



BIONICLE®

70782







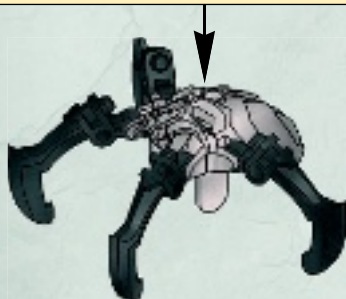
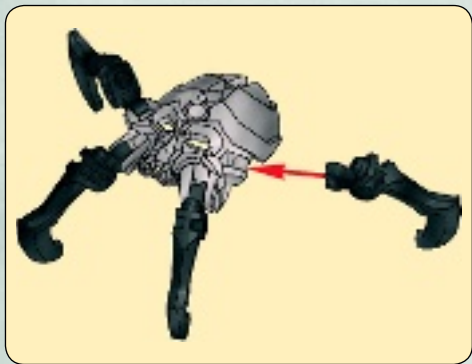

1





2



3

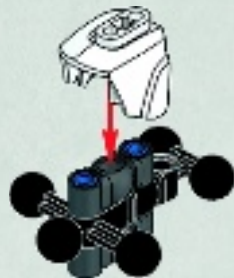



4

1

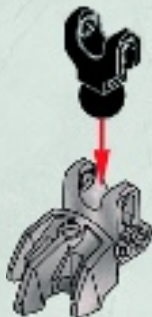

2



2x

5

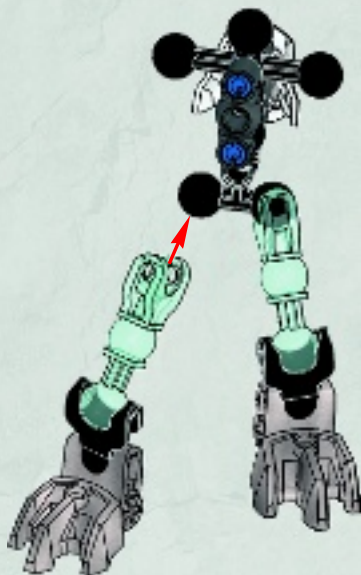



2x

6

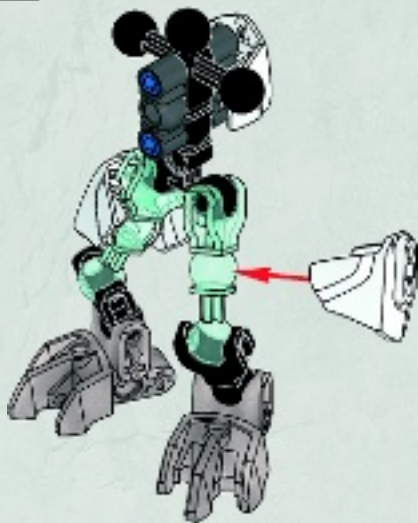

8

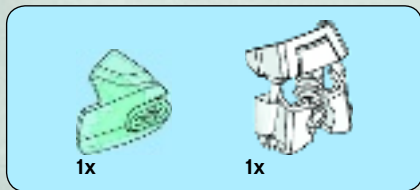

7

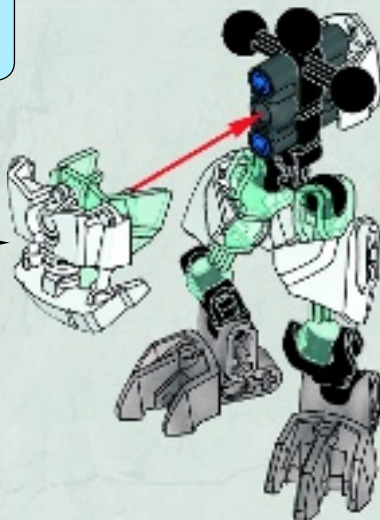
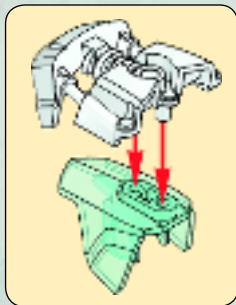



2x



2x

8



2x

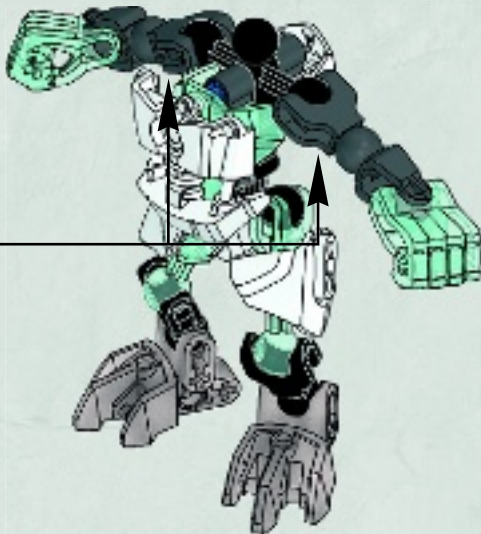

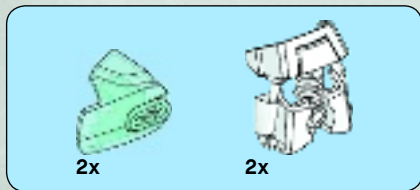

9

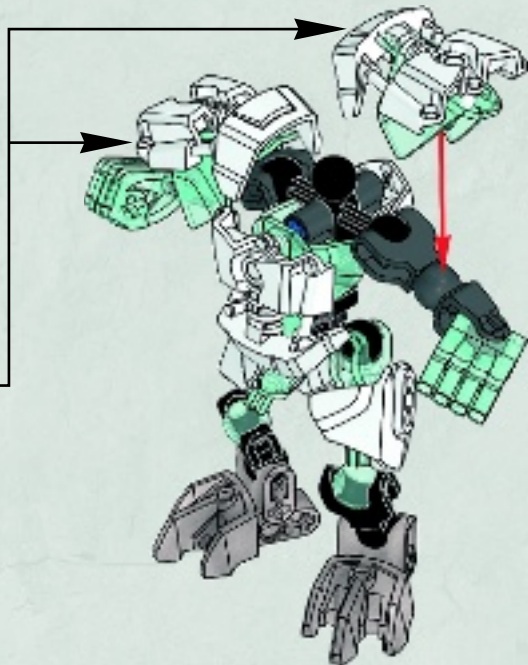
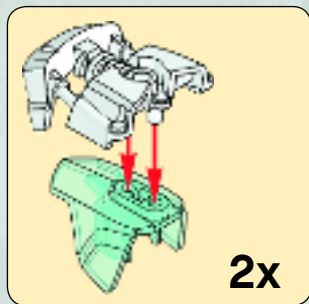

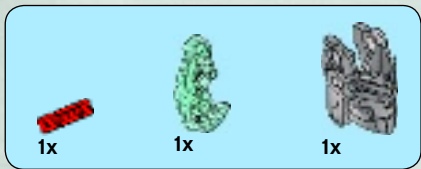

10



11

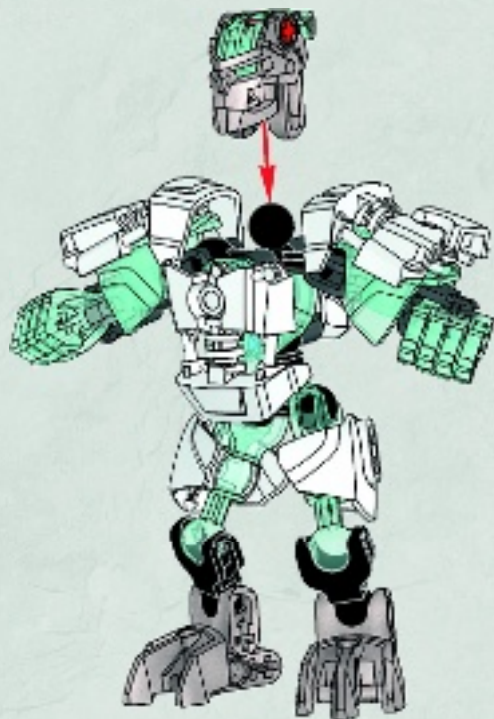



1x



1x

12



CLICK

CLIC

14



2x



1x

13

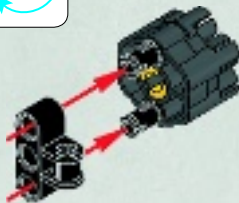



1x



1x

14



1x



1x

15

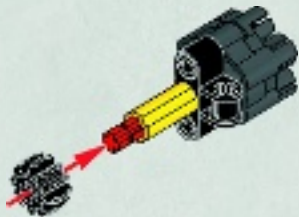



16

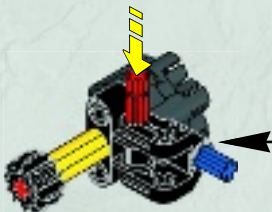
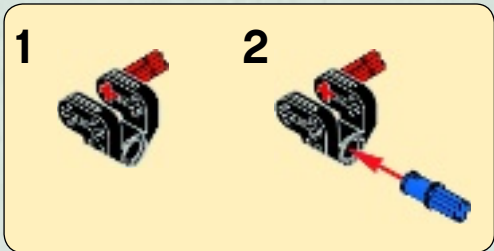



17

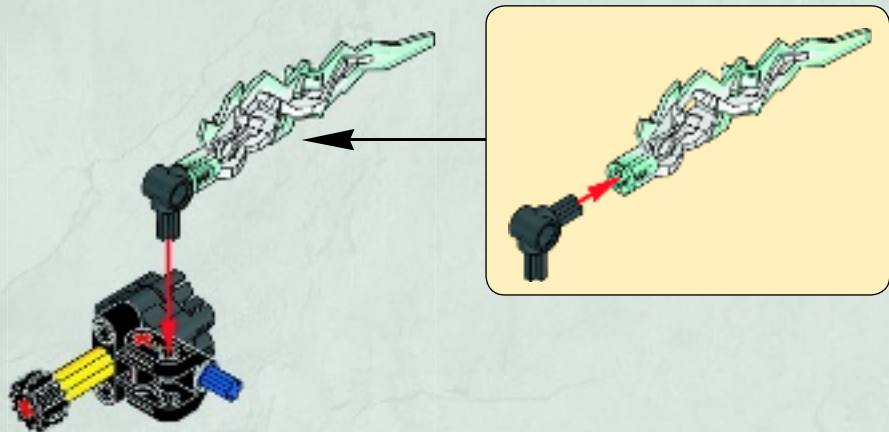



6x

18

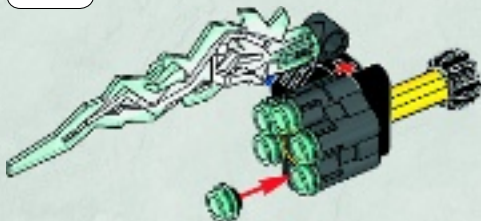

19

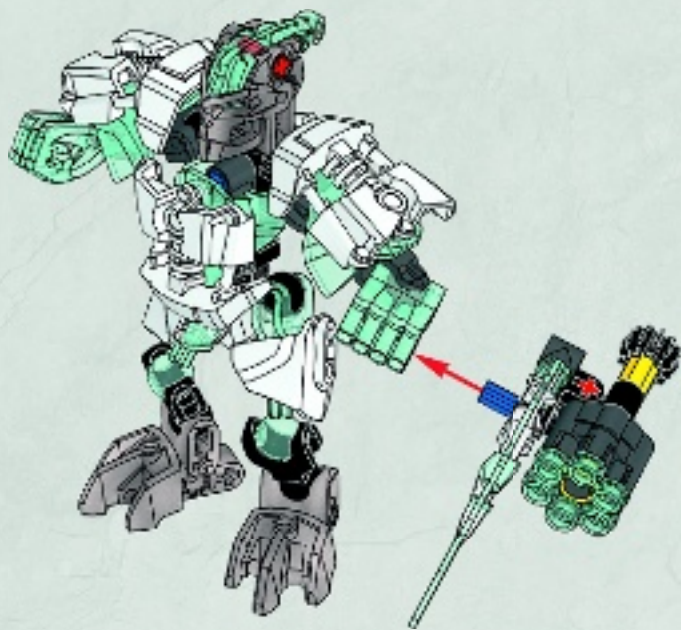



1x



1x



1x

20

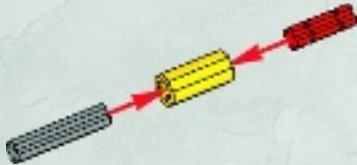

20



1x

21

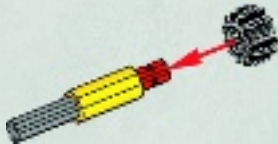



1x



1x

22

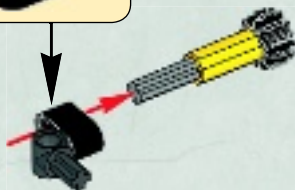



1x



1x

23

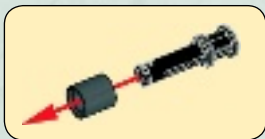



1x

24

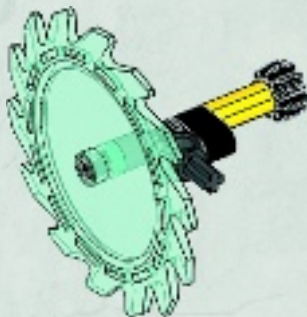

25

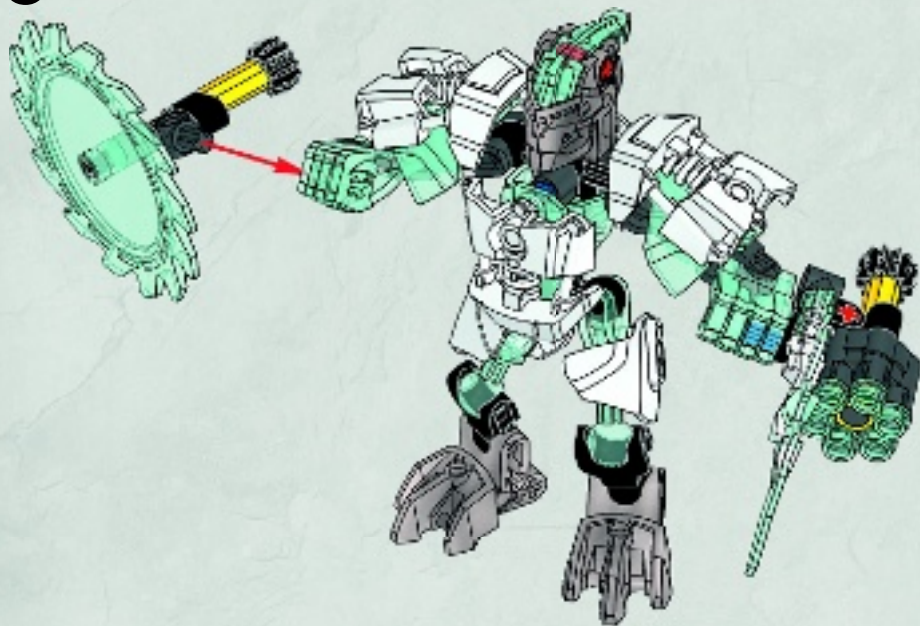

24

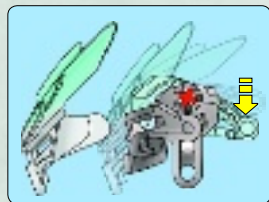

26

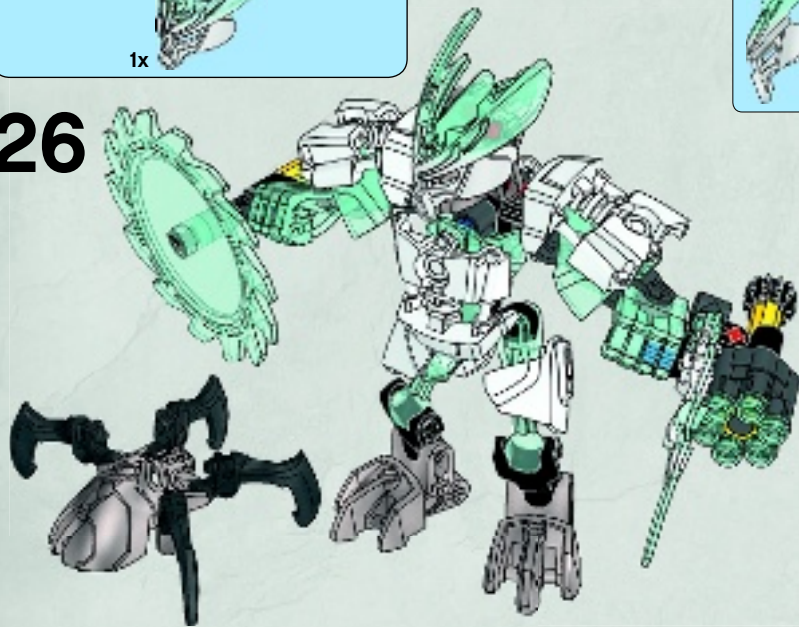



3x
6045952



3x
6102790



4x
4142865



1x
4206482



2x
4514553



2x
4519010



1x
6100103



1x
6007966



1x
4610371



2x
4593557



1x
6006140



1x
4667277



2x
4121715



1x
4140801



2x
4177431



6x
4163917



1x
6079018

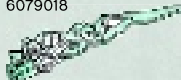

1x
6029783



2x
6043685



1x
6102770



1x
6102638



2x
6043679



3x
6029235



1x
4211815



1x
6100030



2x
4622903



2x
6005331



1x
6083620



2x
6001085



1x
6100488



2x
6100892



1x
6102606



1x
6106710



4x
6106738



Customer Service

Kundenservice

Service Consommateurs

Servicio Al Consumidor

LEGO.com/service or dial



00800 5346 5555 :

1-800-422-5346 :



LEGO.com/bionicle



Download App
Télécharger
l'application
Descarga la App



Apple, the Apple logo, iPad, iPhone and iPod touch are trademarks of Apple Inc., registered in the U.S. and other countries. App Store is a service mark of Apple Inc.

Apple, le logo Apple, iPad, iPhone et iPod touch sont des marques de commerce d'Apple Inc., déposées aux États-Unis et dans d'autres pays. App Store est une marque de service d'Apple Inc.

Apple, el logotipo de Apple, iPad, iPhone e iPod touch son marcas comerciales de Apple Inc. registradas en EE. UU. y otros países. App Store es una marca de servicio de Apple Inc.

Google Play is a trademark of Google Inc.
Google Play est une marque de commerce de Google Inc.
Google Play es una marca comercial de Google Inc.

LEGO.com/bionicle/bi



Power up
Plus de puissance
Máximo poder



70782

+



=



70788



70788



70786



70785



70784

70787

70789

