

# ULTRA AGENTS

70173

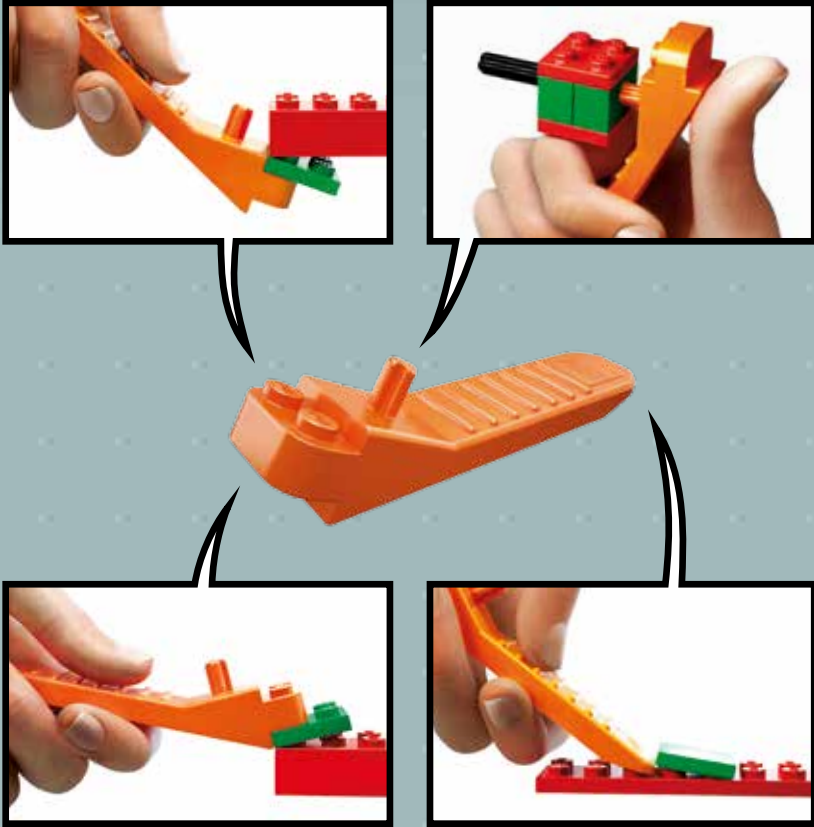

 [LEGO.com/ultraagents](https://www.LEGO.com/ultraagents)



[LEGO.com/brickseparator](https://LEGO.com/brickseparator)

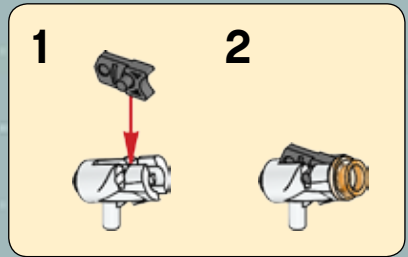
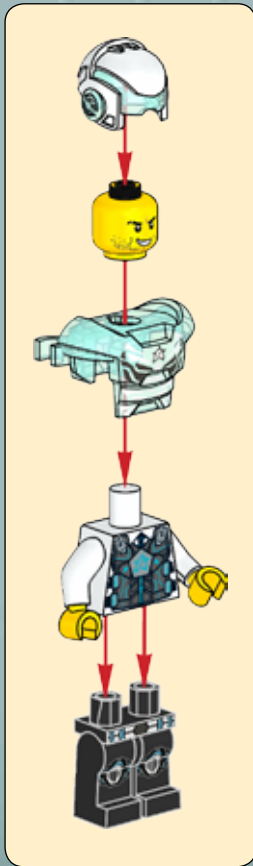
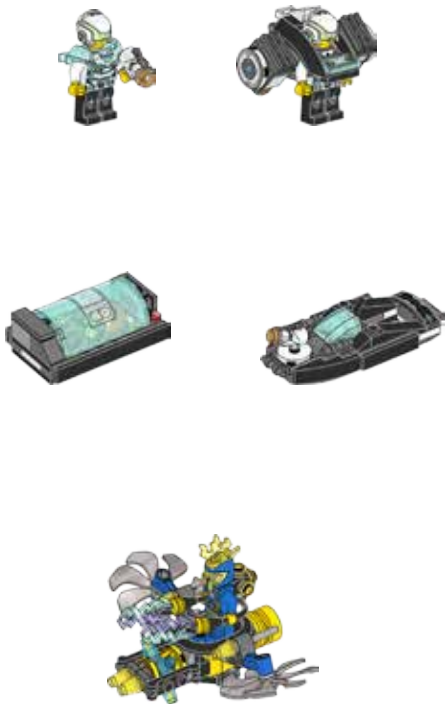

IMPORTANT: Never modify the elements or use other projectiles than provided with this toy.  
IMPORTANT : Ne jamais modifier les éléments ni utiliser d'autres projectiles que ceux fournis avec ce jouet.  
IMPORTANTE: No modifique los elementos ni utilice otros proyectiles diferentes a los suministrados junto con este juguete.





1

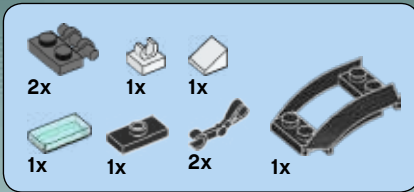

2

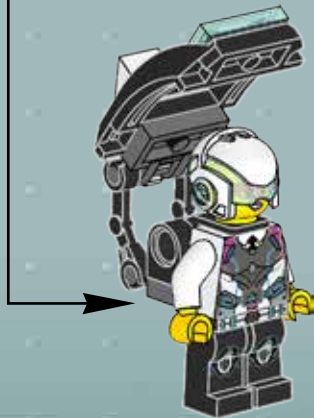
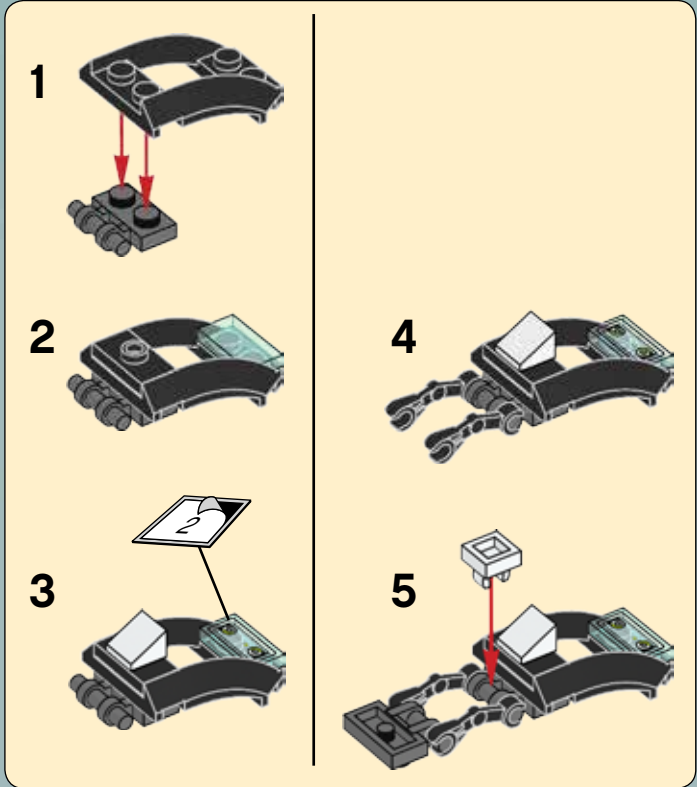

# 3

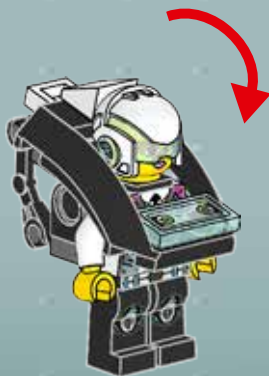

# 4

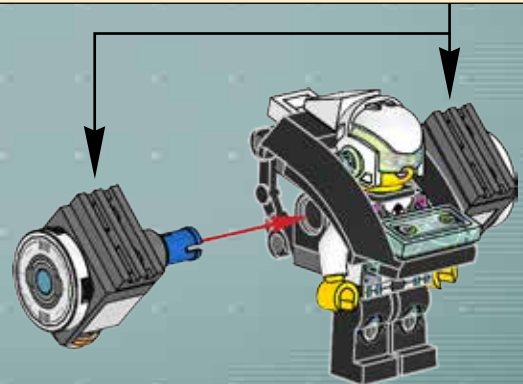
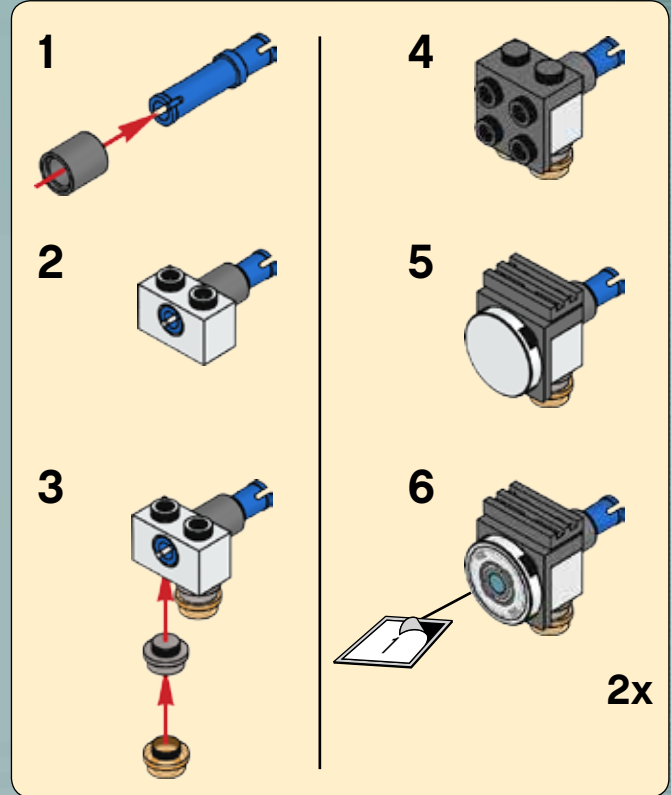
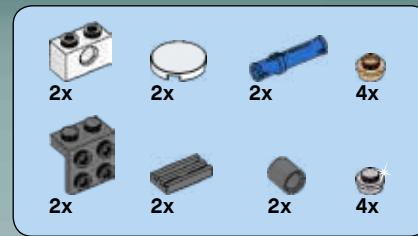

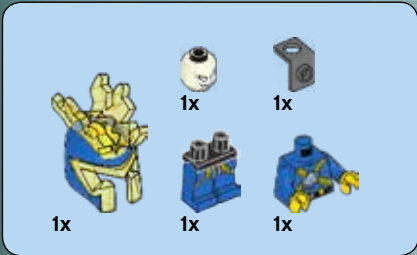

1

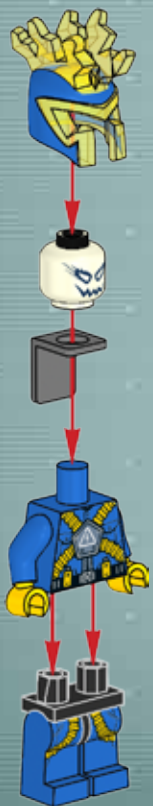

2

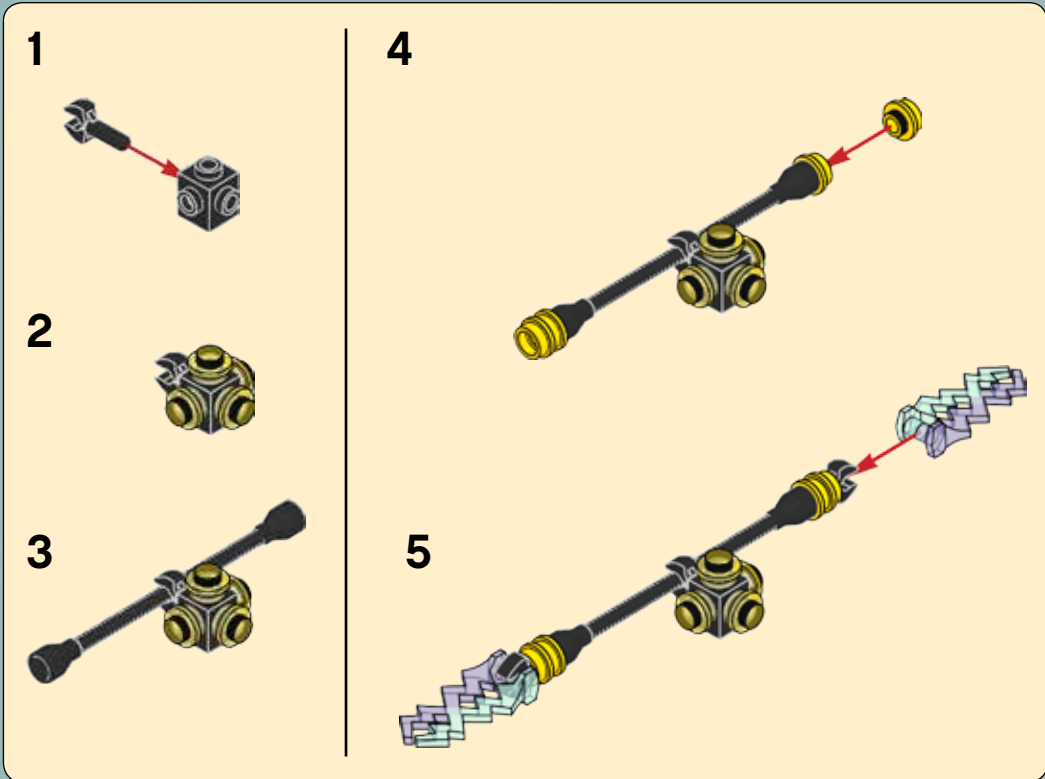

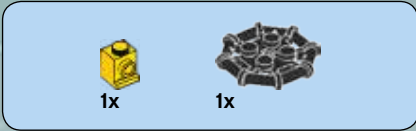
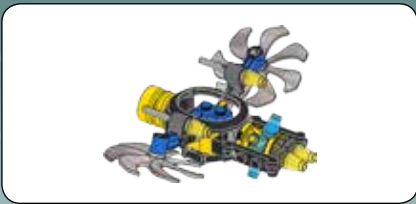

1



2



3

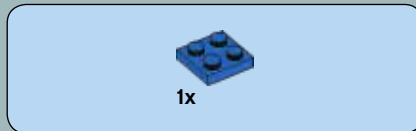
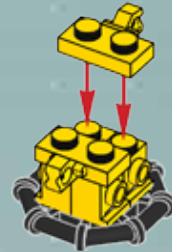

4





5

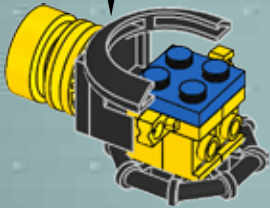
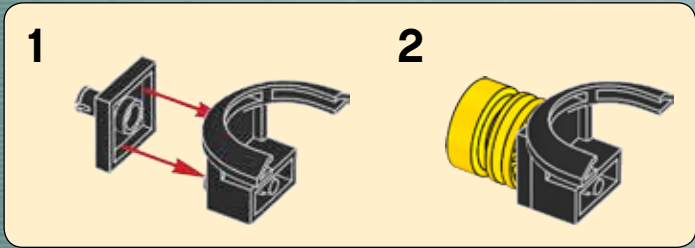

6

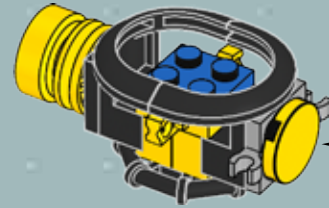
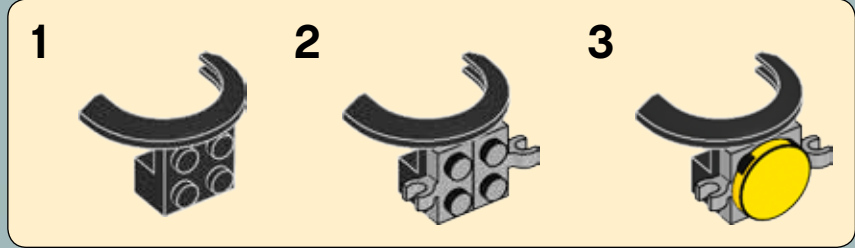



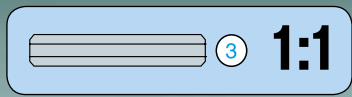

7

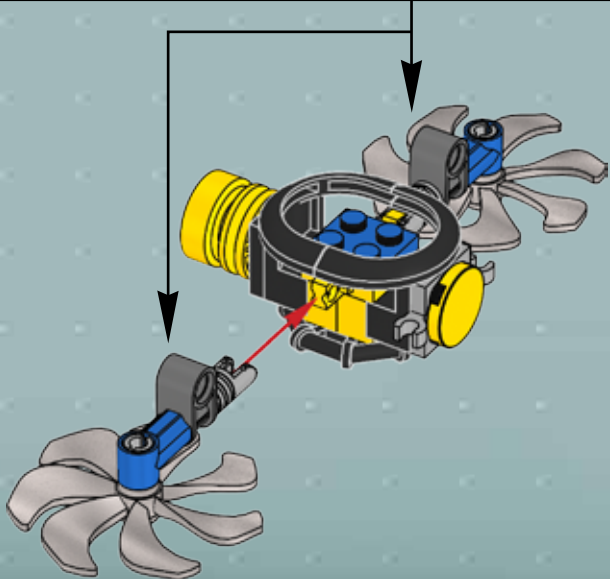
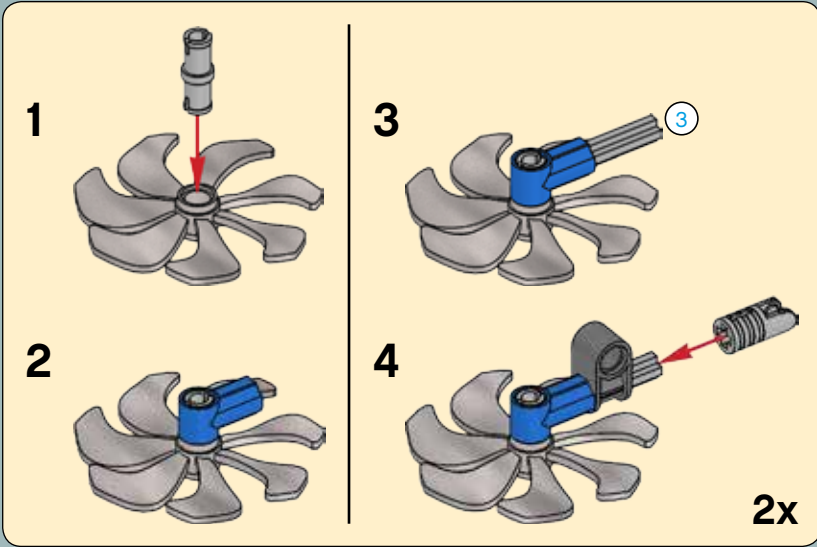

8

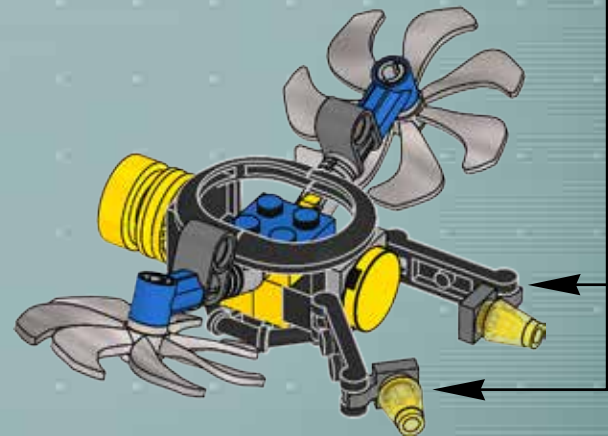
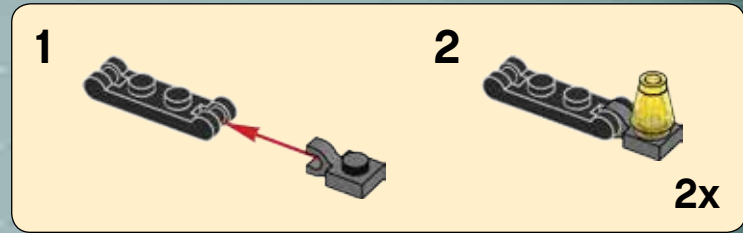

1x  2x  1x  4x 

9

1



2



3



4



1  2  2x 

5

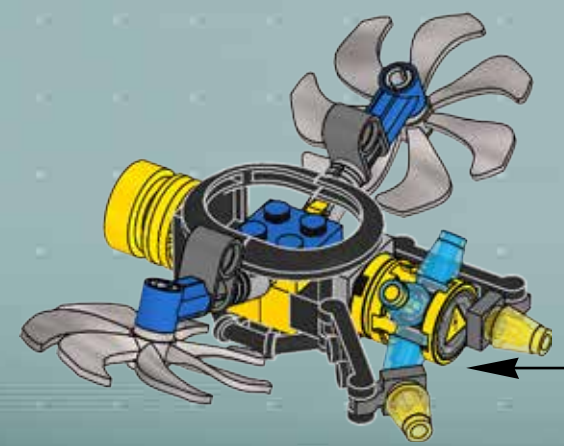



10

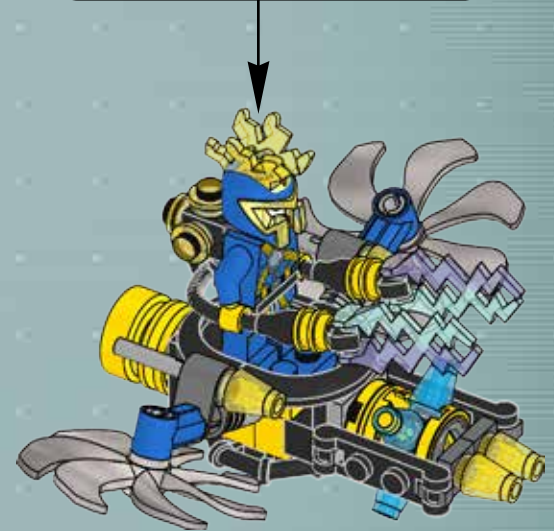
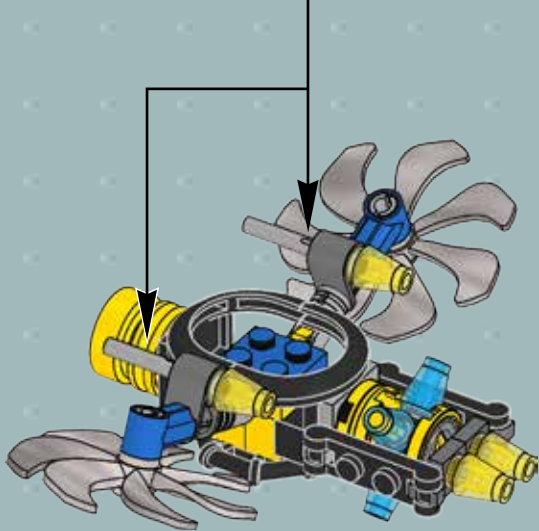
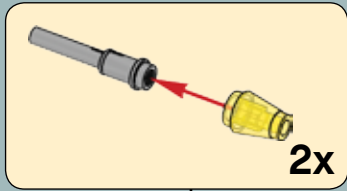



1x

1x

1



1x

4x

2

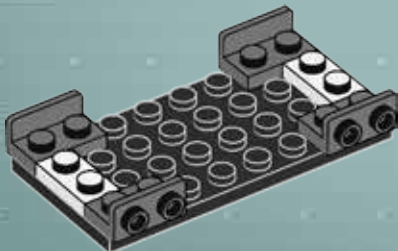

2x

2x

3

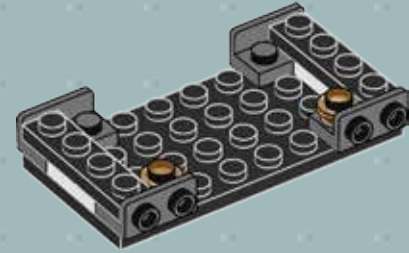

2x

4





5

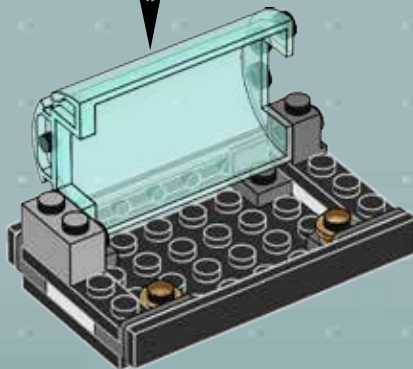
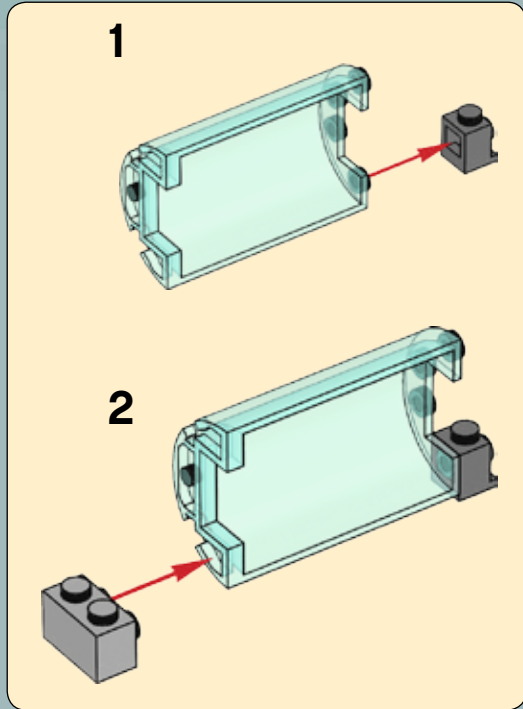

6

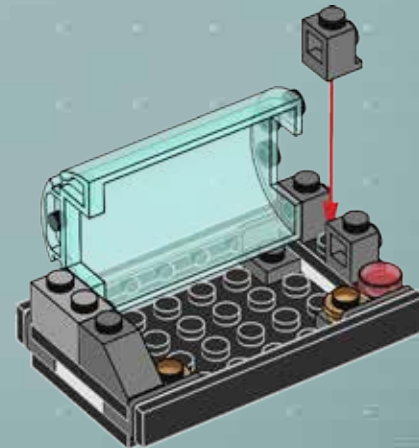

7

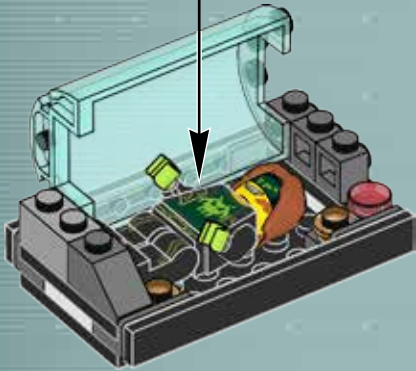

2x

8

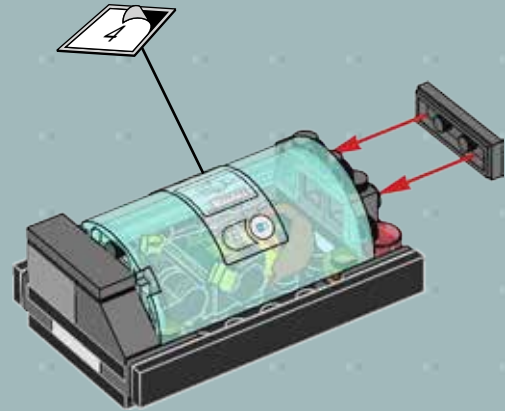

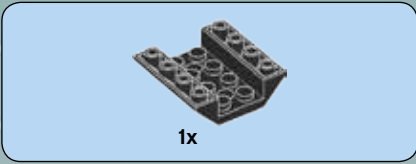

1

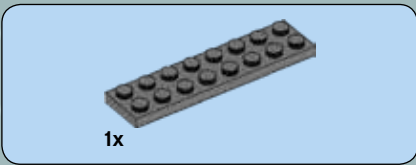
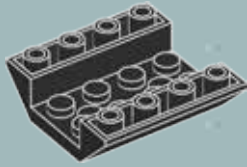

2

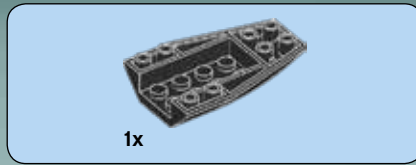
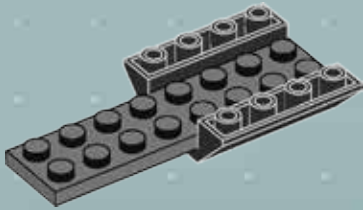

3

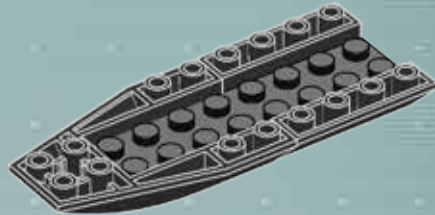

4

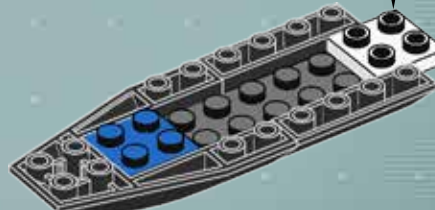



2x



1x

# 5

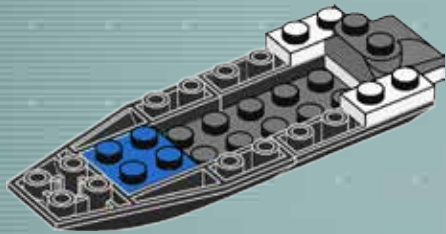

4x

# 6

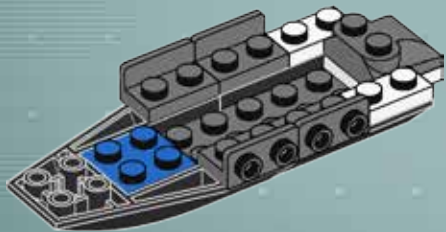

1x



4x

# 7

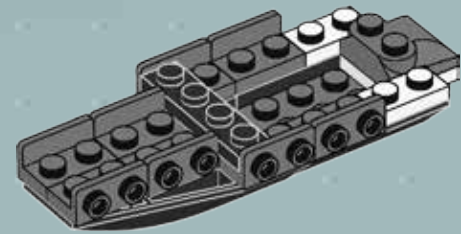

2x



1x

# 8

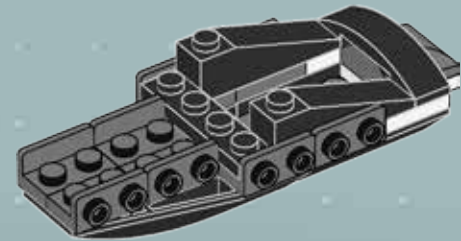





9

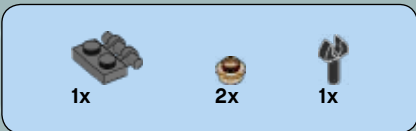
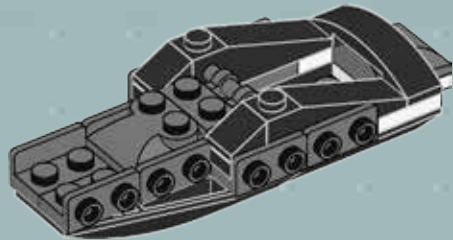

10

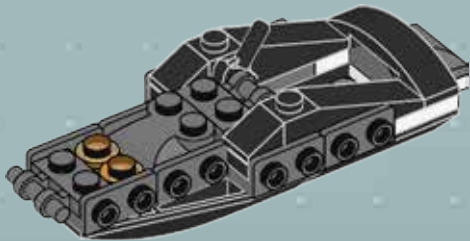

11

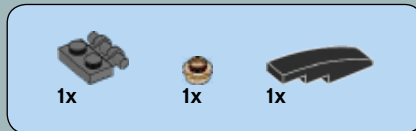
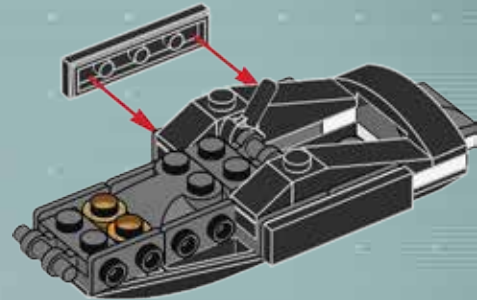

12

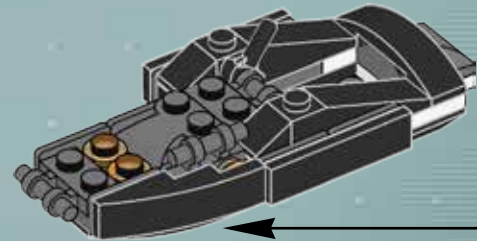

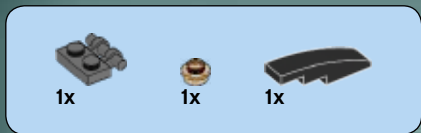

13

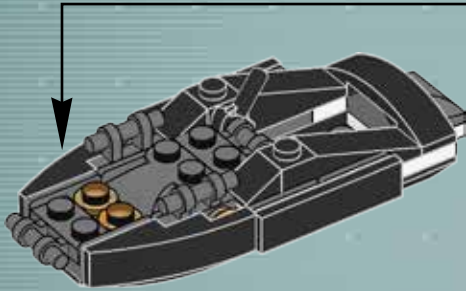
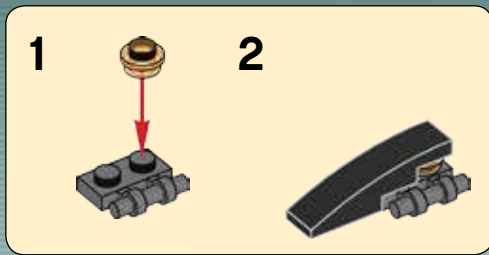

14

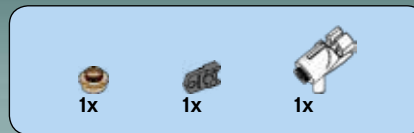

15

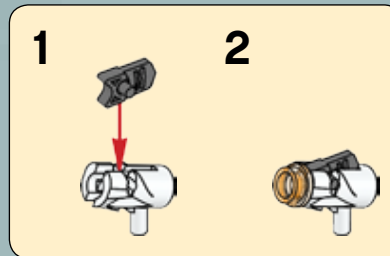



2

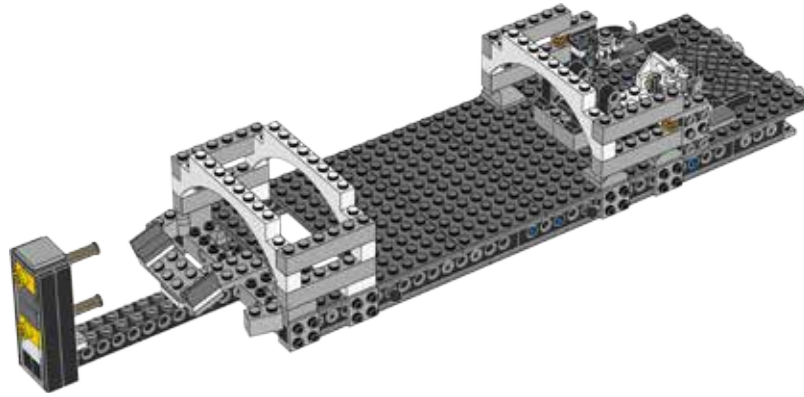

1x

1

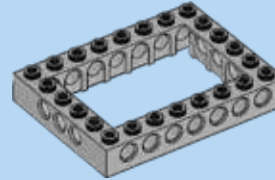

2x

2

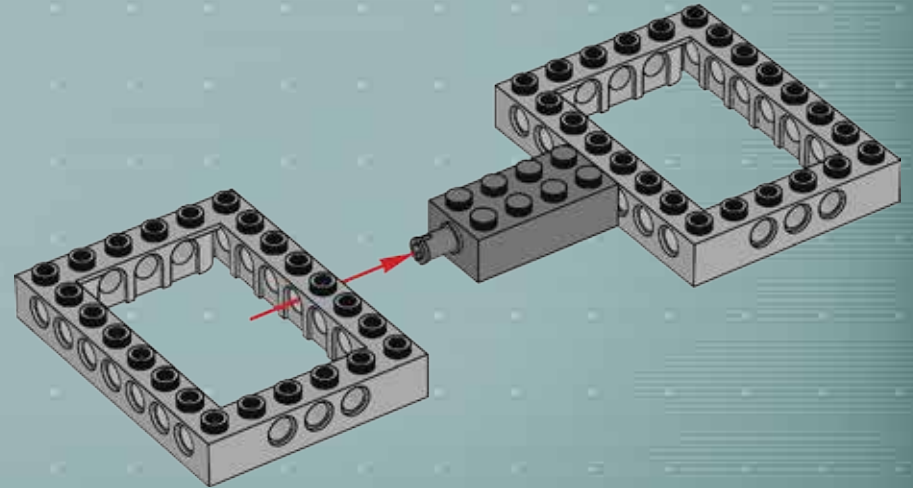

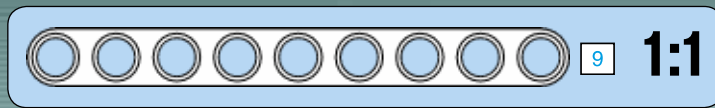
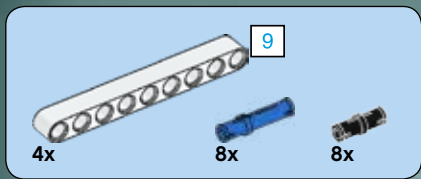

3

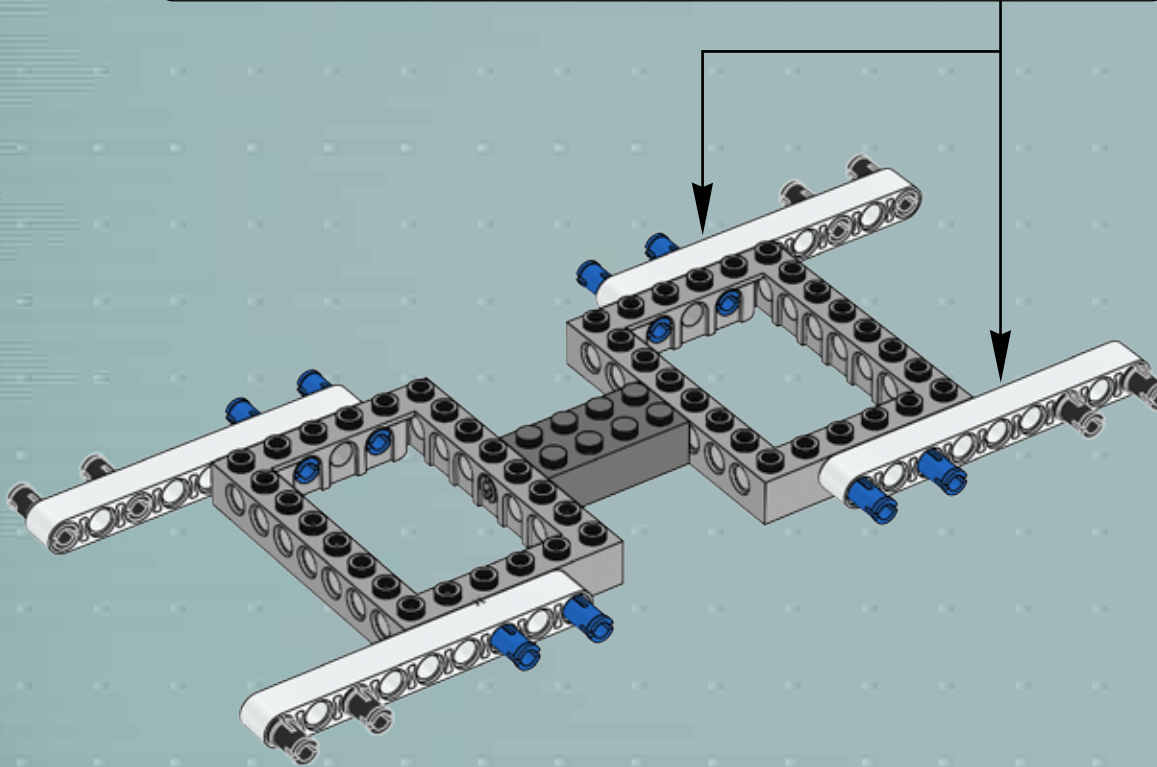
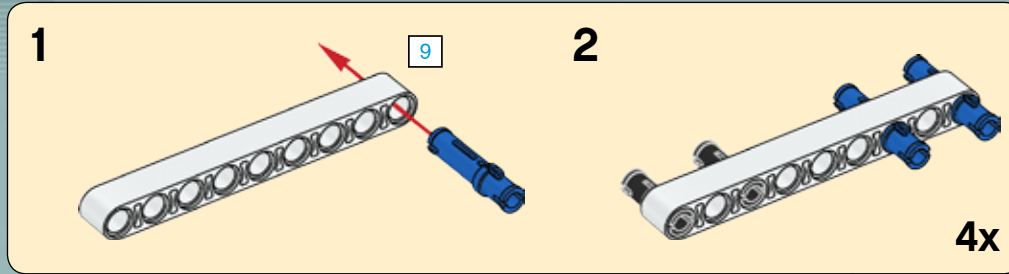

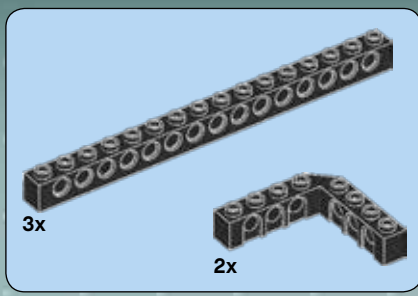

# 4

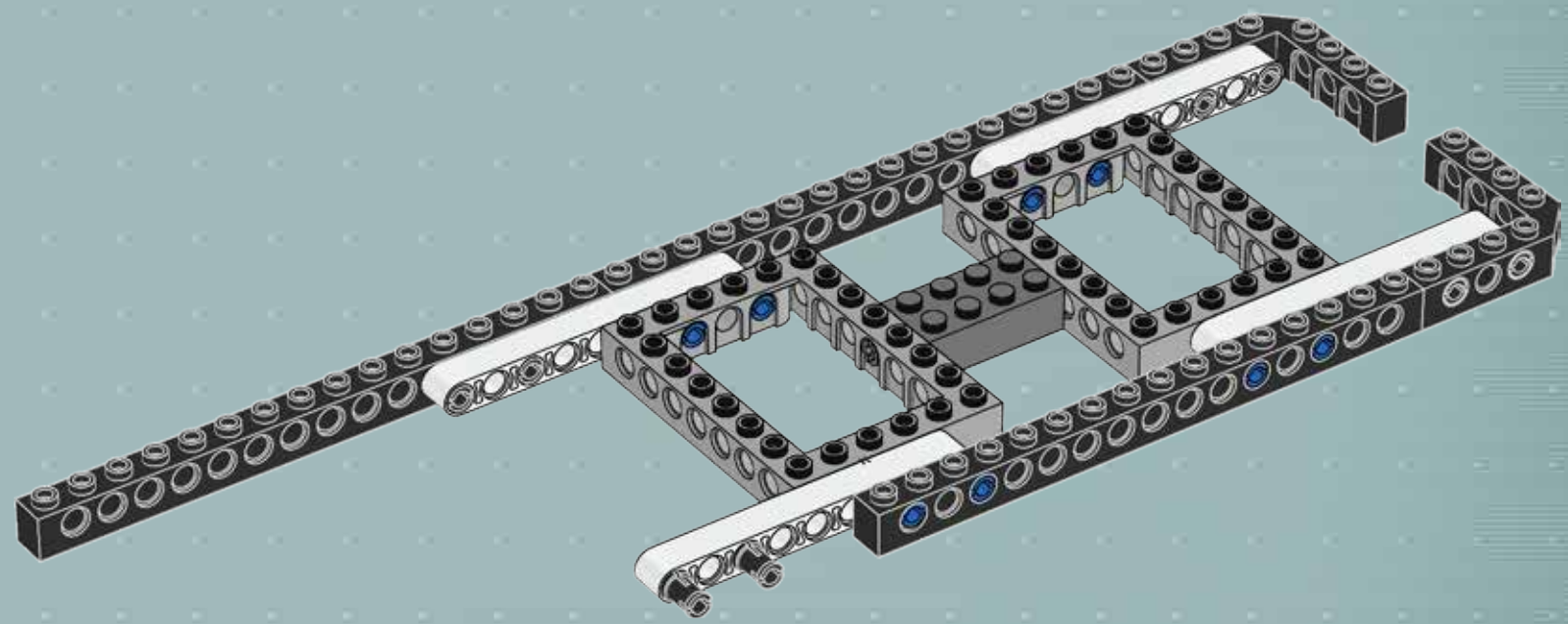

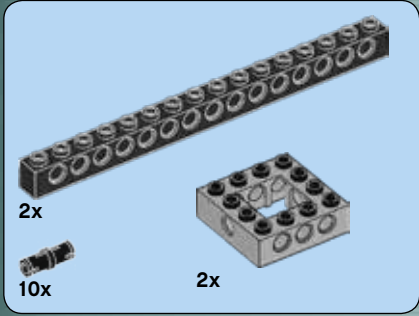
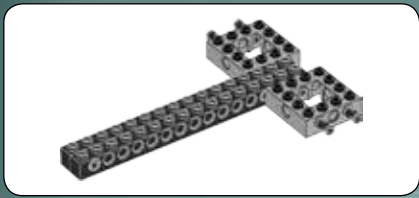

5

1

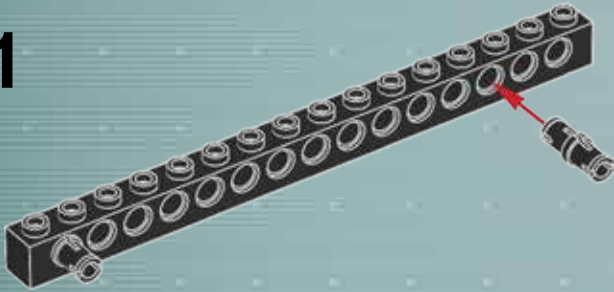

2

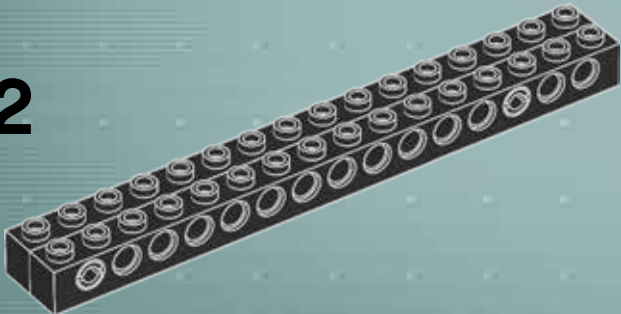

3

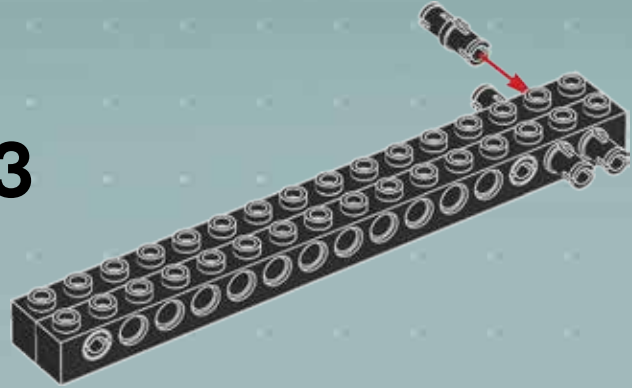

4

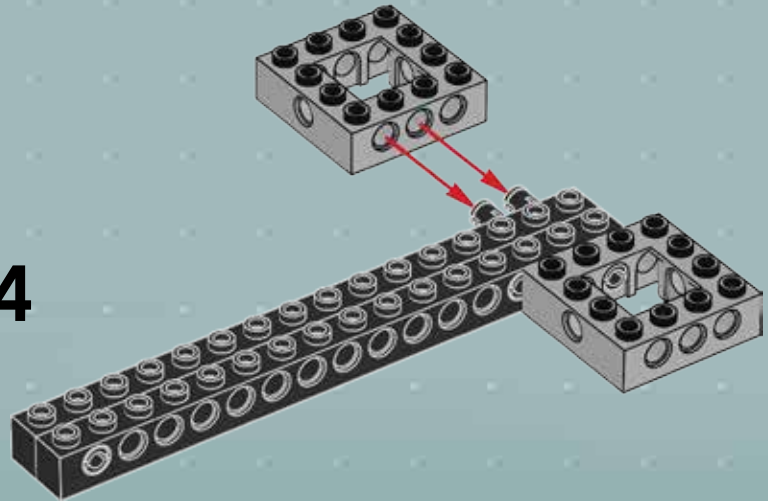

5

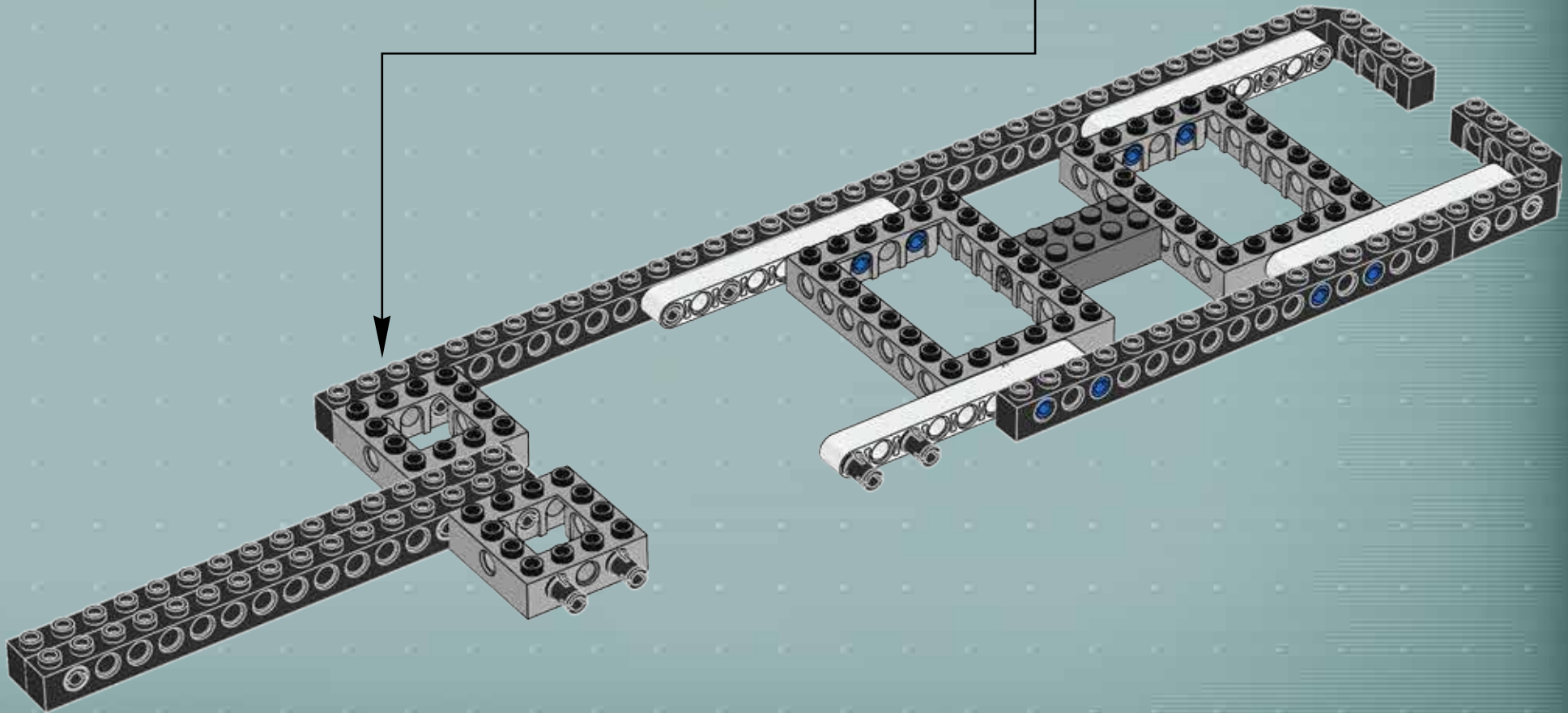
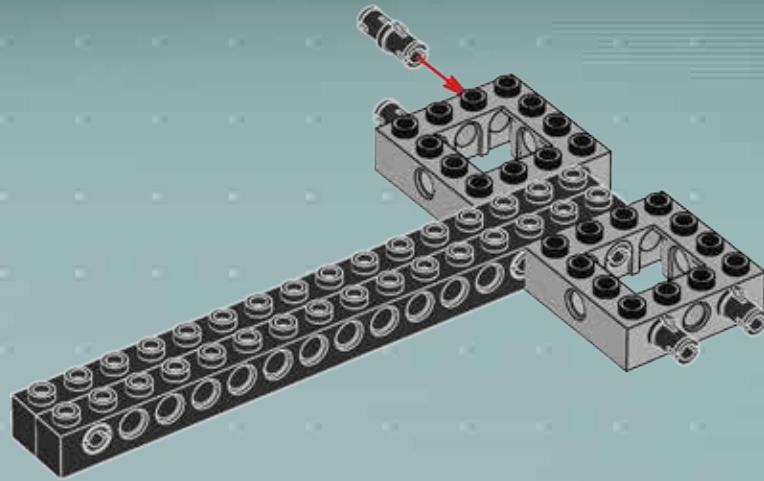

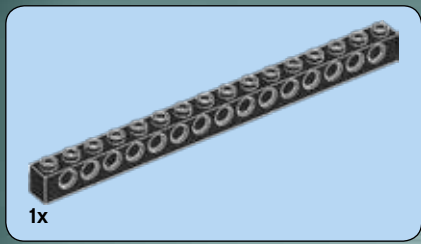

6

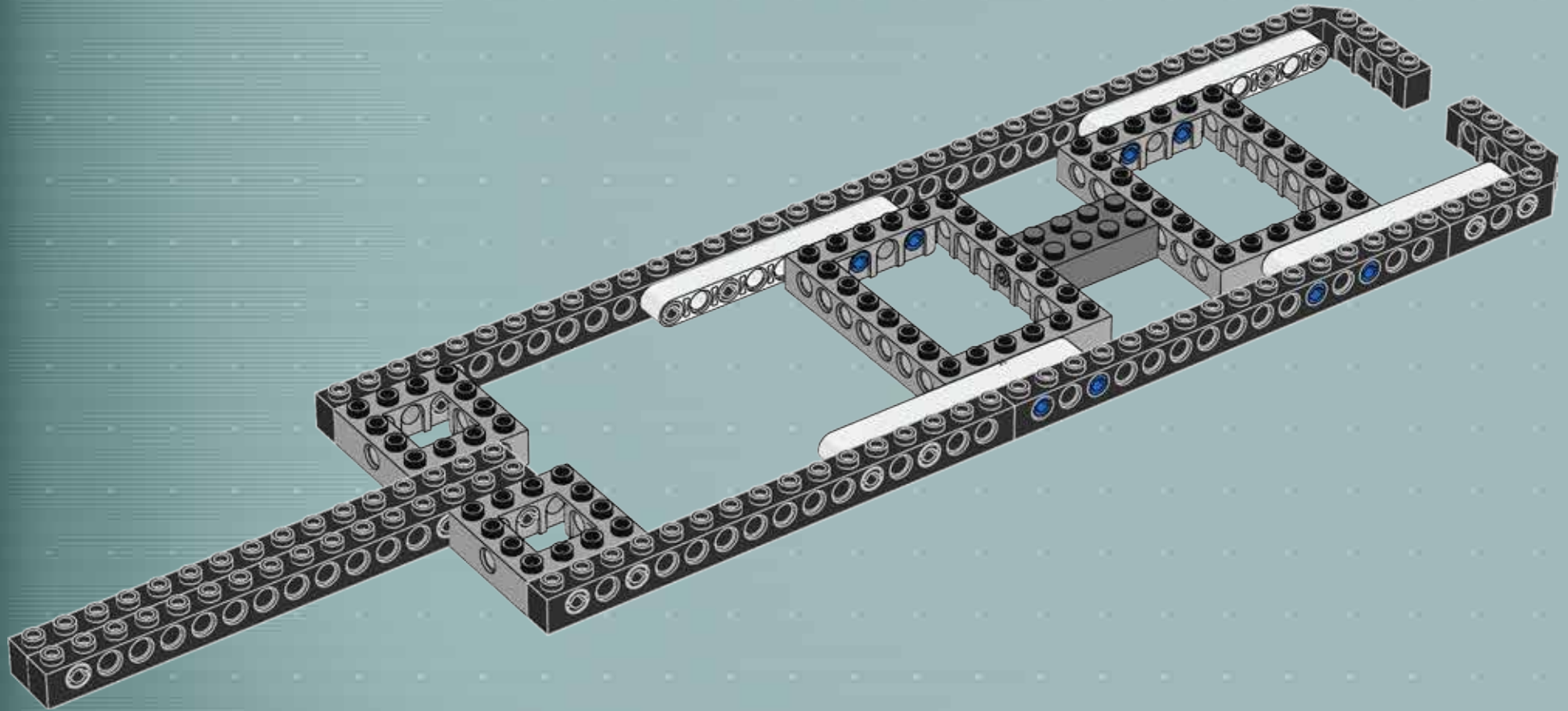





7

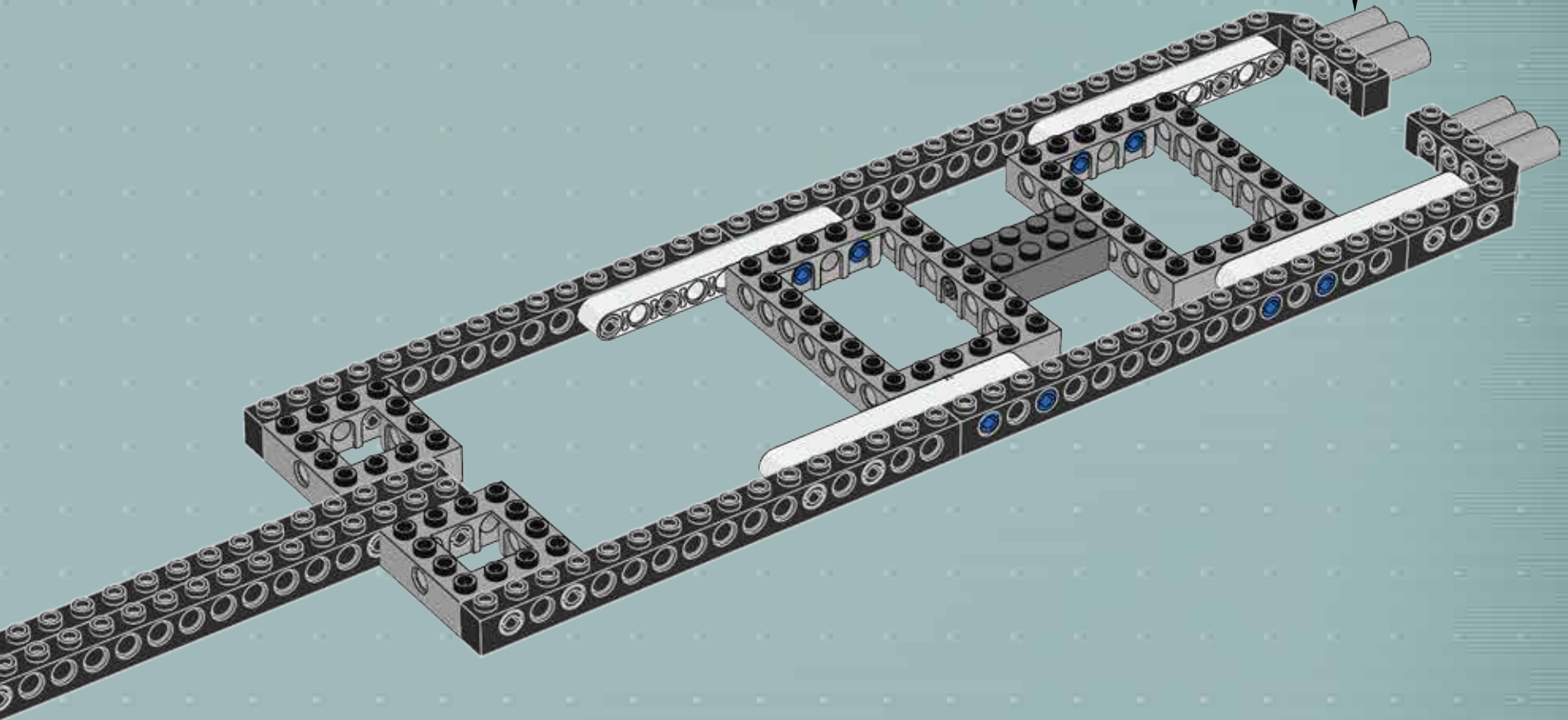
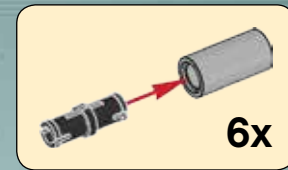

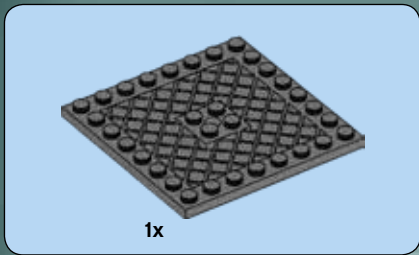

8

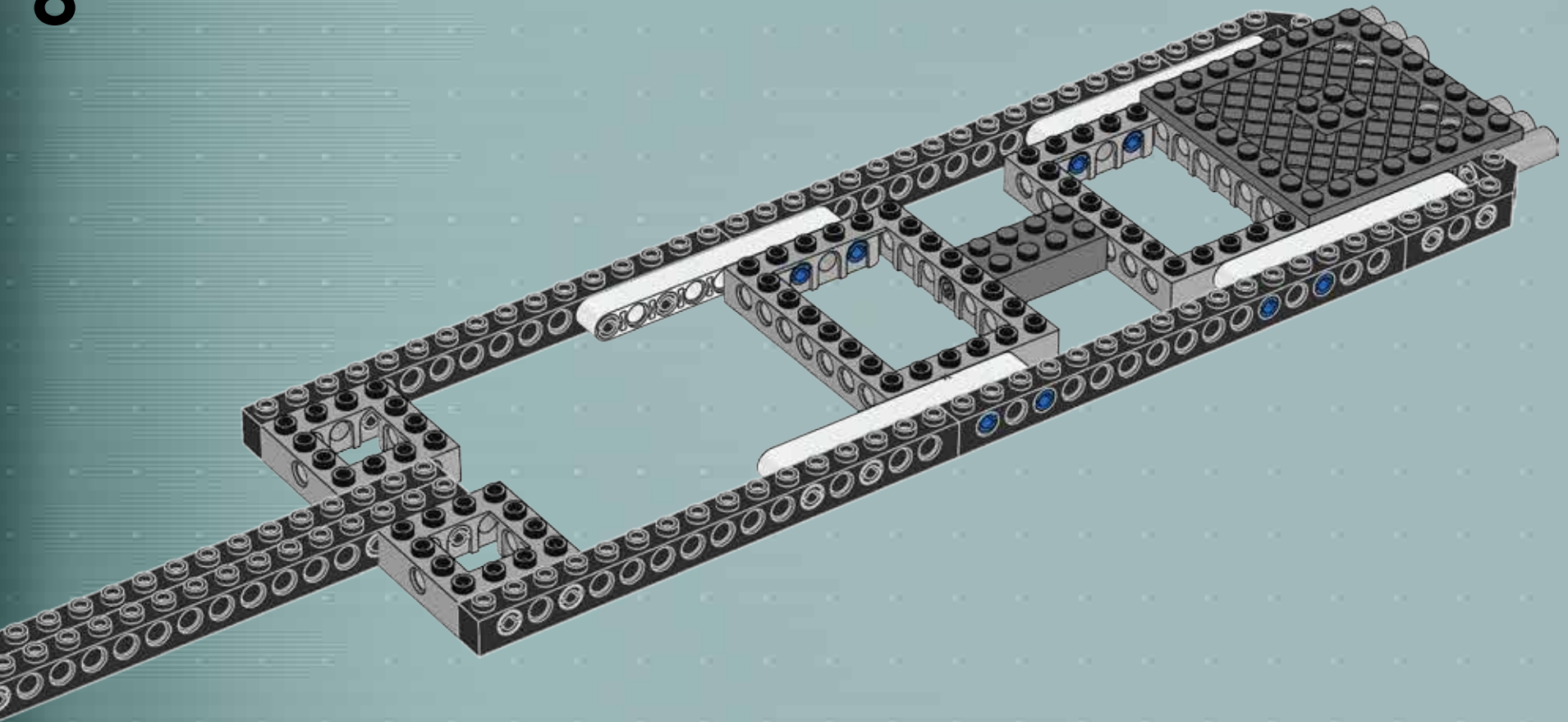

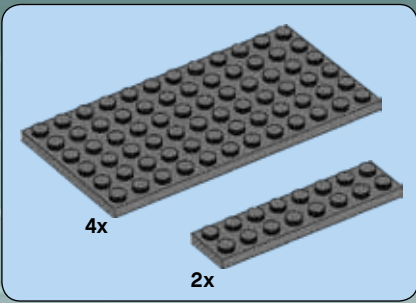

9

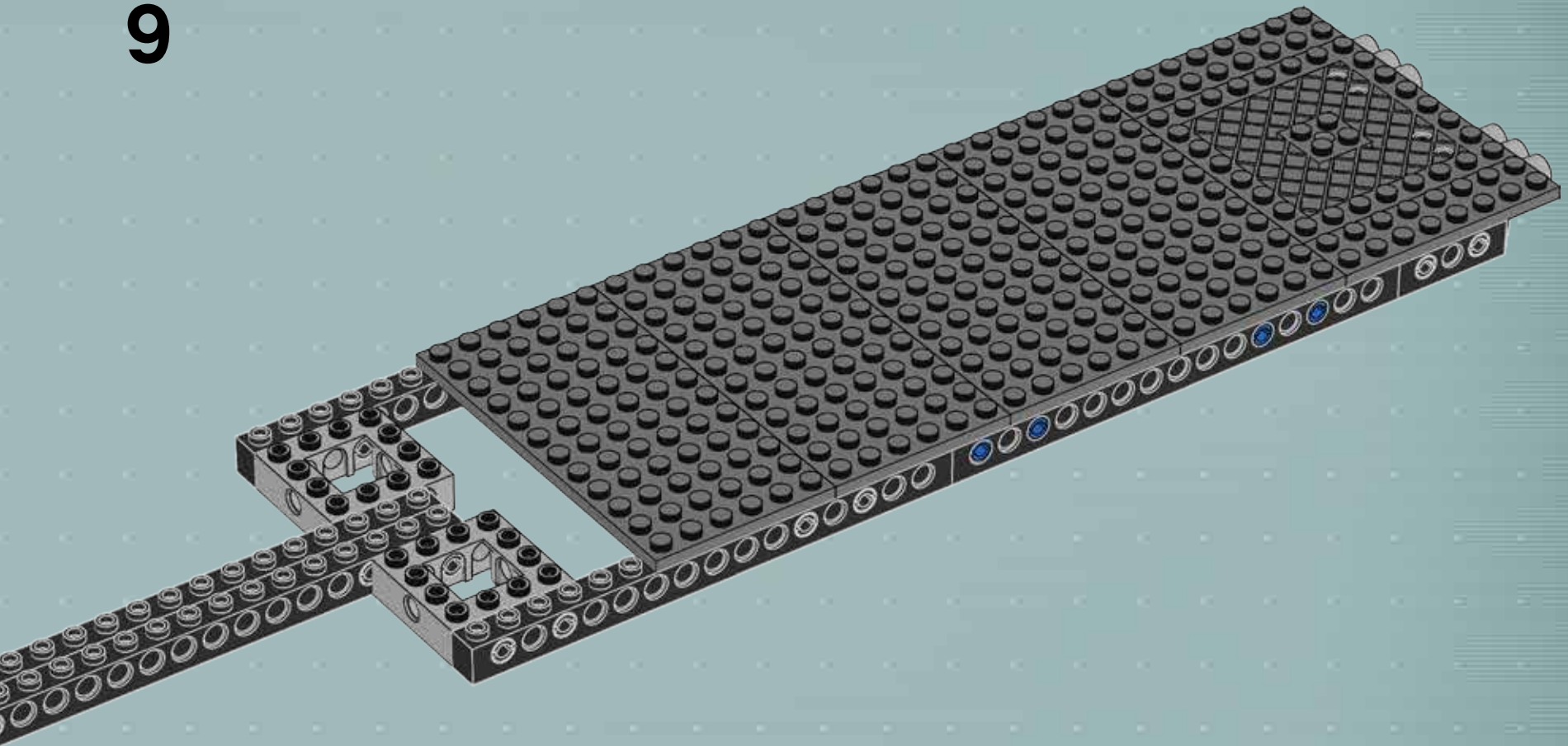

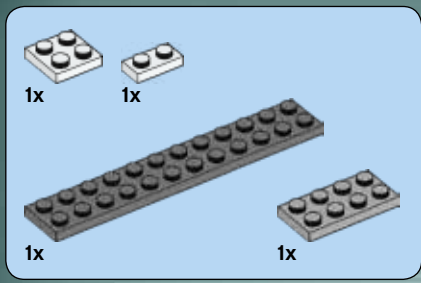

10

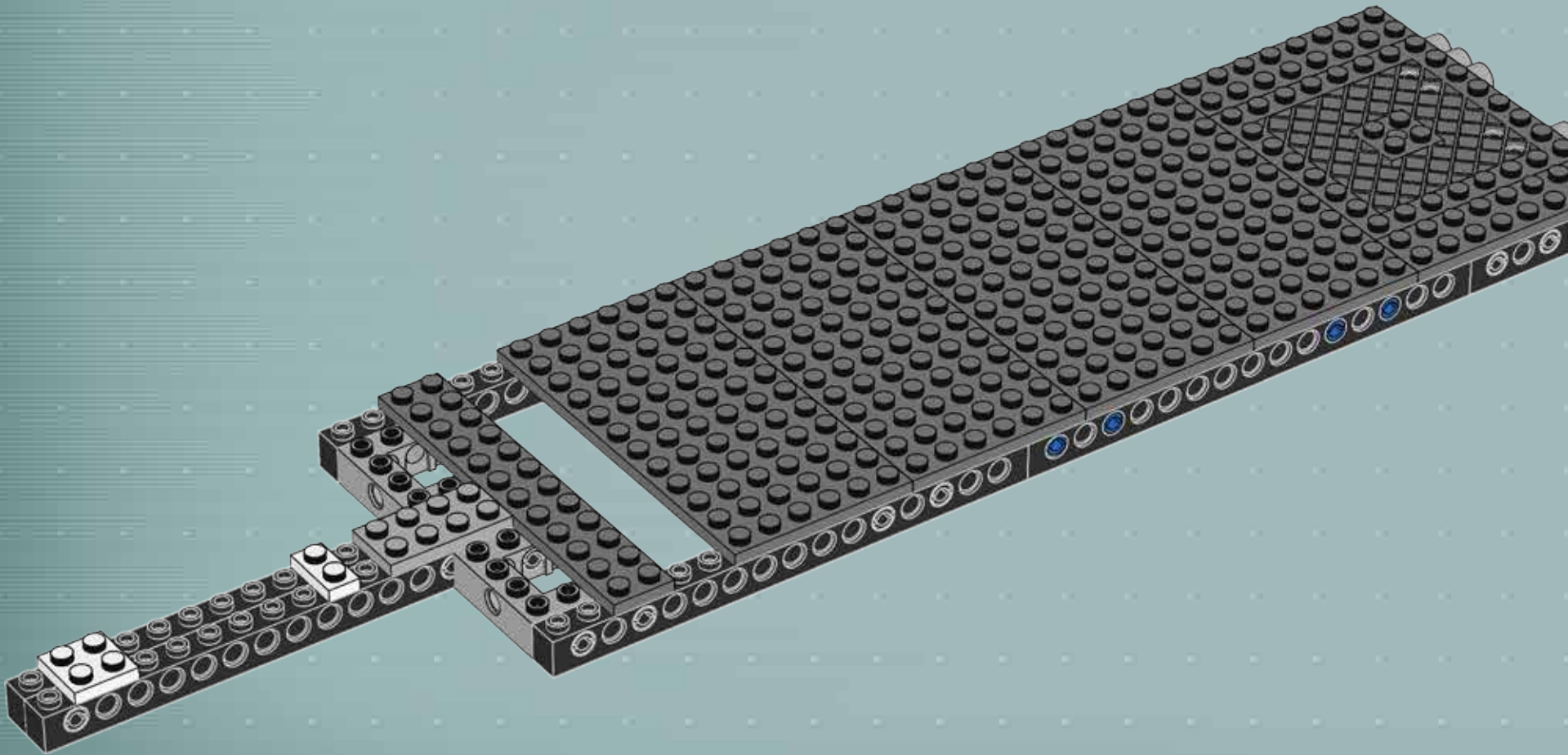

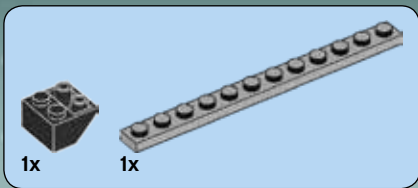

# 11

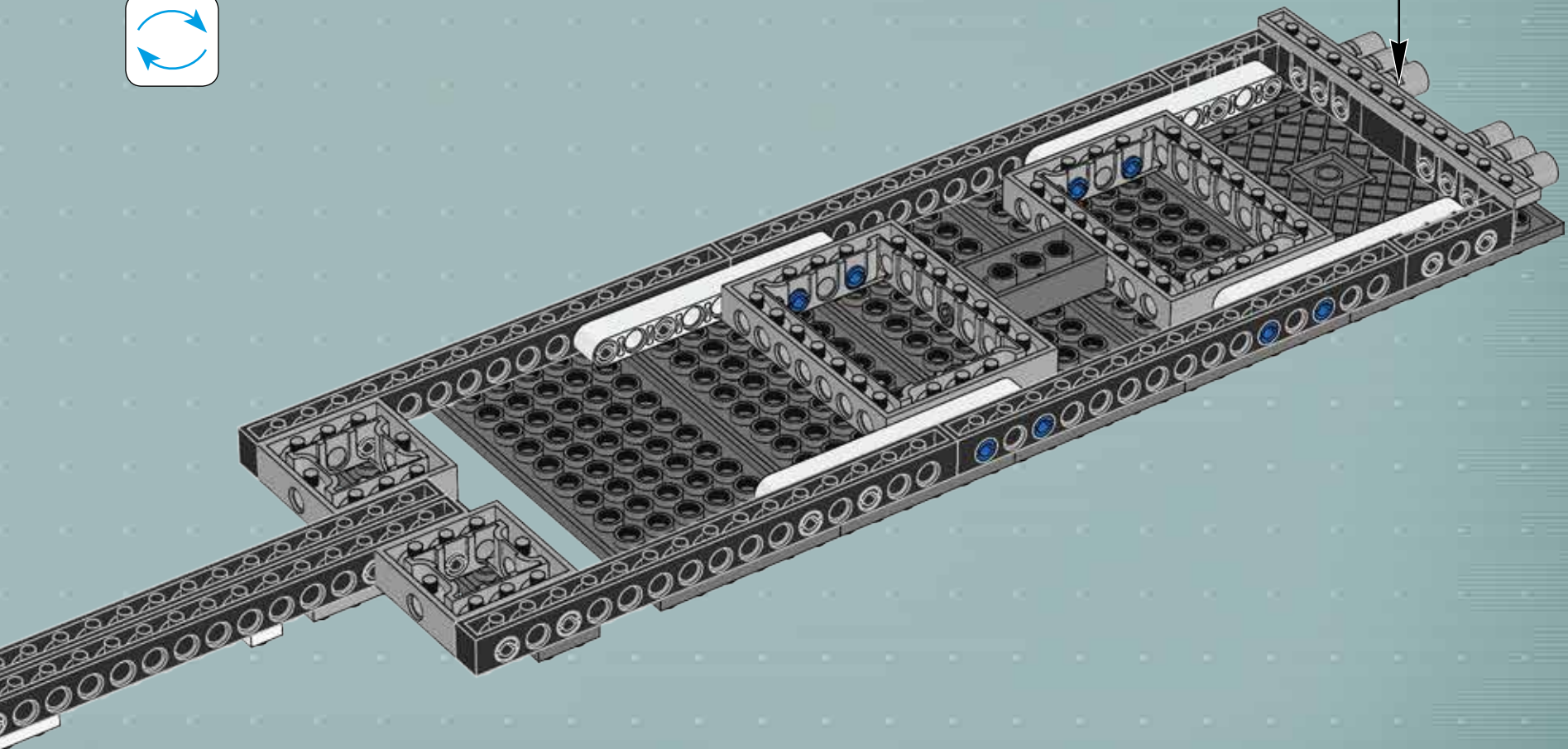
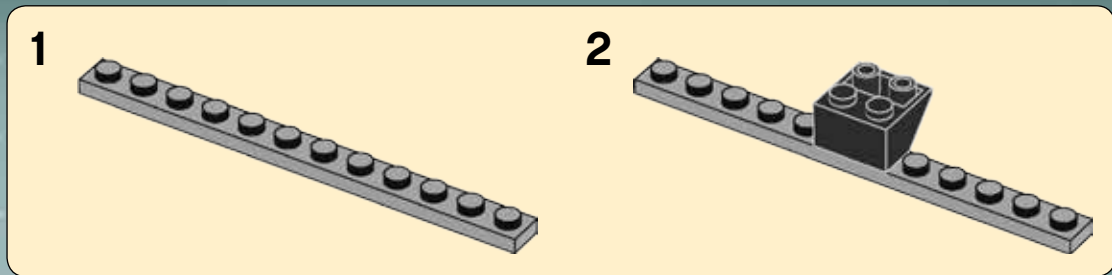

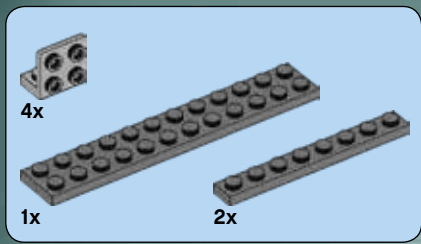

12

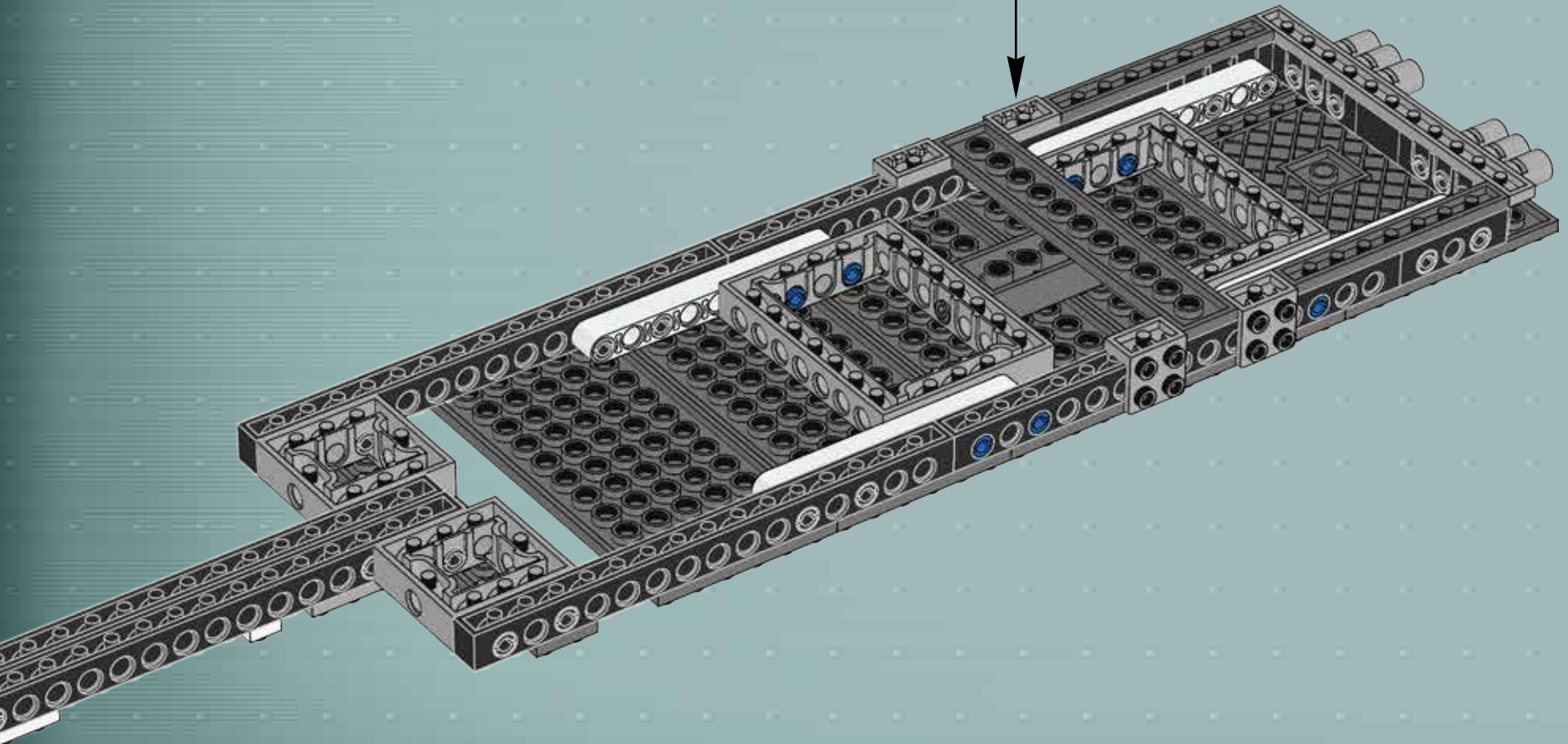
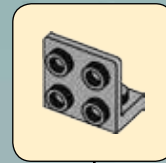

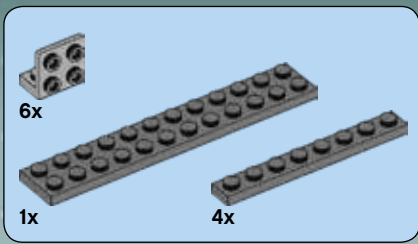

# 13

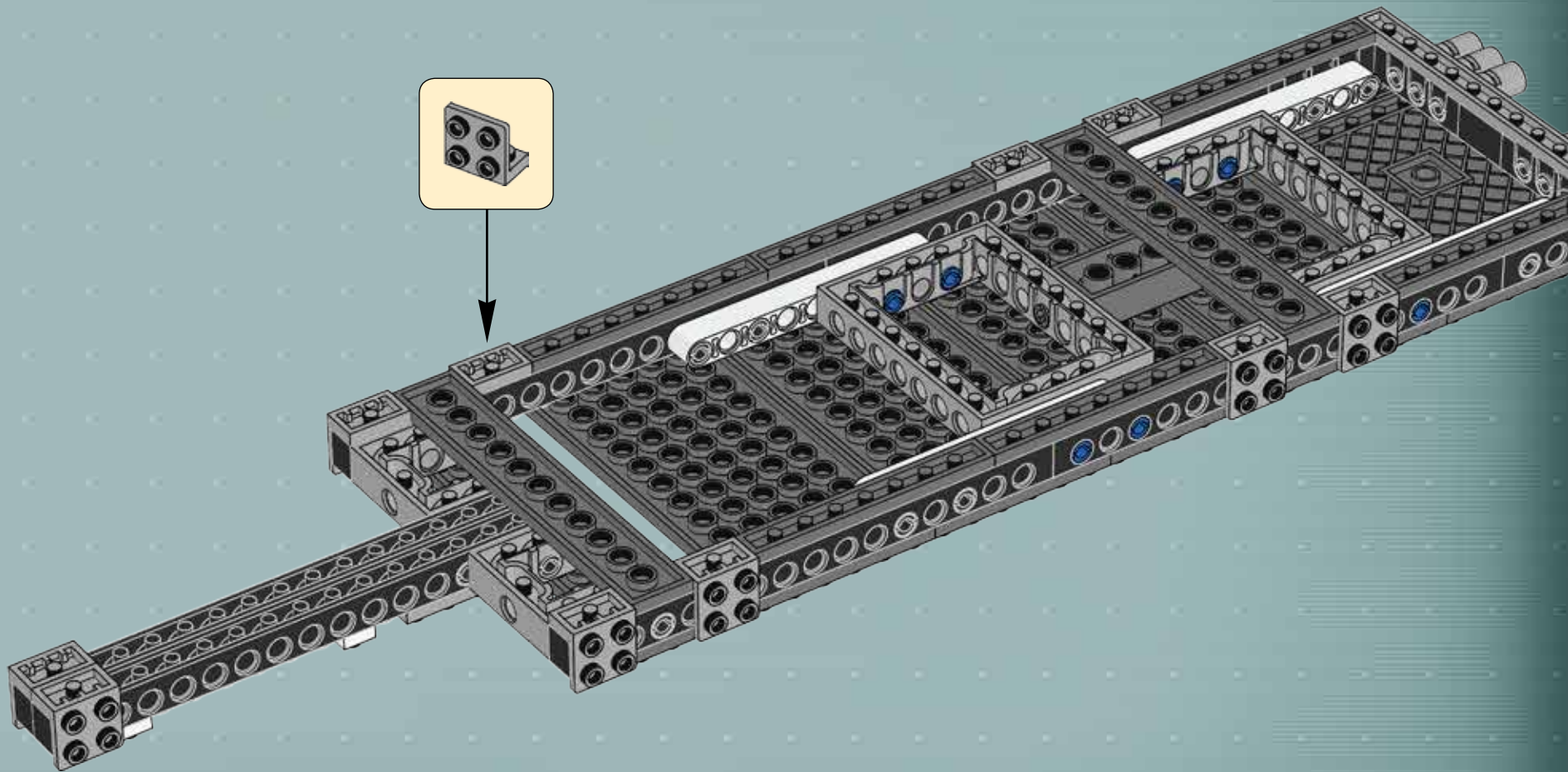

4x

14

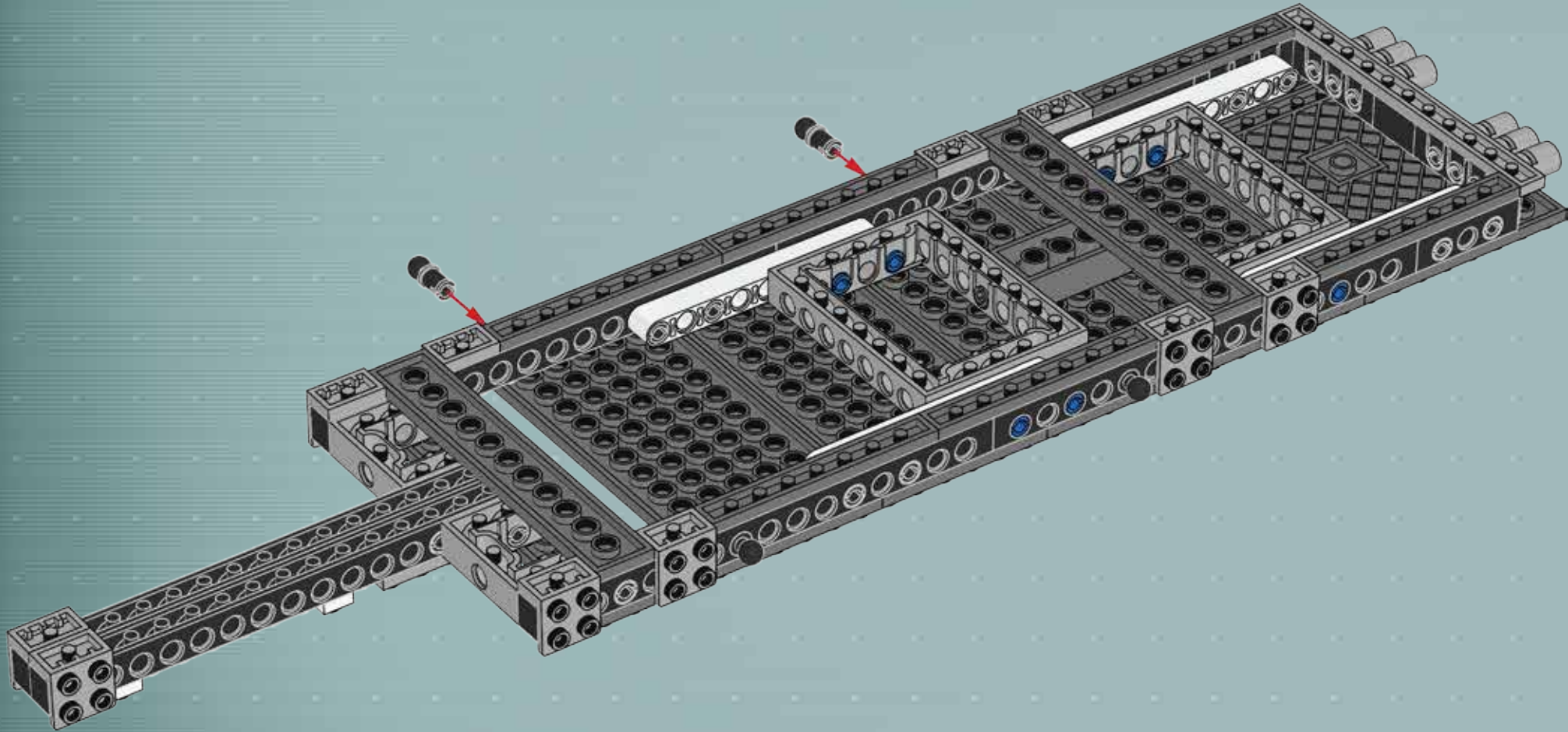





# 15

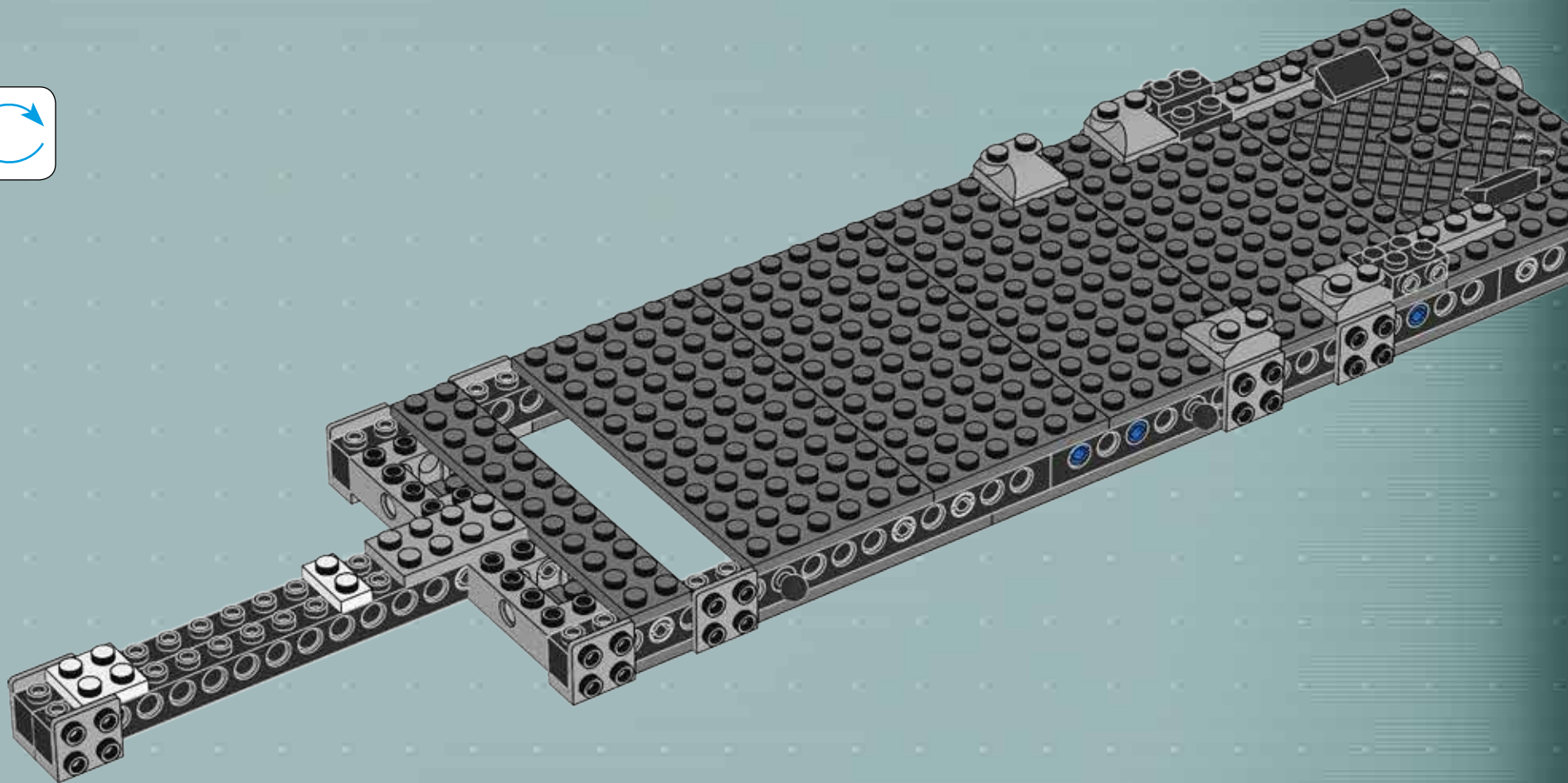

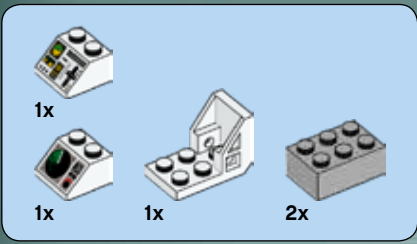

# 16

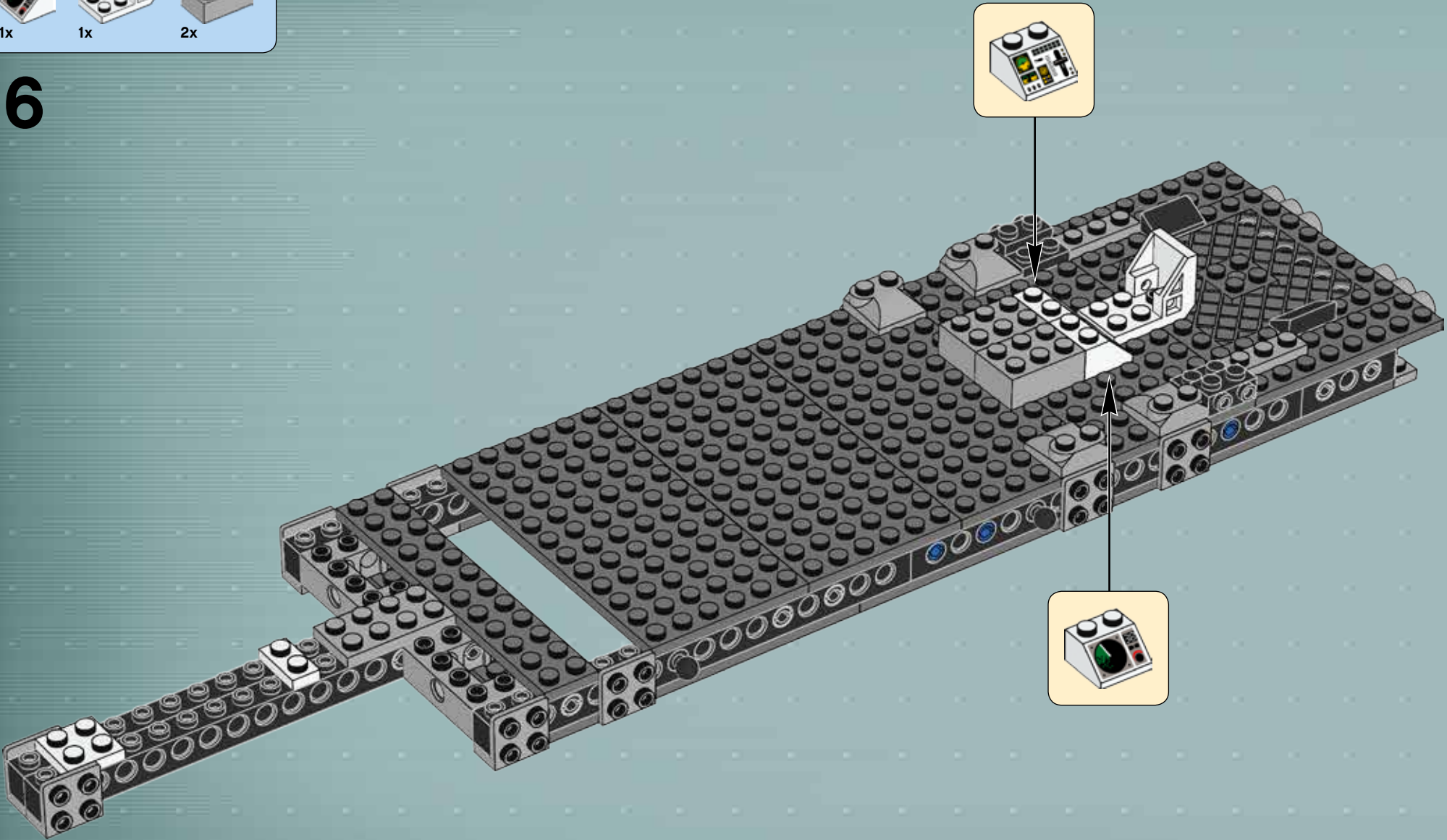

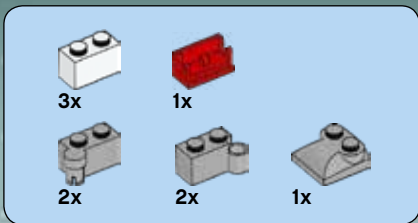

17

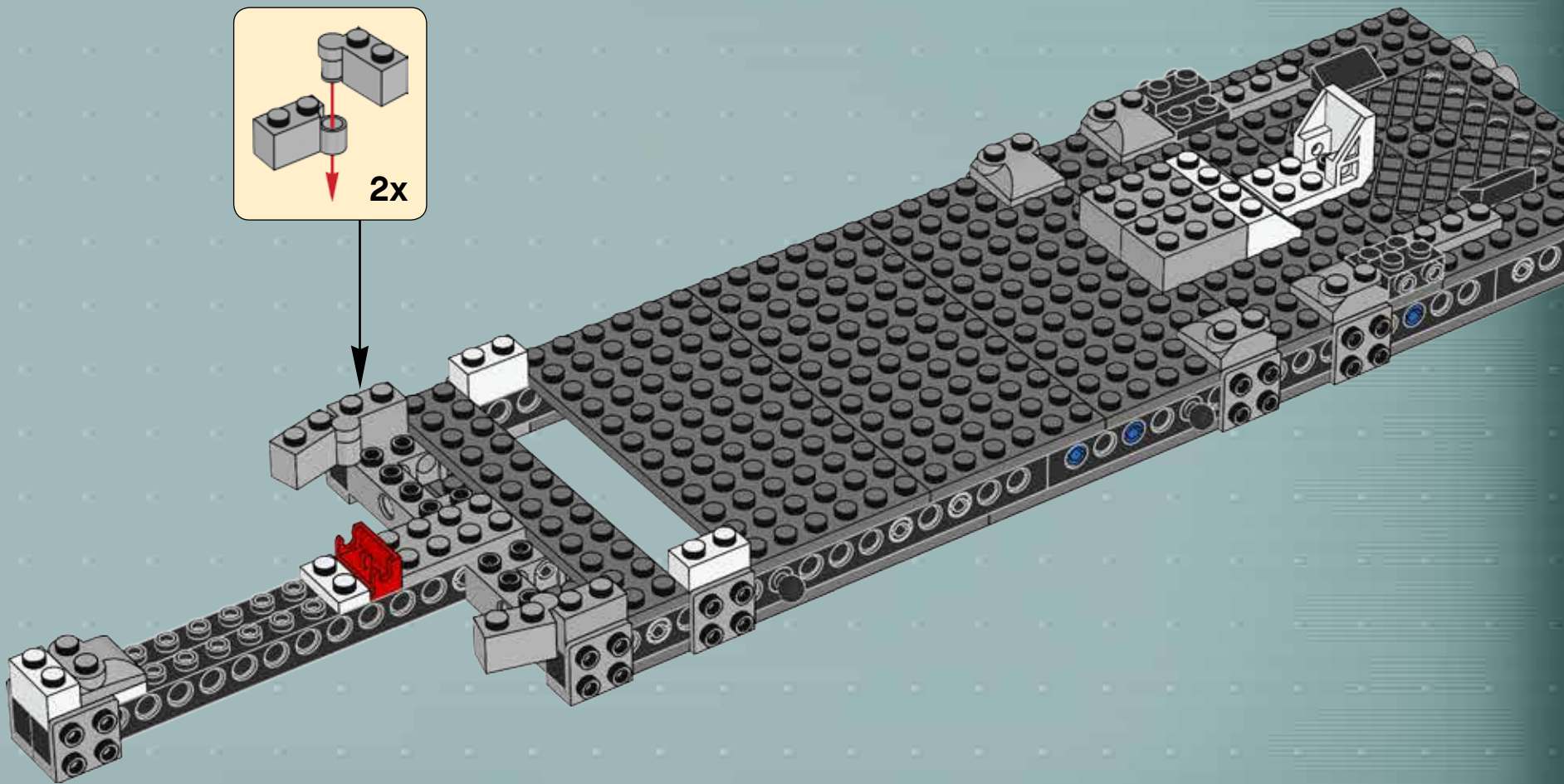
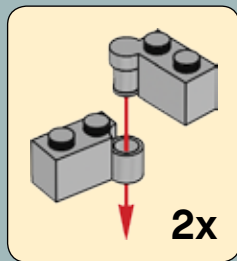

2x  2x  6x 

18

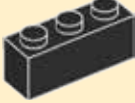
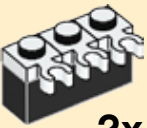
1  2  2x

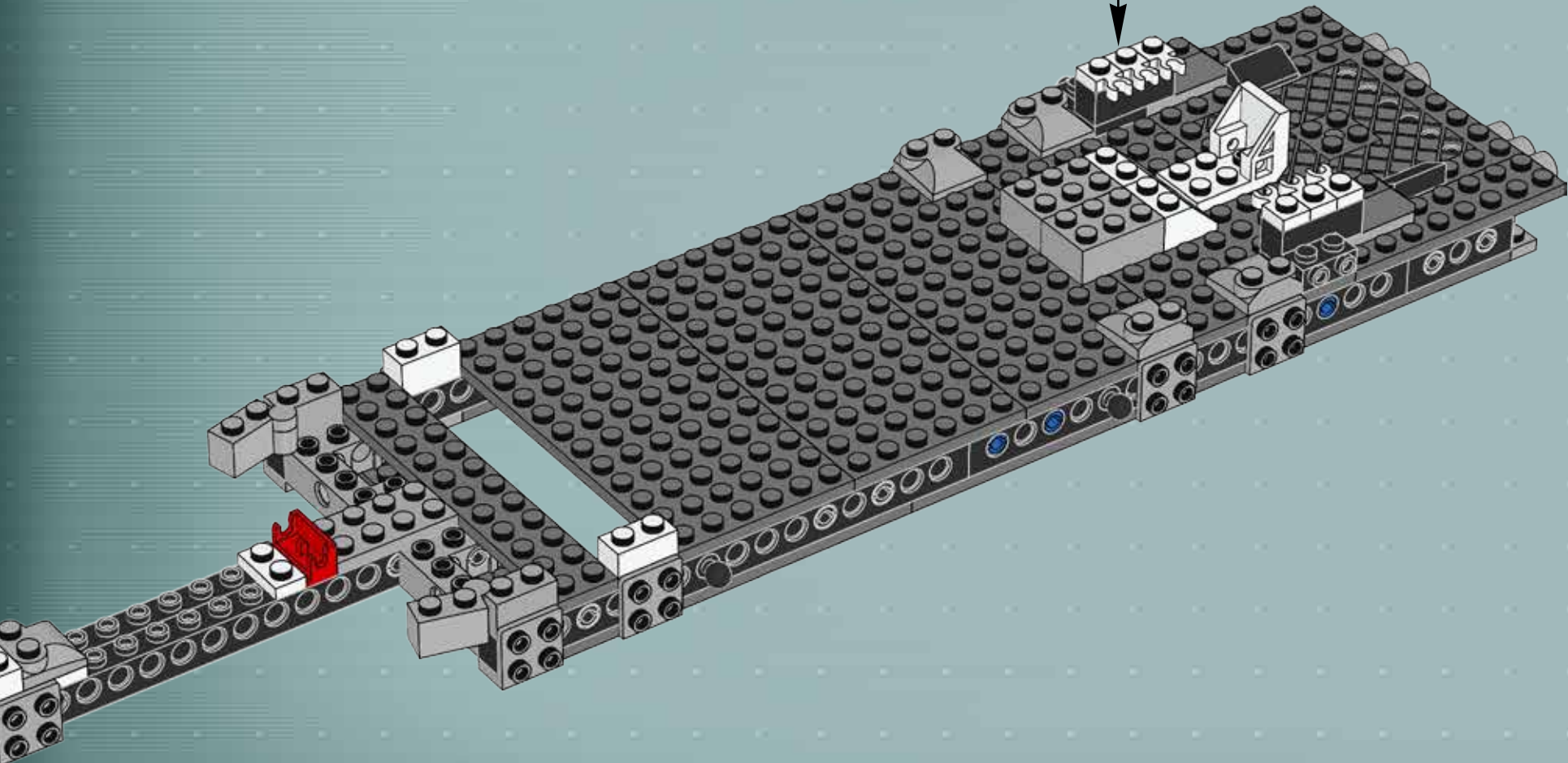

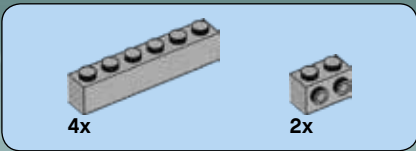

# 19

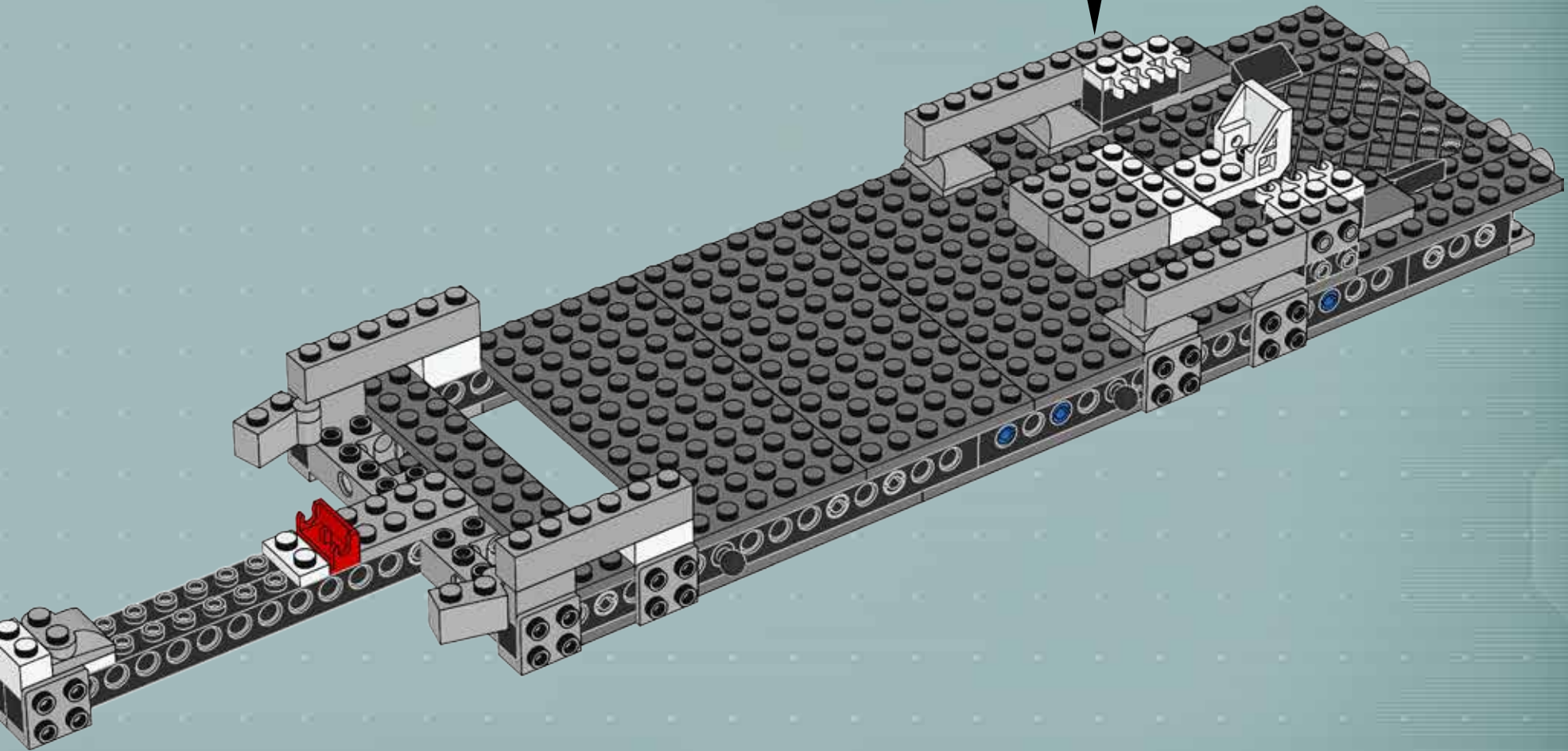
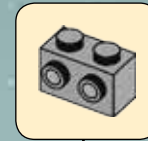

1x  
2x

4x  
1x

2x

20

2x

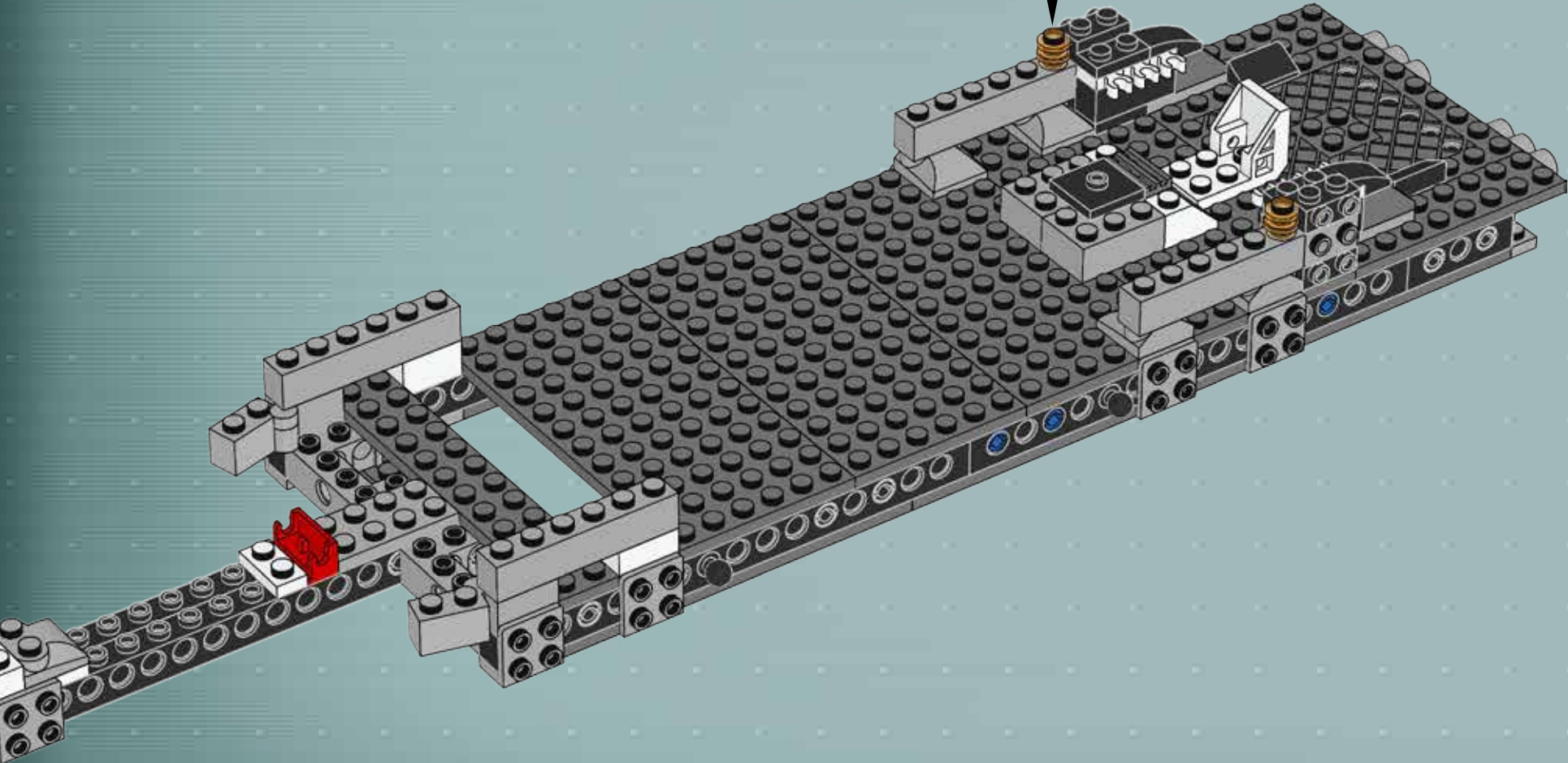

- 1x [Part]
- 2x [Part]
- 2x [Part]
- 1x [Part]
- 1x [Part]
- 1x [Part]
- 2x [Part]
- 2x [Part]
- 1x [Part]

# 21

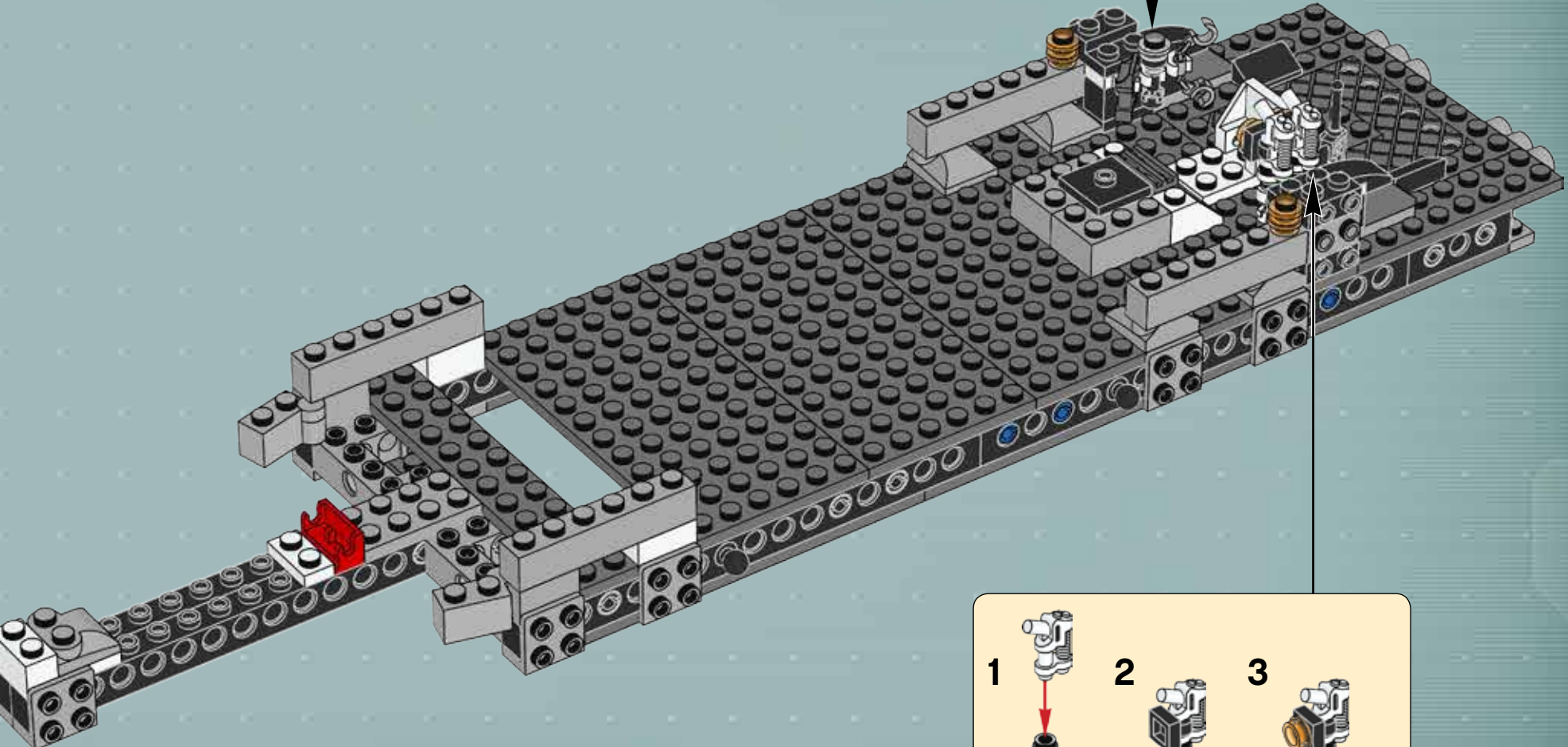
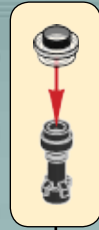

- 1 [Part]
  - 2 [Part]
  - 3 [Part]
- 2x

30 mm  
20 mm  
10 mm  
20 mm  
30 mm



4x



2x

# 22

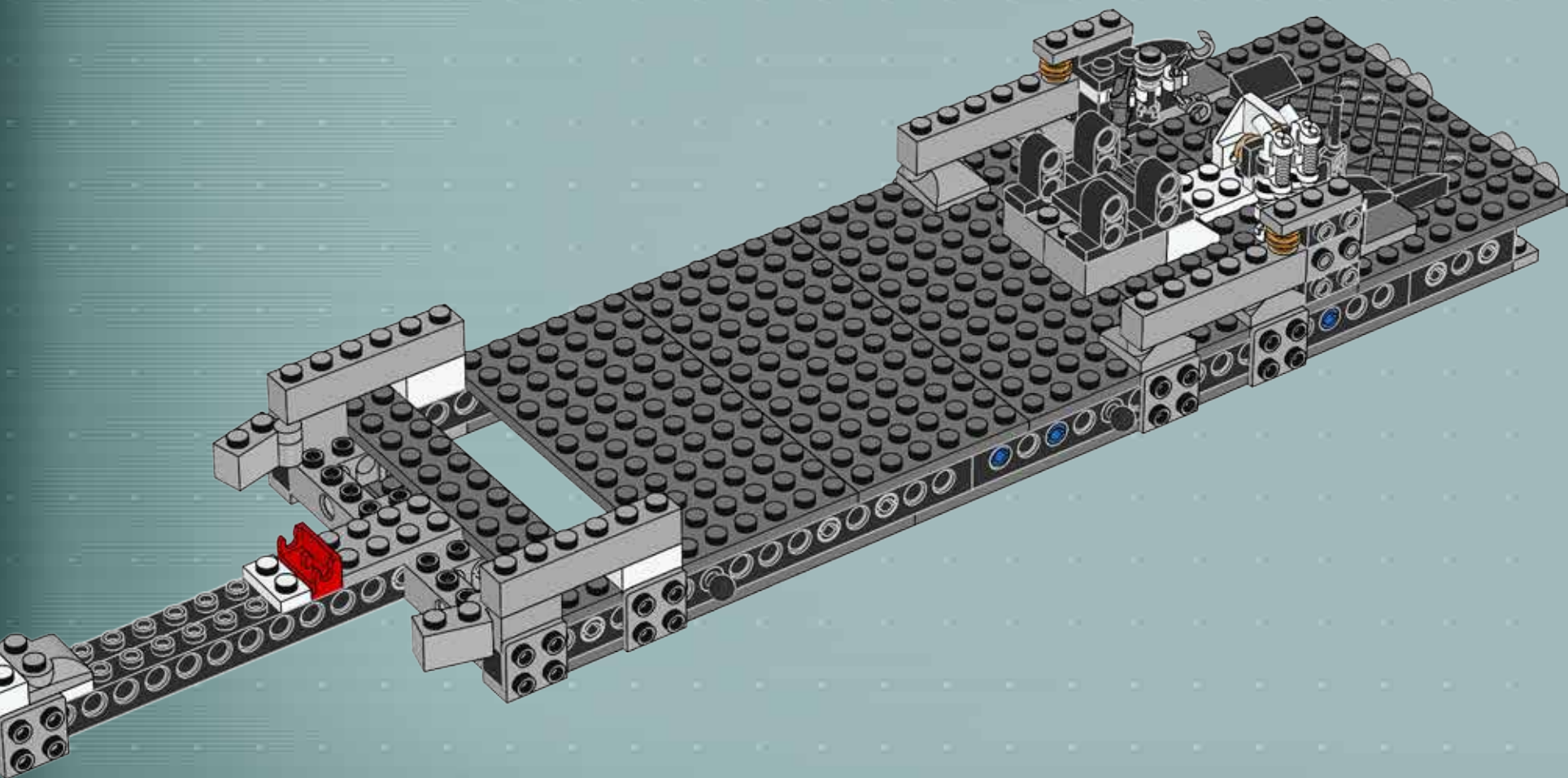



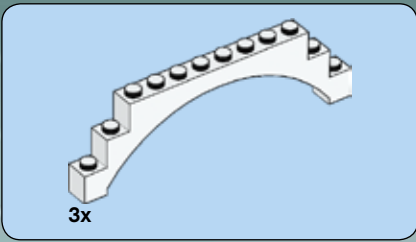

# 23

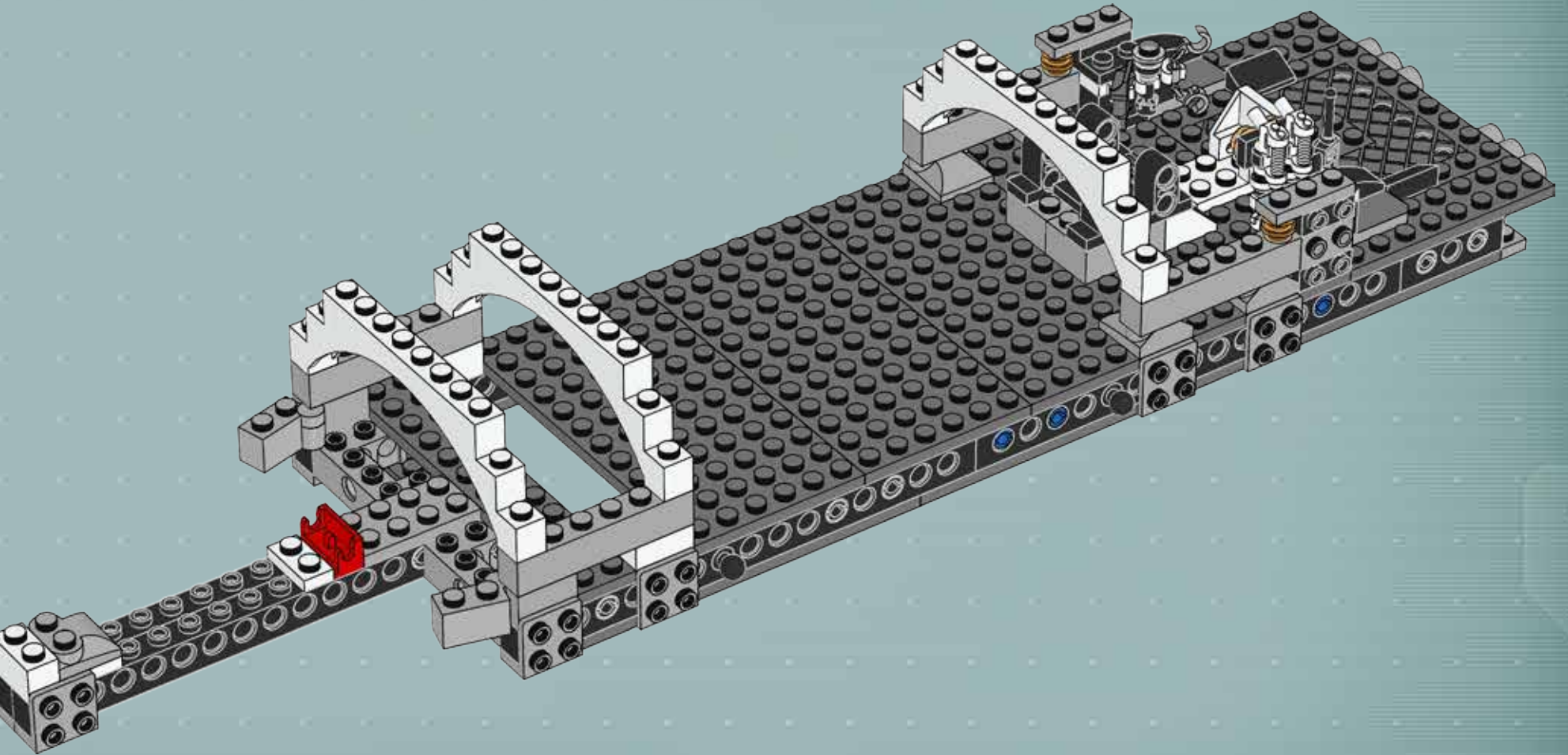

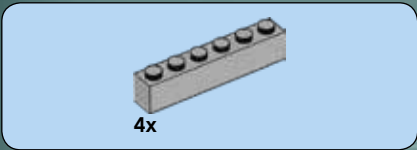

24

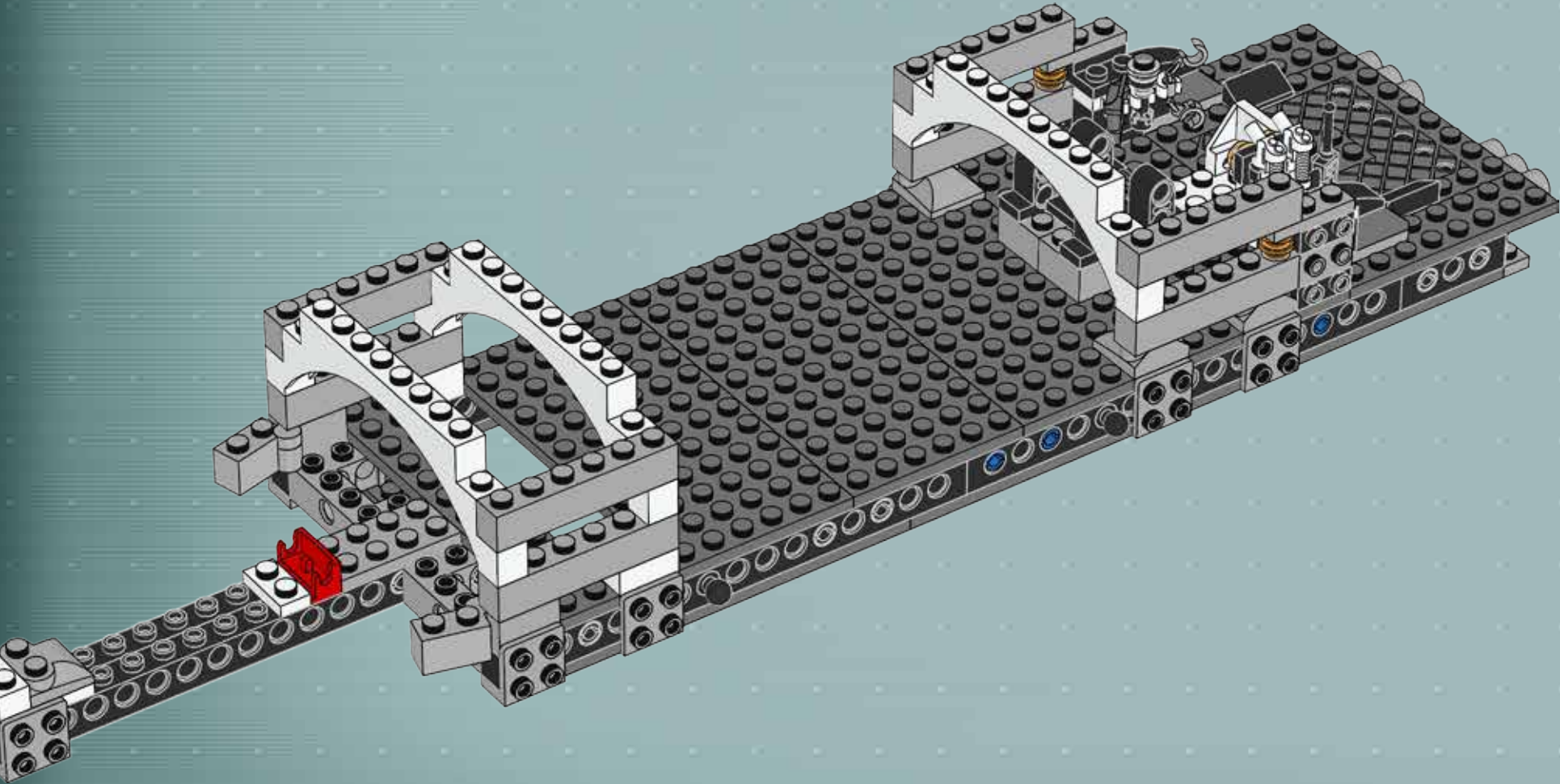

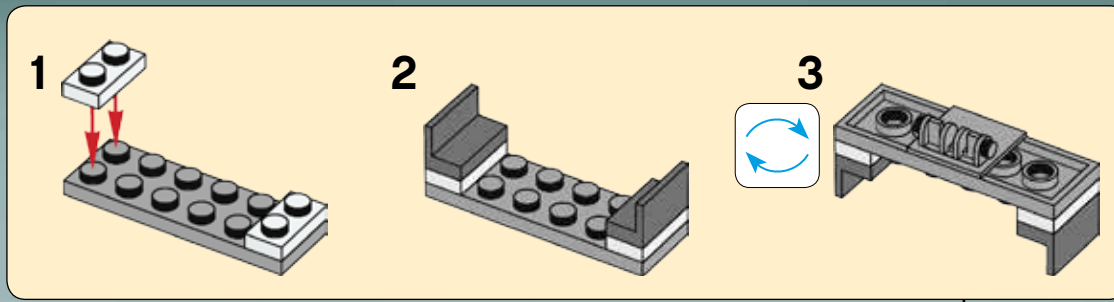
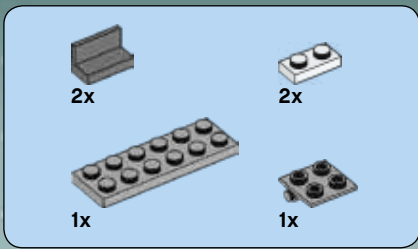

25

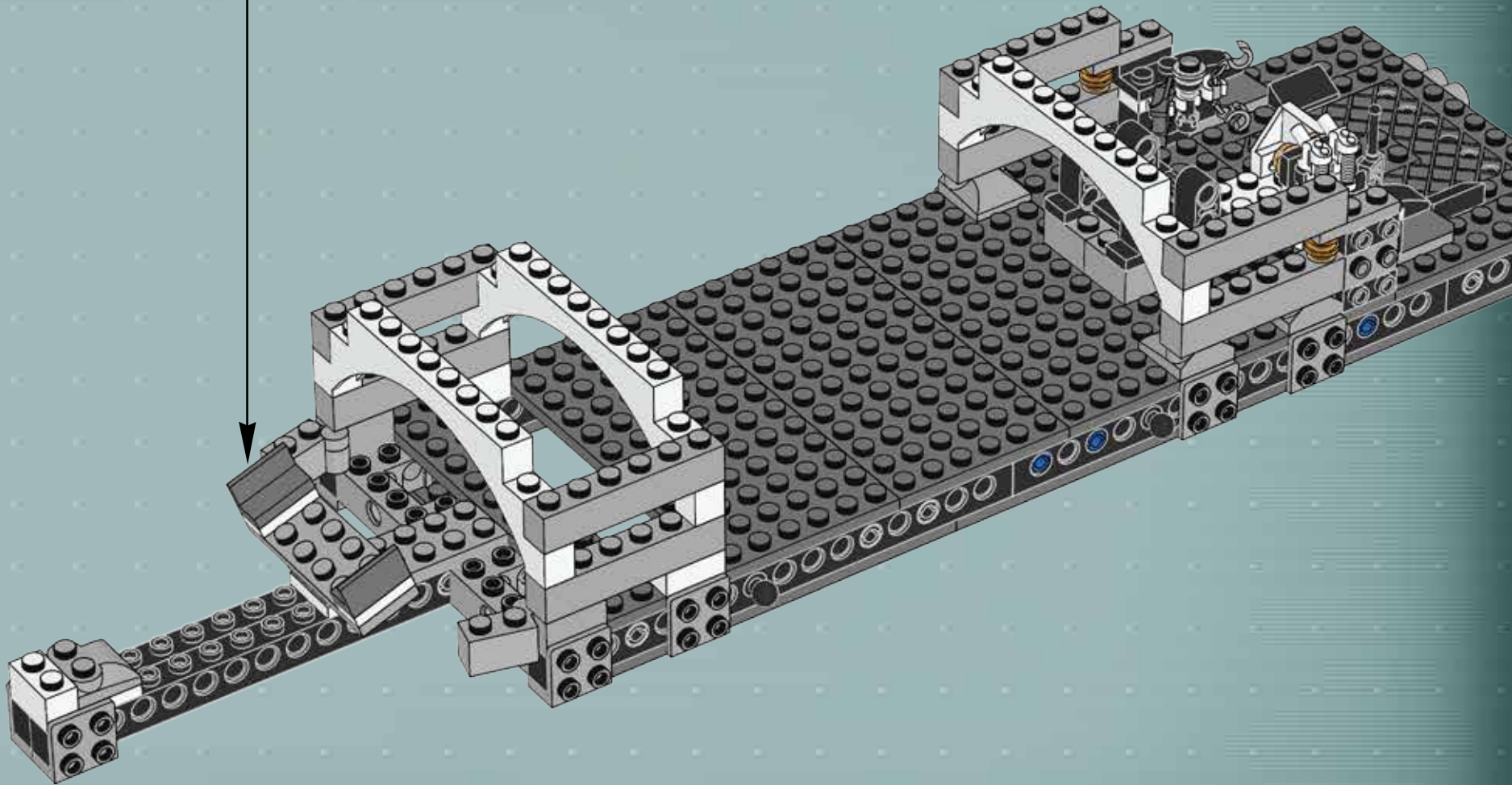

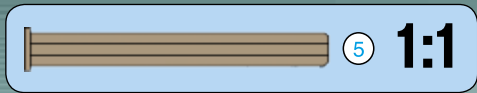
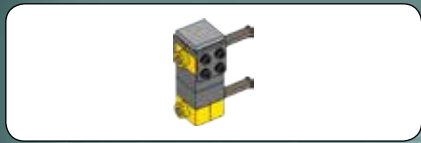

1

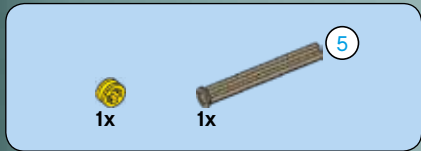
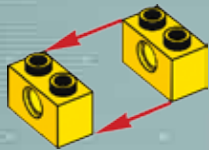

2

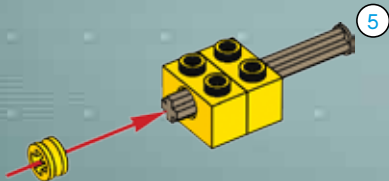

3

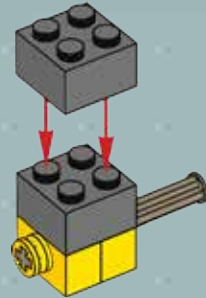

4

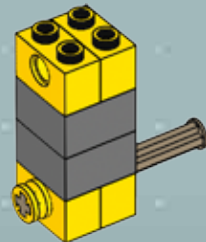

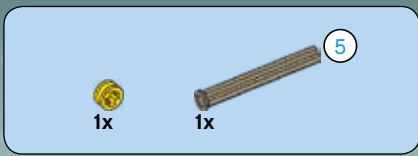

5

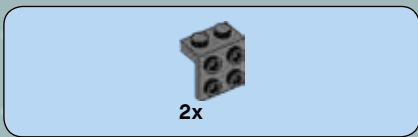
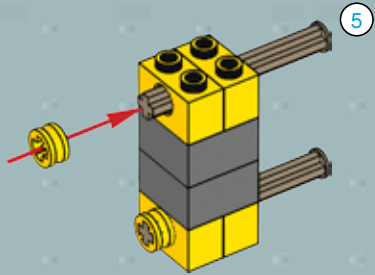

6

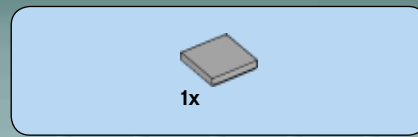
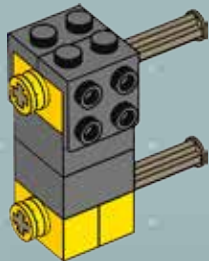

7

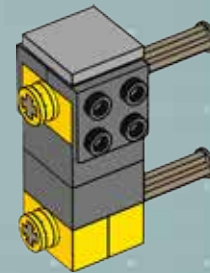

26

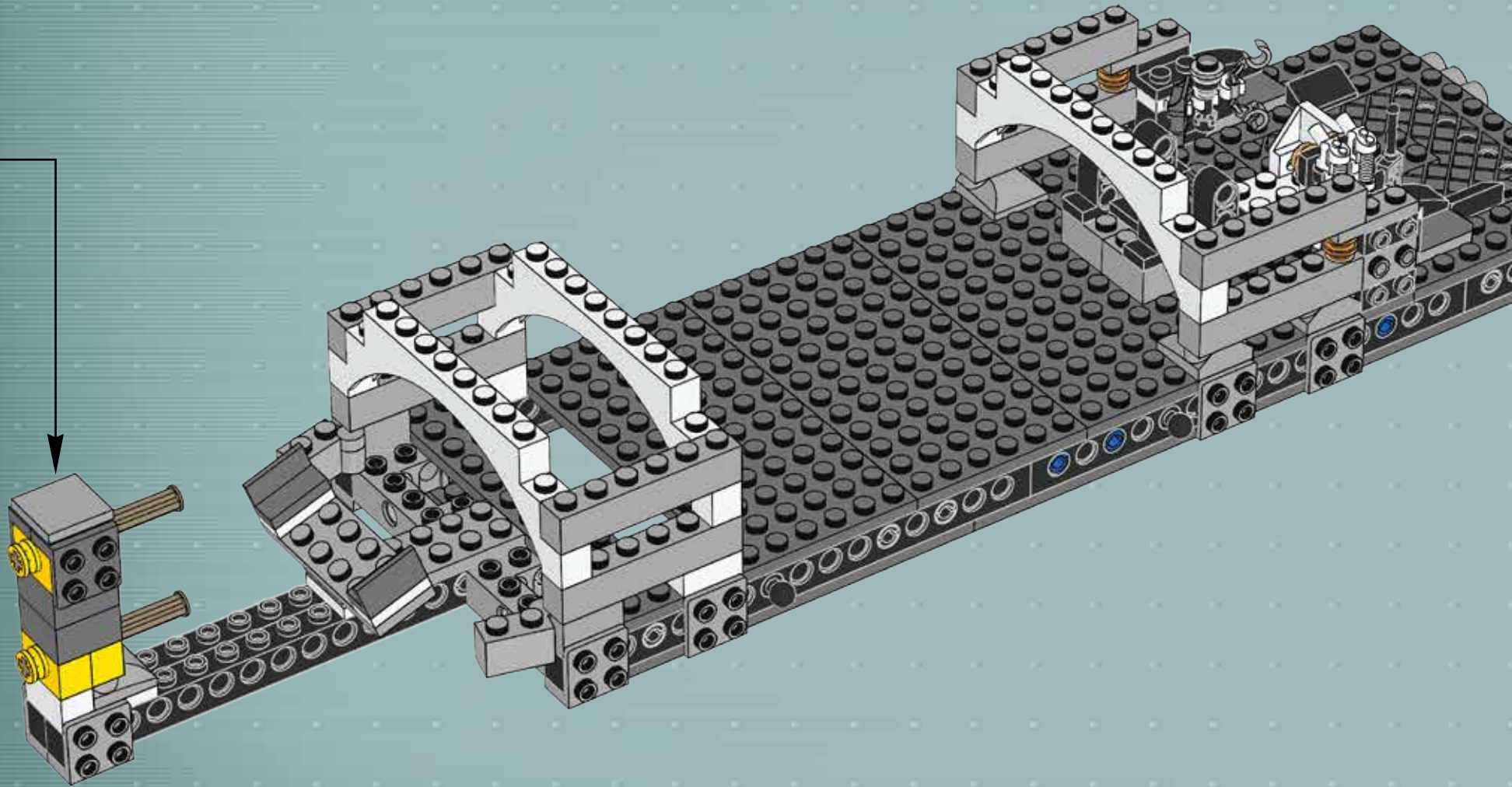



27

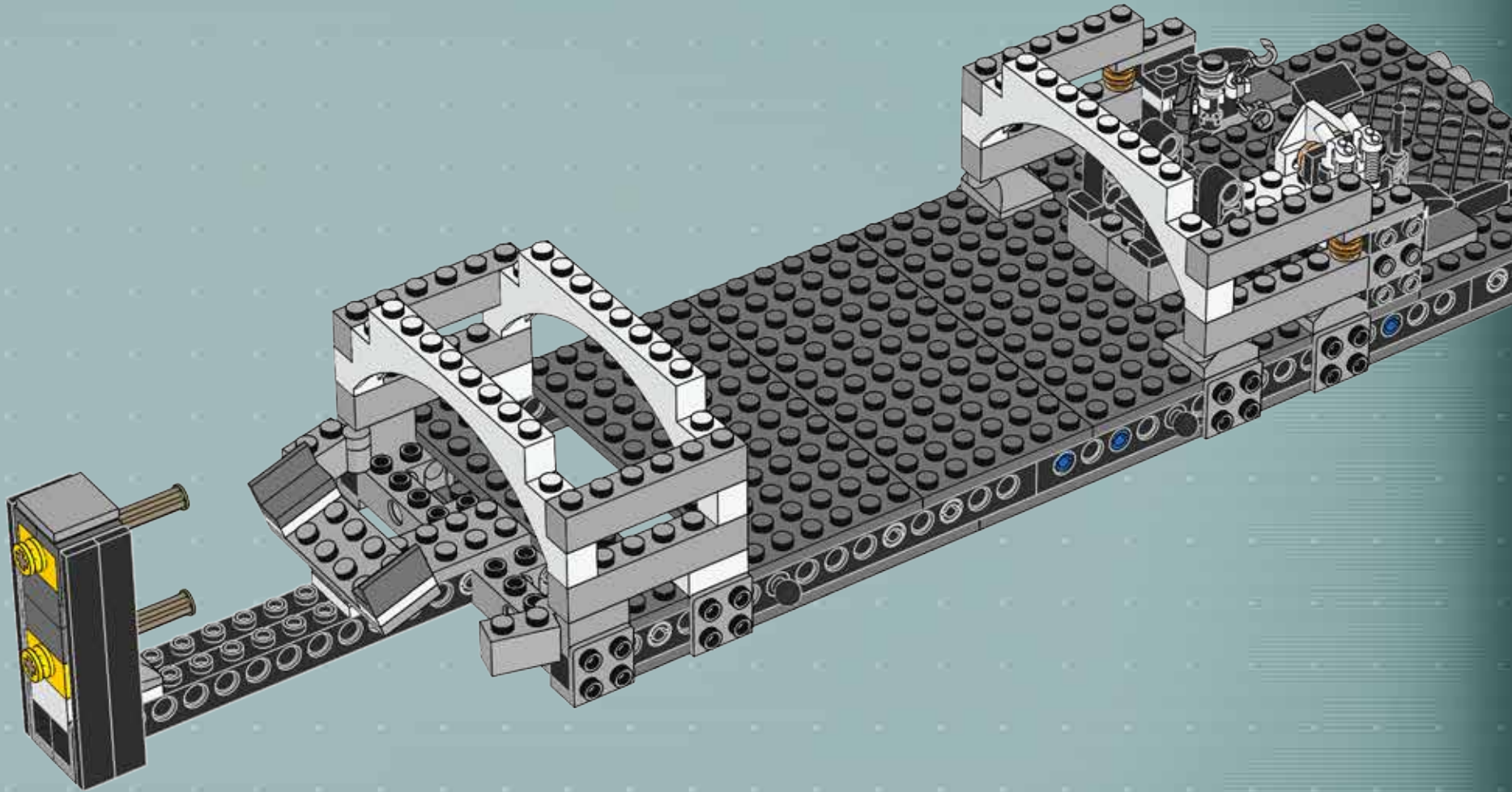

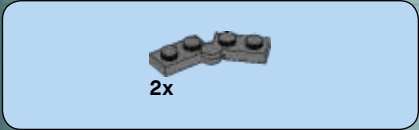
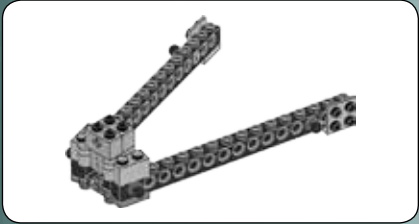
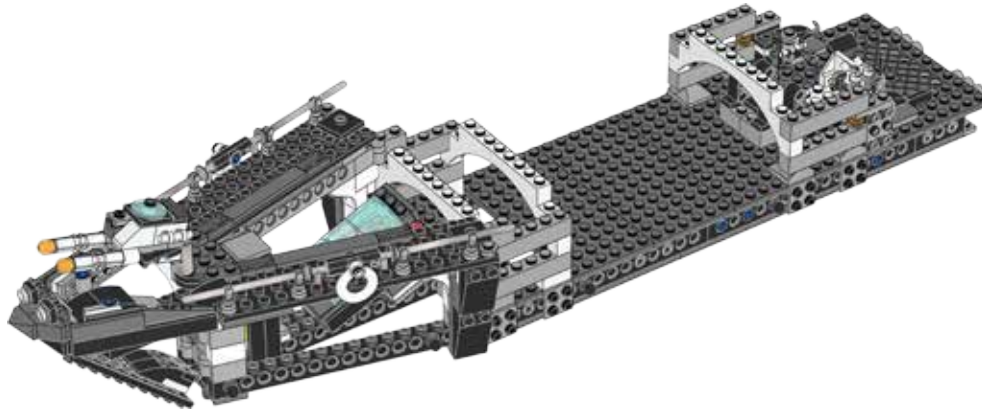
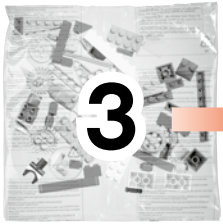

1

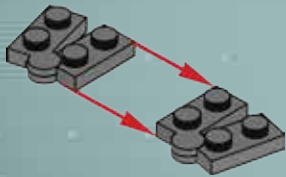

2

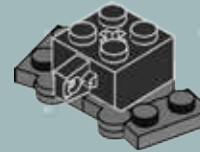



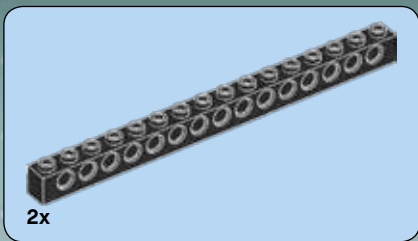

3

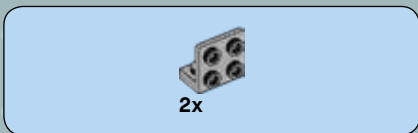
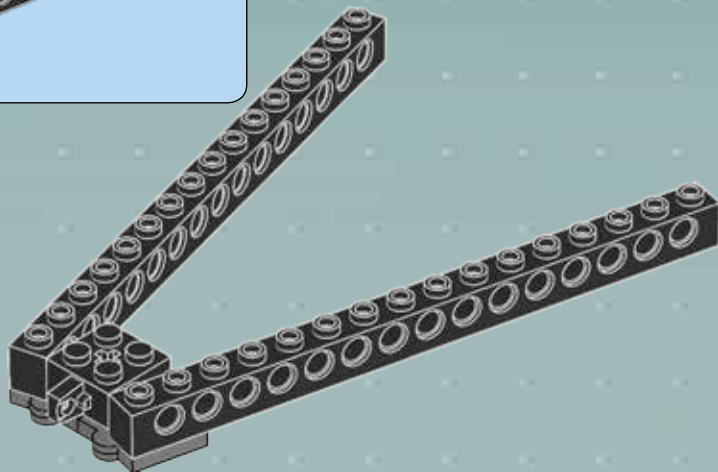

4

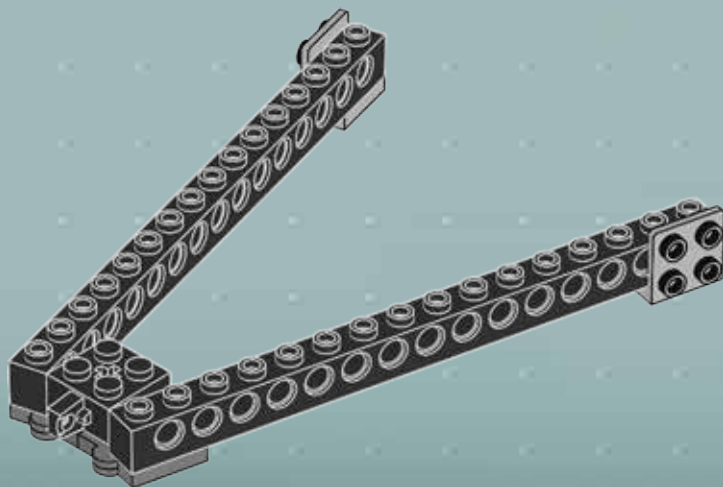

5

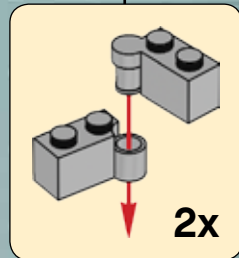
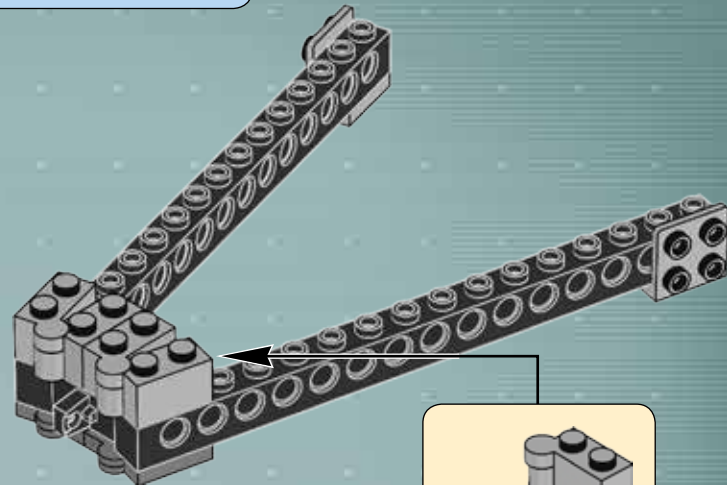

6

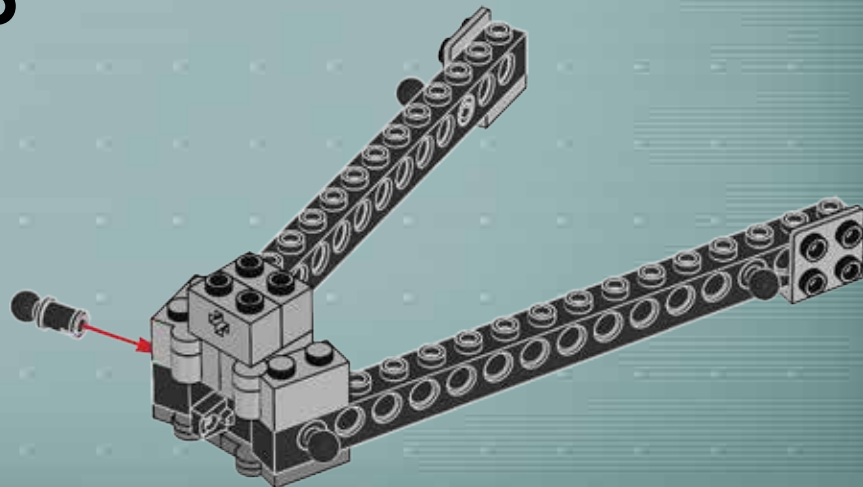

28

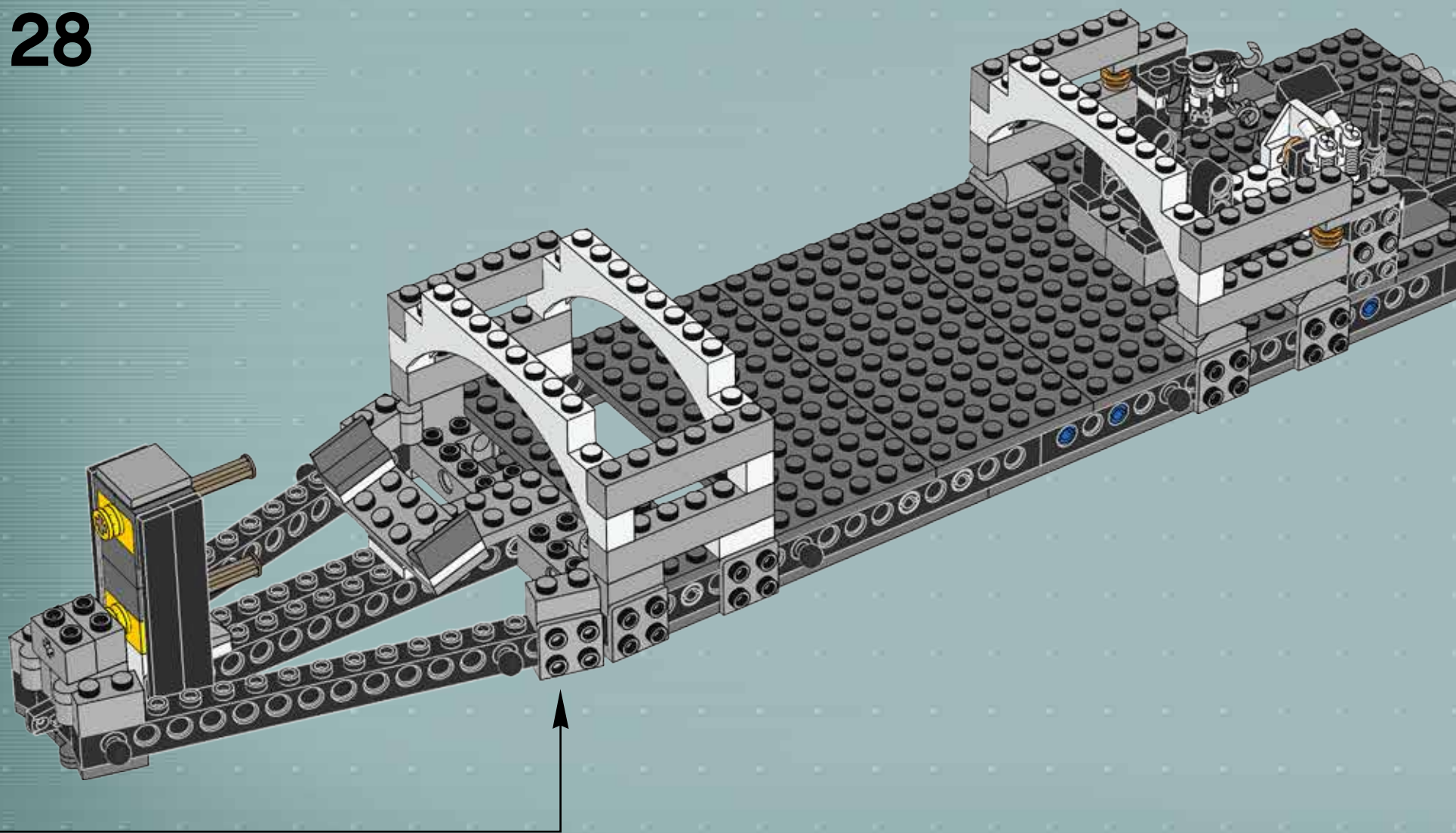

29

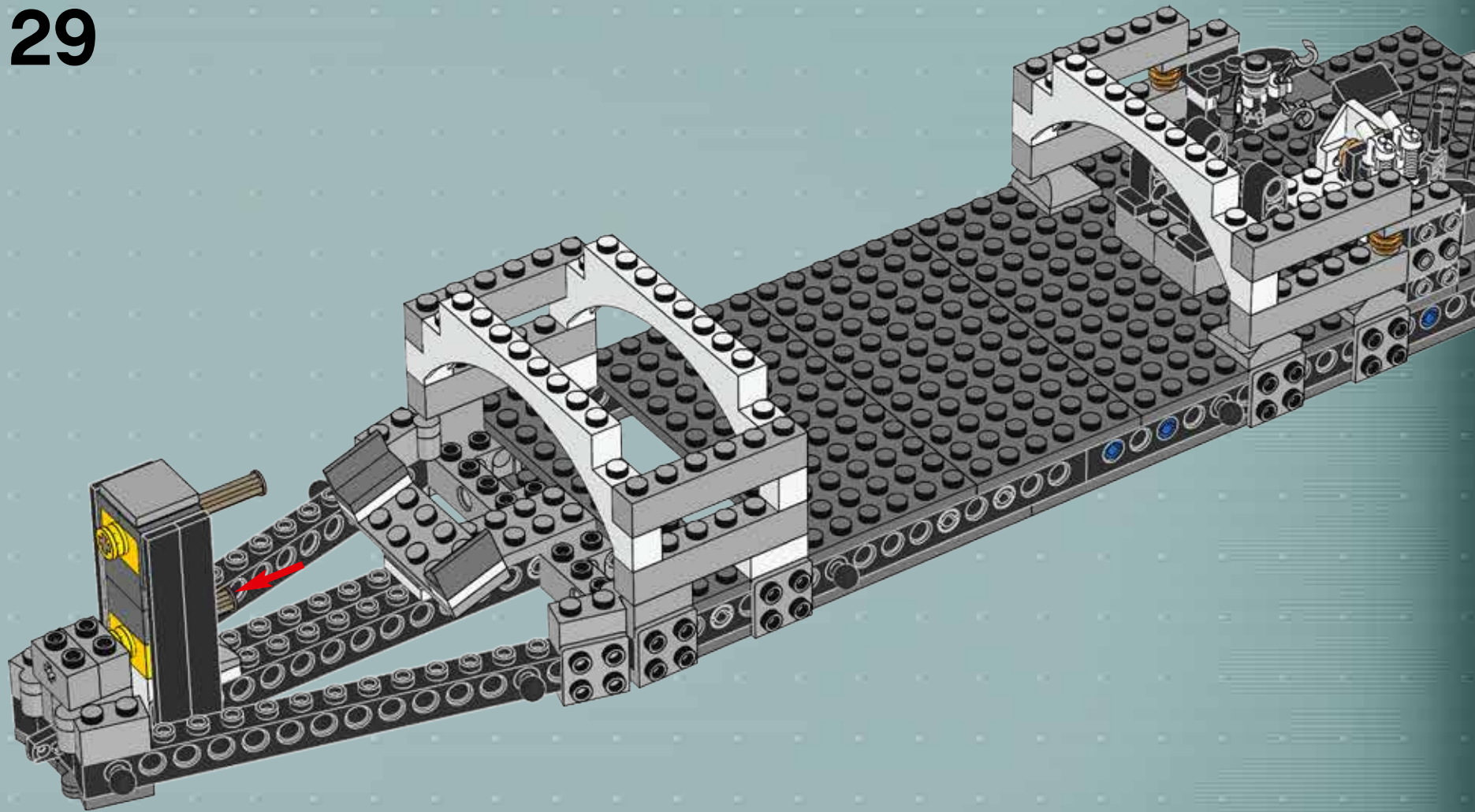

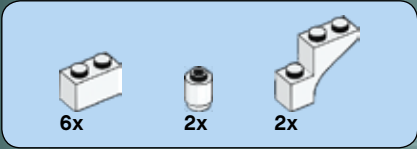

30

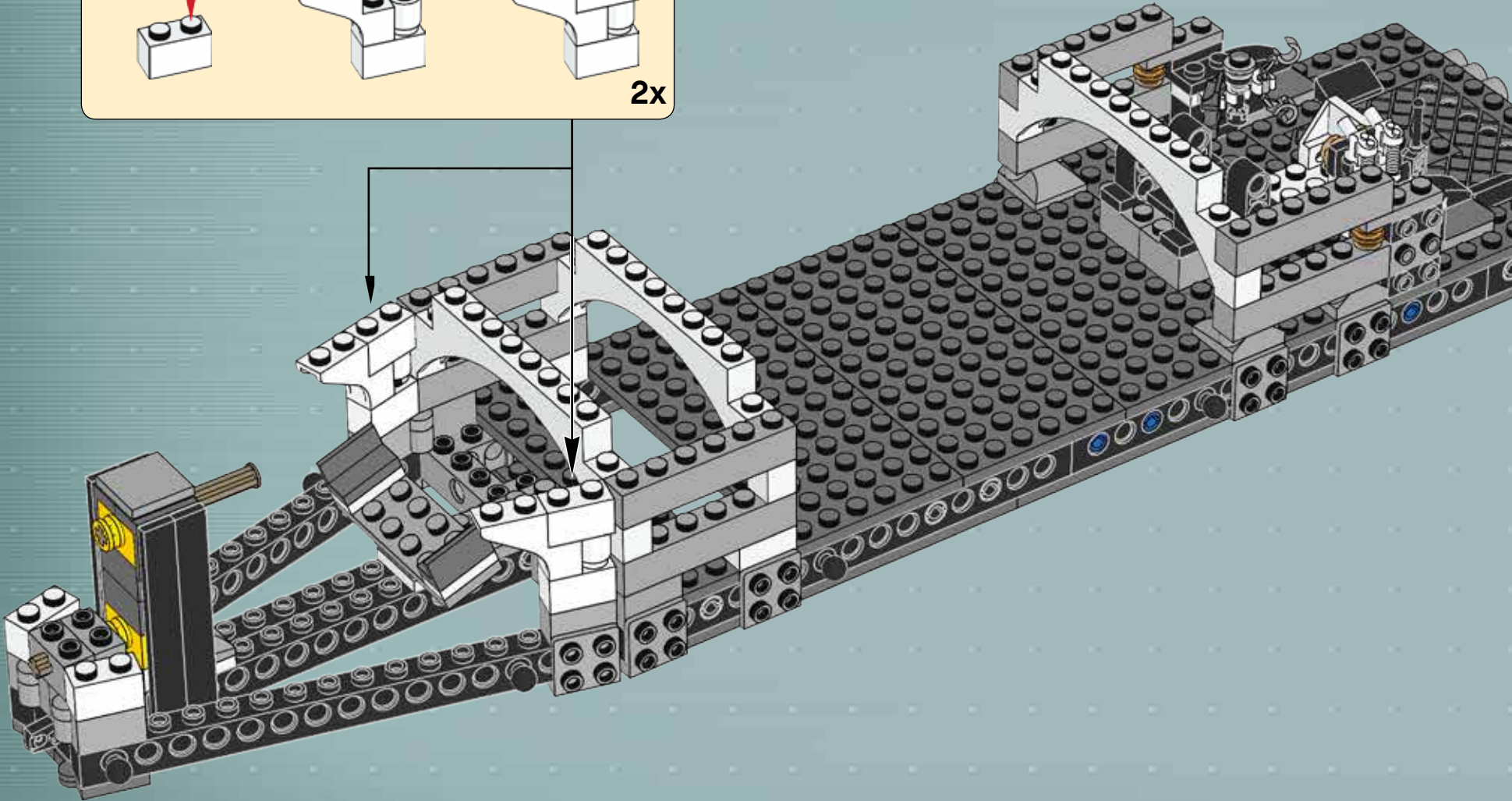
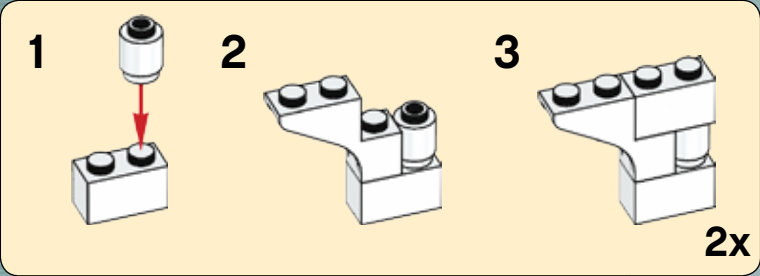



2x



2x

# 31

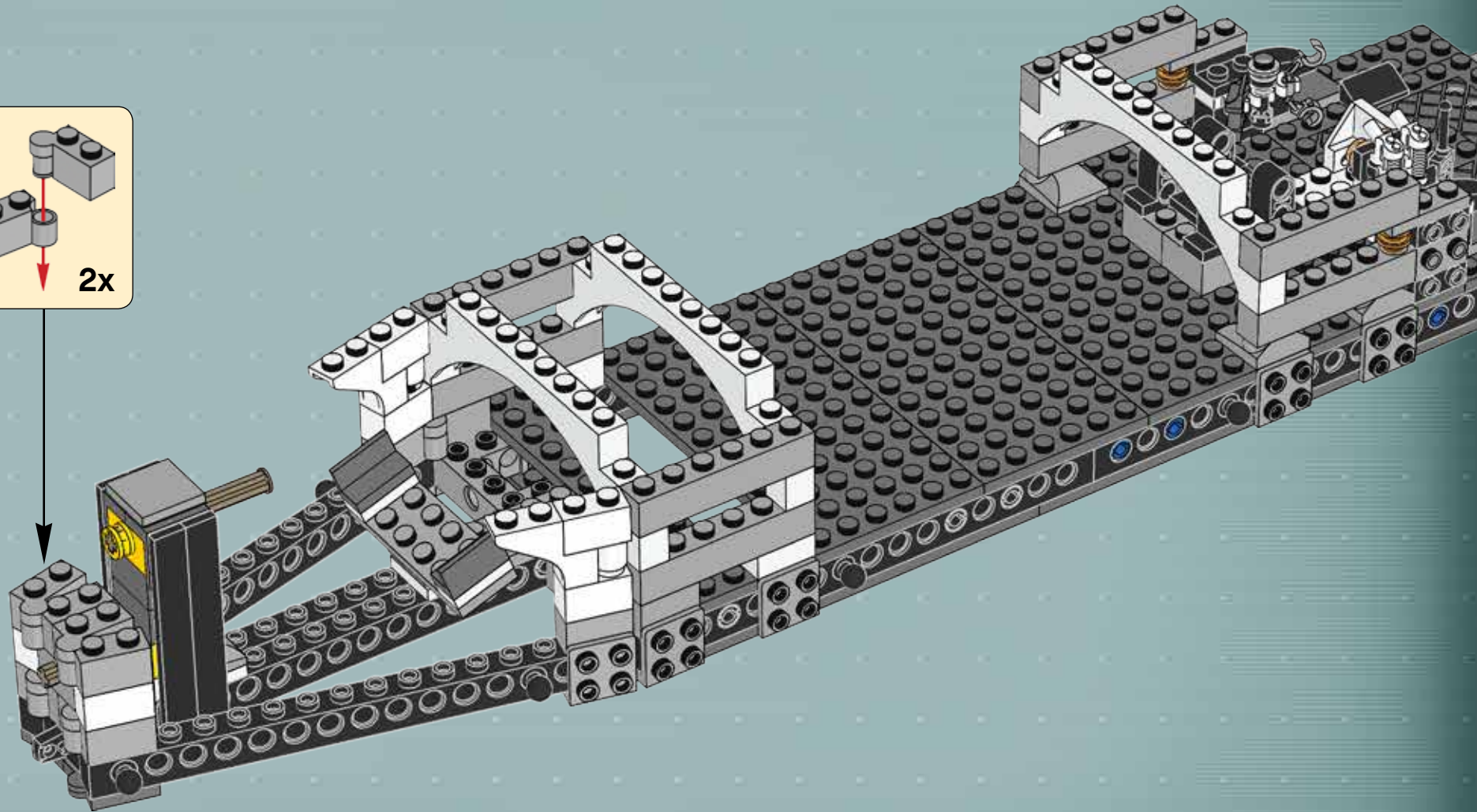
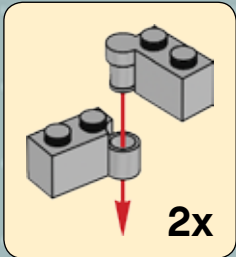

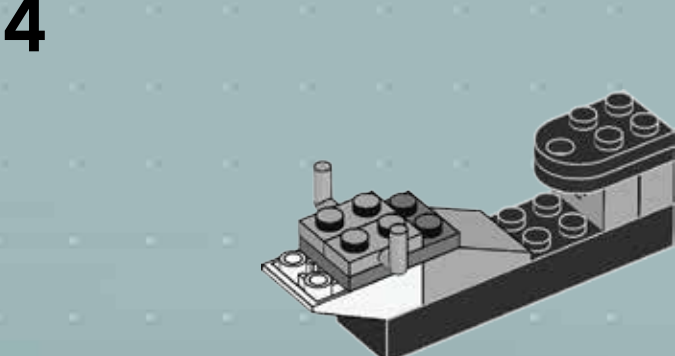
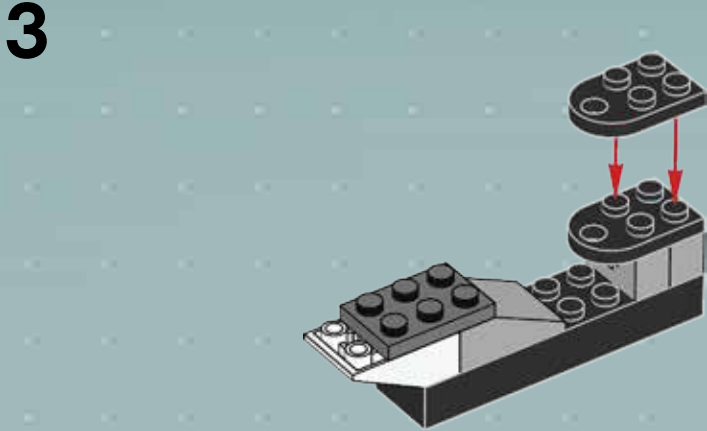
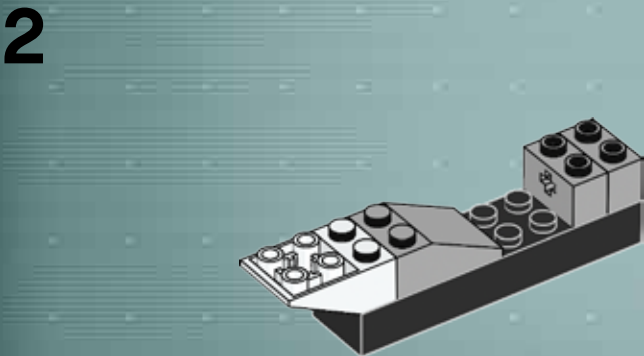
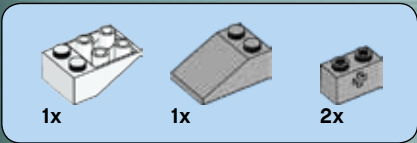
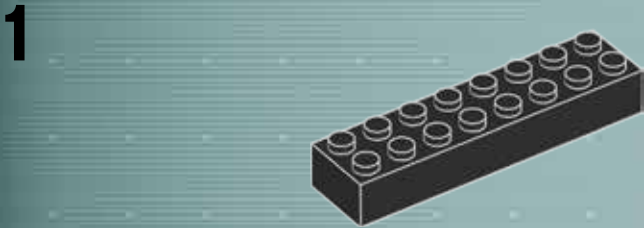
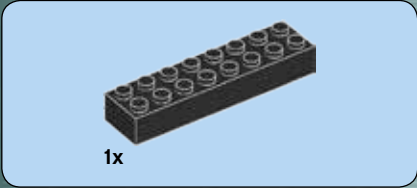
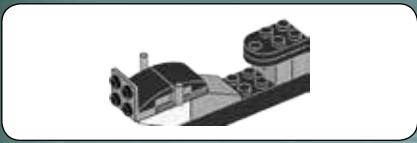



5

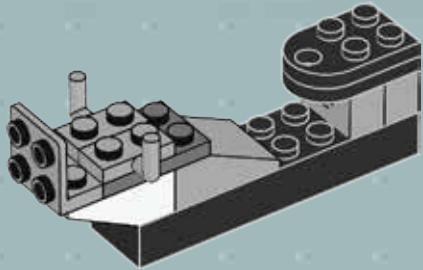

6

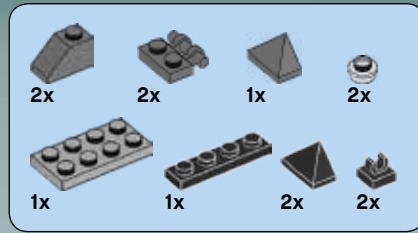
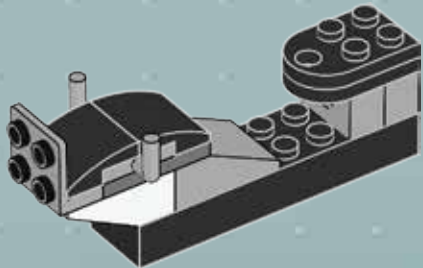

7

1



2



3

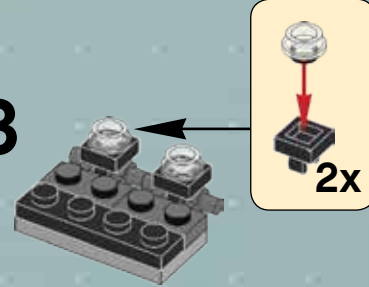

4



5

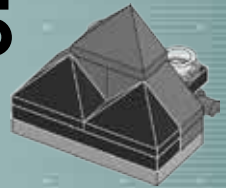

32

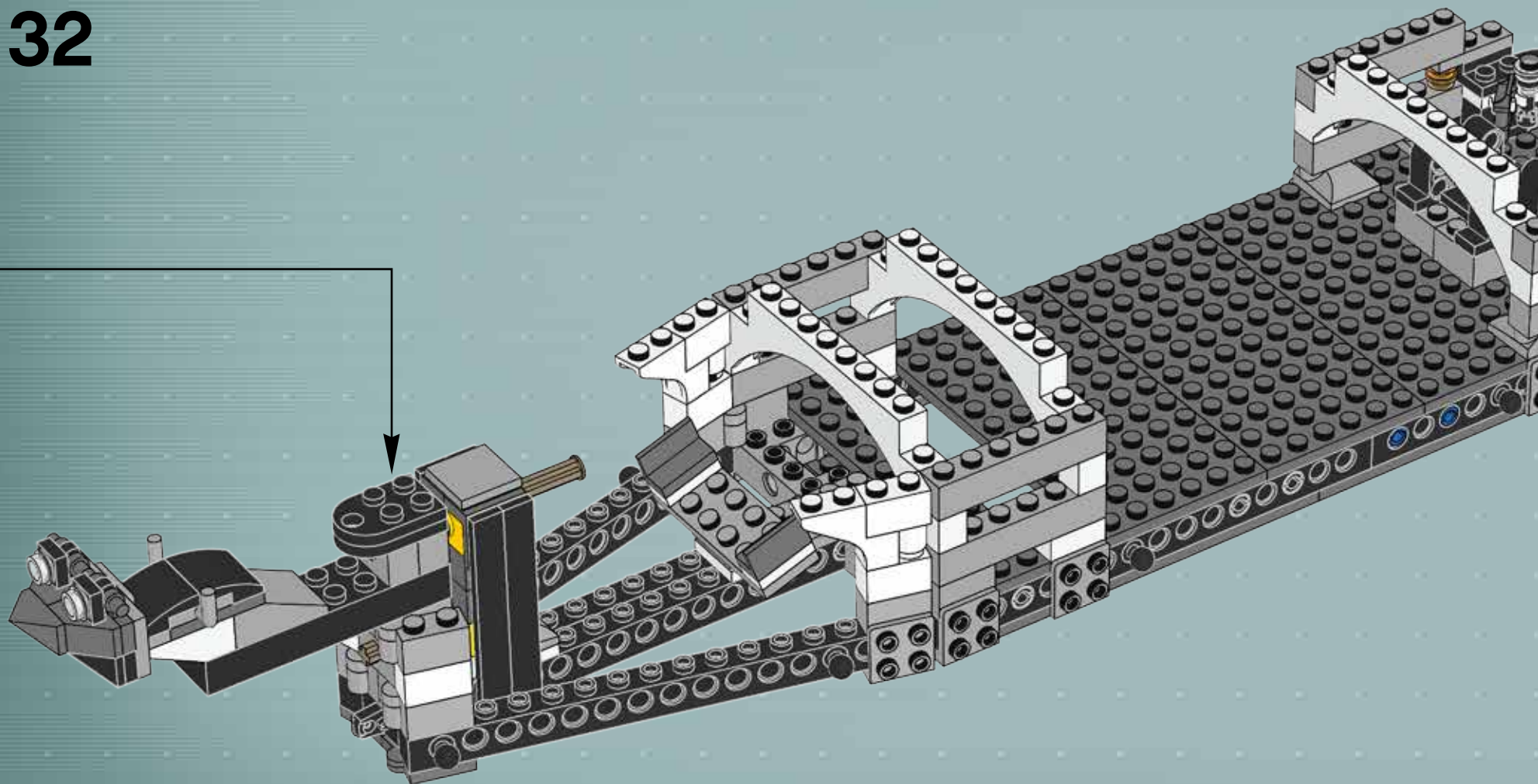



33

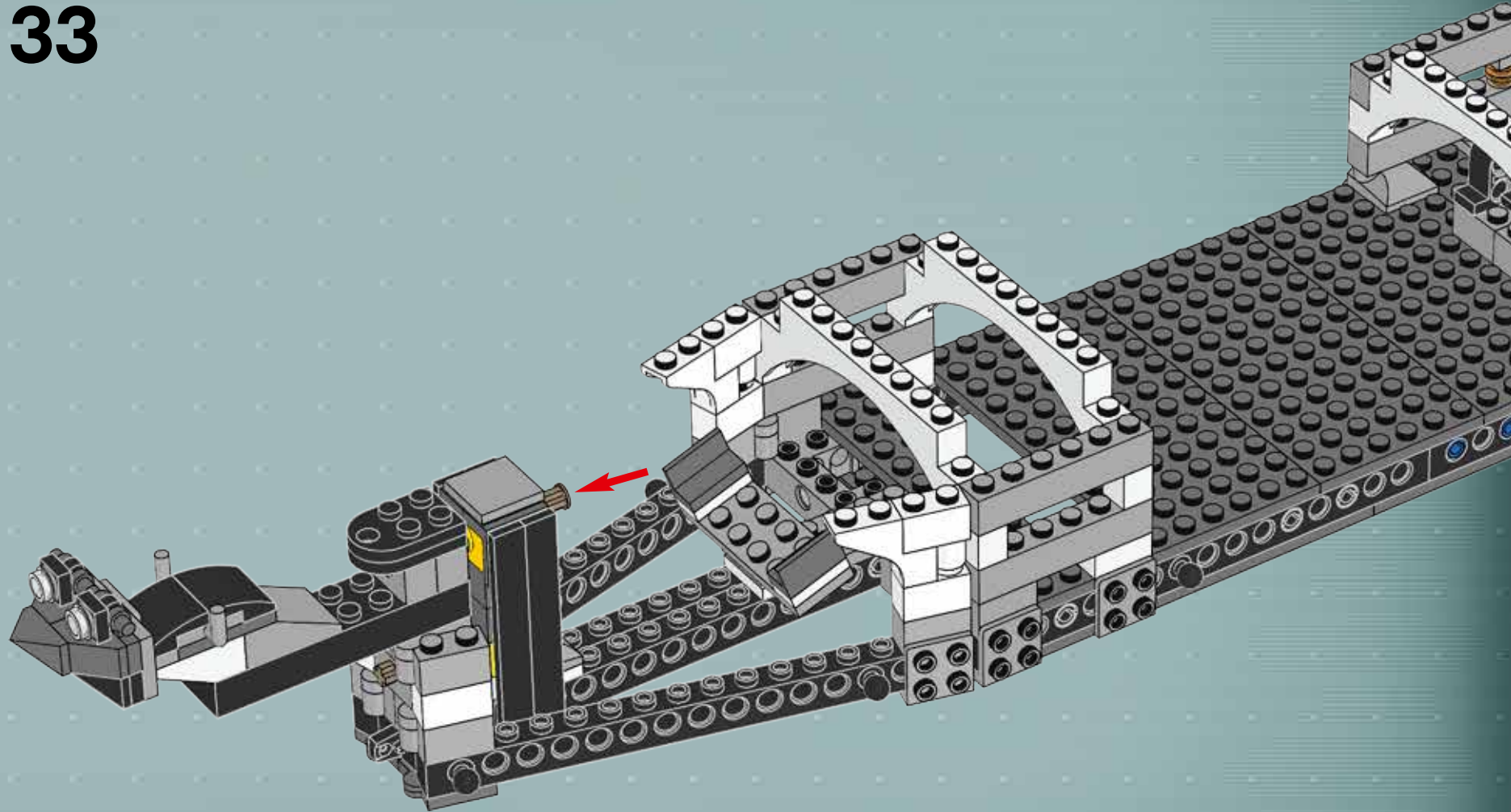

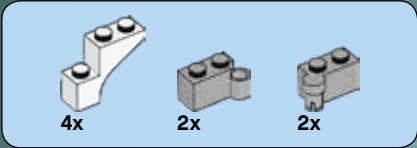

34

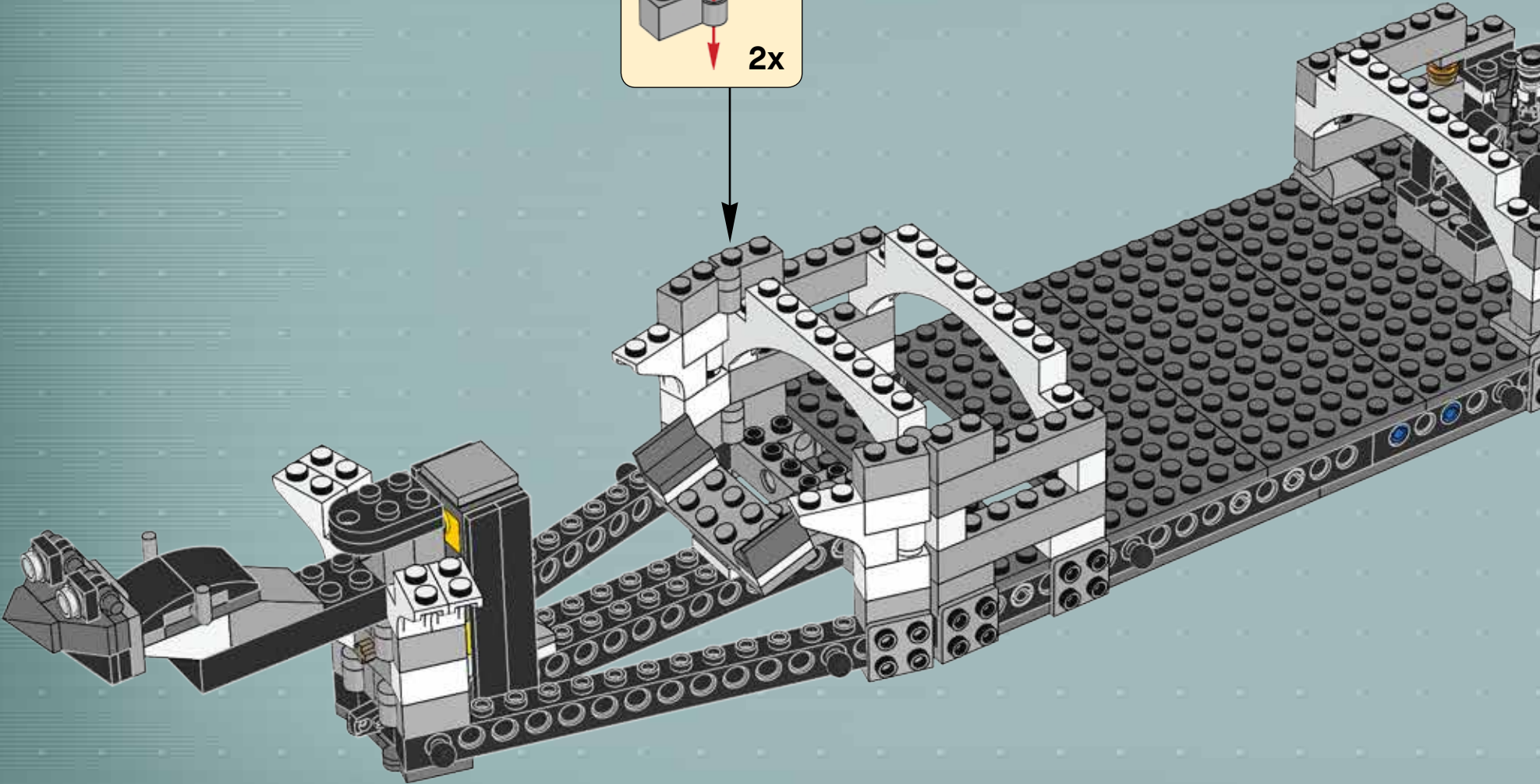
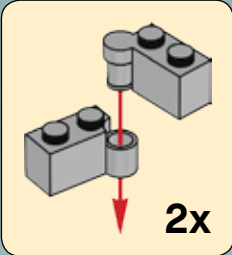

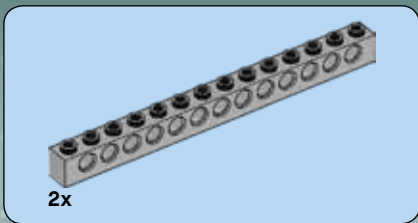

35

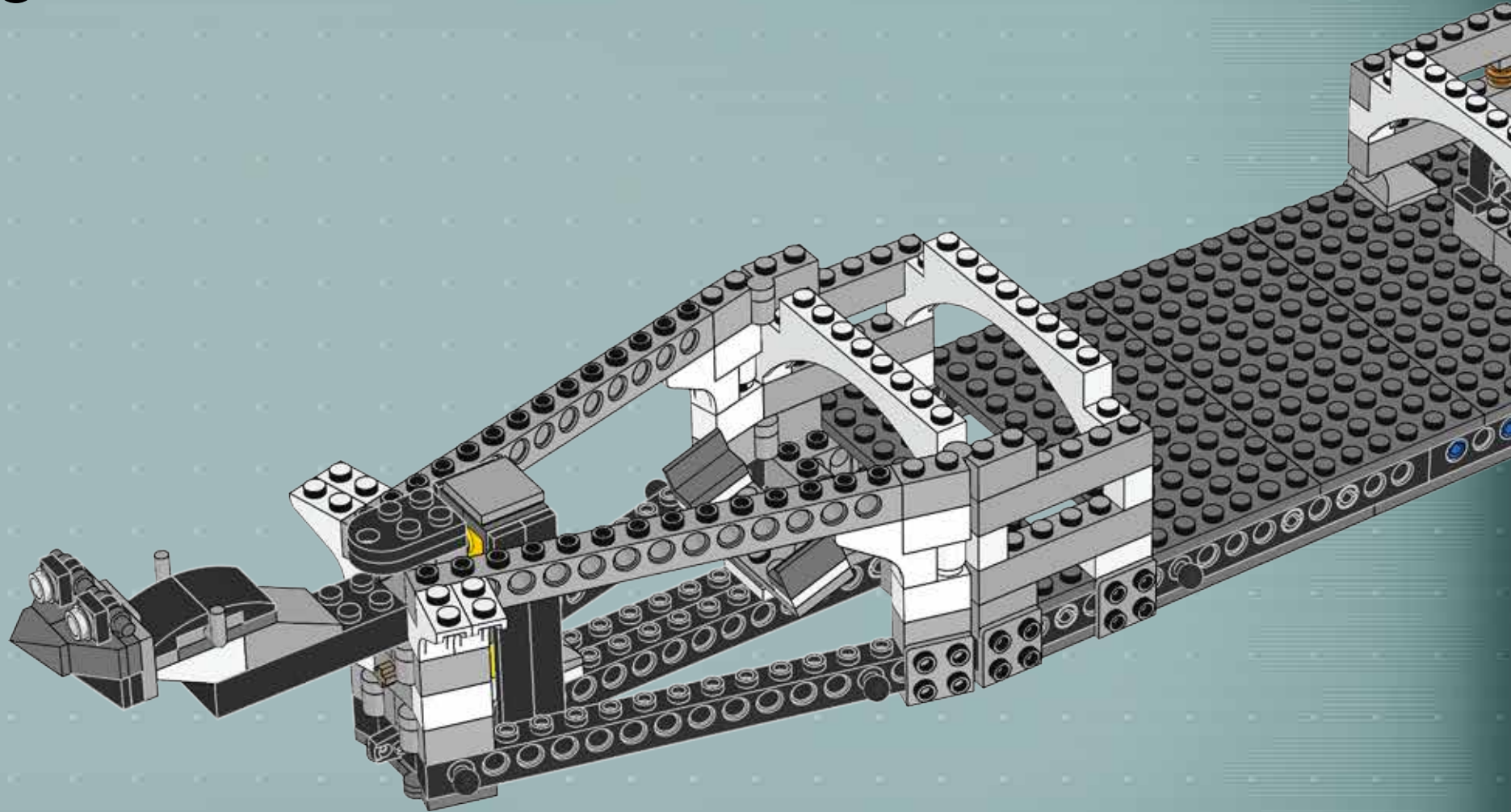

36

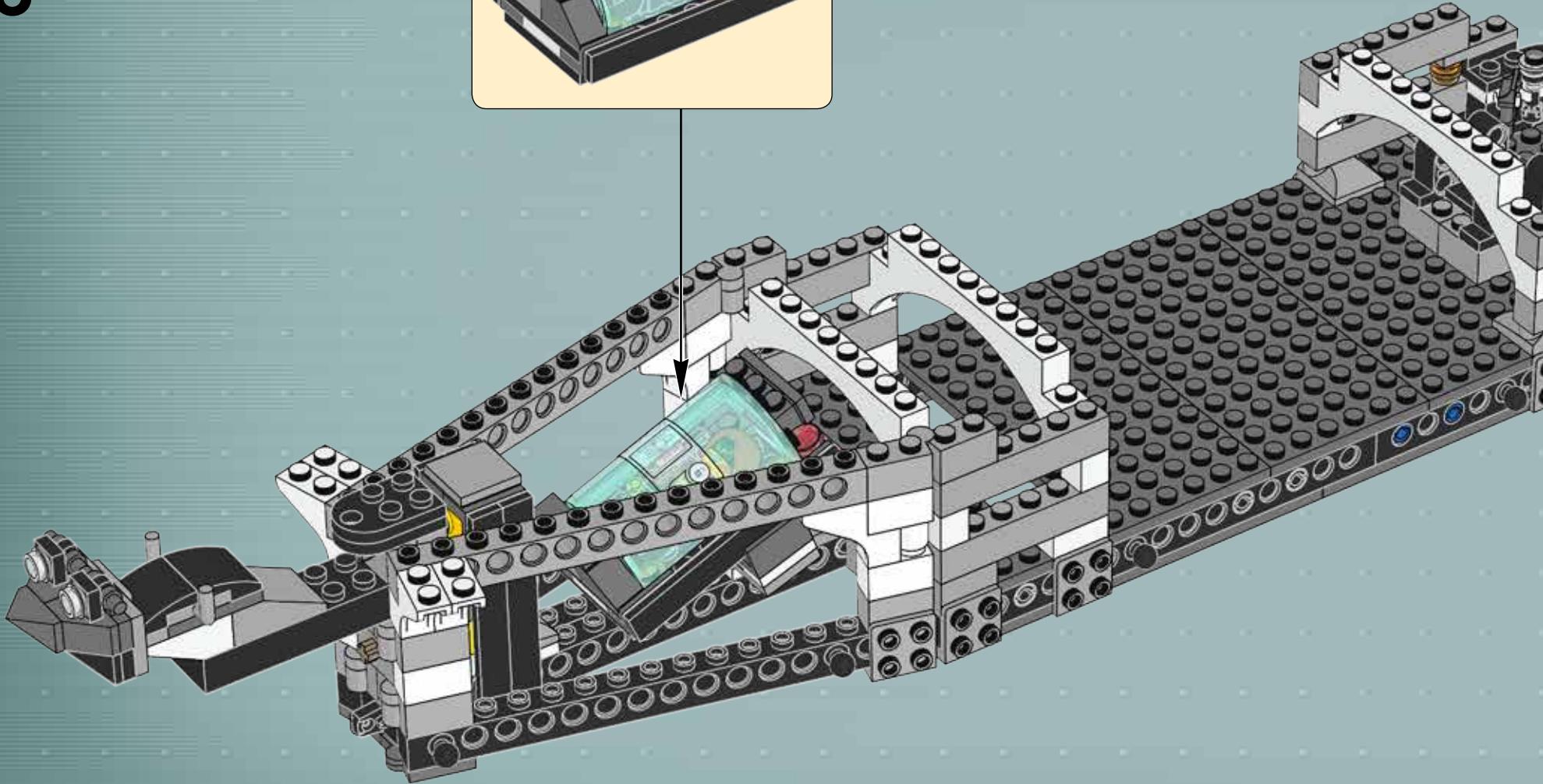
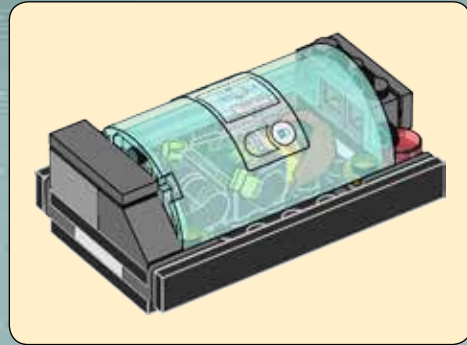

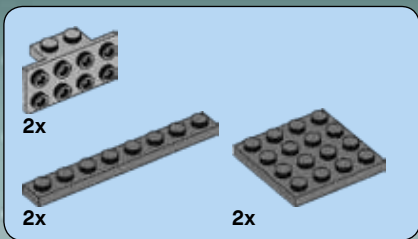

37

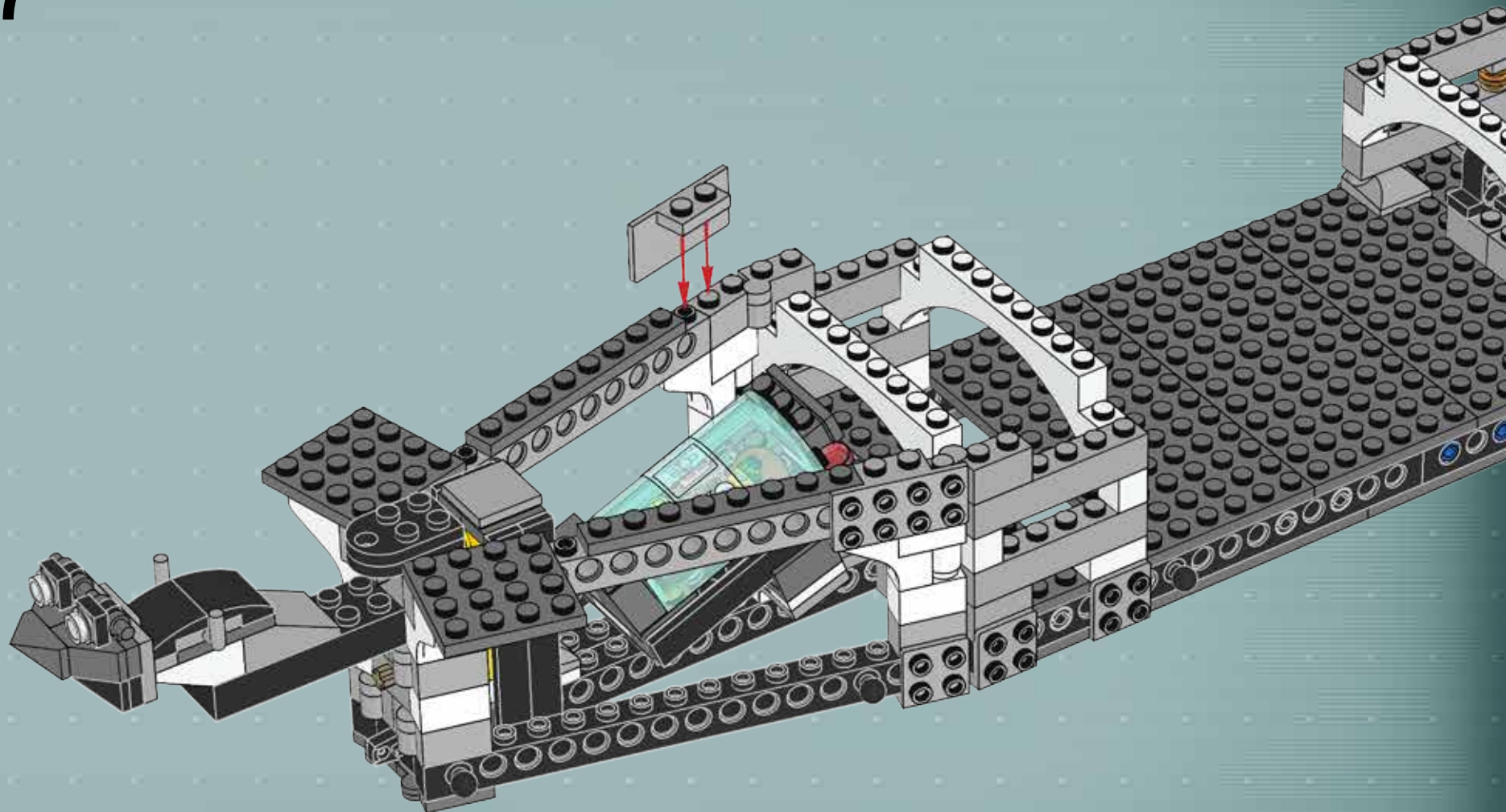

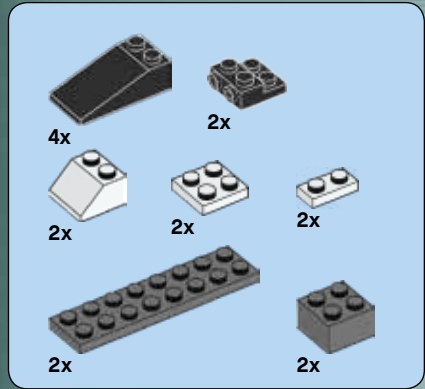

38

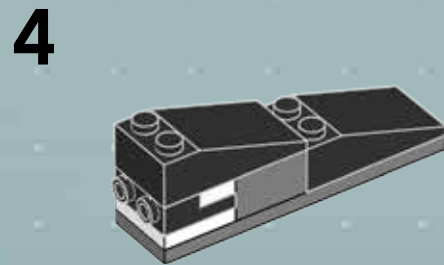
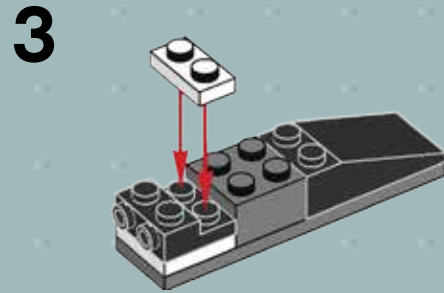
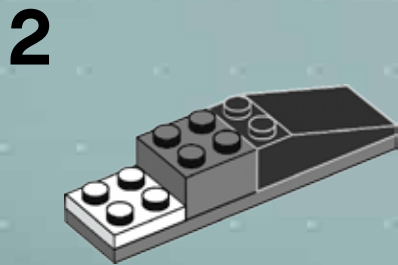
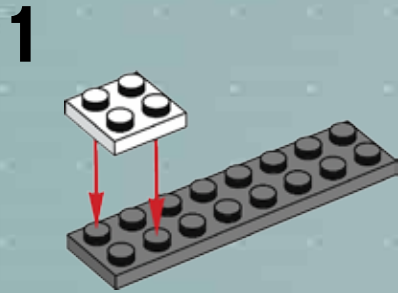

2x

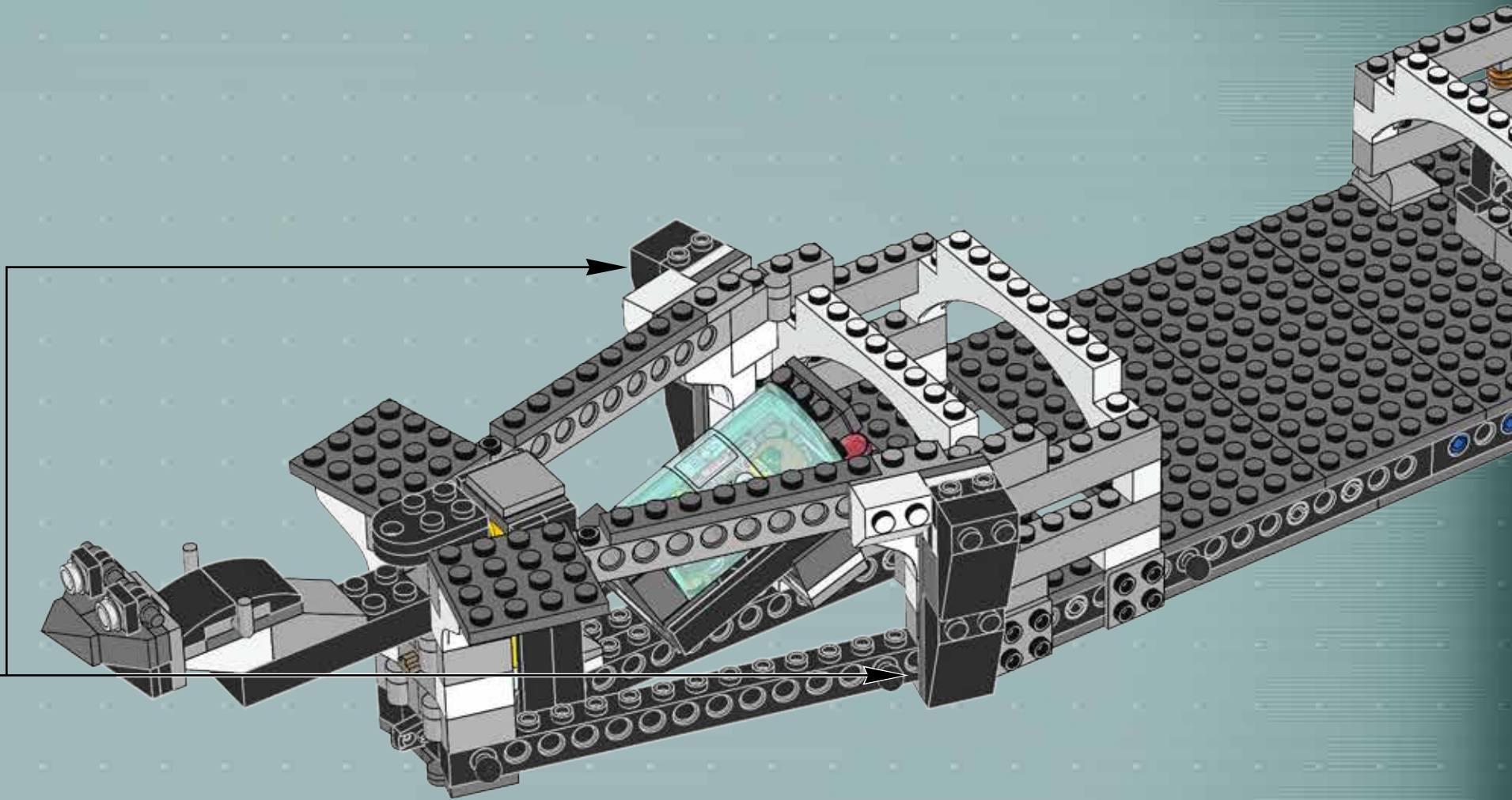

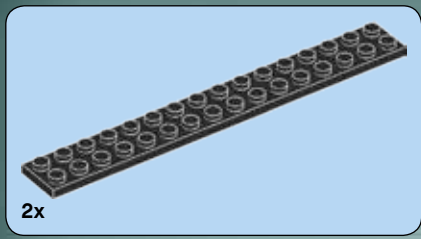

39

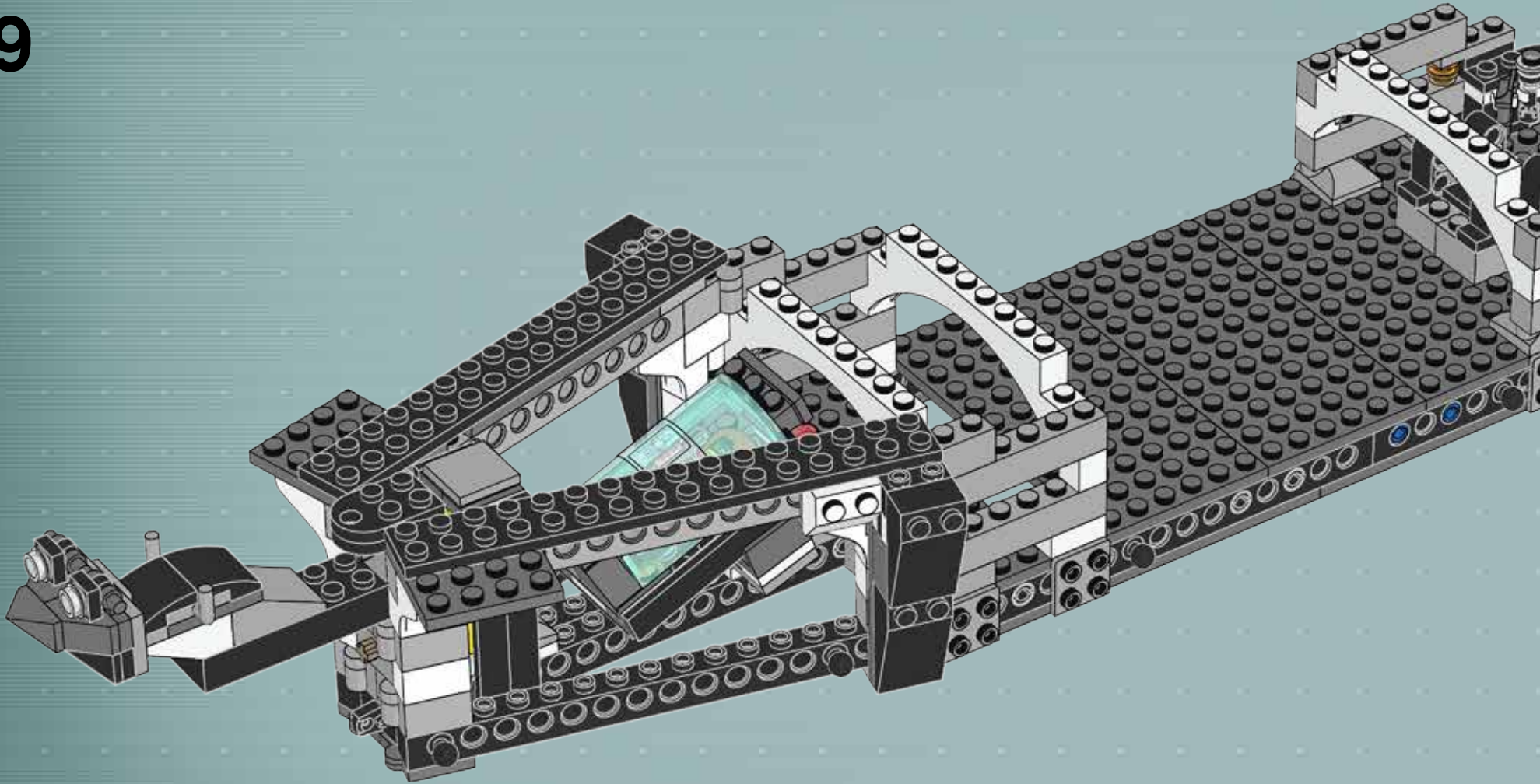





2x

# 40

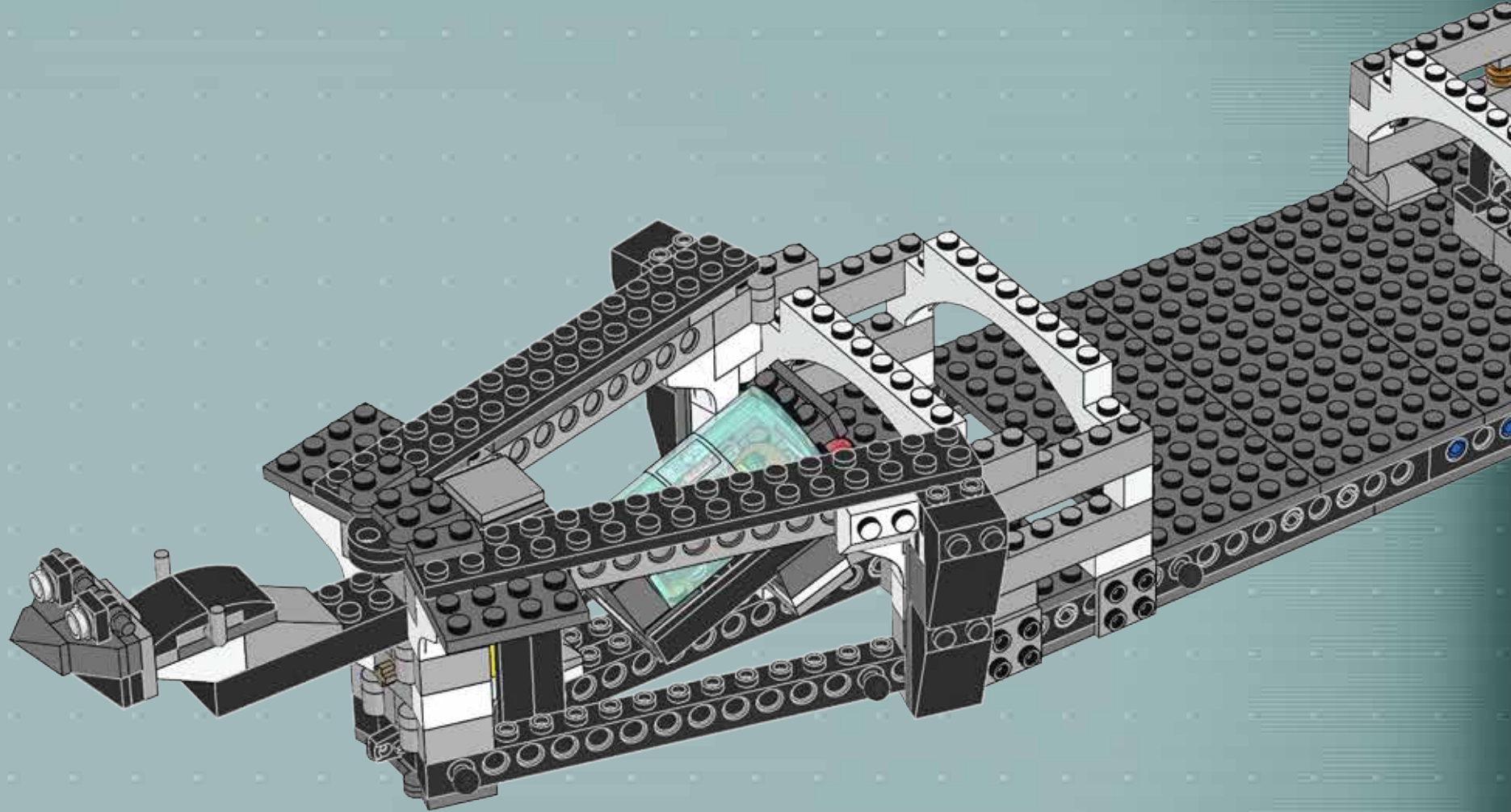

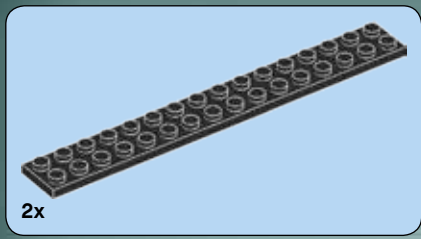

41

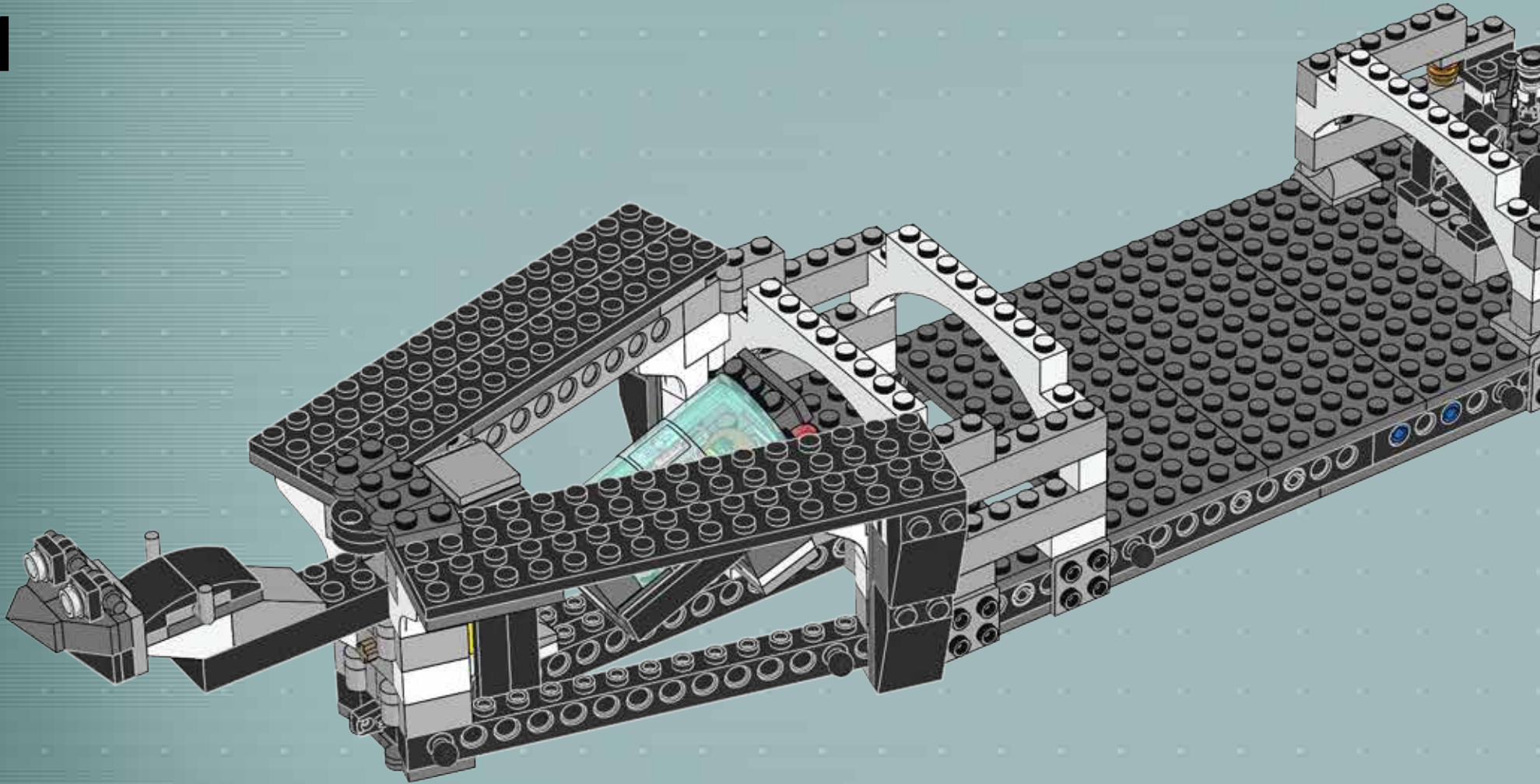

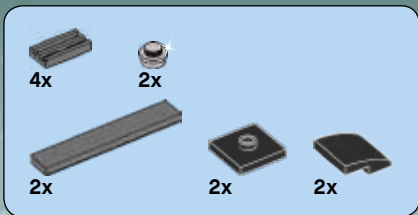

42

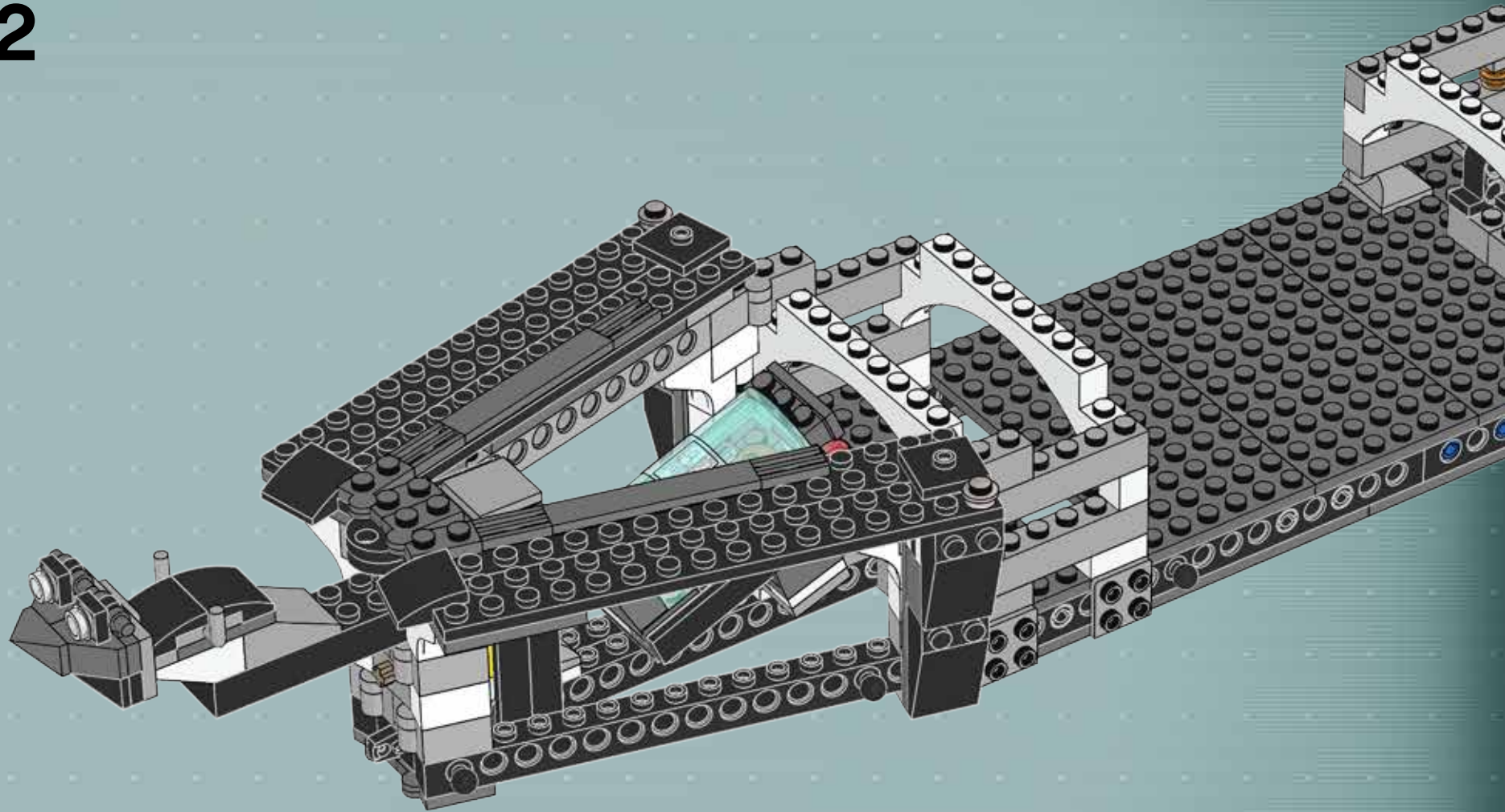

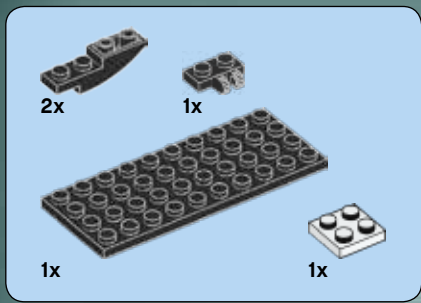

43

1

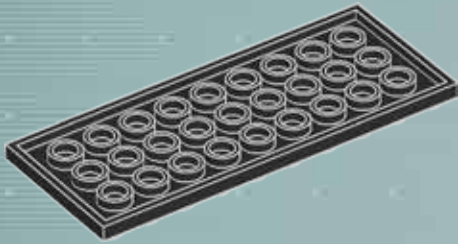

2

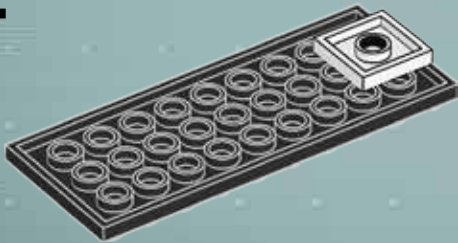

3

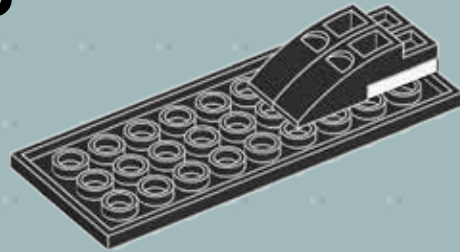

4

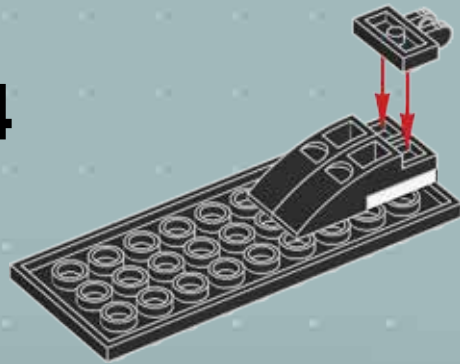

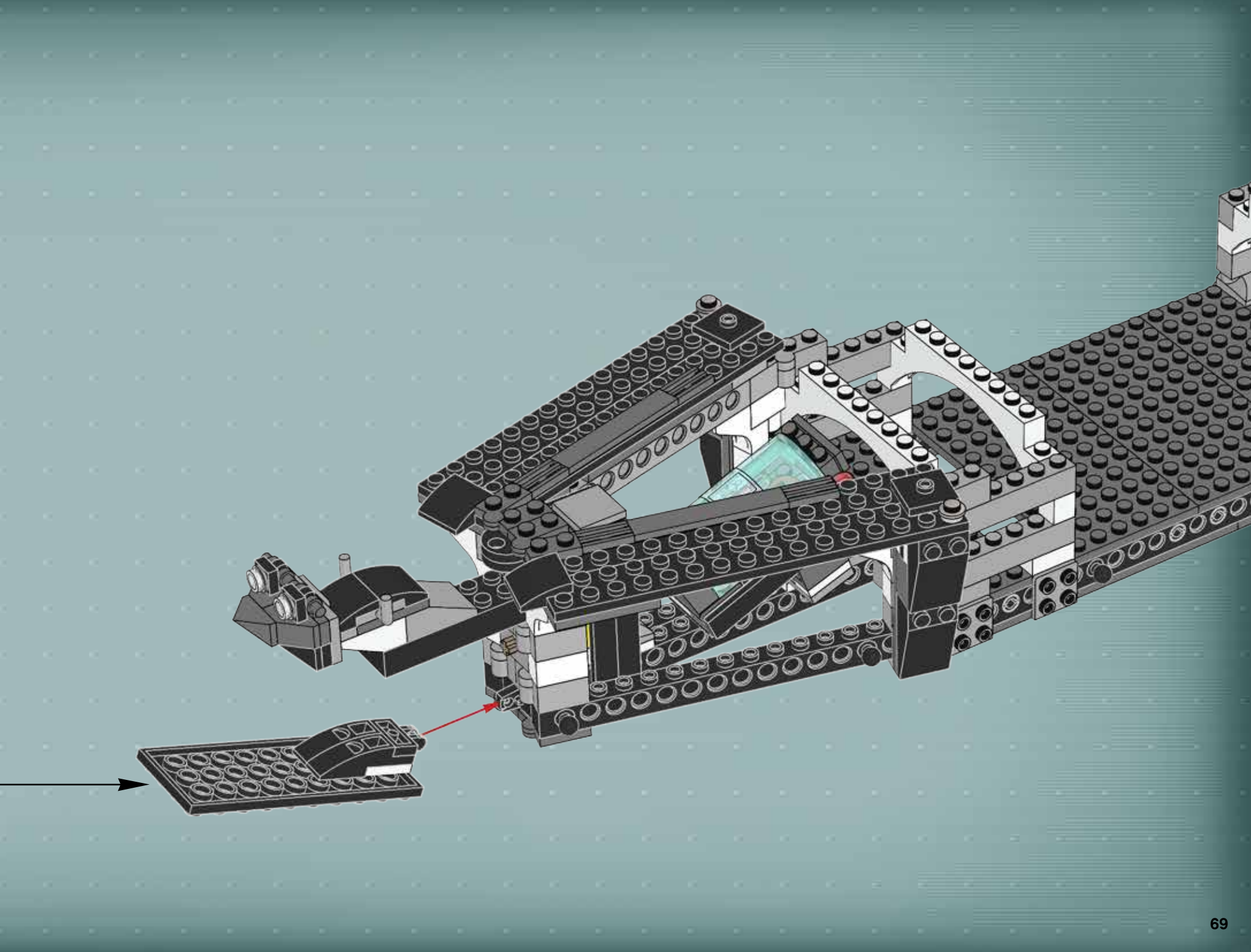

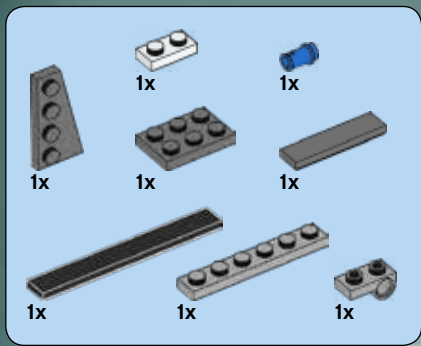

44

1

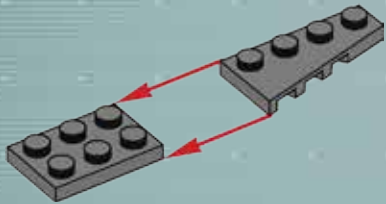

2

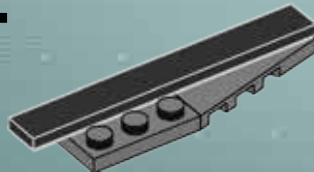

3

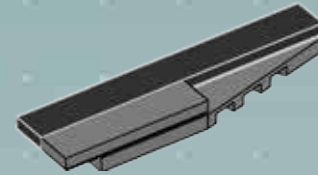

4

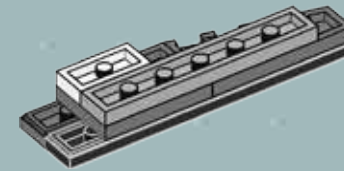
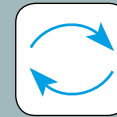

5

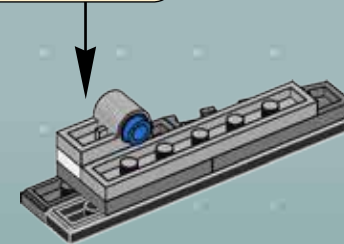
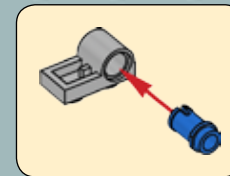

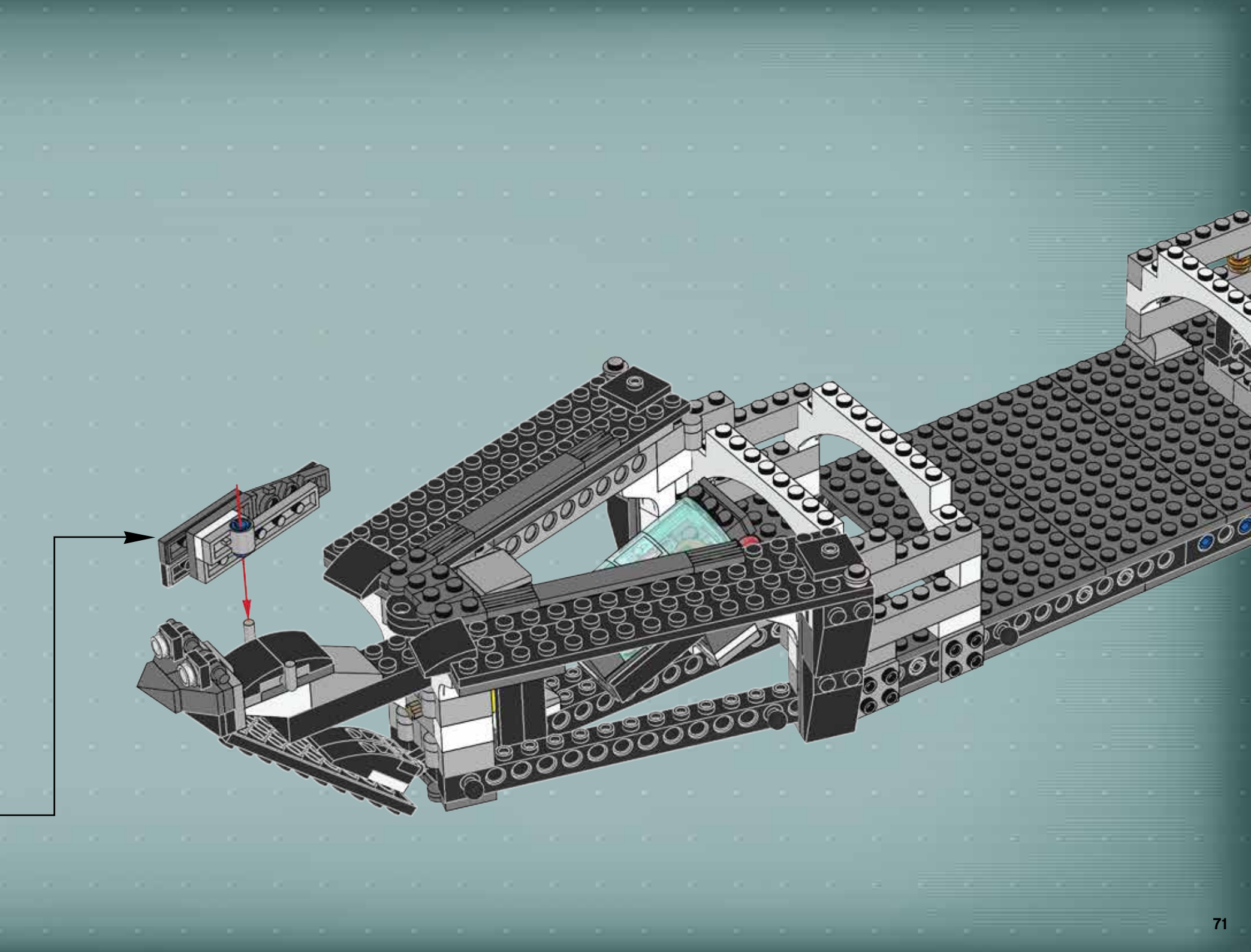





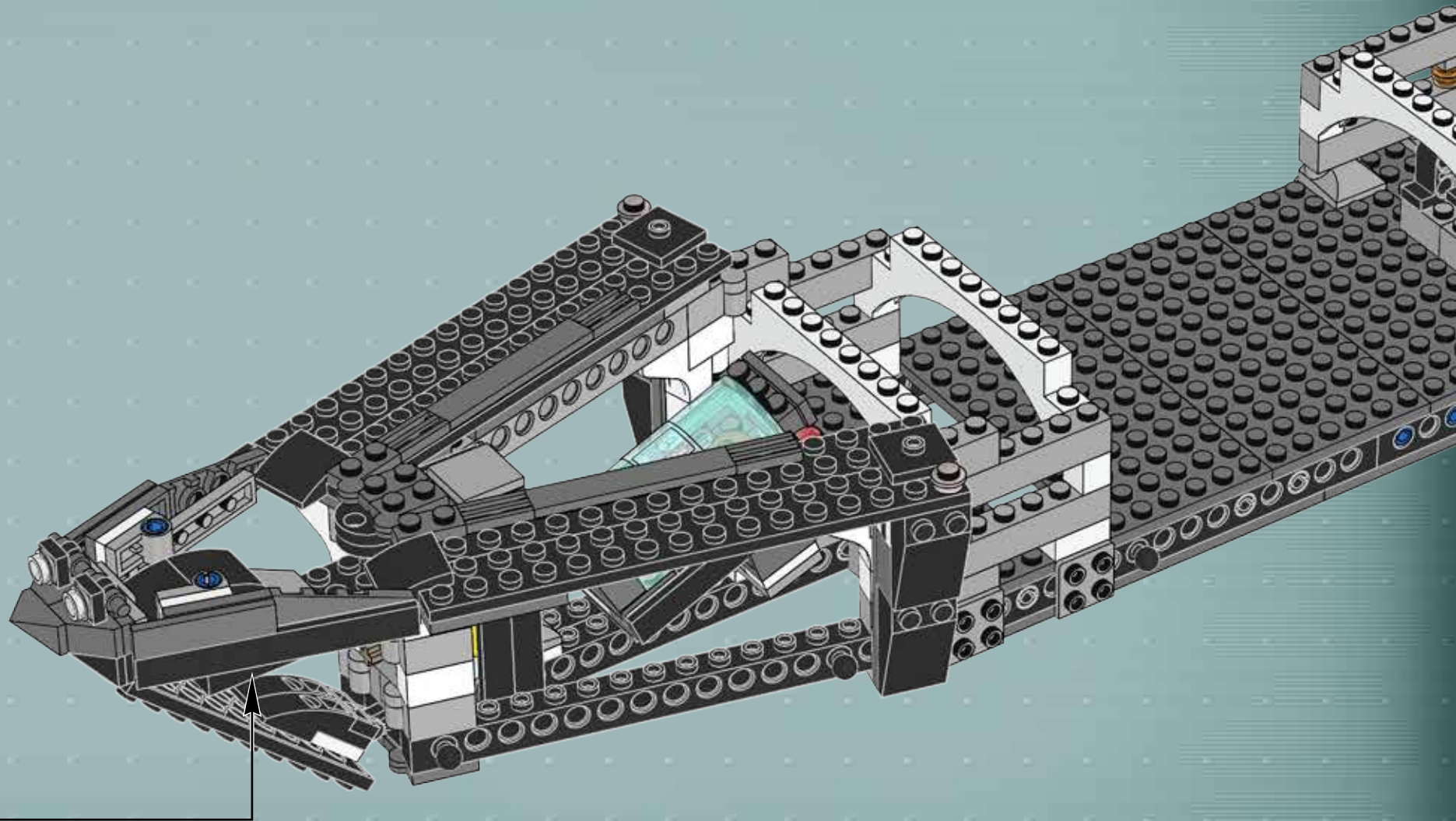

1x

1x

1x

8x

# 46

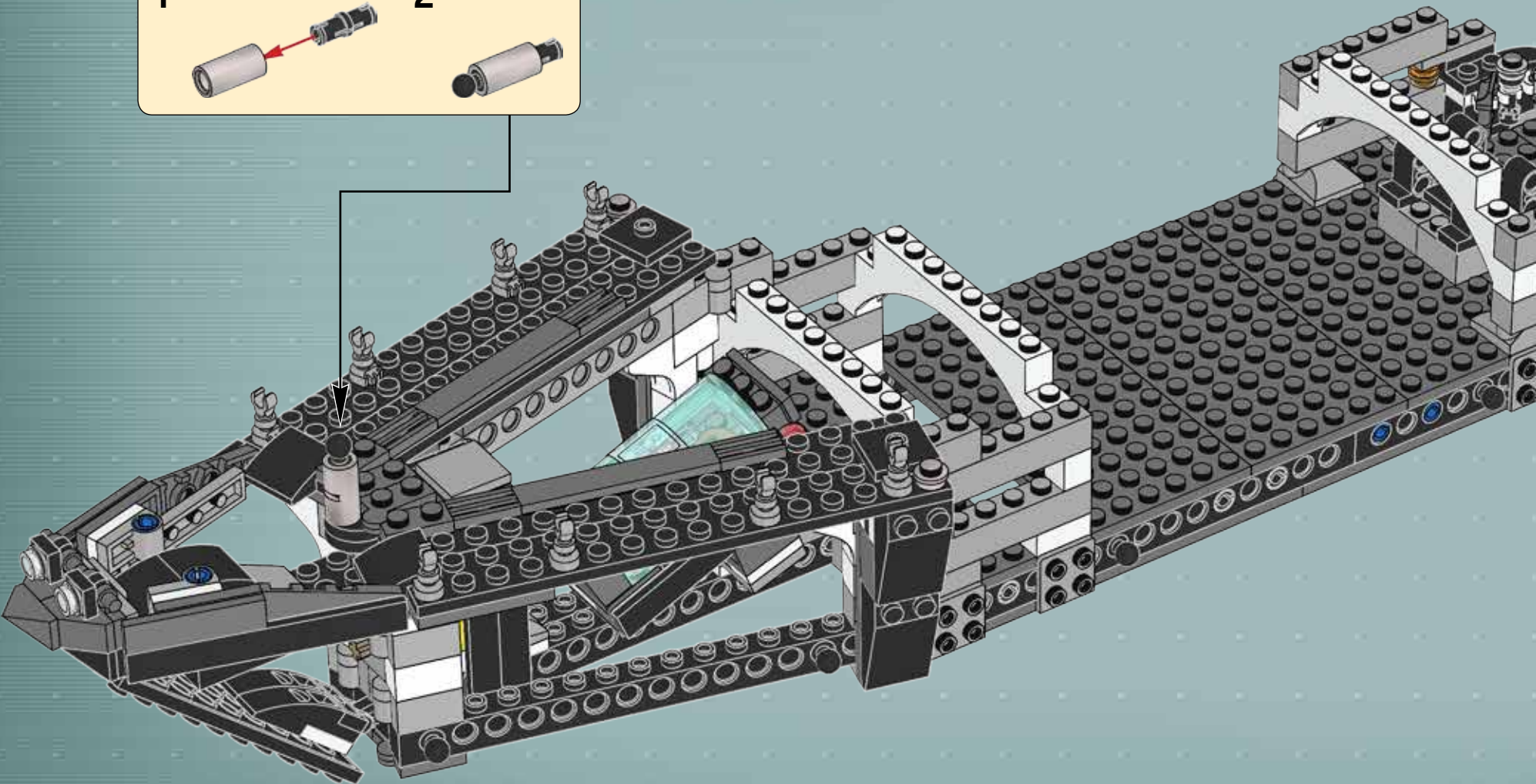
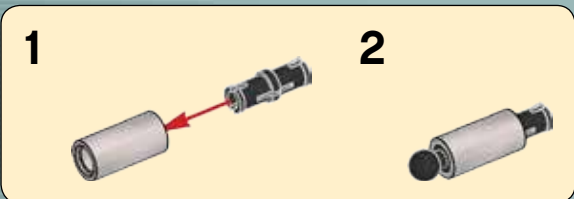

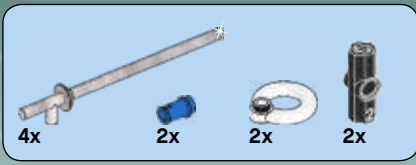

47

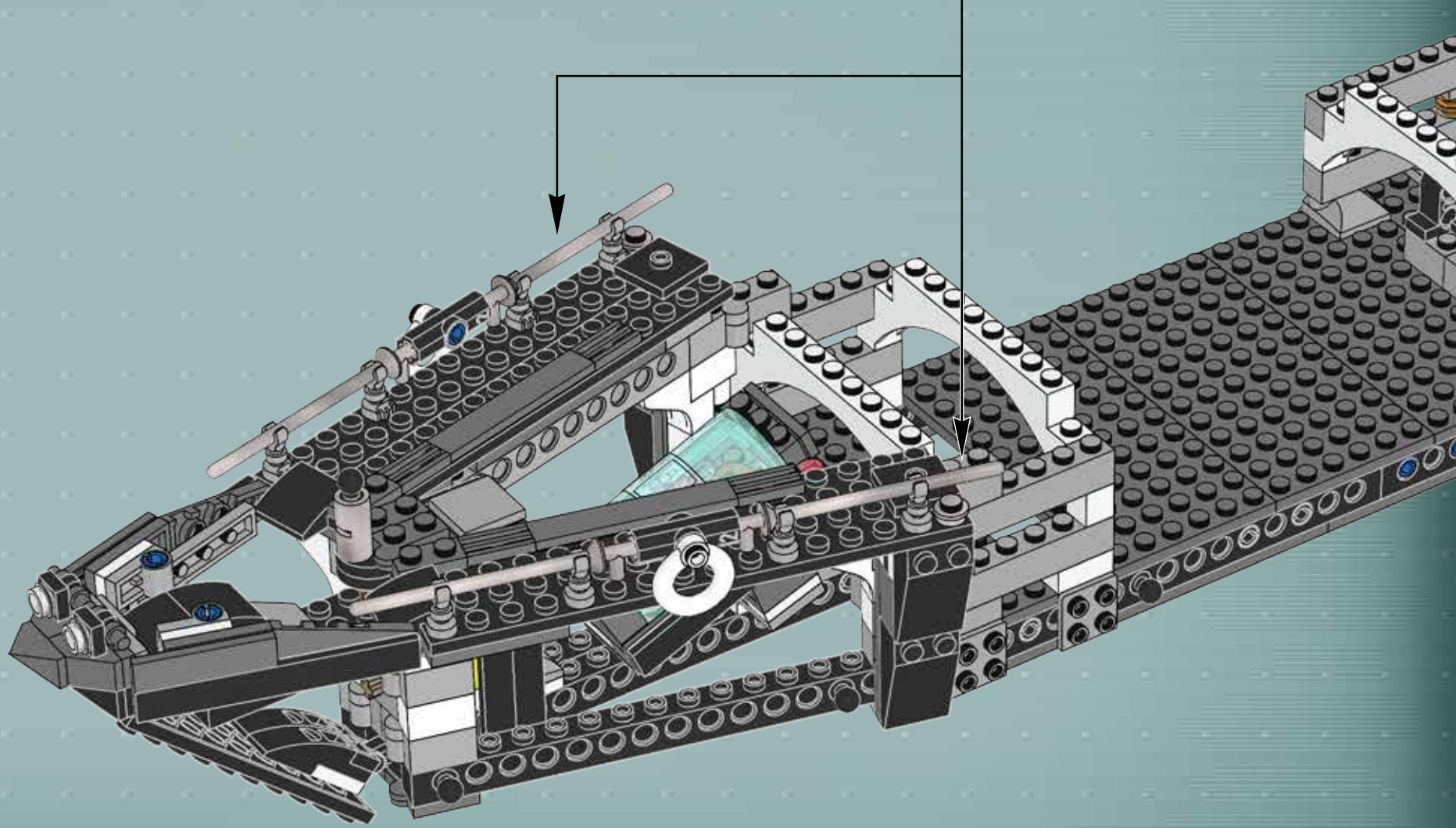
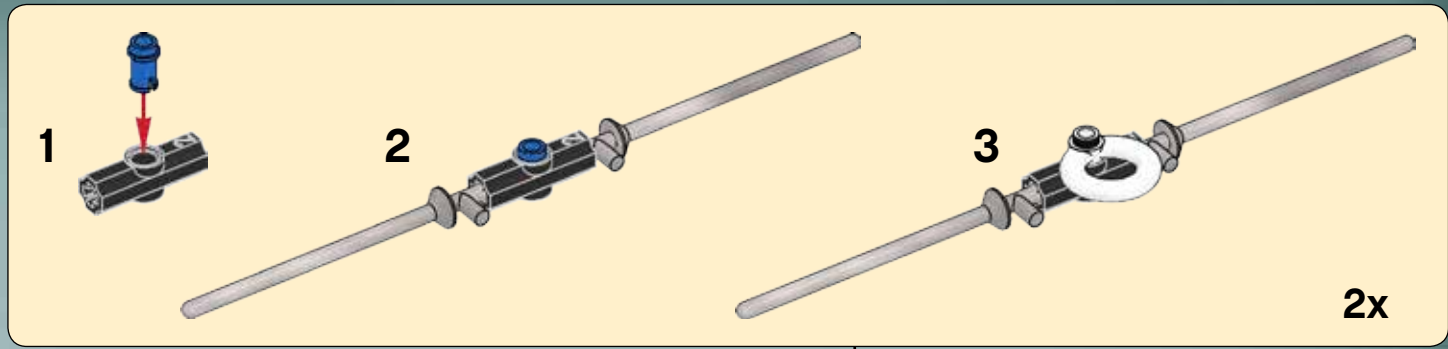

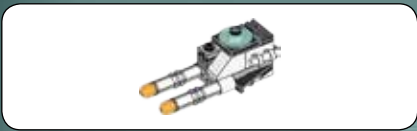

1

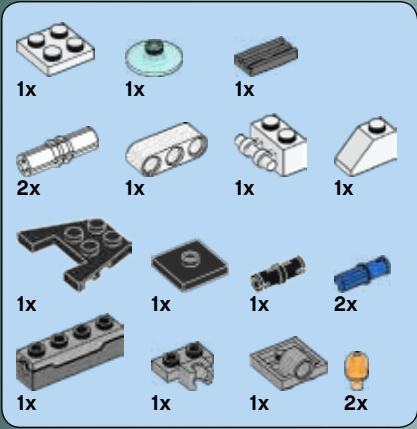
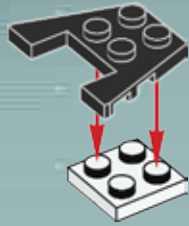

2



3

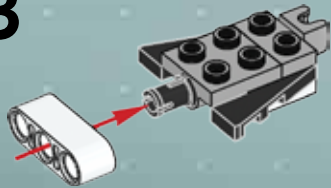

4

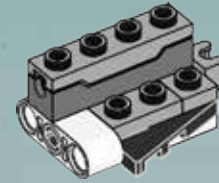

5

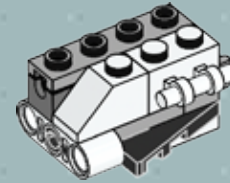

6

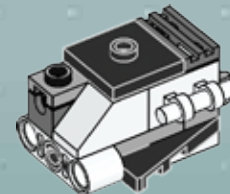

48

7

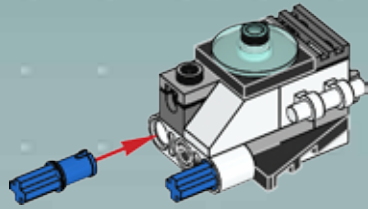

8

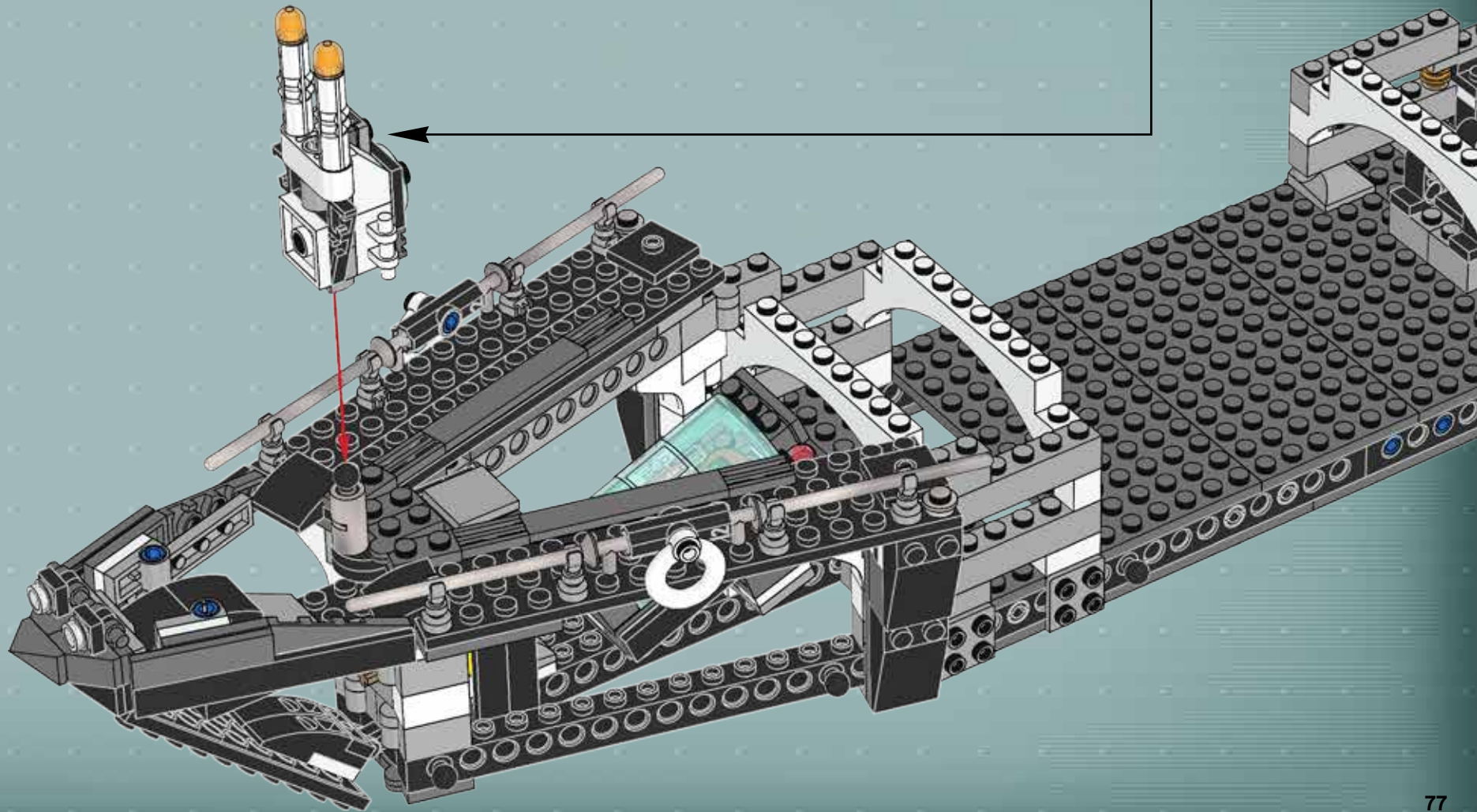
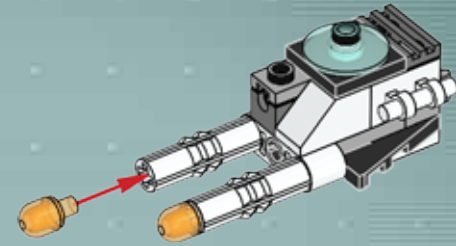

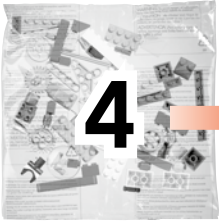

4

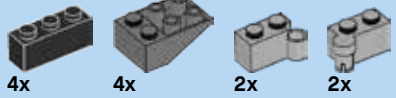
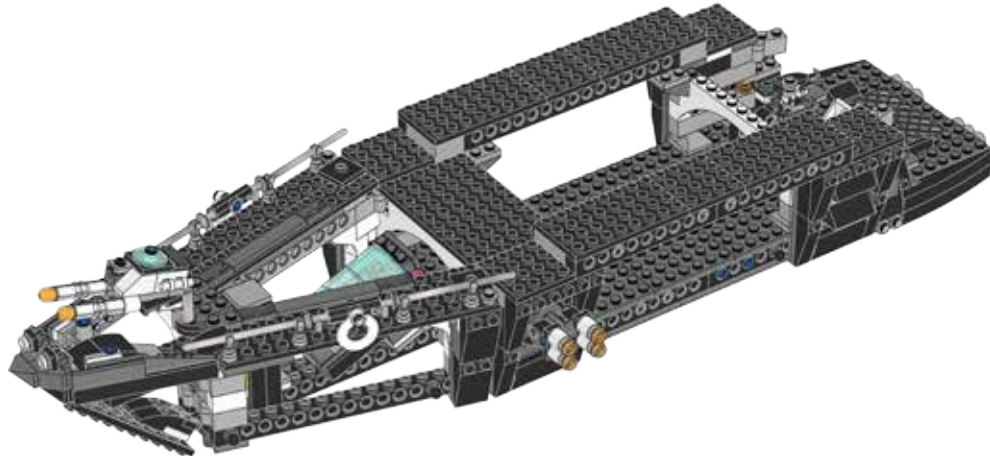

4x

4x

2x

2x

49

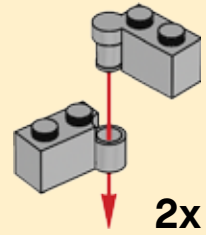

2x

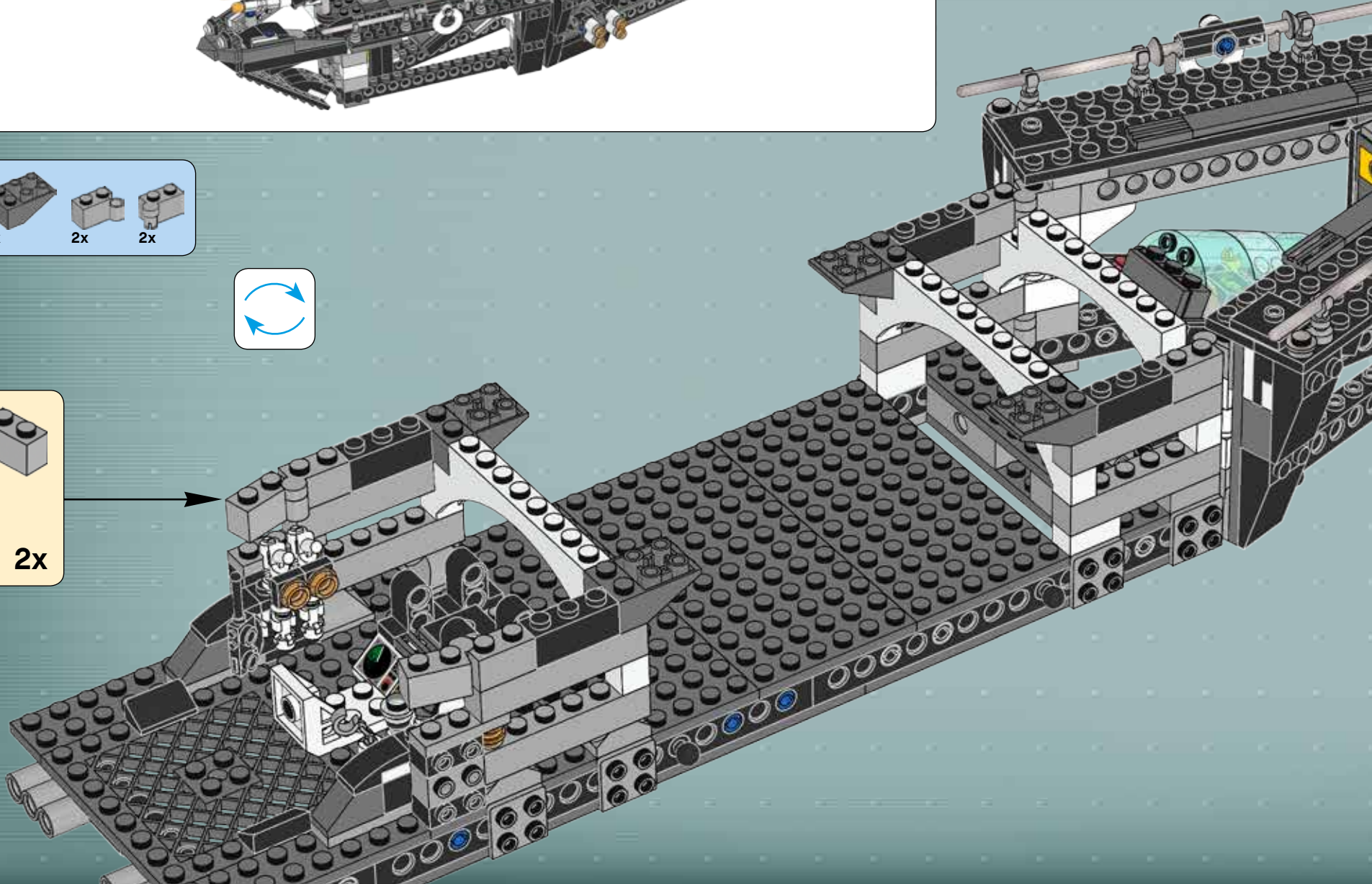



4x



8x

# 50

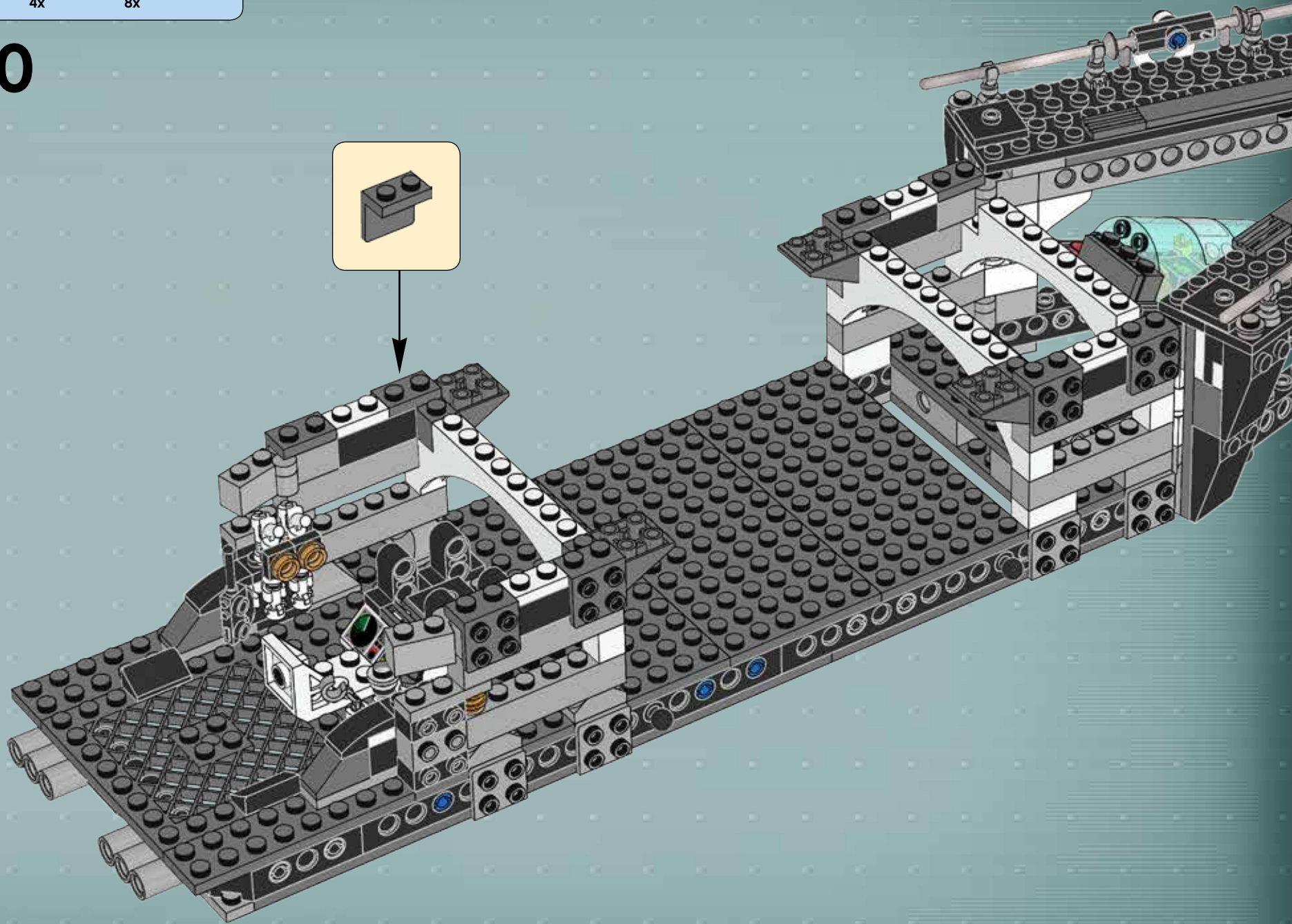
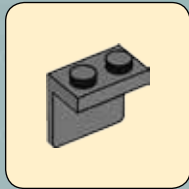



2x

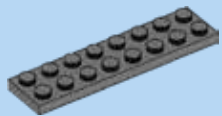

2x

1

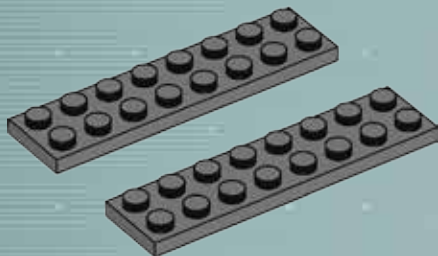

1x

2

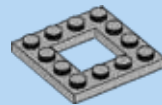
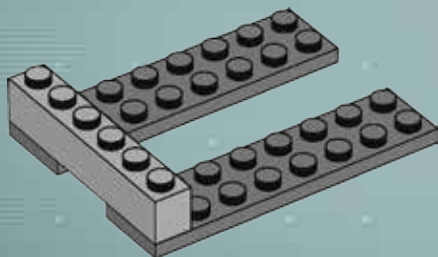

1x

3

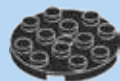
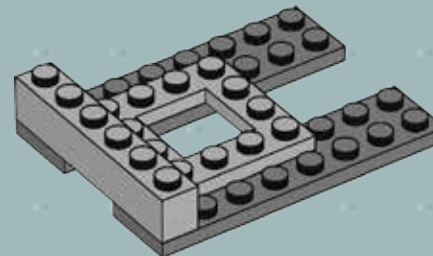

1x

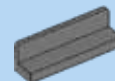

1x

4

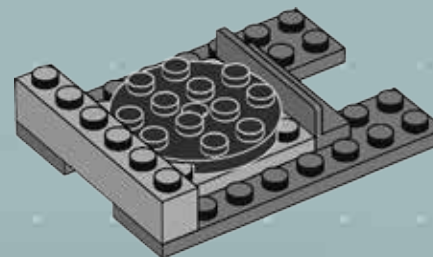





5

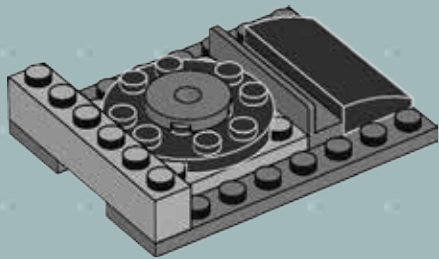

6

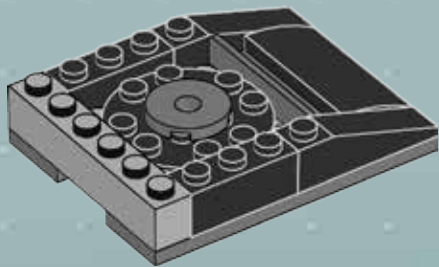

7

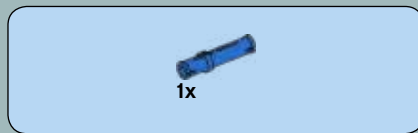
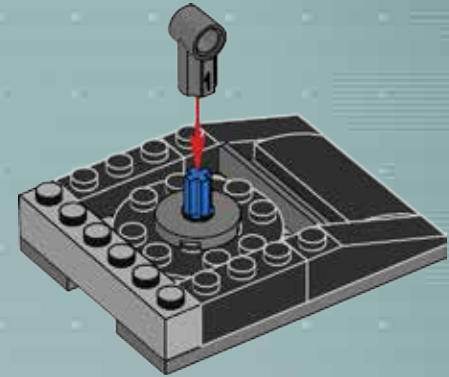

8

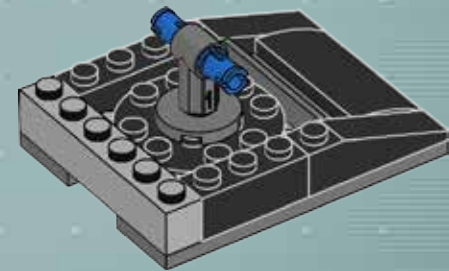

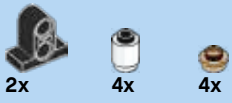

9

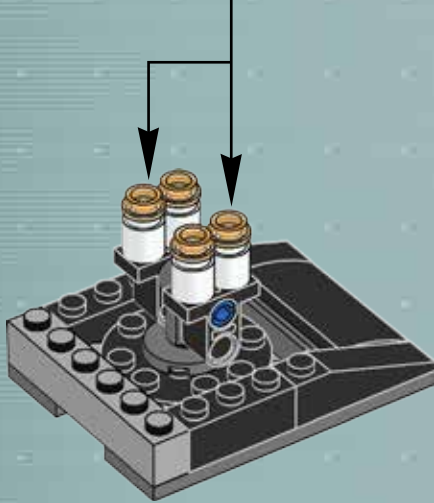
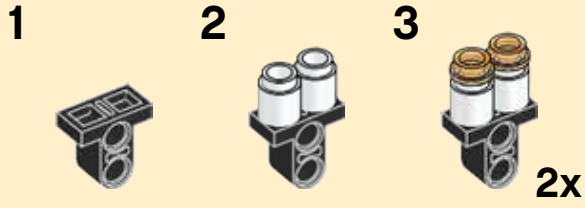

10

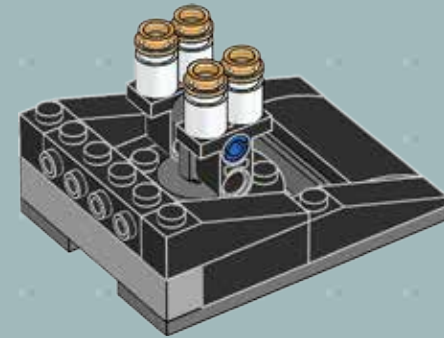

2x

51

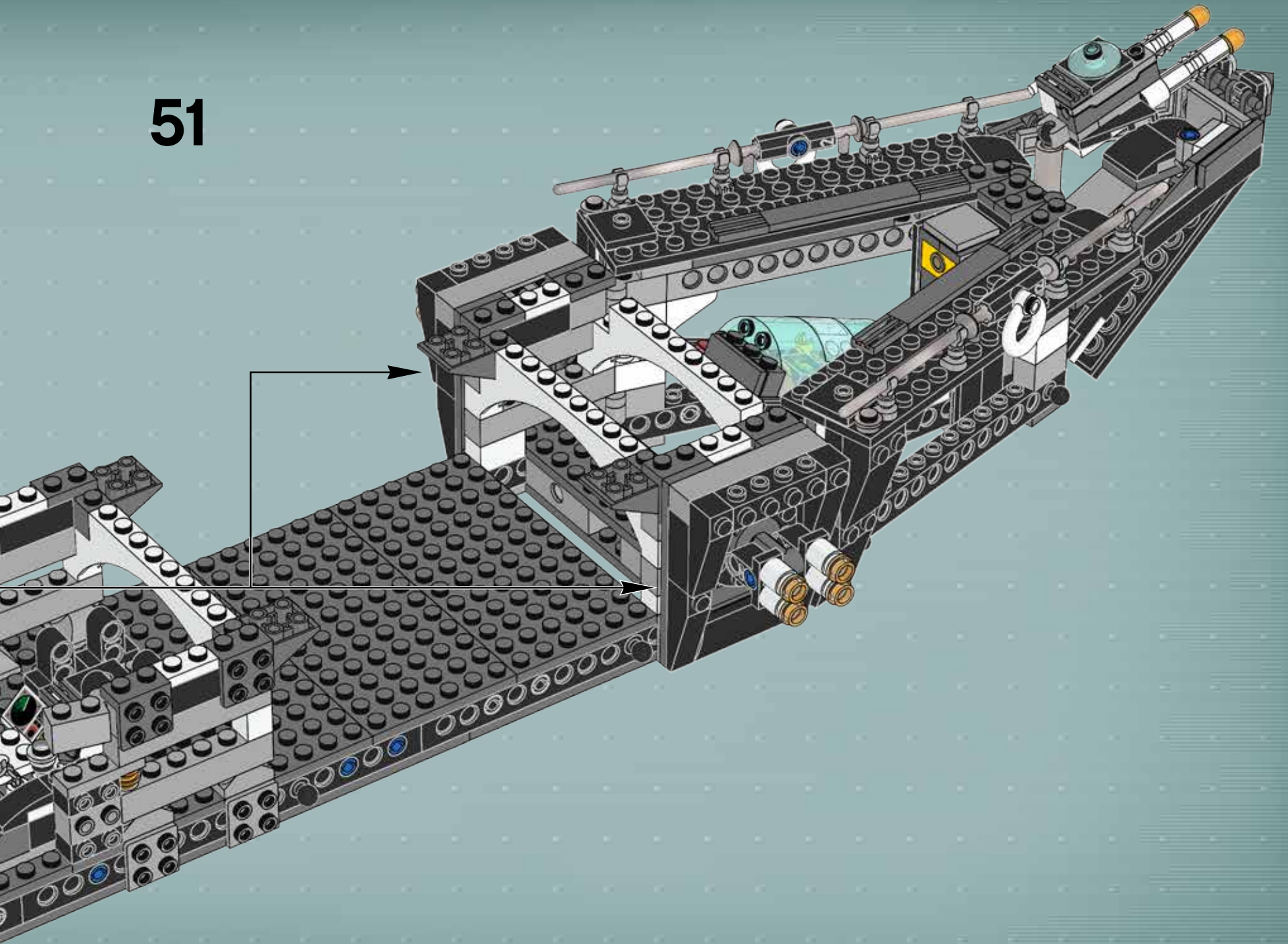

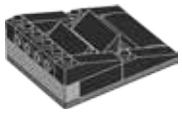

2x



1x

1



1x

2



4x

3

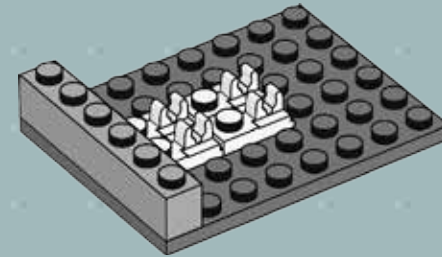

2x

4



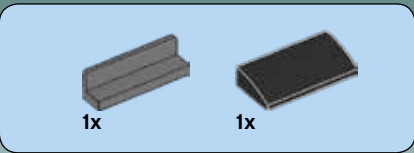

5

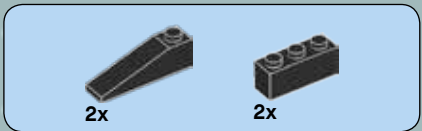
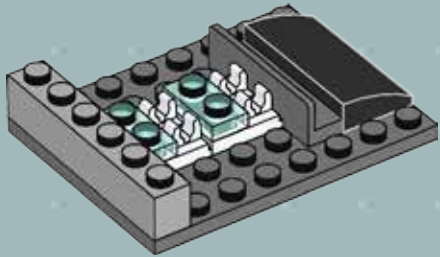

6

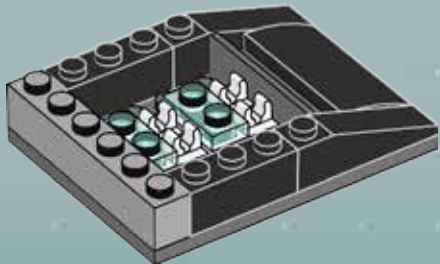

7

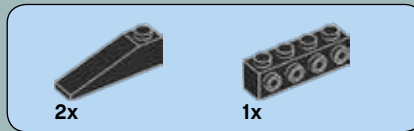
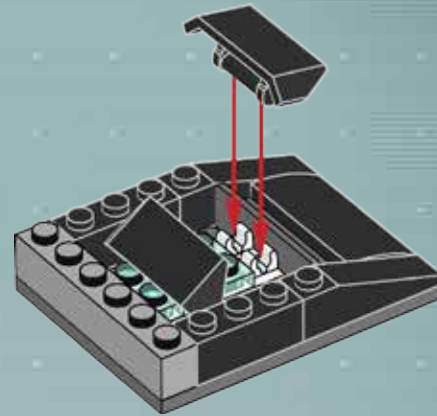

8

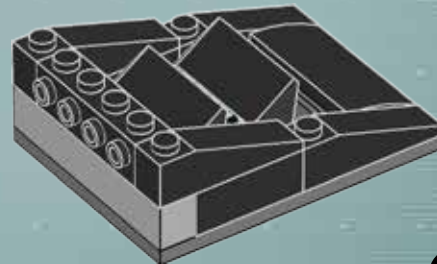

2x

52

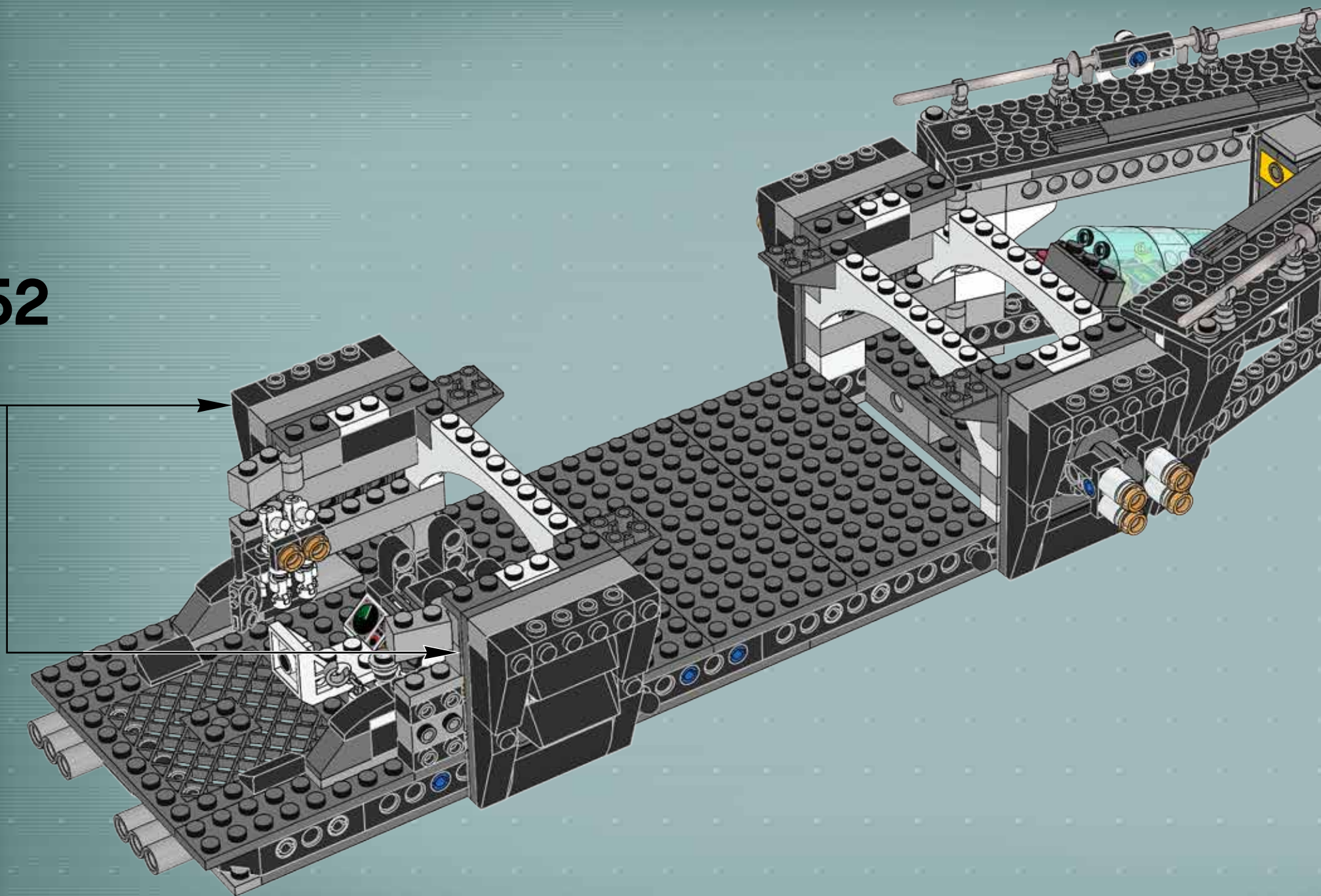

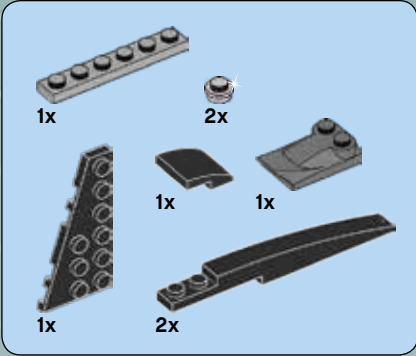

**53**

**1**



**2**

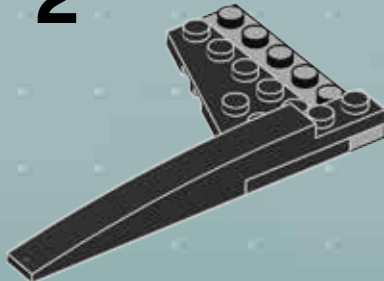

**3**

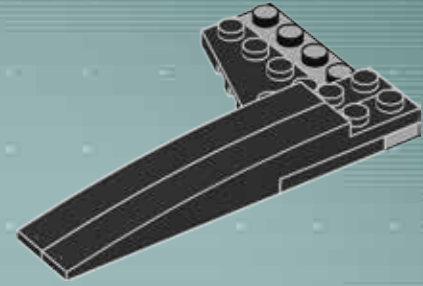

**4**

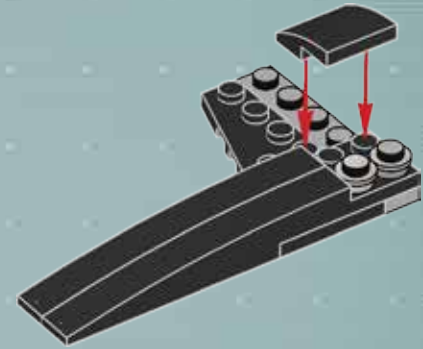

**5**

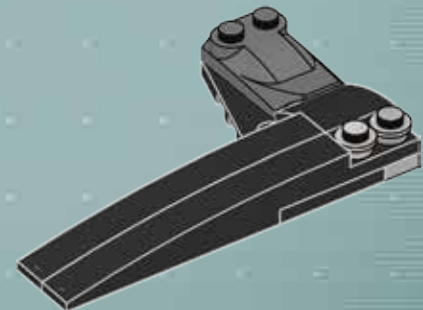

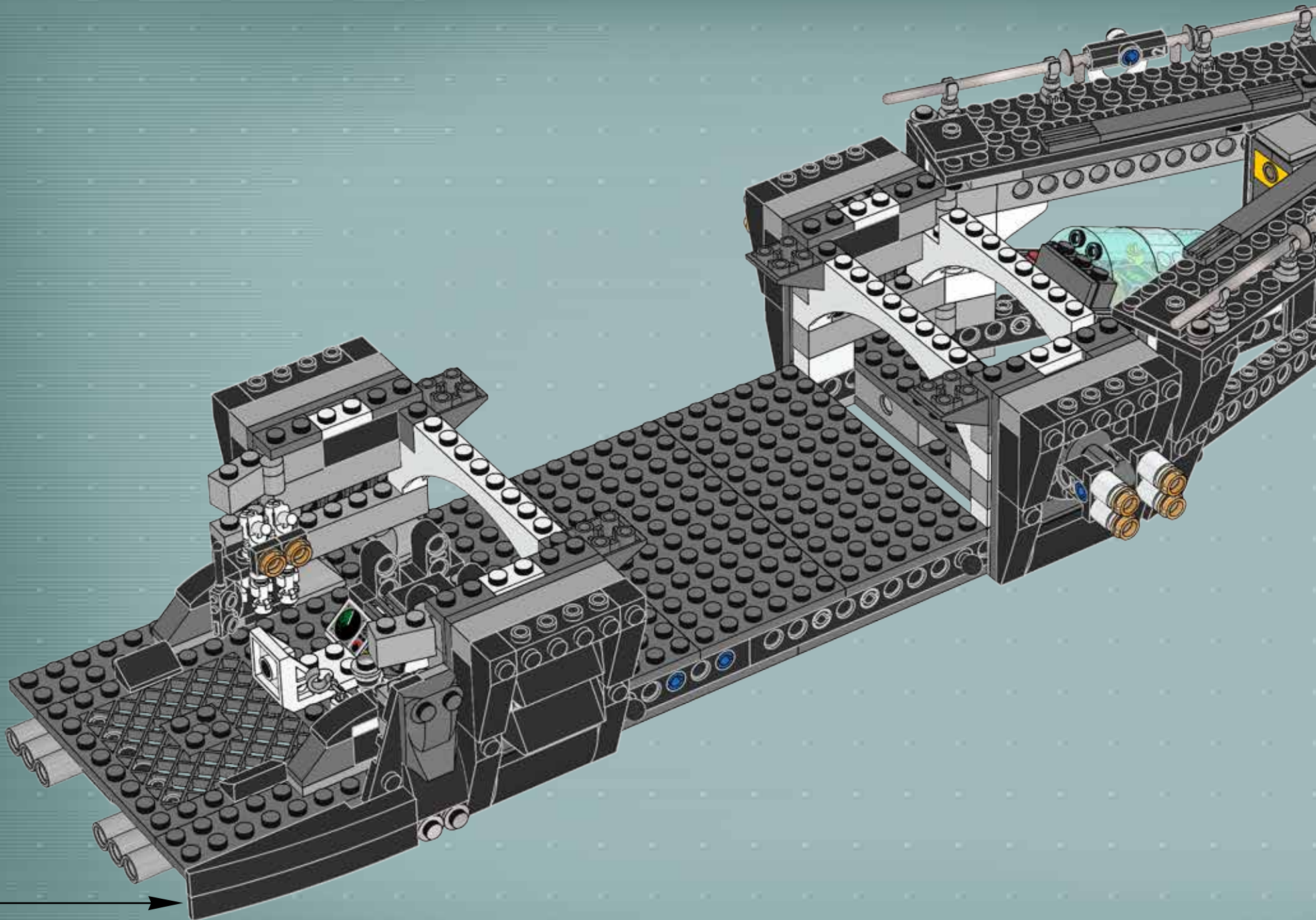



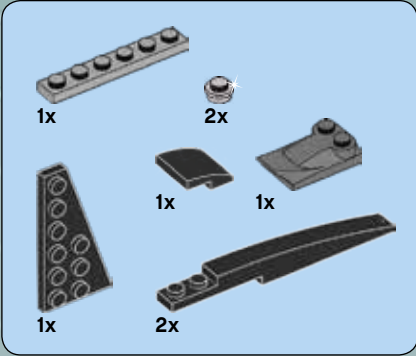

54

1

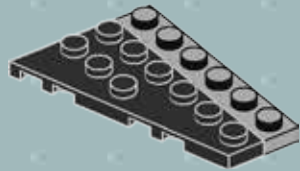

2

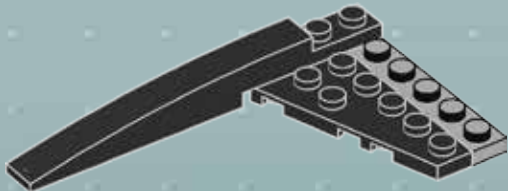

3

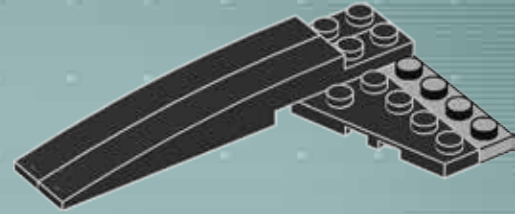

4

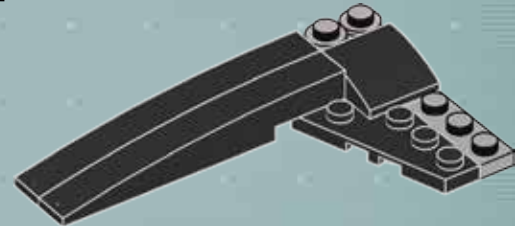

5

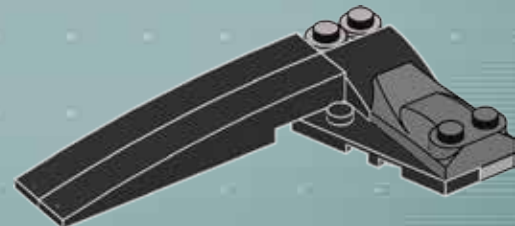

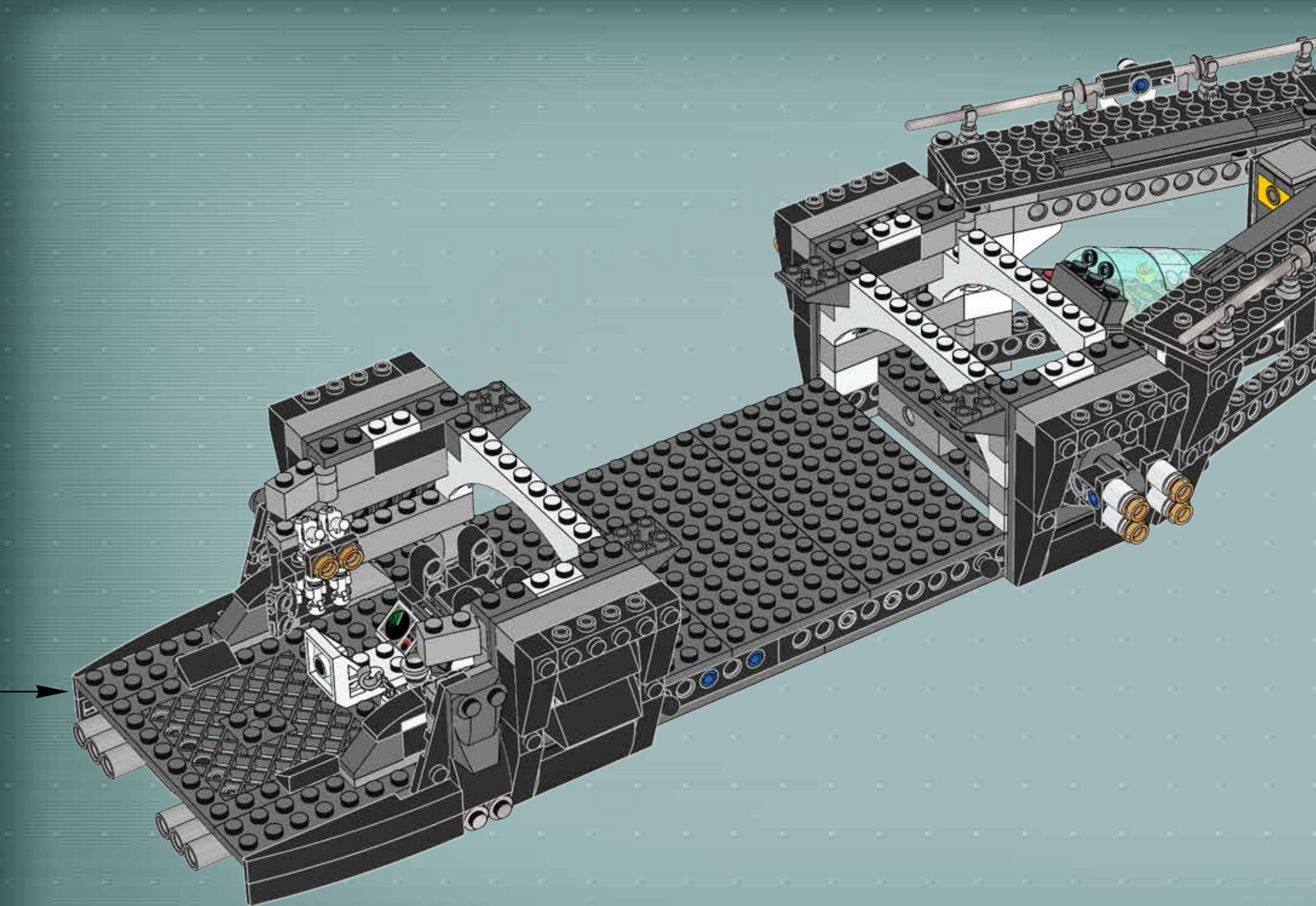

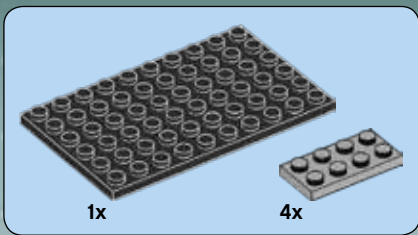

55

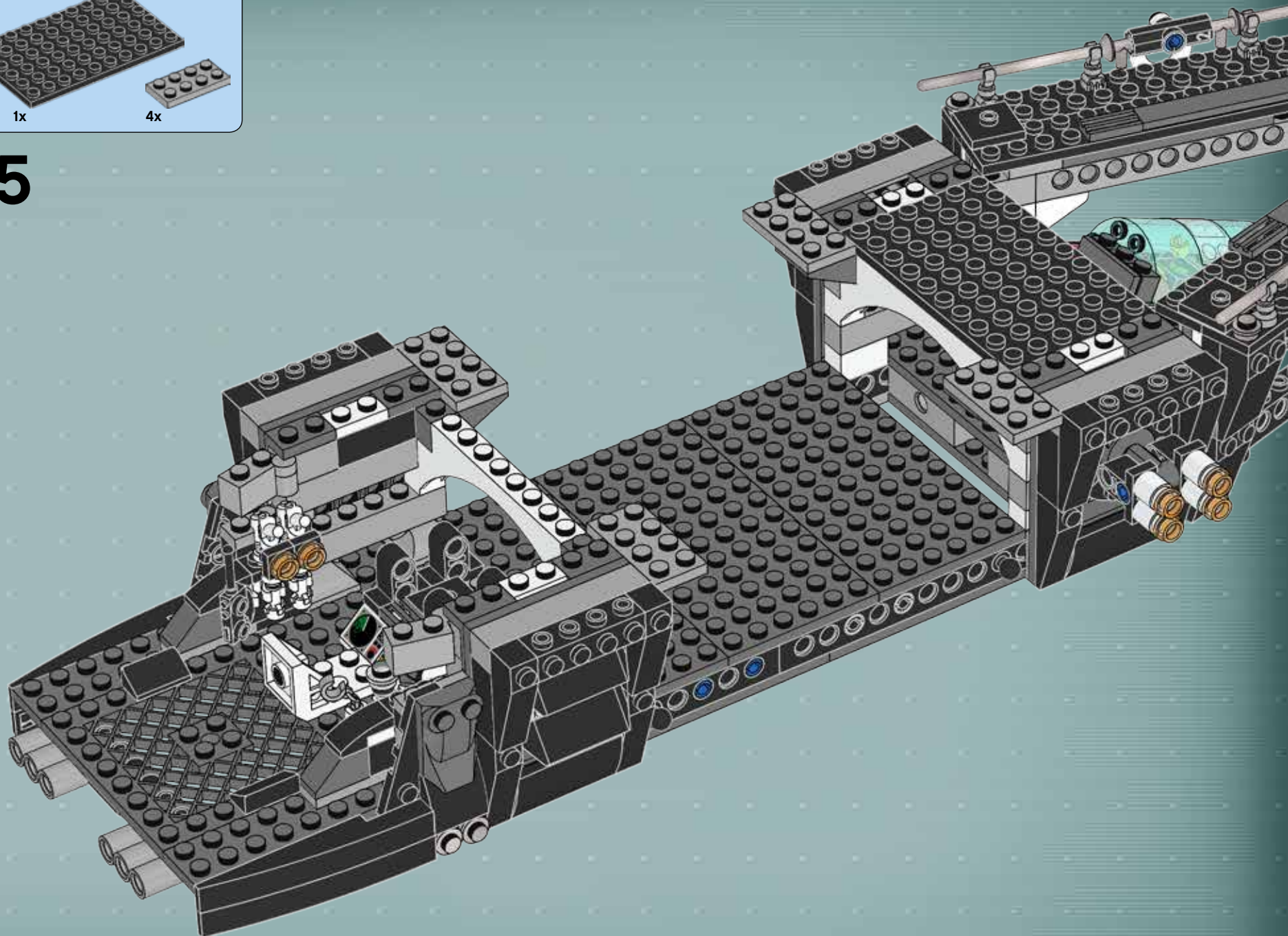

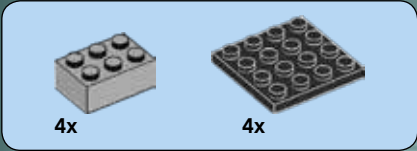

# 56

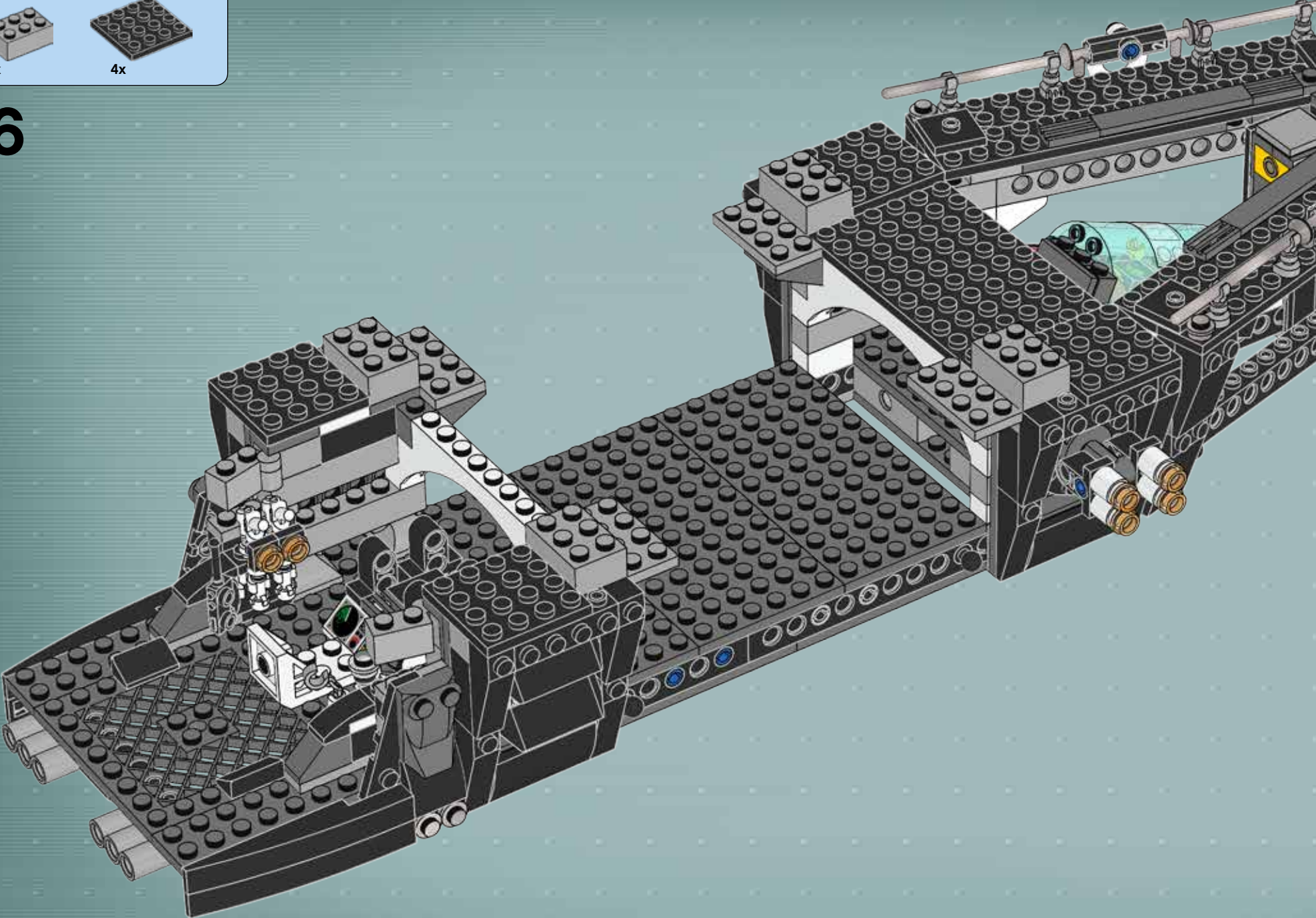

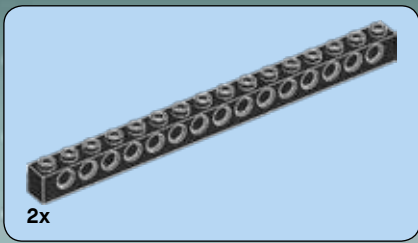

57

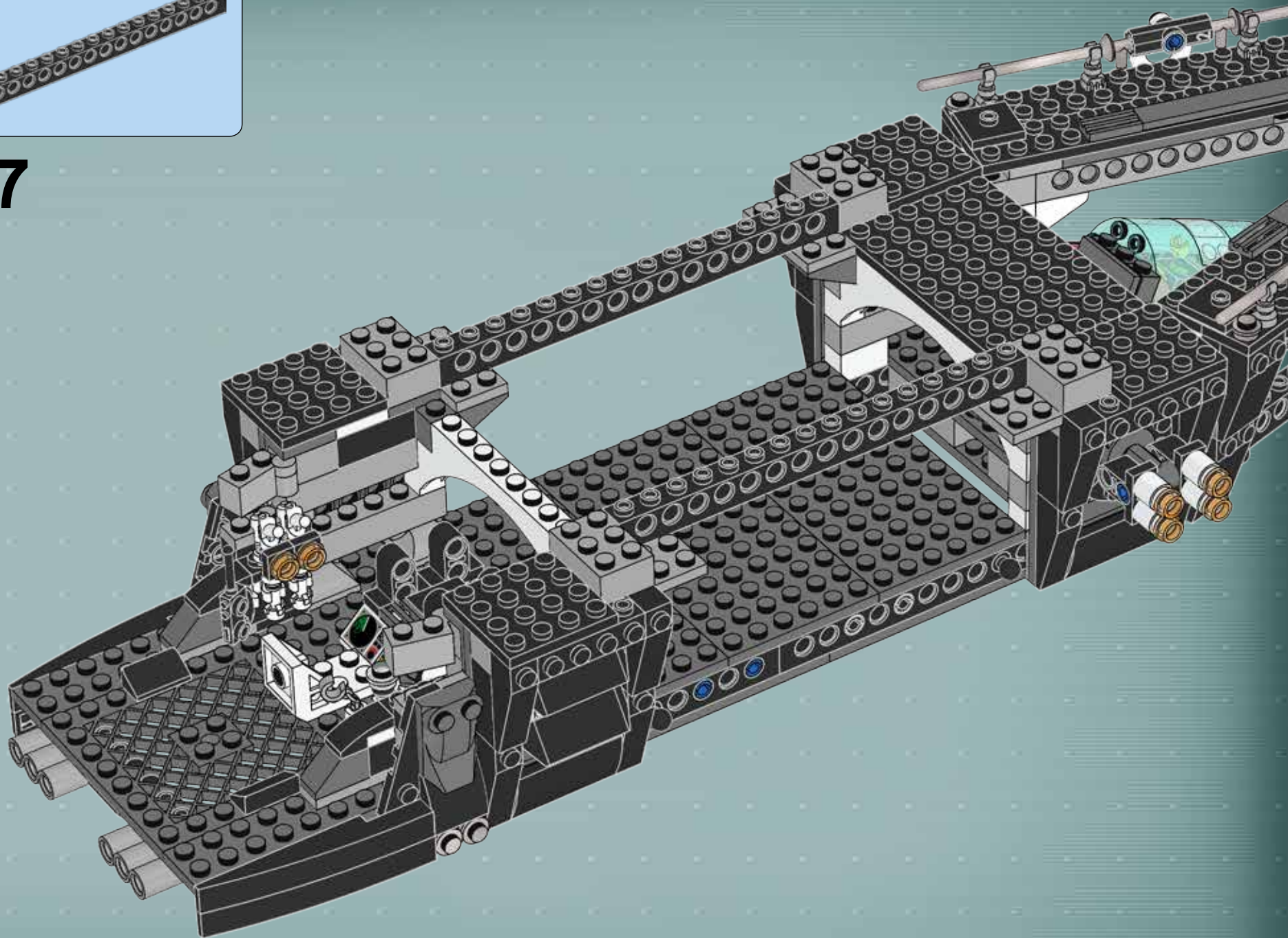

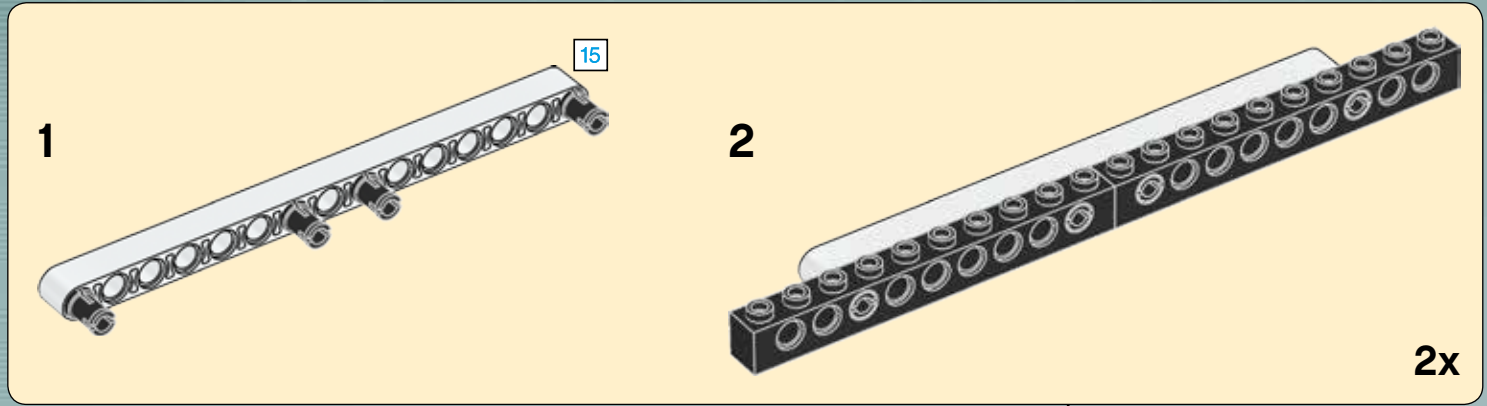
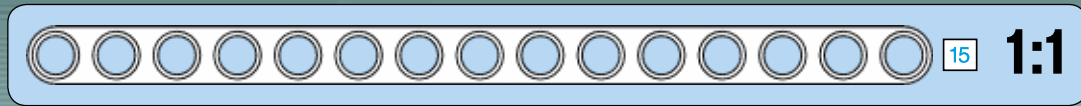
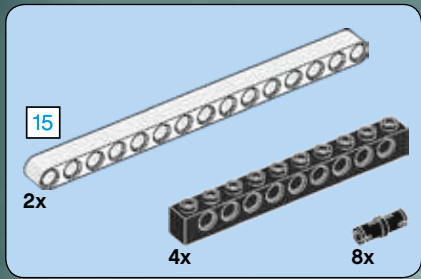

58

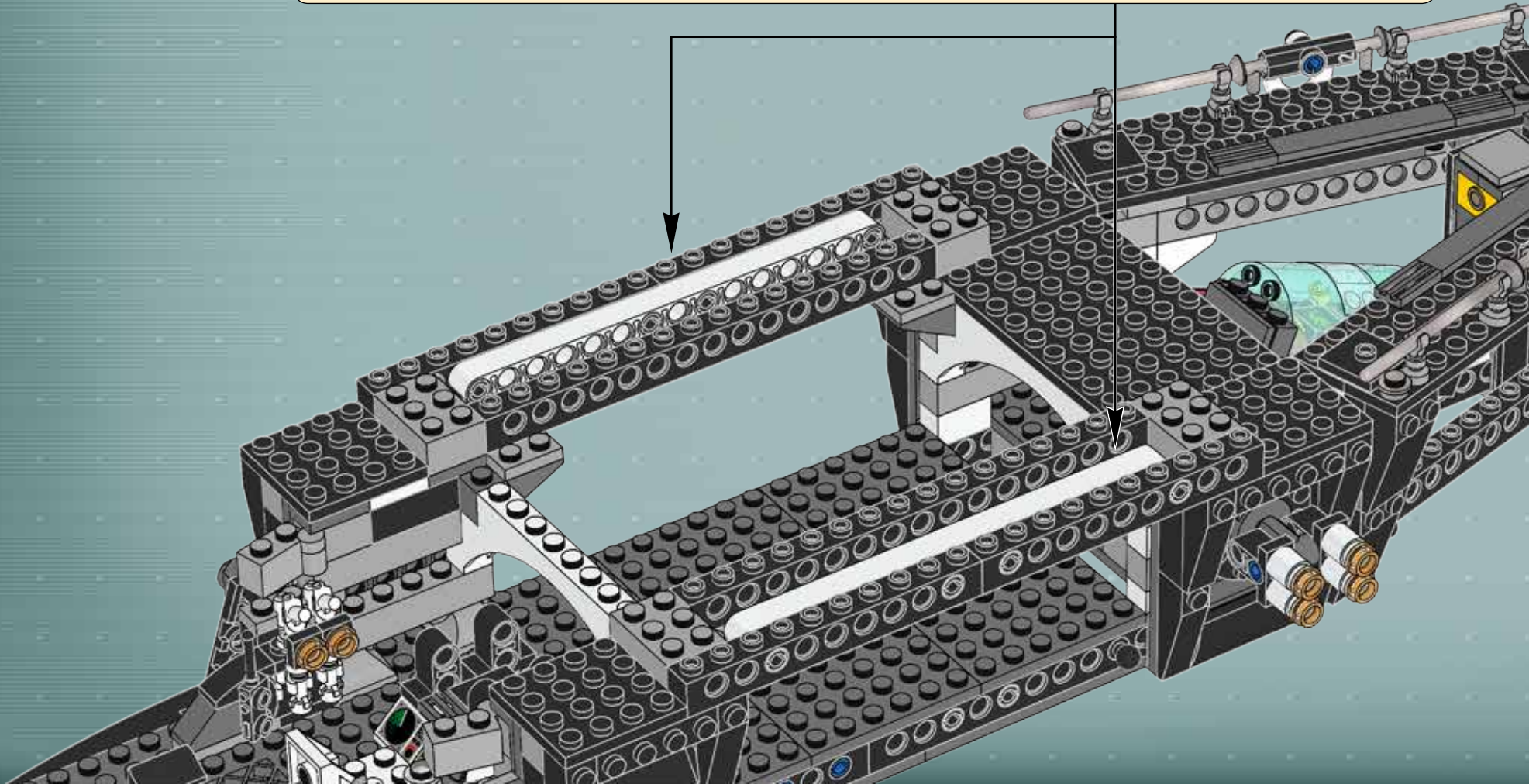

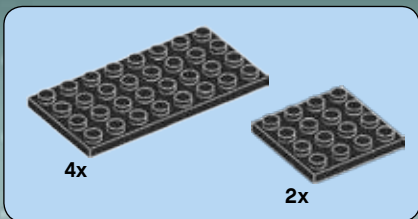

# 59

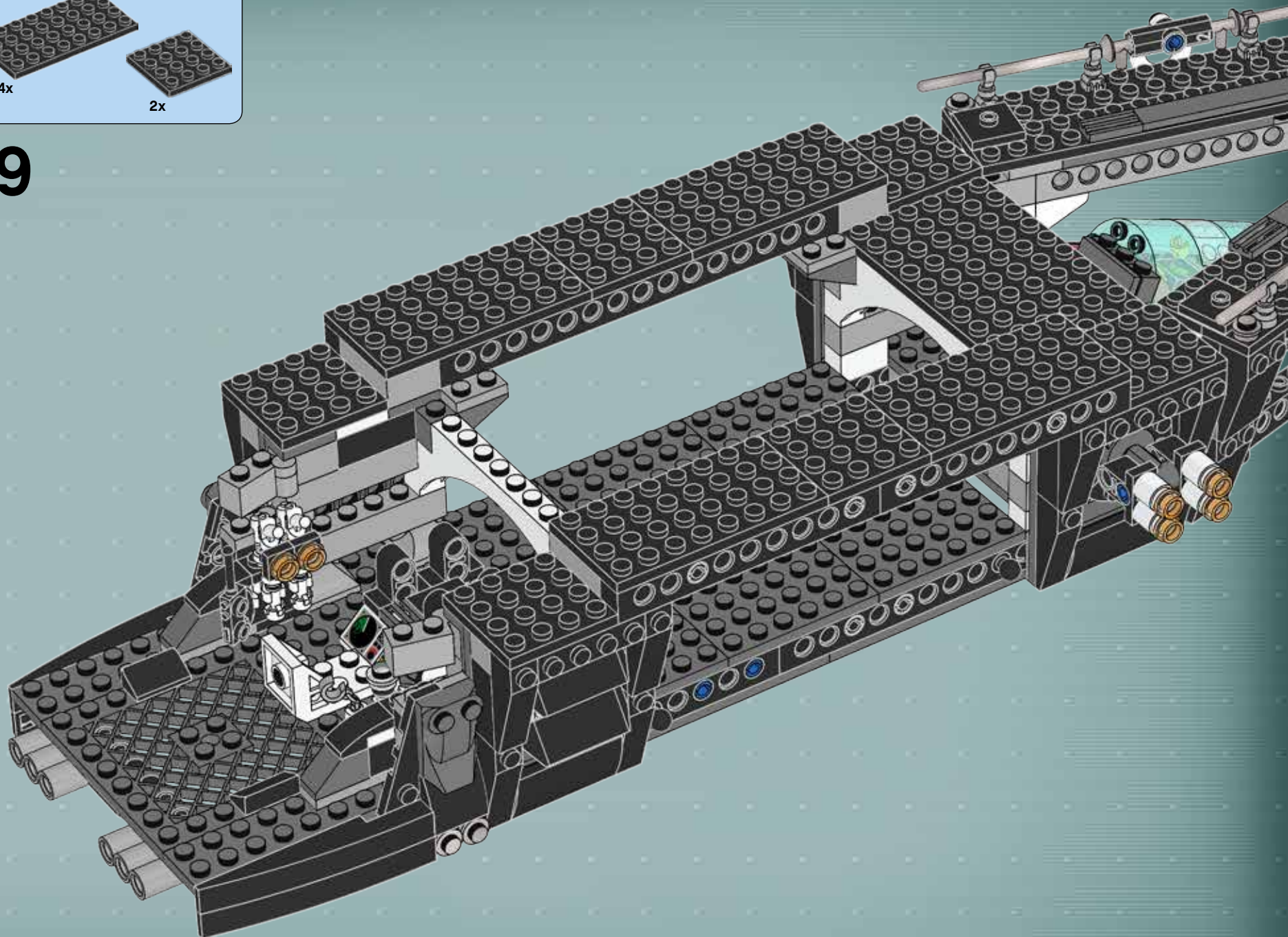

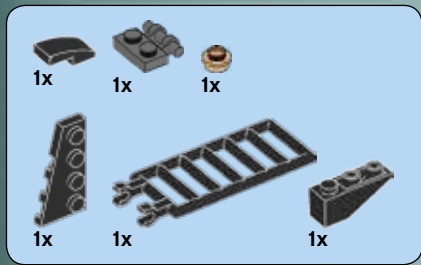
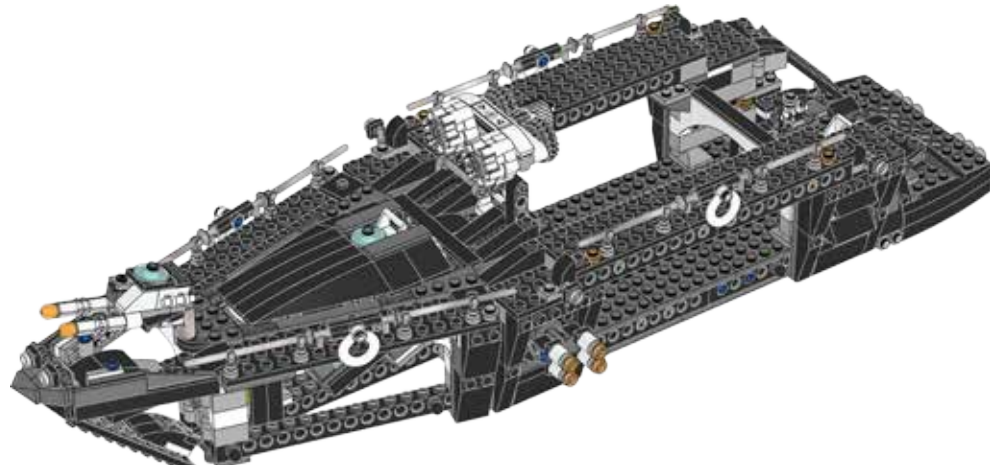

60

1

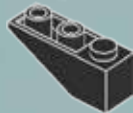

2



3

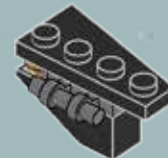

4

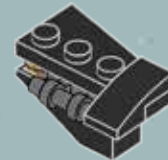

5

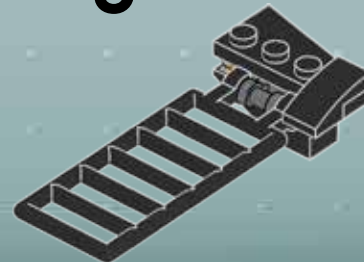



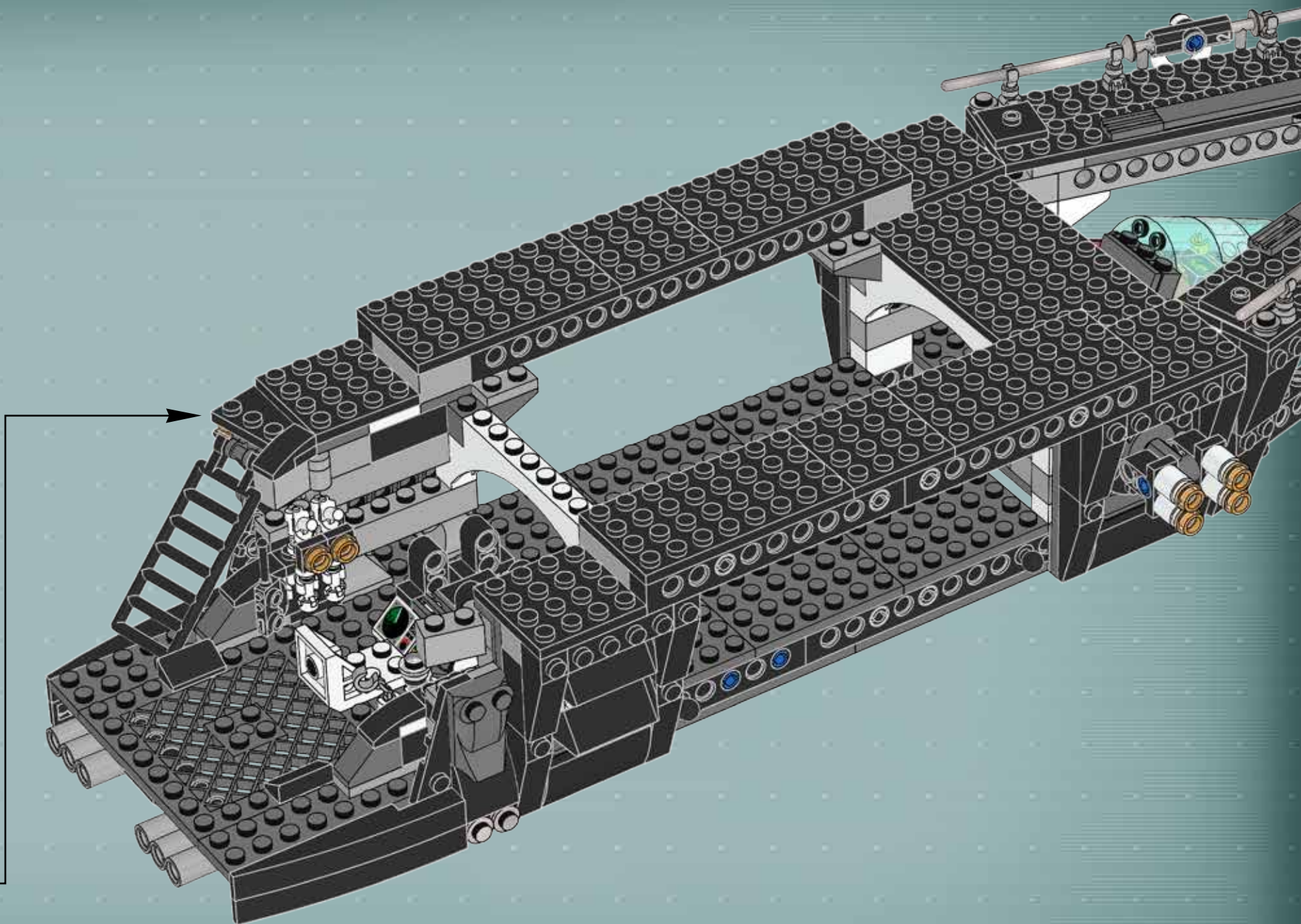

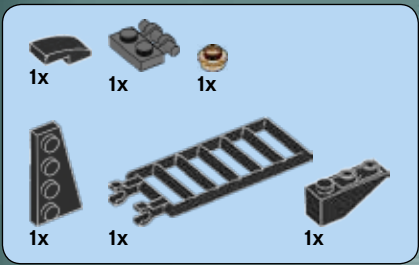

# 61

1



2



3



4



5

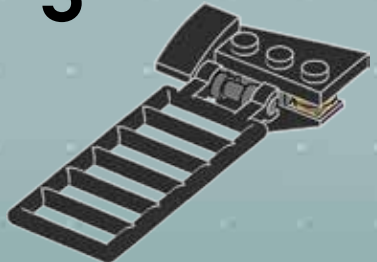

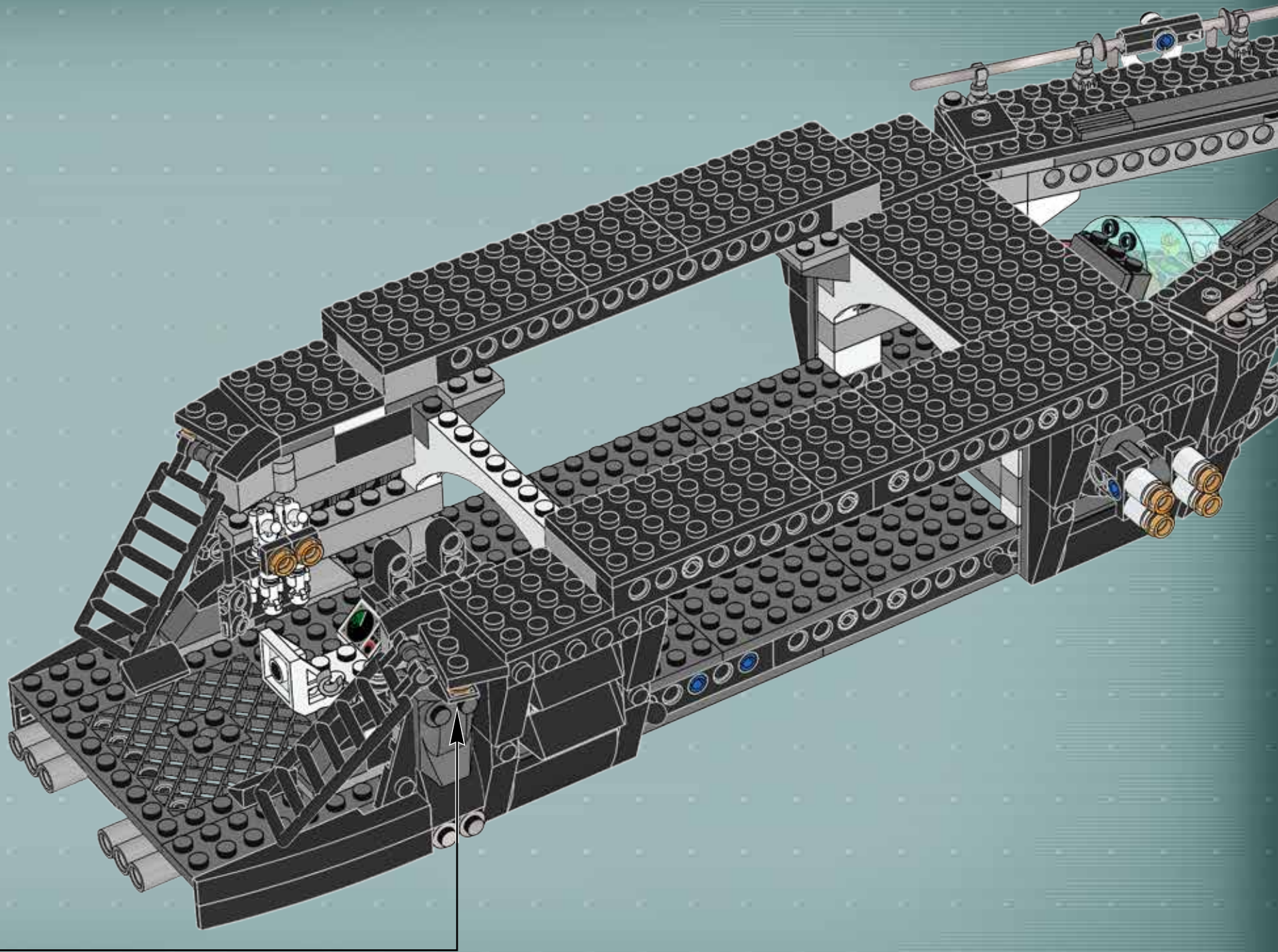



# 62

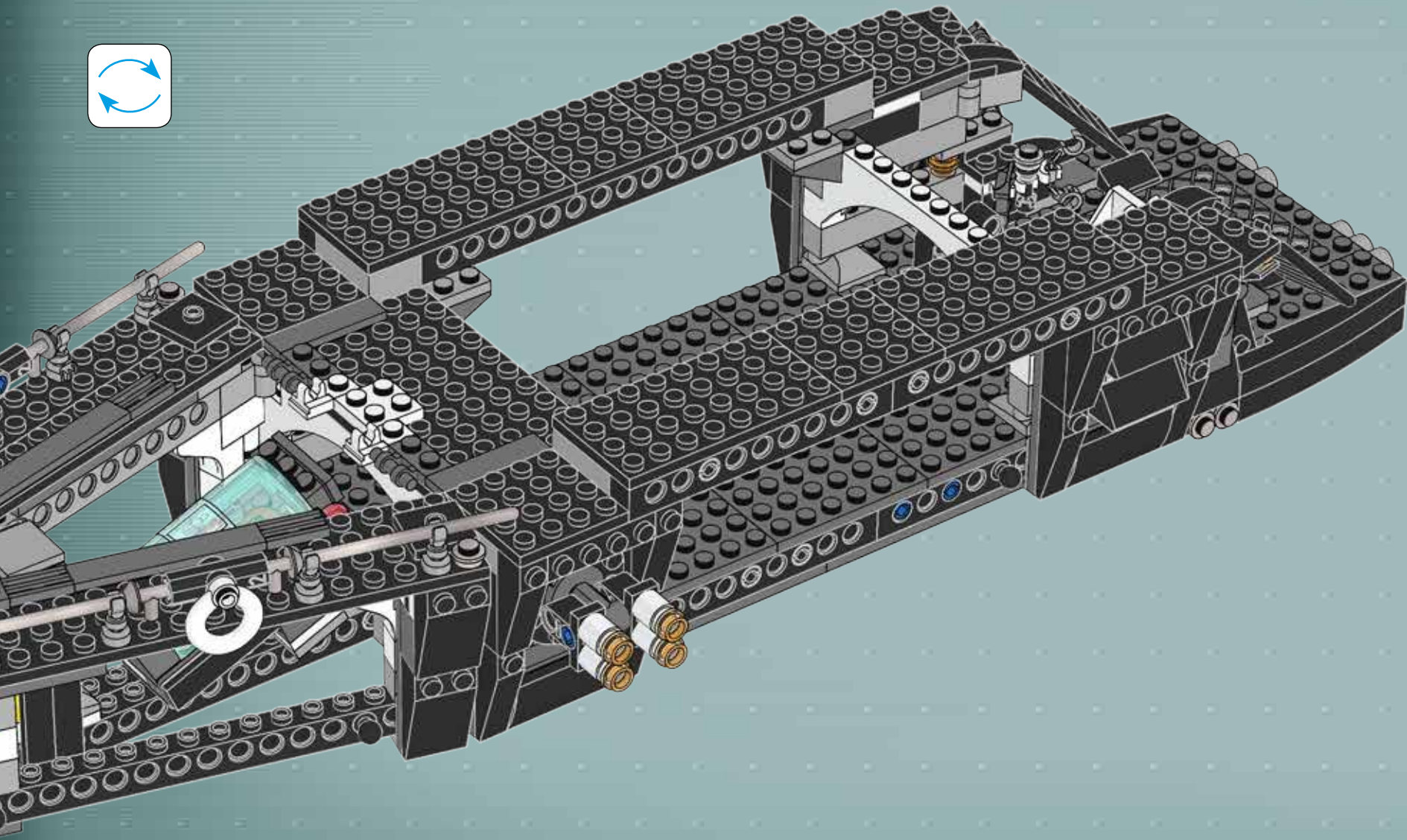

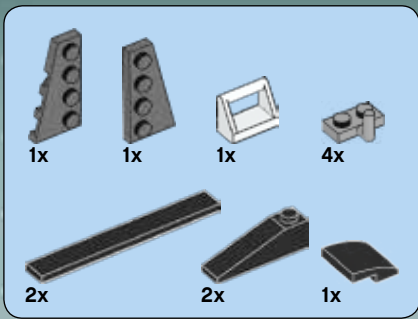

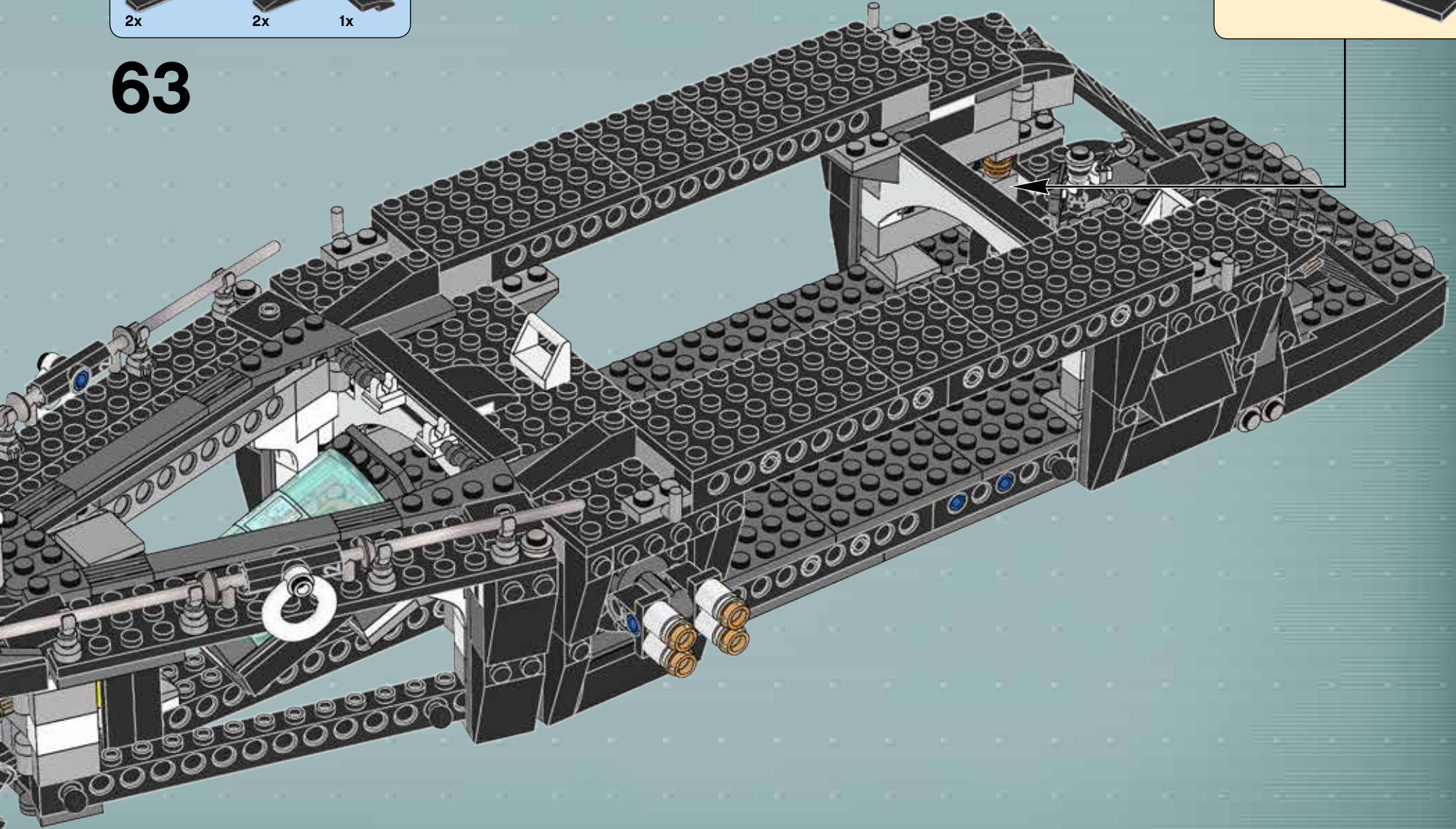

63



- 4x 
- 4x 
- 8x 
- 4x 
- 4x 

64

- 4x   

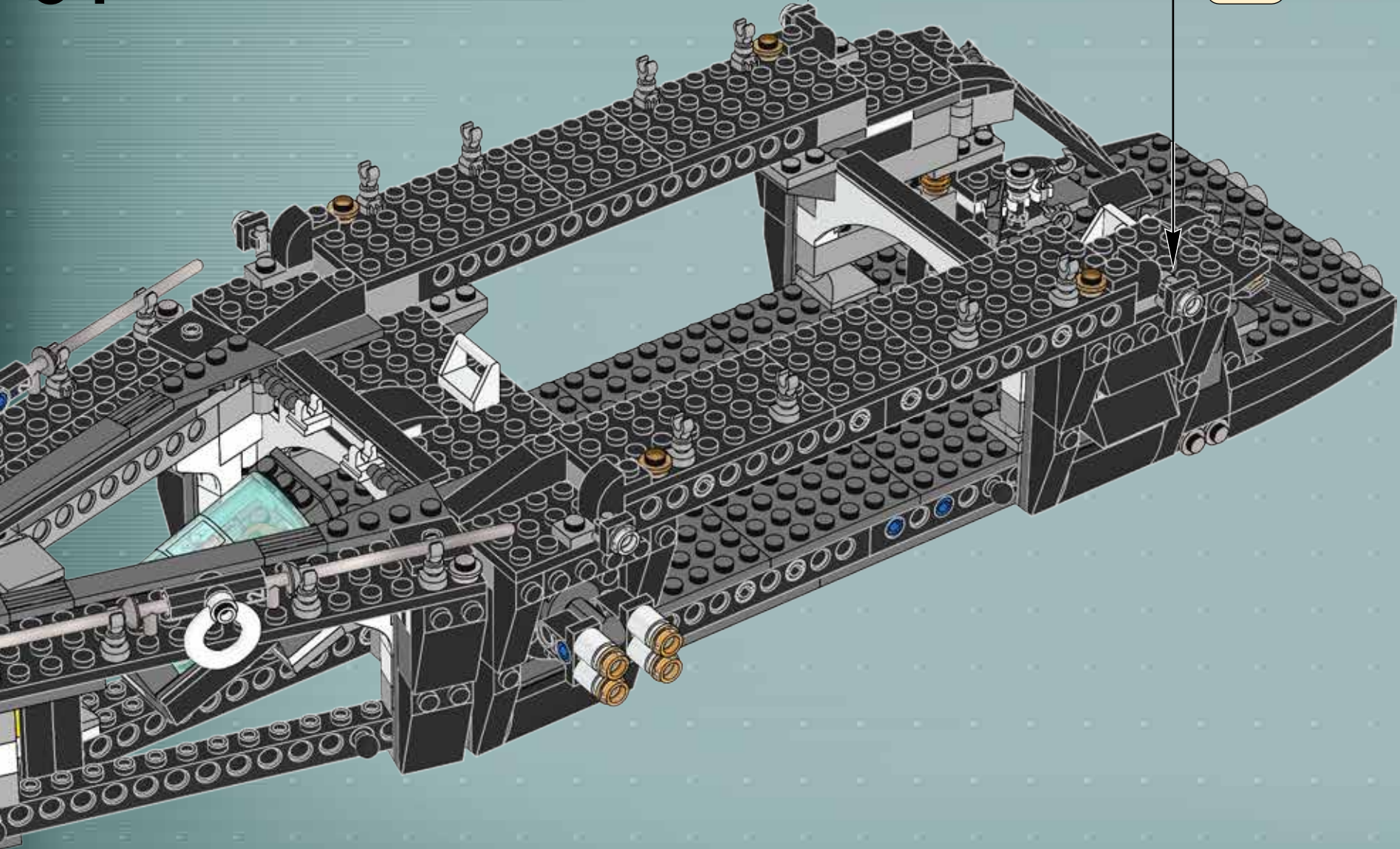

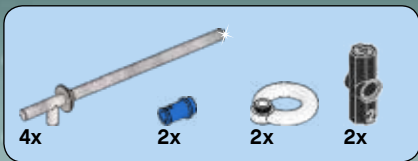

65

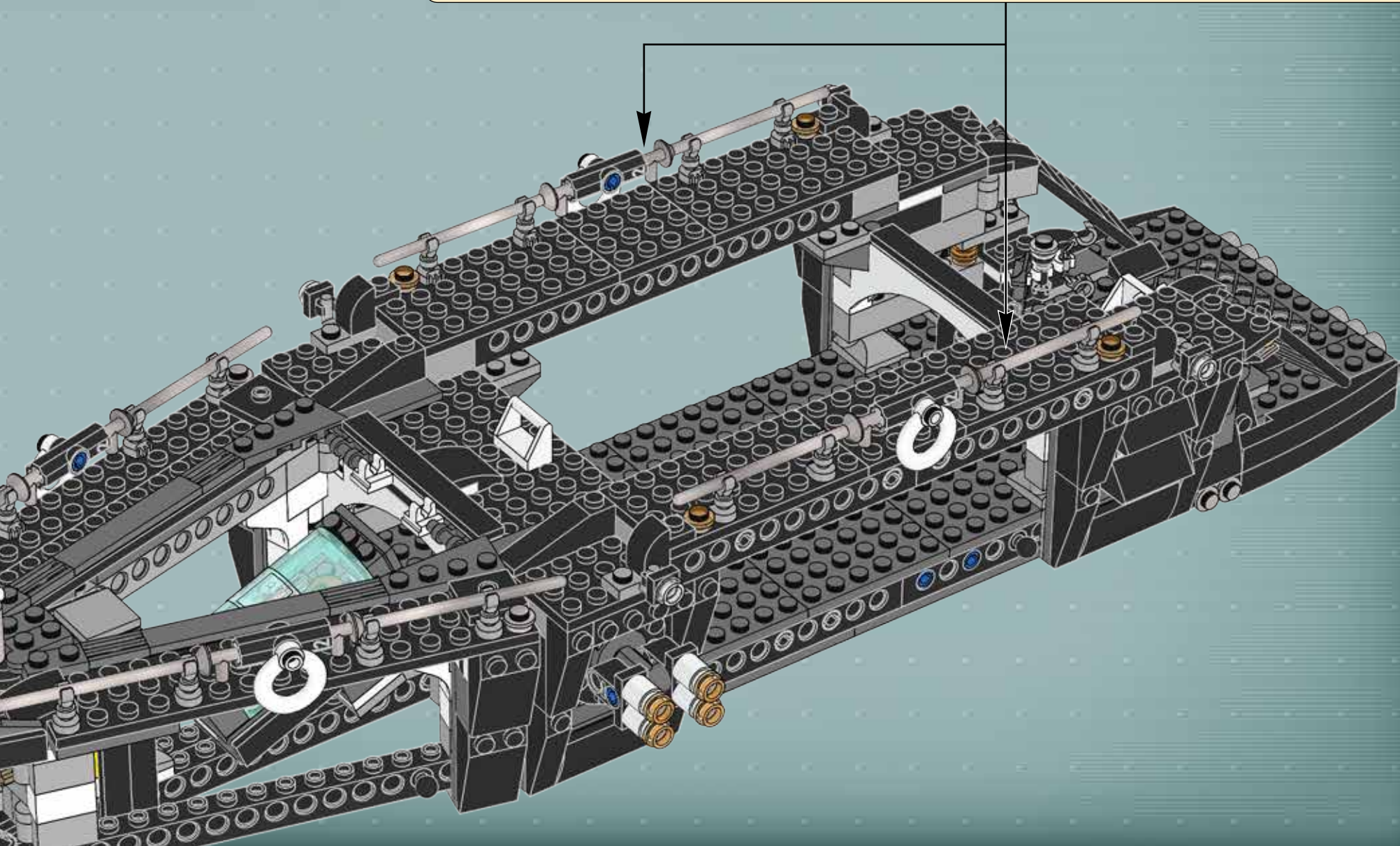
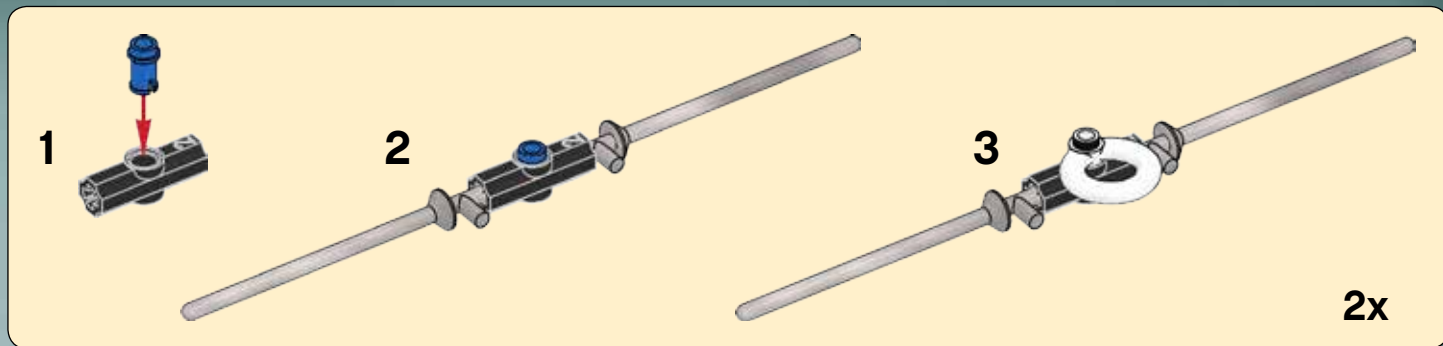

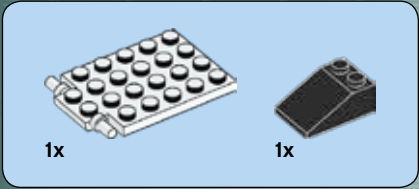

1

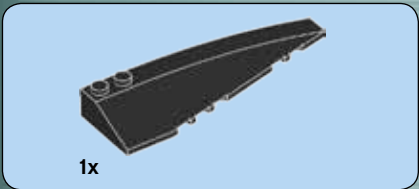

2

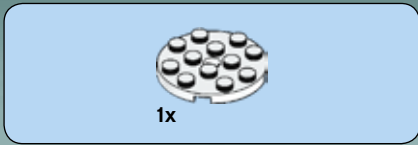
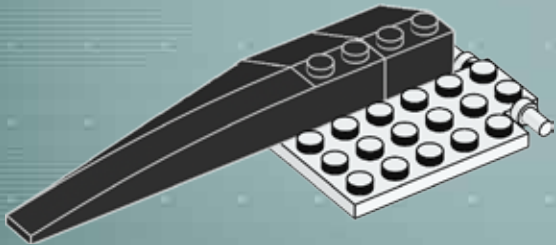

3

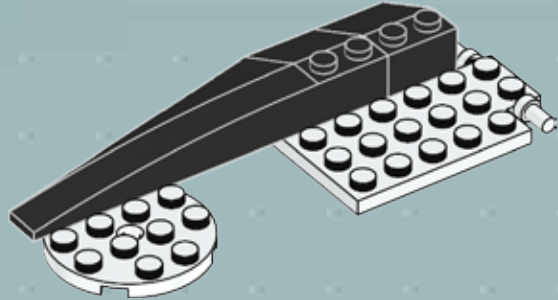

4

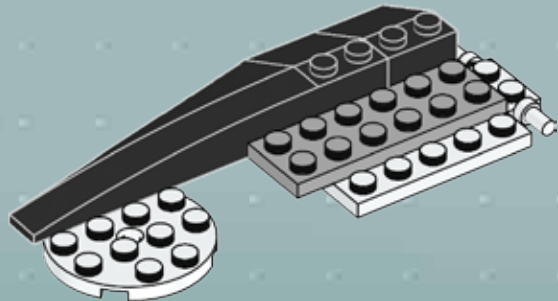



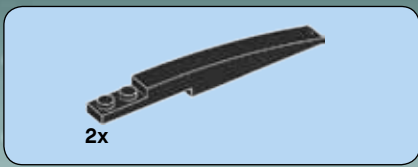

5

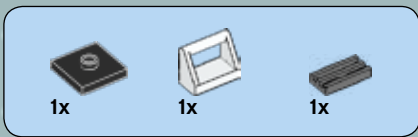
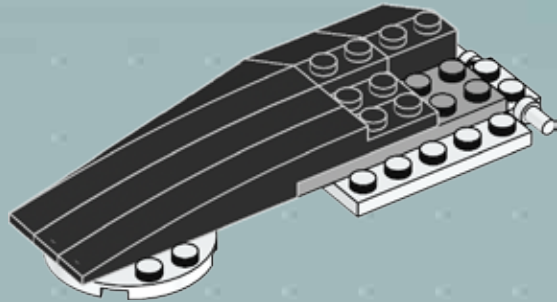

6

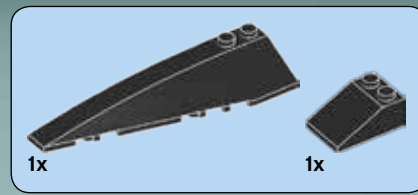
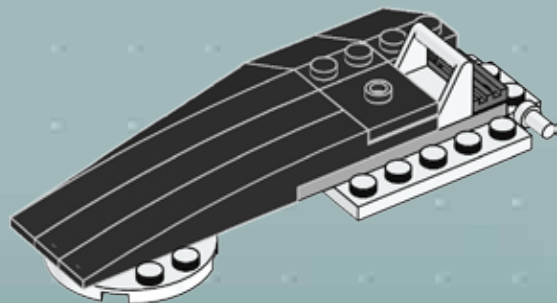

7

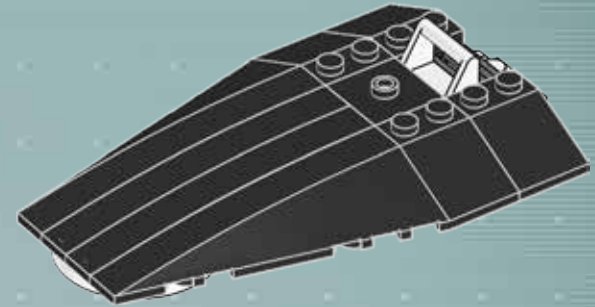

8

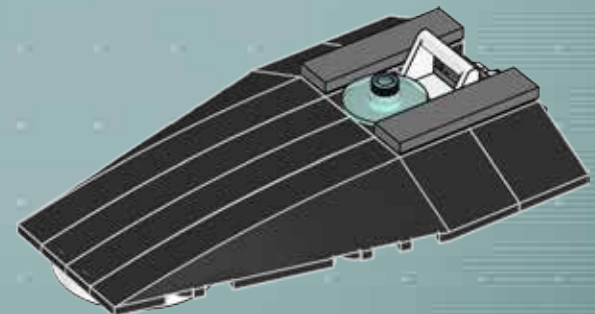

66

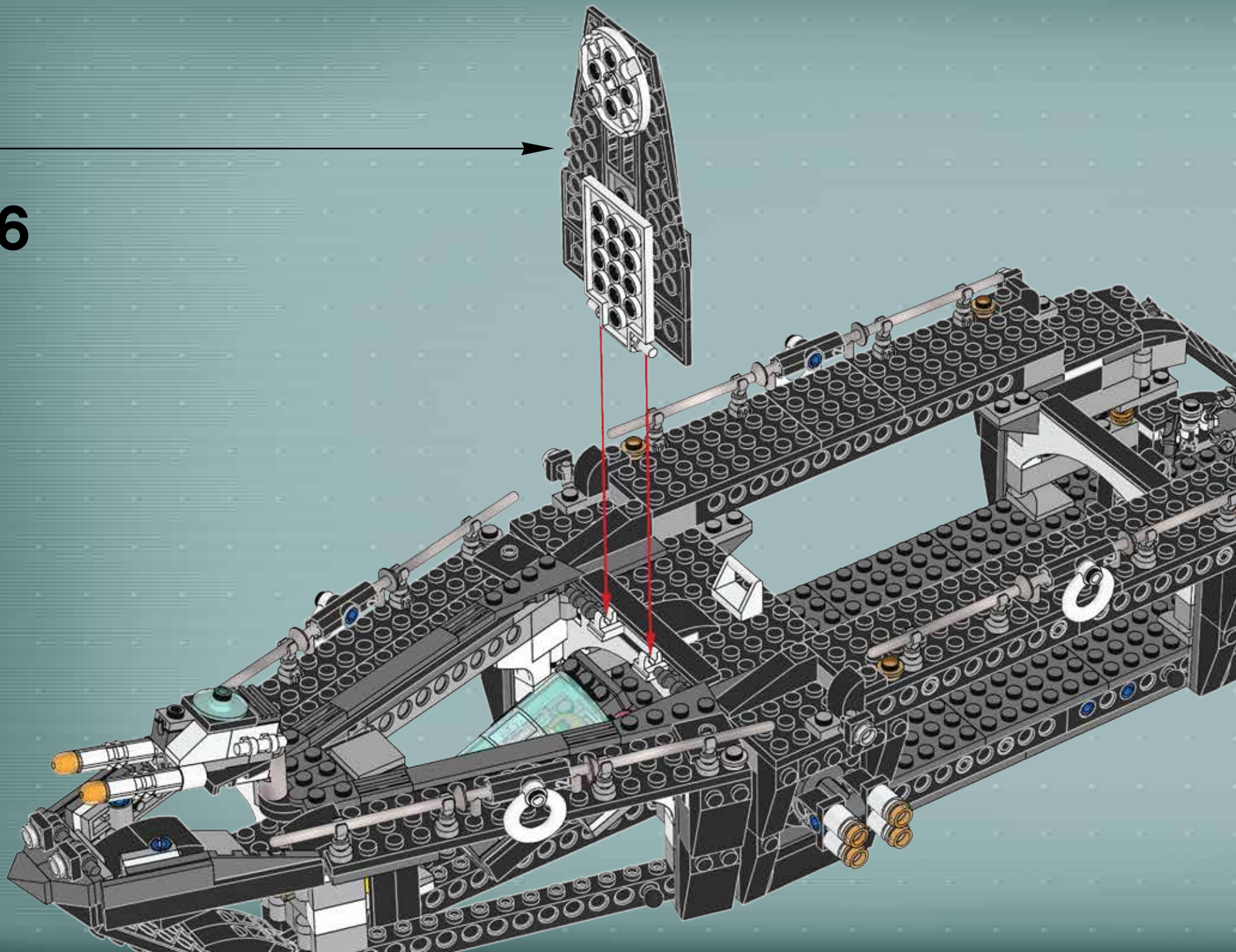

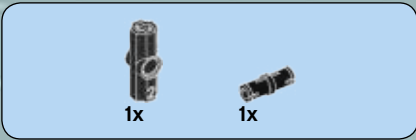

1



2

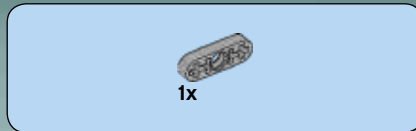

3

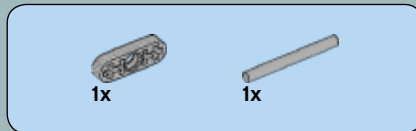

4

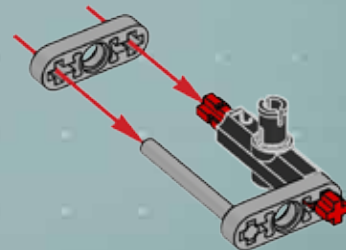

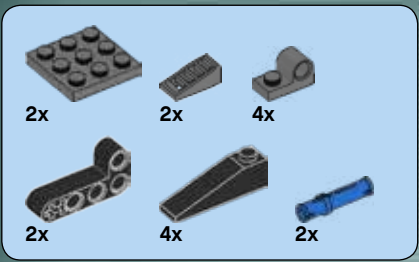

# 5

**1**

**2**

**3**

**4**

**5**

**2x**

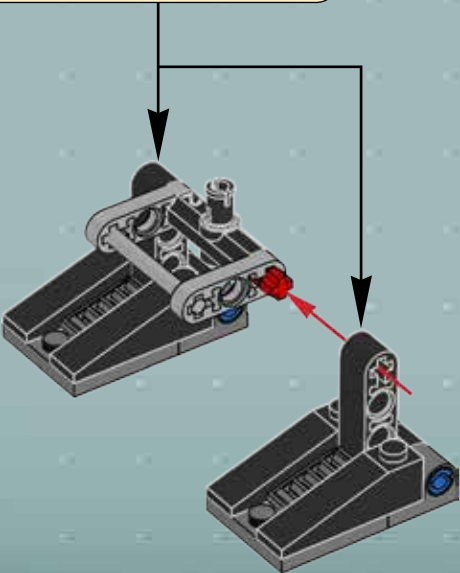

67

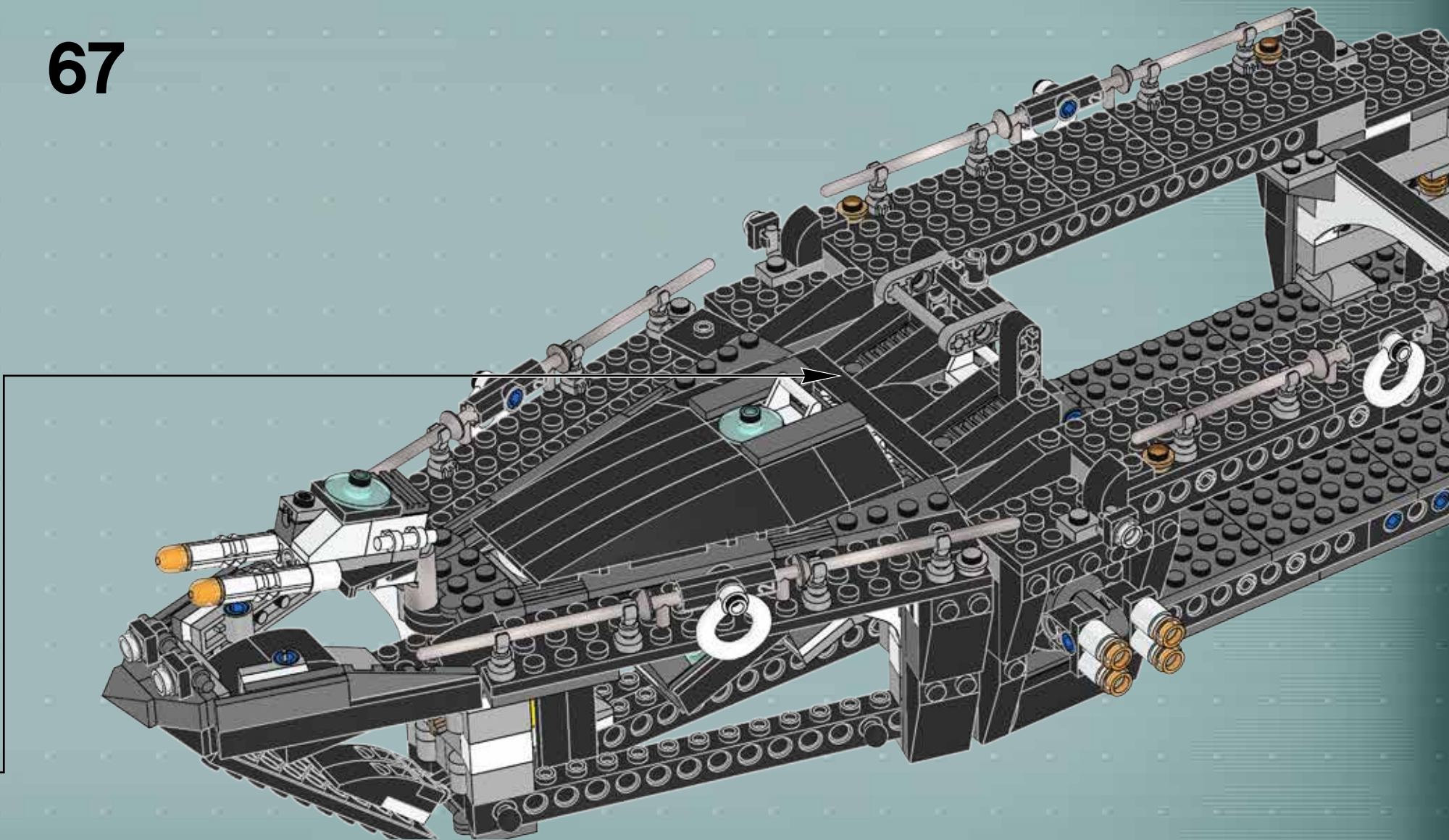

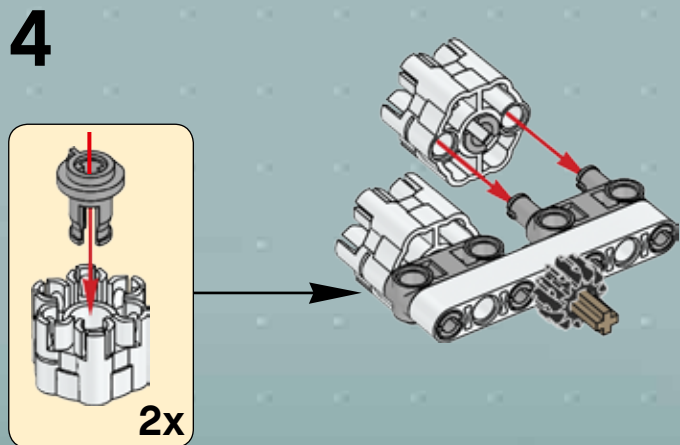
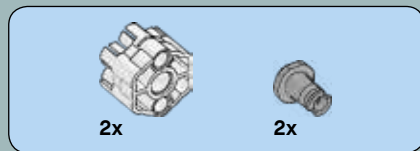
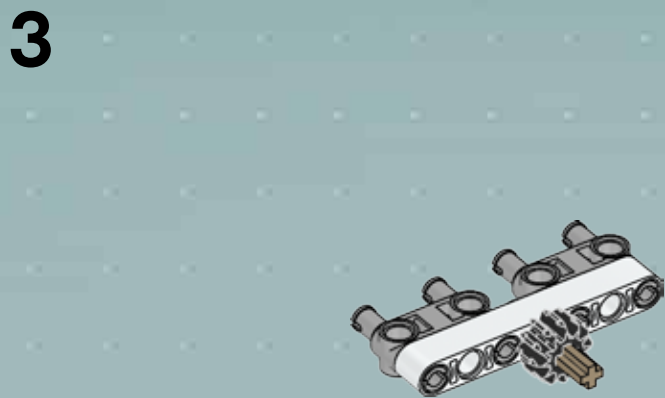
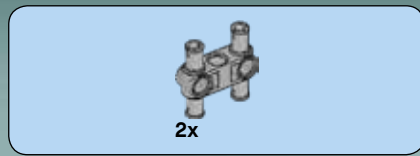
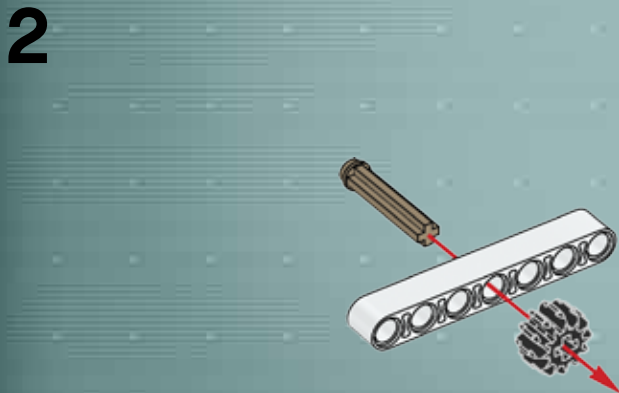
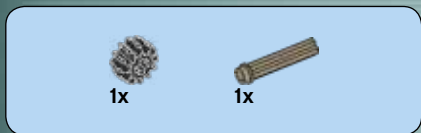
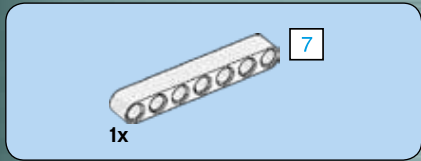

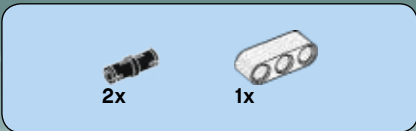

5

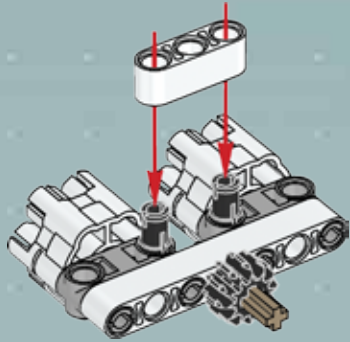

6

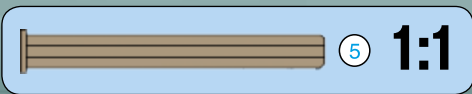
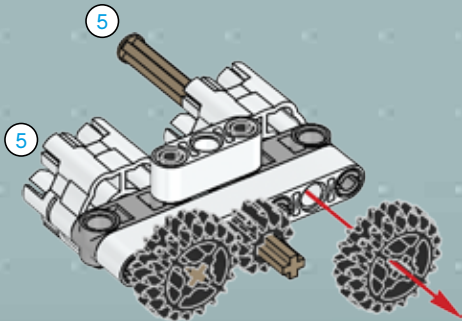

7

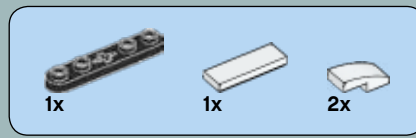
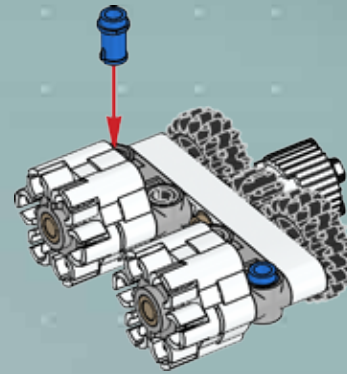

8

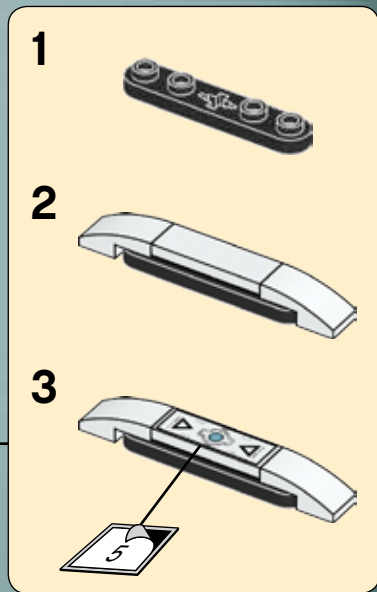
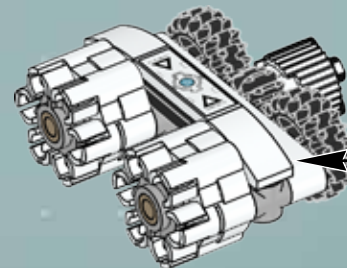

68

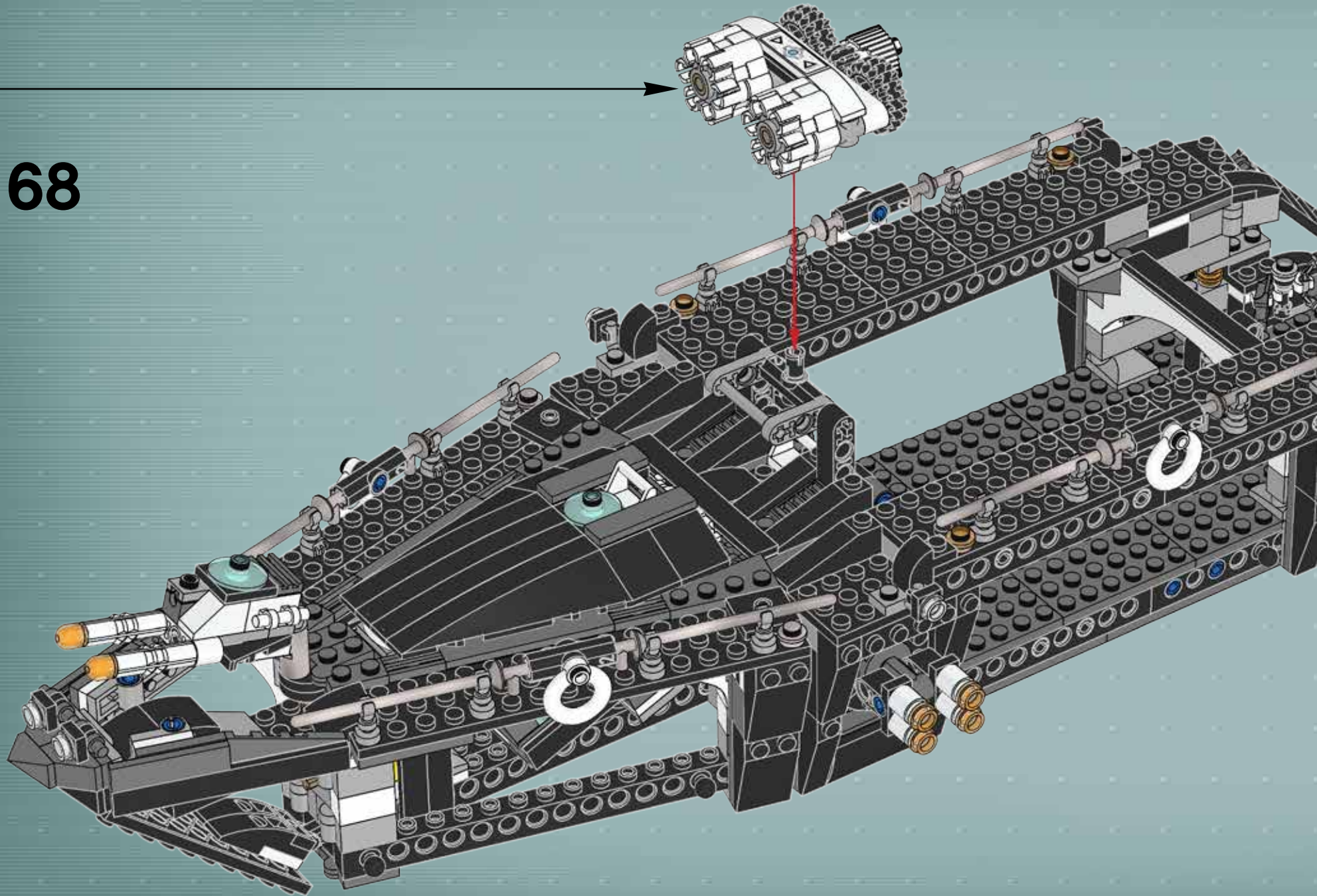



69

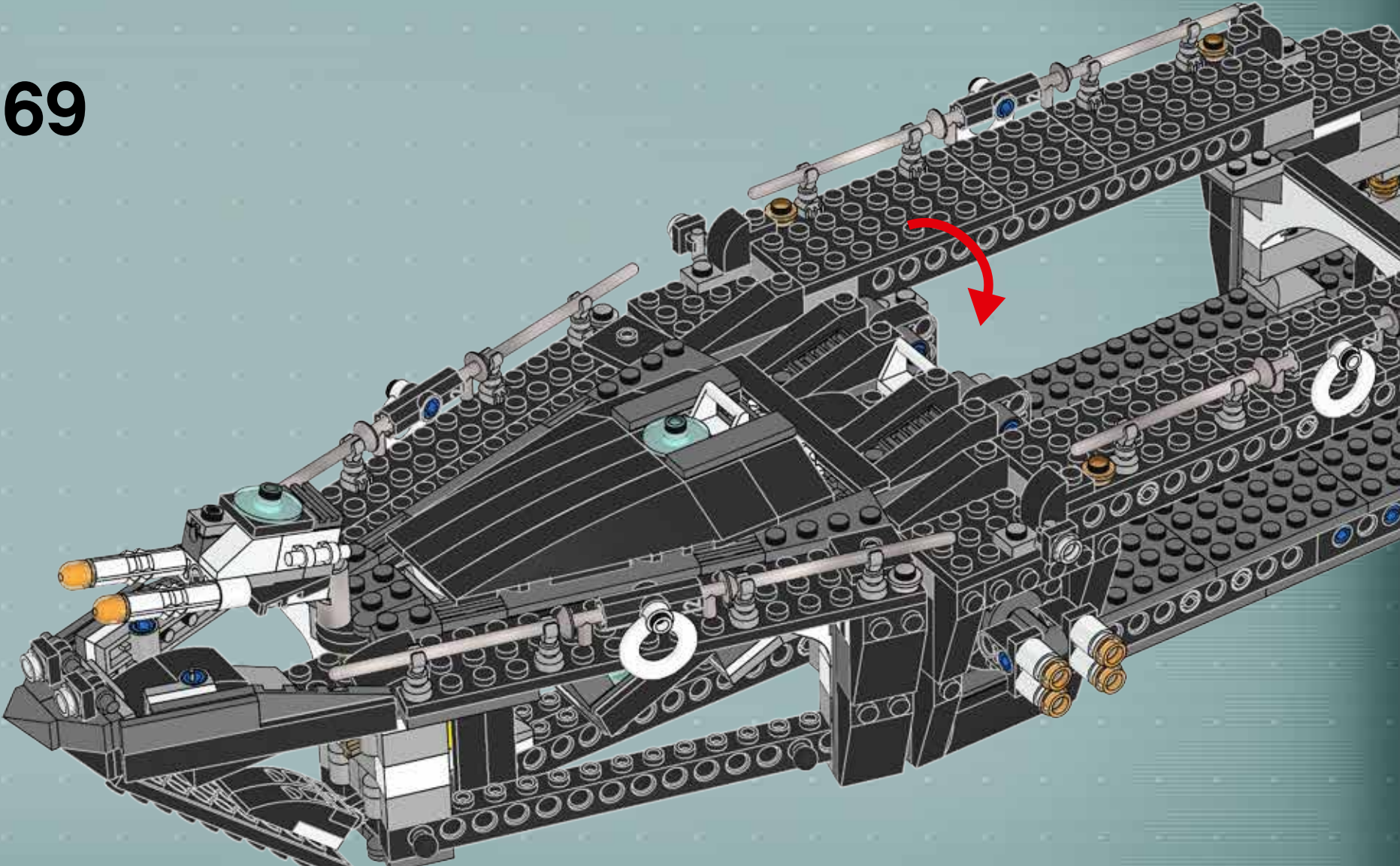

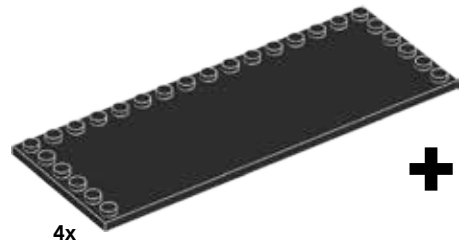

+

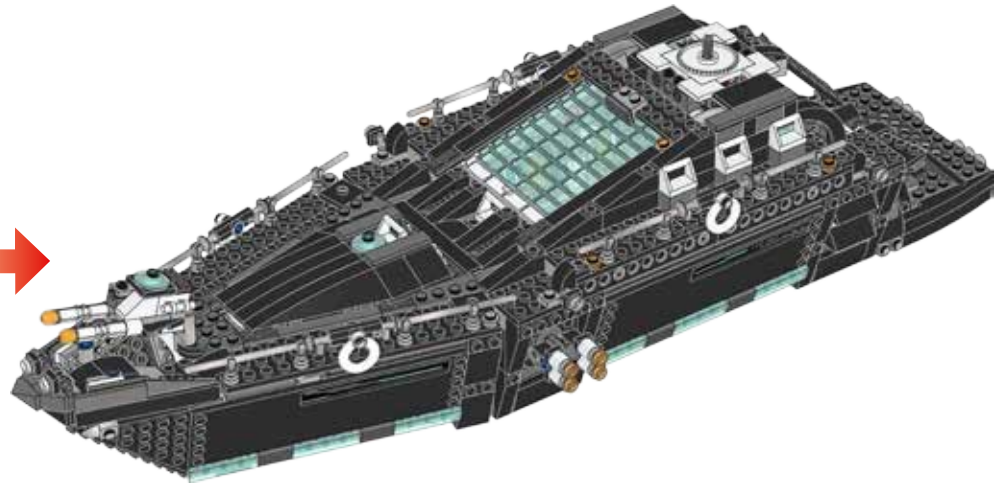

4x

6

1x

2x

3x

2

1

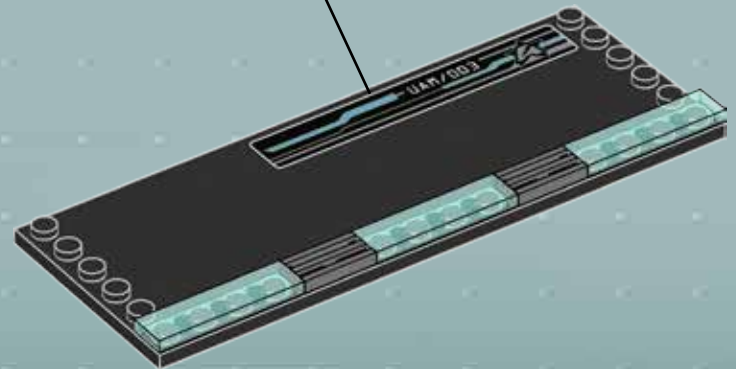



3

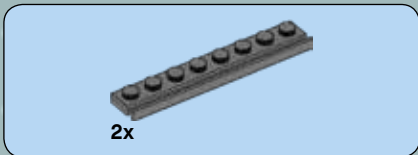
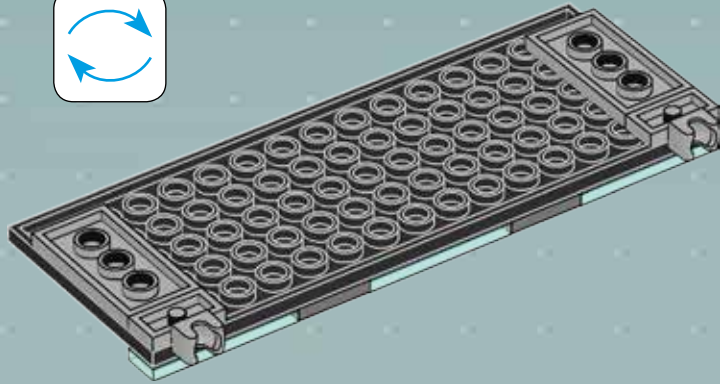

4

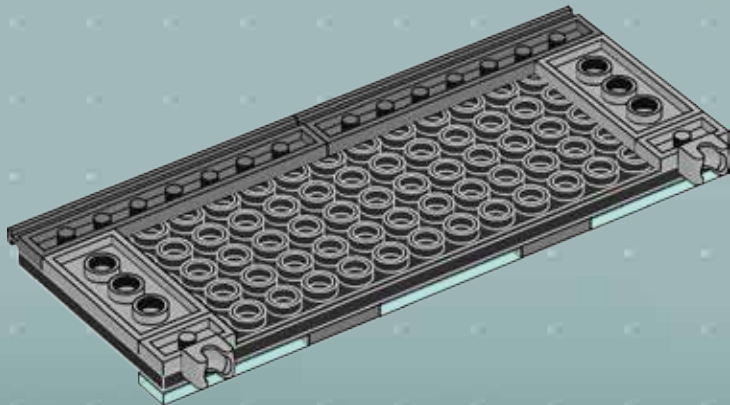

5

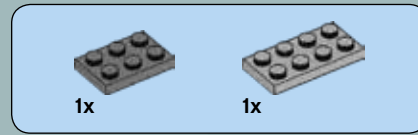
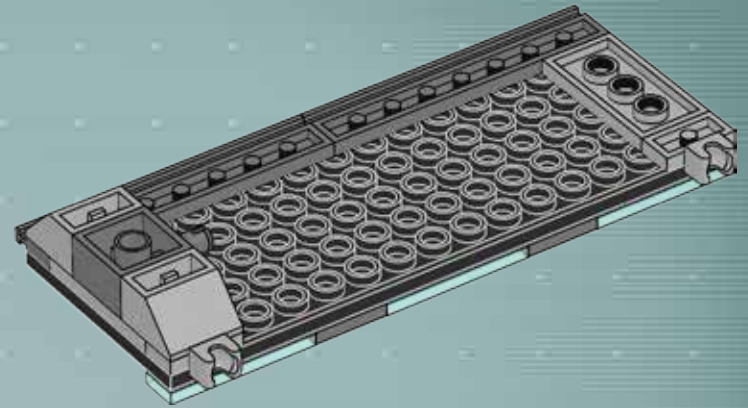

6

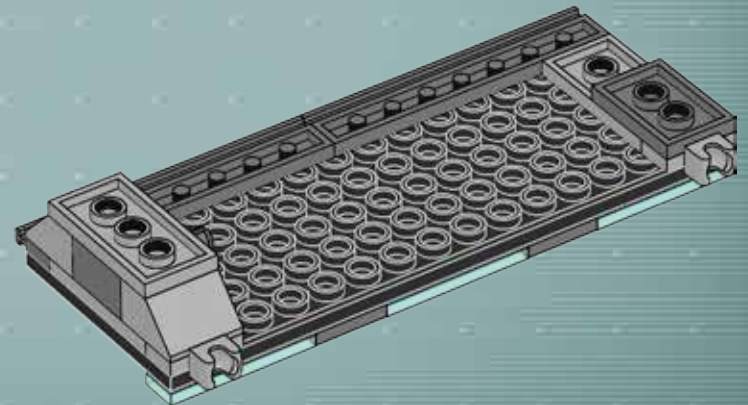

70

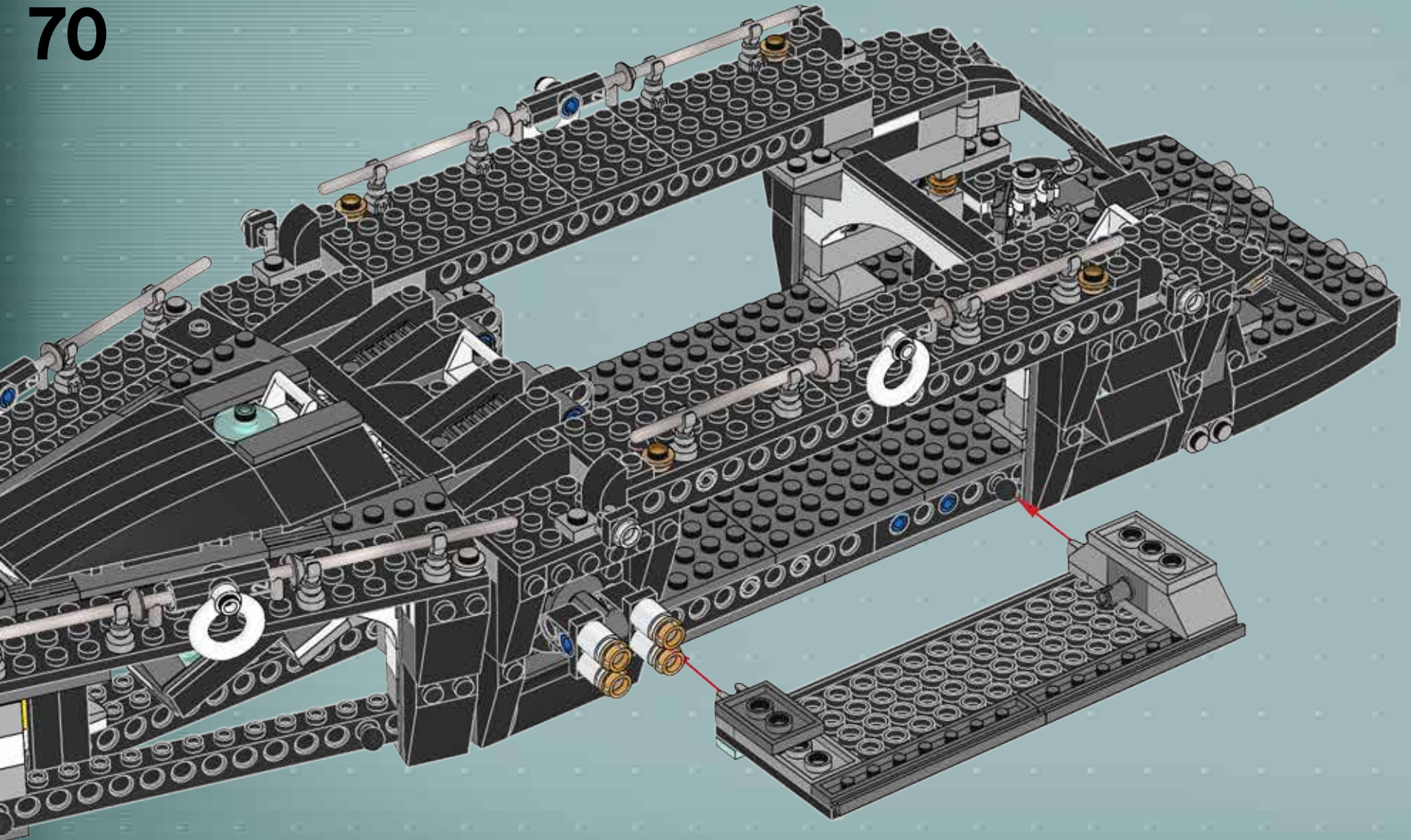

71

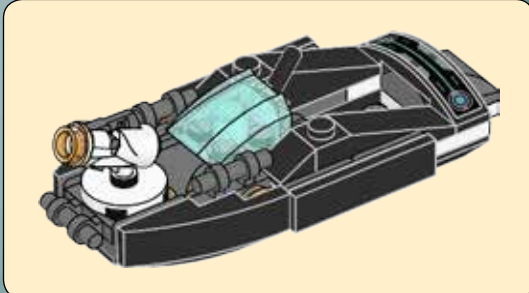
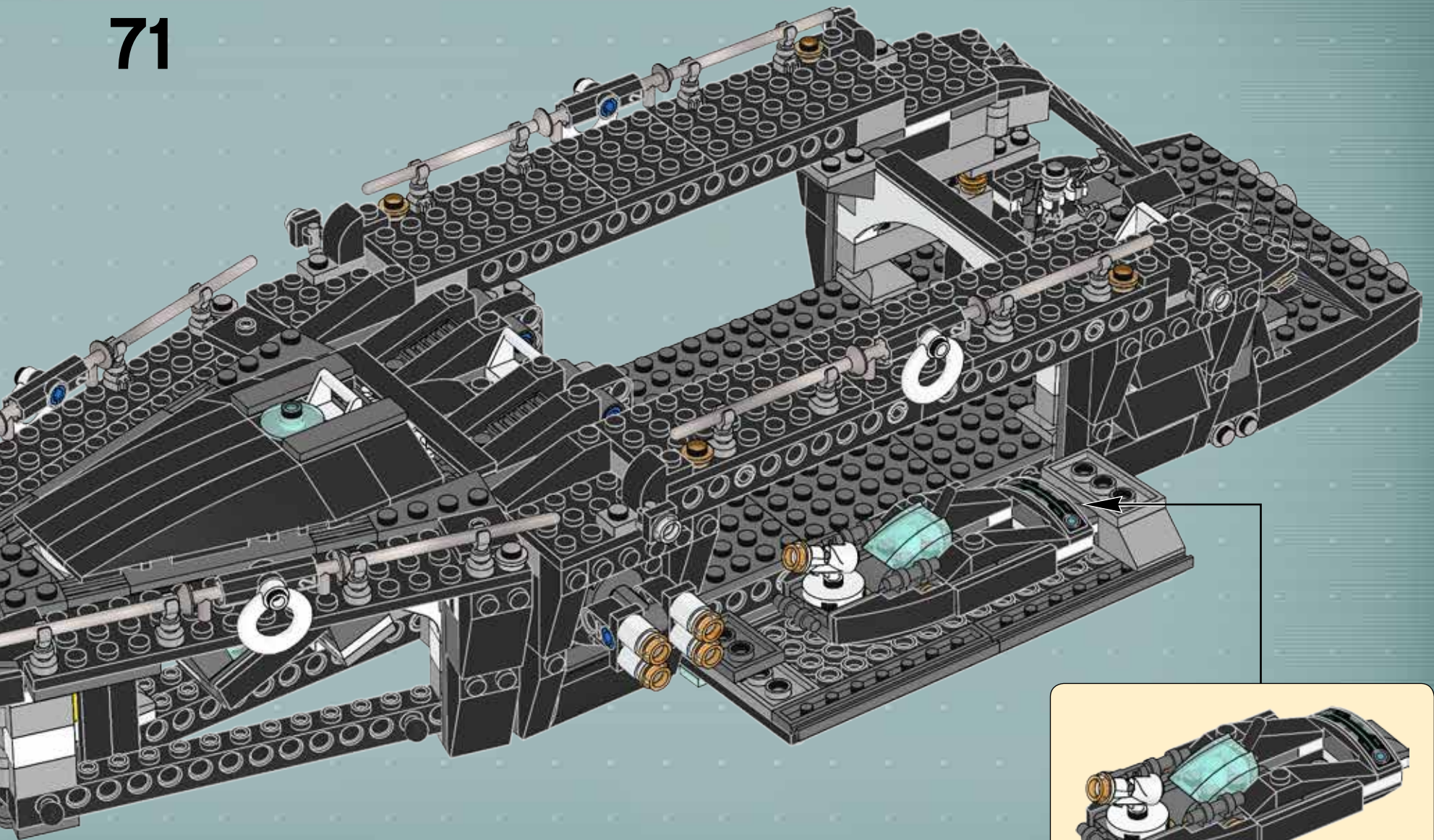

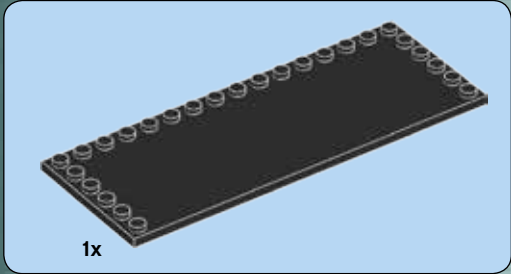
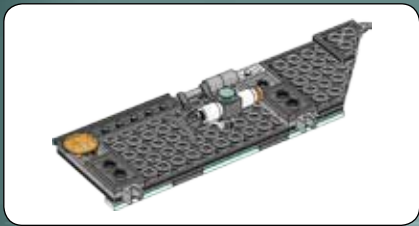

1x

1

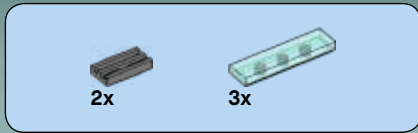
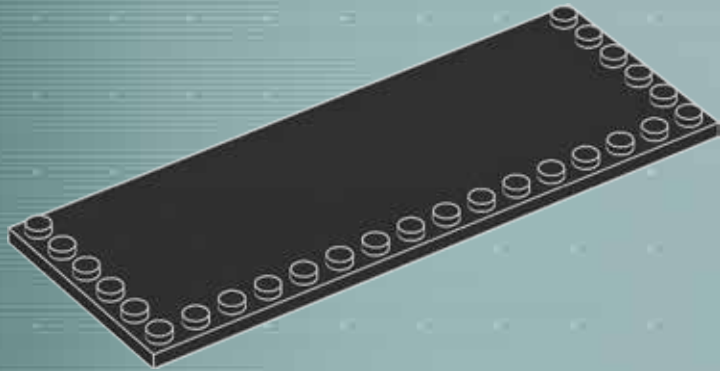

2x

3x

2

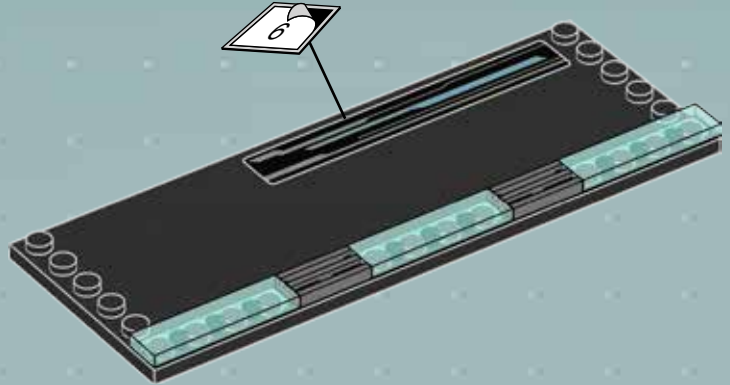

6

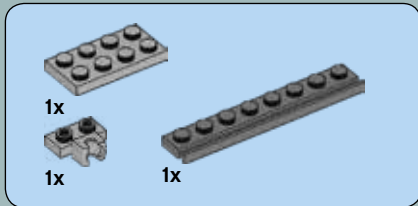

1x

1x

1x



3

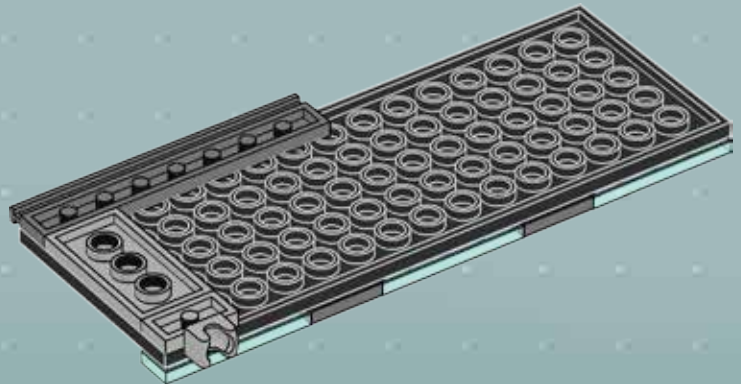

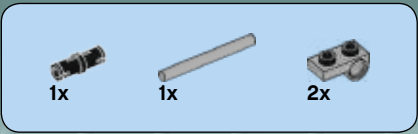

4

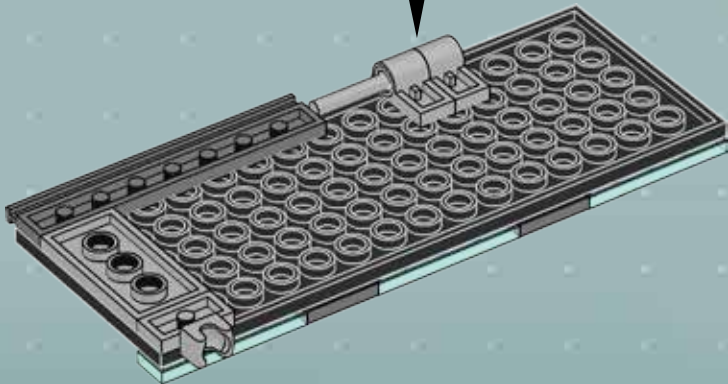
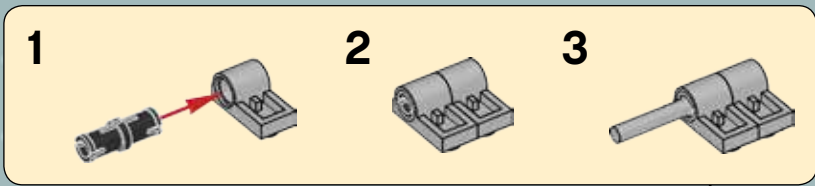

5

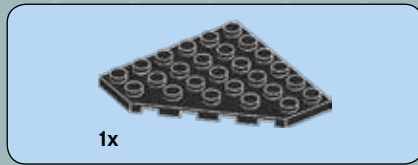
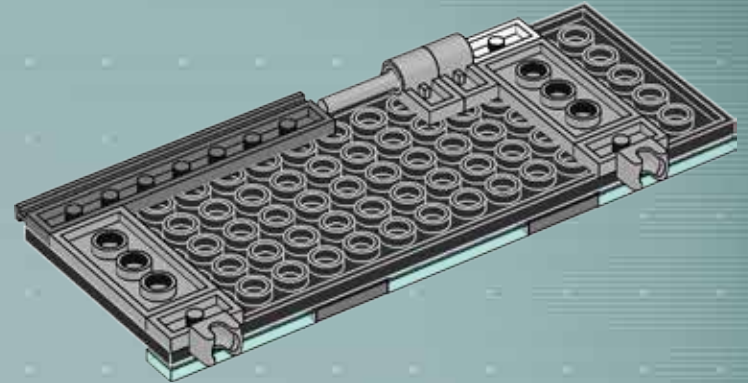

6

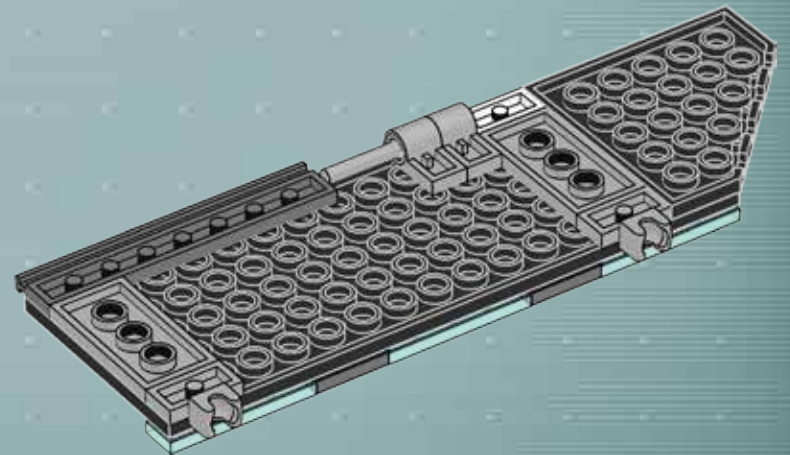



1x



1x

7

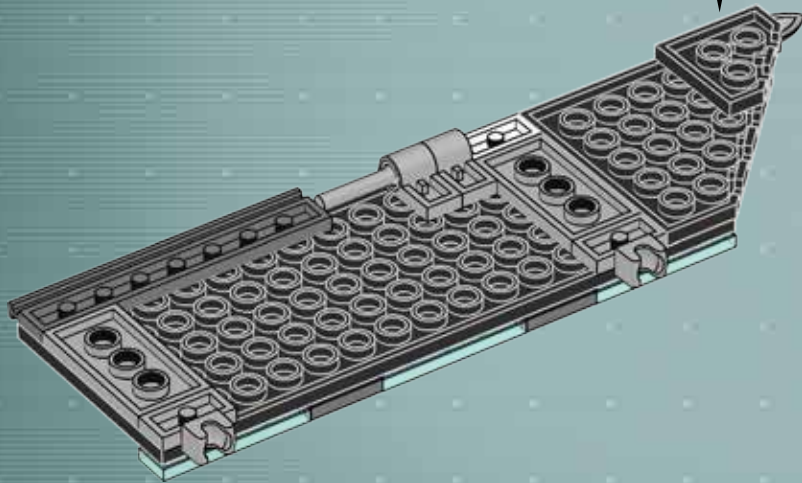
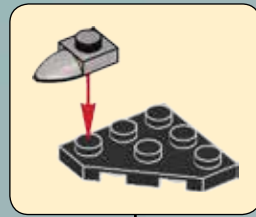

2x



1x

8

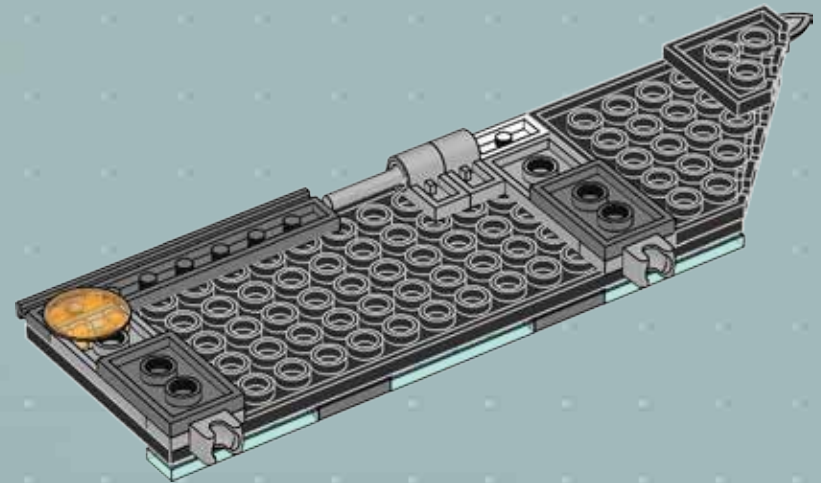





9

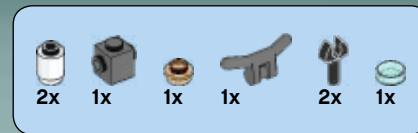
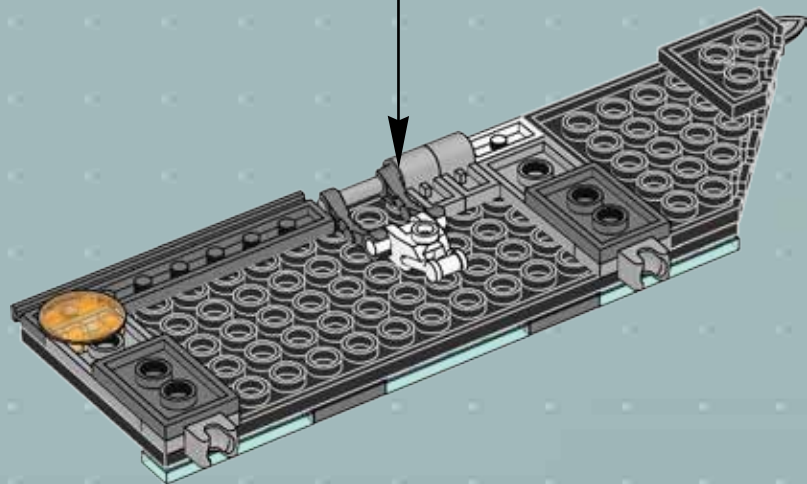
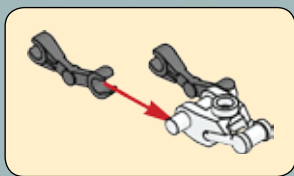

10

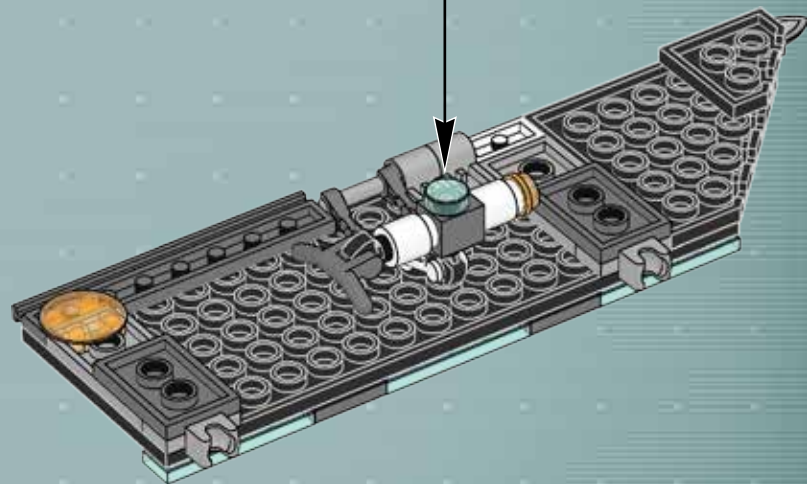
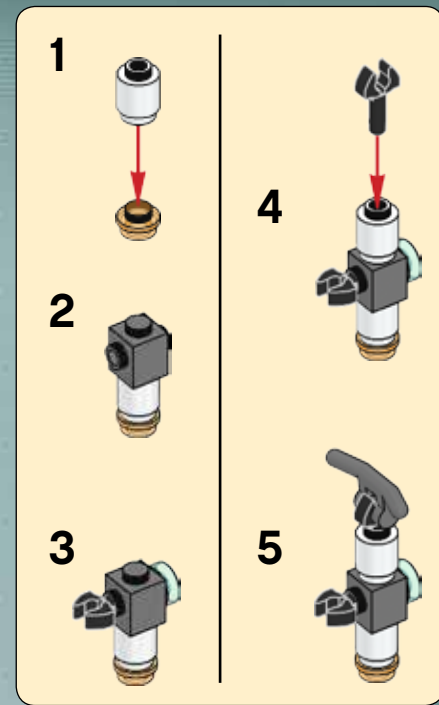

72

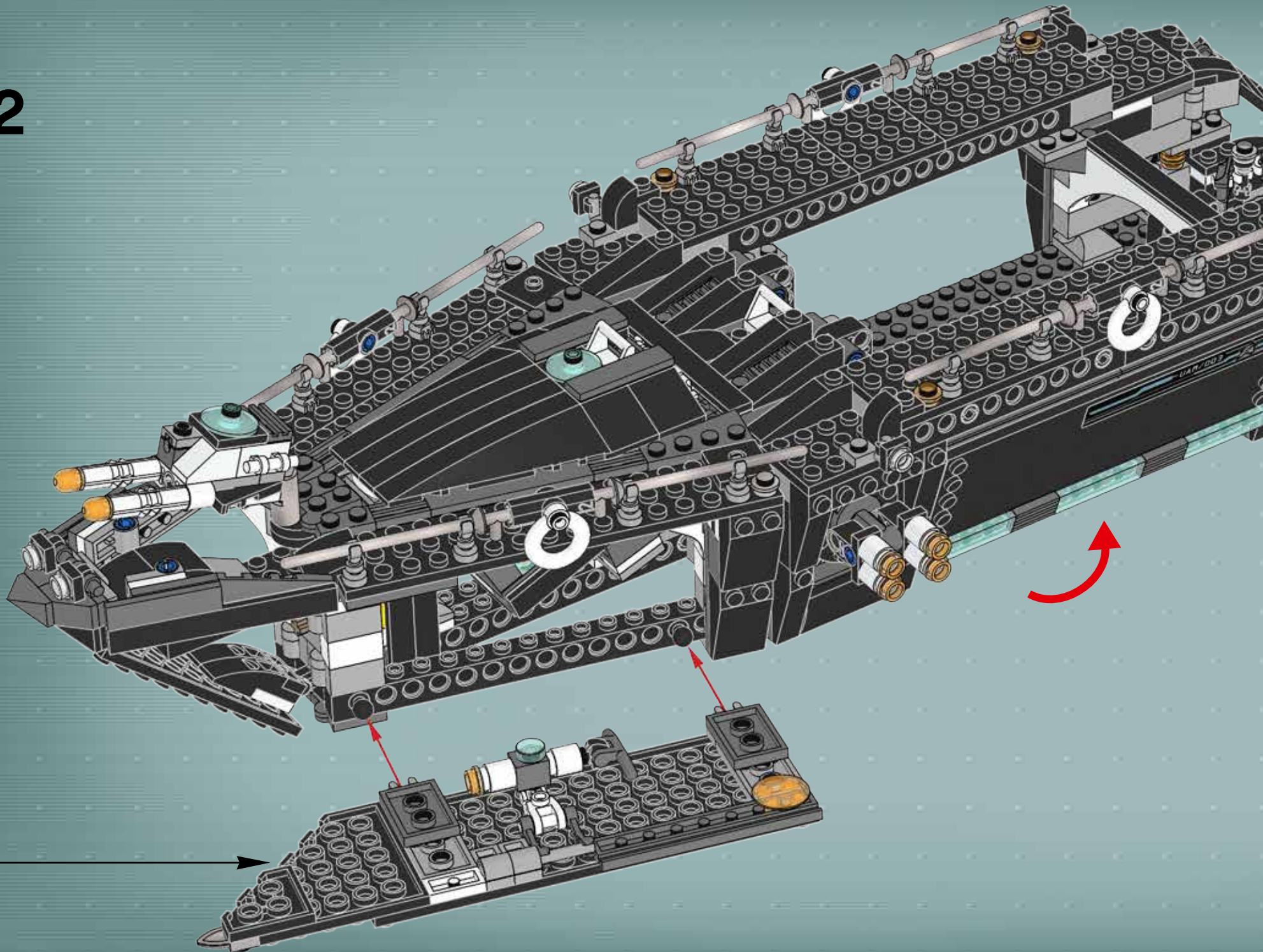

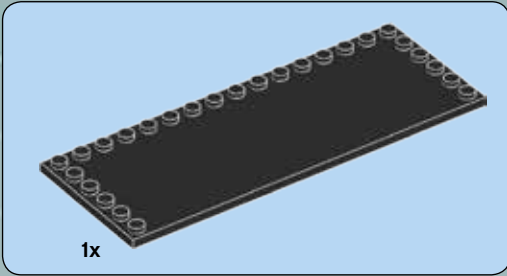
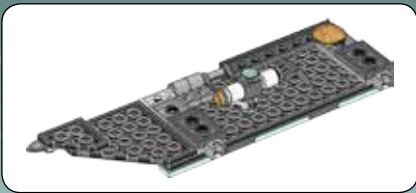

1

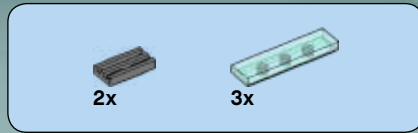
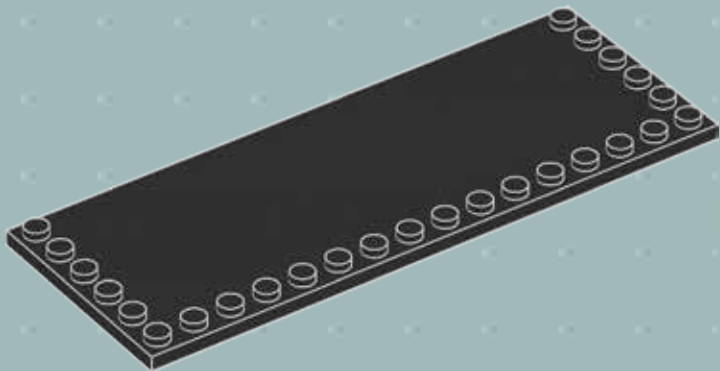

2

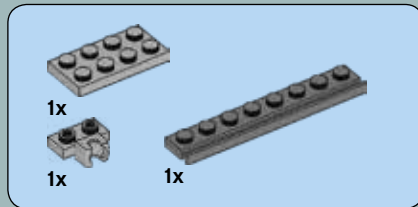
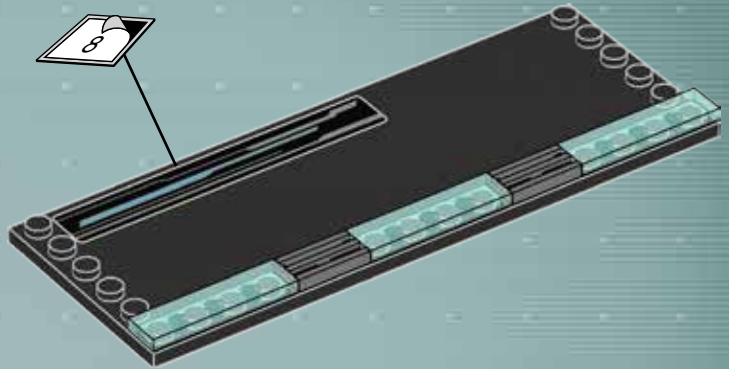

3

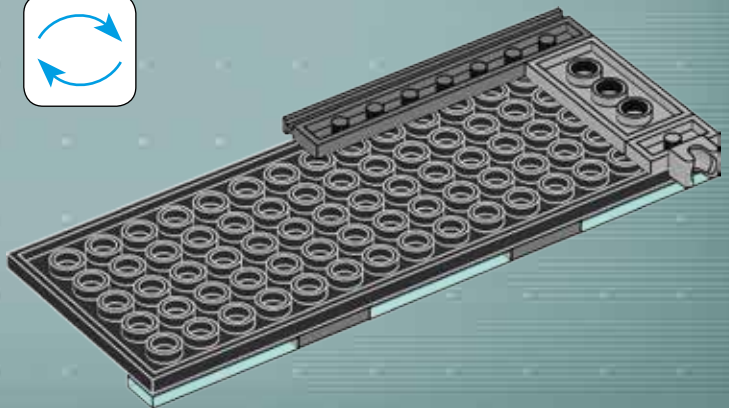
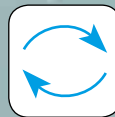

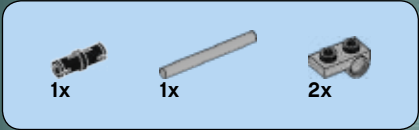

4

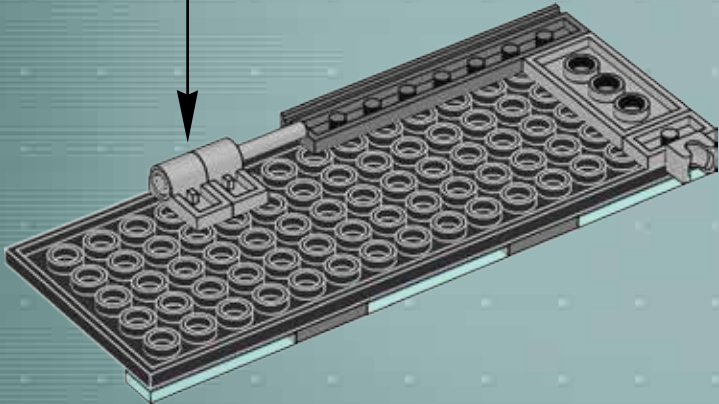
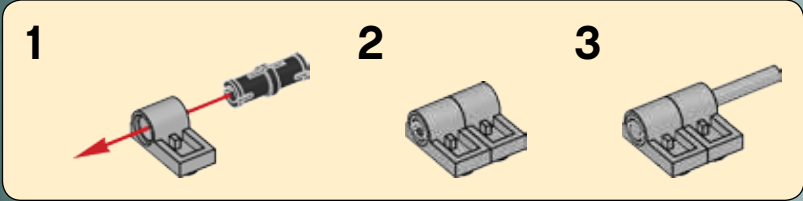

5

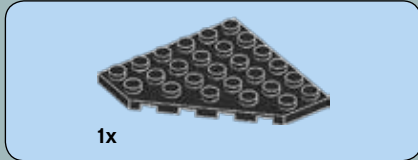
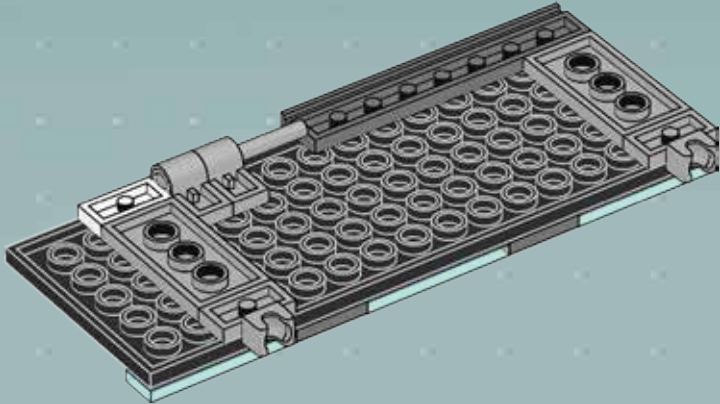

6

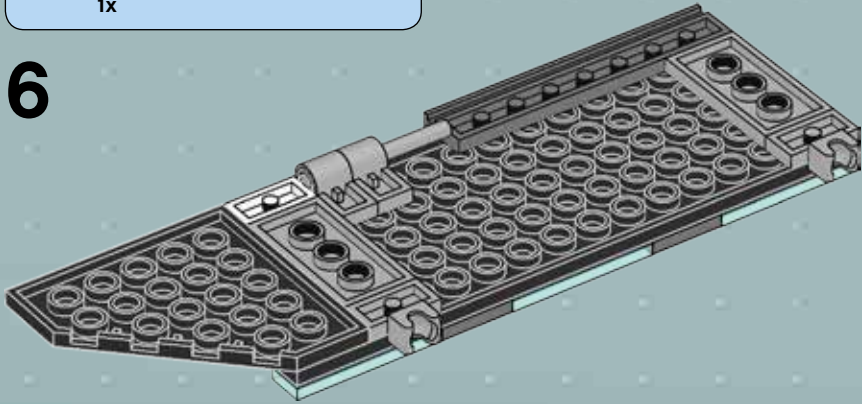



7

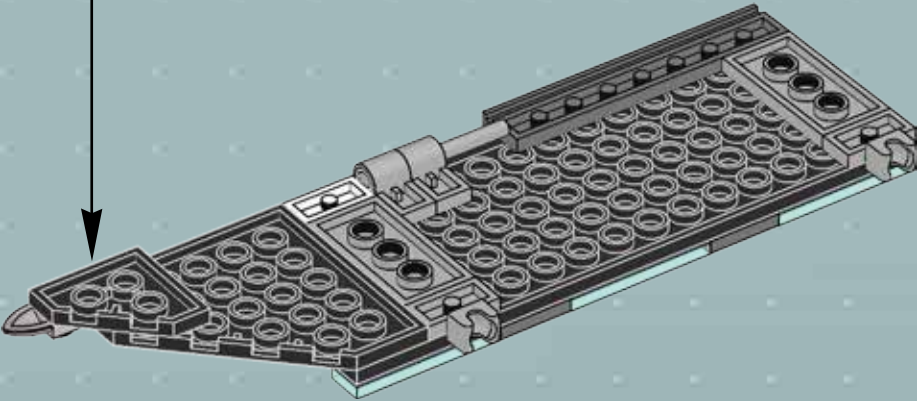
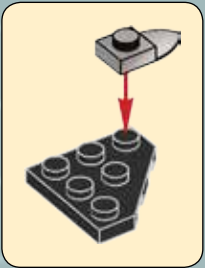

8

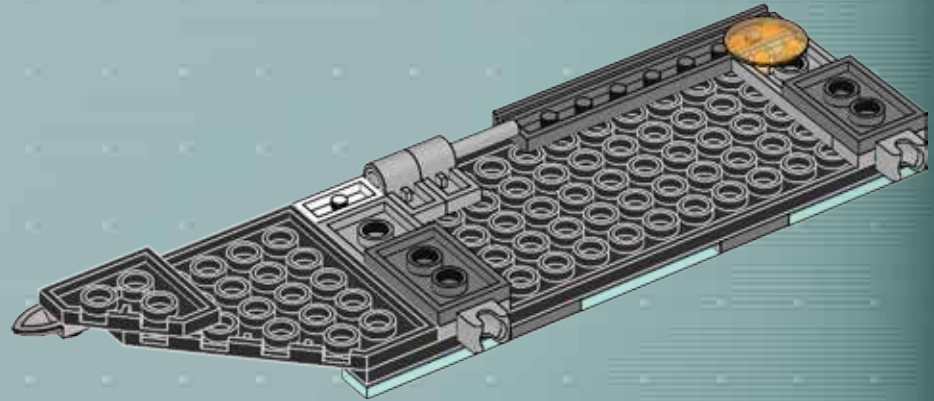



9

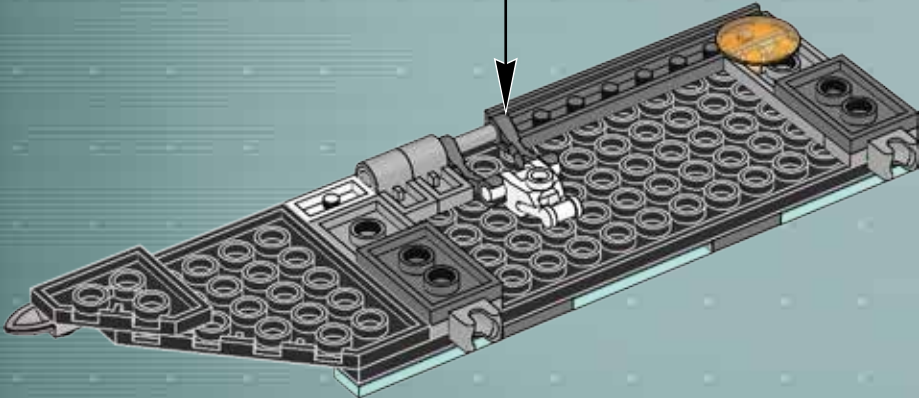
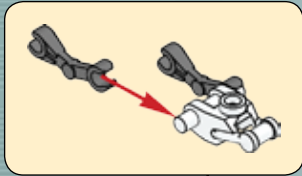

10

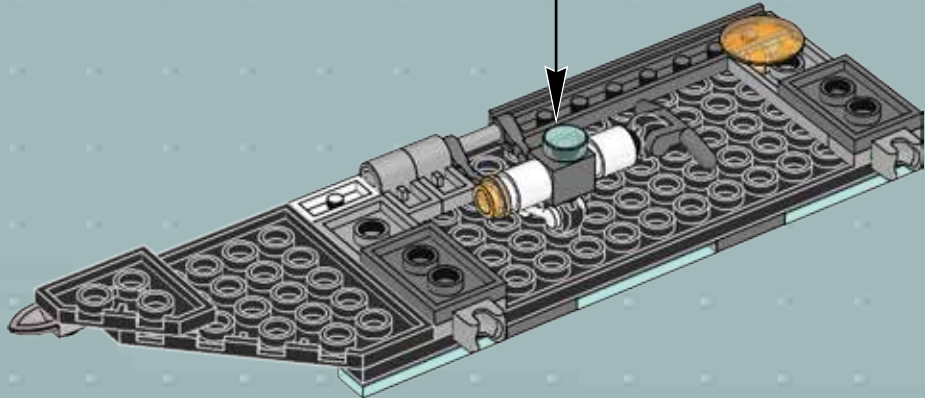
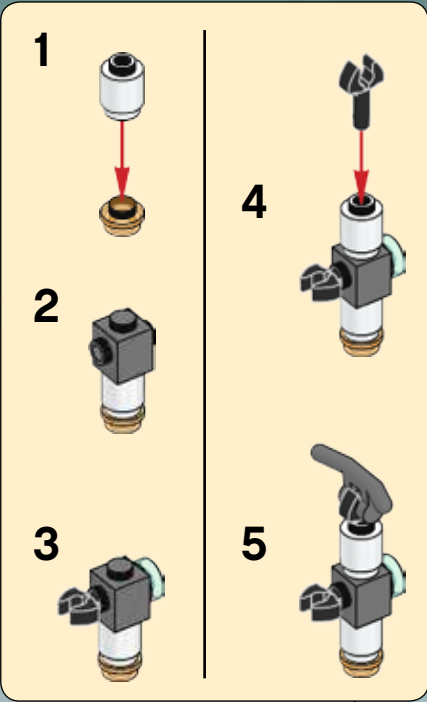

# 73

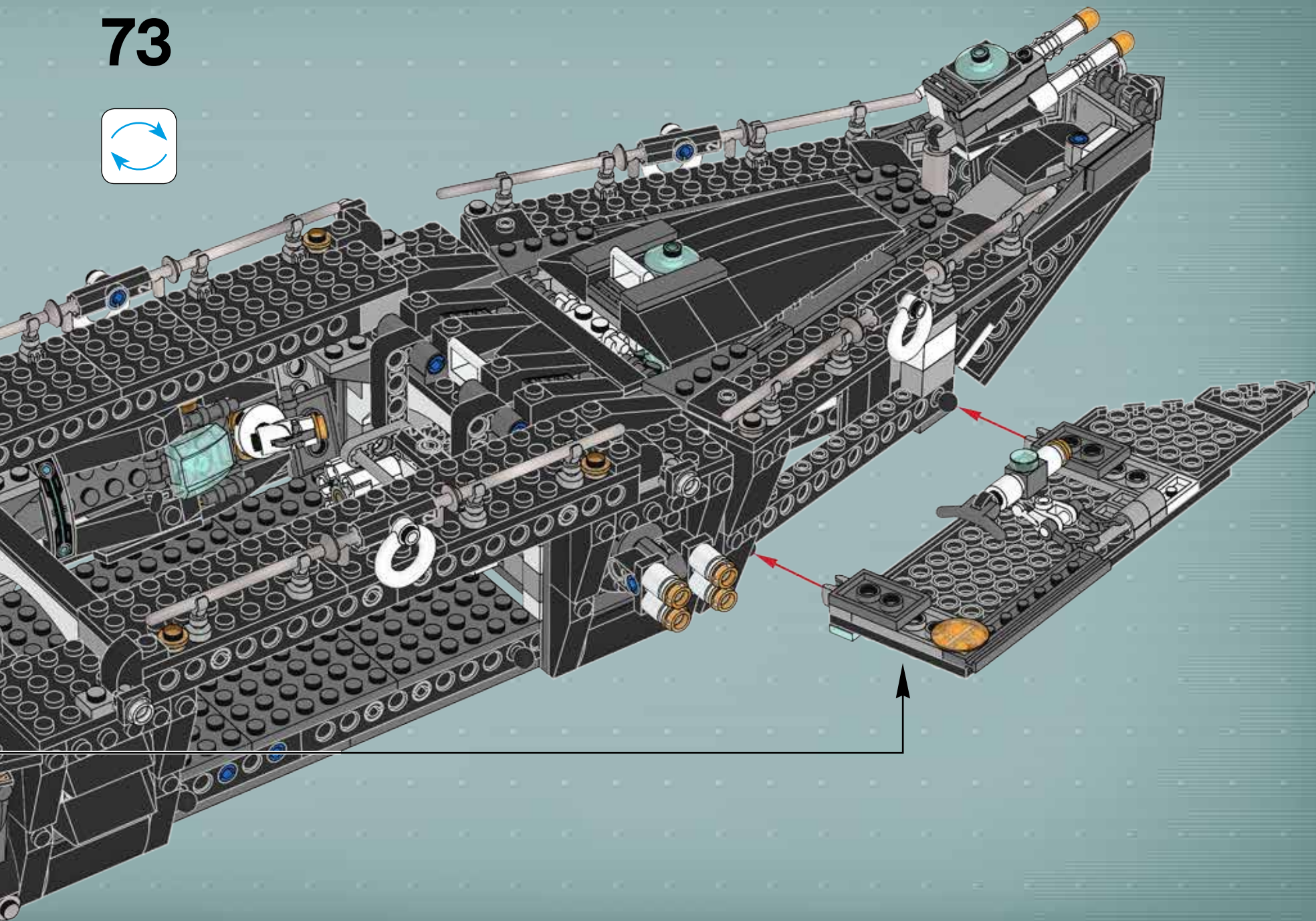

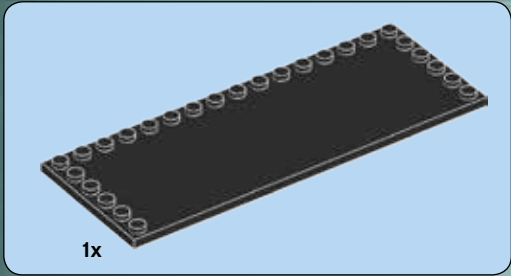

1

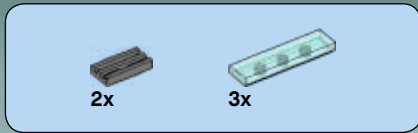
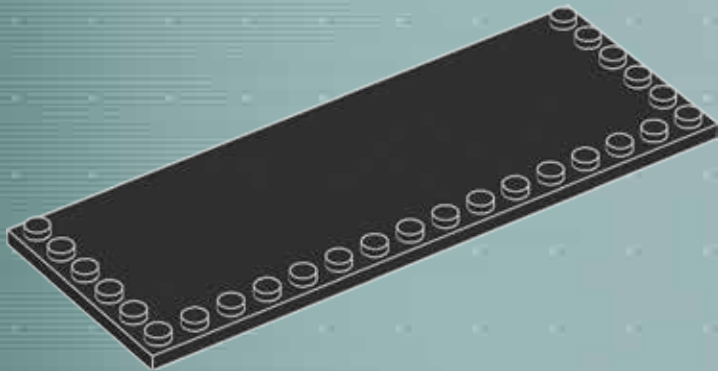

2

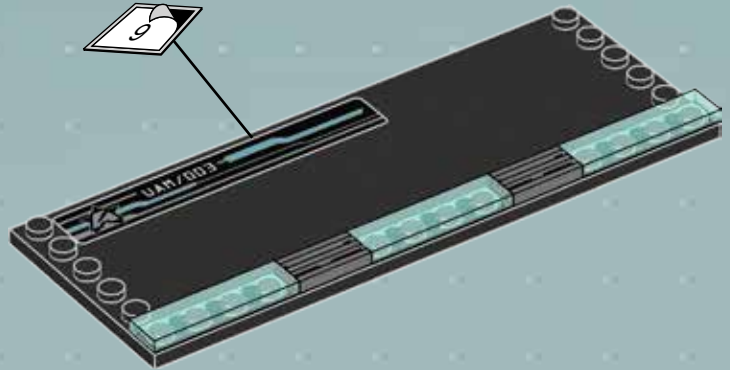

3

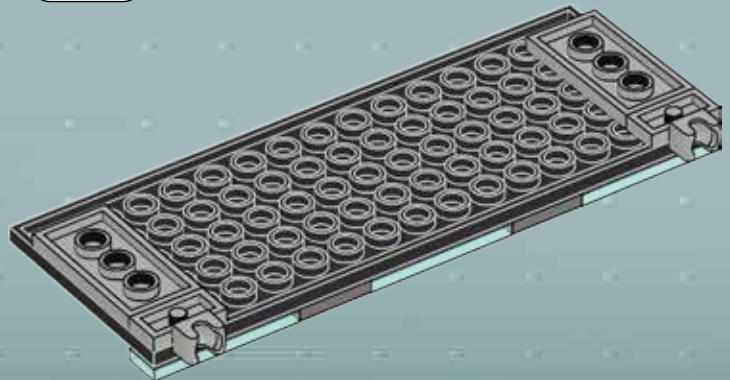



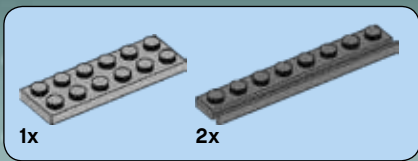

4

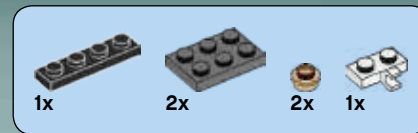
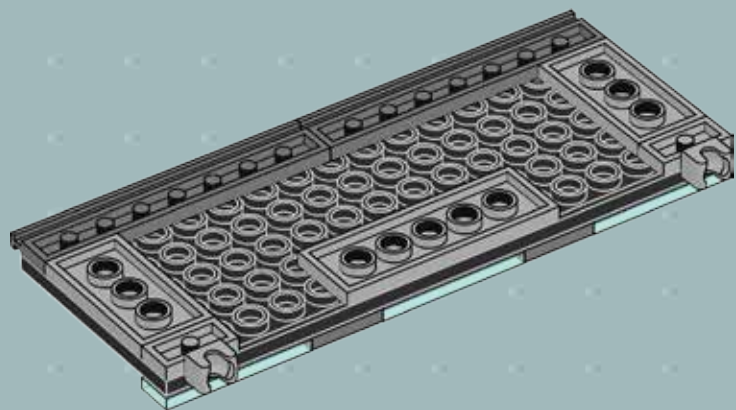

5

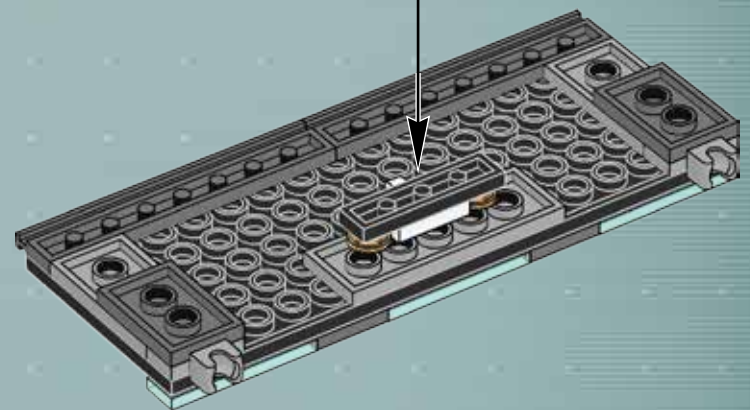
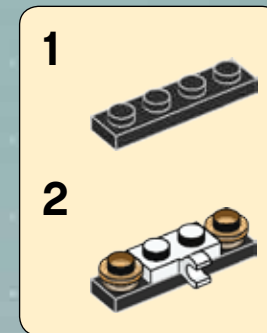

74

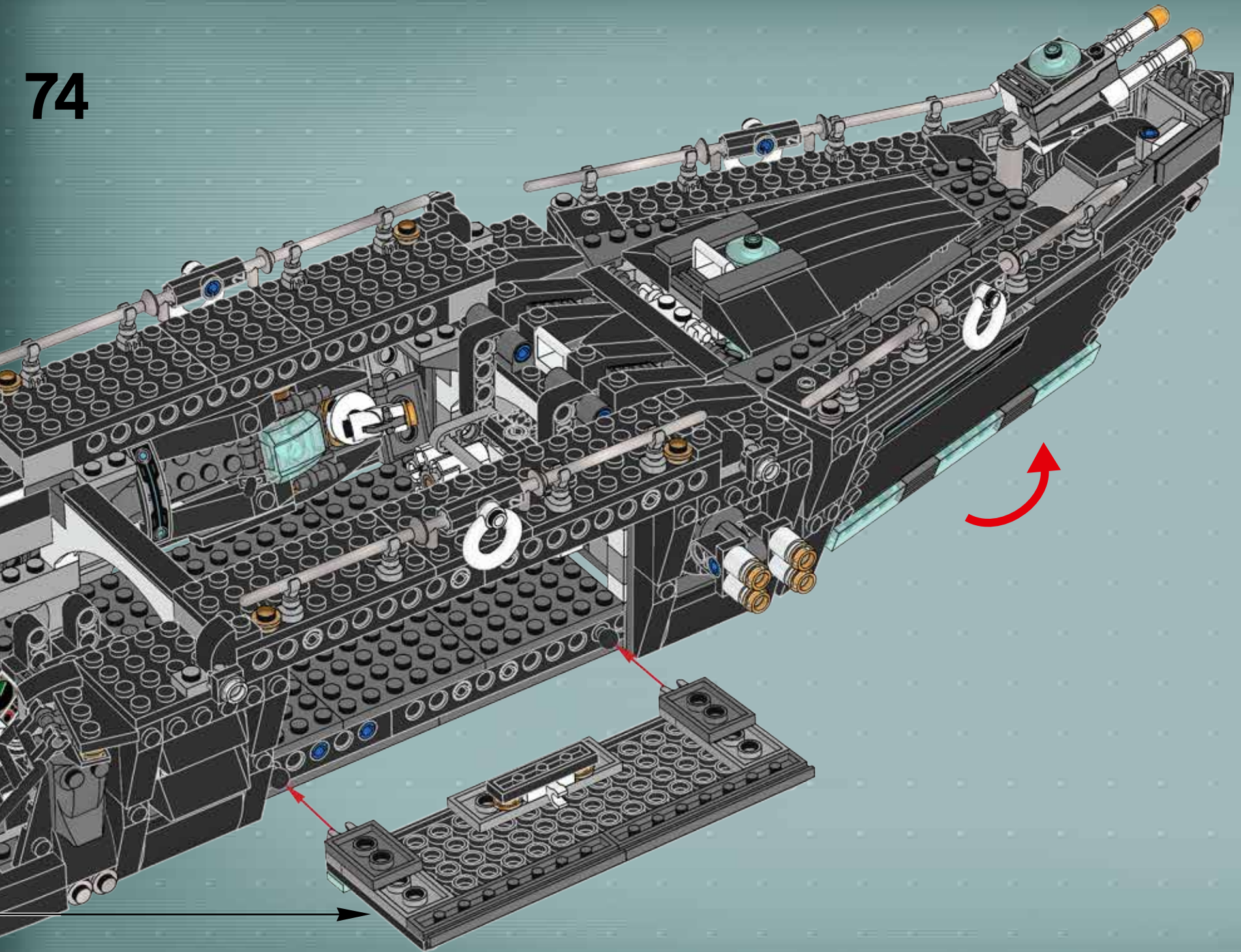

75

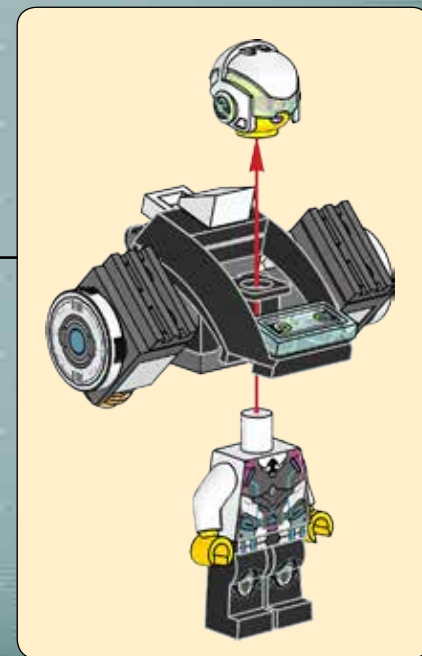
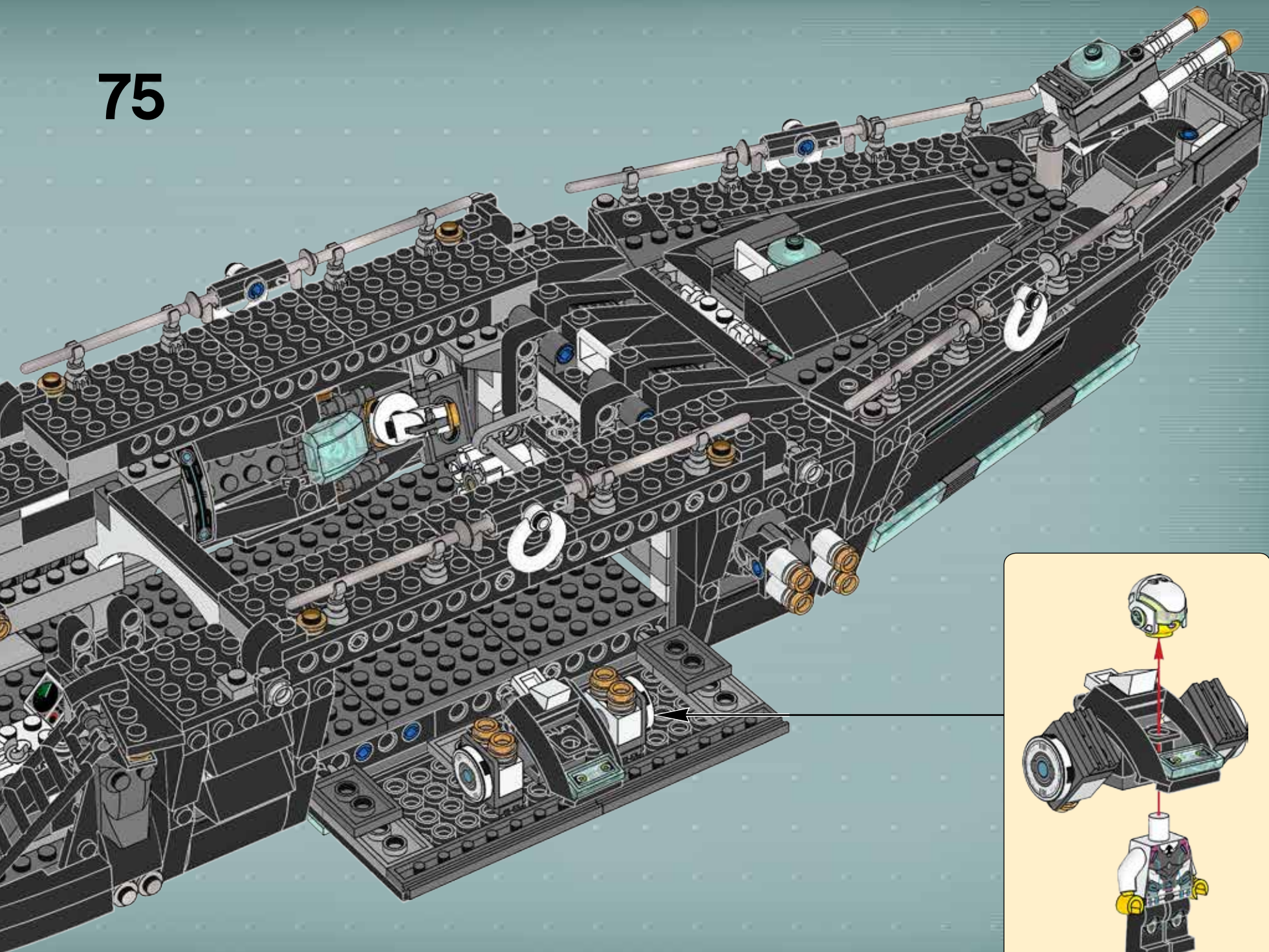

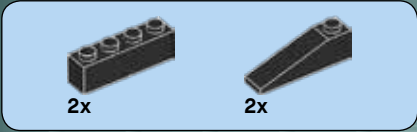

76

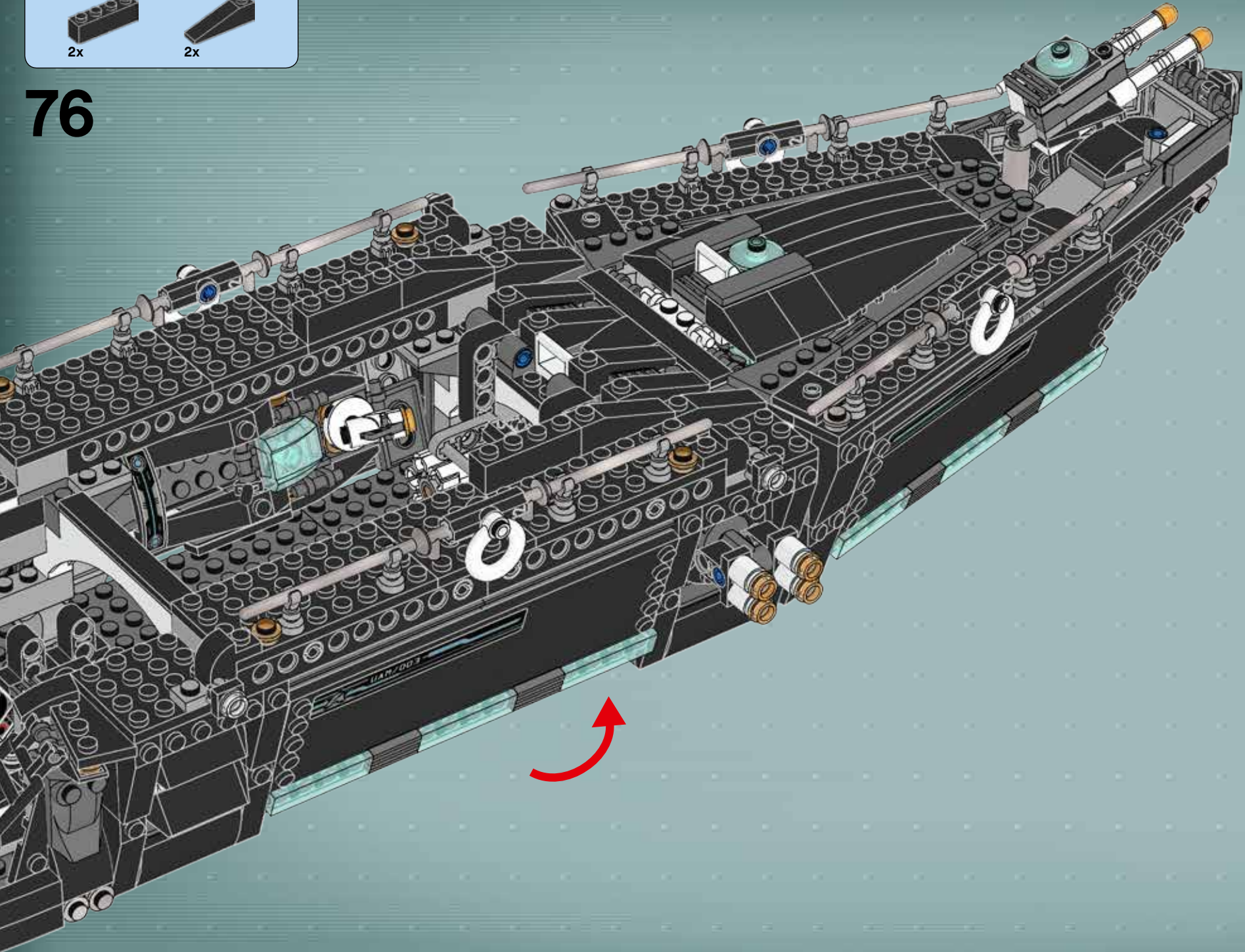

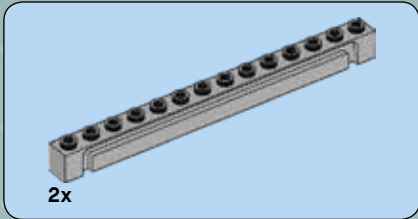
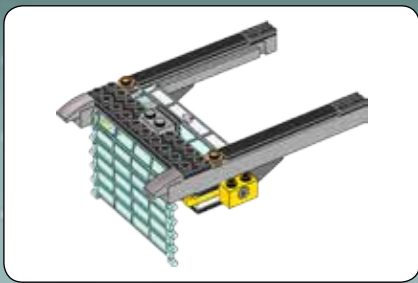

1

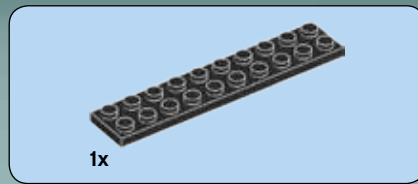
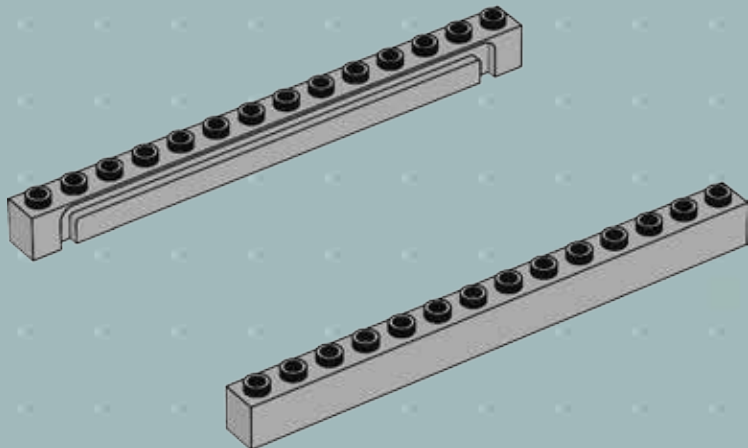

2

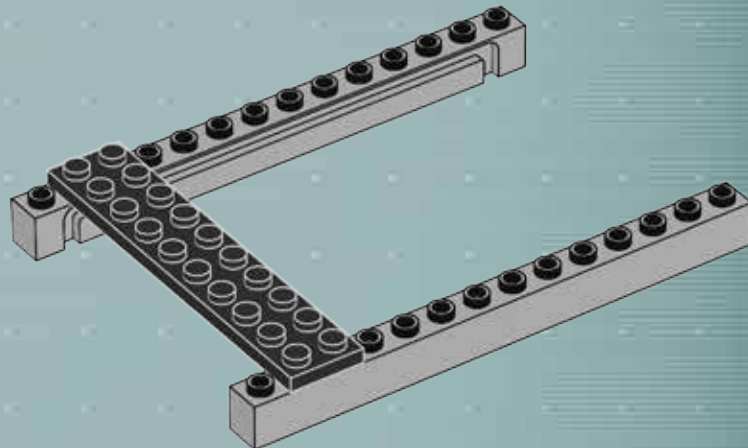

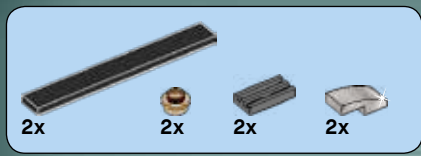

3

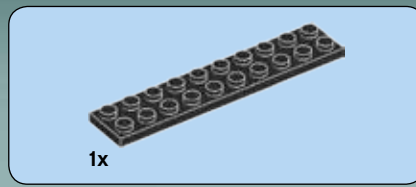
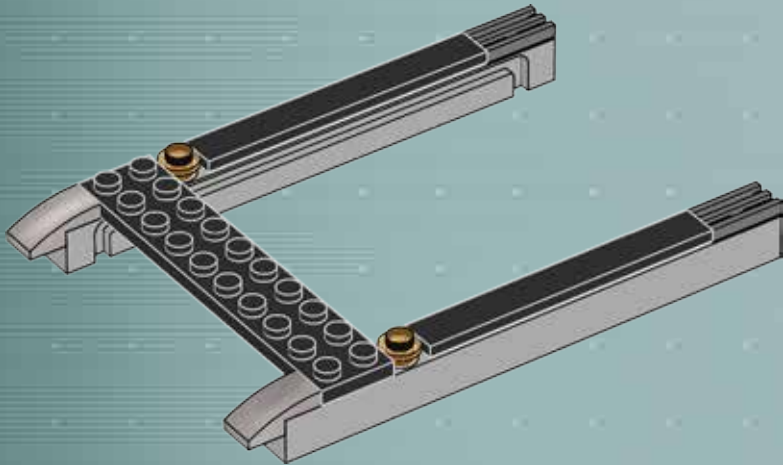

4

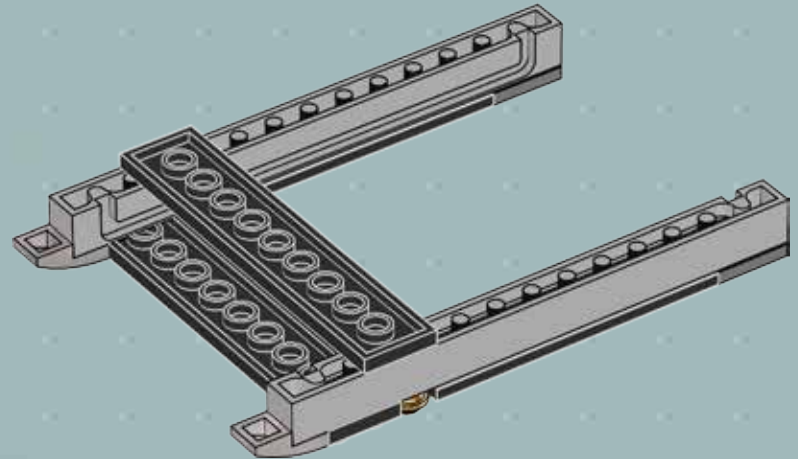



5

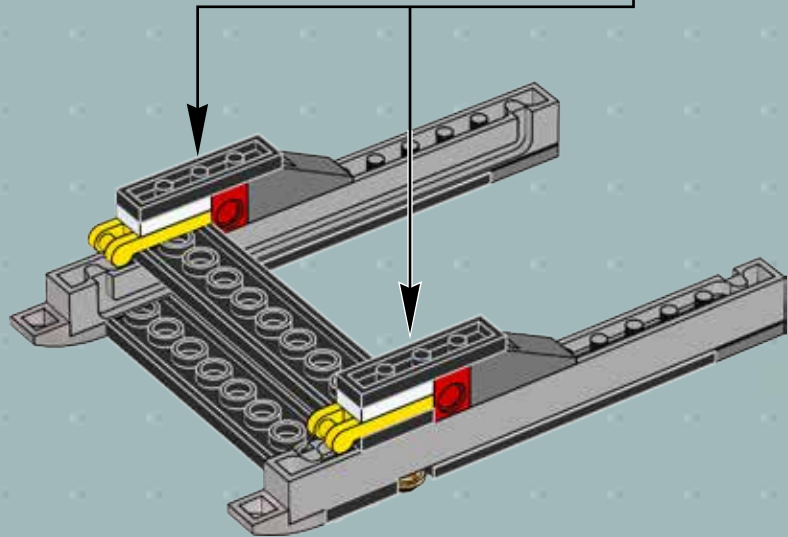
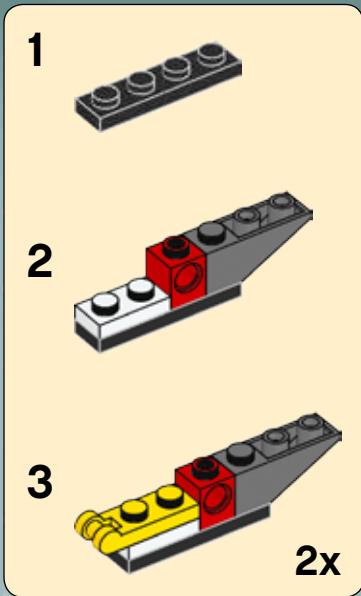

6

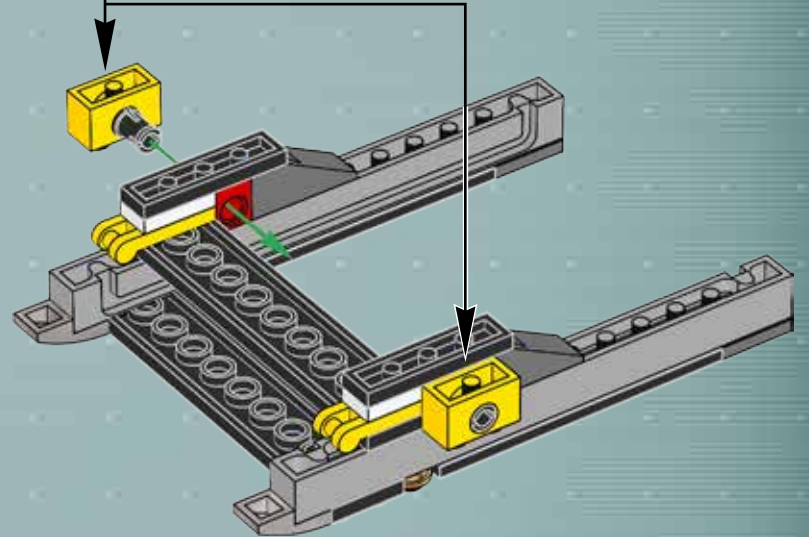
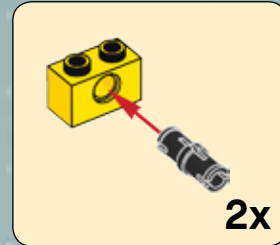

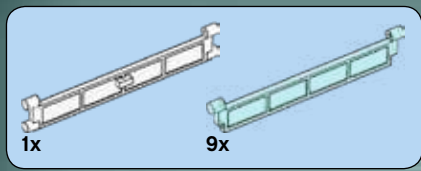

7

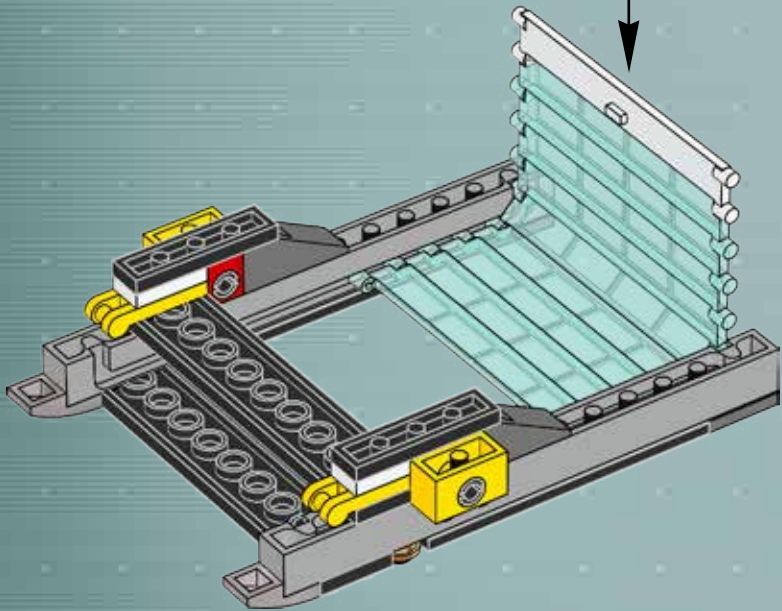
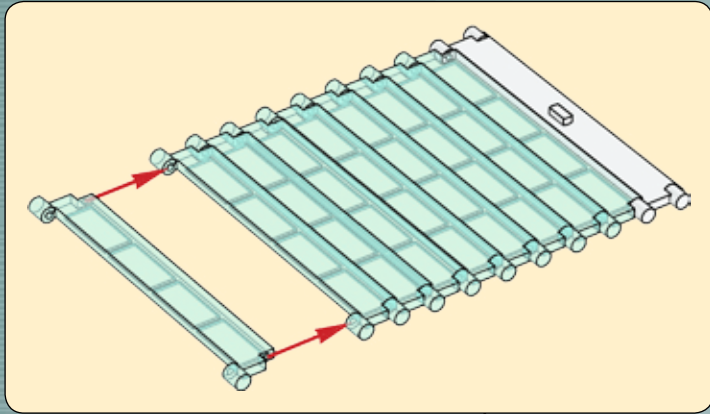

8

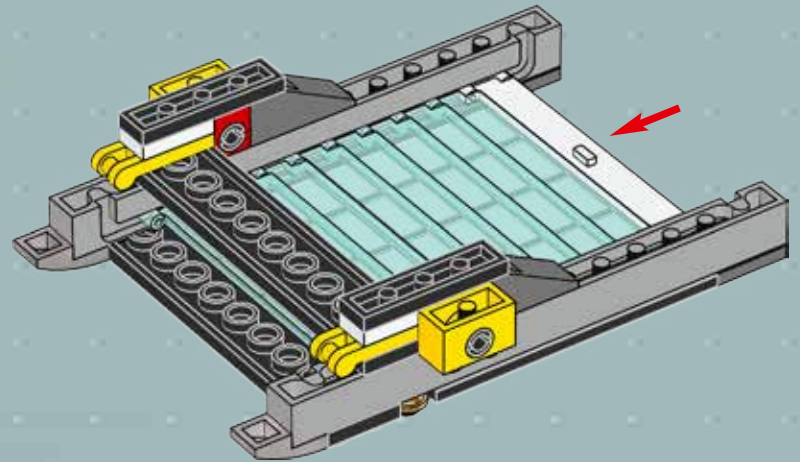





9

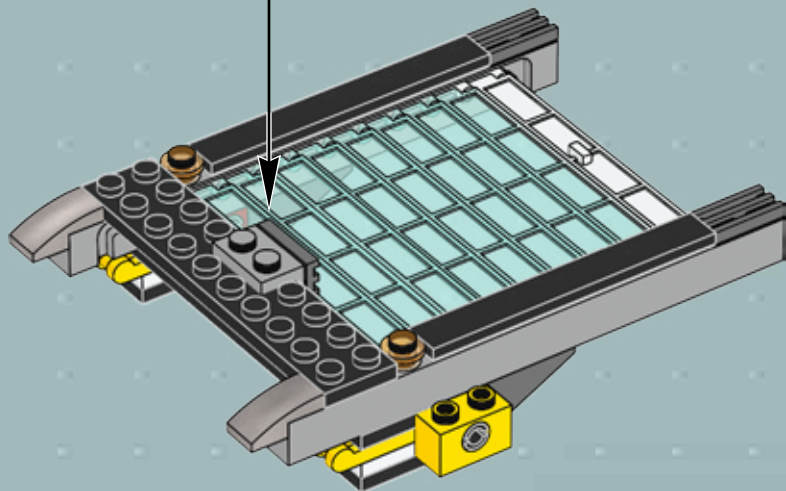
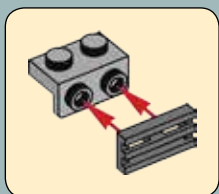

10

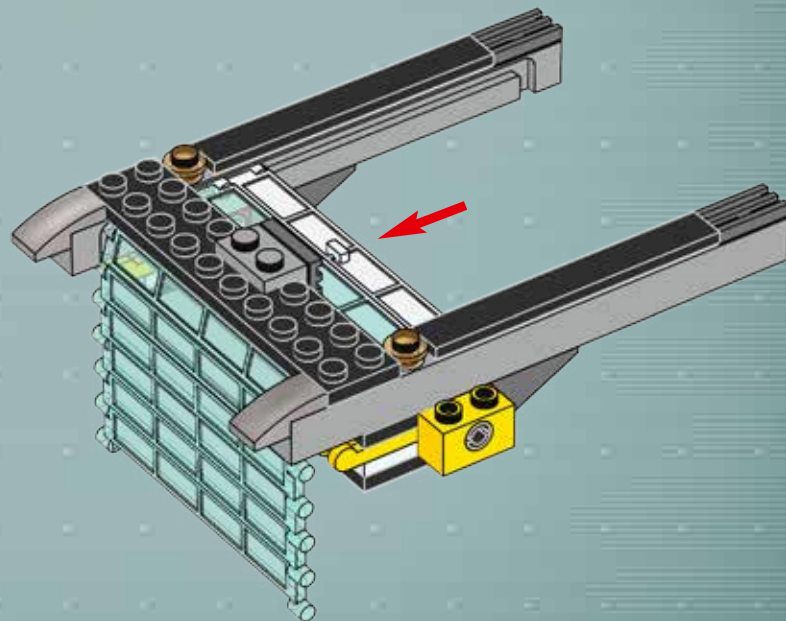

77

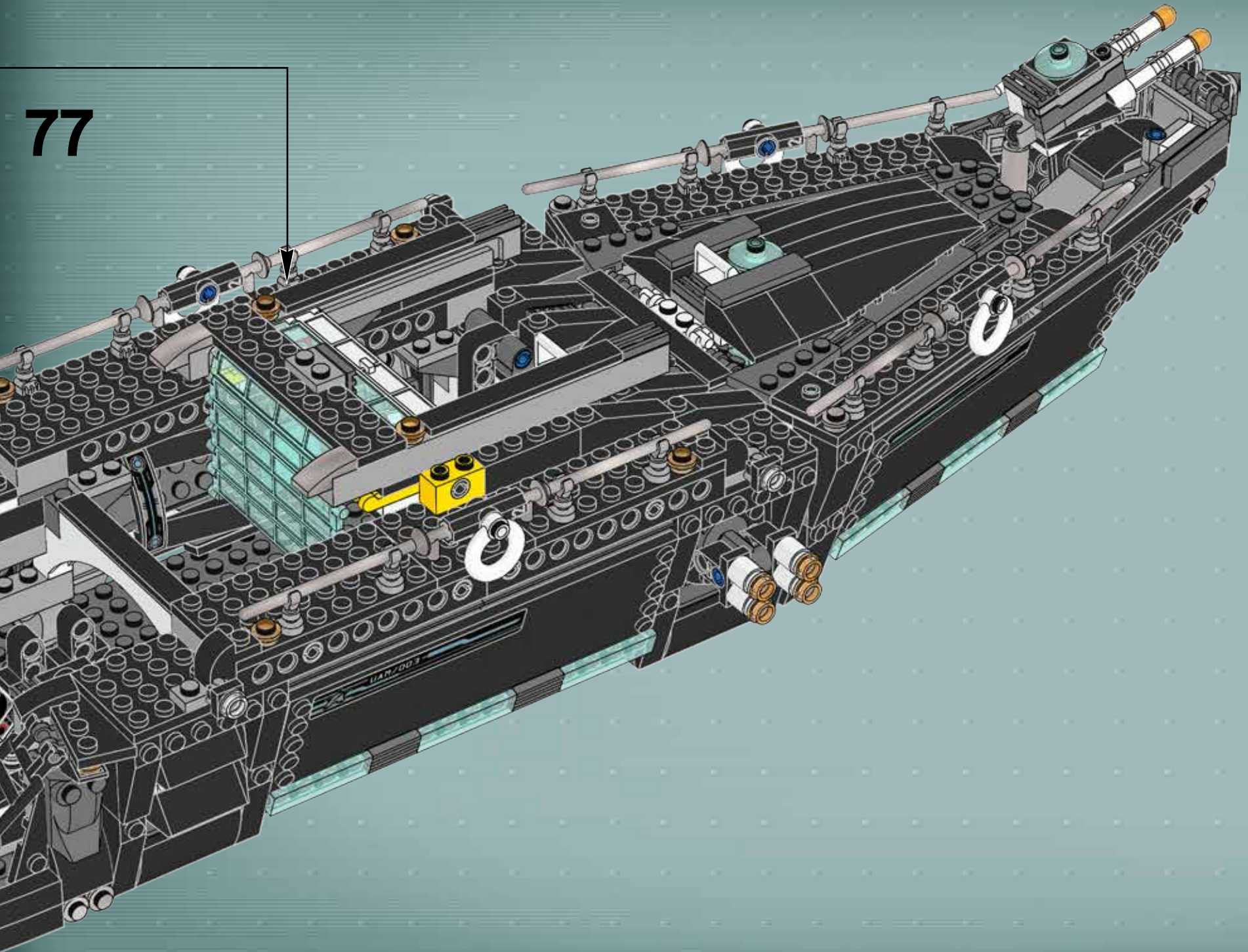

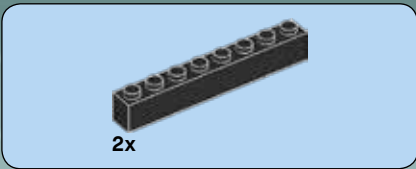

78

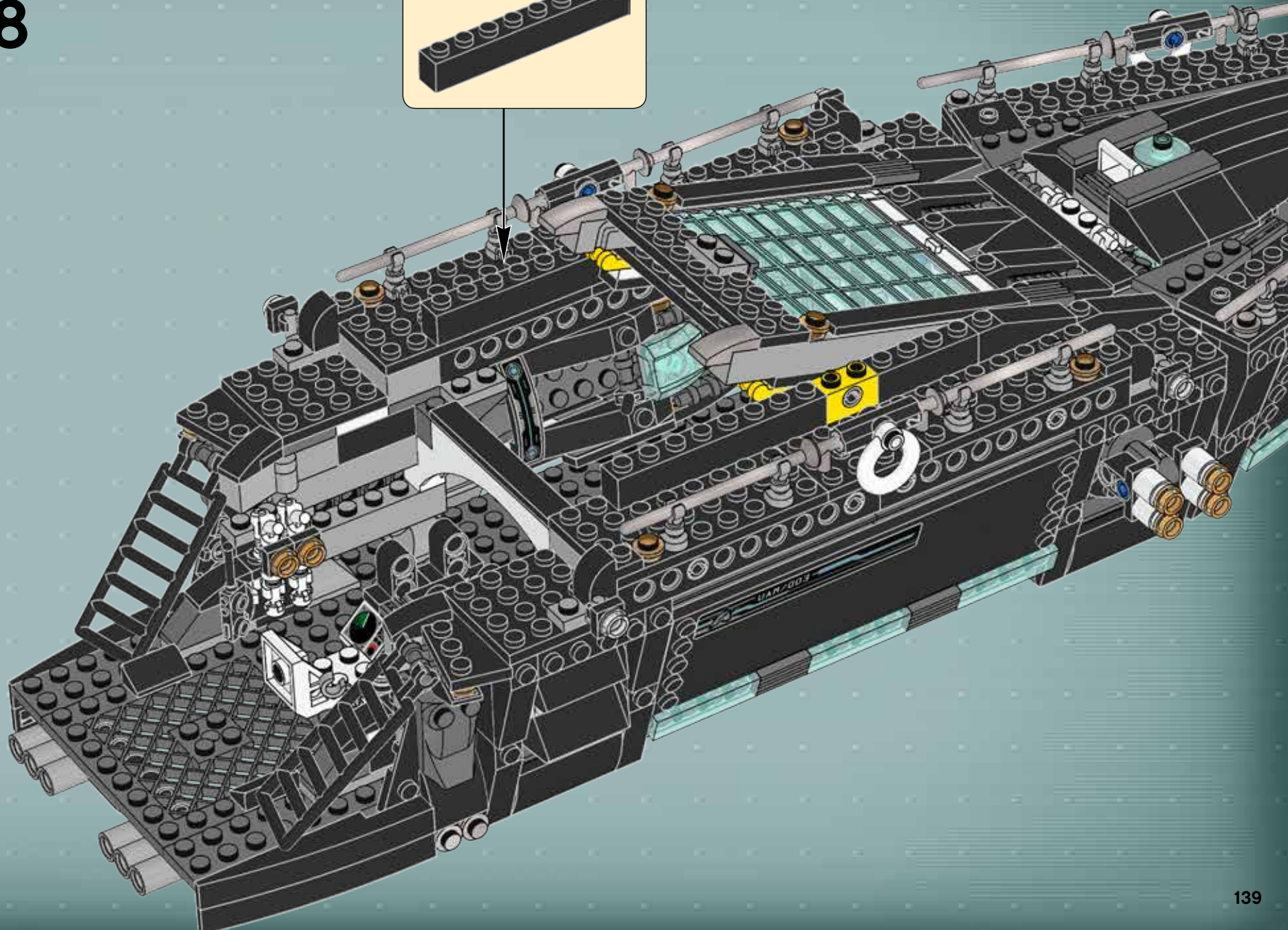
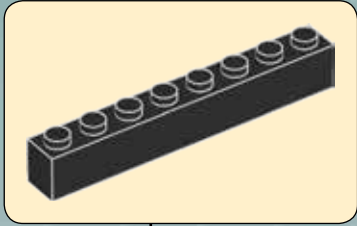

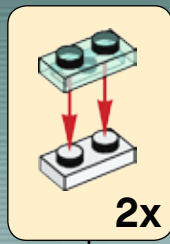
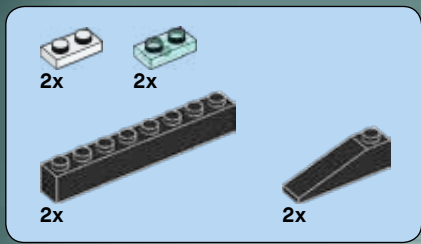

79

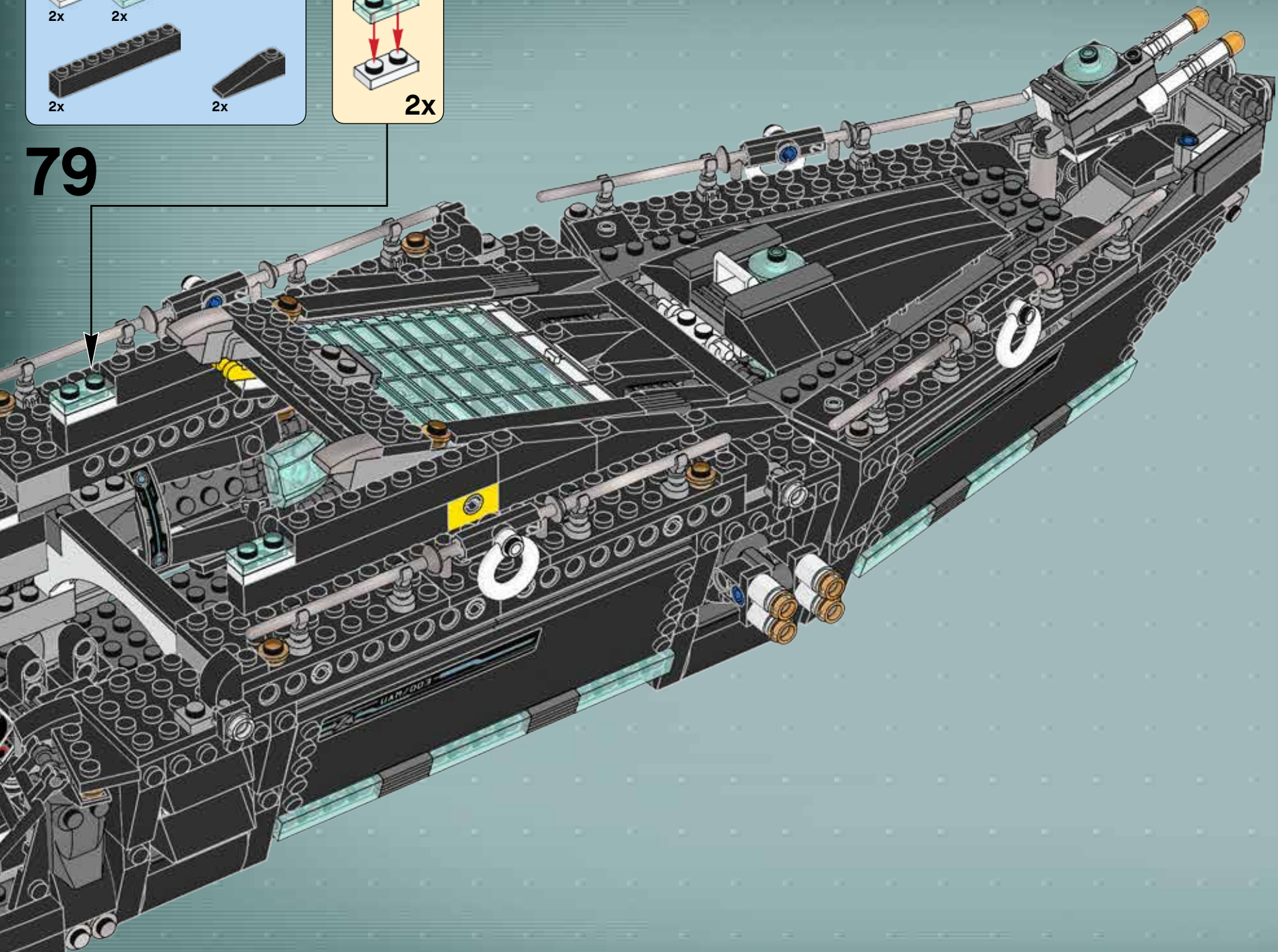

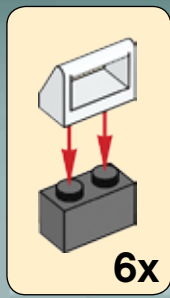
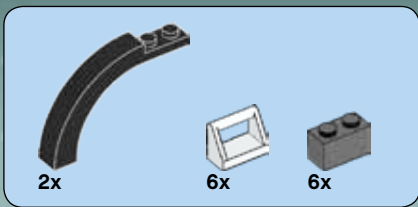

80

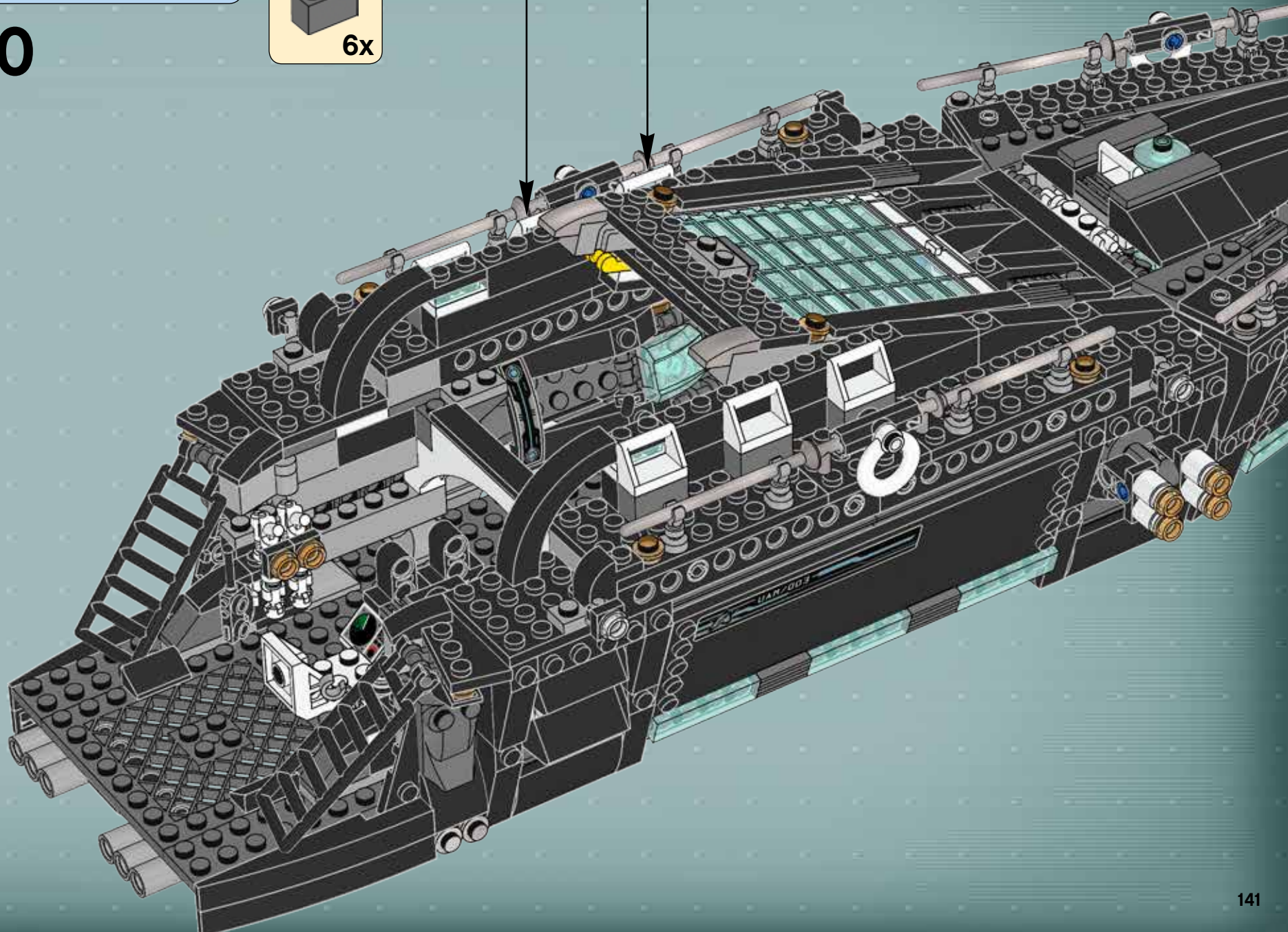

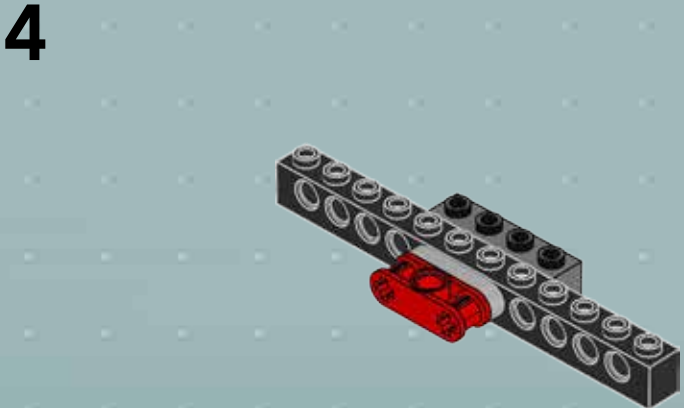
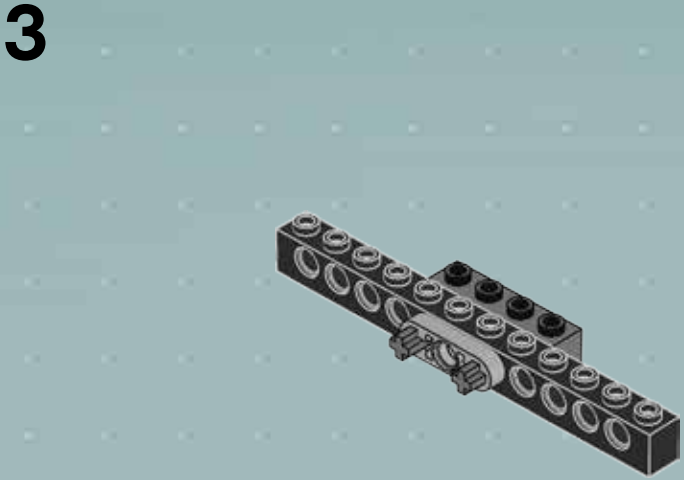
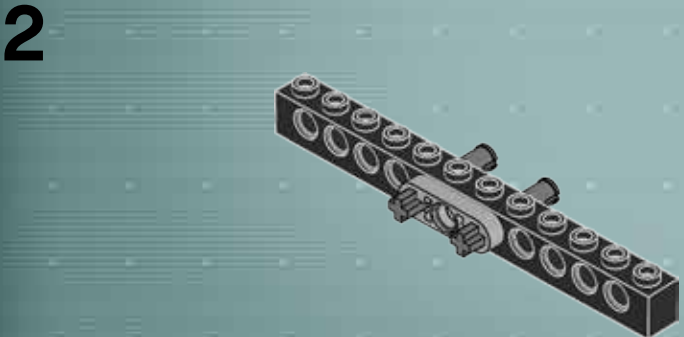
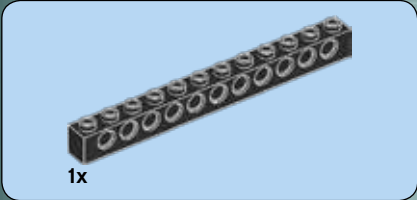
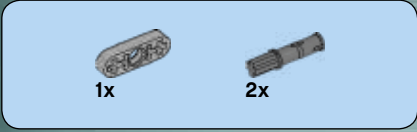
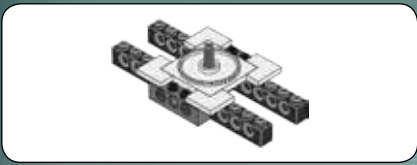

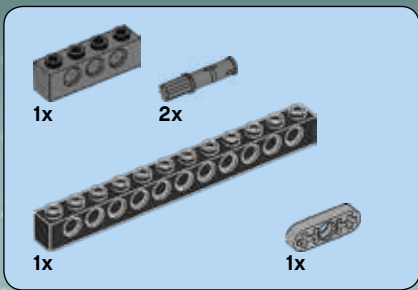

5

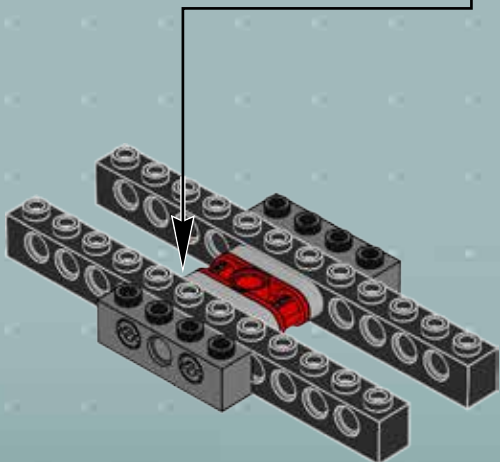
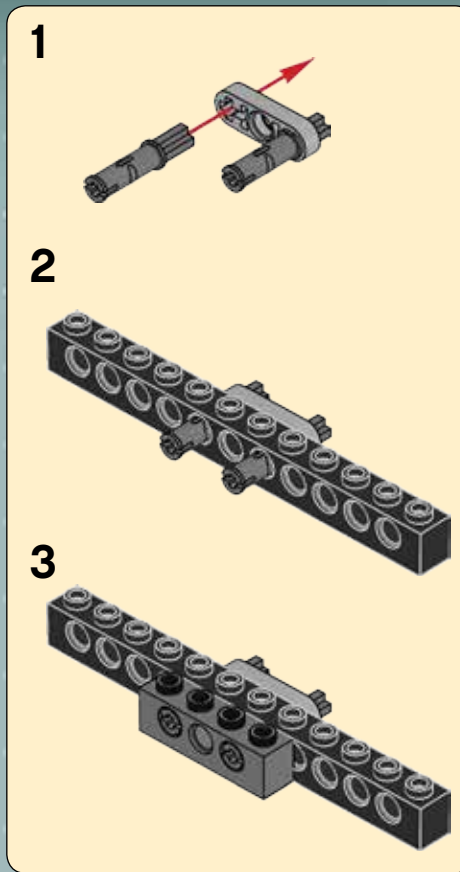

6



7

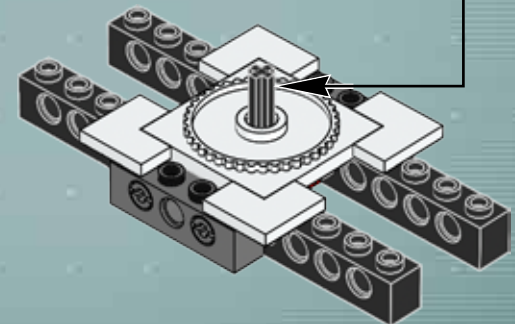
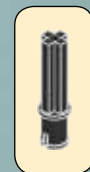

81

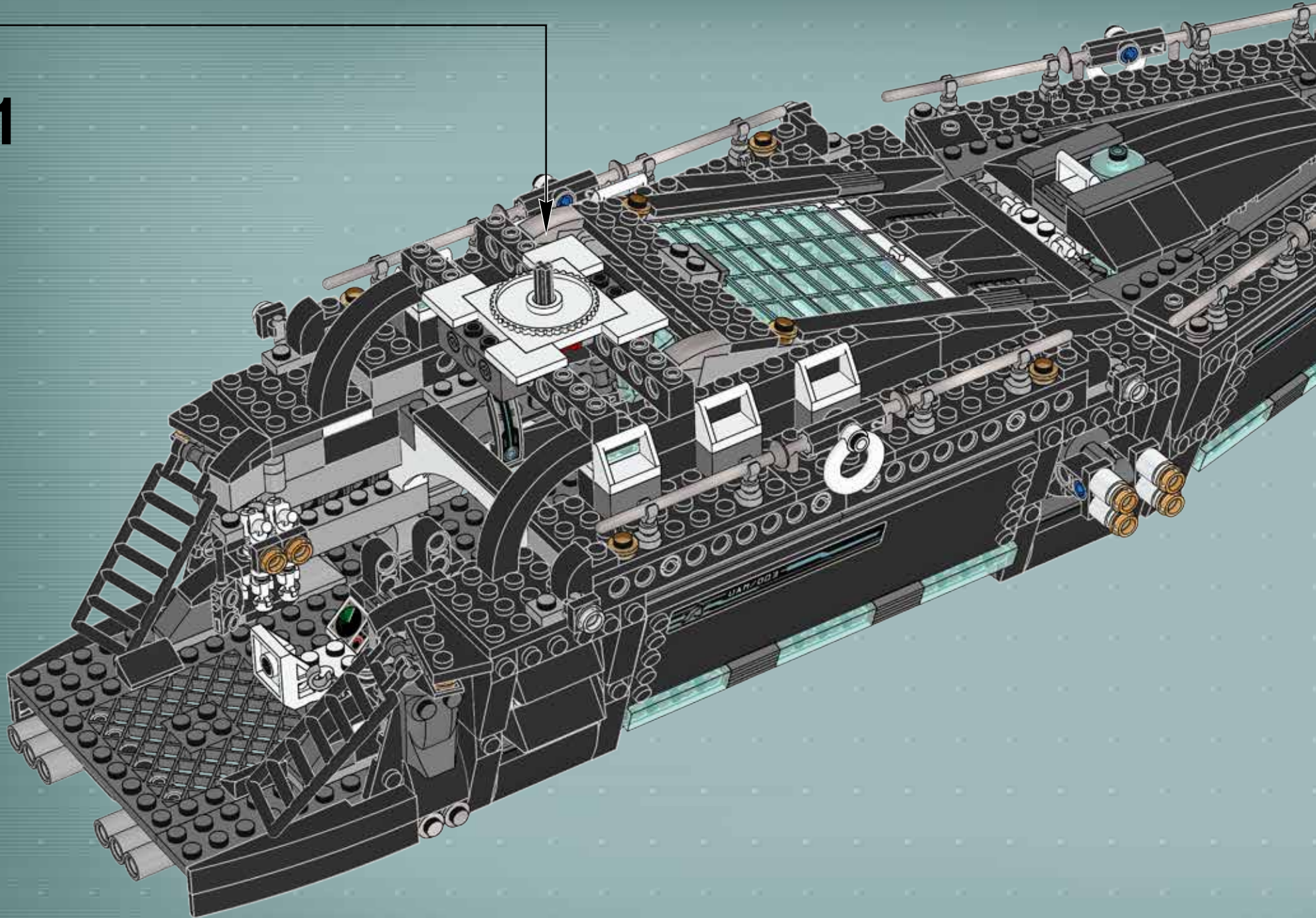





82

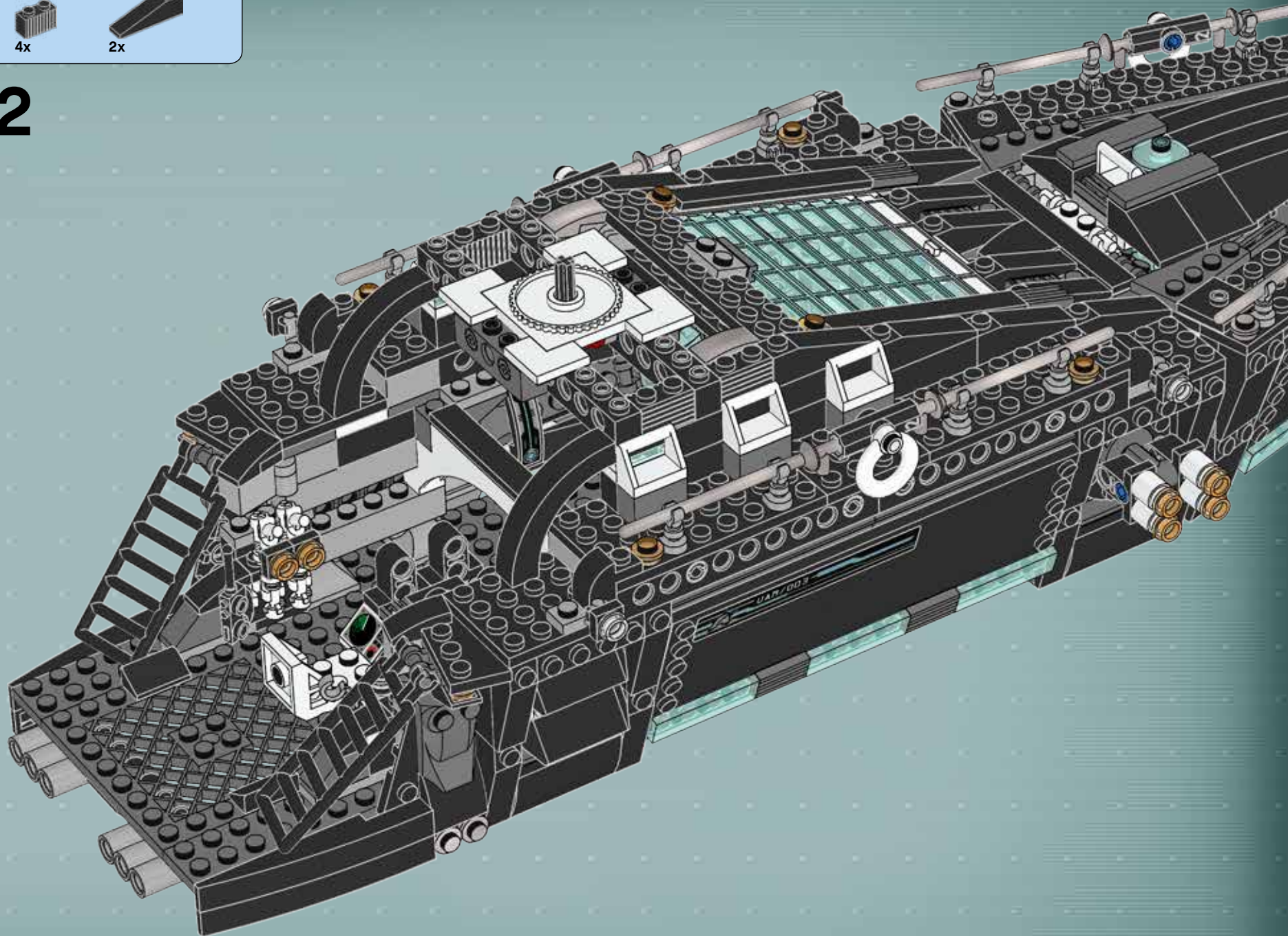

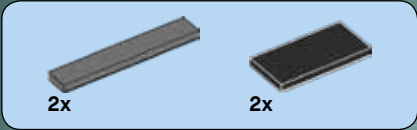

83

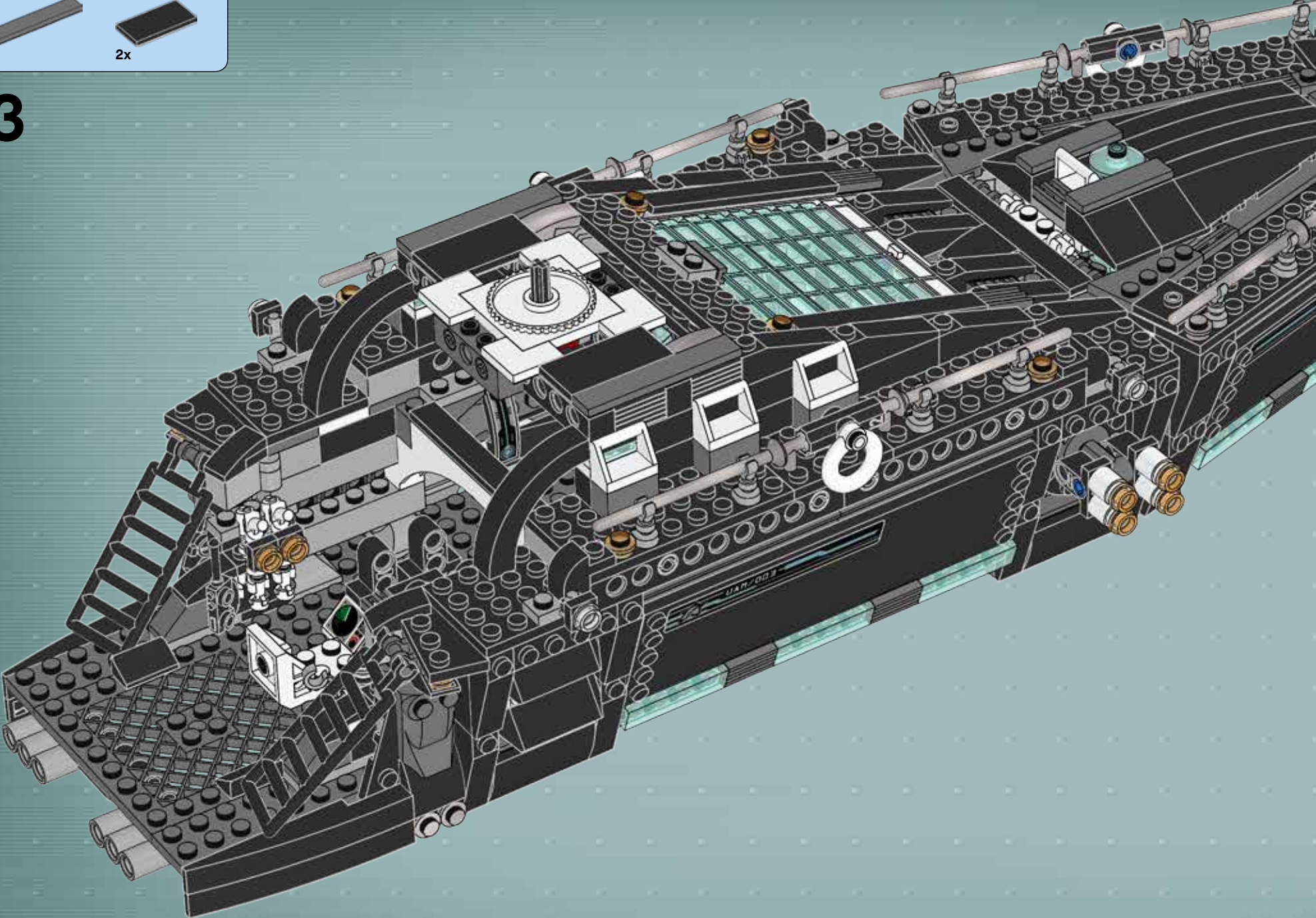

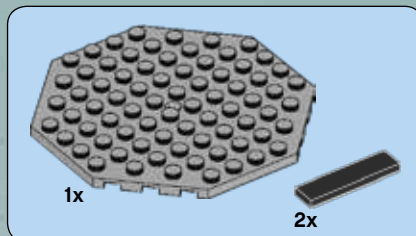
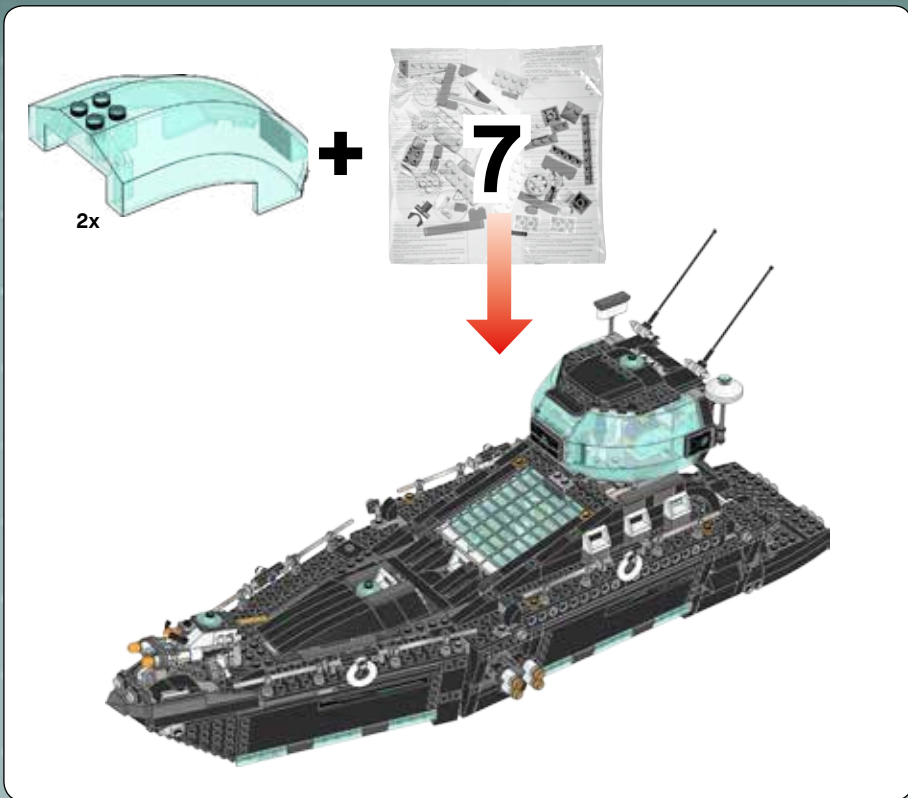

1

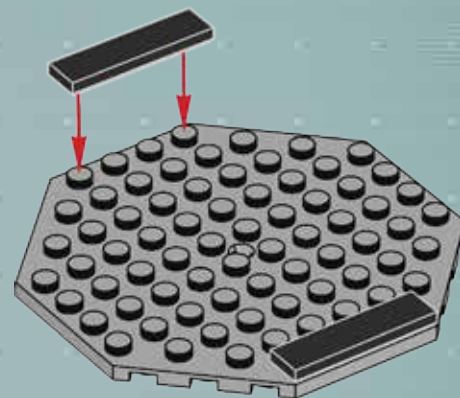

2

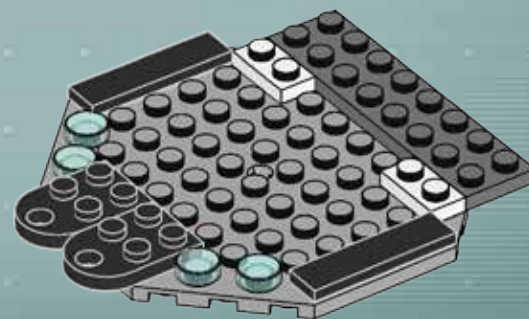

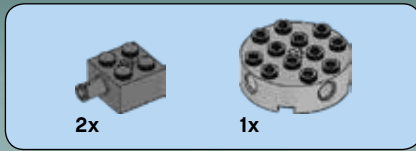
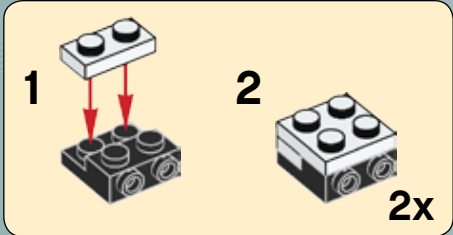
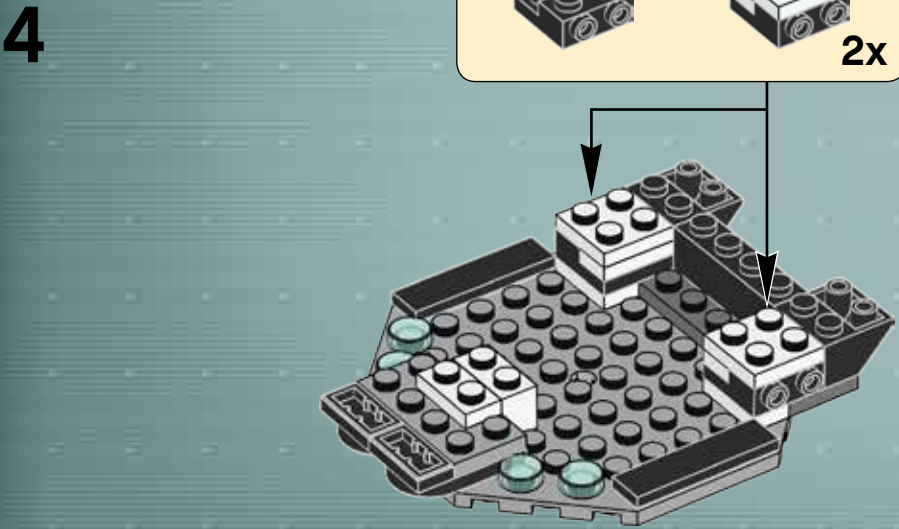
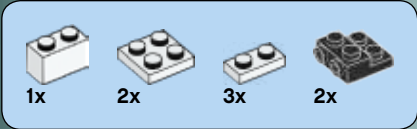
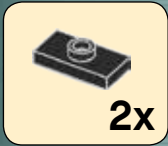
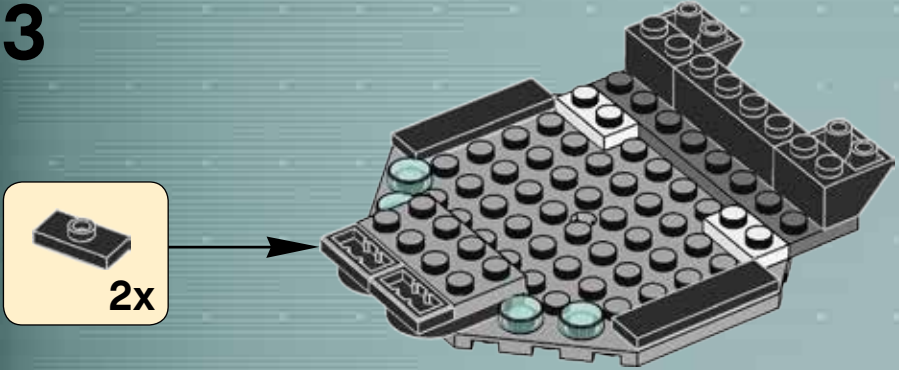
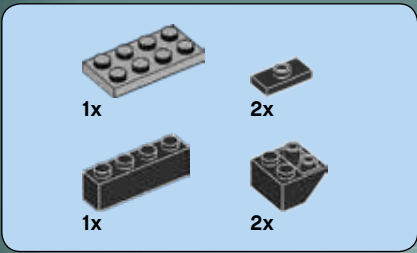

**5**

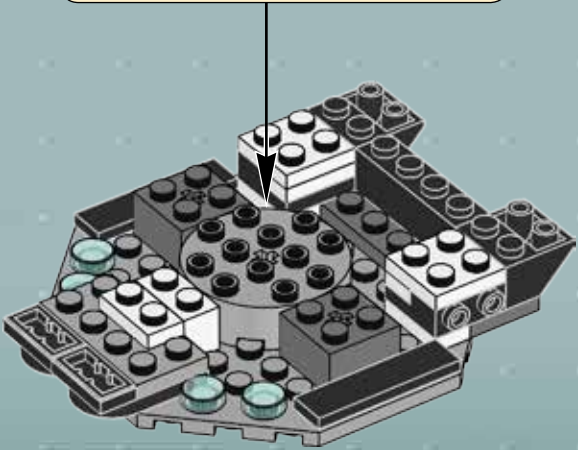
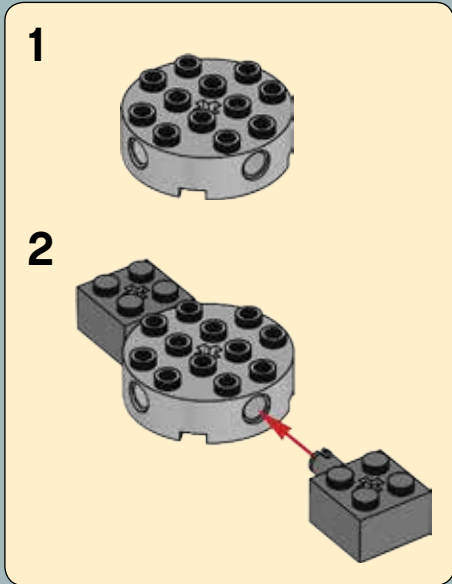

84

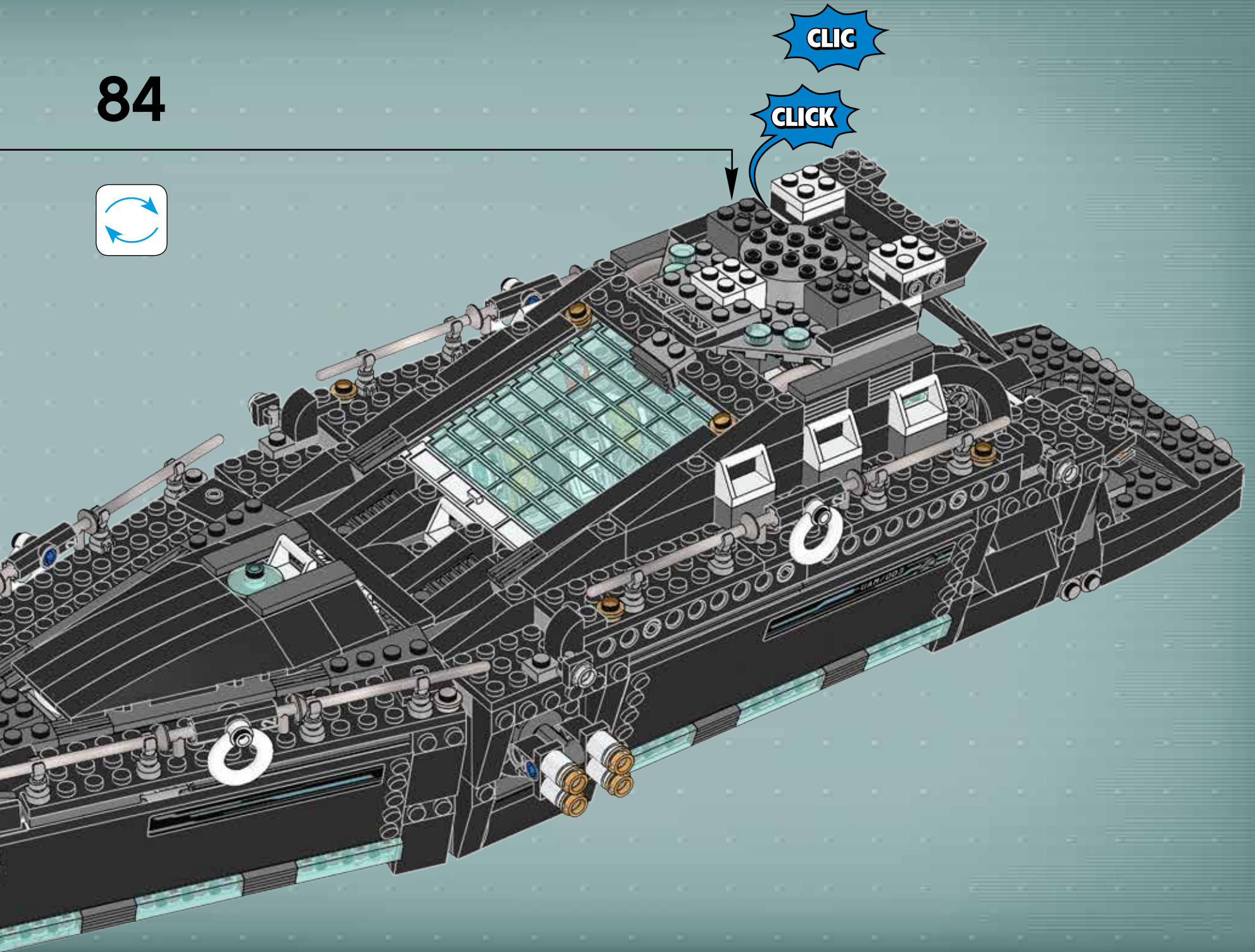

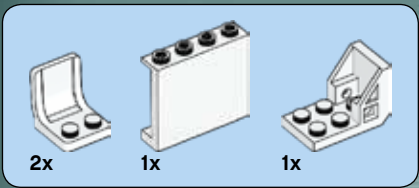

85

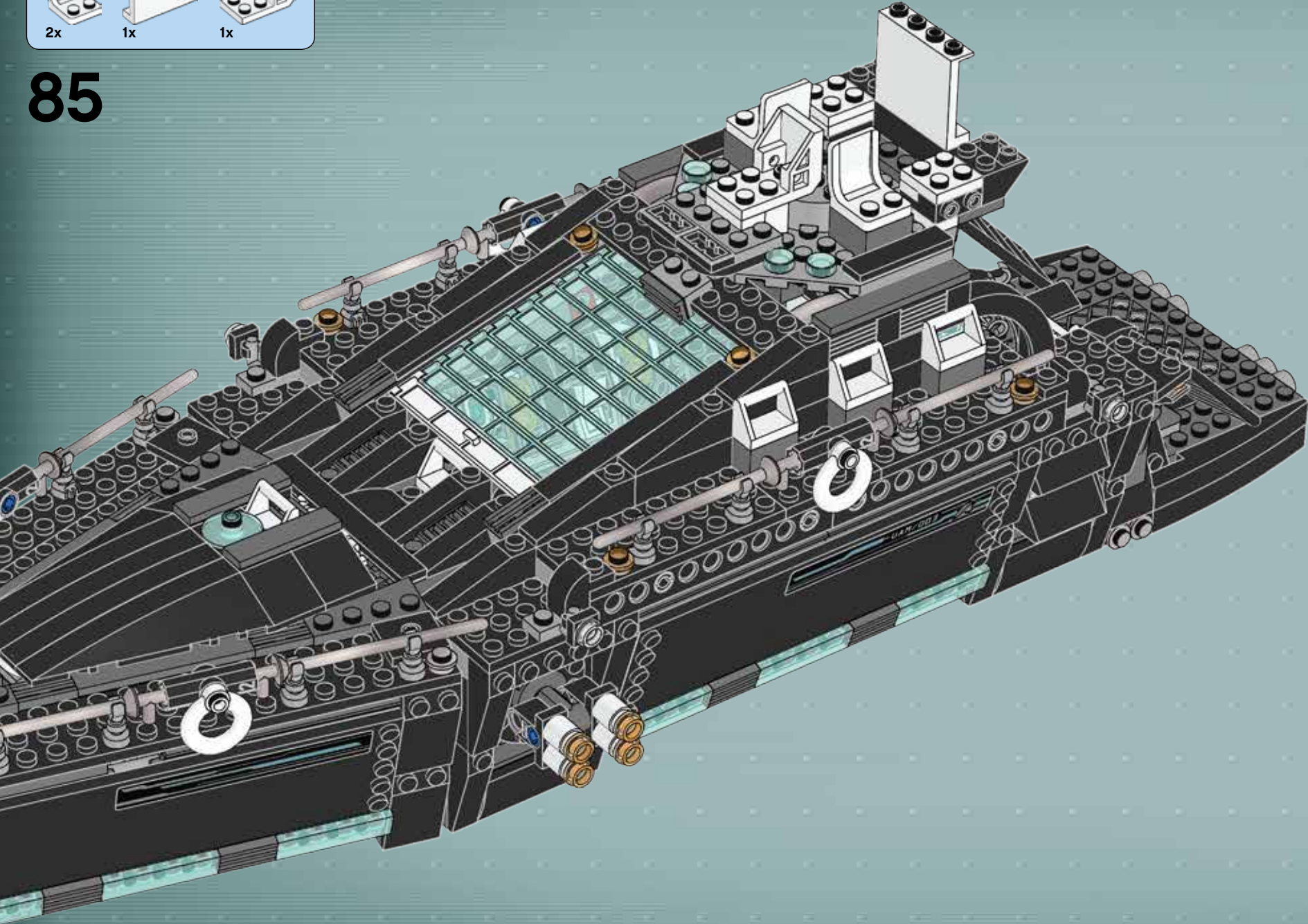

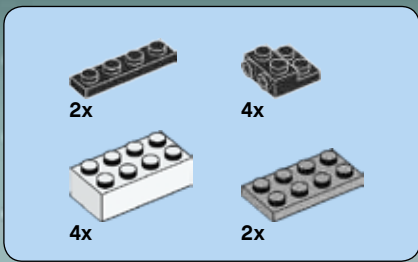

86

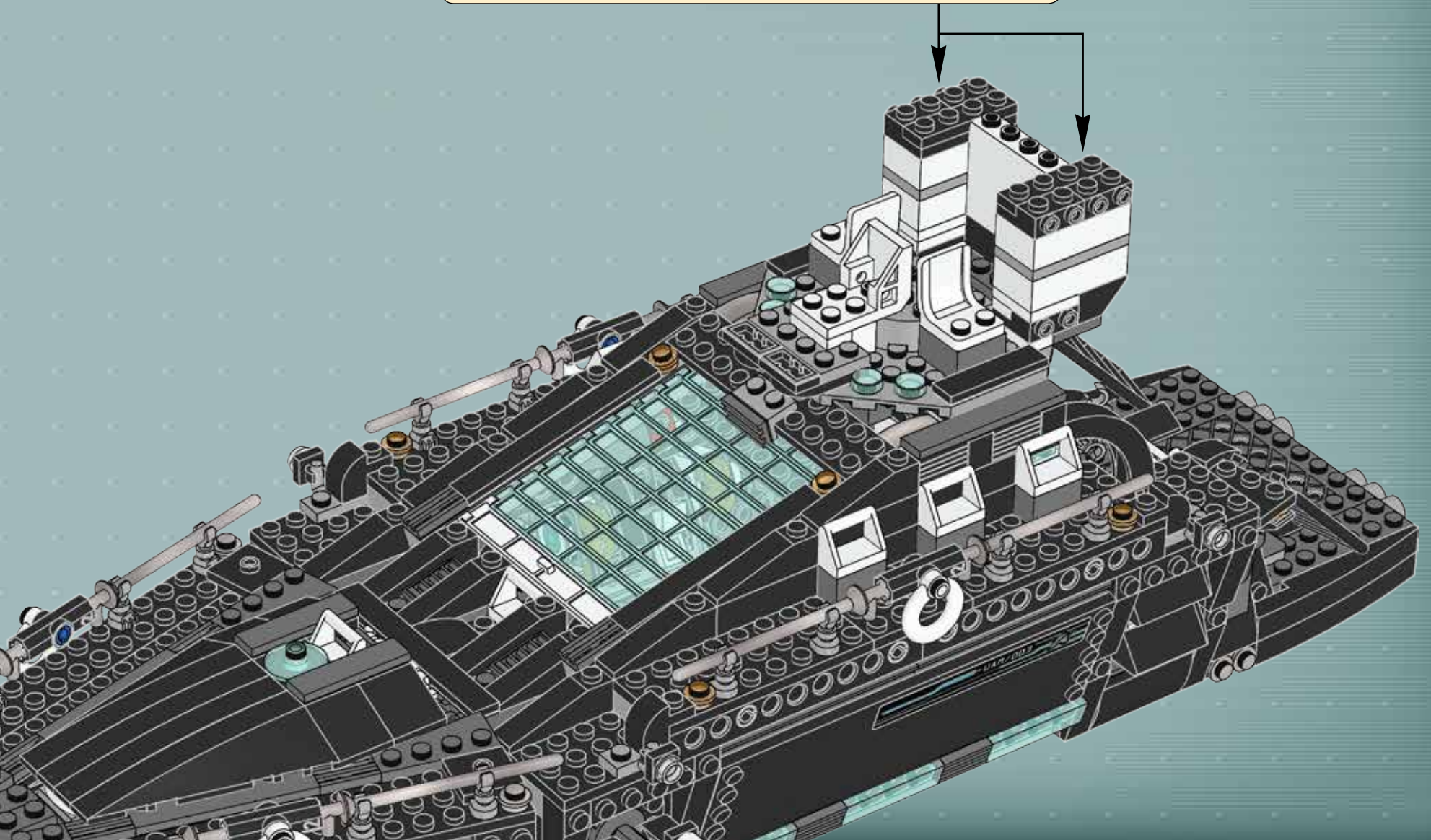
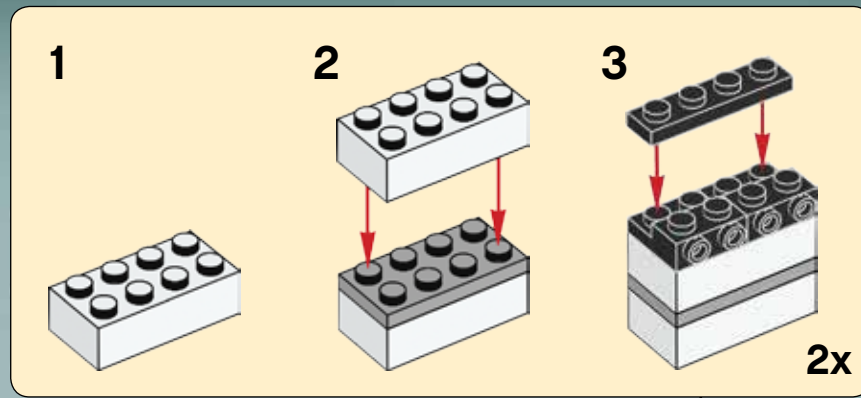

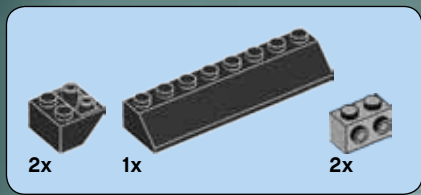

87

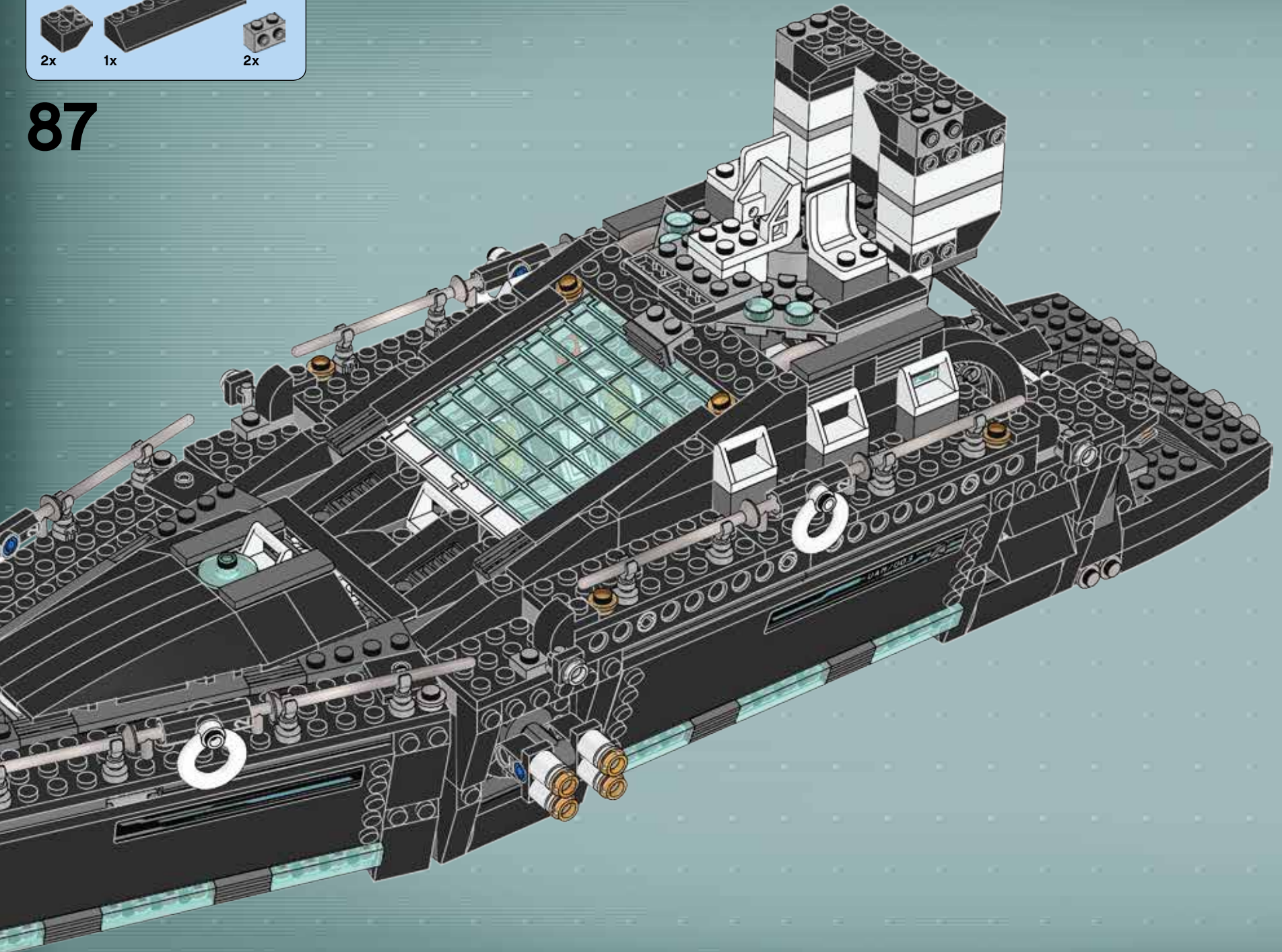



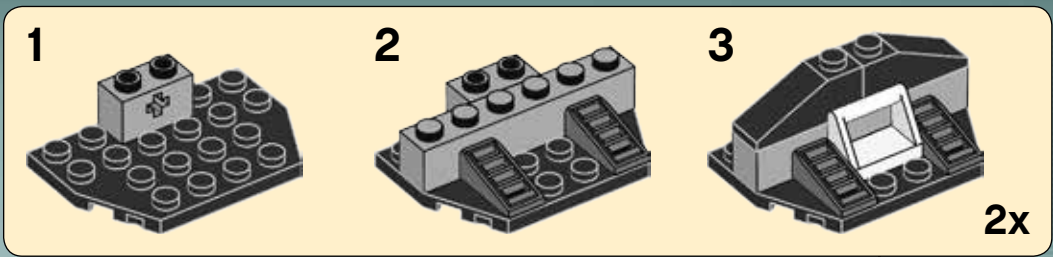
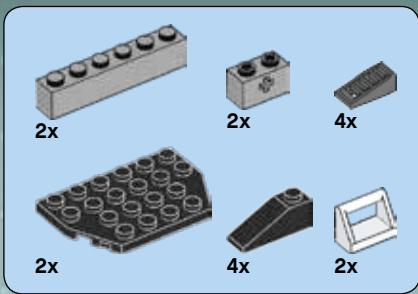

88

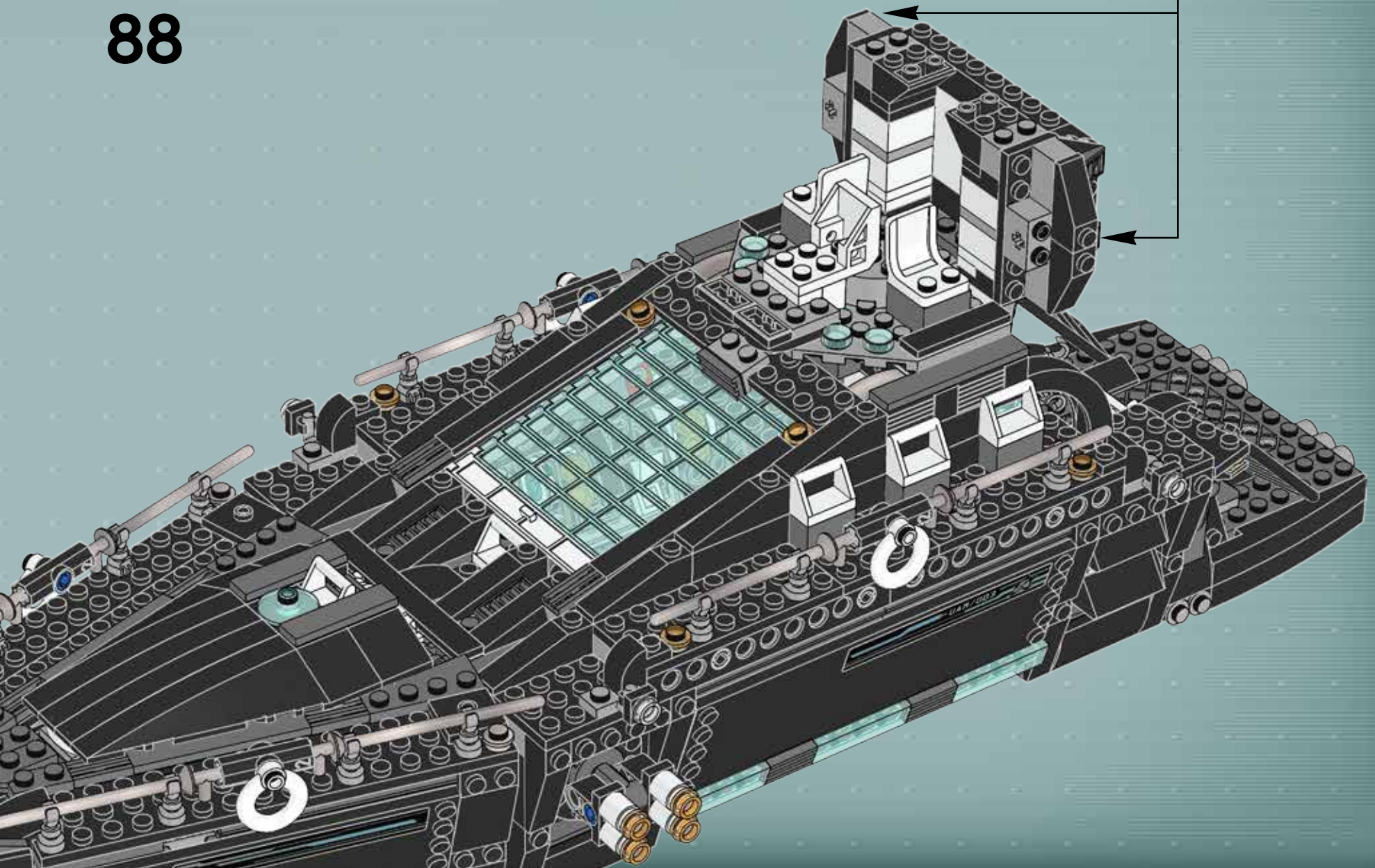



2x

89

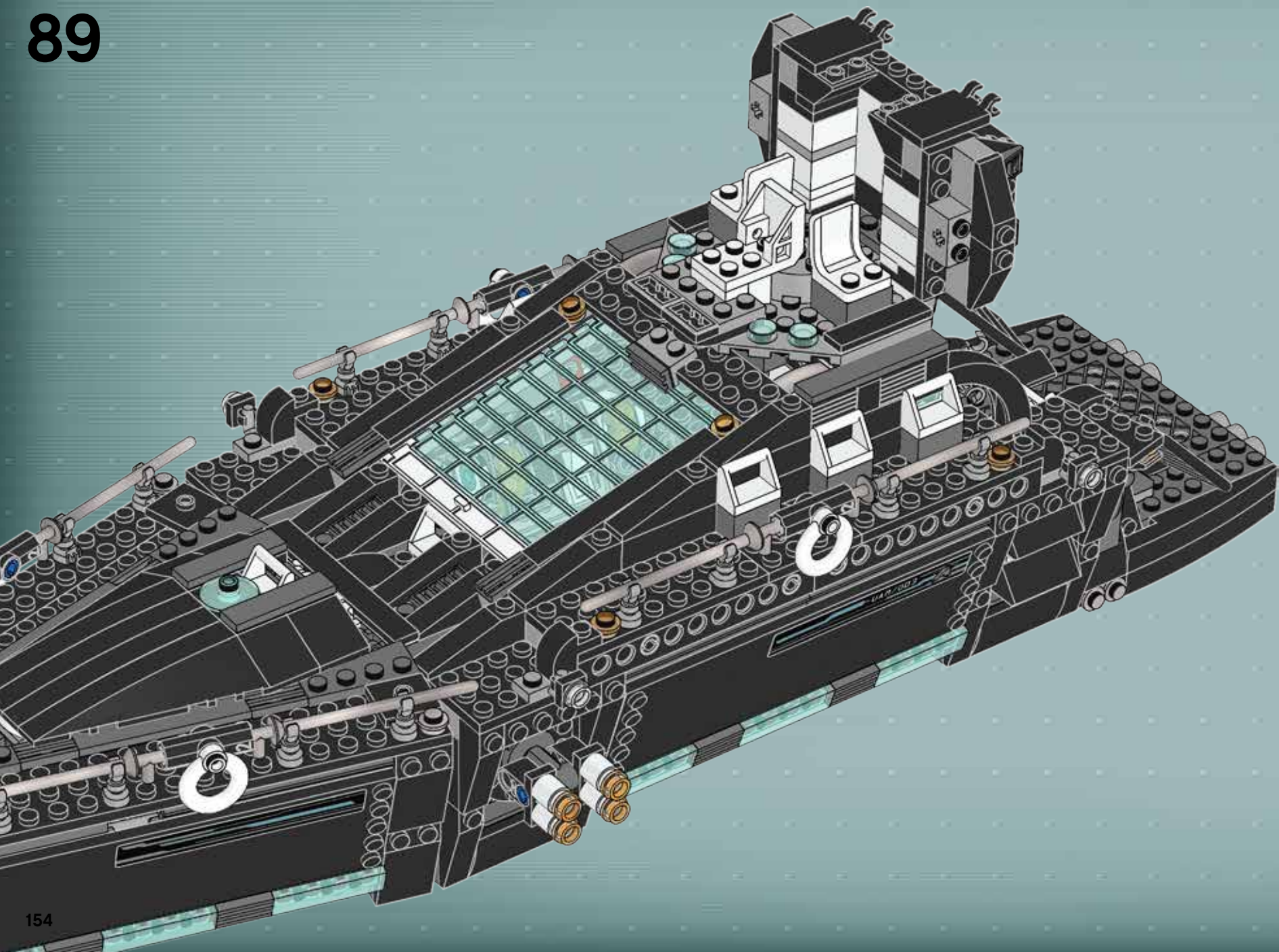

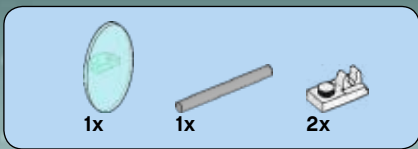

90

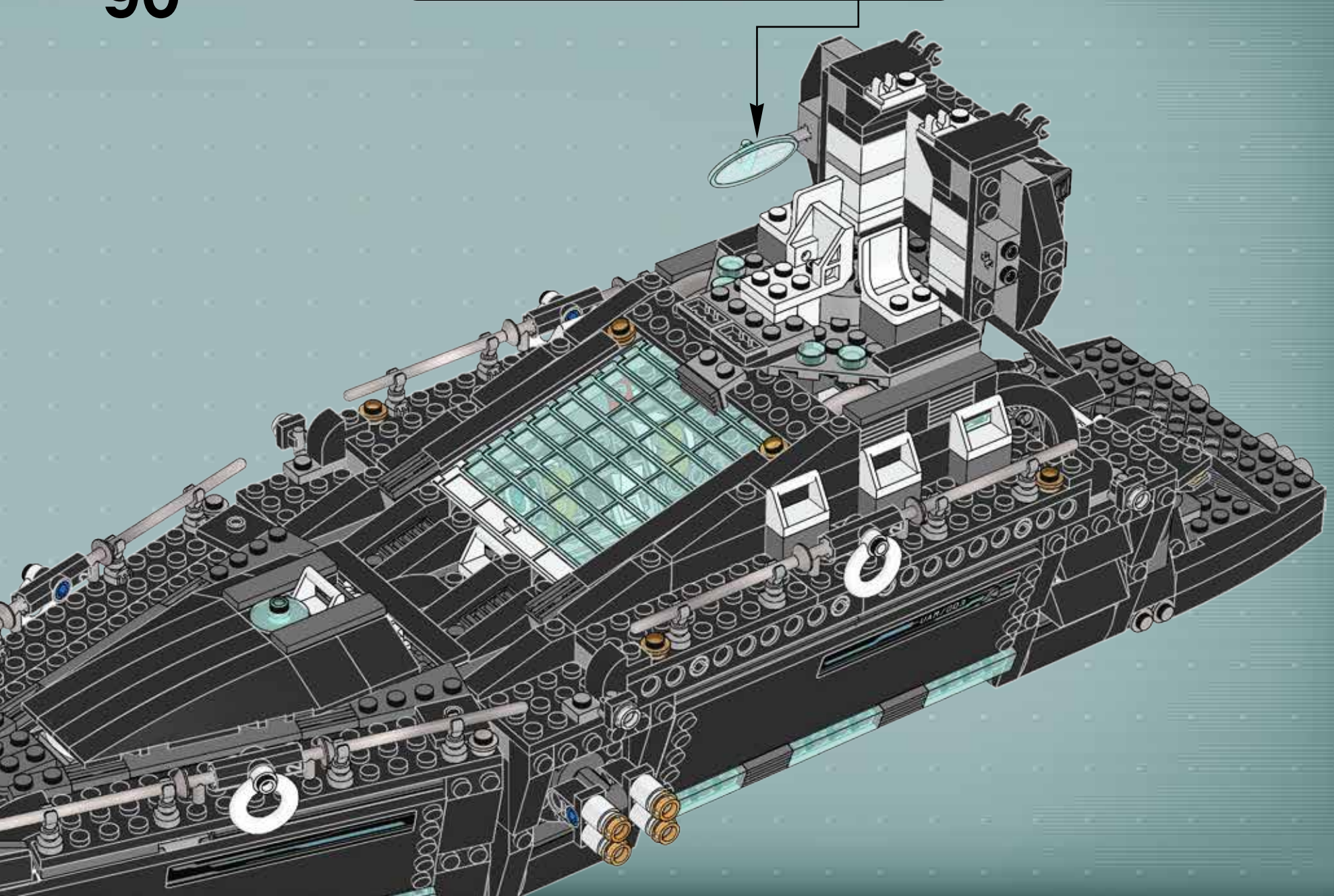
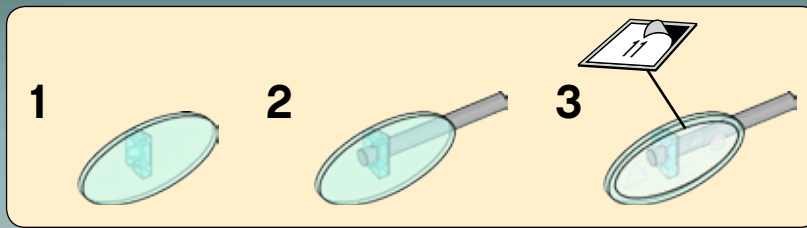

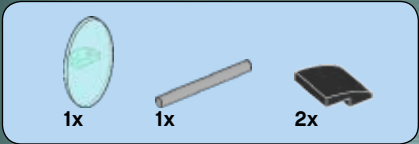

91

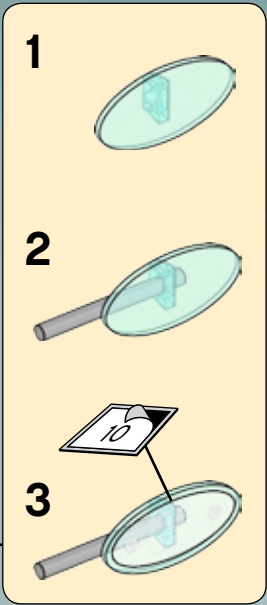
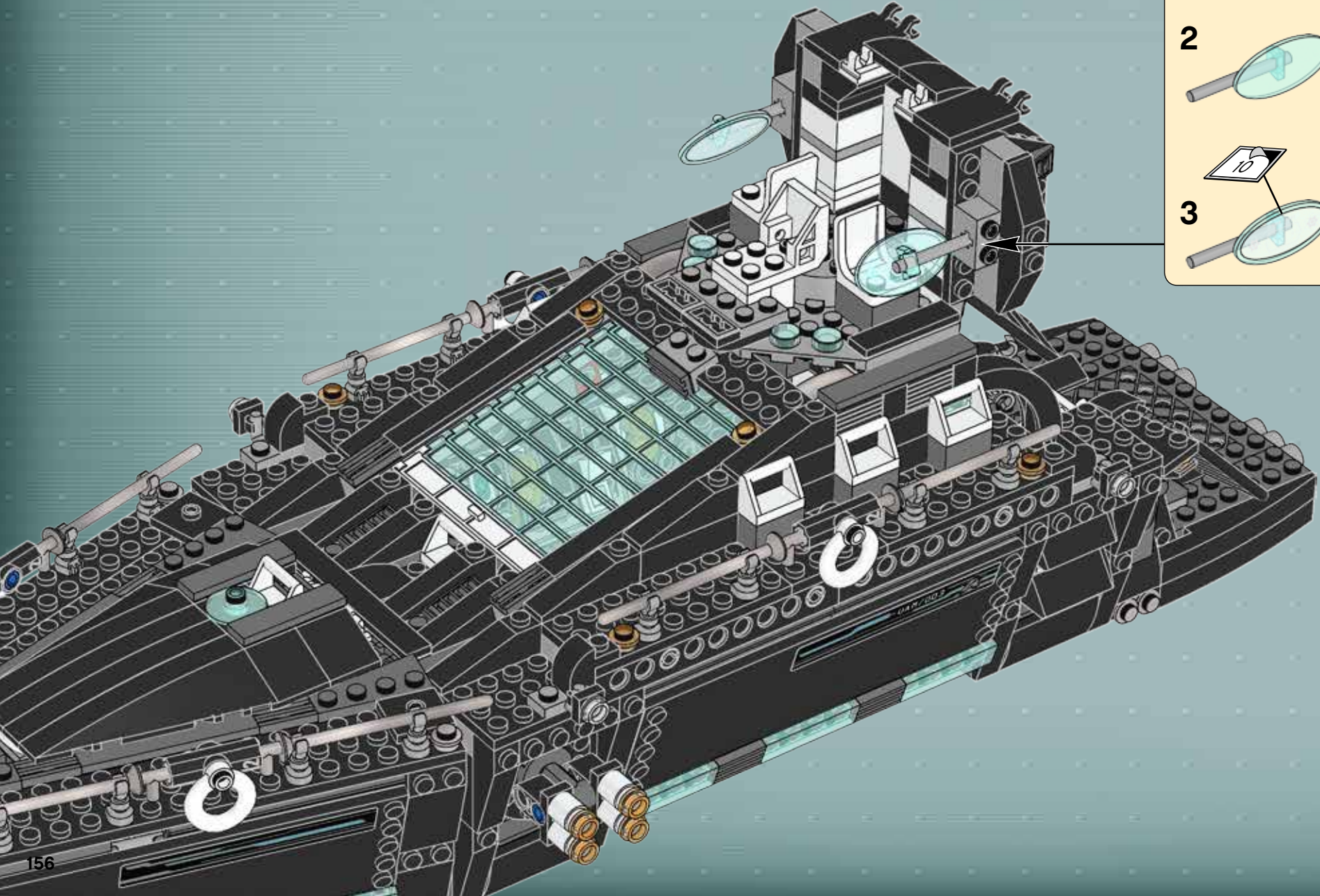

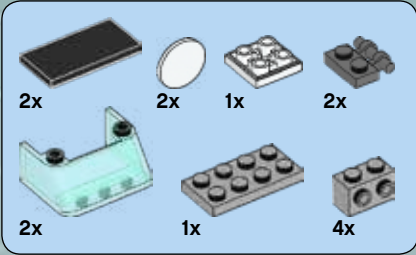

92

1



2

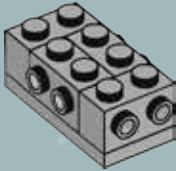

3

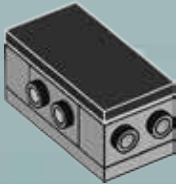

4

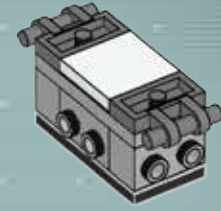

5

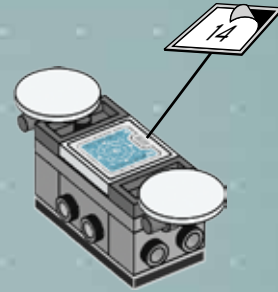

6

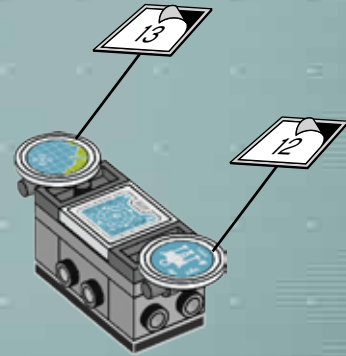

7



8

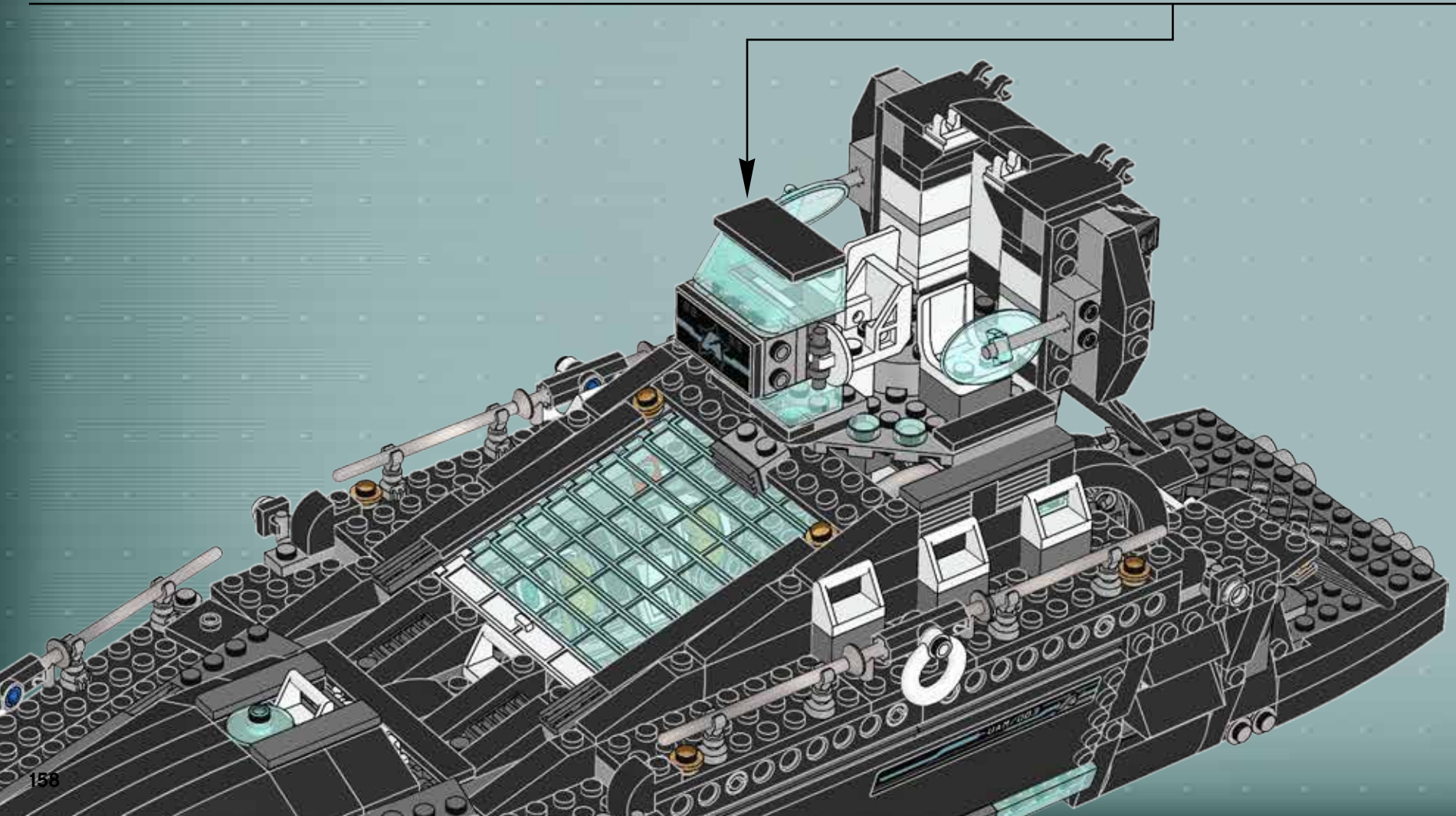
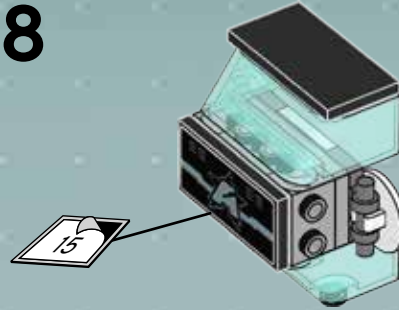

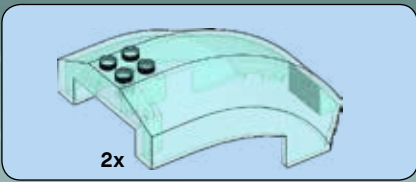

93

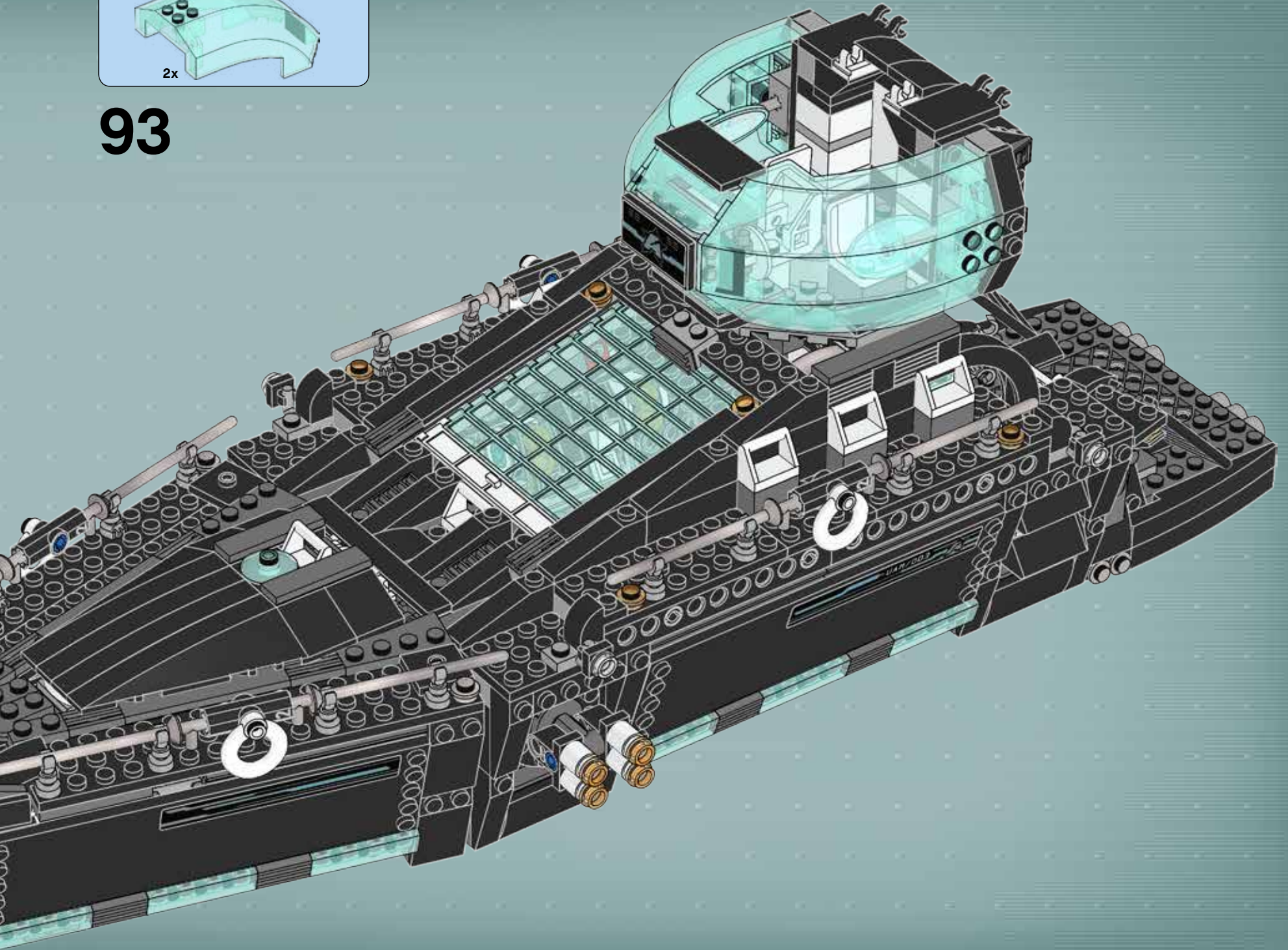

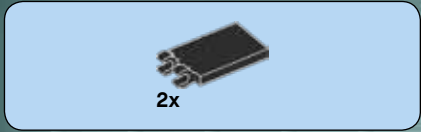

94

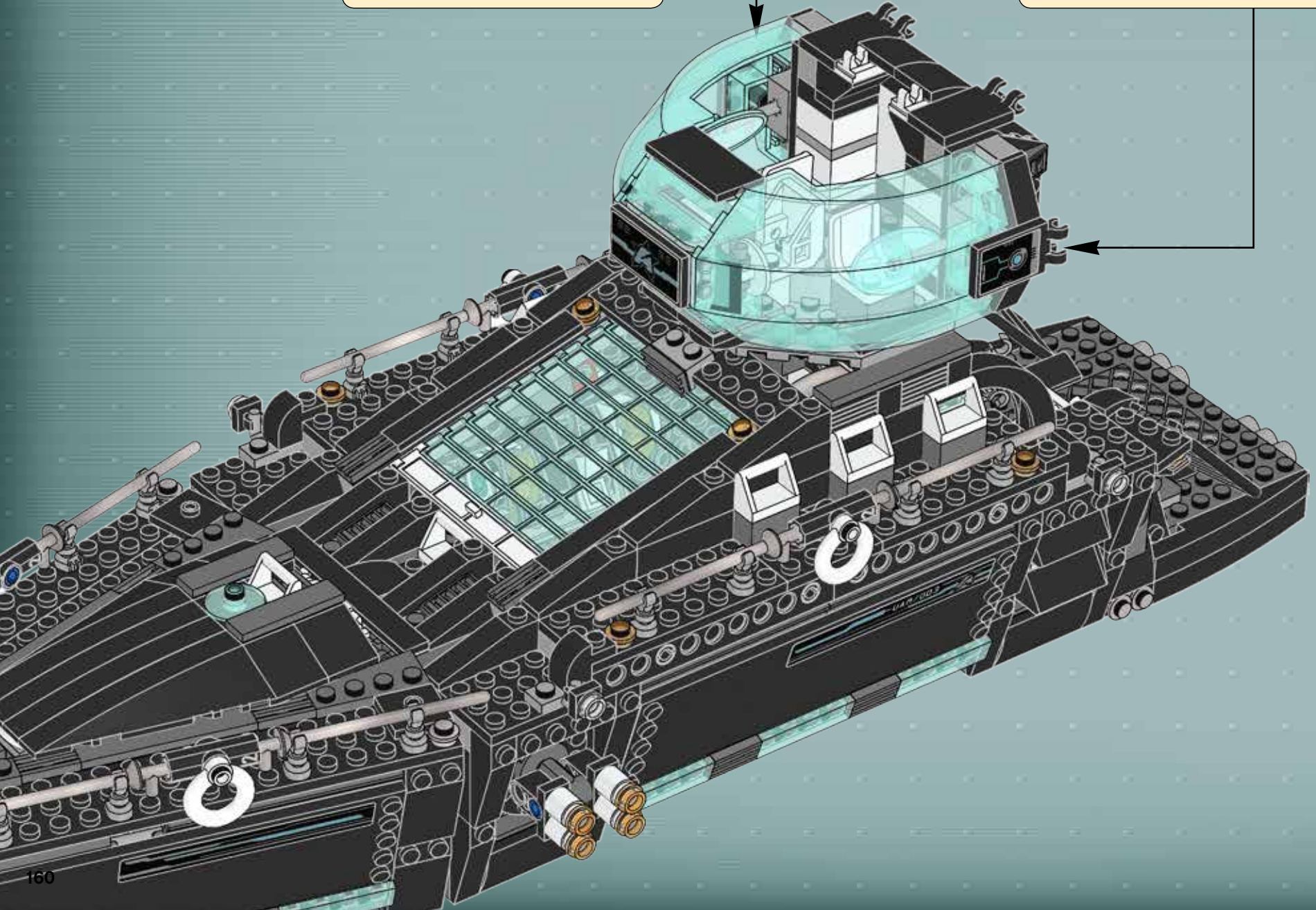
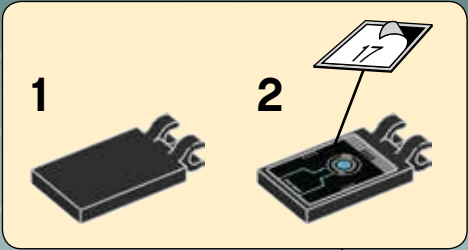
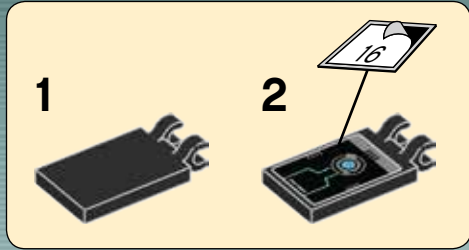





96

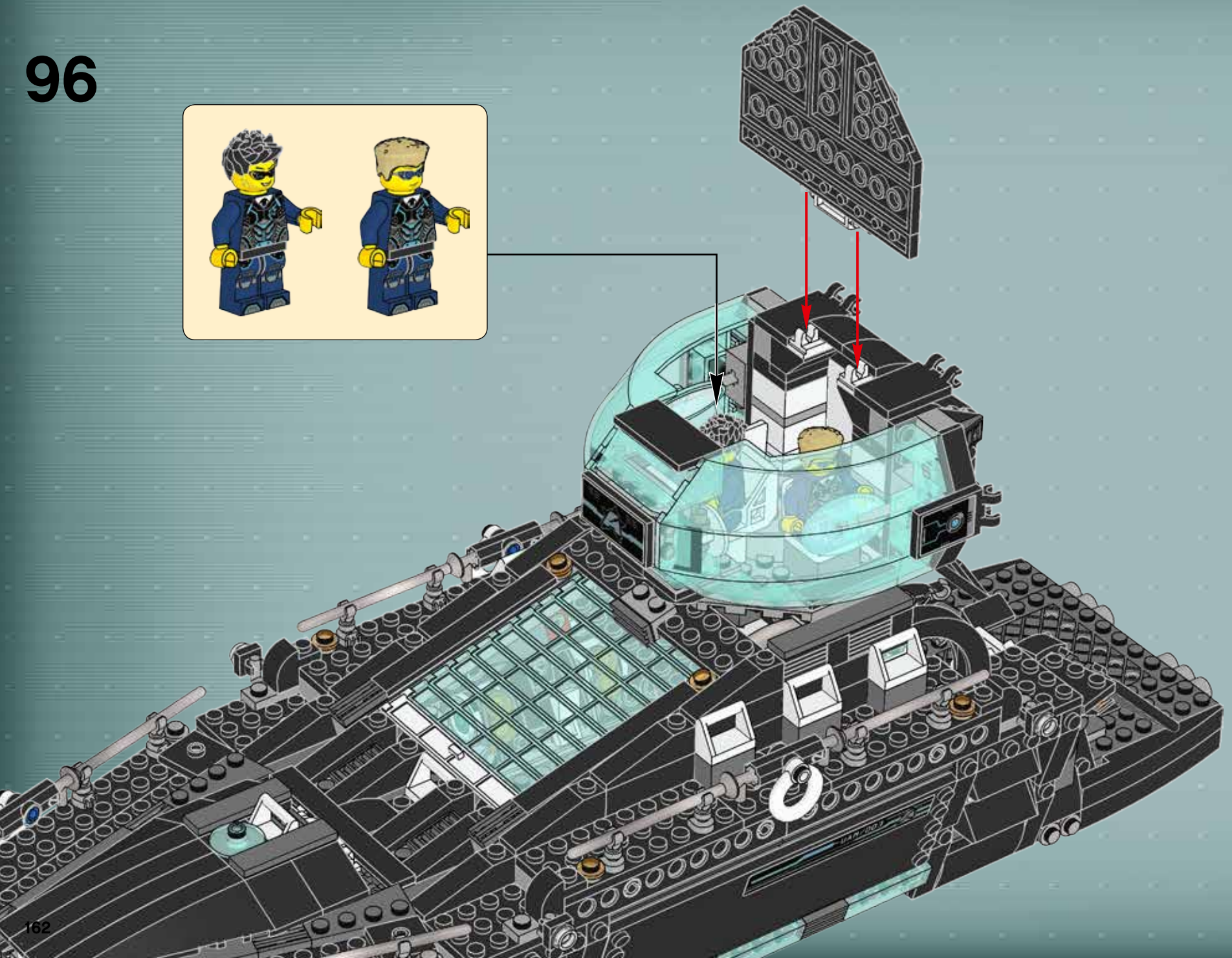

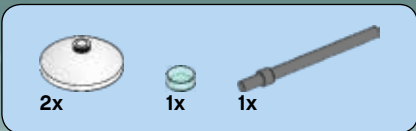

# 97

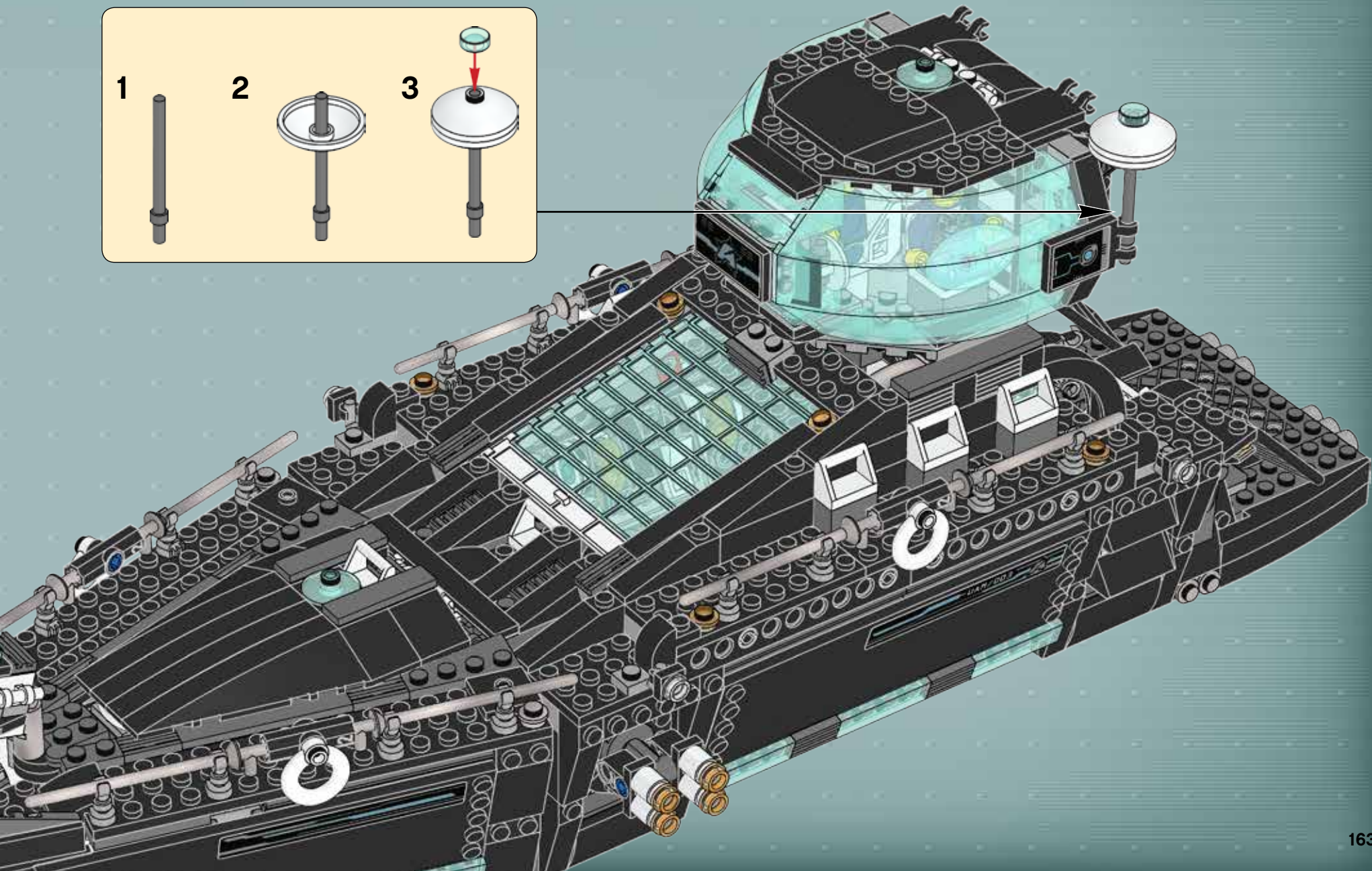
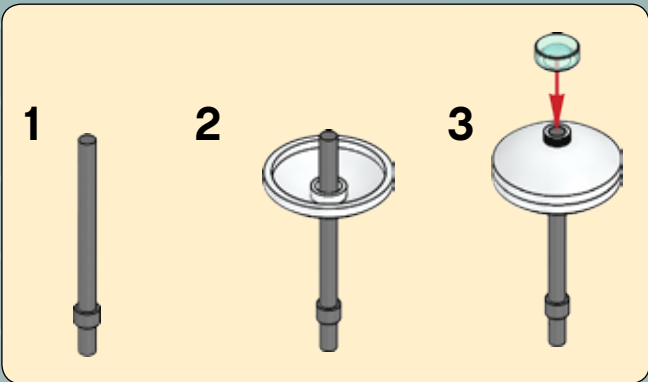

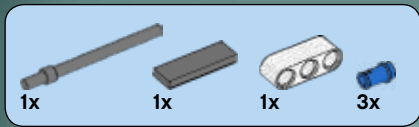

98

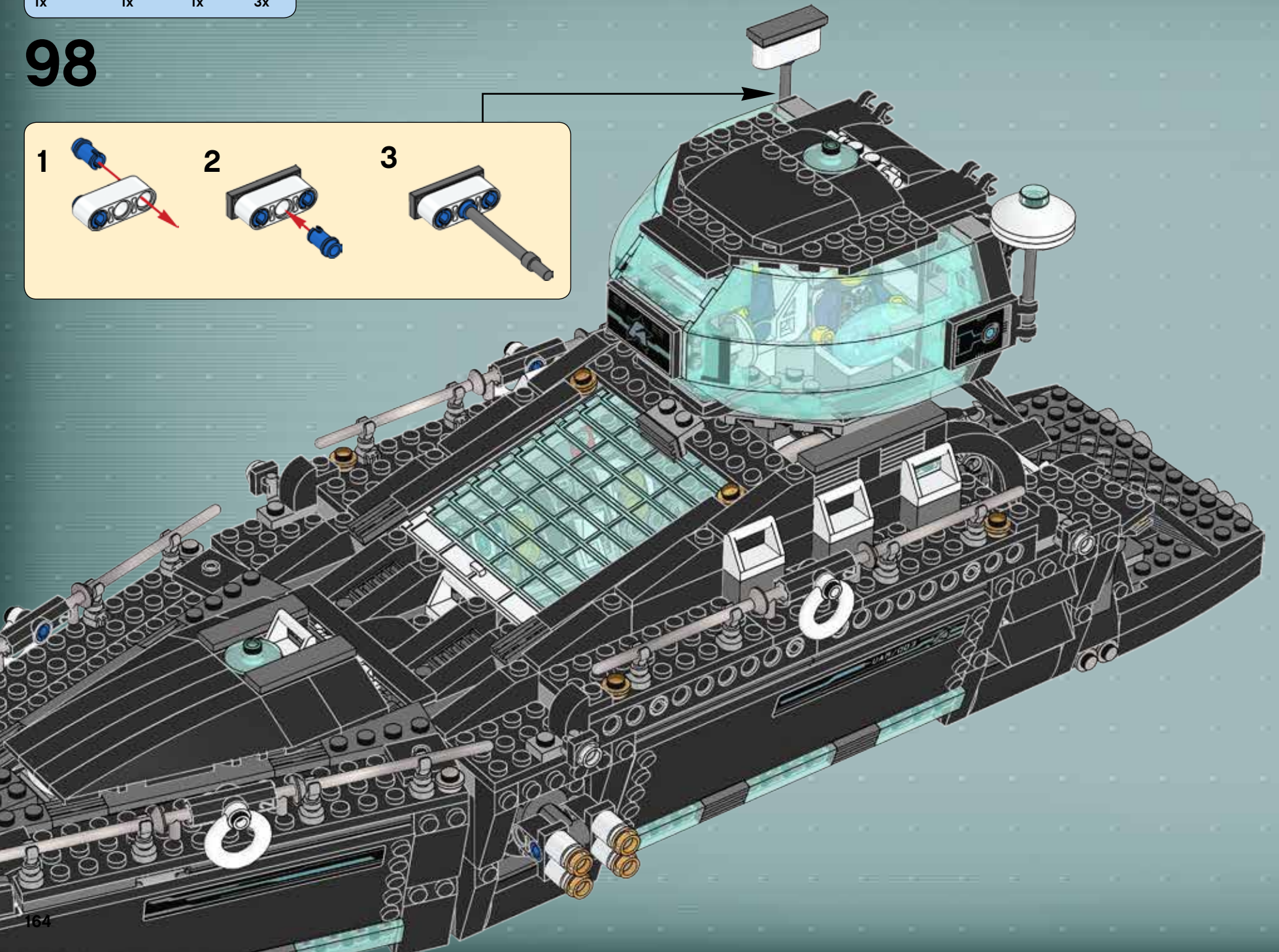
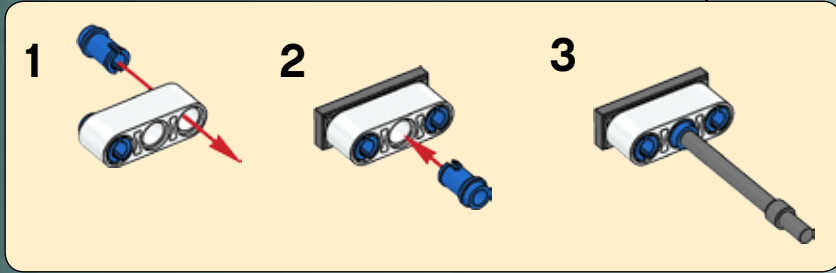



99

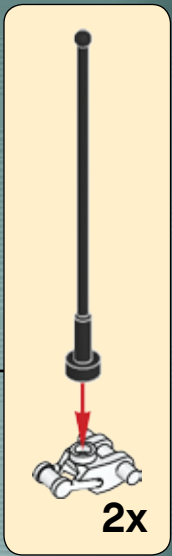
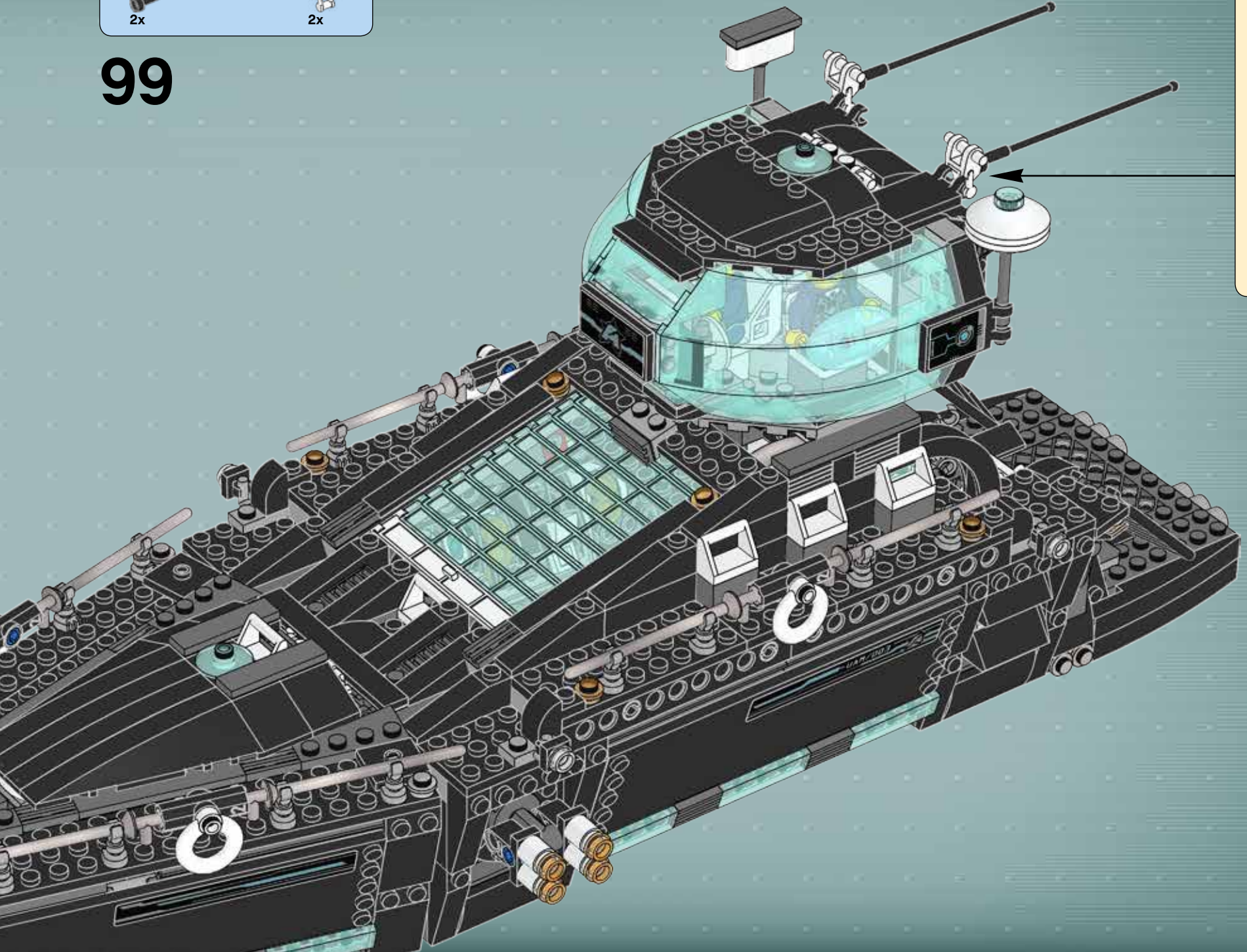

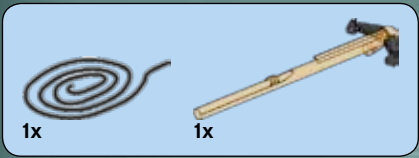

100

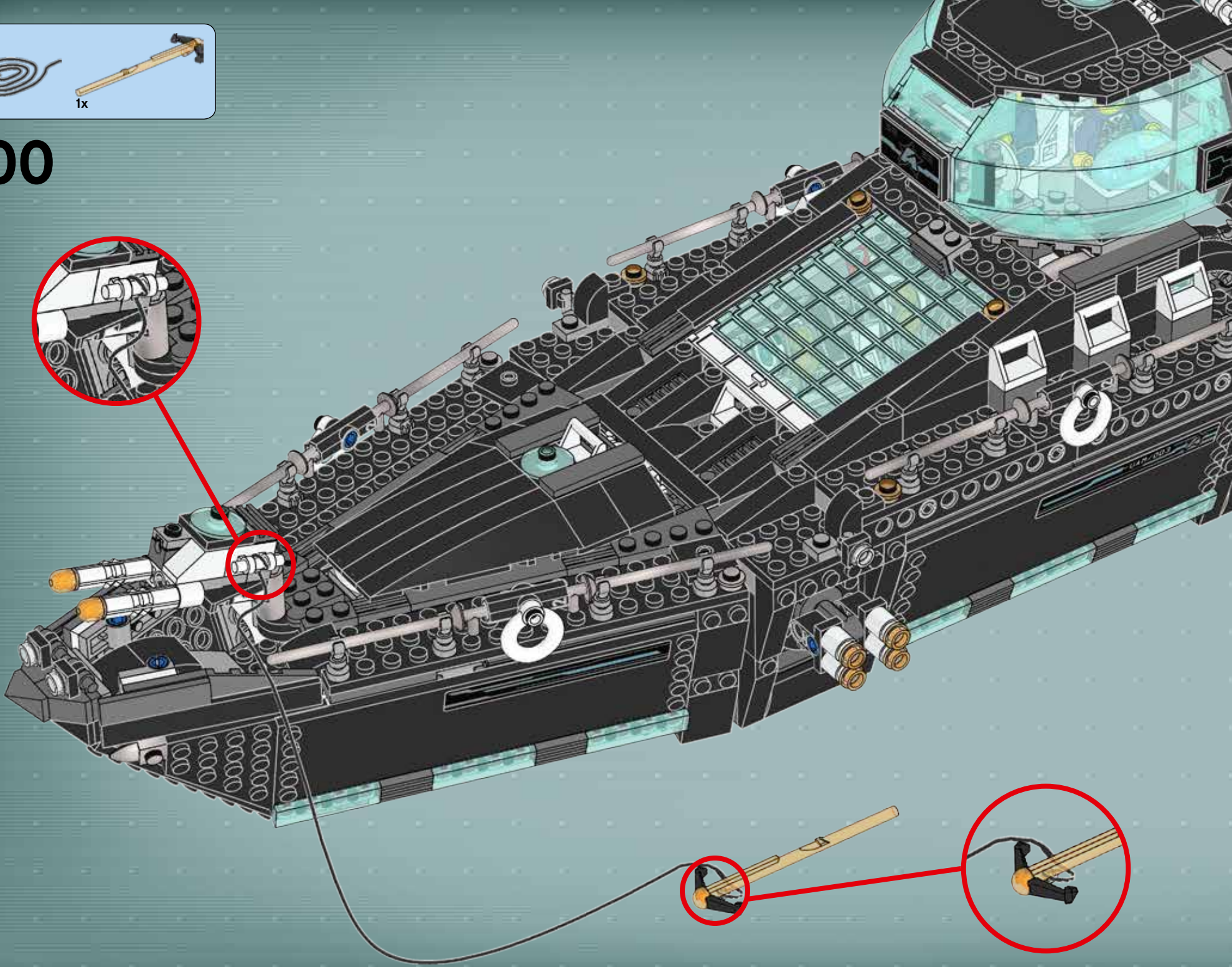

101

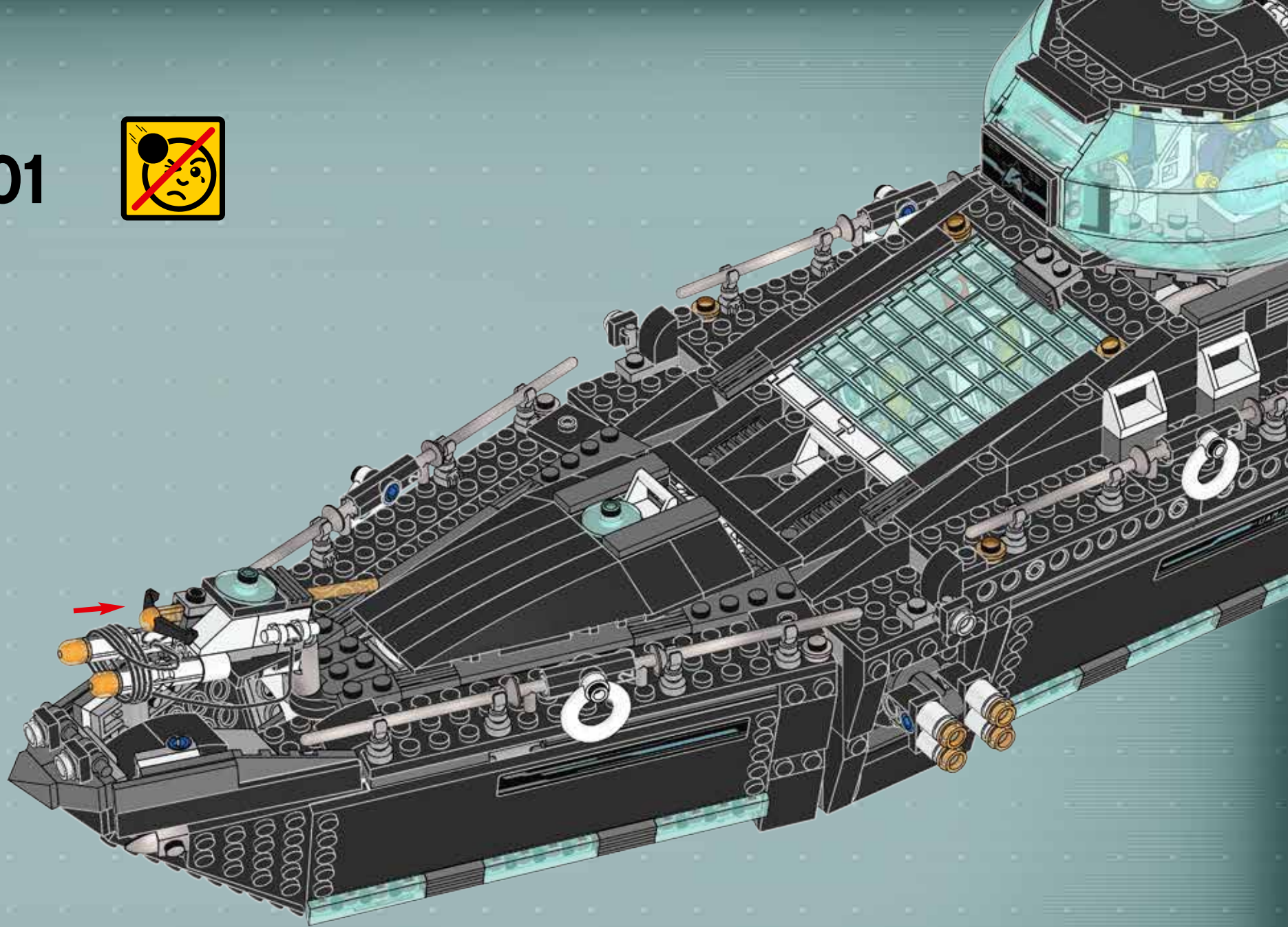



12x



# 102

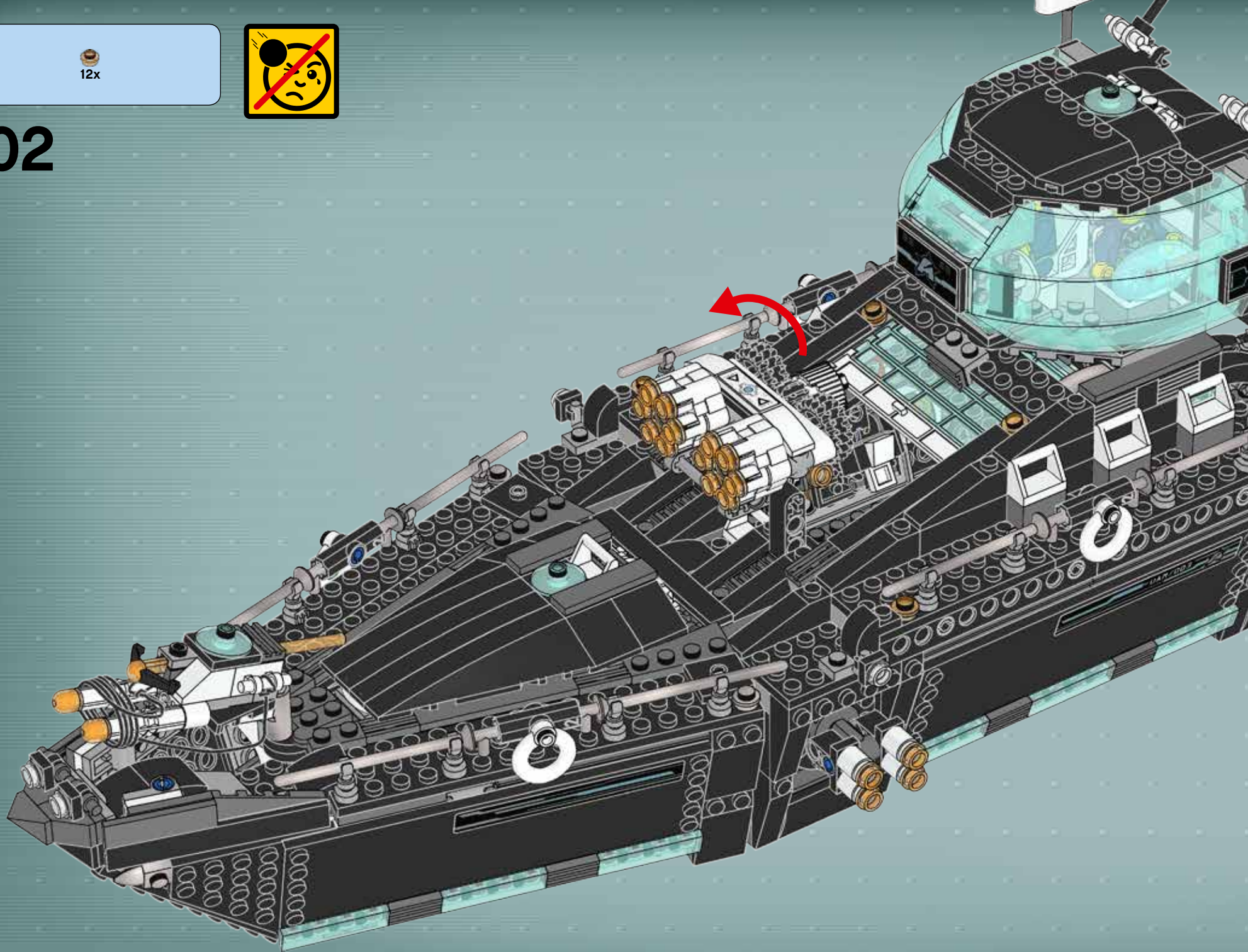



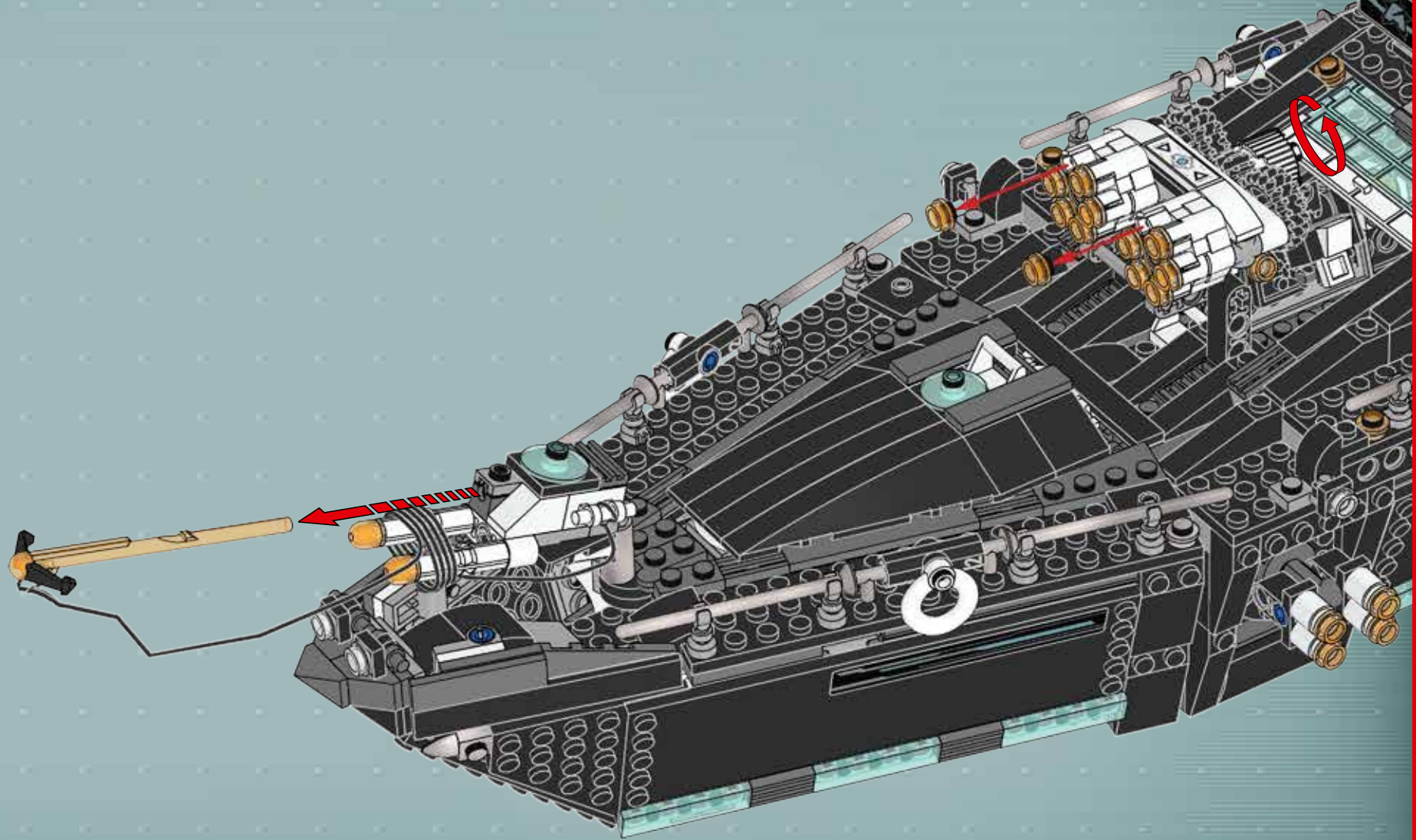

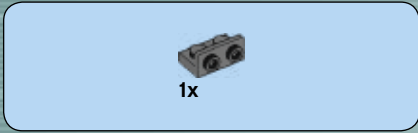

1

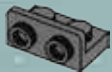

2

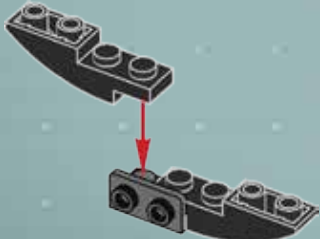

3

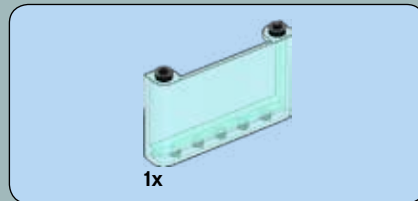
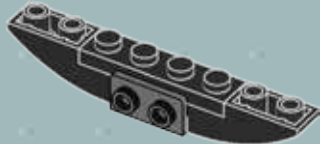

4

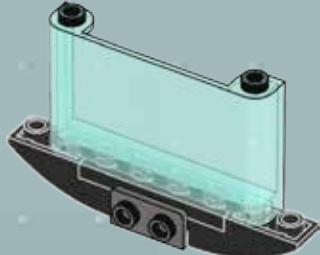

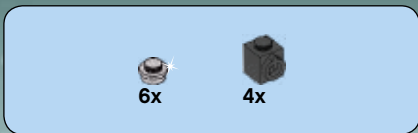

5

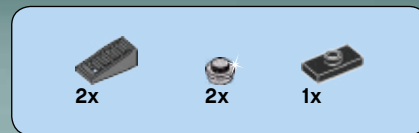
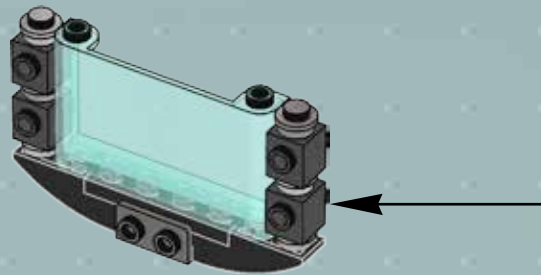
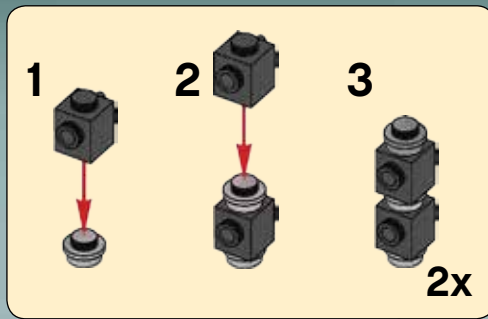

8

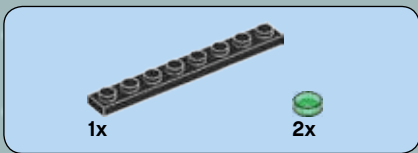

6

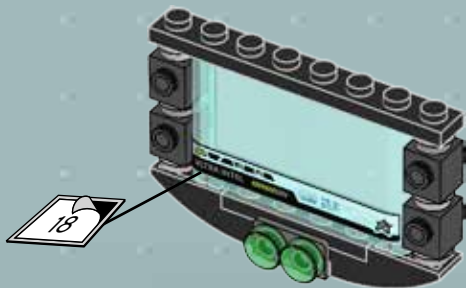

9



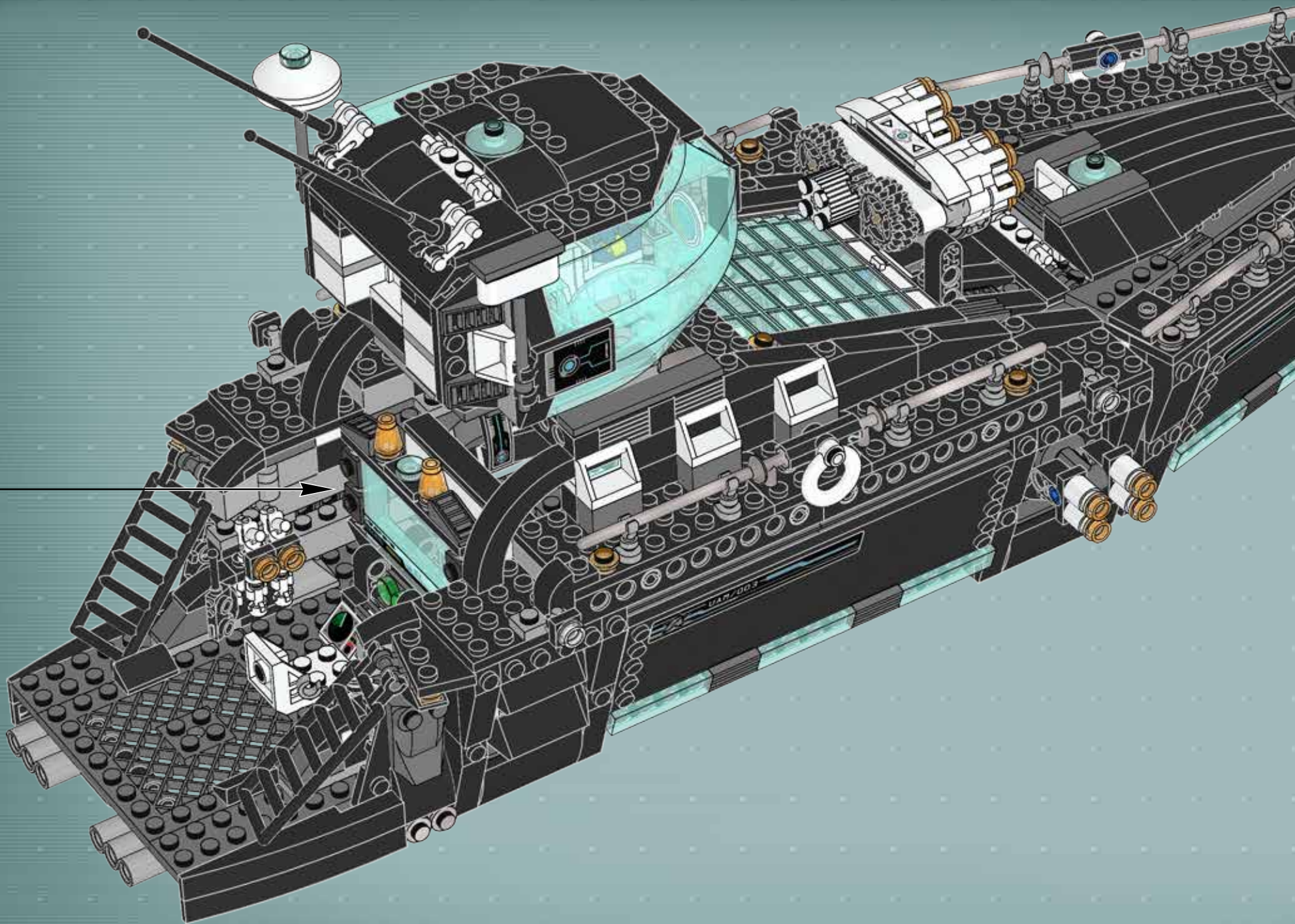



**Download the app and use the AppBrick  
Gadget to complete the mission!**

**Télécharge l'appli et utilise le gadget  
AppliBrique pour réussir la mission !**

**¡Descarga la app y usa el AppBrick  
para completar la misión!**

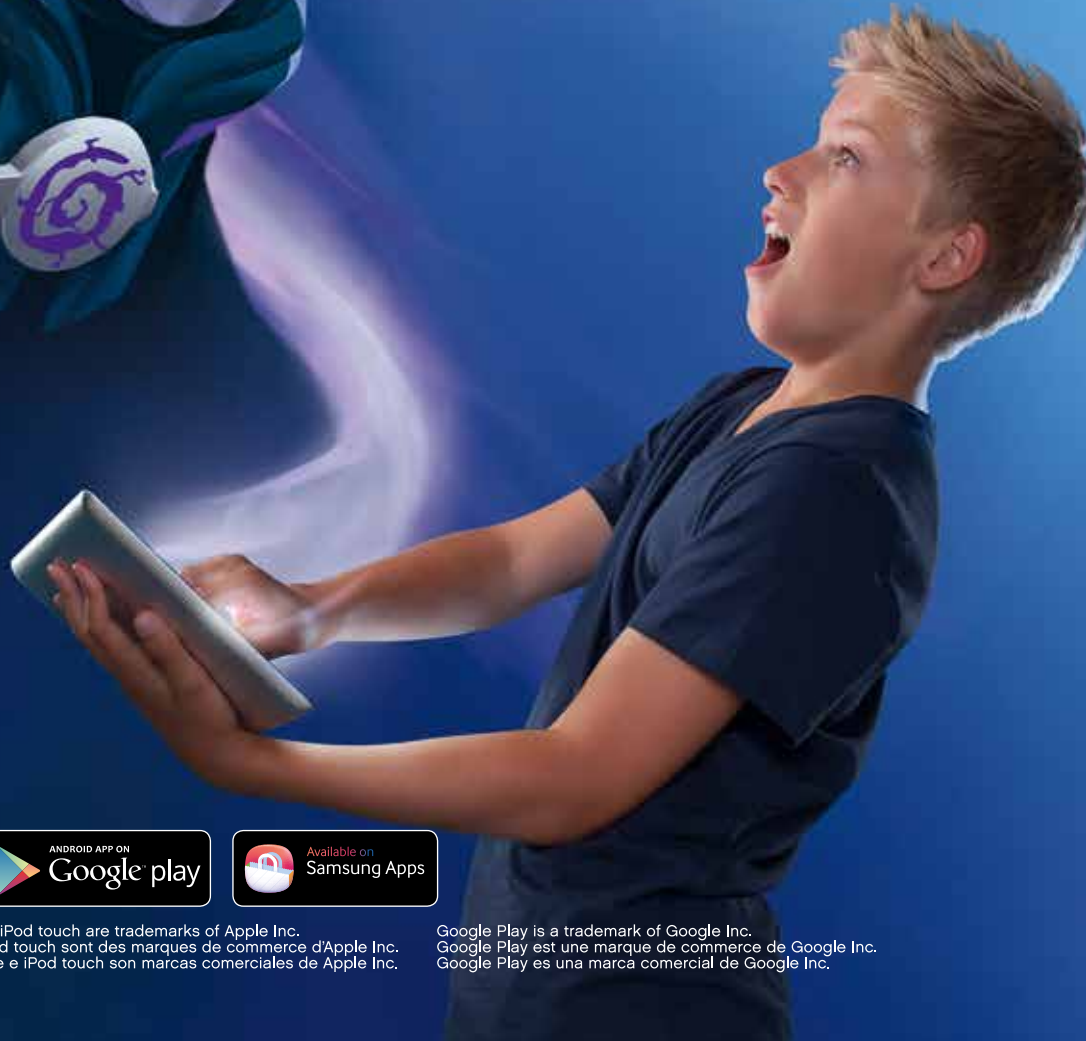

Apple, the Apple logo, iPad, iPhone and iPod touch are trademarks of Apple Inc.  
Apple, le logo Apple, iPad, iPhone et iPod touch sont des marques de commerce d'Apple Inc.  
Apple, el logotipo de Apple, iPad, iPhone e iPod touch son marcas comerciales de Apple Inc.

Google Play is a trademark of Google Inc.  
Google Play est une marque de commerce de Google Inc.  
Google Play es una marca comercial de Google Inc.

**Unlock the secrets with the new AppBrick Gadgets**

**Découvre les secrets avec les nouveaux gadgets AppliBrique**

**Descubre los secretos con los nuevos AppBricks**





# ULTRA AGENTS



70171



70172



70173



70166



70167



70168



70169



70170







42036



42033



42034

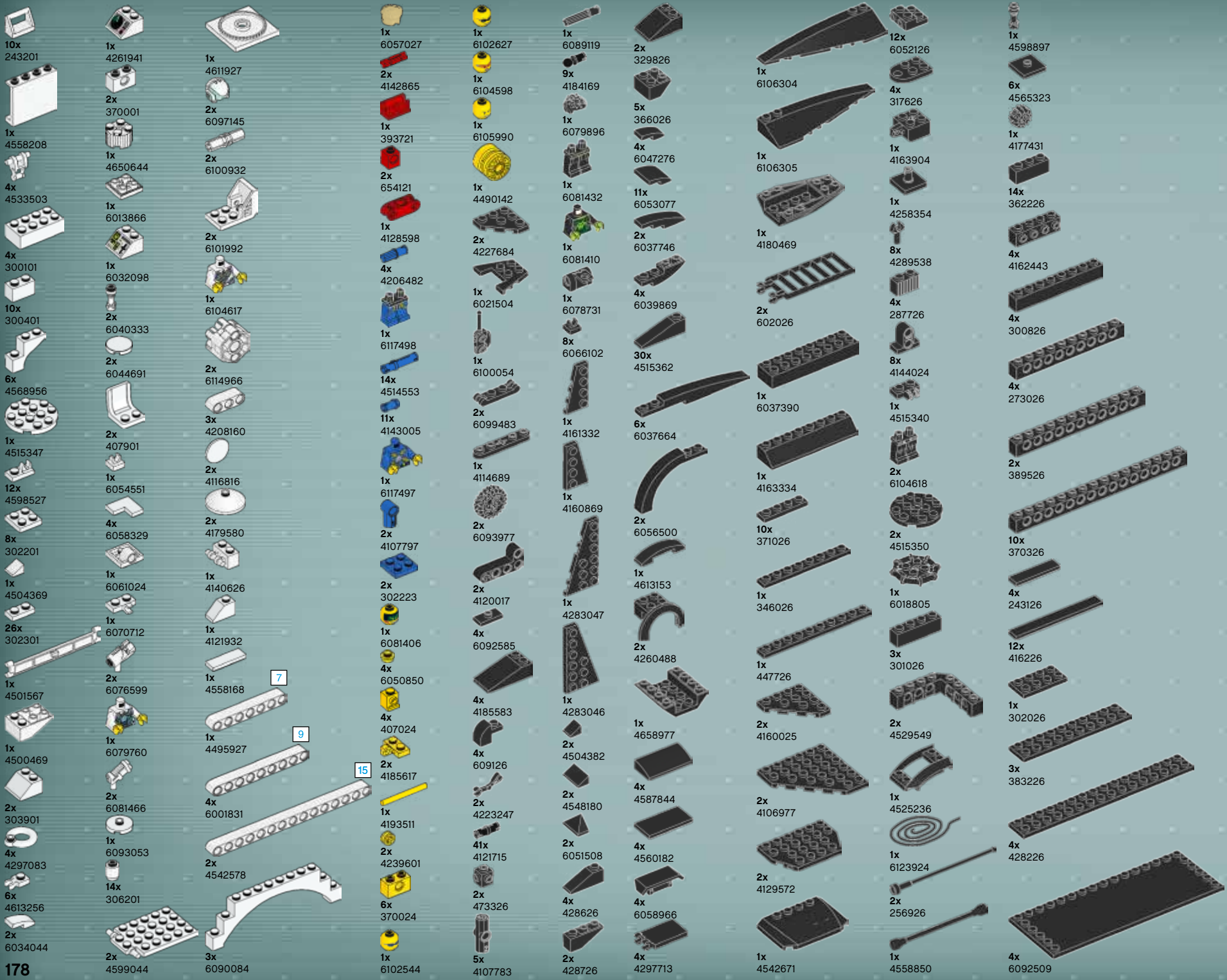

- 10x 243201
- 1x 4558208
- 4x 4533503
- 4x 300101
- 10x 300401
- 6x 4568956
- 1x 4515347
- 12x 4598527
- 8x 302201
- 1x 4504369
- 26x 302301
- 1x 4501567
- 1x 4500469
- 2x 303901
- 4x 4297083
- 6x 4613256
- 2x 6034044
- 1x 4261941
- 2x 370001
- 1x 4650644
- 1x 6013866
- 1x 6032098
- 2x 6040333
- 2x 6044691
- 2x 407901
- 1x 6054551
- 4x 6058329
- 1x 6061024
- 1x 6070712
- 2x 6076599
- 1x 6079760
- 2x 6081466
- 1x 6093053
- 14x 306201
- 1x 4611927
- 2x 6097145
- 2x 6100932
- 2x 6101992
- 1x 6104617
- 2x 6114966
- 3x 4208160
- 2x 4116816
- 2x 4179580
- 1x 4140626
- 1x 4121932
- 1x 4558168
- 1x 4495927
- 4x 6001831
- 2x 4542578
- 3x 6090084
- 1x 6057027
- 2x 4142865
- 1x 393721
- 2x 654121
- 1x 4128598
- 4x 4206482
- 1x 6117498
- 14x 4514553
- 11x 4143005
- 1x 6117497
- 2x 4107797
- 2x 302223
- 1x 6081406
- 4x 6050850
- 4x 407024
- 2x 4185617
- 1x 4193511
- 2x 4239601
- 6x 370024
- 1x 6102544
- 1x 6102627
- 1x 6104598
- 1x 6105990
- 1x 4490142
- 2x 4227684
- 1x 6021504
- 1x 6100054
- 2x 6099483
- 1x 4114689
- 2x 6093977
- 2x 4120017
- 4x 6092585
- 4x 4185583
- 4x 609126
- 2x 4223247
- 41x 4121715
- 2x 473326
- 5x 4107783
- 1x 6089119
- 9x 4184169
- 1x 6079896
- 1x 6081432
- 1x 6081410
- 1x 6078731
- 8x 6066102
- 1x 4161332
- 1x 4160869
- 1x 4283047
- 1x 4283046
- 2x 4504382
- 2x 4548180
- 2x 6051508
- 4x 428626
- 2x 428726
- 2x 329826
- 5x 366026
- 4x 6047276
- 11x 6053077
- 2x 6037746
- 4x 6039869
- 30x 4515362
- 6x 6037664
- 2x 6056500
- 1x 4613153
- 2x 4260488
- 1x 4658977
- 4x 4587844
- 4x 4560182
- 4x 6058966
- 4x 4297713
- 12x 6052126
- 4x 317626
- 1x 4163904
- 1x 4258354
- 8x 4289538
- 4x 287726
- 8x 4144024
- 1x 4515340
- 2x 6104618
- 2x 4515350
- 1x 6018805
- 3x 301026
- 2x 4529549
- 1x 4525236
- 1x 6123924
- 2x 256926
- 1x 4558850
- 1x 4598897
- 6x 4565323
- 1x 4177431
- 14x 362226
- 4x 4162443
- 4x 300826
- 4x 273026
- 2x 389526
- 10x 370326
- 4x 243126
- 12x 416226
- 1x 302026
- 3x 383226
- 4x 428226
- 4x 6092509

- 6x 4243819
- 5x 303526
- 1x 303026
- 1x 303326
- 2x 6109815
- 1x 4639346
- 1x 4546691
- 9x 4258476
- 2x 4228126
- 2x 6028411
- 8x 6022171
- 3x 4581214
- 1x 6103865
- 1x 6064345
- 1x 6006514
- 2x 4524365
- 65x 4222960
- 1x 6097148
- 2x 4567338
- 2x 4278409
- 4x 6055631
- 1x 6031821
- 2x 6102607
- 2x 6102608
- 5x 4494475
- 2x 6097090
- 6x 6089147
- 2x 4612621
- 6x 4611702
- 6x 4211386
- 9x 6015344
- 2x 4520320
- 2x 4211815
- 5x 616608
- 6x 4526985
- 2x 4211807
- 6x 4233493
- 1x 4654582
- 13x 4654580
- 2x 4225033
- 2x 4211436
- 16x 6064023
- 9x 6043656
- 1x 4211881
- 1x 6045988
- 1x 4211421
- 2x 4222047
- 4x 4211429
- 4x 4211438
- 1x 4514846
- 2x 4613165
- 19x 4211395
- 3x 4211452
- 10x 6011459
- 10x 4211461
- 1x 4211527
- 2x 4211640
- 2x 4211848
- 1x 6034493
- 14x 4211393
- 2x 6023978
- 2x 4211705
- 4x 4211566
- 1x 4211413
- 1x 4641048
- 2x 6028812
- 4x 6092649
- 6x 4211053
- 4x 4210651
- 2x 4218696
- 2x 4579354
- 2x 6051334
- 1x 6048898
- 20x 4210631
- 2x 6063277
- 2x 4213574
- 3x 4568734
- 2x 4213607
- 4x 6019987
- 4x 6015356
- 5x 4211135
- 1x 4211124
- 2x 6100030
- 4x 4211064
- 4x 4211060
- 3x 4211046
- 3x 4211044
- 12x 6117972
- 10x 4211043
- 13x 6000606
- 1x 4210718
- 6x 4211088
- 2x 4211068
- 2x 6081987
- 4x 4210900
- 2x 4210851
- 1x 6076203
- 2x 4271950
- 2x 6055313
- 1x 4299022
- 14x 4210660
- 2x 4210658
- 2x 4261908
- 8x 4540386
- 8x 4210998
- 6x 4210967
- 10x 4210997
- 3x 4211067
- 2x 6039176
- 2x 4243831
- 2x 4210794
- 4x 4256149
- 1x 4210469
- 4x 6102774
- 2x 4210788
- 2x 4210782
- 1x 6117394
- 4x 6103777
- 3x 6078279
- 2x 4515367
- 1x 6054858
- 2x 6047418
- 2x 4625146
- 18x 4633691
- 2x 4612827
- 8x 4611884

**Customer Service**  
 Kundenservice  
 Service Consommateurs  
 Servicio Al Consumidor  
 LEGO.com/service or dial

: 00800 5346 5555  
 : 1-800-422-5346