

LEGENDS OF **CHIMA**™



70145





4

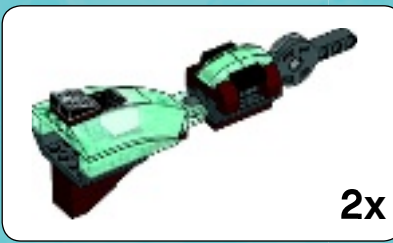
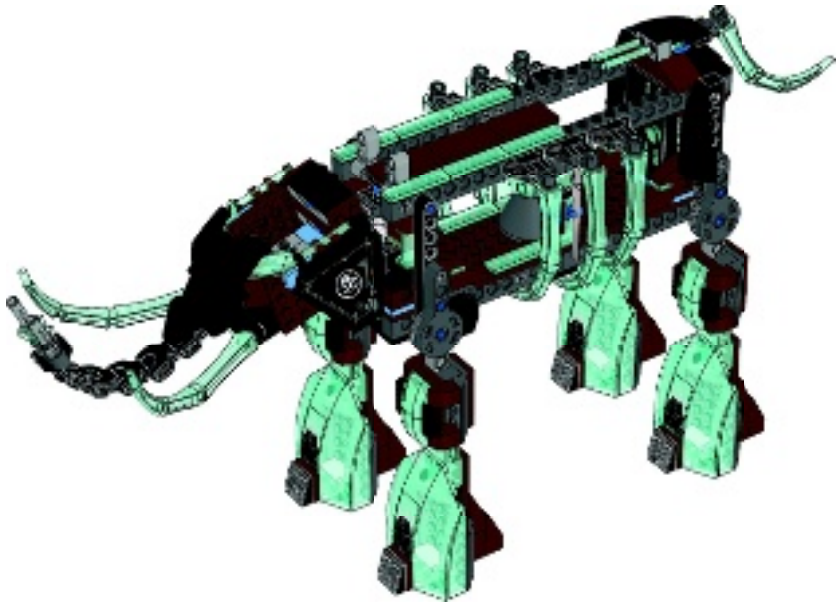

2x

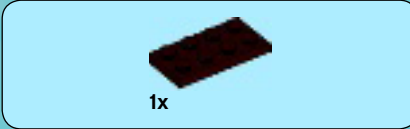

1x

1

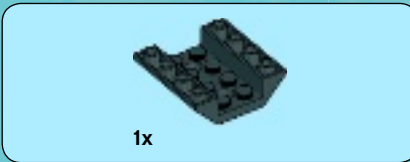

1x

2



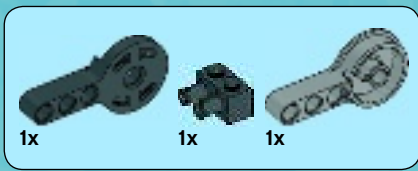

3

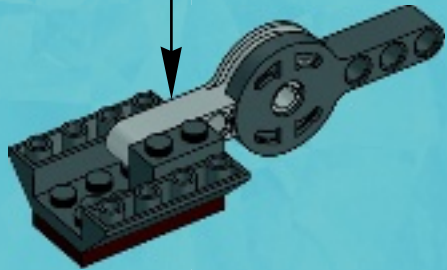
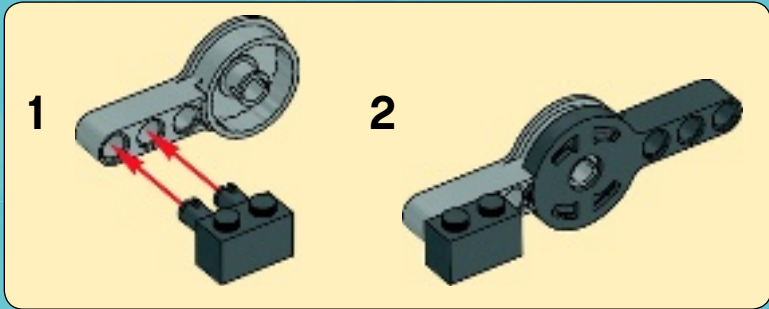

4

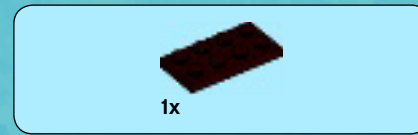
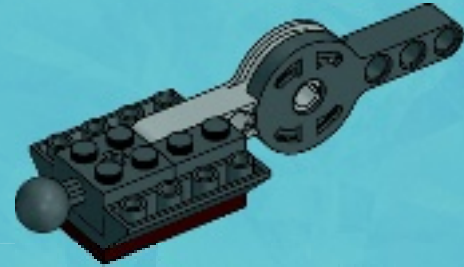

5

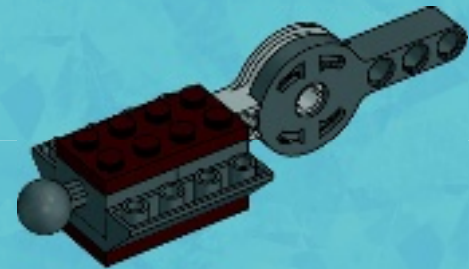



4x



1x

6

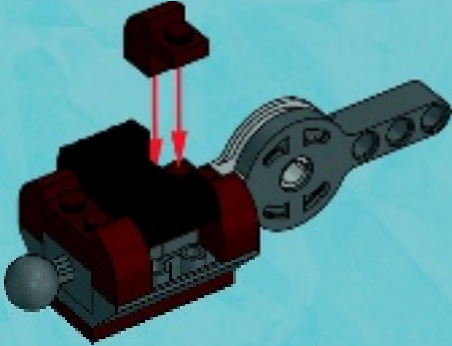

2x

7

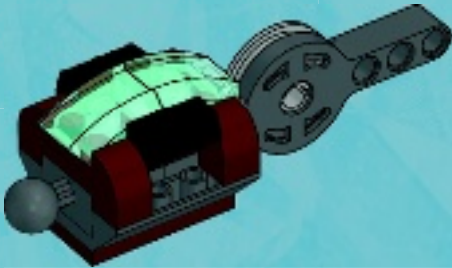

1x



1x

1

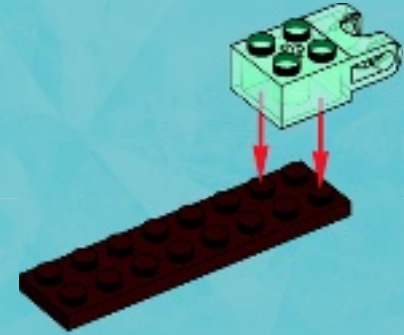

1x

2



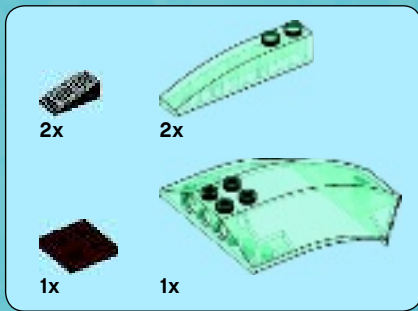

3

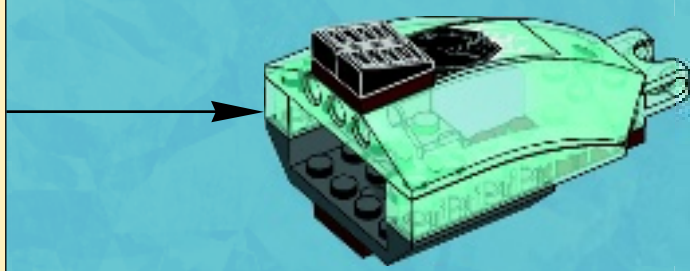
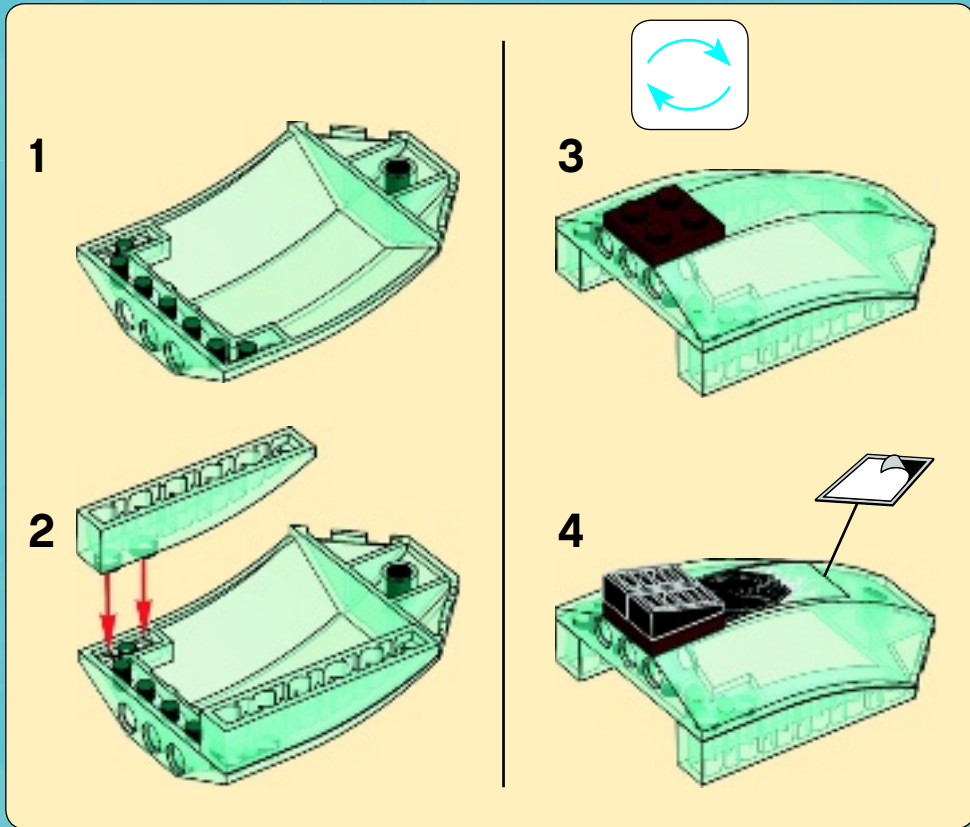

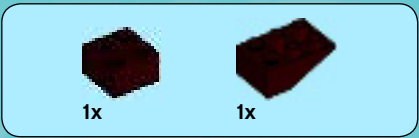

4

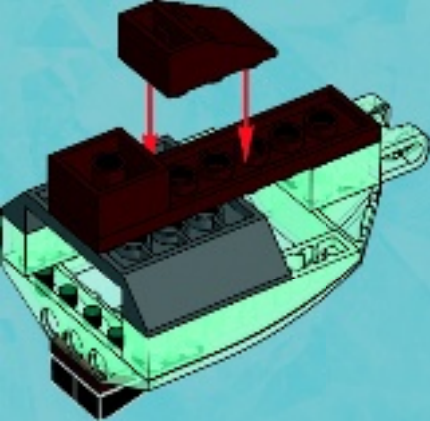

5

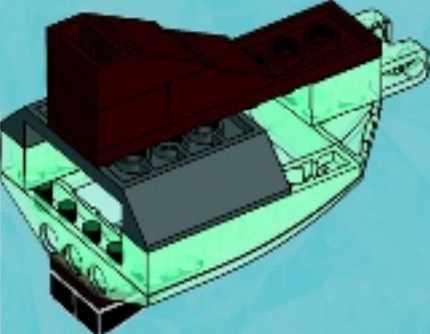

8

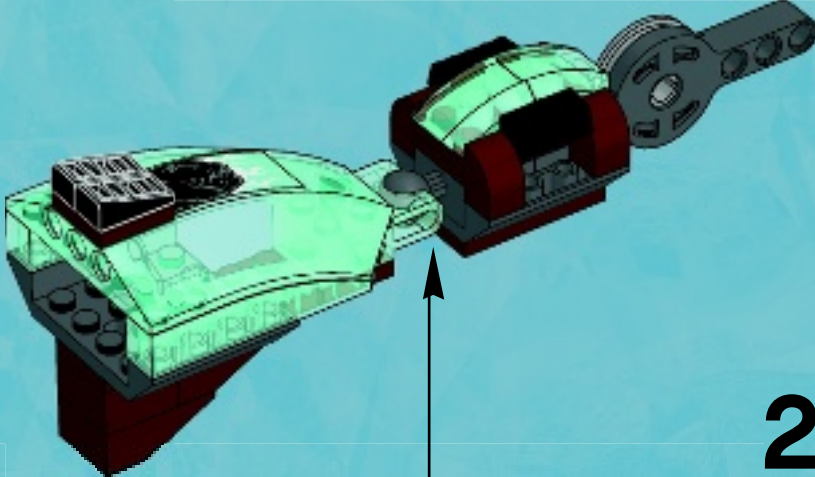

2x

32

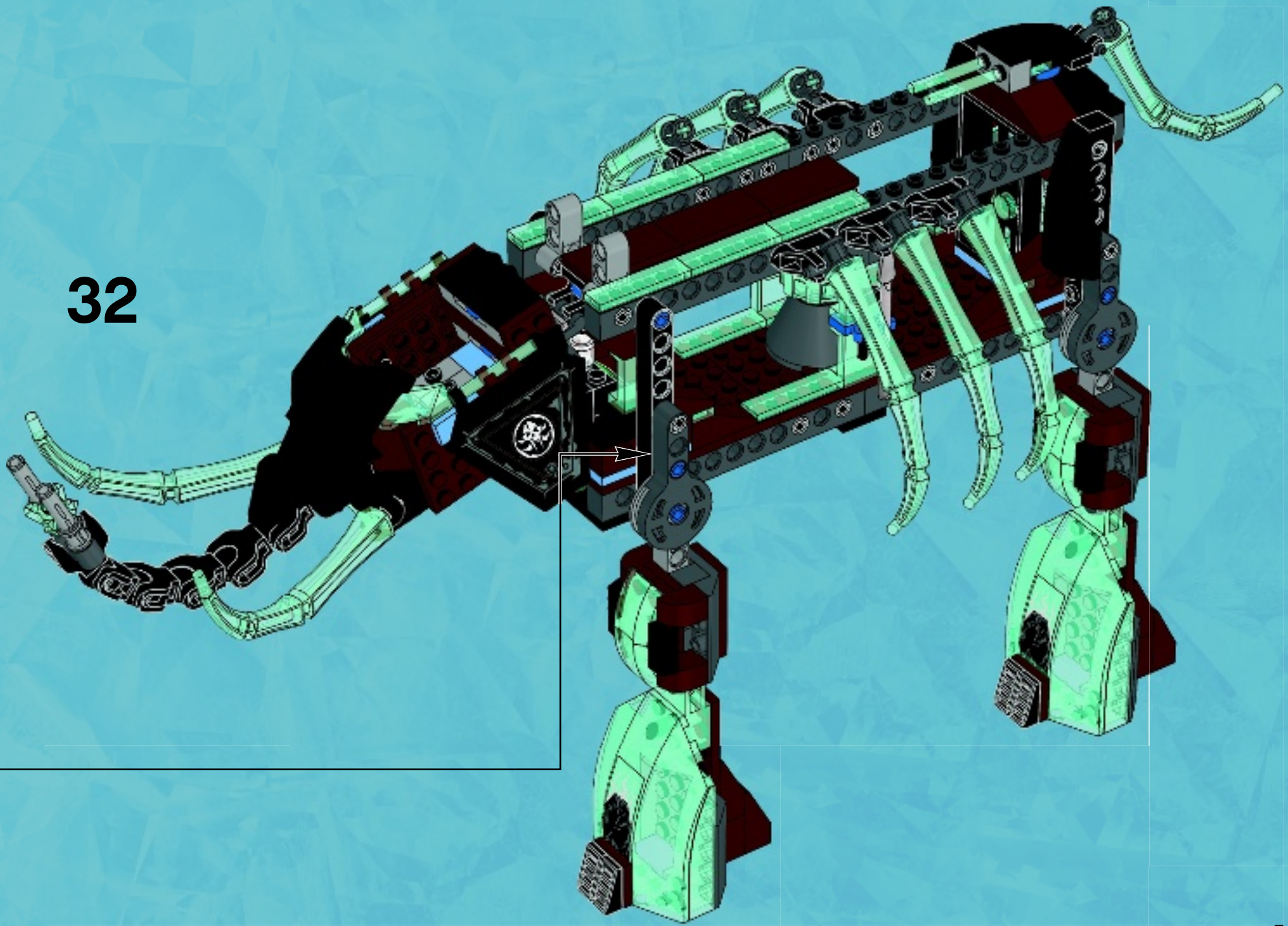



1x



1x

33

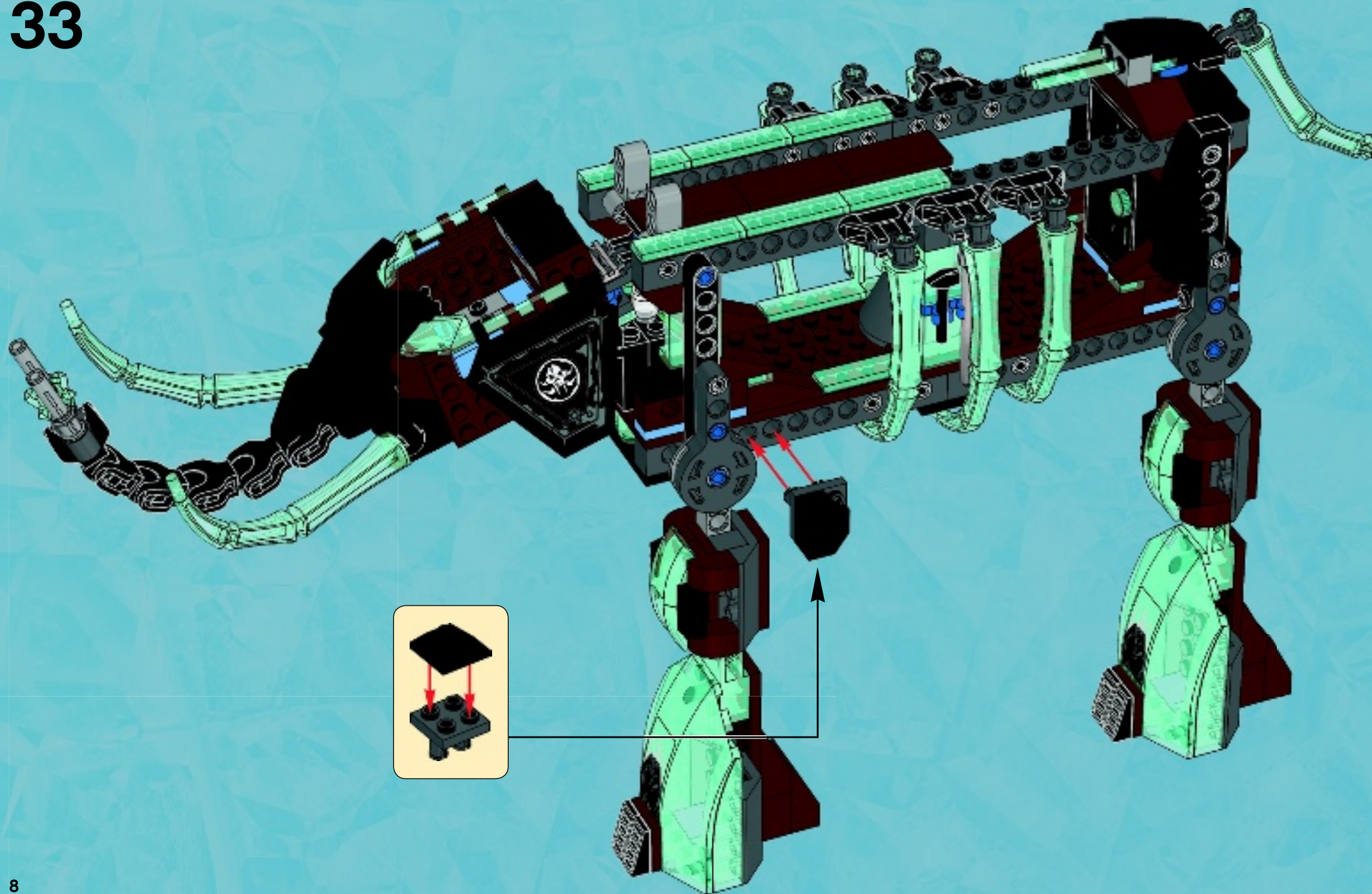

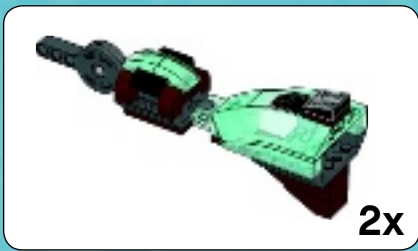

1



2

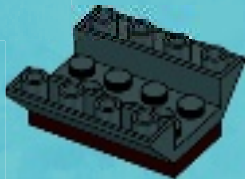

3

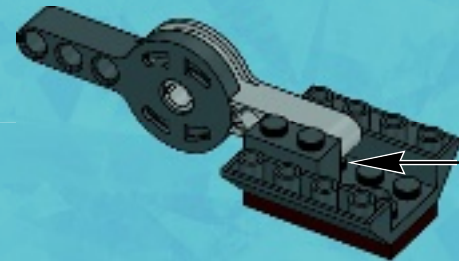
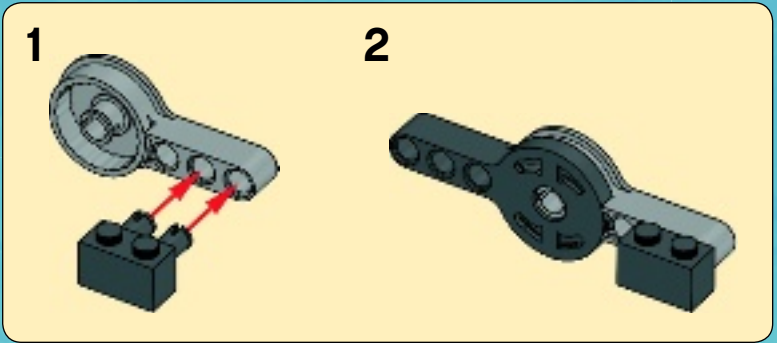



4

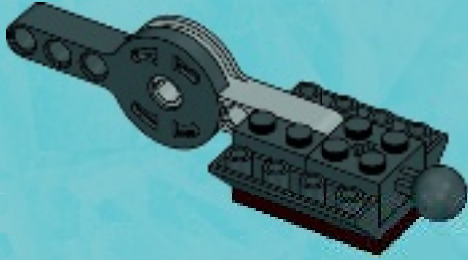

5

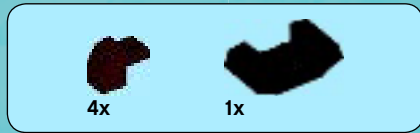
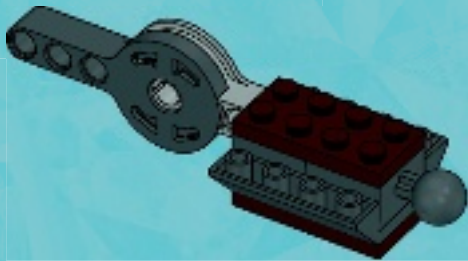

6

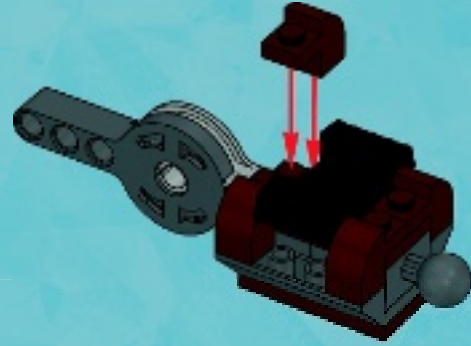

7

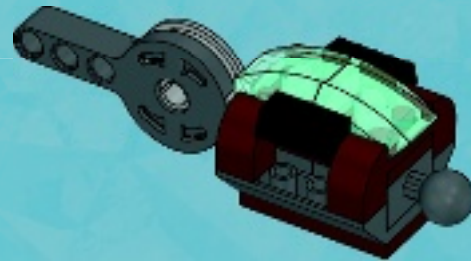



1

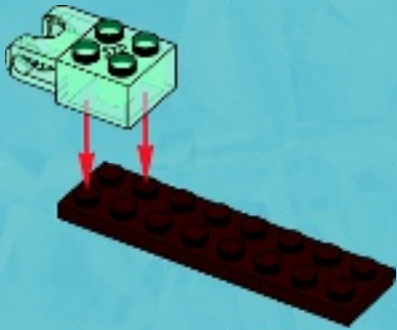

2

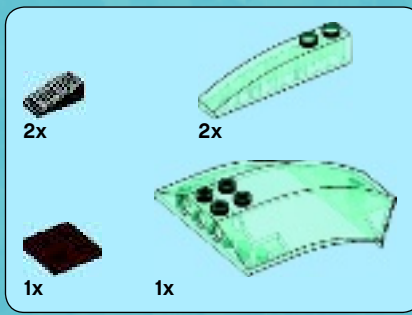
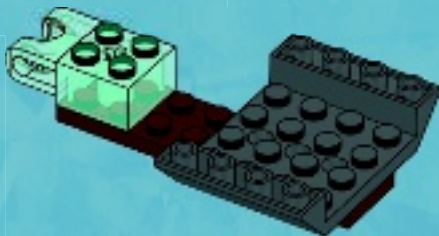

3

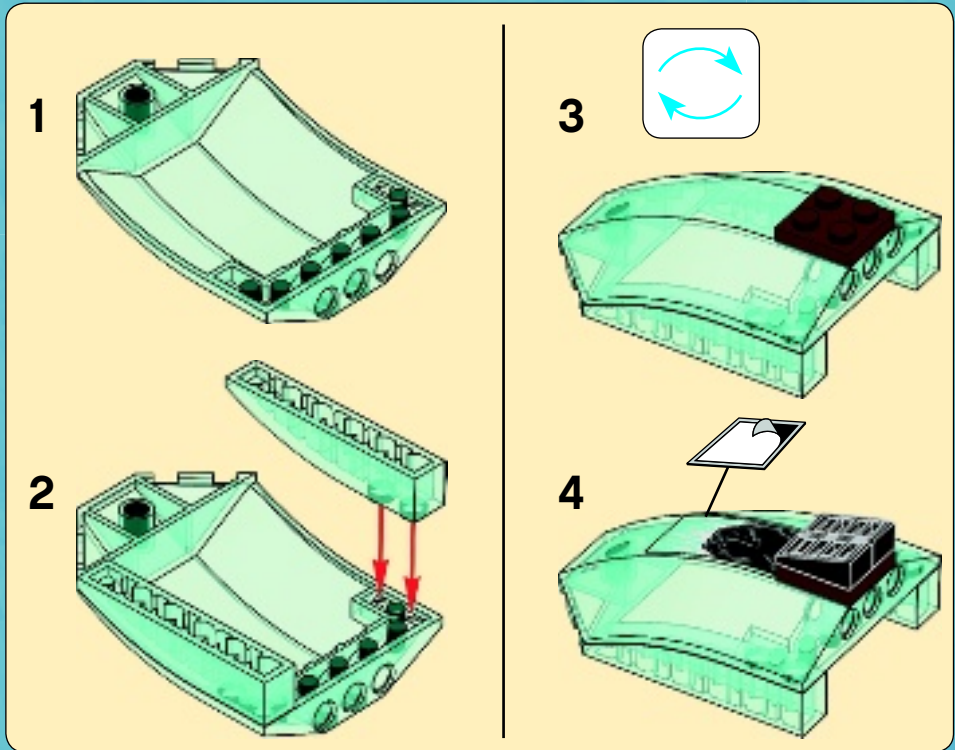



1x



1x

4

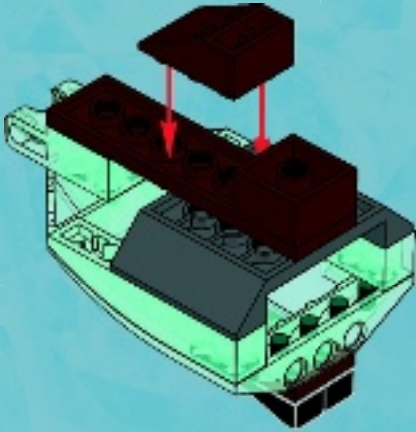

1x

5

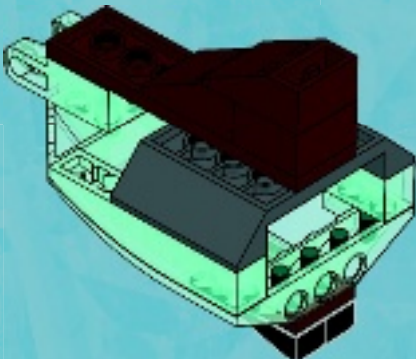

8

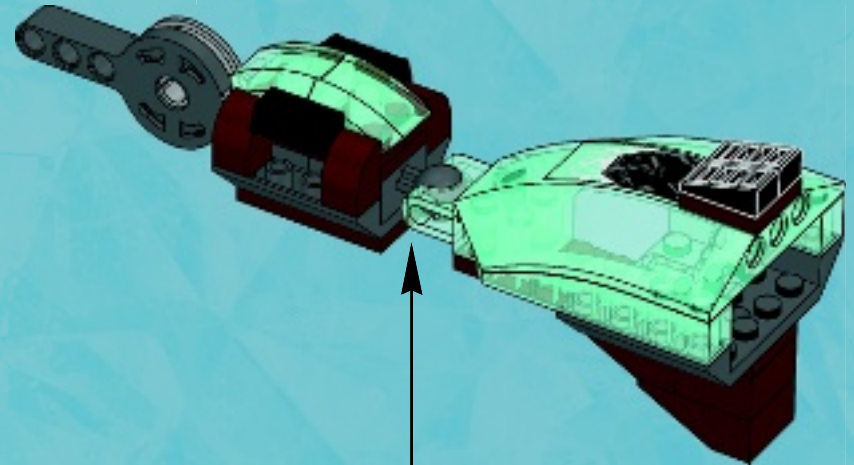

2x

34

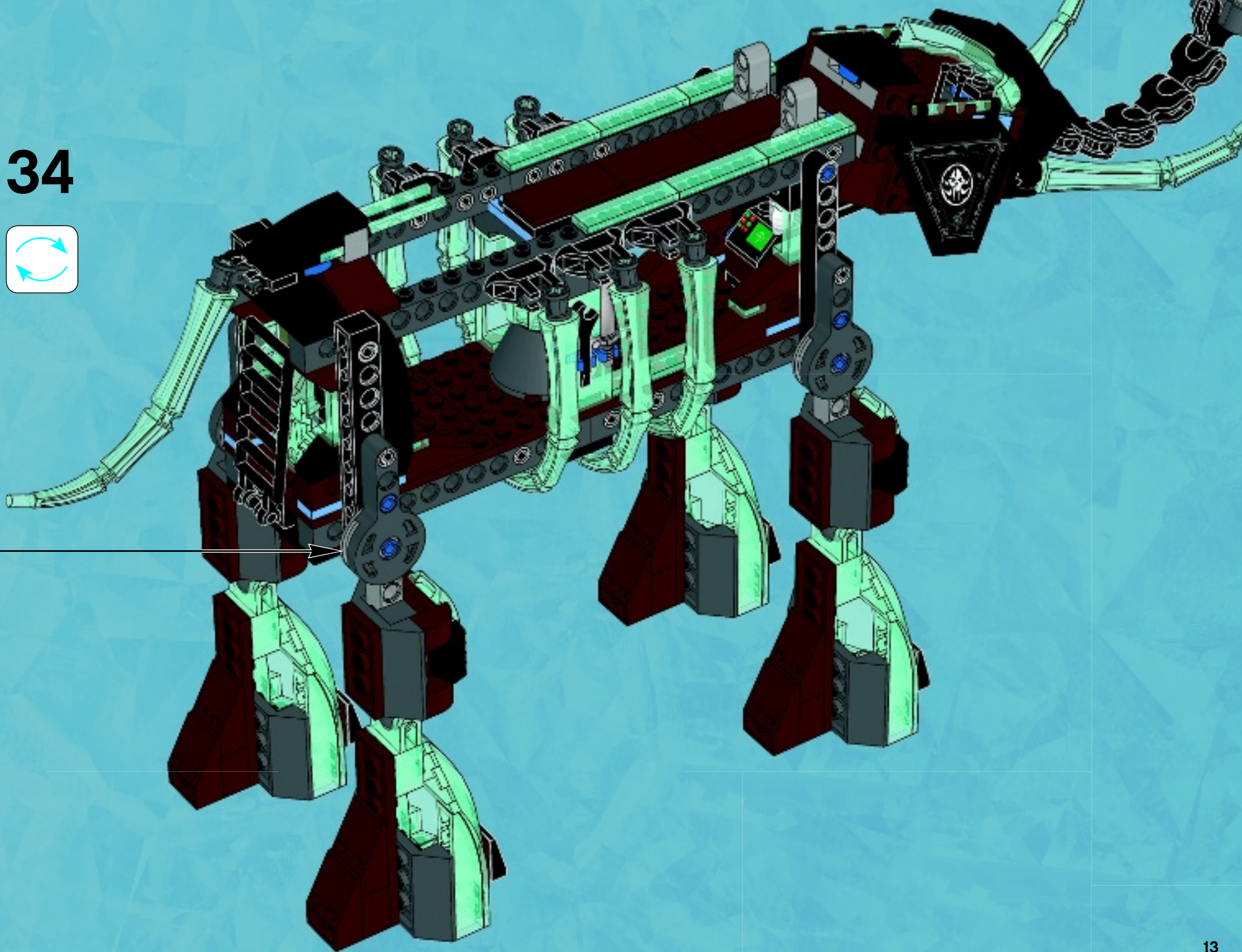



1x



1x

35

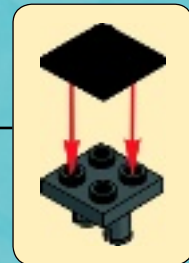
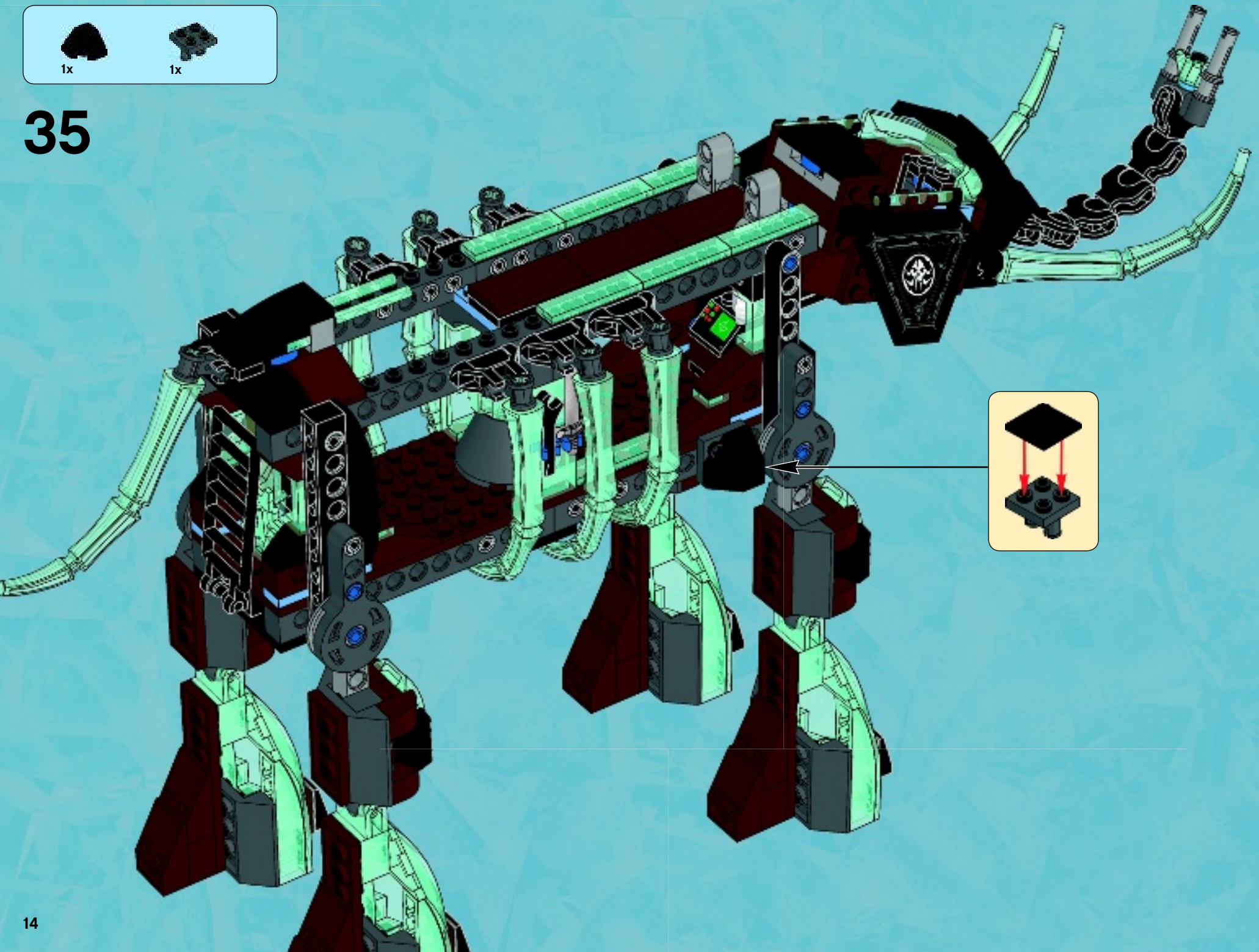

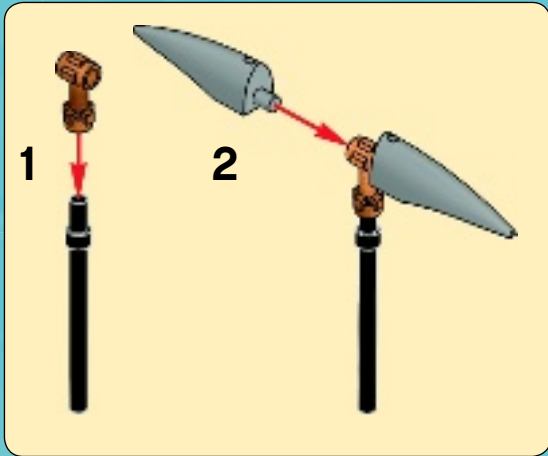
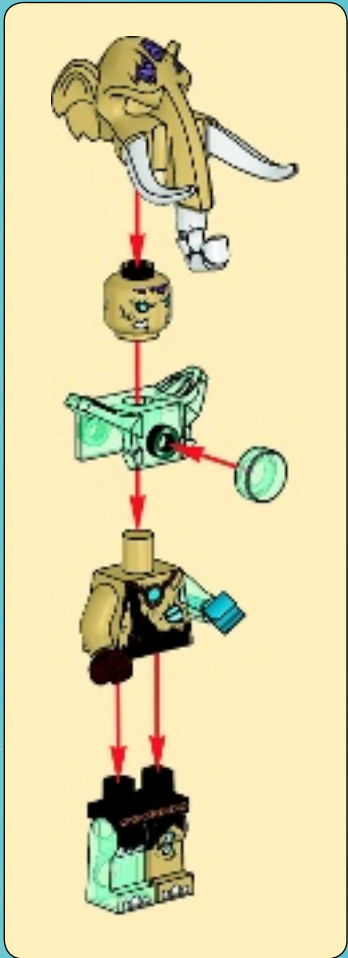
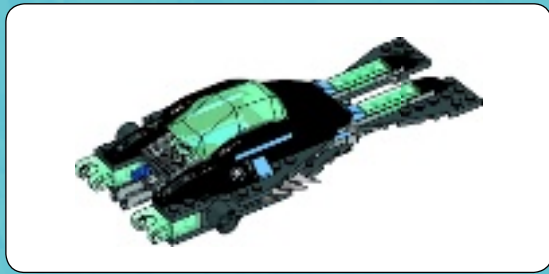
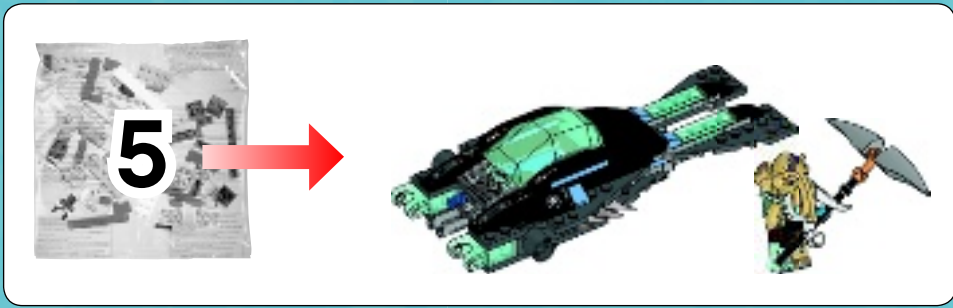

1

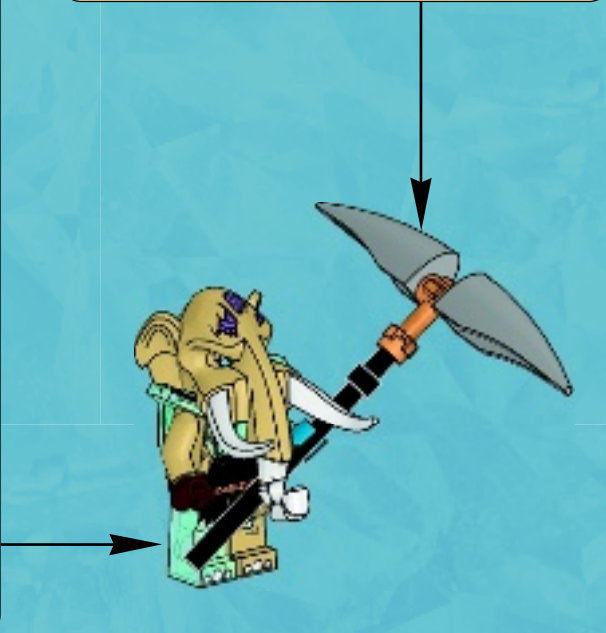



2

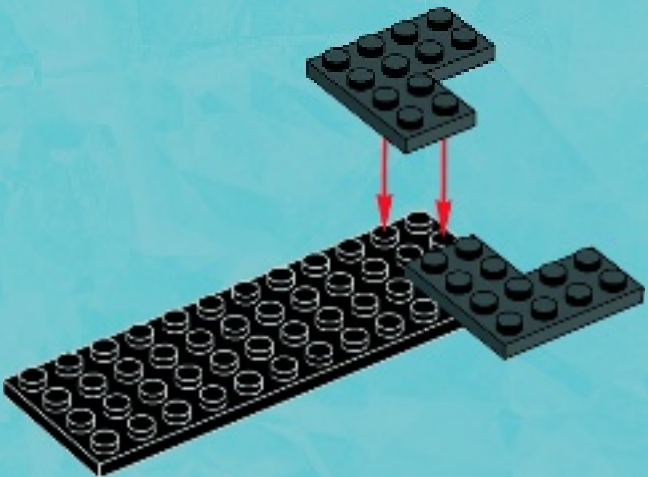

3

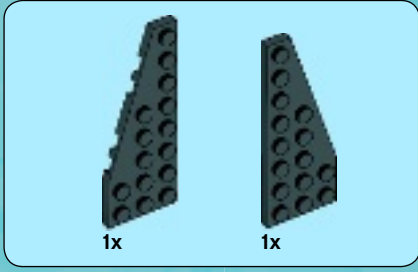
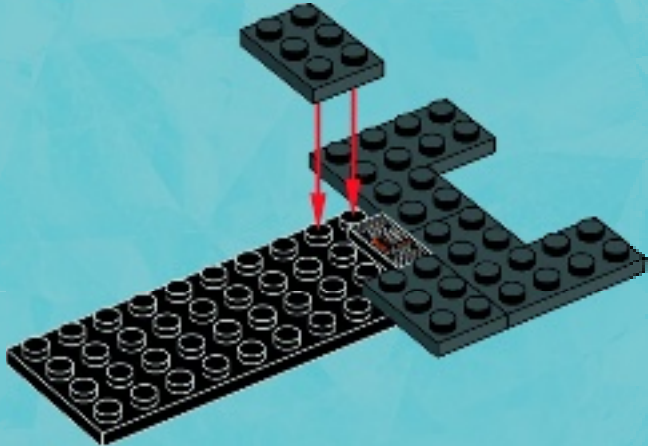

4





3x

5

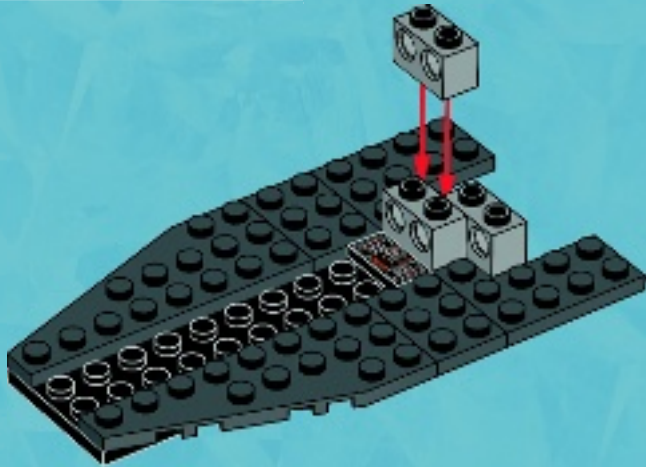

2x

6

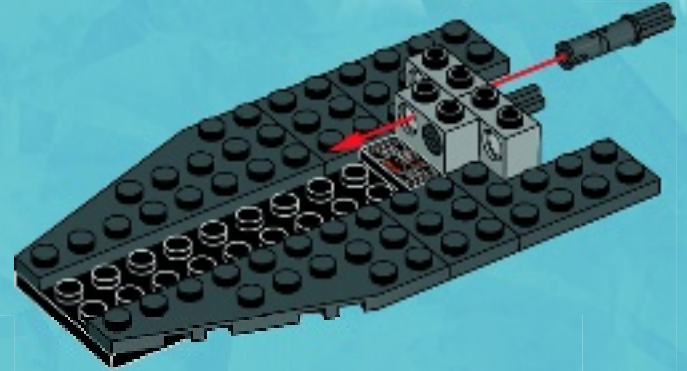

2x

7





8

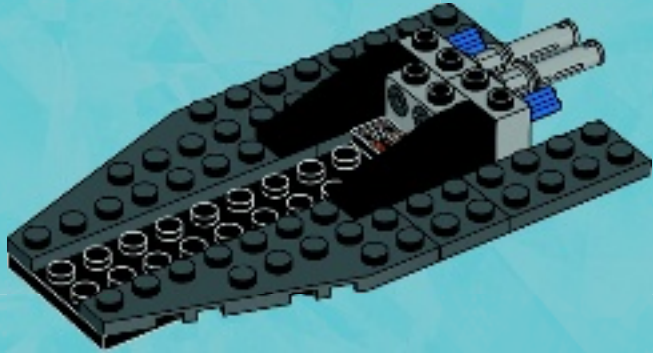

9

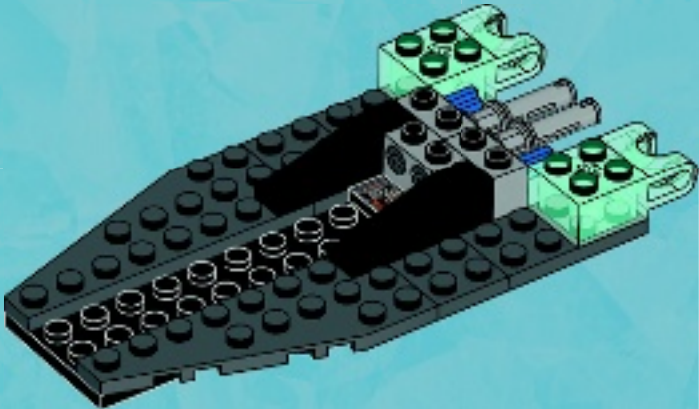

10

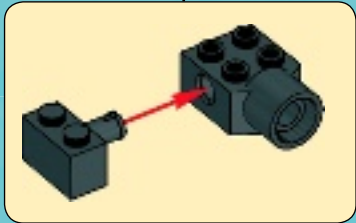
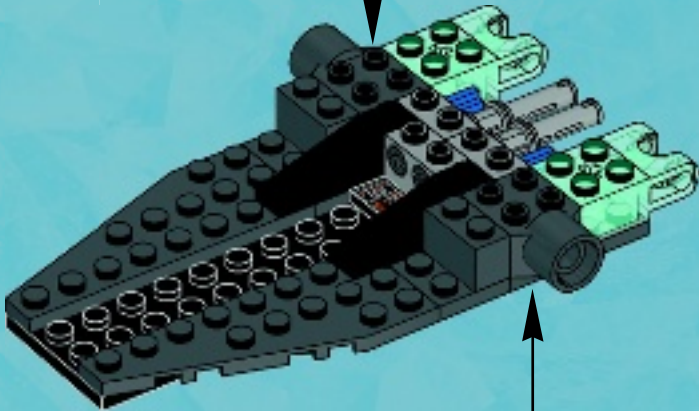
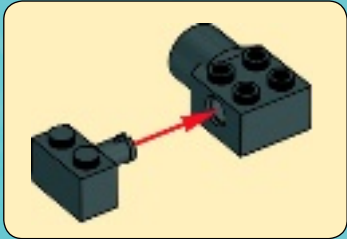



2x

11

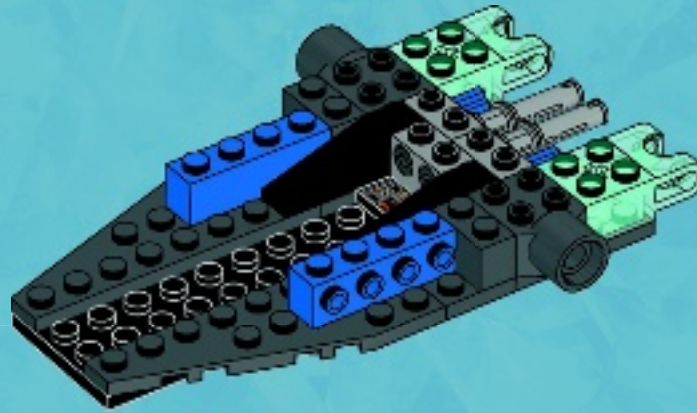

1x



1x



8x

12

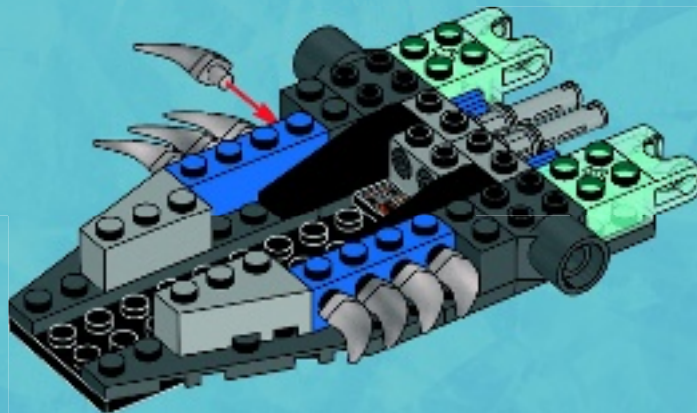

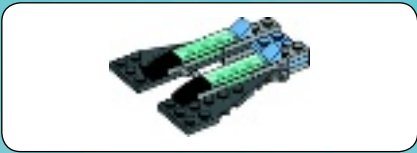

1x

1

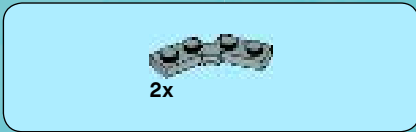
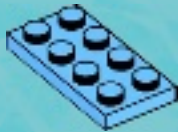

2x

2

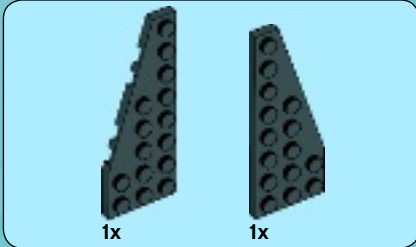
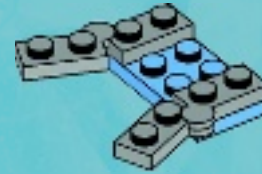

1x

1x

3

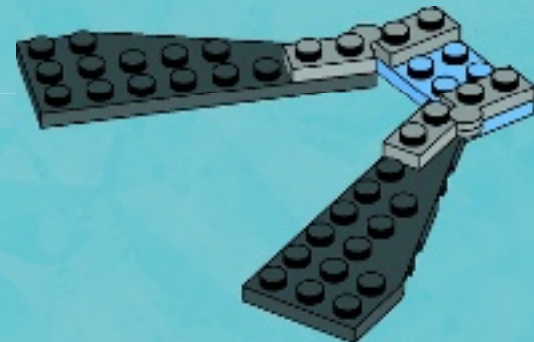



2x



2x

4

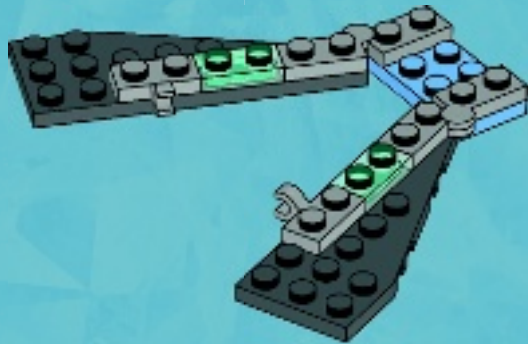

2x



2x

5

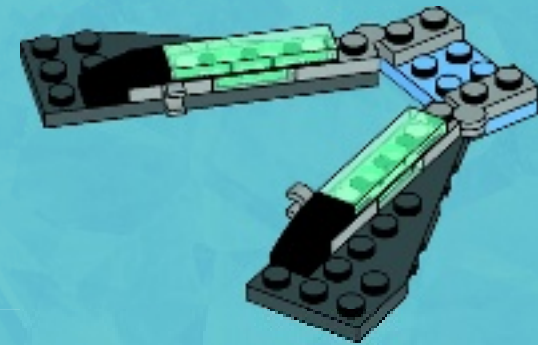

2x

6

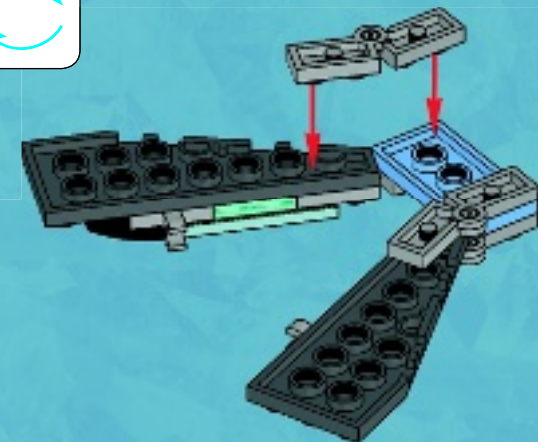
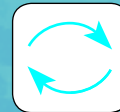



2x

7

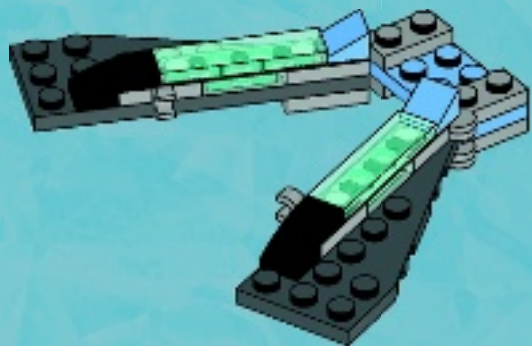
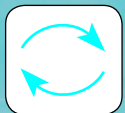

13

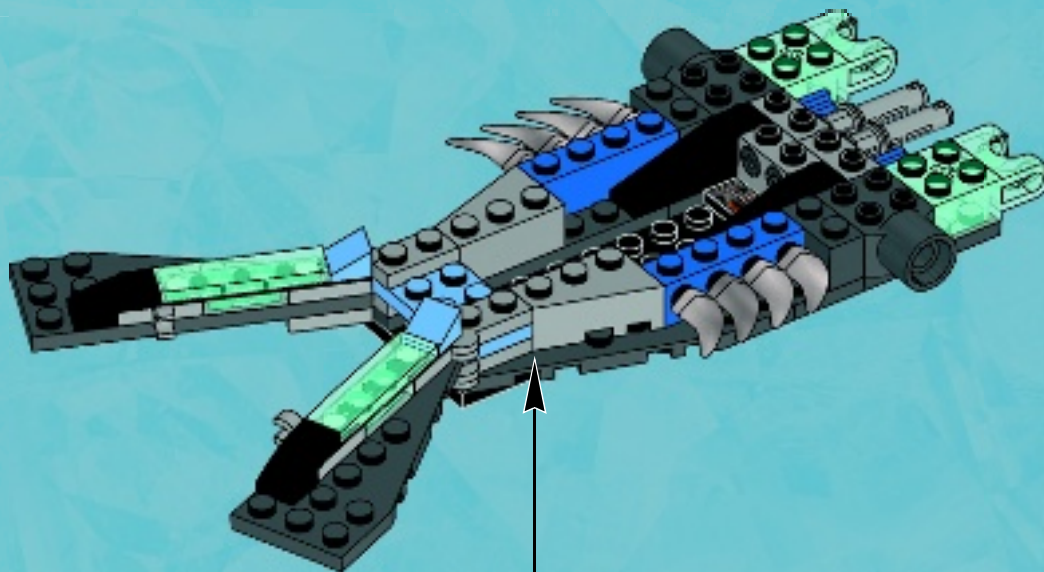

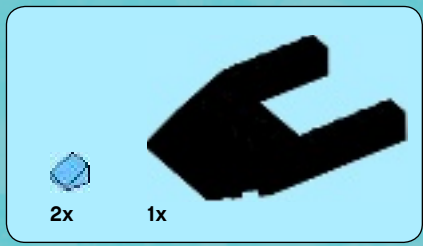

16

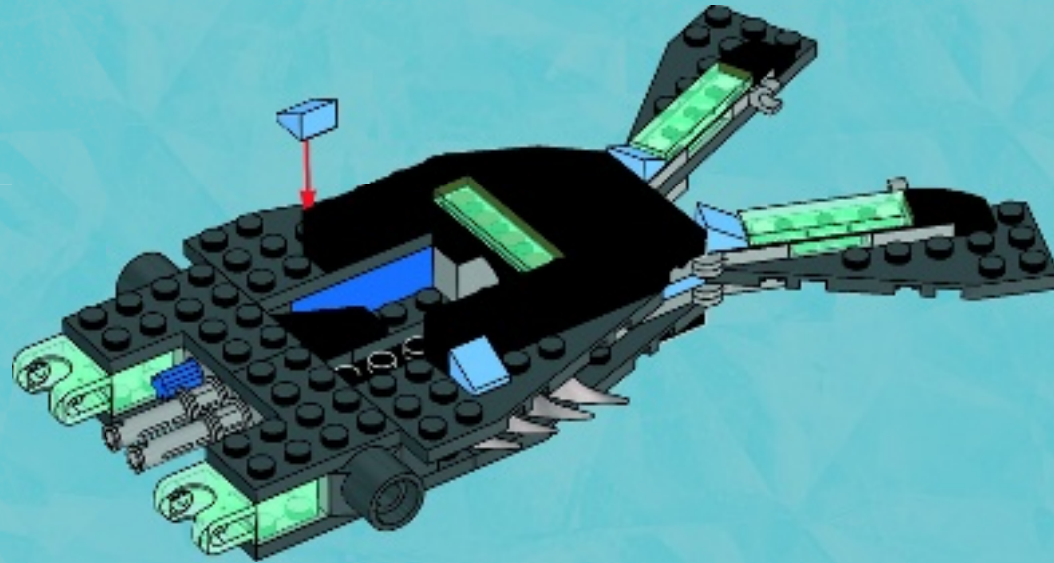



2x



2x

17

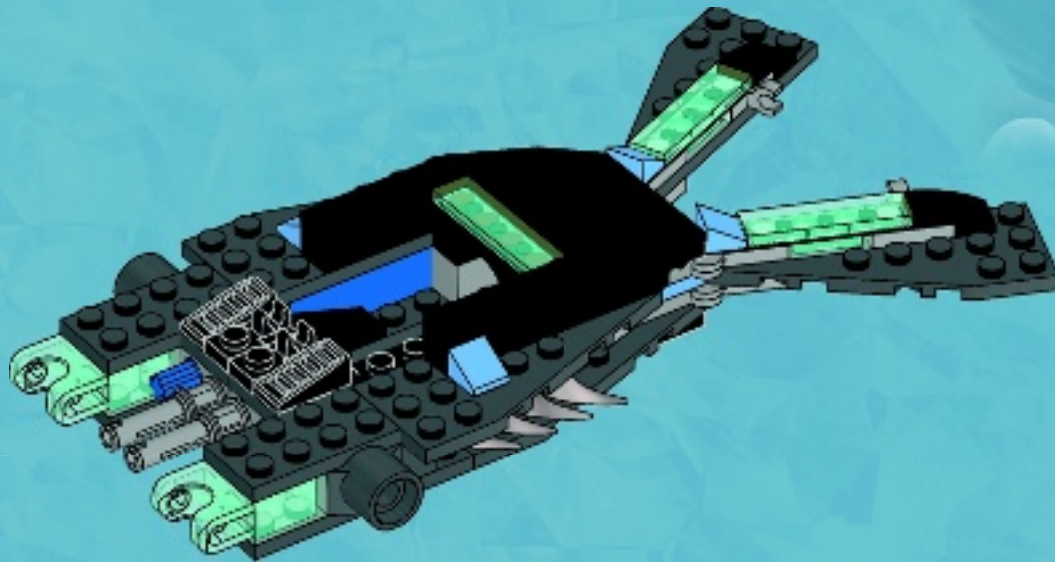

1x



1x

18

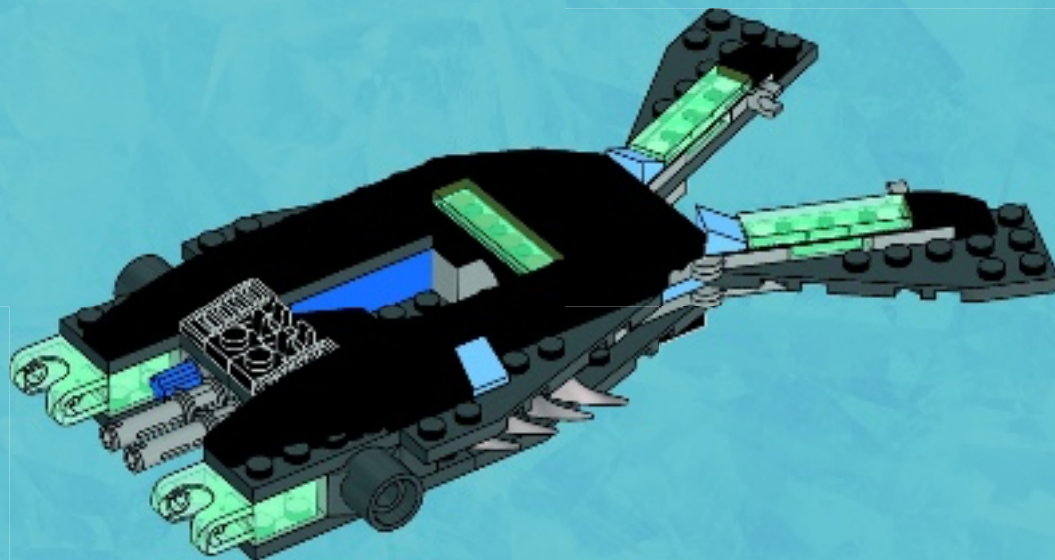

19

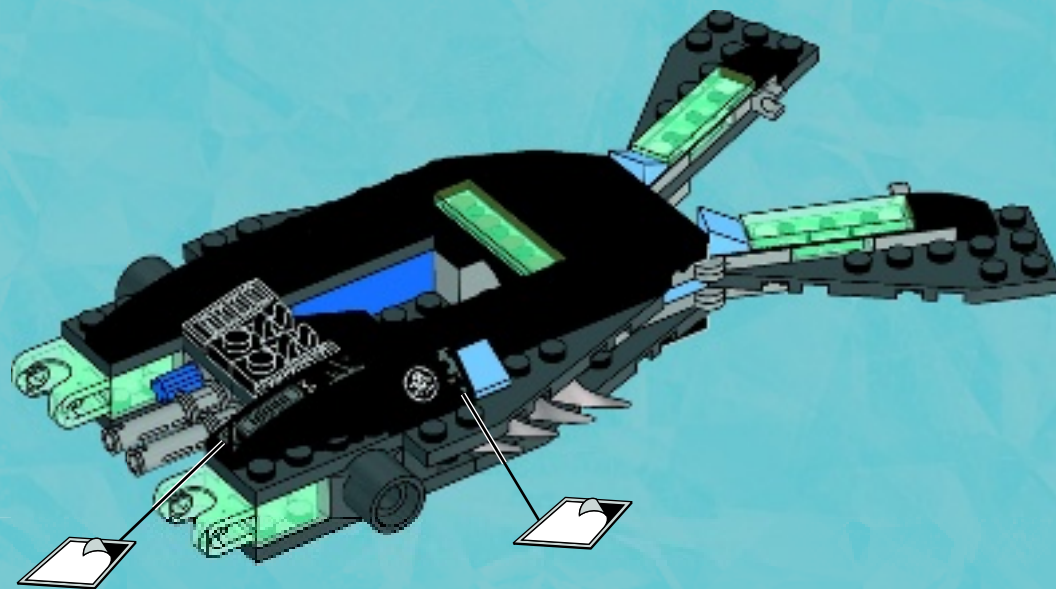

20

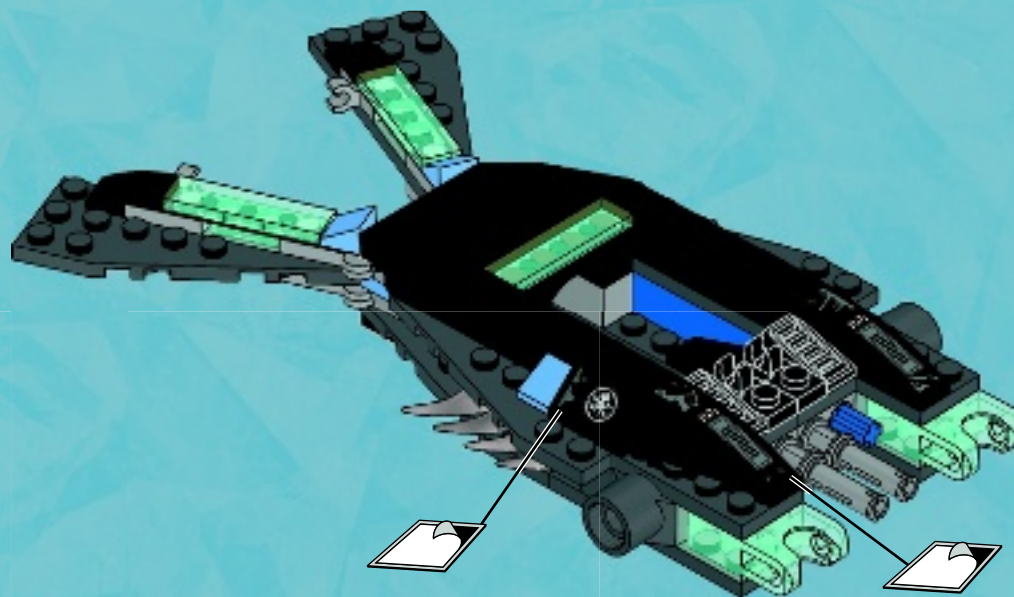
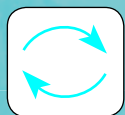



21

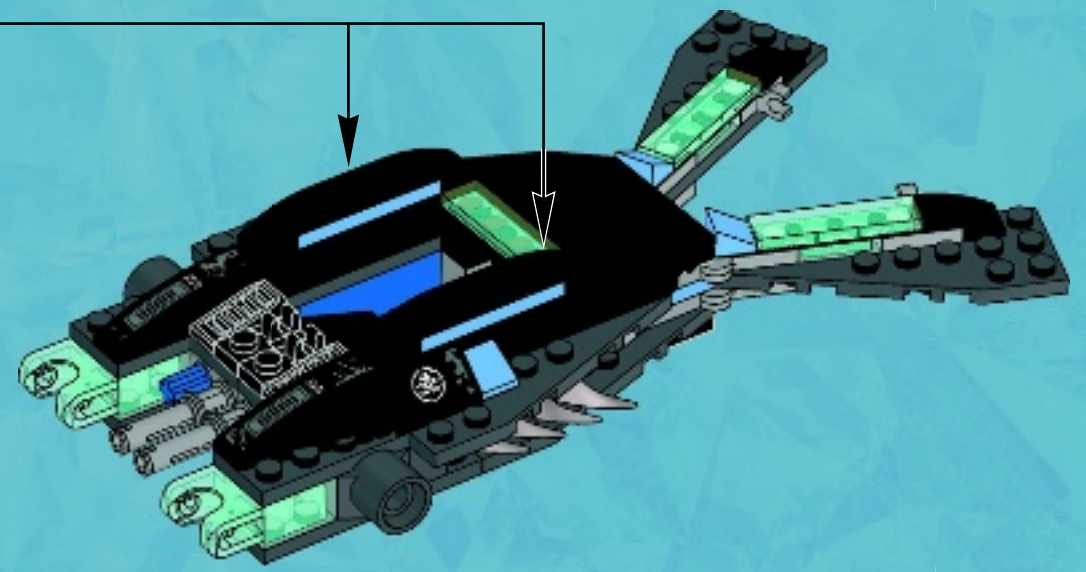
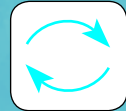
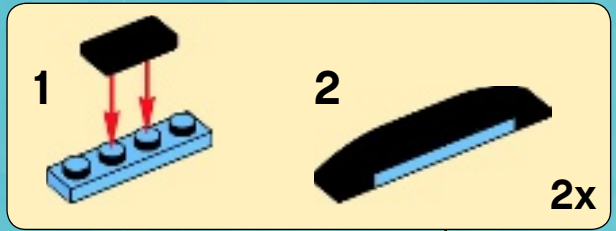

22

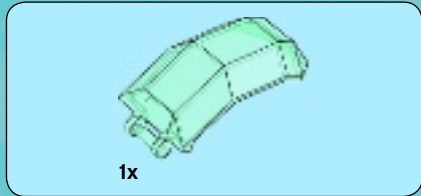
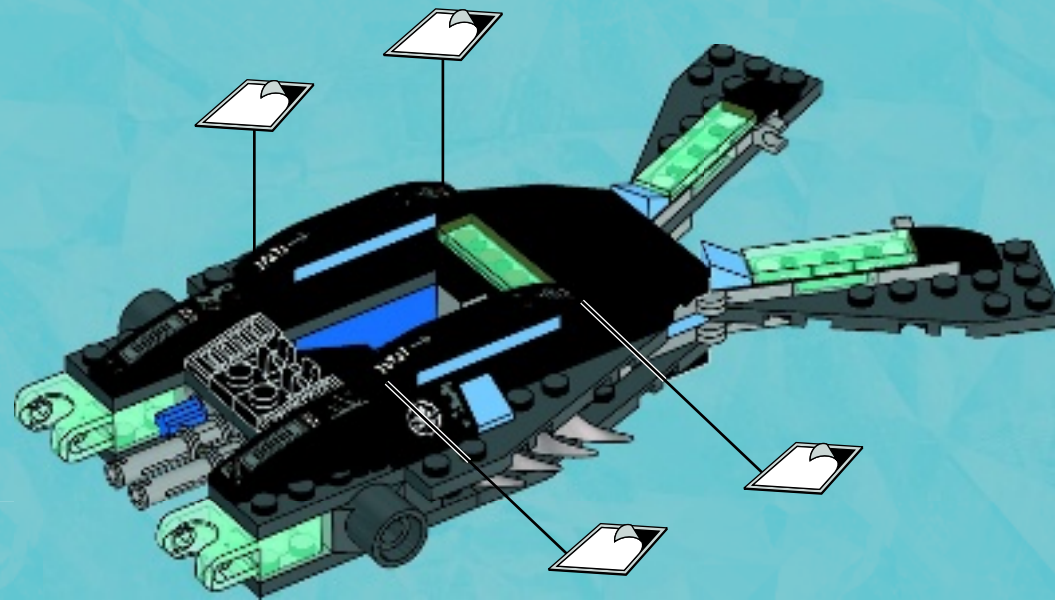

23

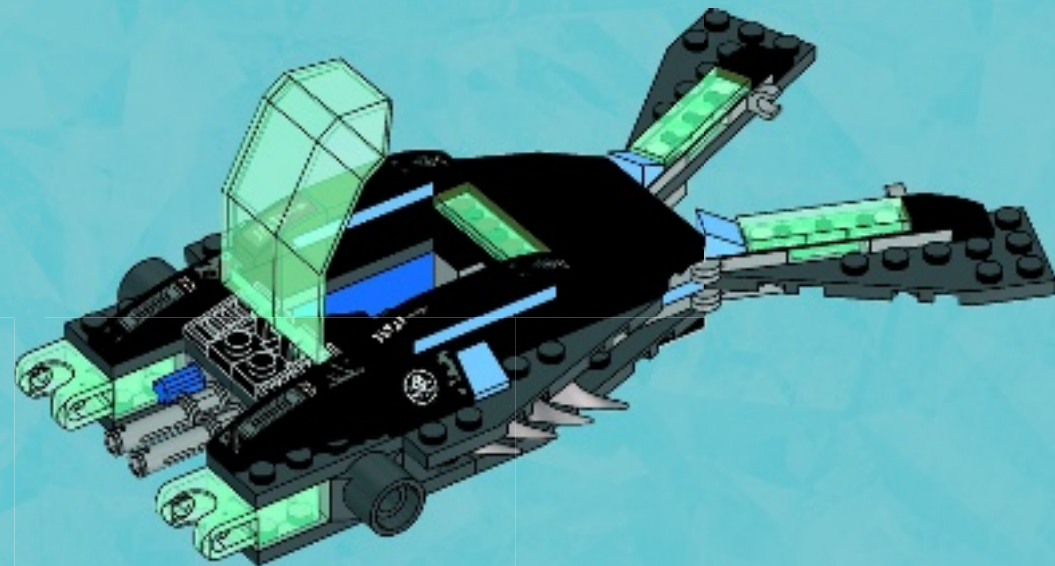

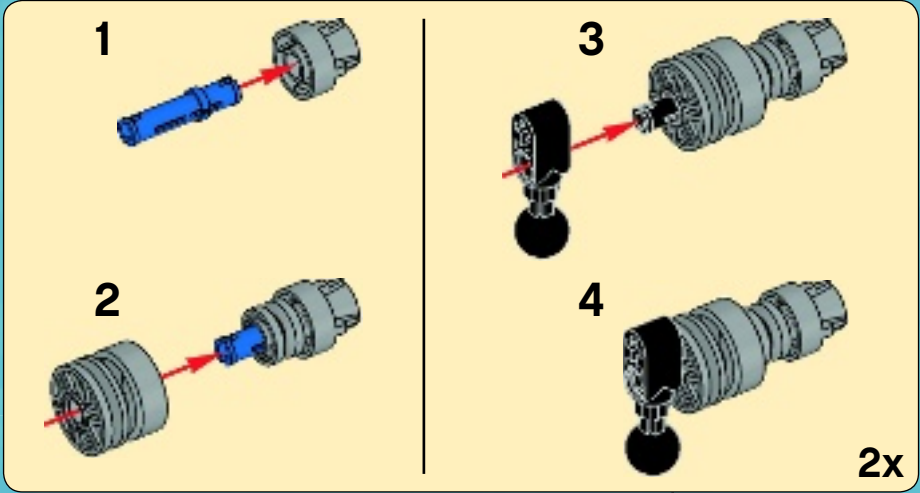
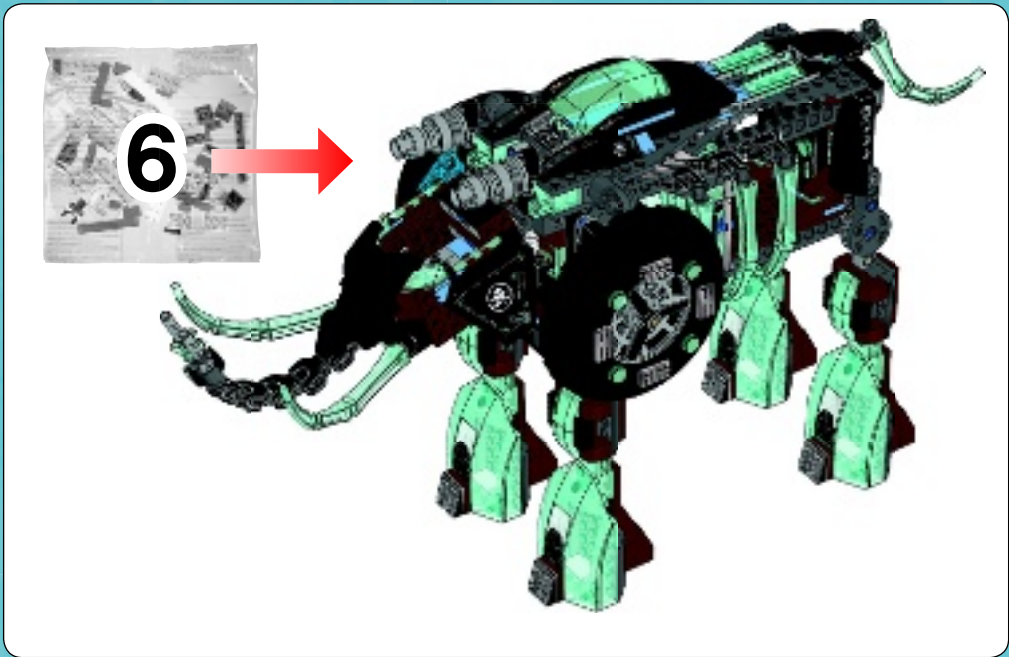

24

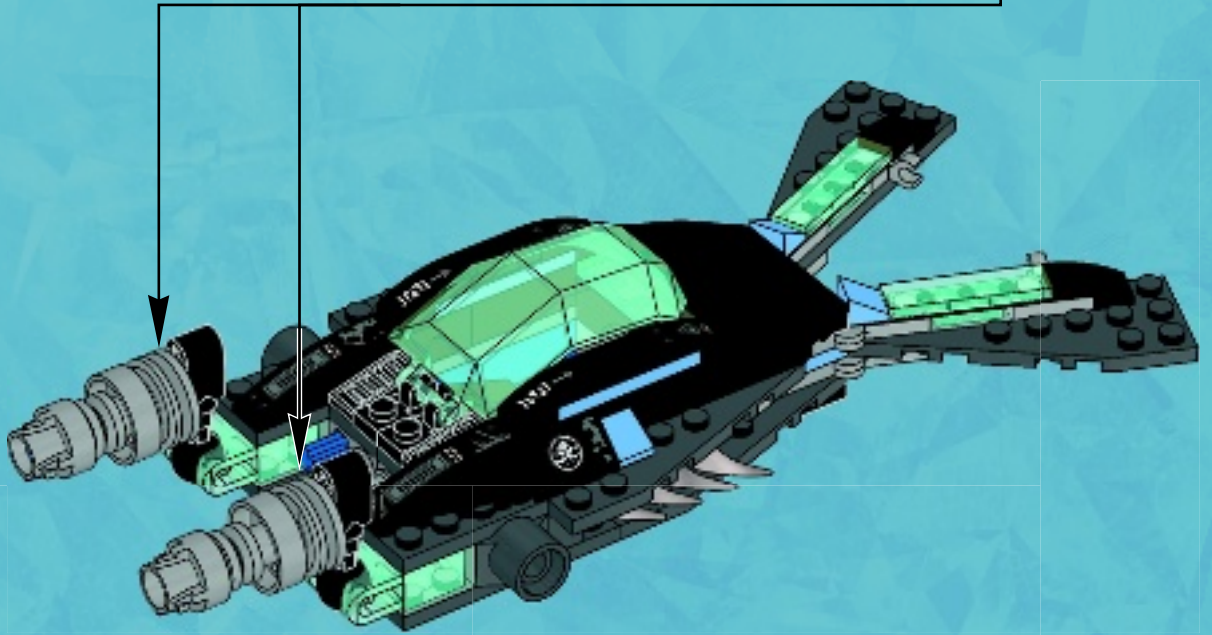

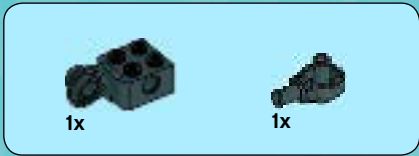

1

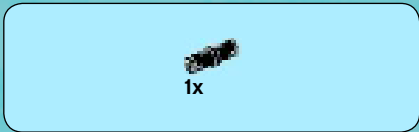
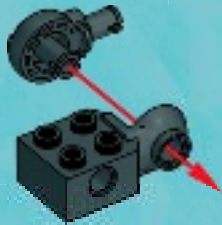

2

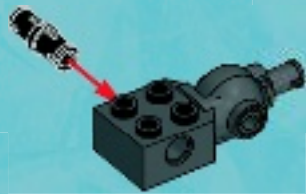

3



4

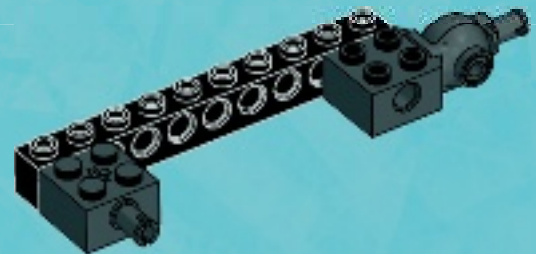

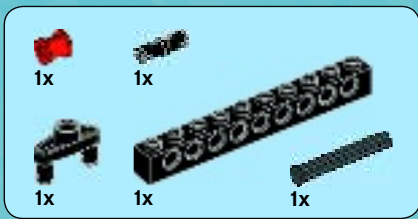

5

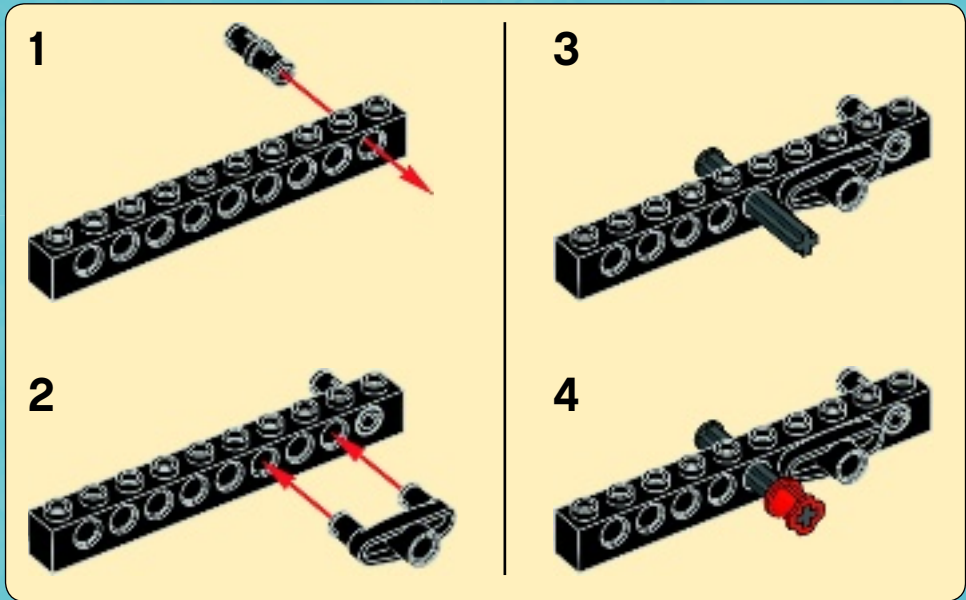

6

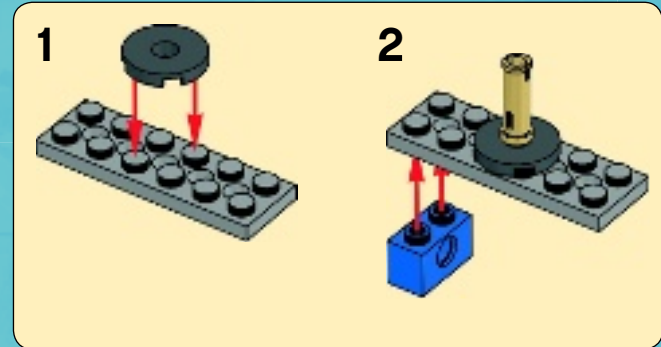

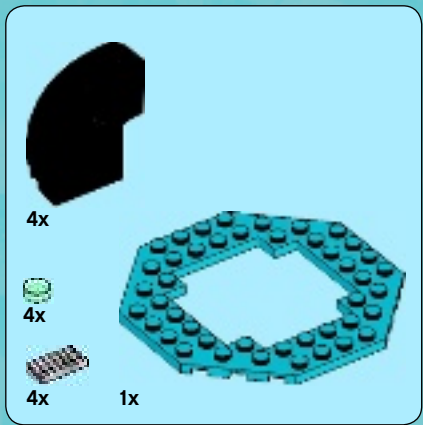

7

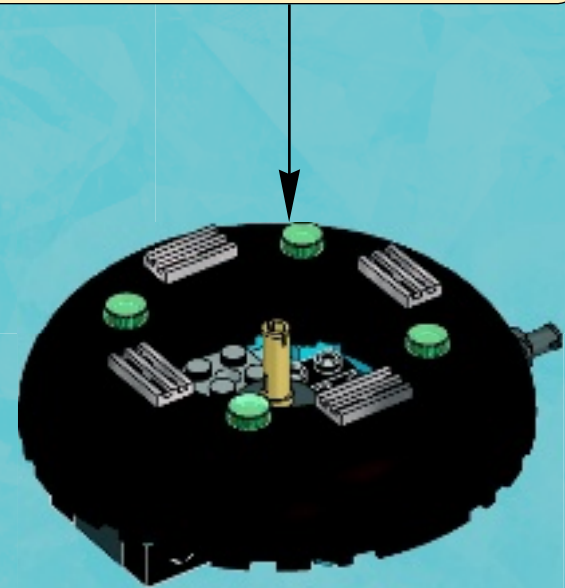
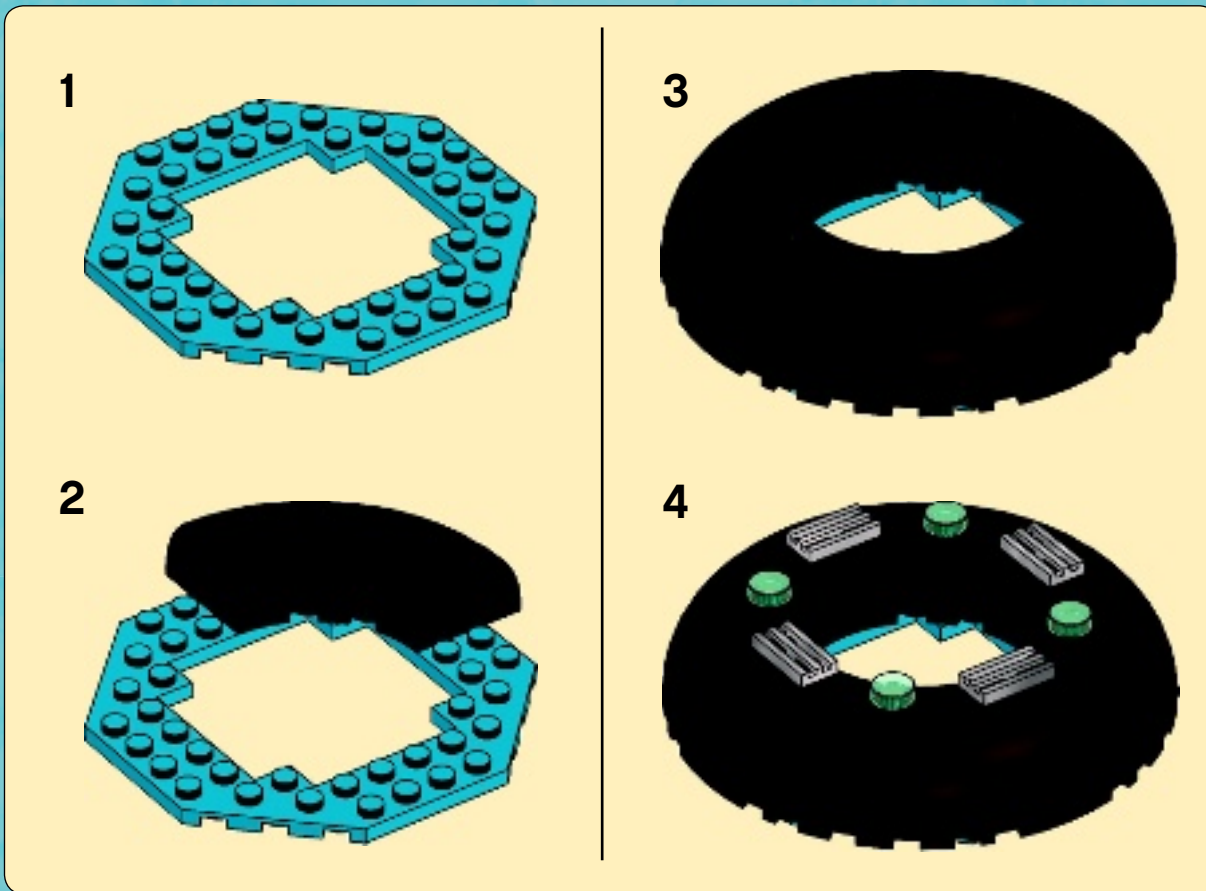

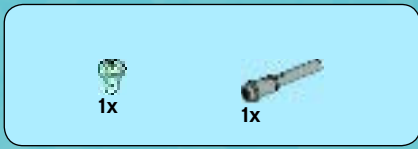

8

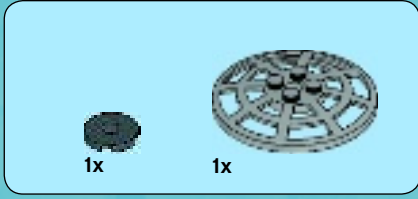
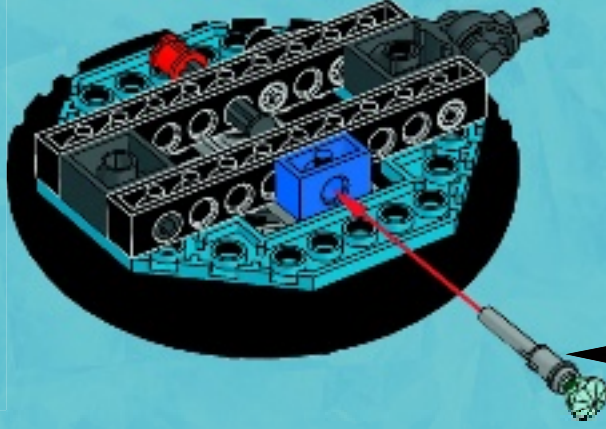

9

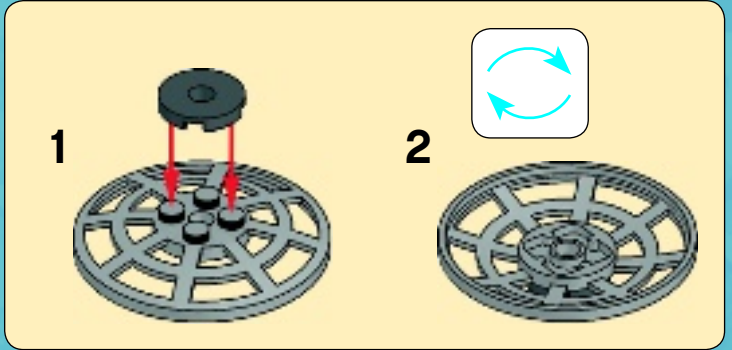
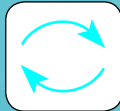

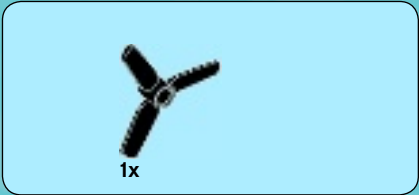

10



25

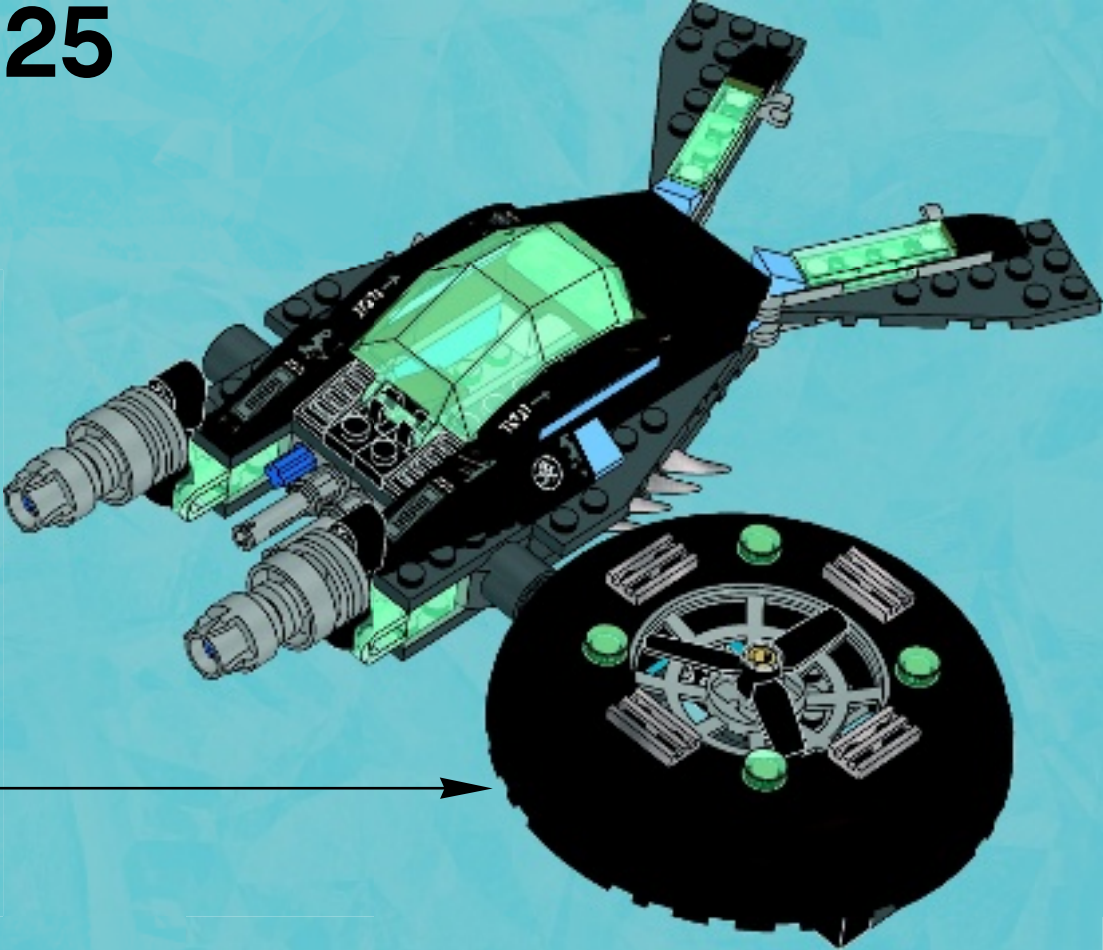



1



2



3



4



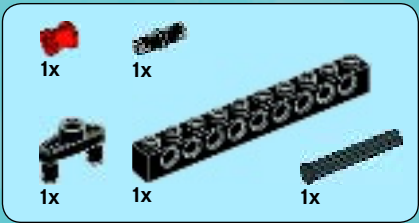

5

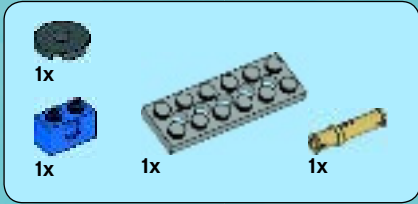
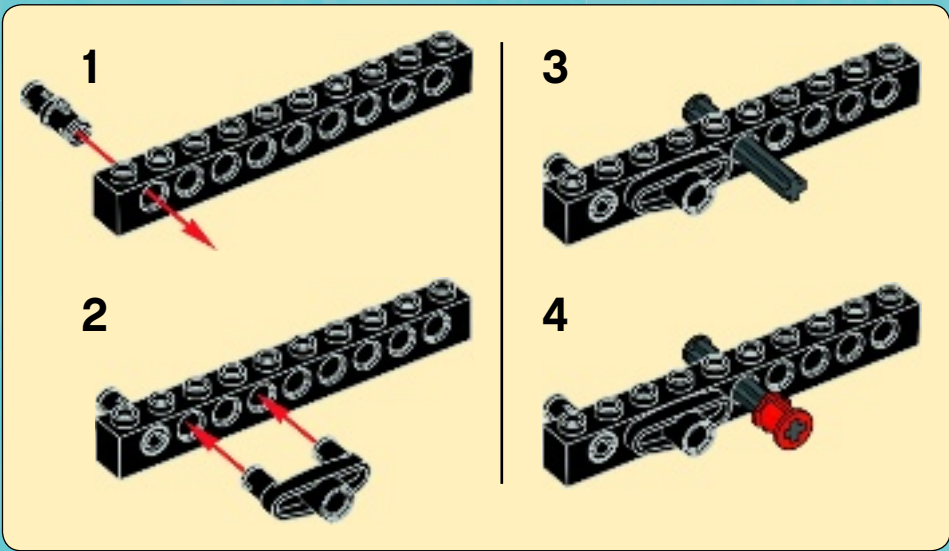

6

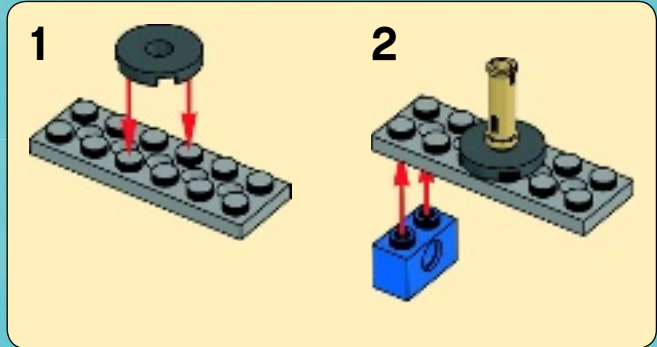

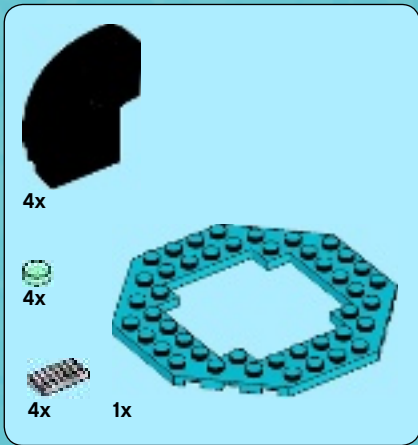

7

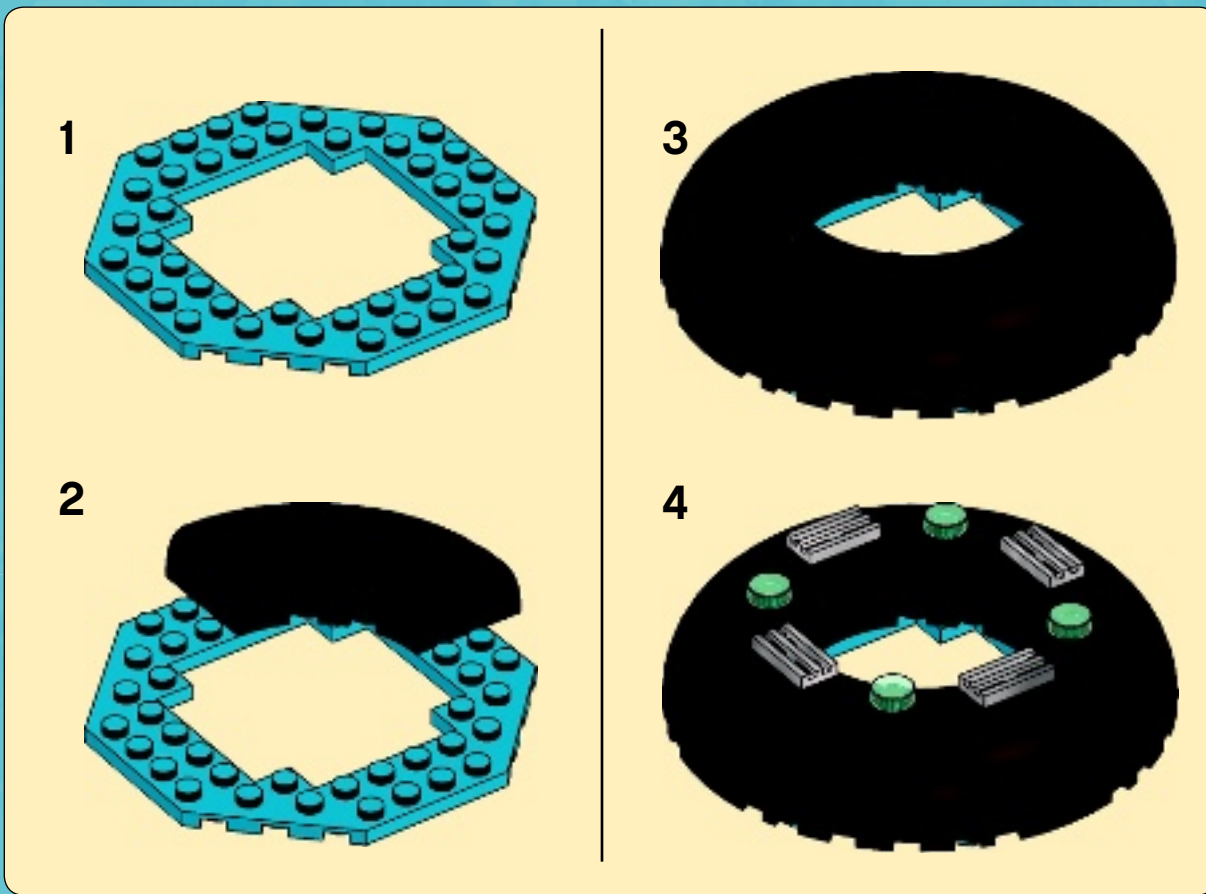

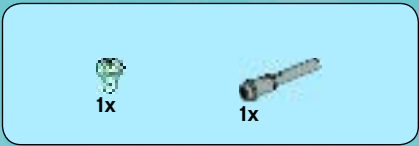

8

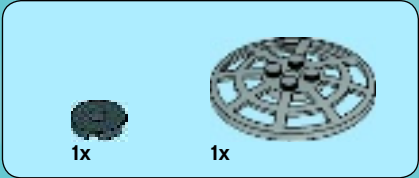
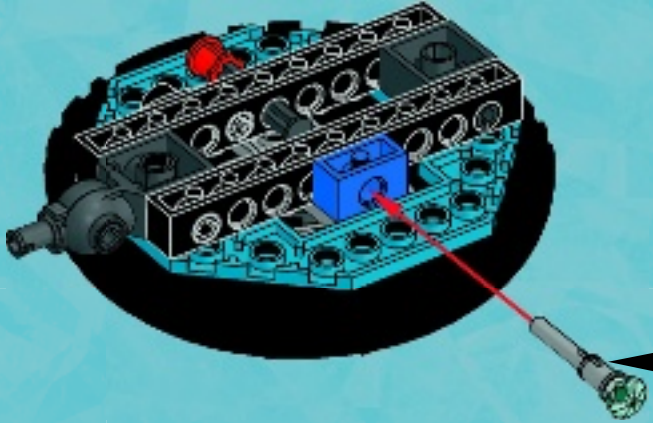

9

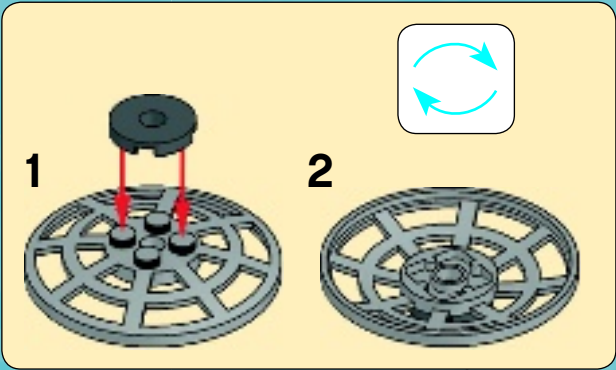



10



26

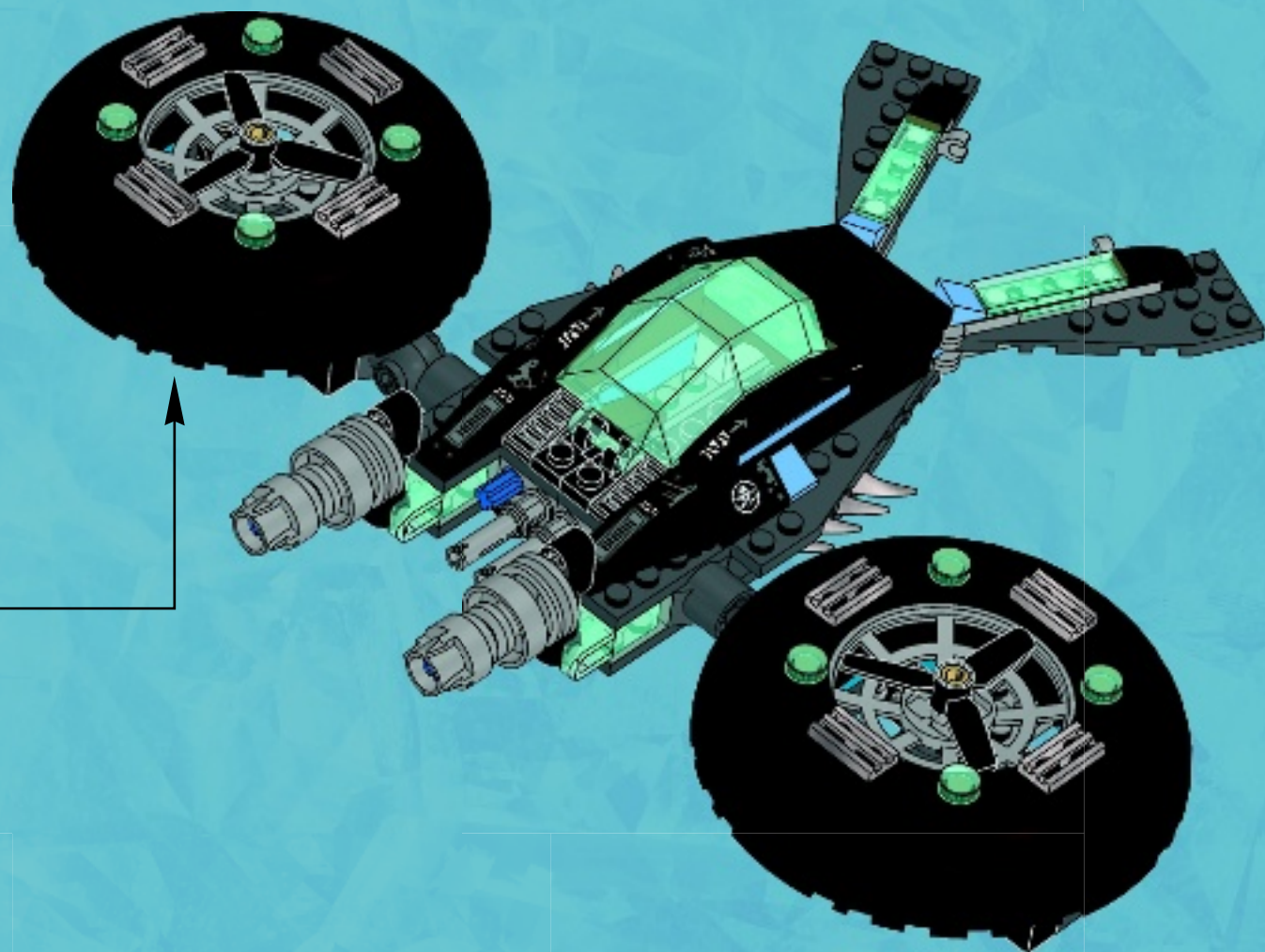

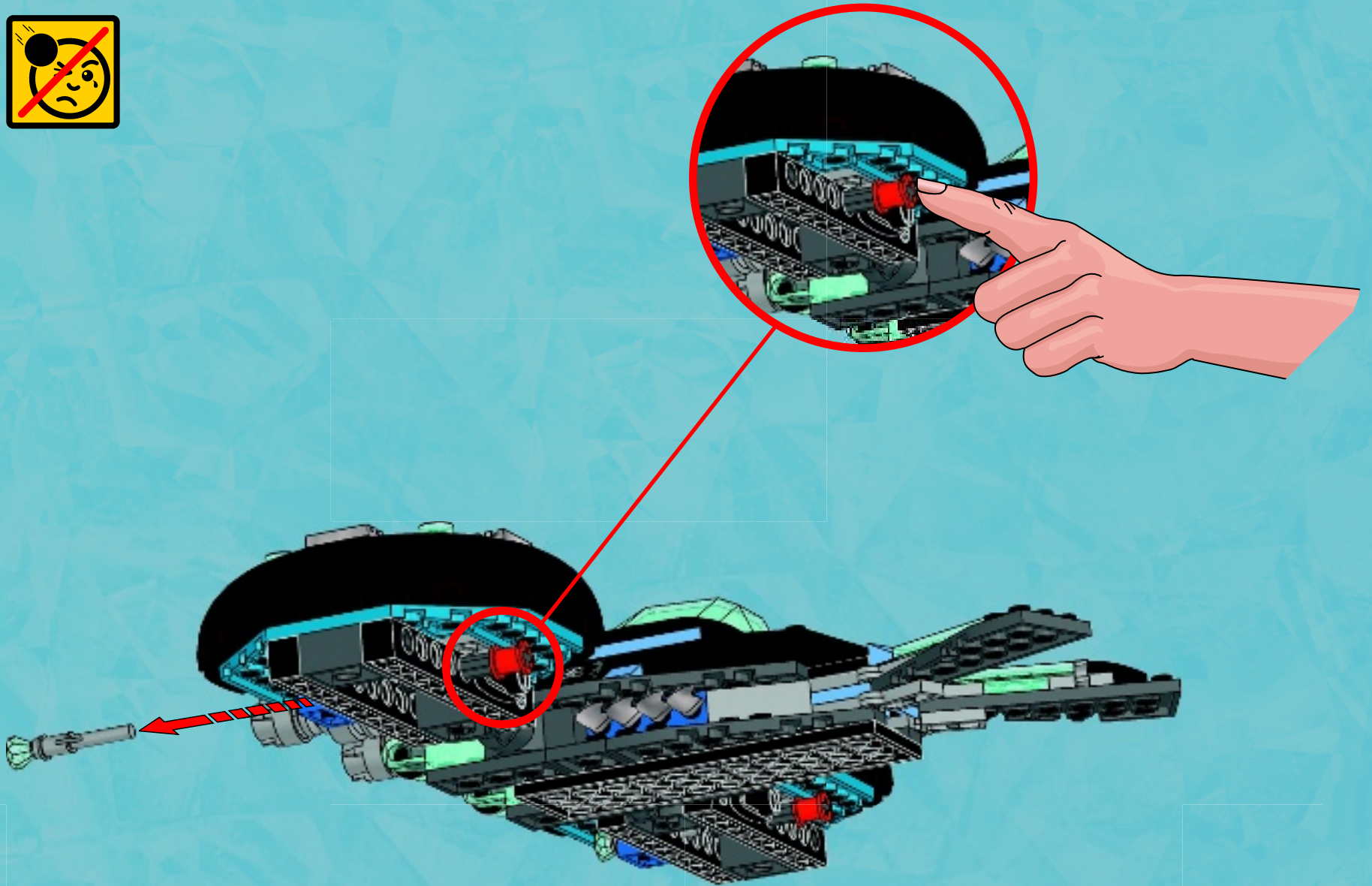

36

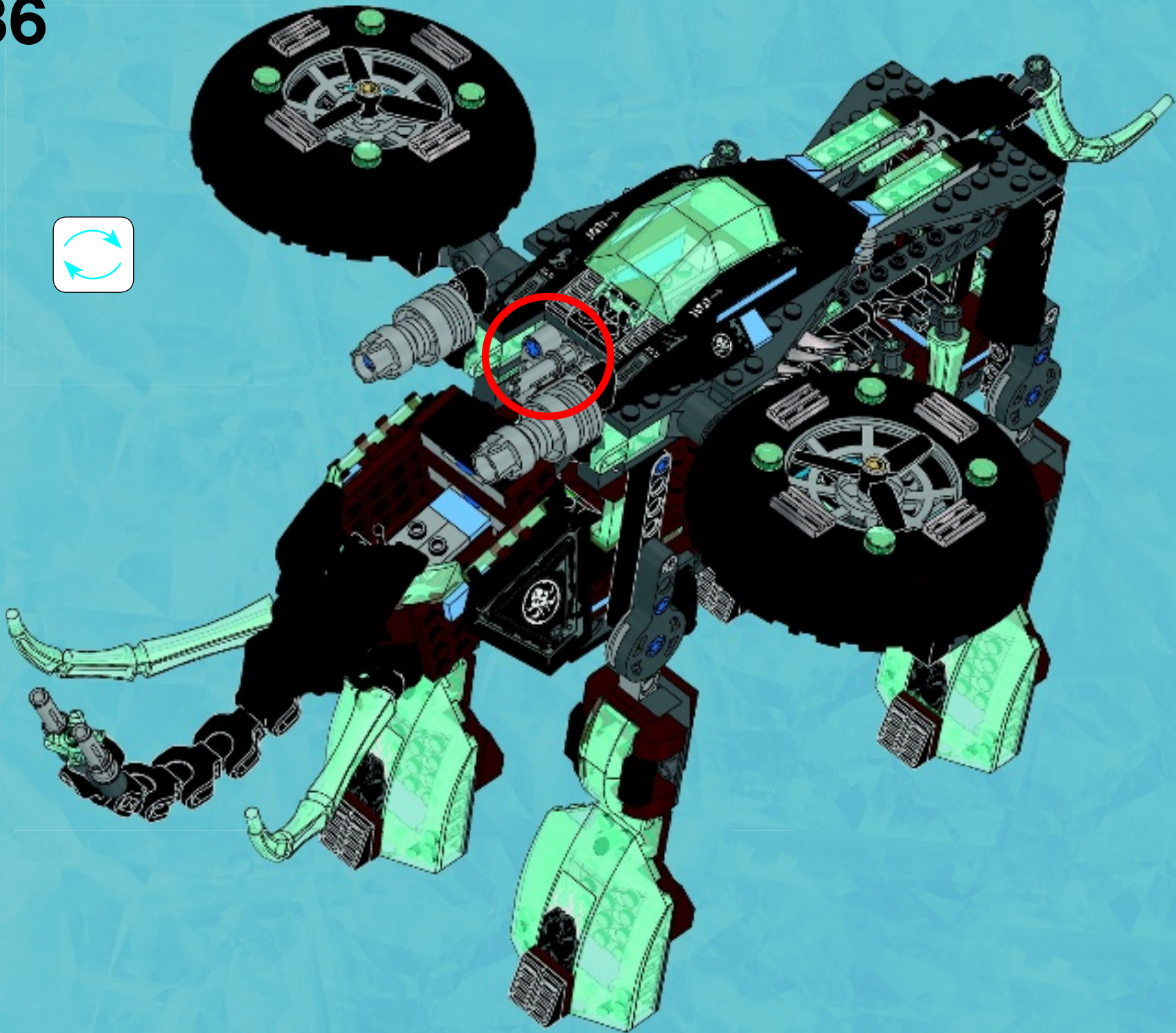

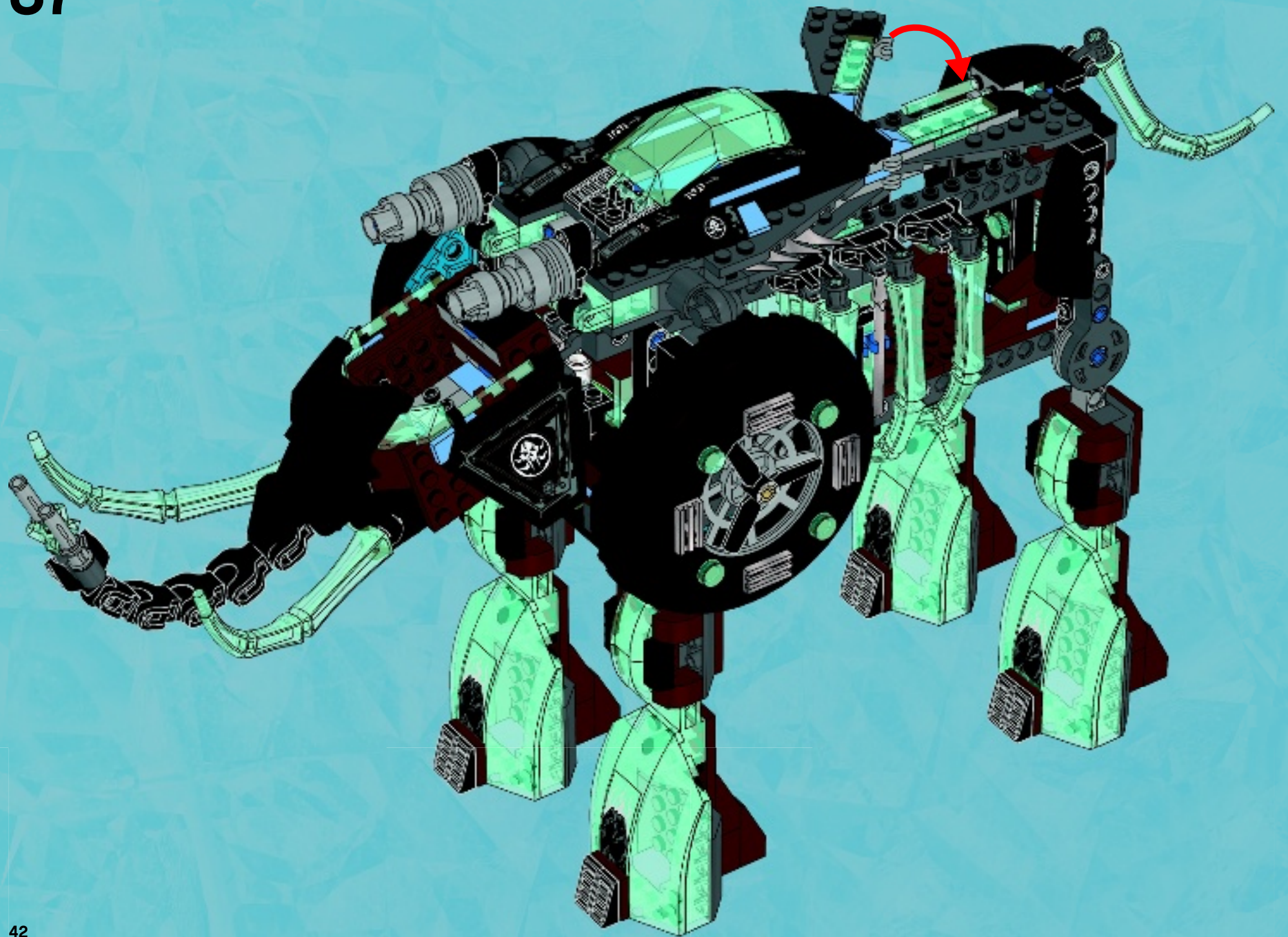



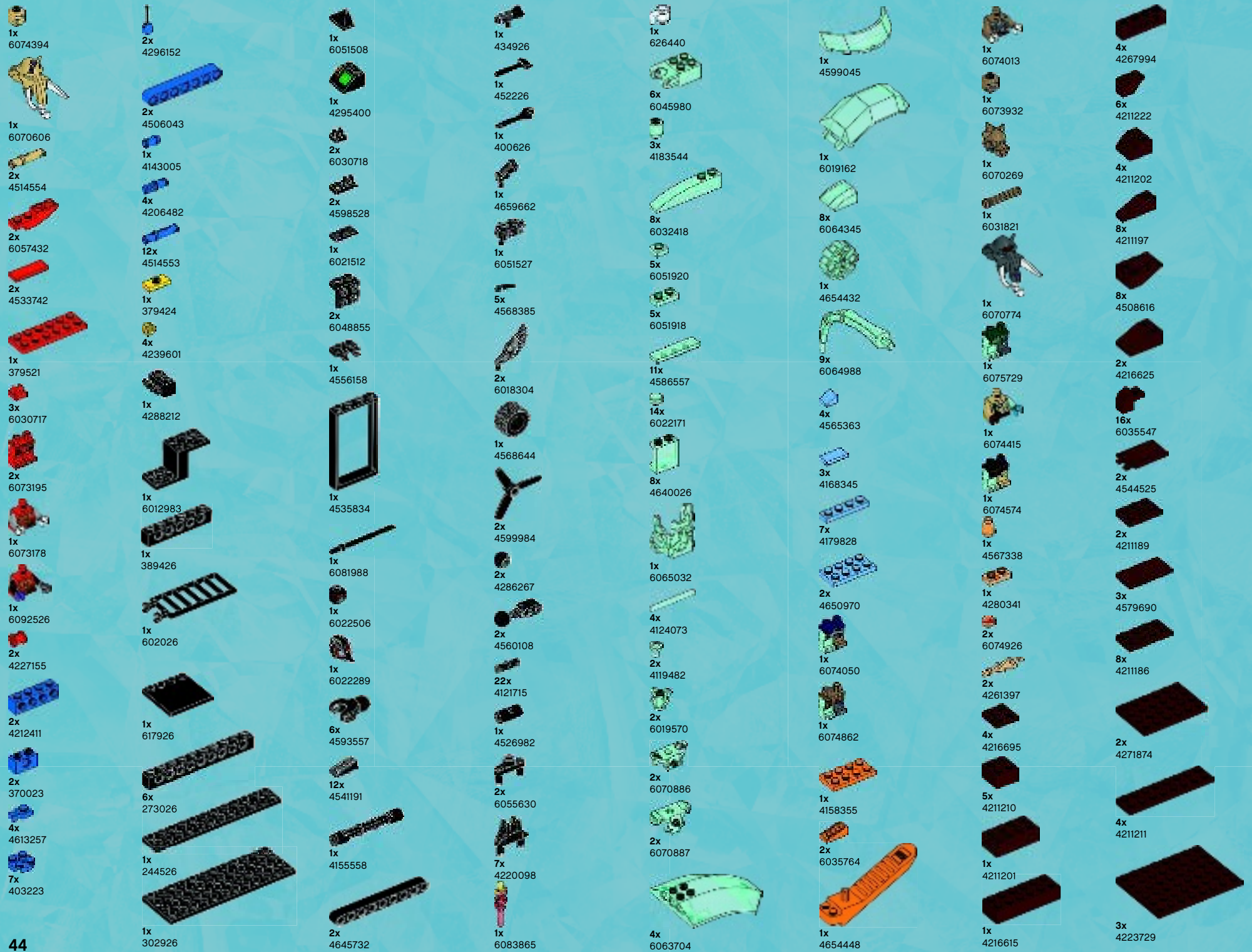



Customer Service
 Kundenservice
 Service Consommateurs
 Servicio Al Consumidor
 LEGO.com/service or dial

 : 00800 5346 5555
 : 1-800-422-5346

NEW APP!
DOWNLOAD
NOW!



LEGENDS OF
CHIMA
ONLINE™

NOUVELLE APP!
TÉLÉCHARGER
MAINTENANT!



© 2014 The LEGO Group.™ & © WBEL. (s14)

Only supported in US and Canada. Playable on iPad 2 and up, iPad mini, iPhone 4S and up and iPod touch 5th generation and up. Apple, the Apple logo and iPad are trademarks of Apple Inc., registered in the U.S. and other countries. App Store is a service mark of Apple Inc. All other trademarks and copyrights are the property of their respective owners.

Offert uniquement aux États-Unis et au Canada. Fonctionne sur iPad 2 et supérieur, iPad mini, iPhone 4S et supérieur et iPod touch 5e génération et supérieur. Apple, le logo Apple, et iPad sont des marques de commerce d'Apple Inc., déposées aux États-Unis et dans d'autres pays. App Store est une marque de service d'Apple Inc. Toutes les autres marques de commerce et copyrights appartiennent à leurs propriétaires respectifs.

Sólo válido en EE. UU. y Canada. Compatible con iPad 2 y modelos posteriores, iPad mini, iPhone 4S y modelos posteriores, e iPod touch de 5a generación y modelos posteriores. Apple, el logotipo de Apple e iPad son marcas comerciales de Apple Inc., registradas en EE.UU. y otros países. App Store es una marca de servicio de Apple Inc. El resto de marcas comerciales y derechos de autor son propiedad de sus respectivos propietarios.



CHIMAONLINE.COM

**ENTER FIRE CHI POWER MODE!
ENTRE EN MODE DE PUISSANCE
CHI DE FEU!
¡ACTIVA EL MODO
DE CHI DEL
FUEGO!**



70142

70144

70146

**DETACHABLE VEHICLE INCLUDED!
VEHICULE DETACHABLE INCLUS!
¡INCLUYE UN VEHICULO
DESMONTABLE!**



70141

70143

70145



LAVAL

70144, 70156



CRAGGER

70144, 70150



WORRIZ

70145, 70149



ERIS

70142



RAZAR

70145



FLUMINOX

70146, 70155



FLINX

70146



GORZAN

70143



LEGENDS OF
CHIMATM



MAULA

70145



MOTTROT

70145



VARDY

70141



SIR FANGAR

70143, 70156



STRAINOR

70142, 70145



STEALTHOR

70143, 70146



VOOM VOOM

70146, 70151



MUNGUS

70144





LEGENDS OF CHIMA™



...Or visit: - Ou visitez : - O visita:

LEGO.COM/CHIMA

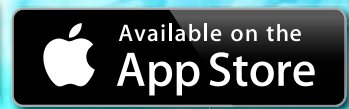

Apple, the Apple logo, iPad, iPhone and iPod touch are trademarks of Apple Inc., registered in the U.S. and other countries. App Store is a service mark of Apple Inc./Apple, le logo Apple, iPad, iPhone et iPod touch sont des marques de commerce d'Apple Inc., déposées aux Etats-Unis et dans d'autres pays. App Store est une marque de service d'Apple Inc./Apple, el logotipo de Apple, iPad, iPhone e iPod touch son marcas comerciales de Apple Inc. registradas en EE. UU. y otros paises. App Store es una marca de servicio de Apple Inc.
Google Play is a trademark of Google Inc./Google Play est une marque de commerce de Google Inc./Google Play es una marca comercial de Google Inc.



LEGOLAND[®] PARKS

CALIFORNIA • FLORIDA



LEGOLAND[®] DISCOVERY CENTER

ATLANTA • CHICAGO • DALLAS/FORT WORTH
KANSAS CITY • TORONTO • WESTCHESTER



LEGO LEGENDS OF
CHIMA[™]

FIND OUT MORE AND GET SPECIAL OFFERS AT LEGOLAND-CHIMA.COM
OBTENEZ PLUS D'INFORMATIONS ET DES OFFRES SPÉCIALES SUR LEGOLAND-CHIMA.COM
MÁS INFORMACIÓN Y OFERTAS ESPECIALES EN LEGOLAND-CHIMA.COM

KIDS GO FREE

with full paid adult ticket

Purchase at LEGOLAND-CHIMA.com

Now through 12/31/17.

See website for terms and offer details.

LES ENFANTS ENTRENT GRATUITEMENT

à l'achat d'un billet pour adulte

Achat sur LEGOLAND-CHIMA.com

Dès maintenant et jusqu'au 31/12/17

Consultez le site Web pour obtenir les conditions
et les détails de l'offre

NIÑOS ENTRAN GRATIS

en la compra de una entrada
de adulto los

Compra en LEGOLAND-CHIMA.com

Ahora hasta el 31/12/17

Condiciones y detalles de la oferta en el sitio web



club™

Free*! Gratuit !

* Paid subscription in Australia and New Zealand.
Abonnement payant en Australie et Nouvelle-Zélande.

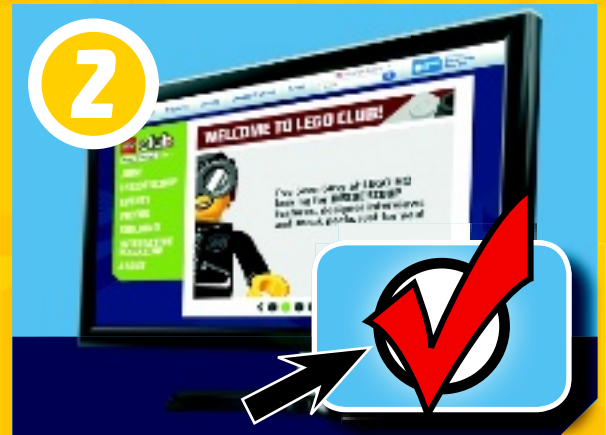

LEGO.com/club

LEGO, the LEGO logo and LEGENDS OF CHIMA are trademarks of the/son des marques de commerce de/son marcas registradas de LEGO Group. ©2014 The LEGO Group.6101206

