



LEGENDS OF

CHIMA

TM

70132



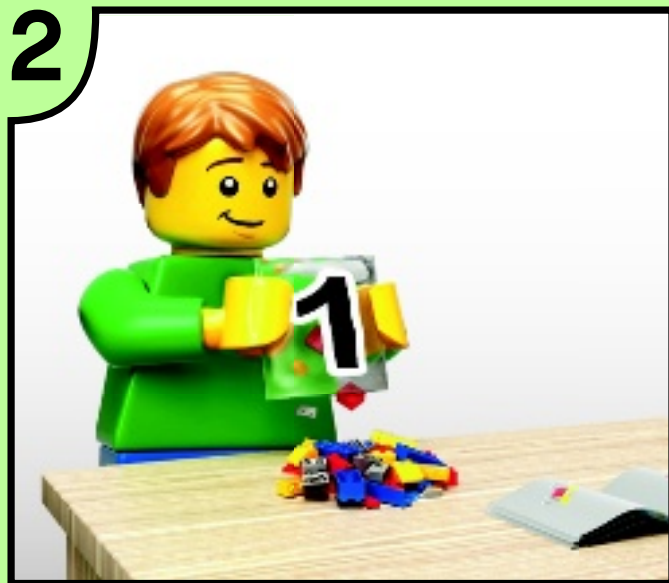

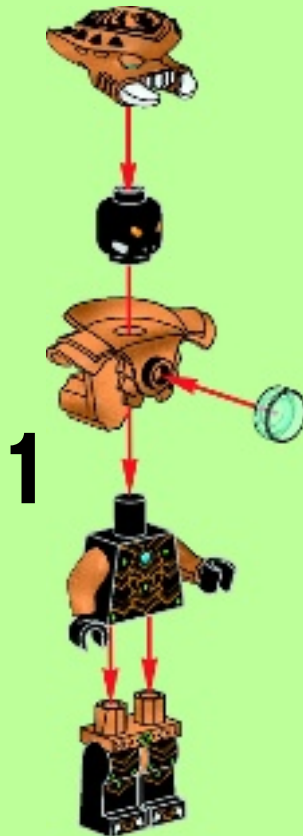
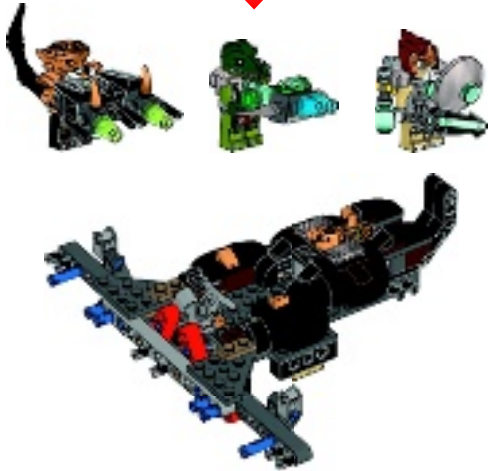



2x

1

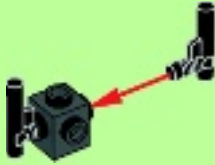

2



3



4



5



6



2x

3



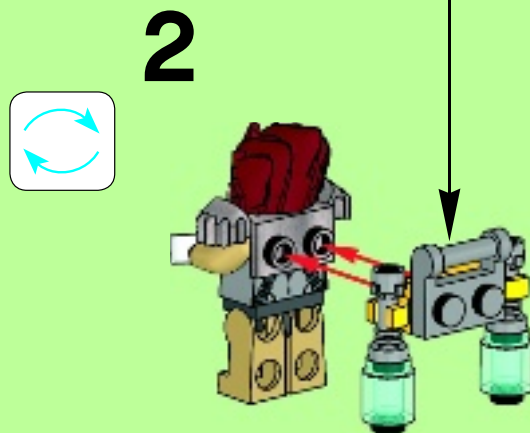
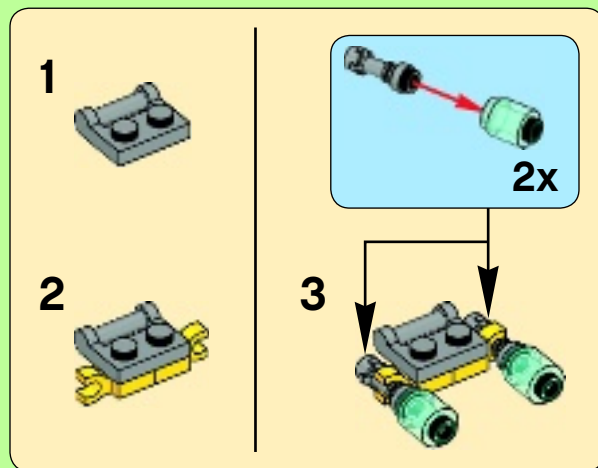
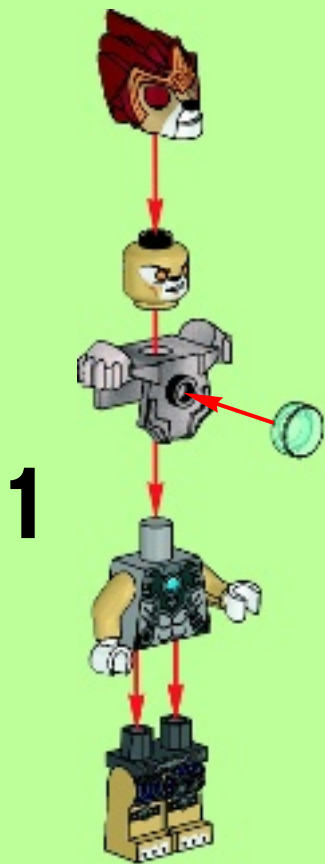

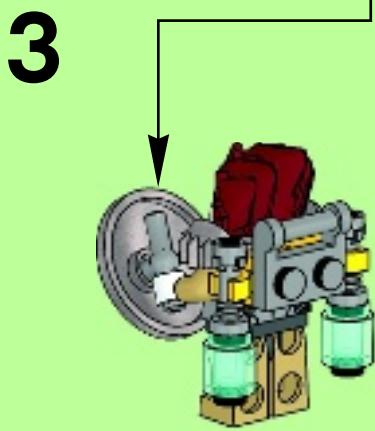
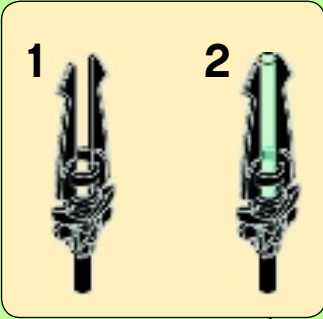
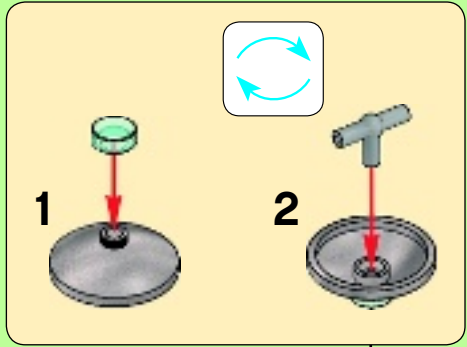

1

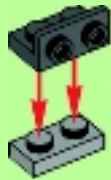

2



3



4

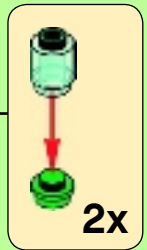
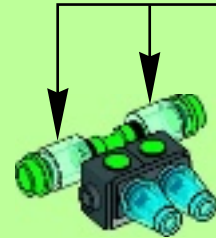

5



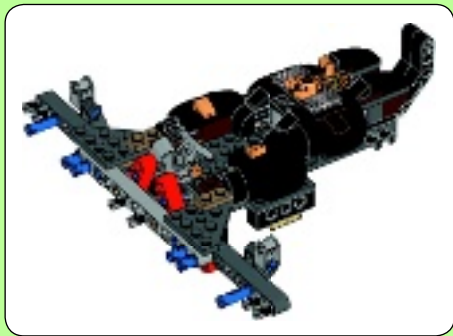

1



2



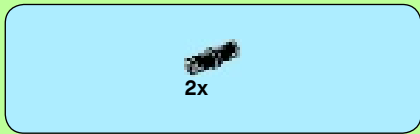

3

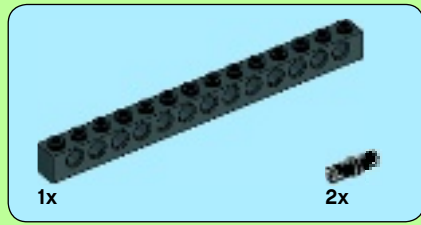

4

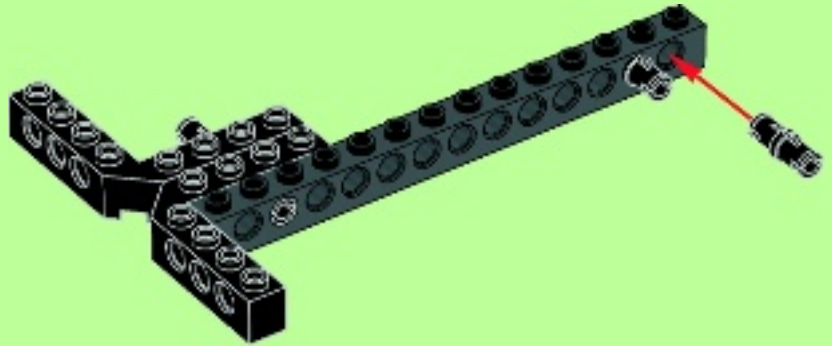



5

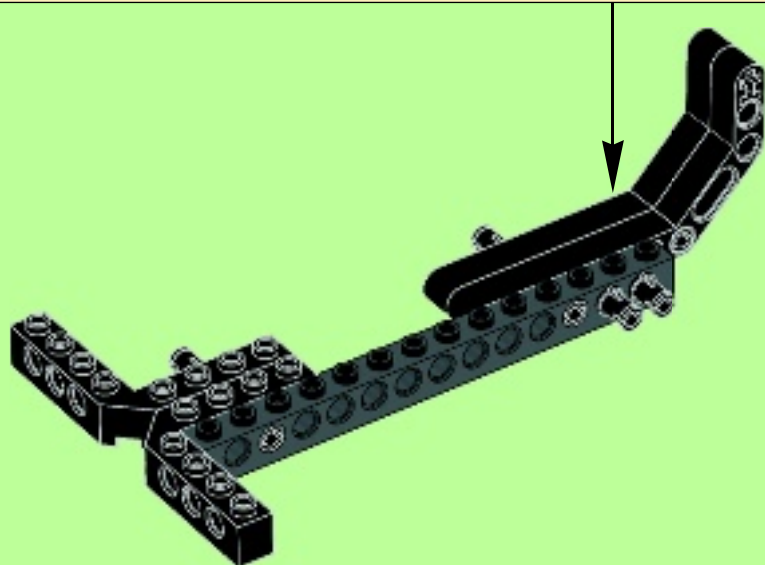
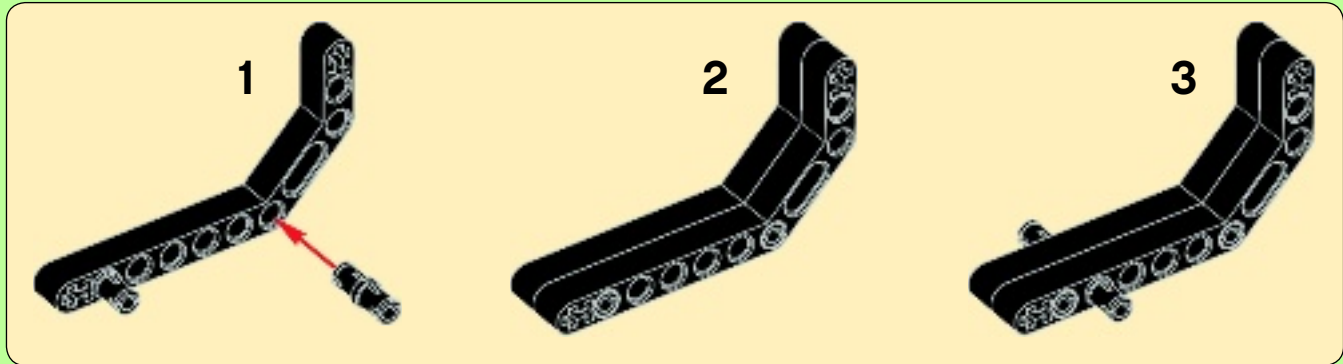

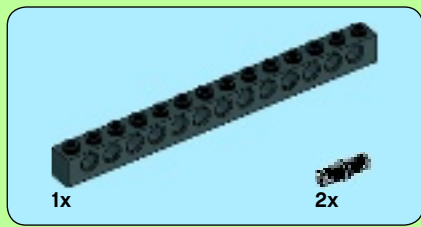

6

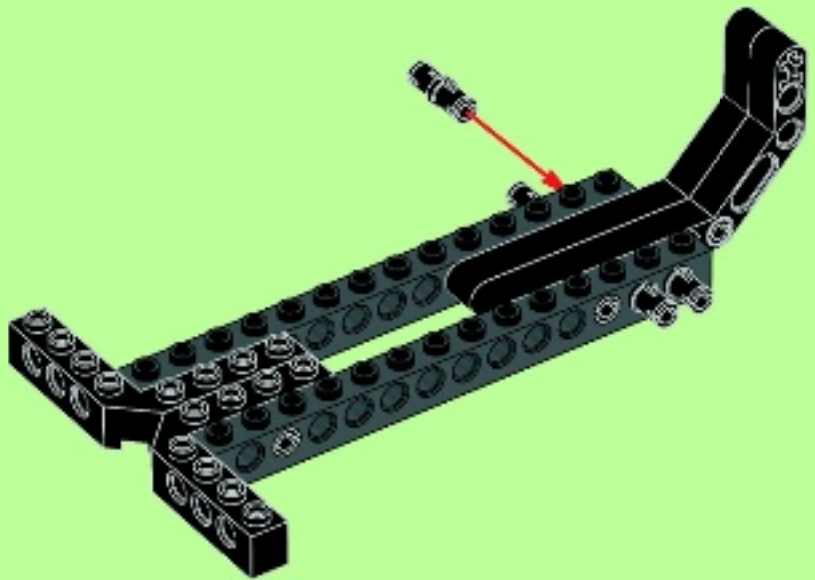

7

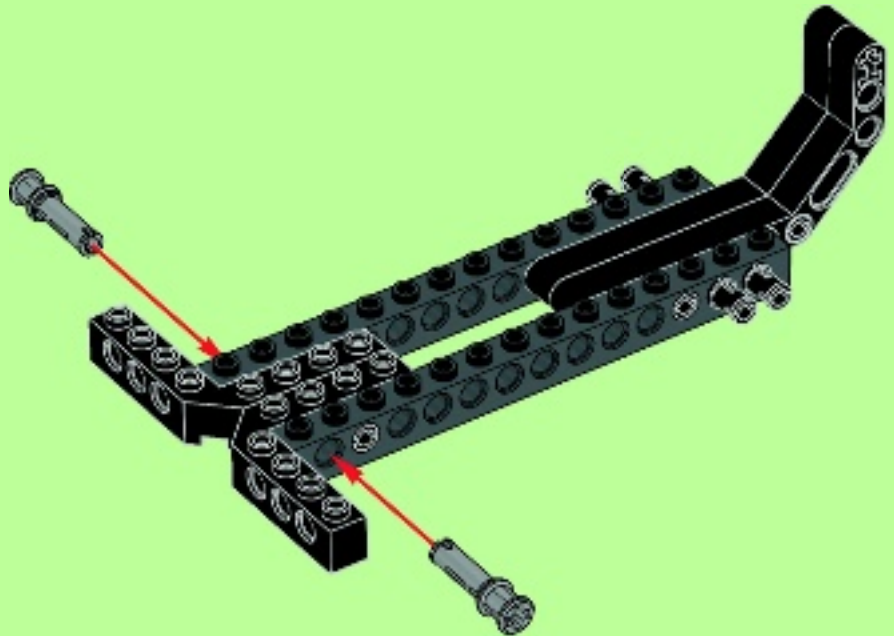

2x

2x

8

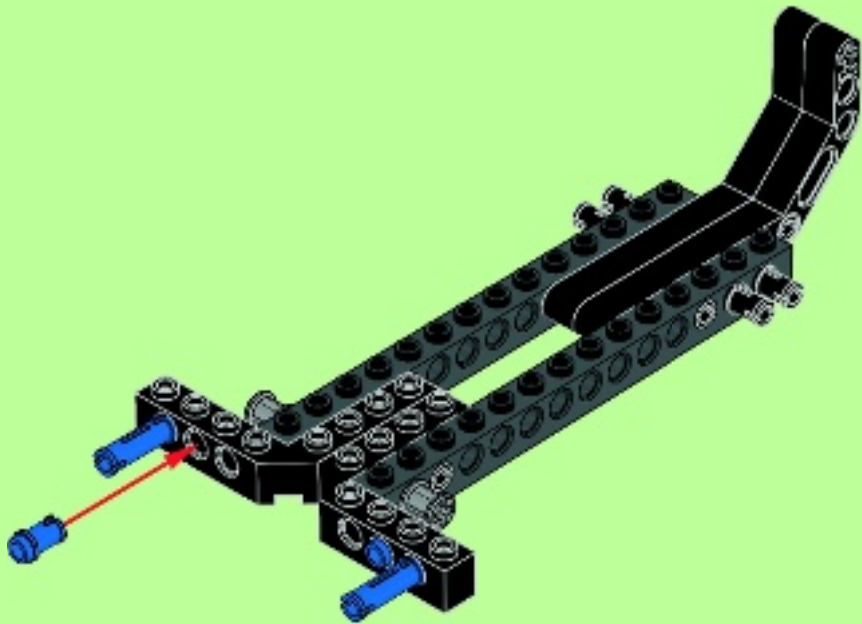

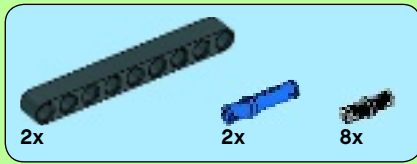

9

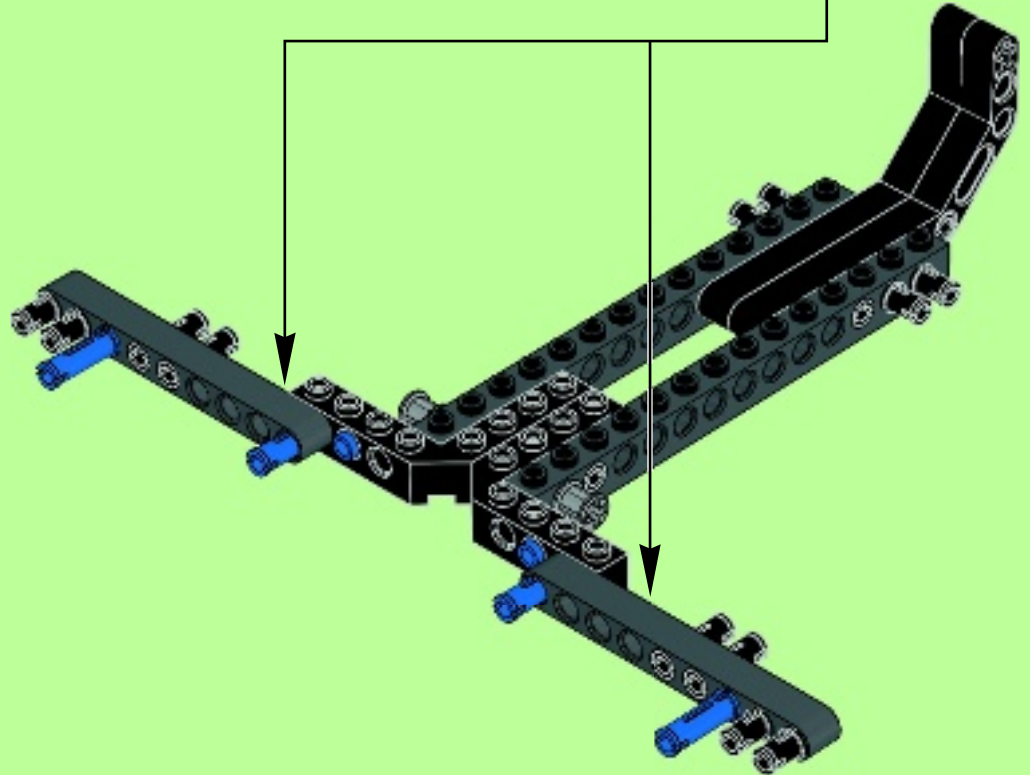
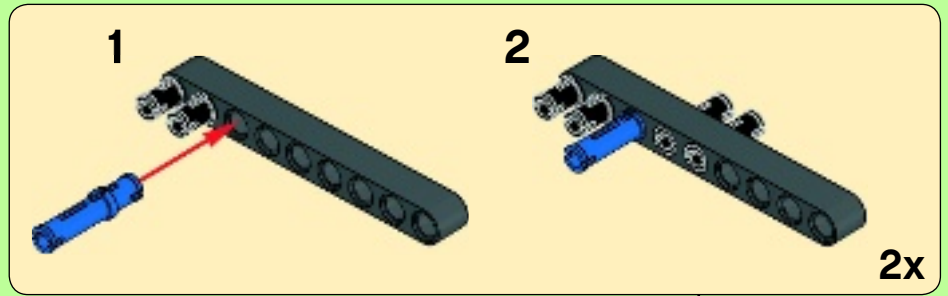



2x

10

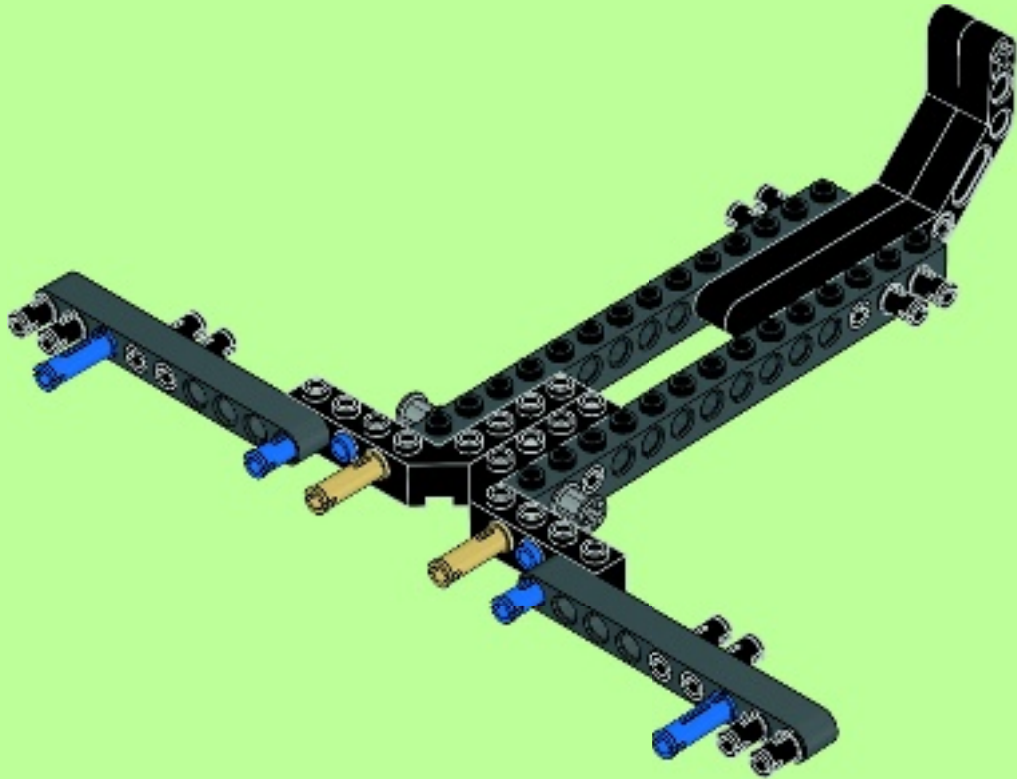

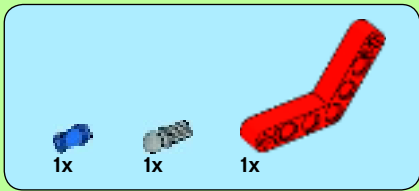

11

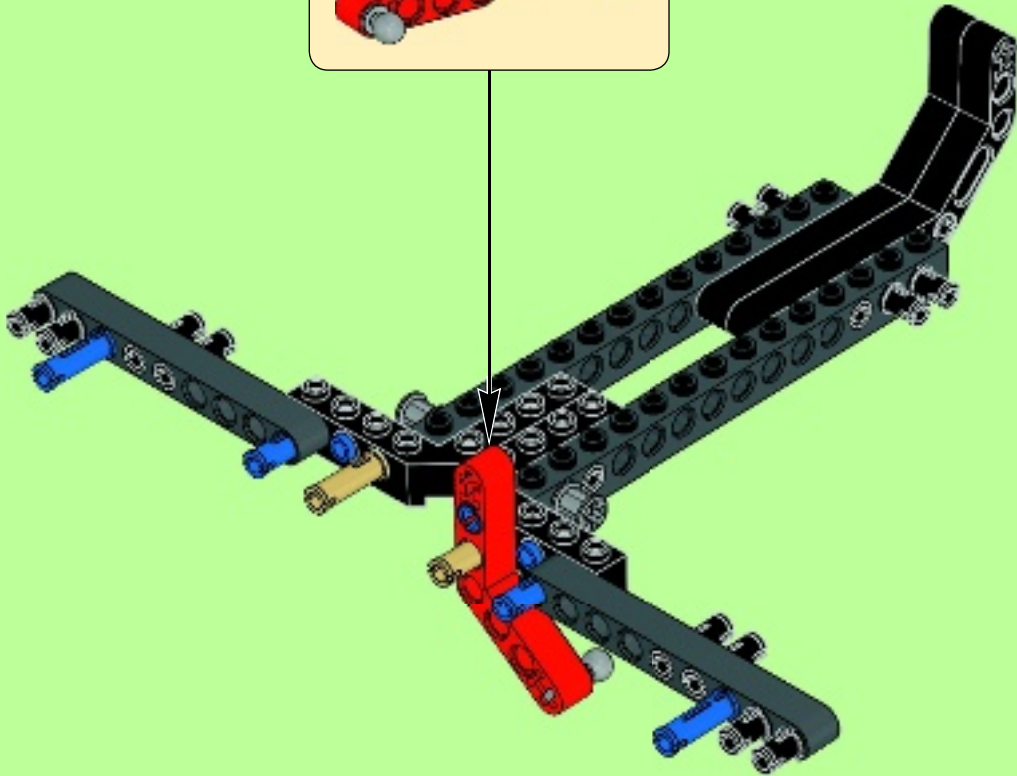
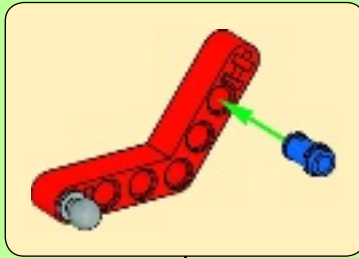

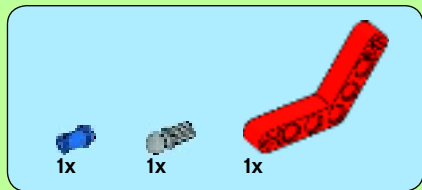

12

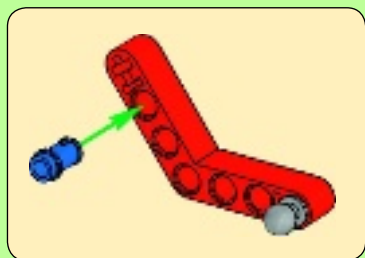
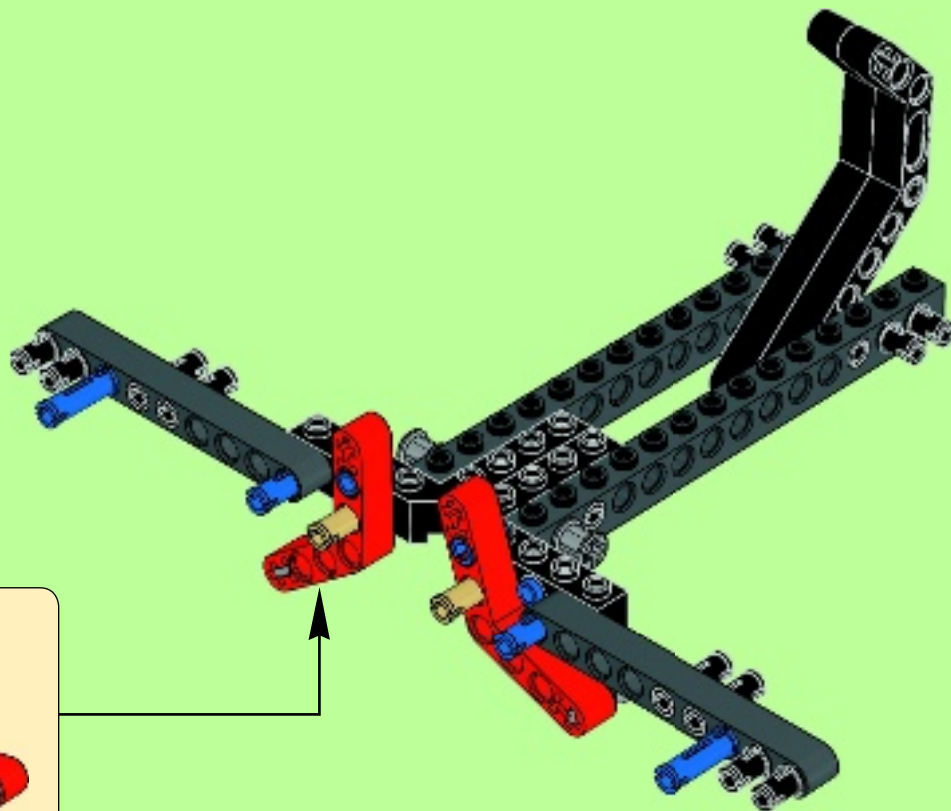

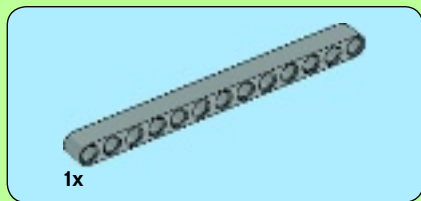

13

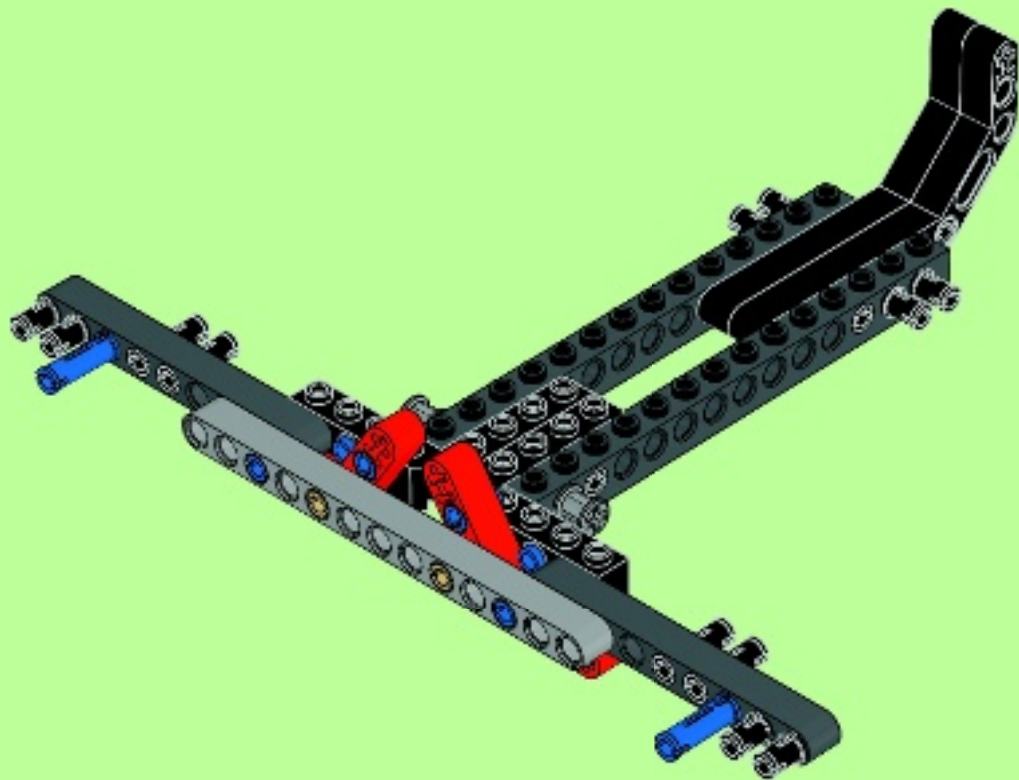



14

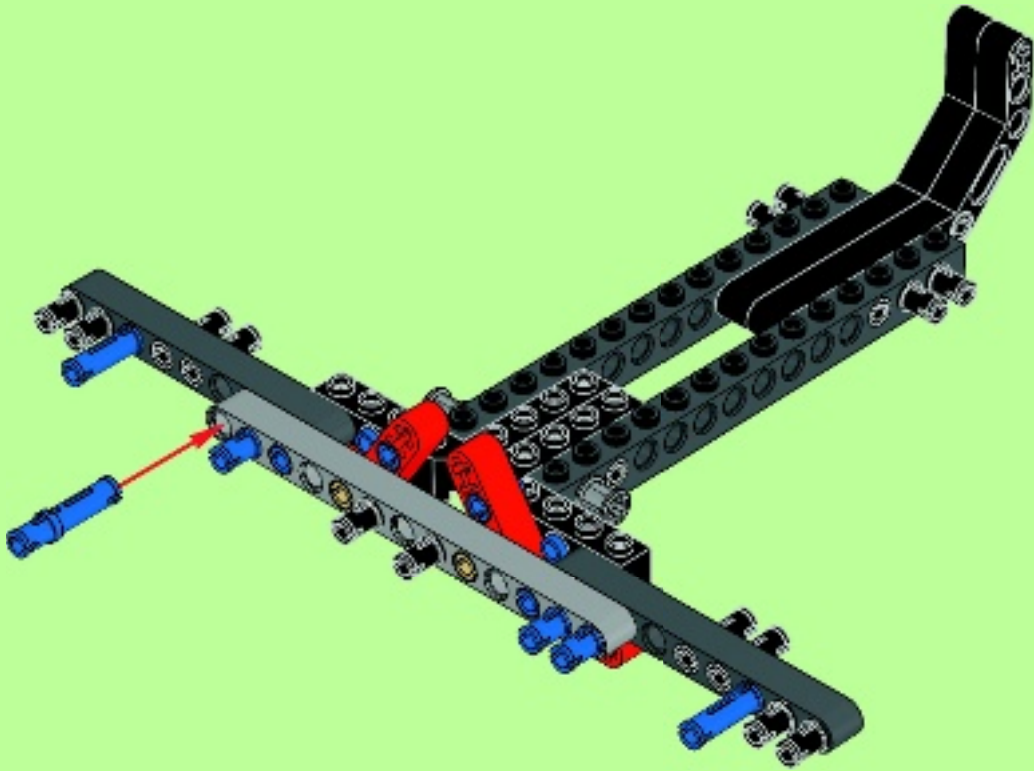

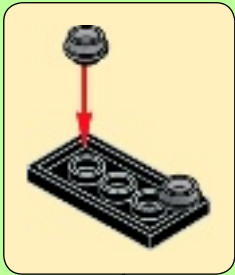
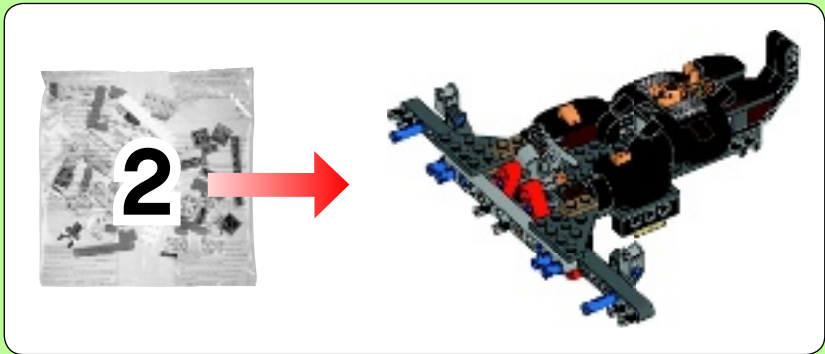

15

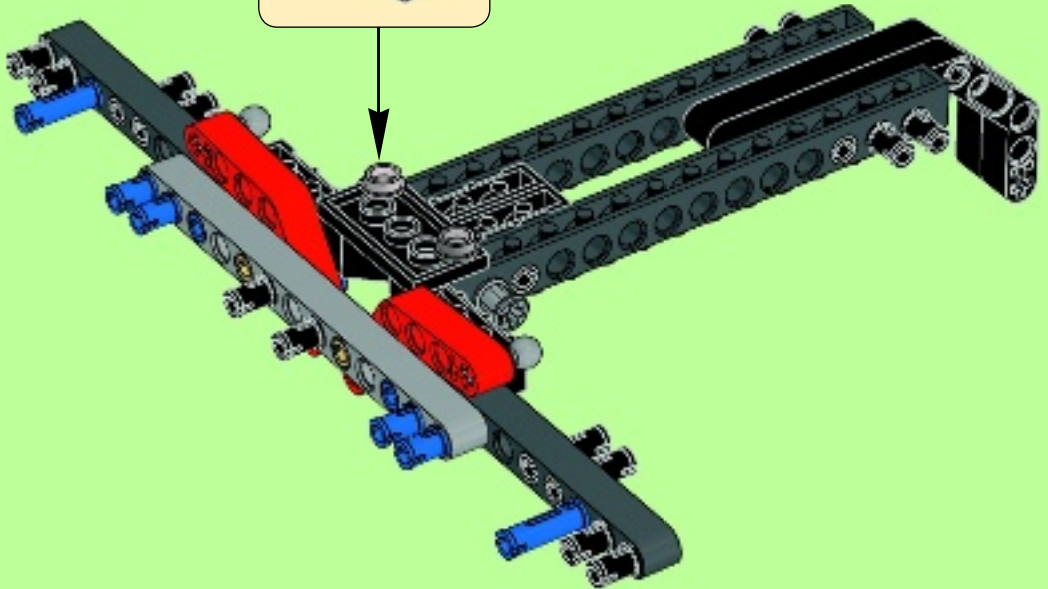

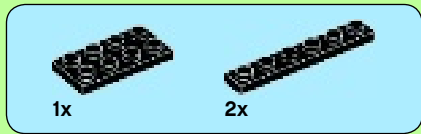

16

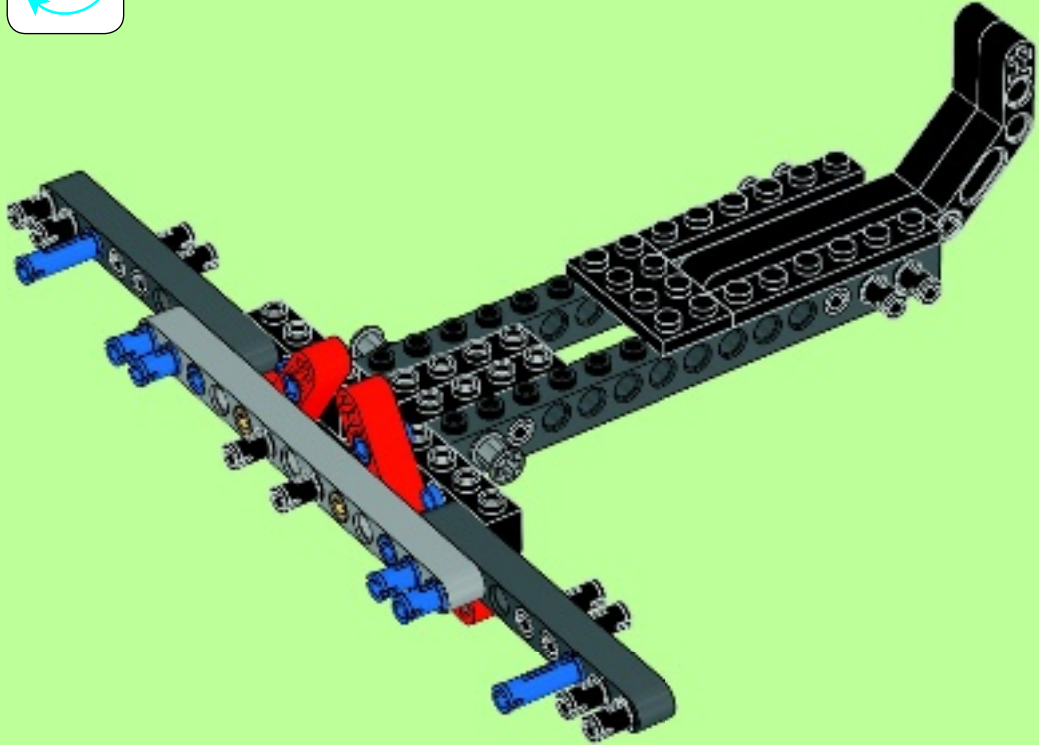

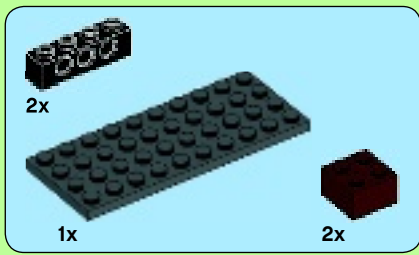

17

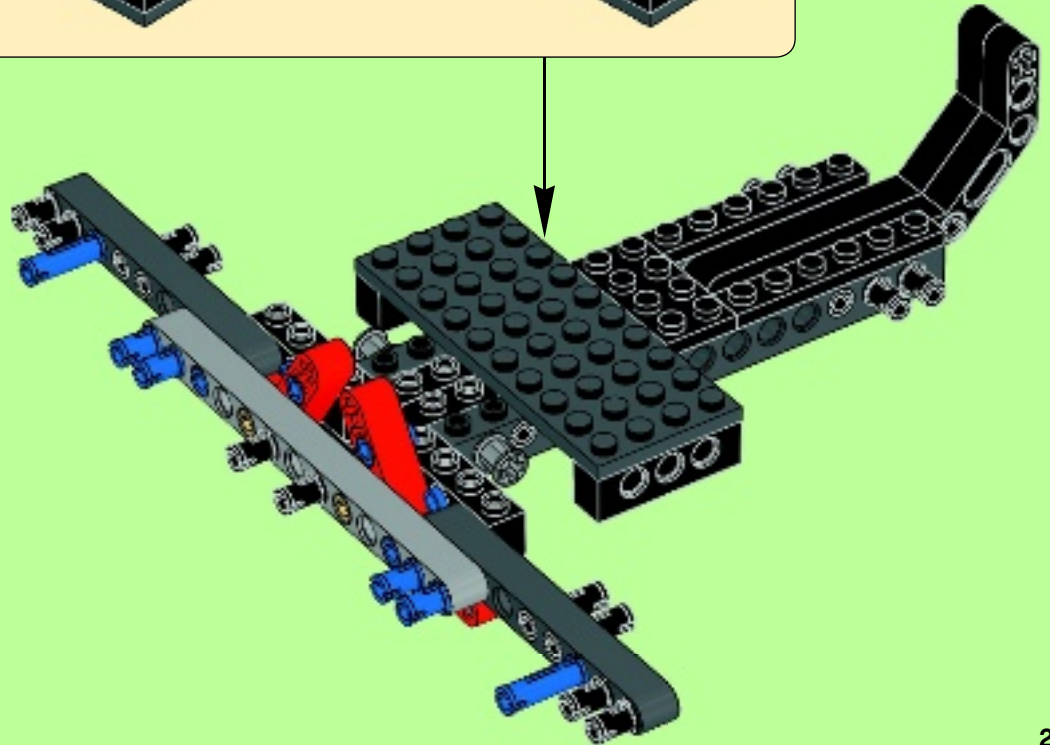
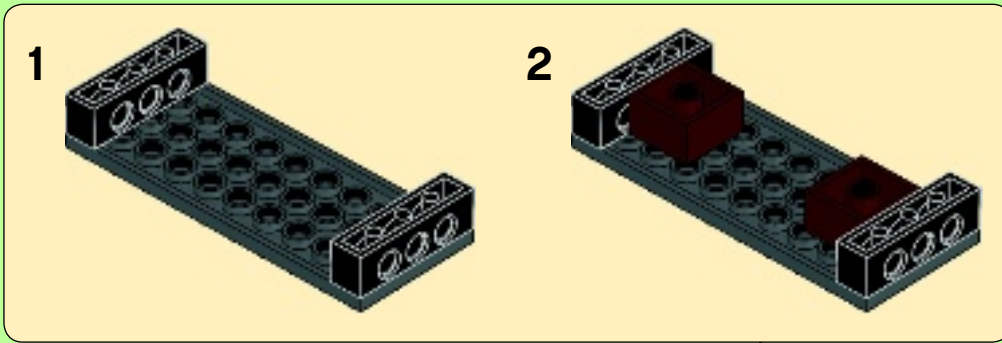

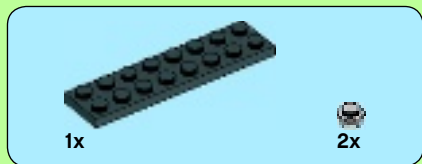

18

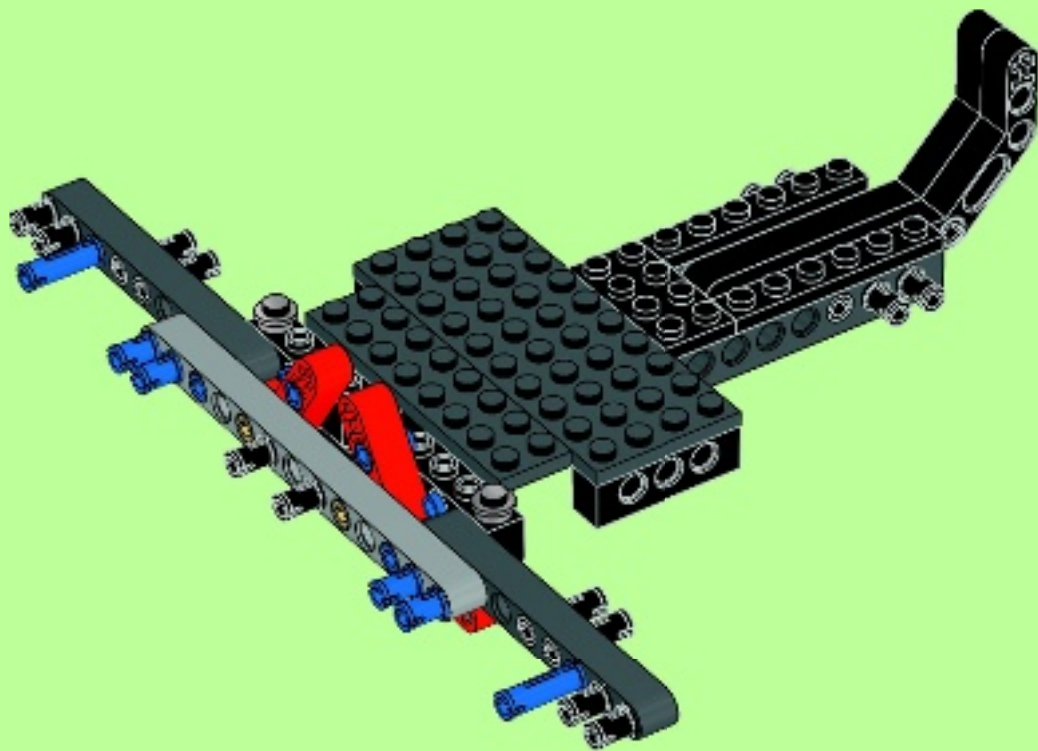



2x



2x



2x

19

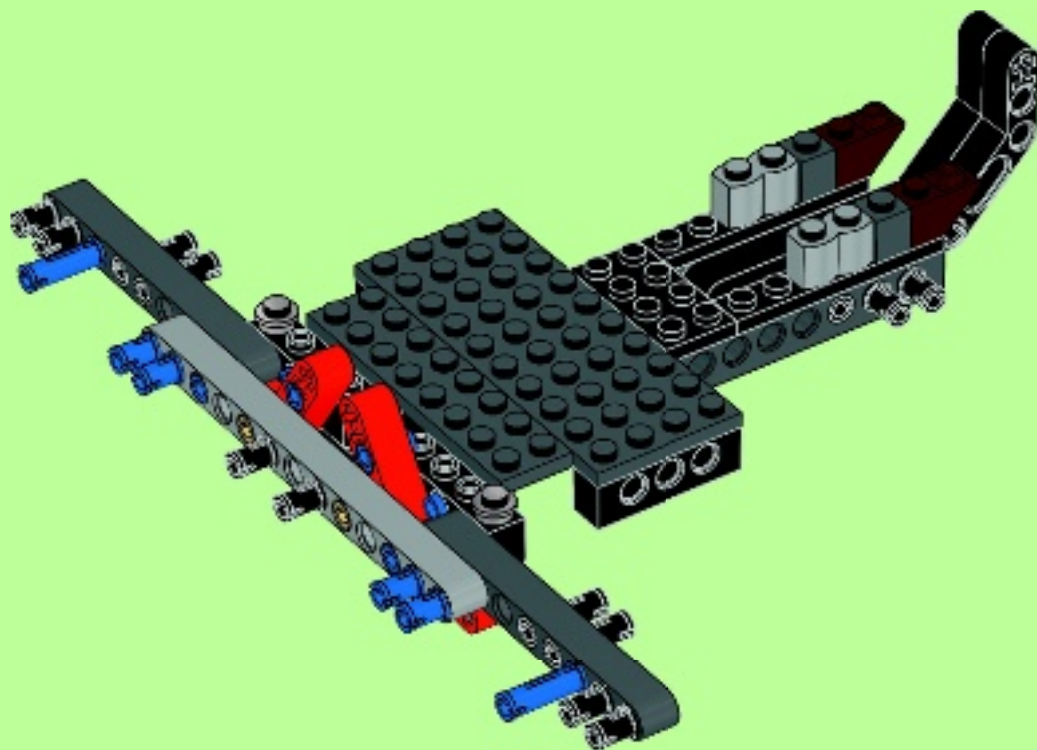



2x



2x

20

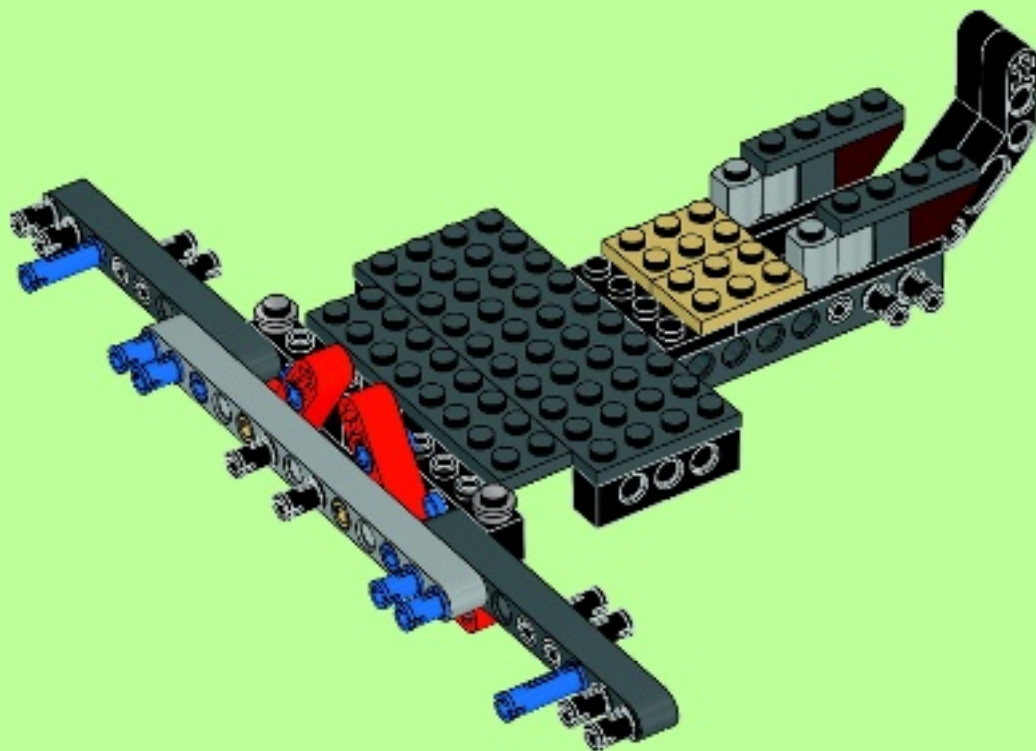

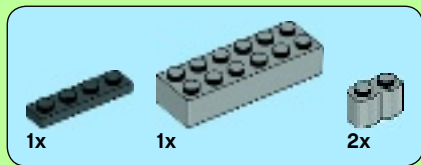

21

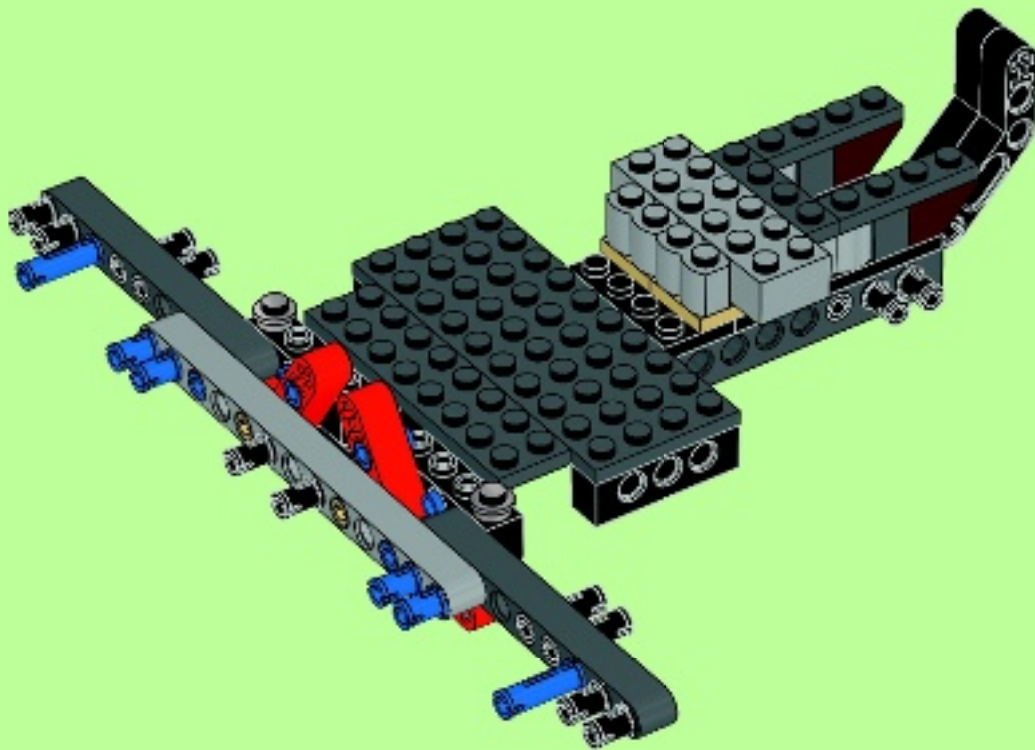



22

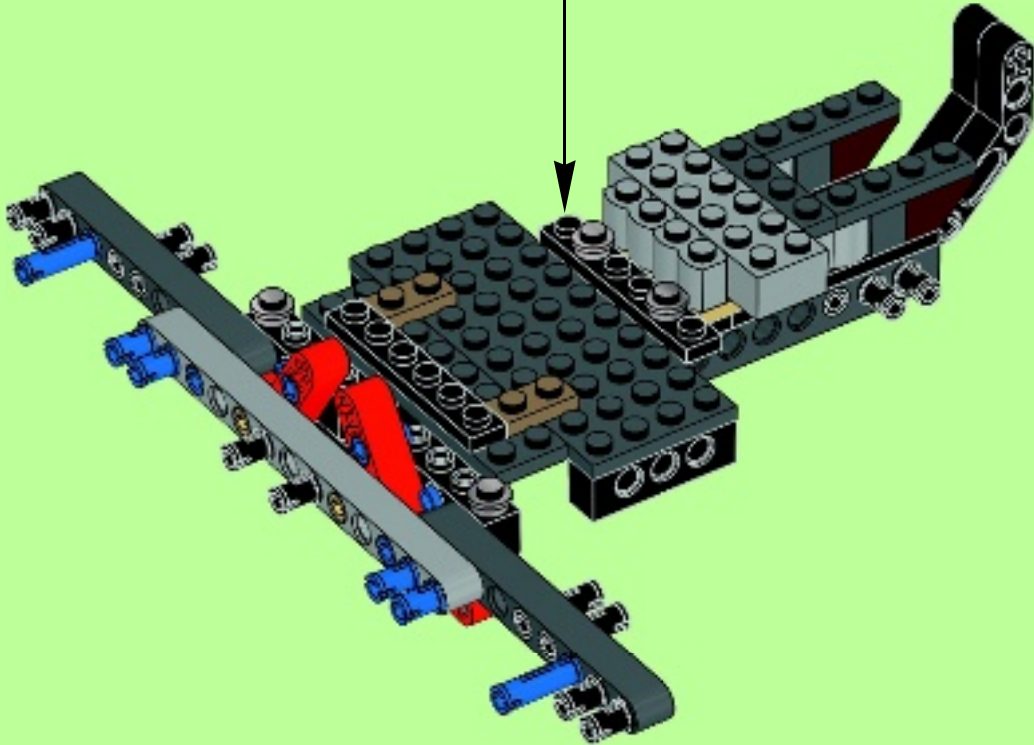
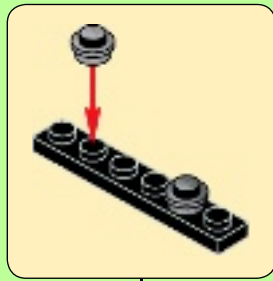

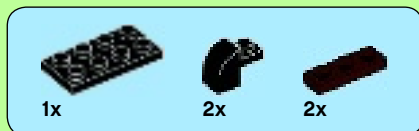

23

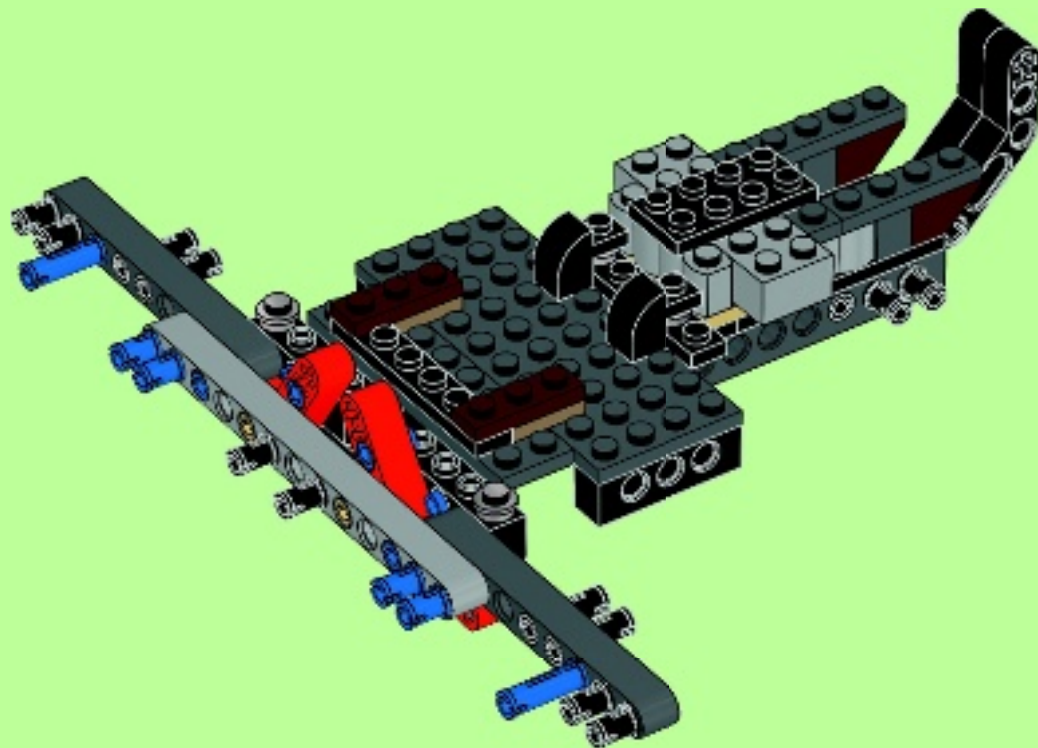

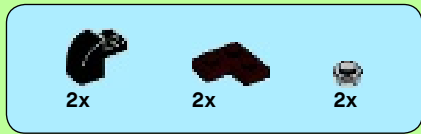

24

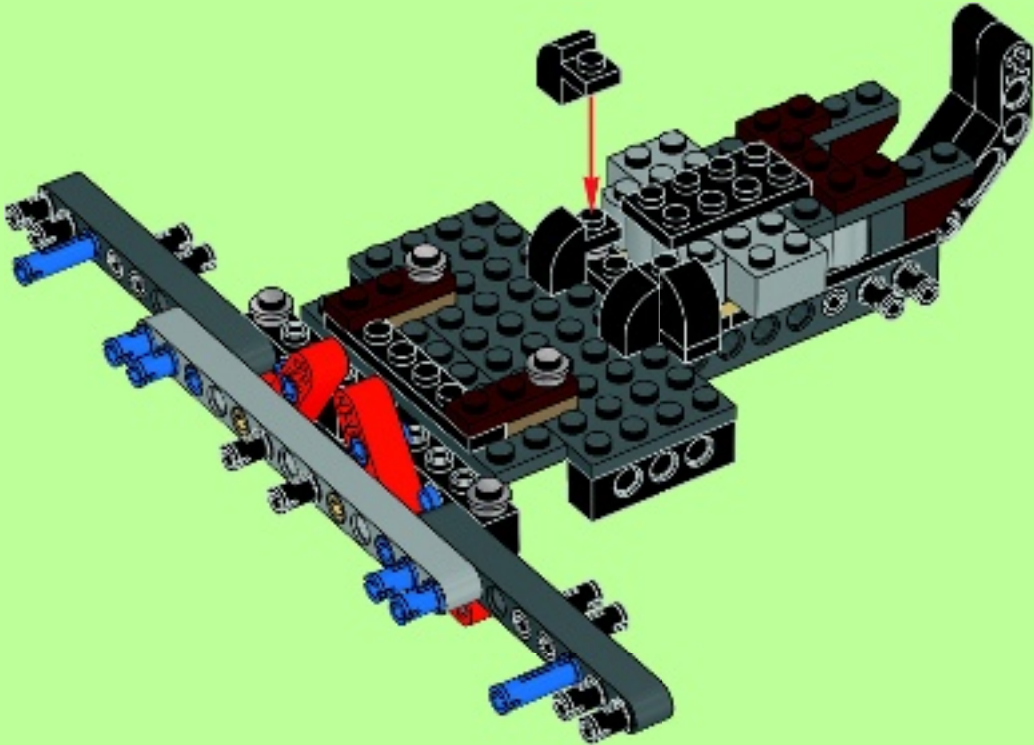

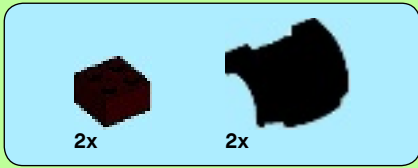

25

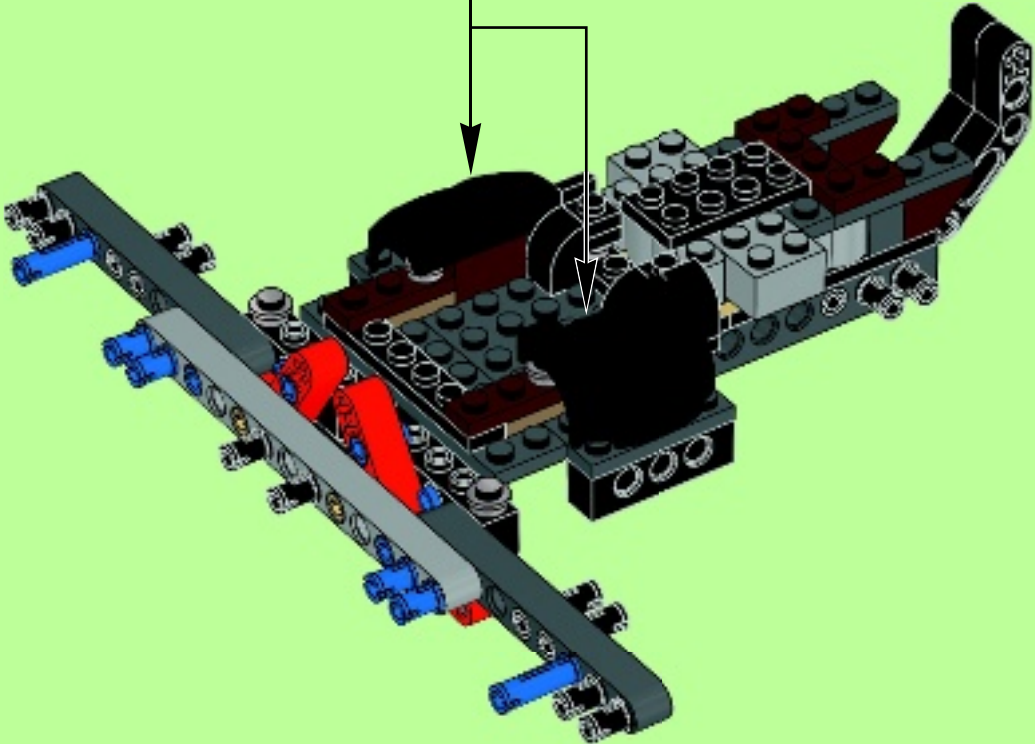
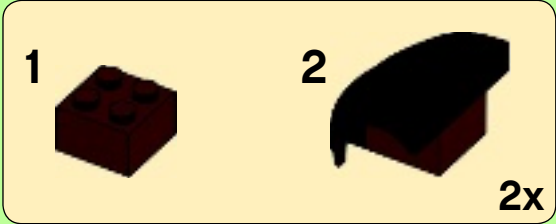



26

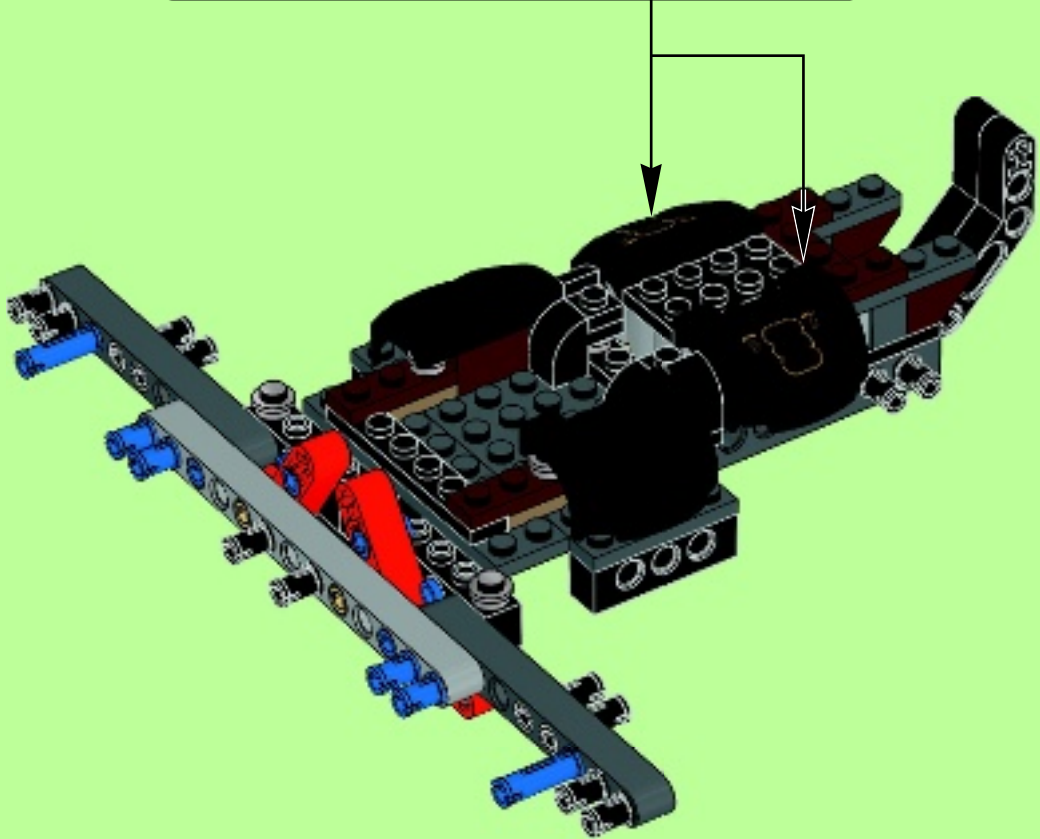
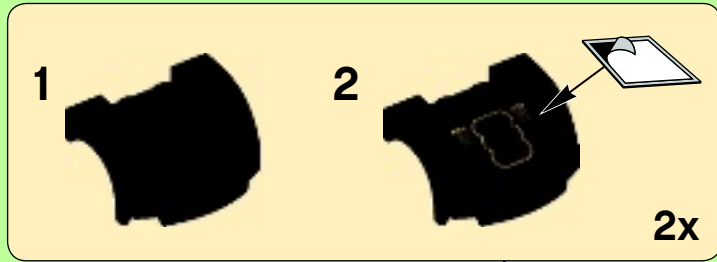



1x



2x

27

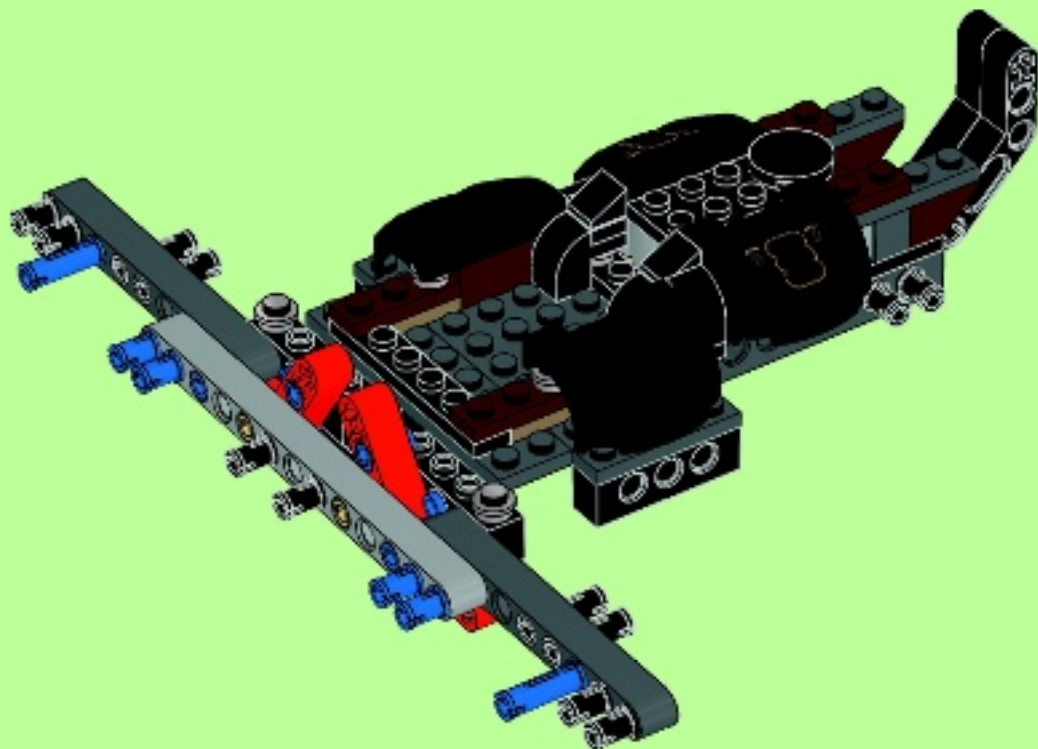

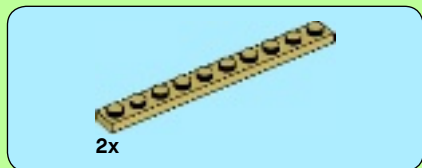

28

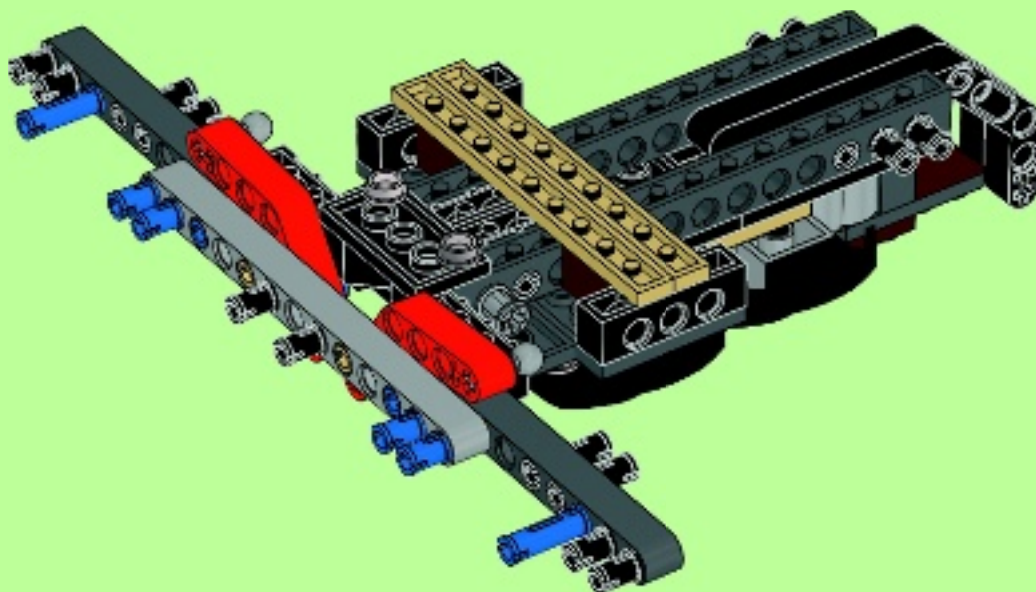



2x



2x

29

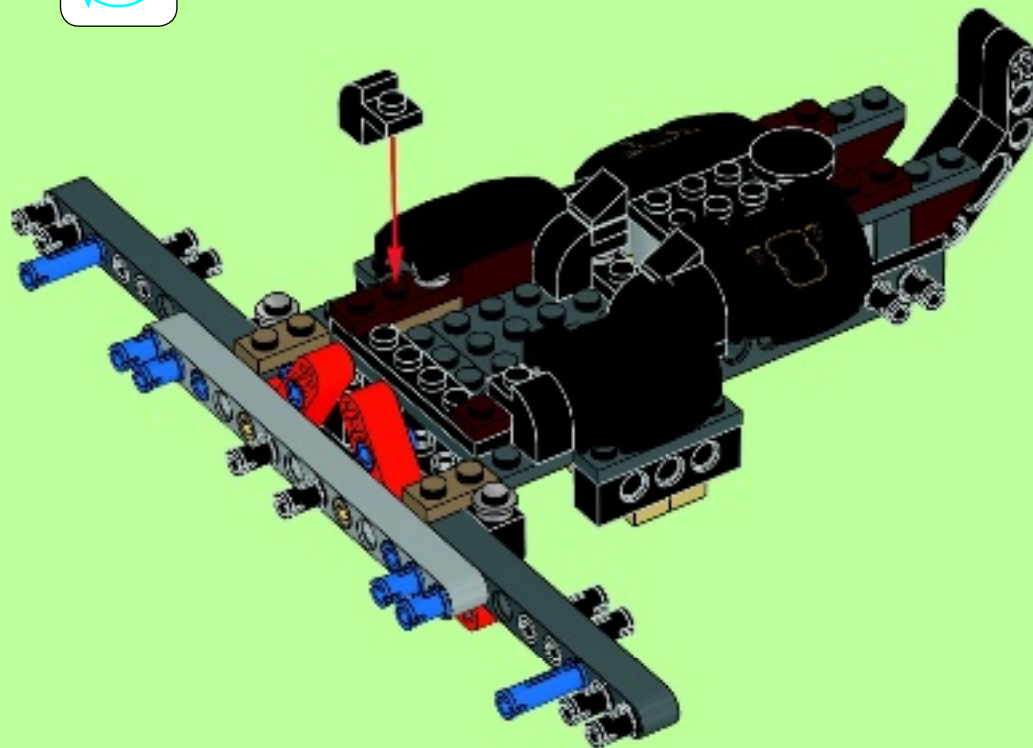



2x

30

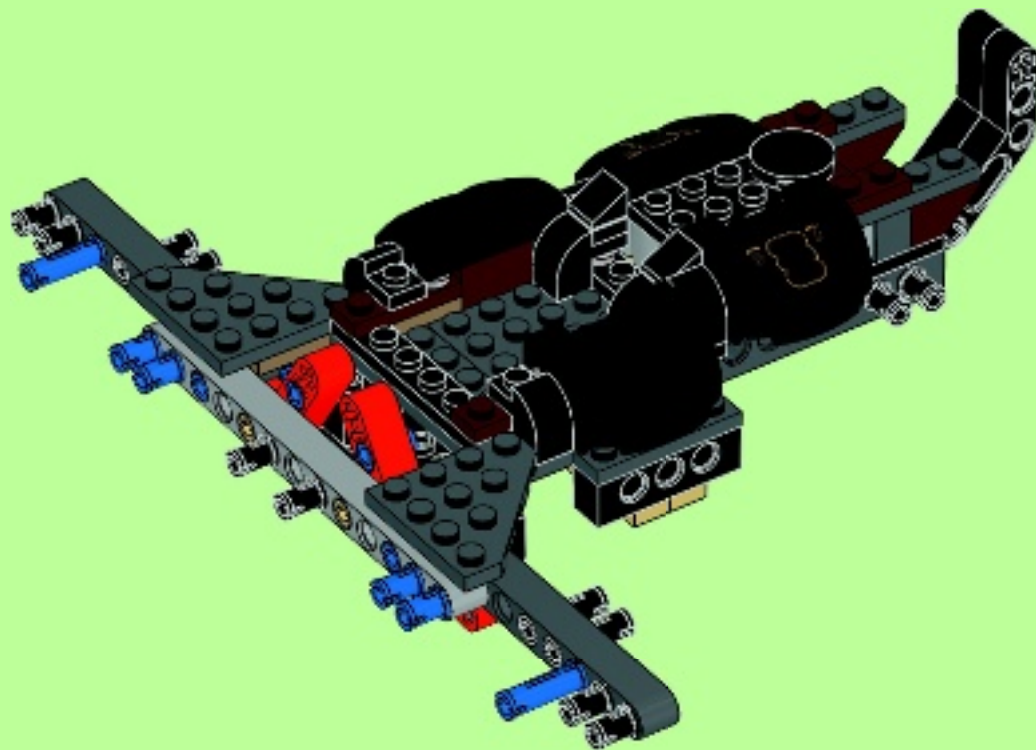



31

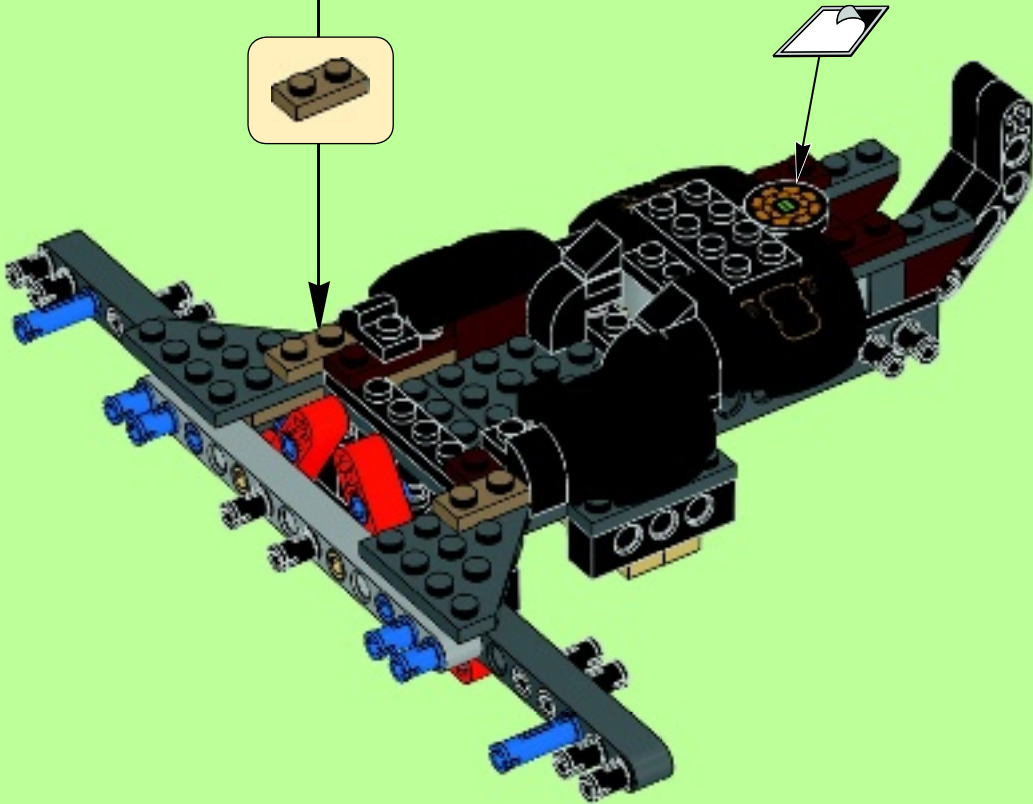



2x



2x



2x

32

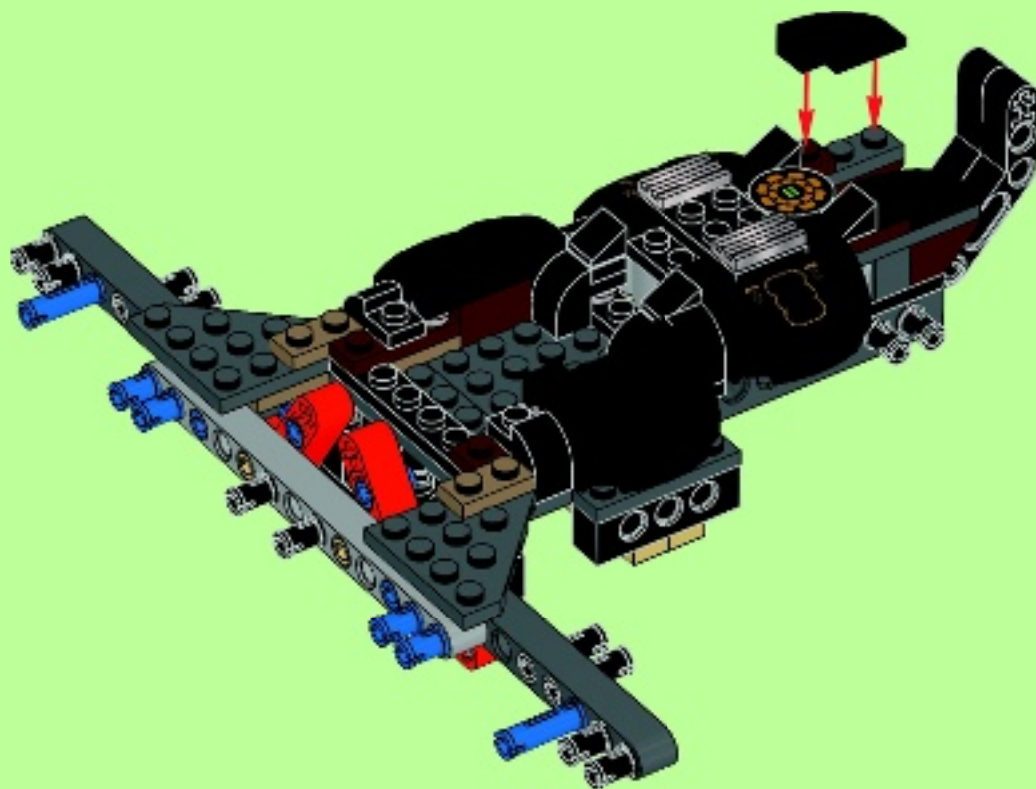



2x



2x

33



1



2



2x

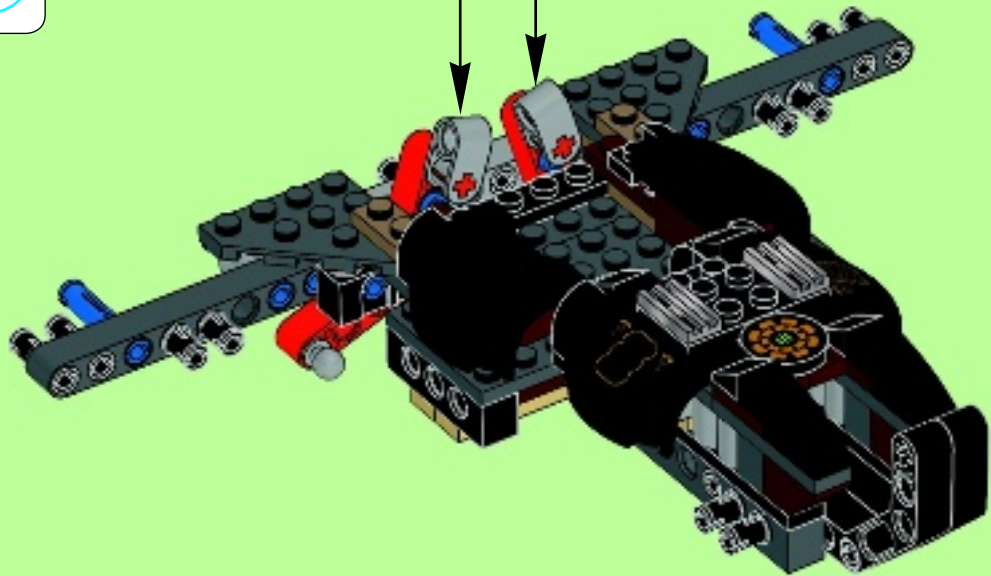

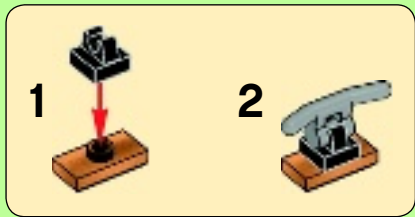

34

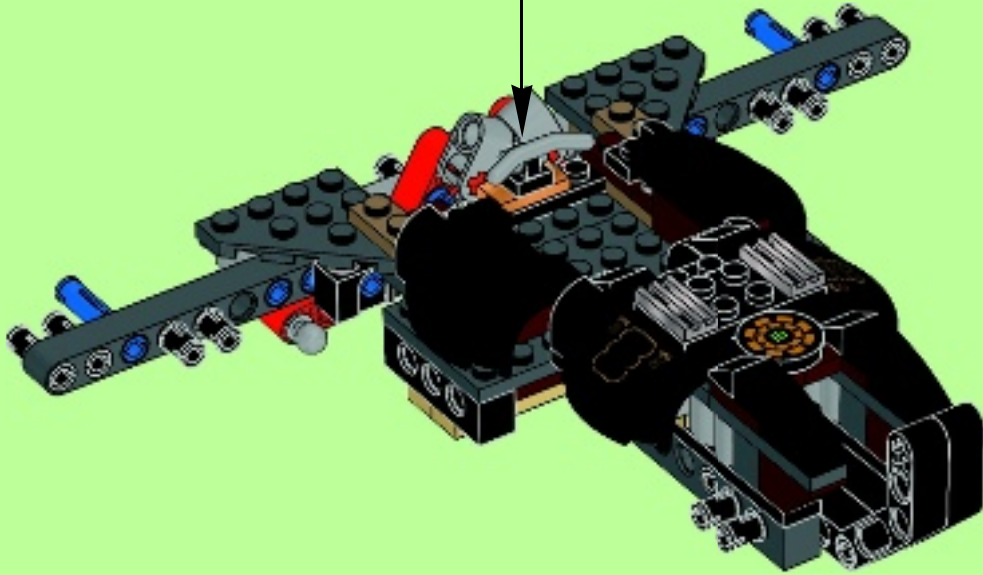



1x



2x

35

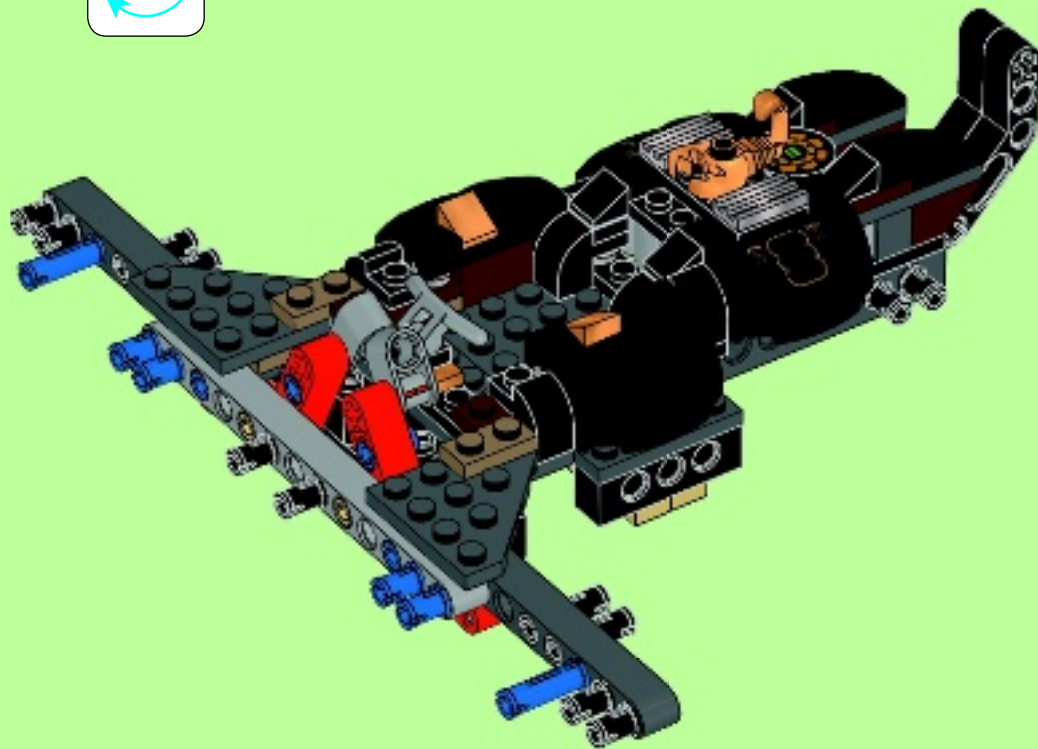



36

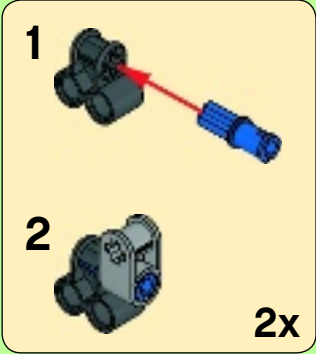
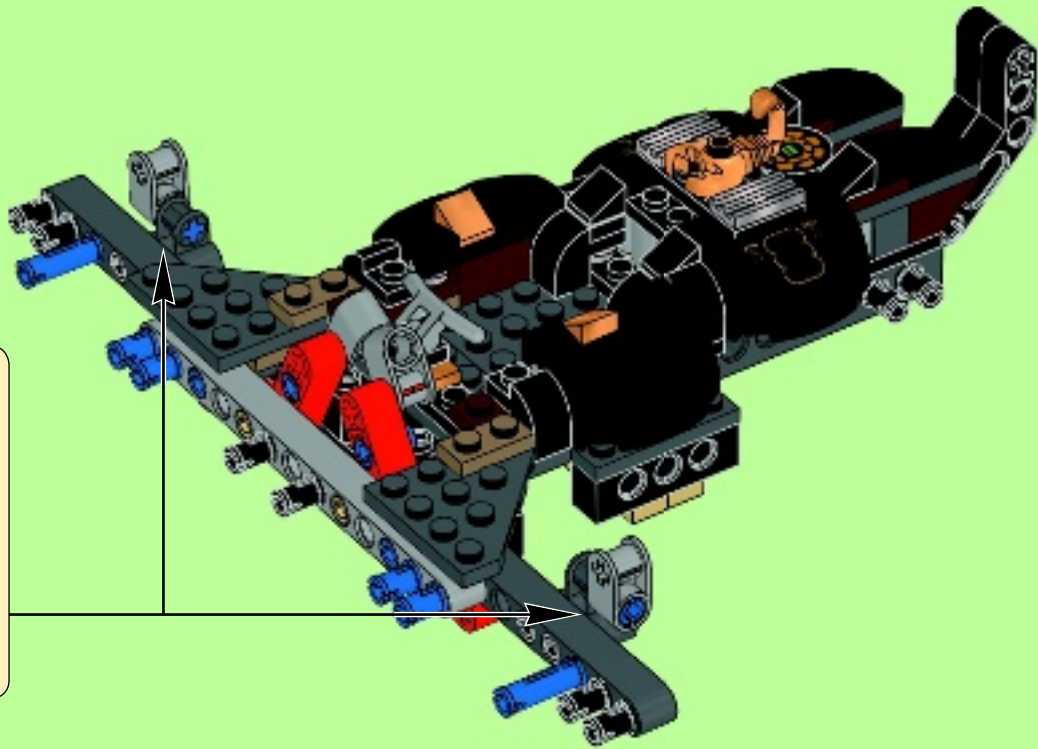

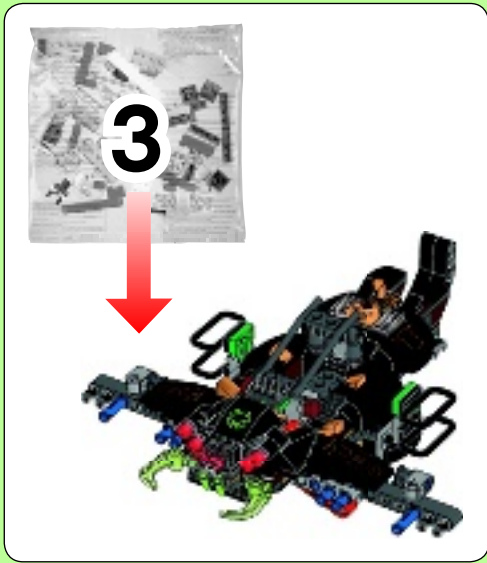

1

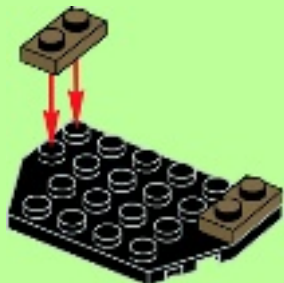

2



3





4

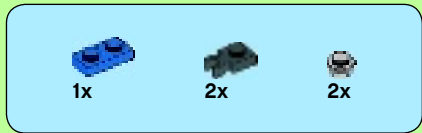

5

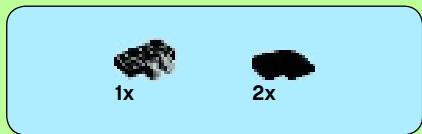

6



7





2x



2x

8

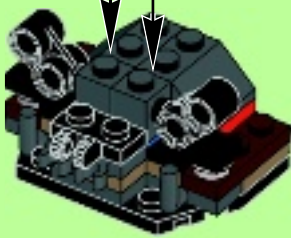
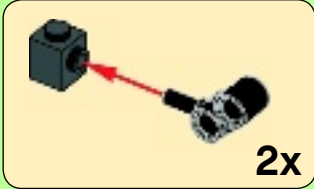

2x



2x



1x

9

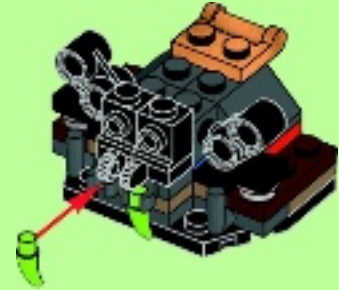

4x



4x

10

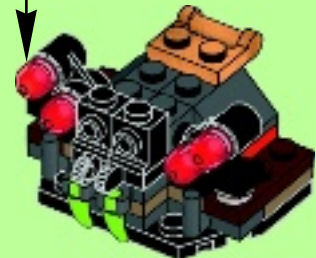
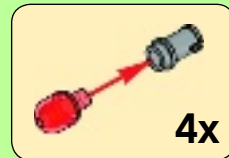



1x

11



2x

12



2x

13

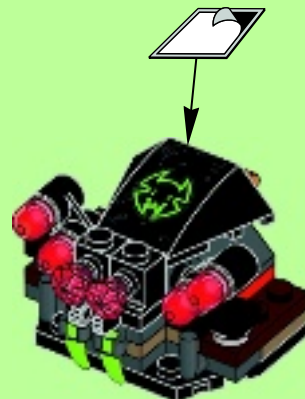
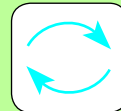

37

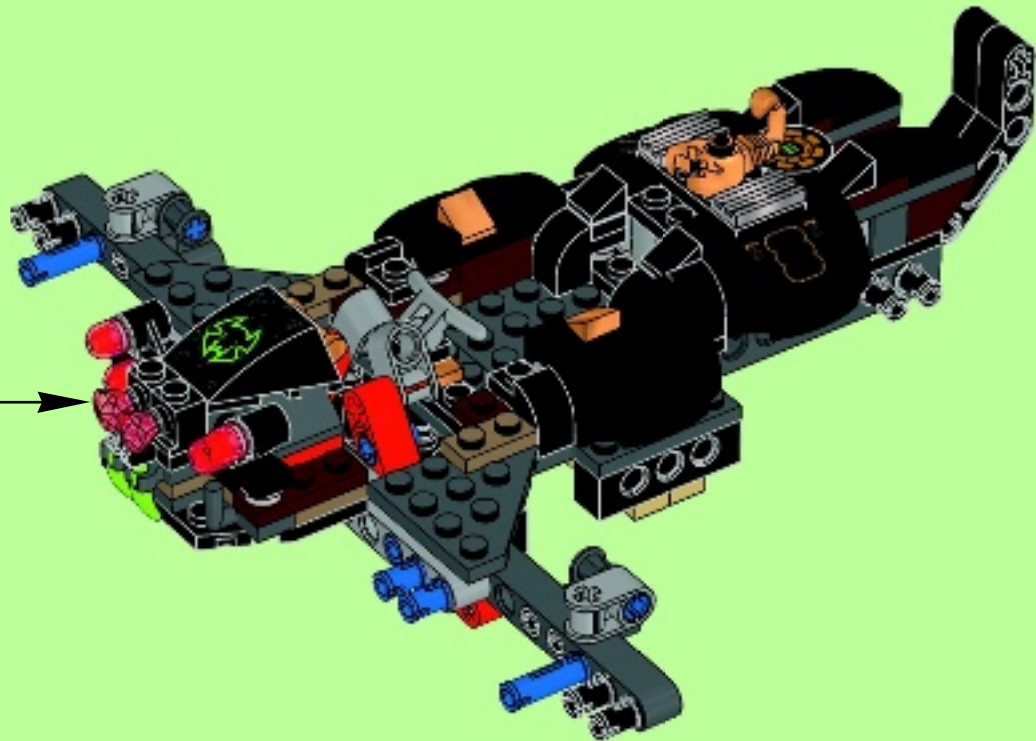

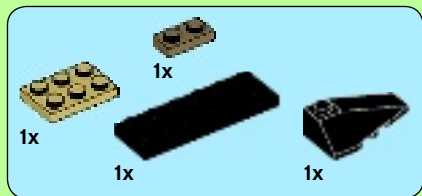

38

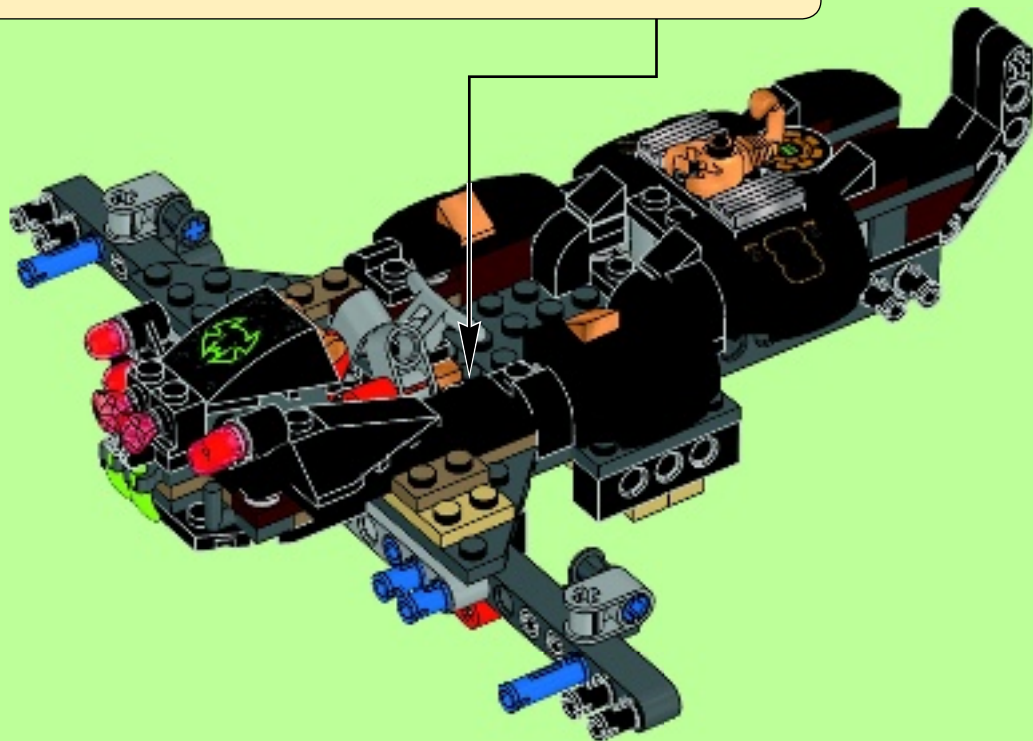
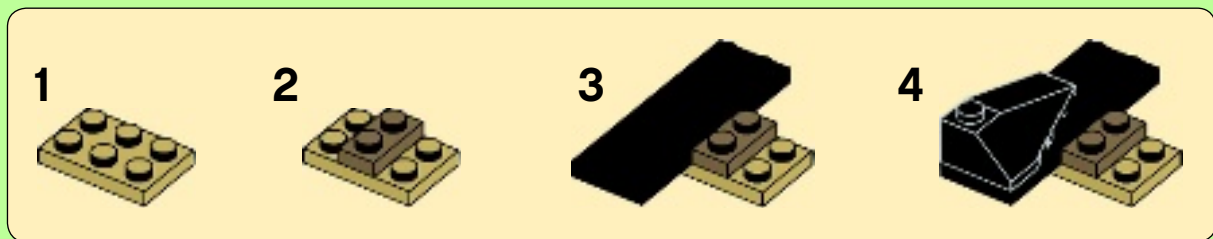

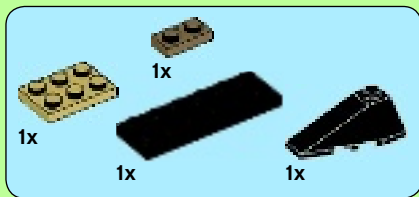

39

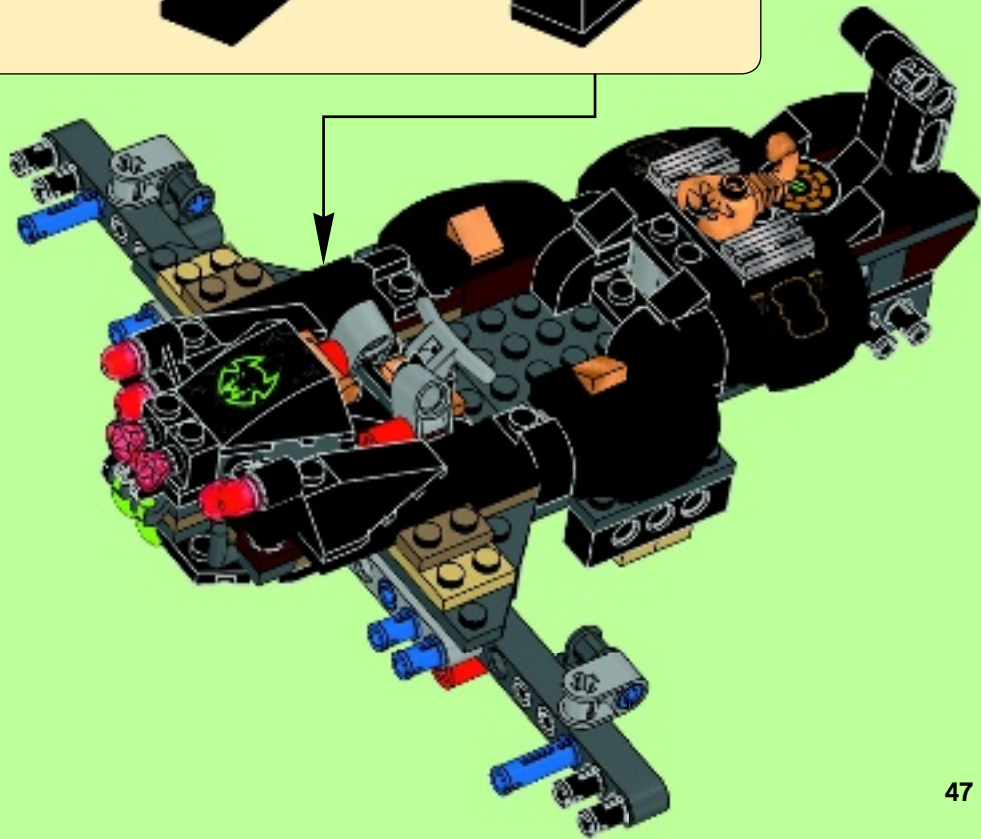



2x

40

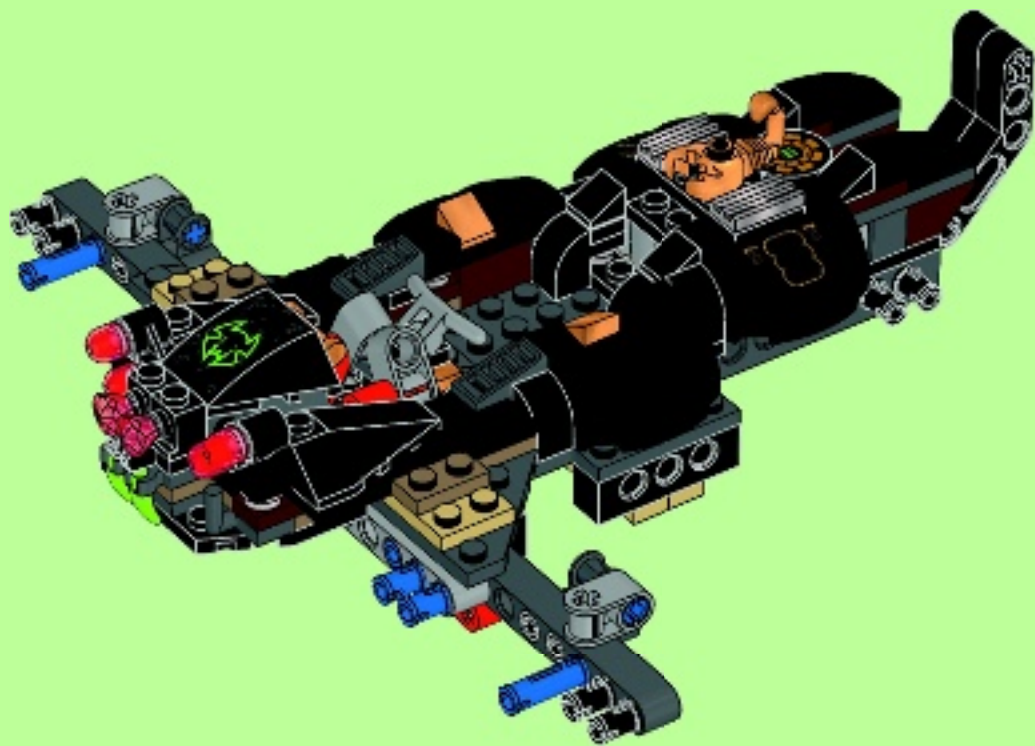

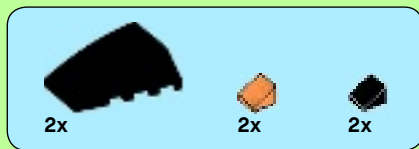

41

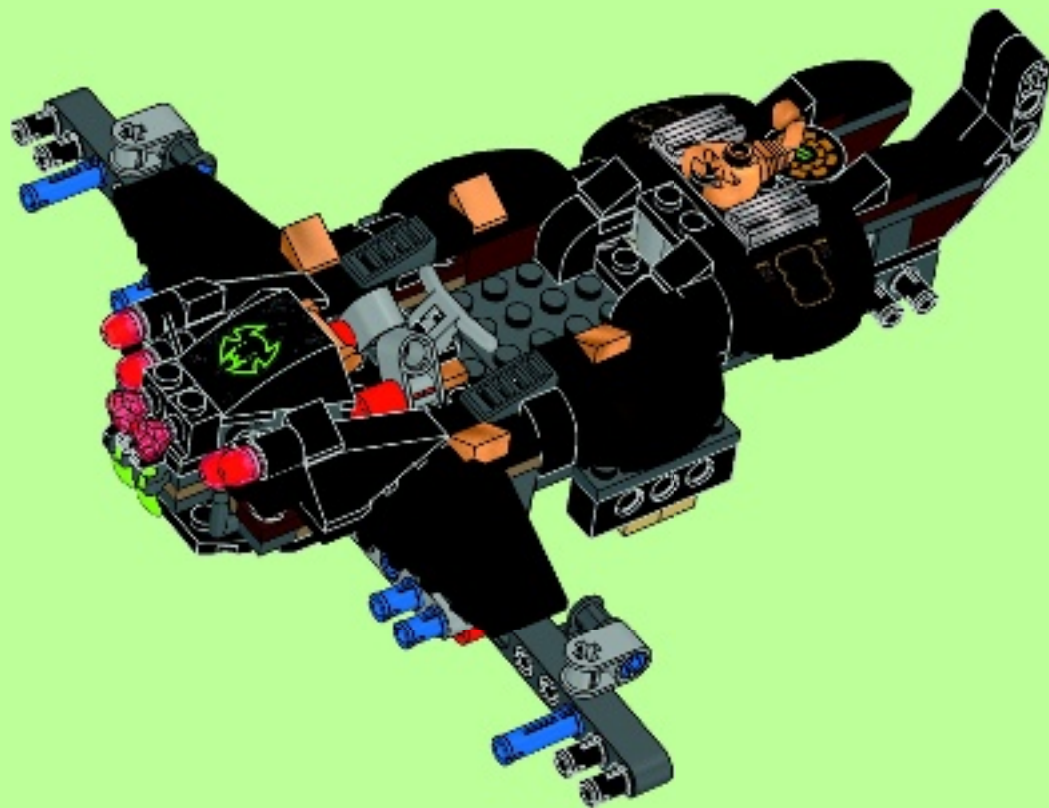



2x



2x



2x

42

1



2



2x

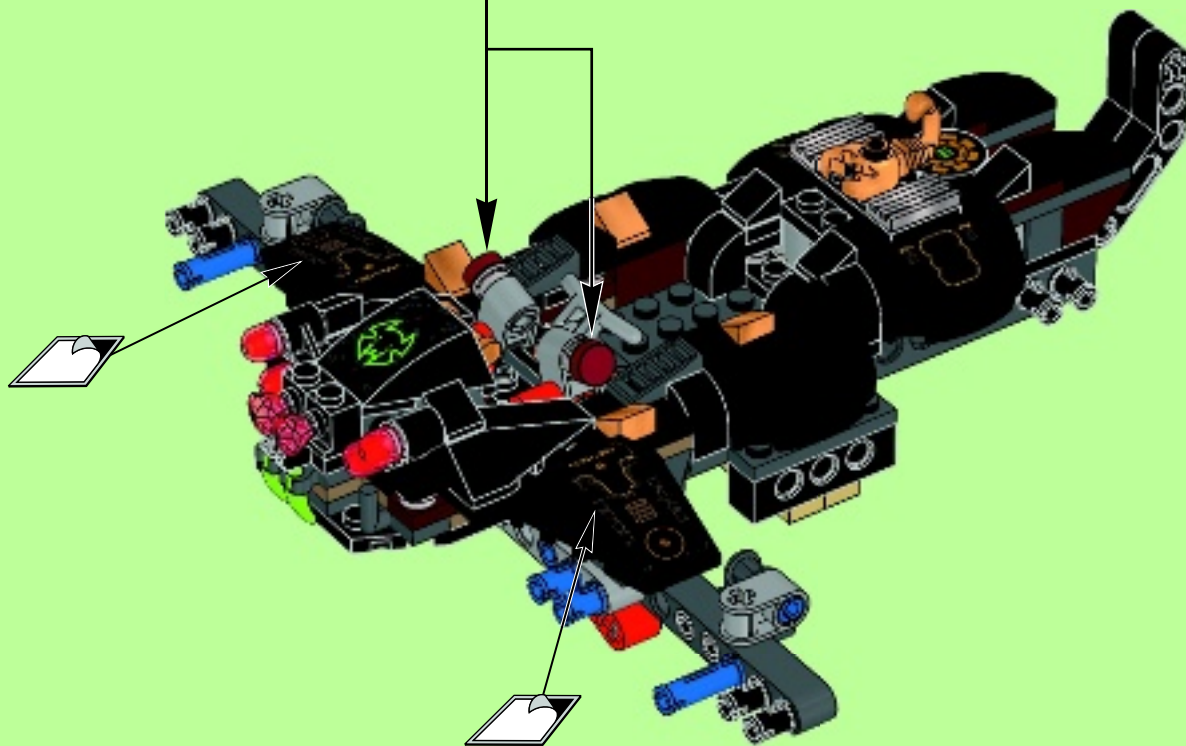

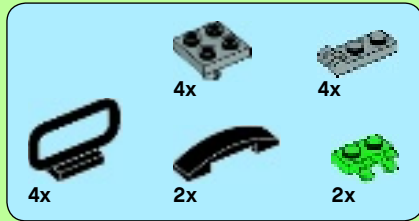

43

1



2

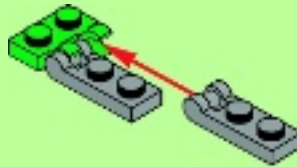

3



4

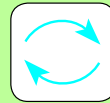
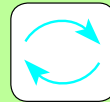

5

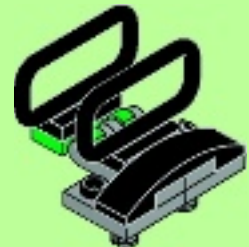

2x

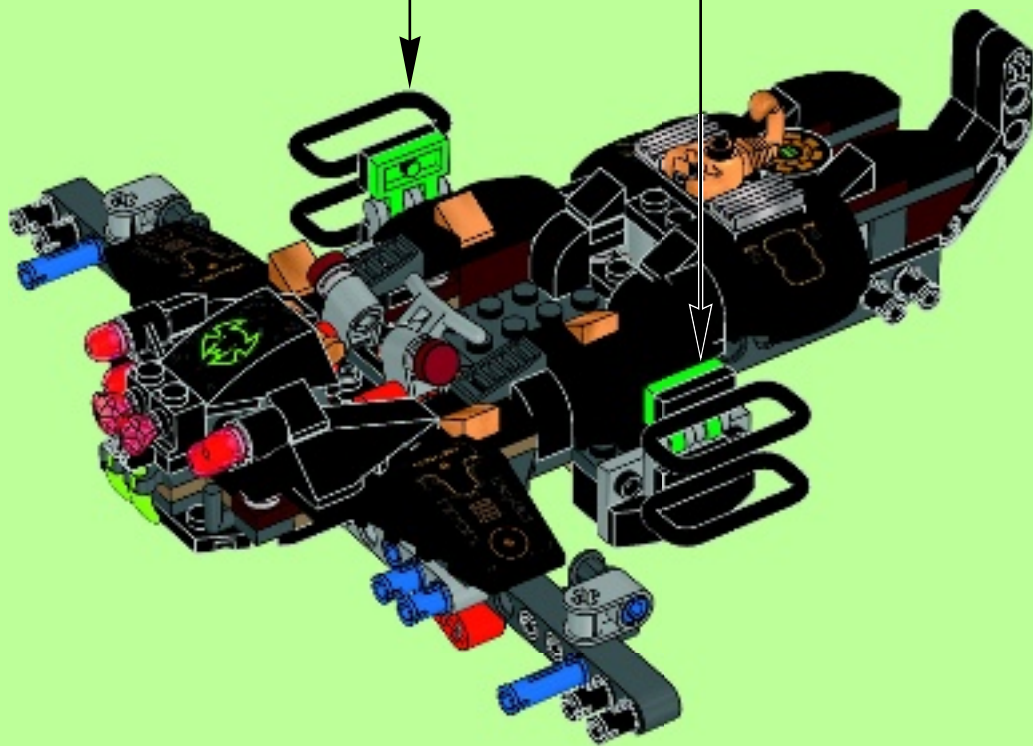

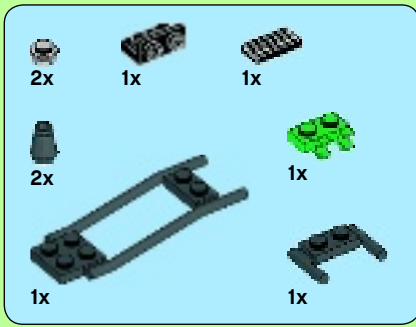

44

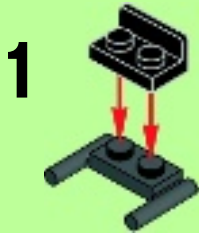

2

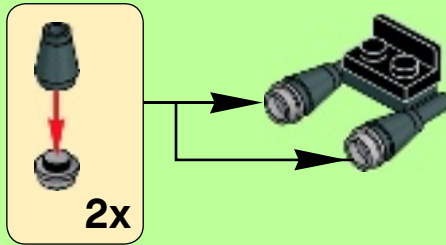

3

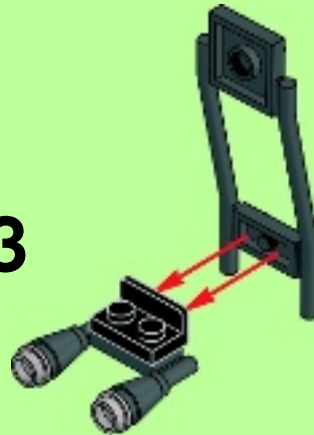

4

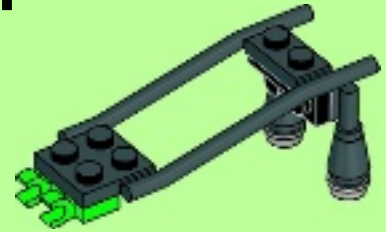

5

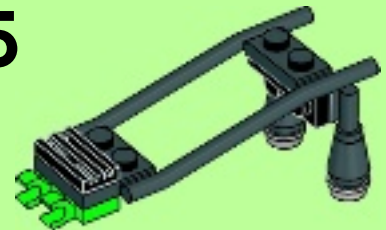

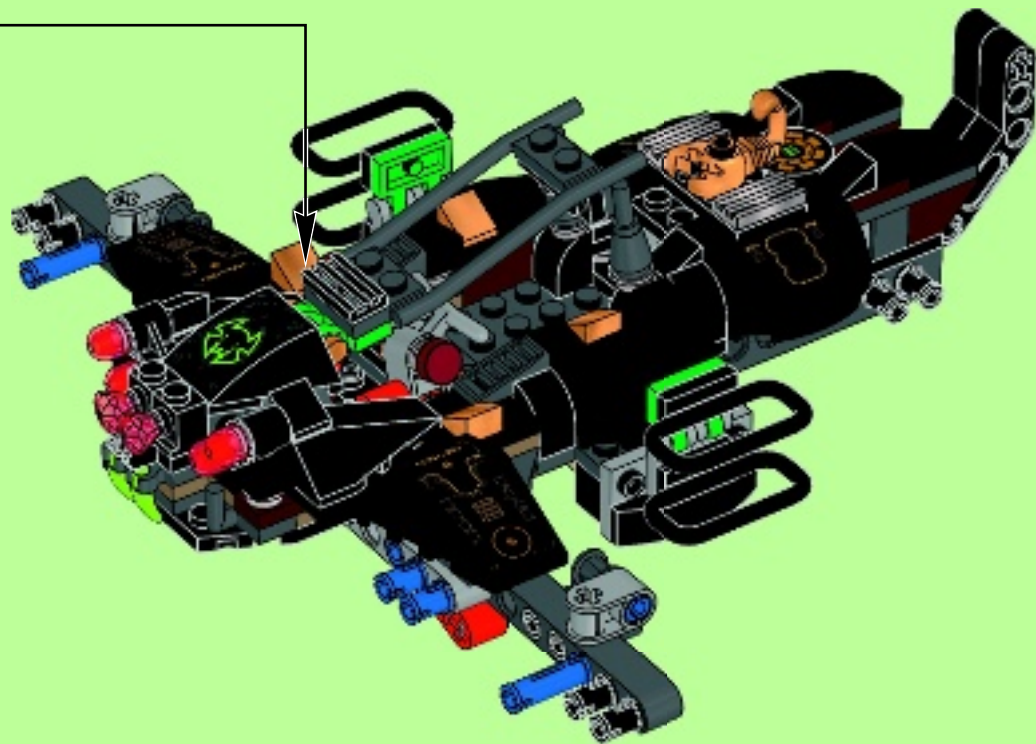



2x

45

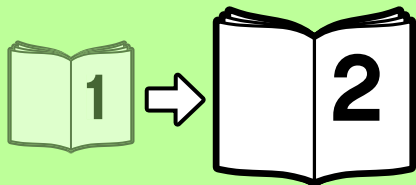
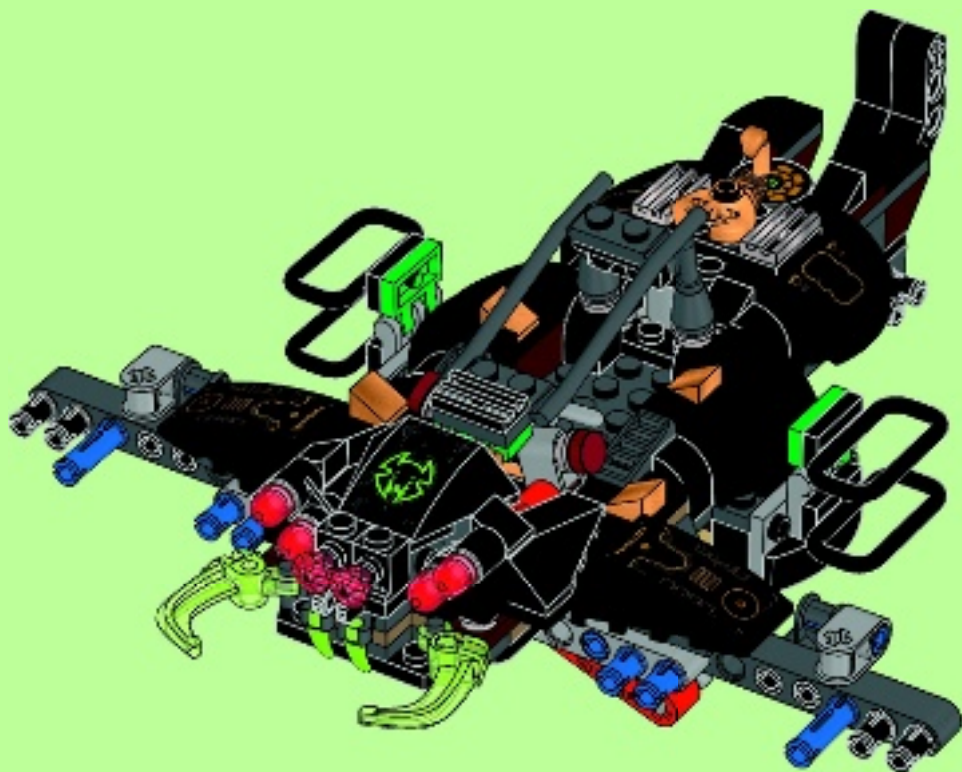



WIN!

Go to LEGO.com/productfeedback to fill out a survey for a chance to win a cool LEGO® Product. No purchase necessary. Open to all residents where not prohibited.



LEGO.com/productfeedback

GEWINNE! WIN!

Nimm an der Umfrage auf LEGO.com/productfeedback teil und hab die Chance ein cooles LEGO® Produkt zu gewinnen!

Die Teilnahme am Gewinnspiel führt zu keinerlei Kaufverpflichtungen. Teilnahme in allen nicht ausgeschlossenen Ländern möglich.

Ga naar LEGO.com/productfeedback, vul een enquêteformulier in en maak kans op een cool LEGO® product.

Geen aankoopverplichting. Ledereen mag deelnemen, uitgezonderd ingezetenden van landen waar een enquêteverbod geldt.

GAGNE! 当てよう!

Visite LEGO.com/productfeedback pour répondre à un questionnaire et avoir une chance de gagner un produit LEGO® très cool!

Aucune obligation d'achat. Ouvert à tous les résidents des pays autorisés.

LEGO.com/productfeedback にアクセスして、アンケートにご記入ください。当選者にはレゴ®製品を差し上げます。

お買い上げの必要はありません

禁止されていない限り、すべての皆様にご利用いただけます。



6081435

LEGO, the LEGO logo and LEGENDS OF CHIMA are trademarks of the/sont des marques de commerce de/son marcas registradas de LEGO Group. ©2014 The LEGO Group.