

1

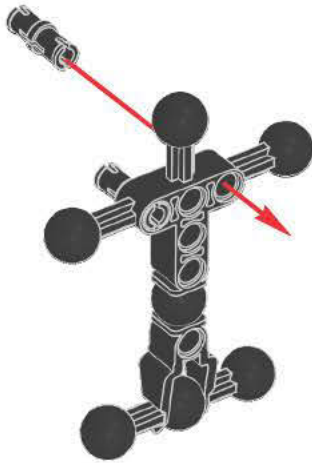

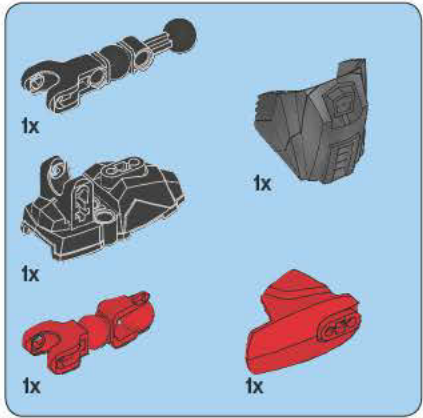

2

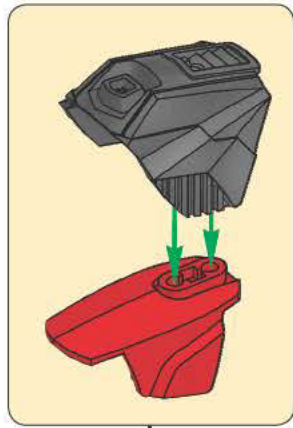
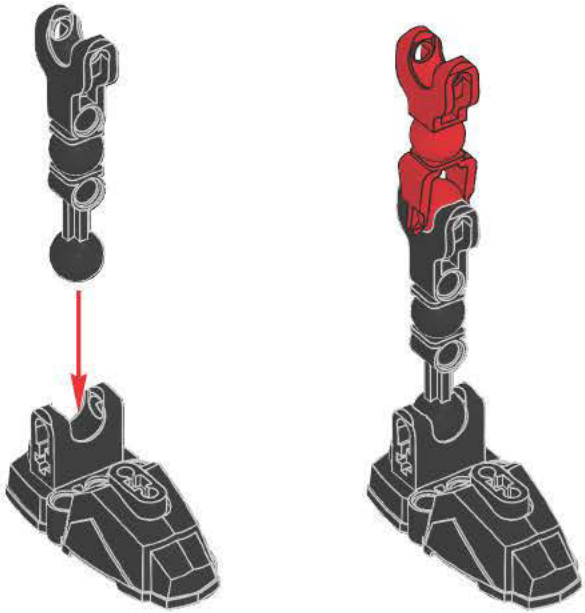

2x

3

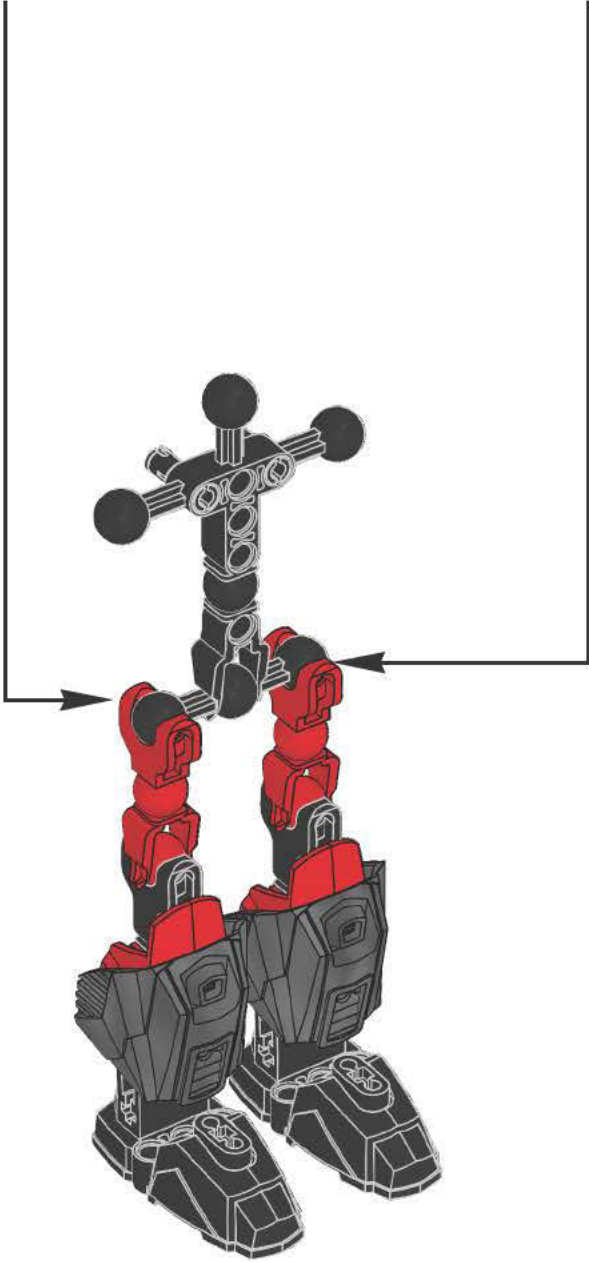

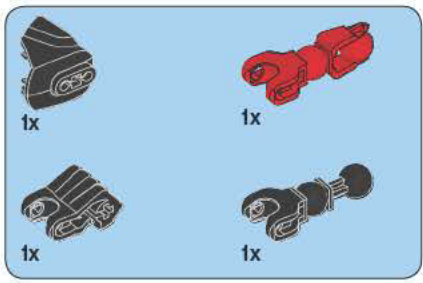

**3**

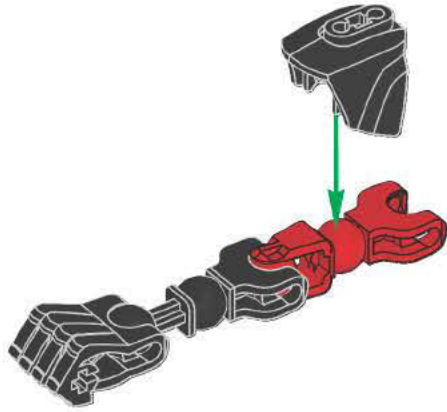

**2x**

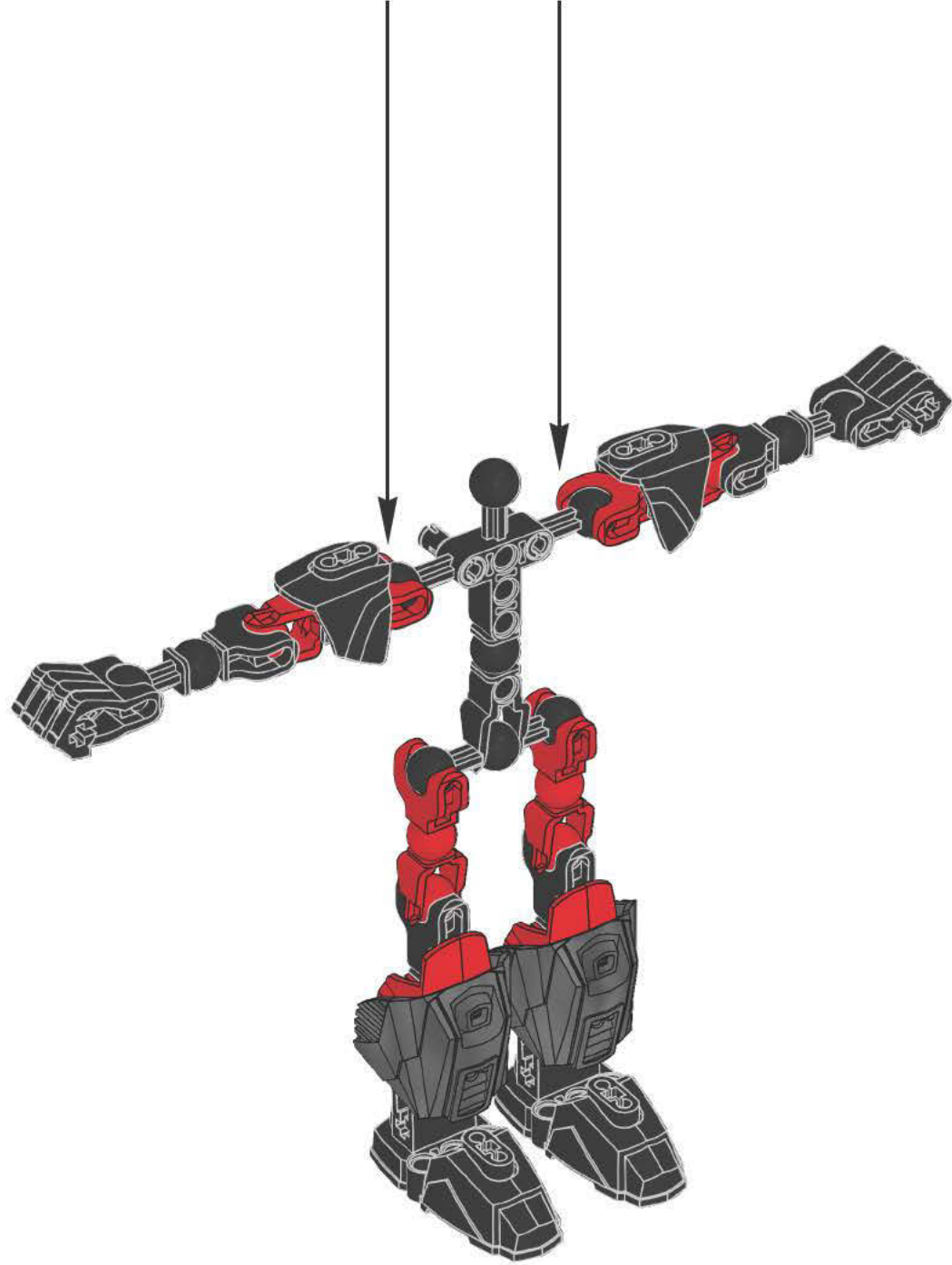

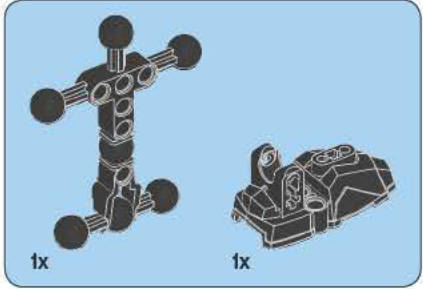
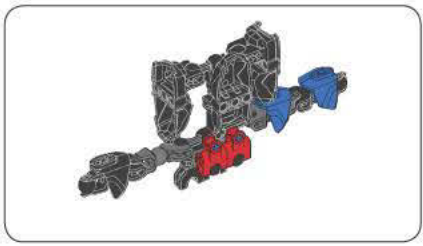

1

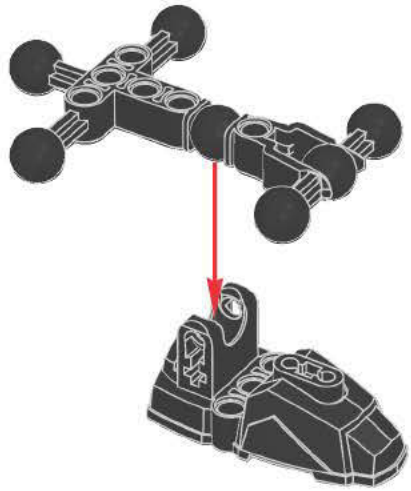

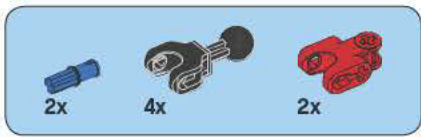

2

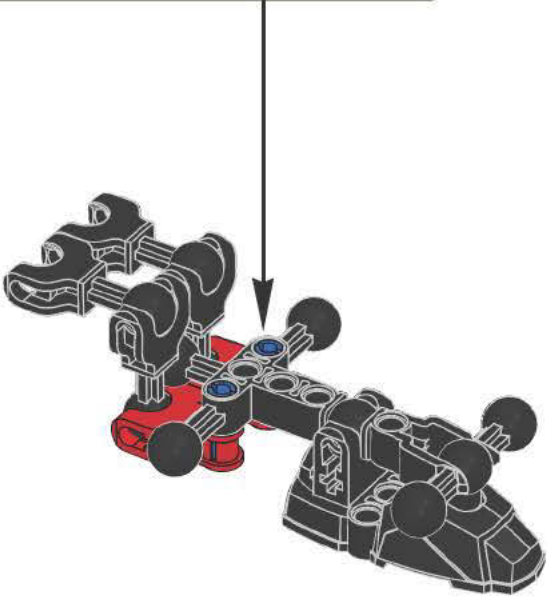
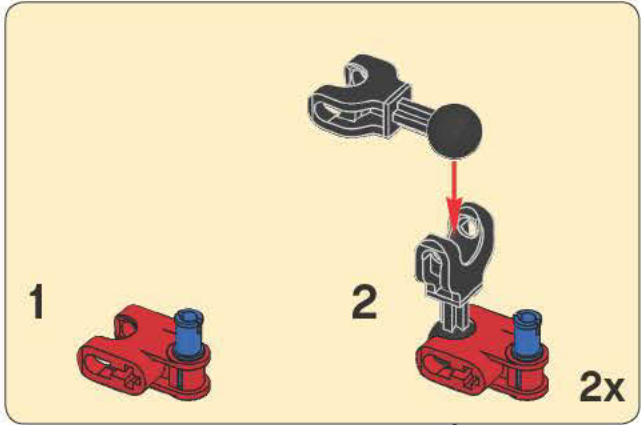



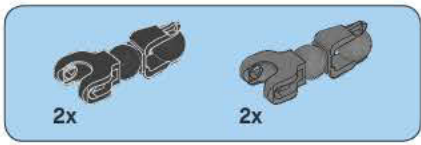

3

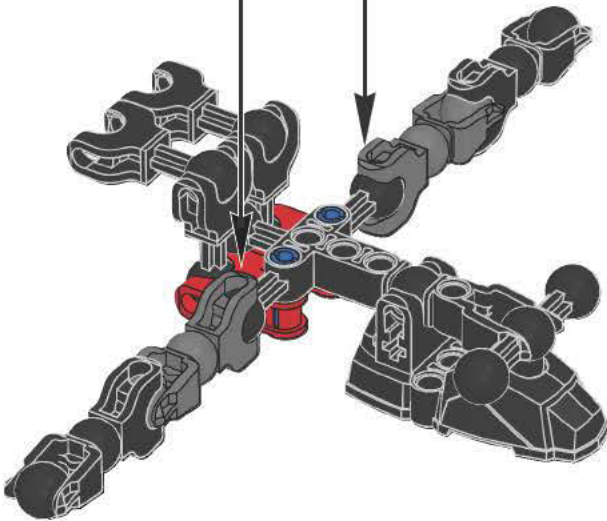
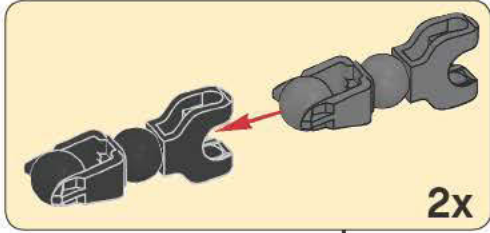

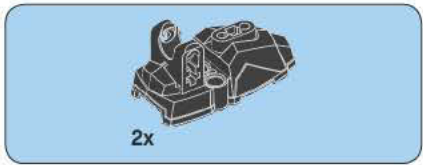

4

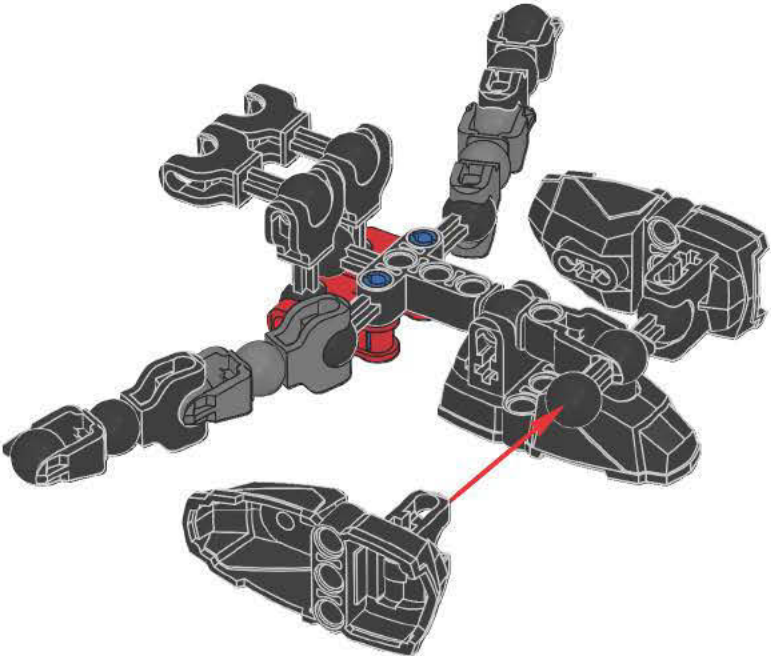

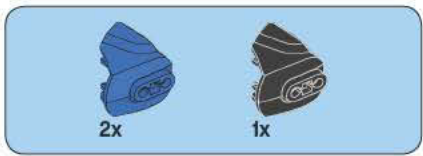

5

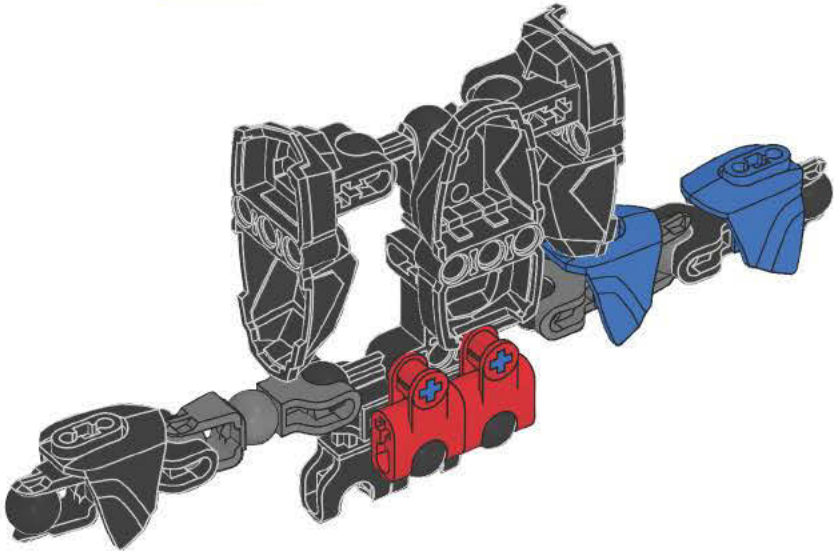

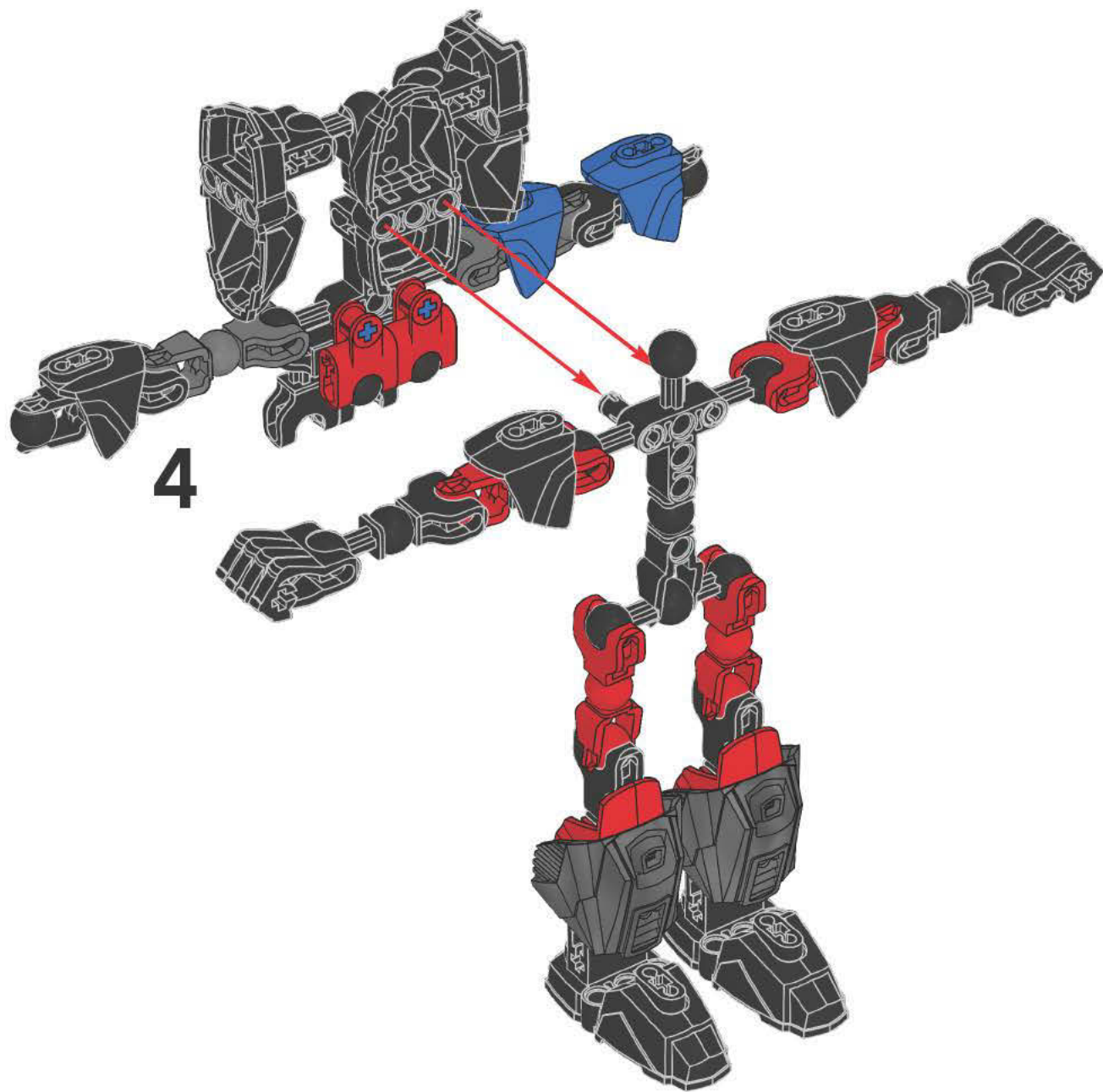

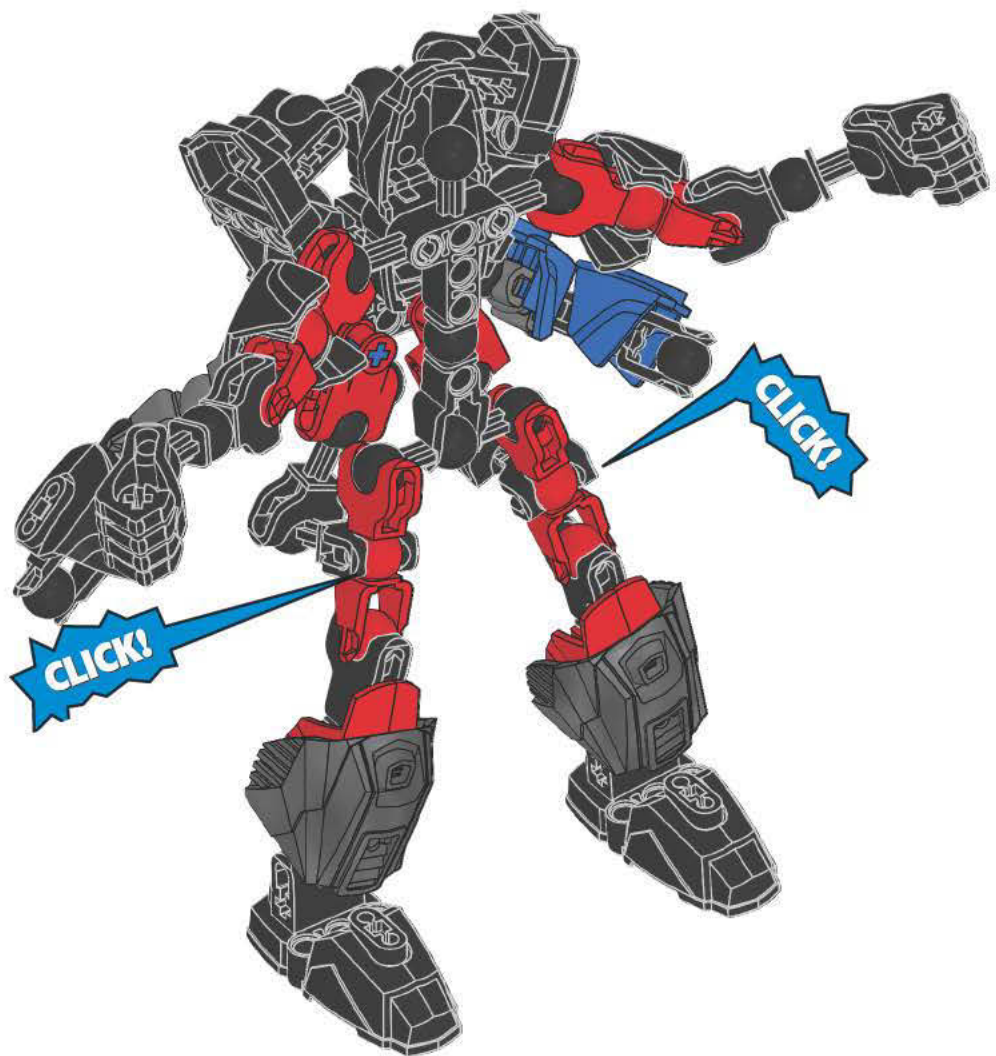

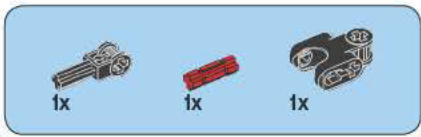

5

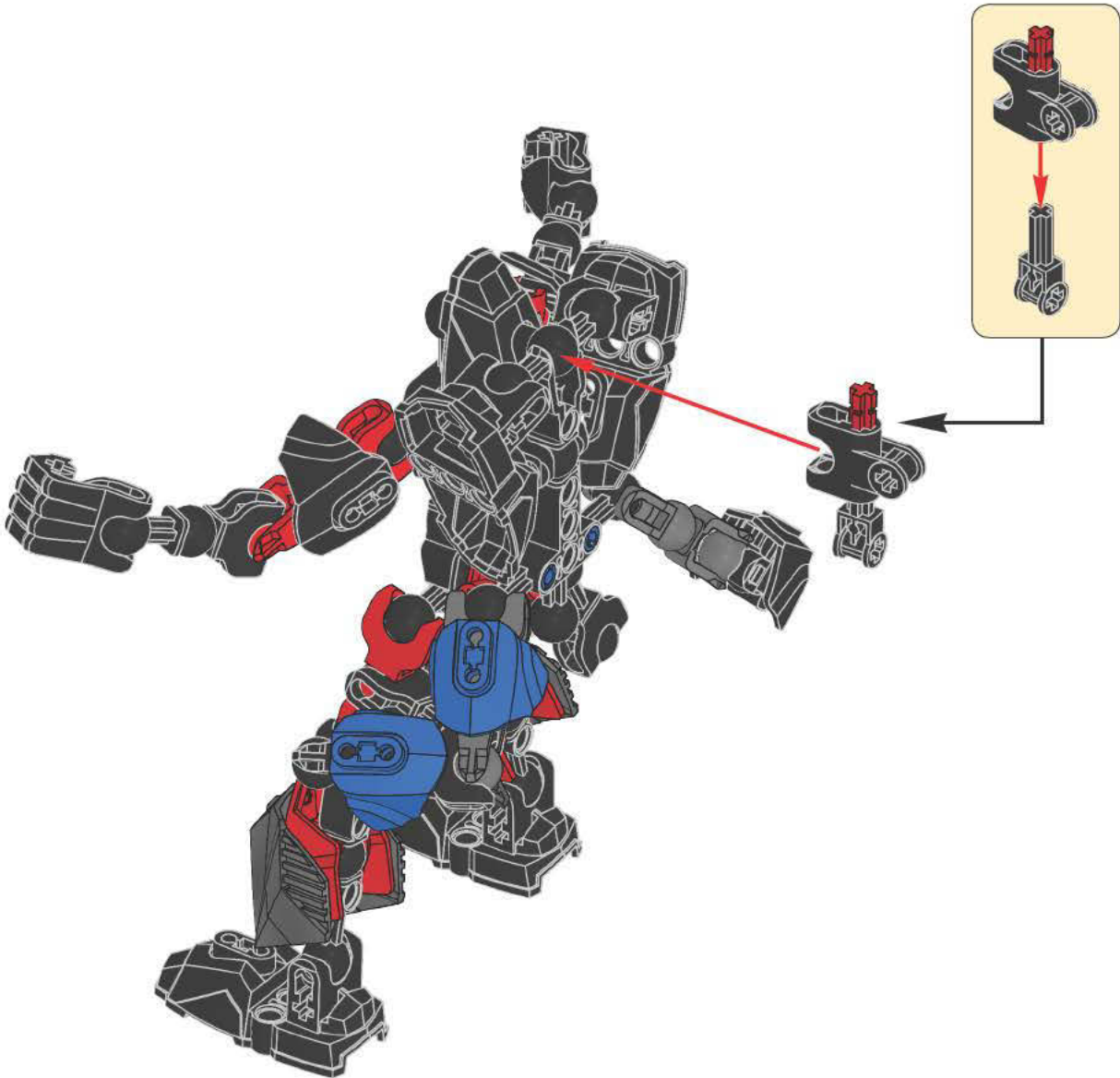



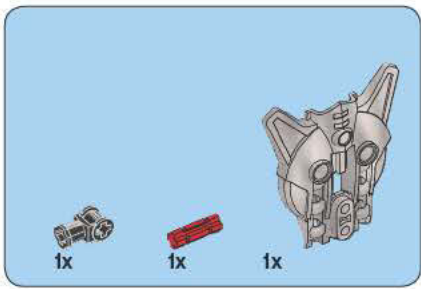

6

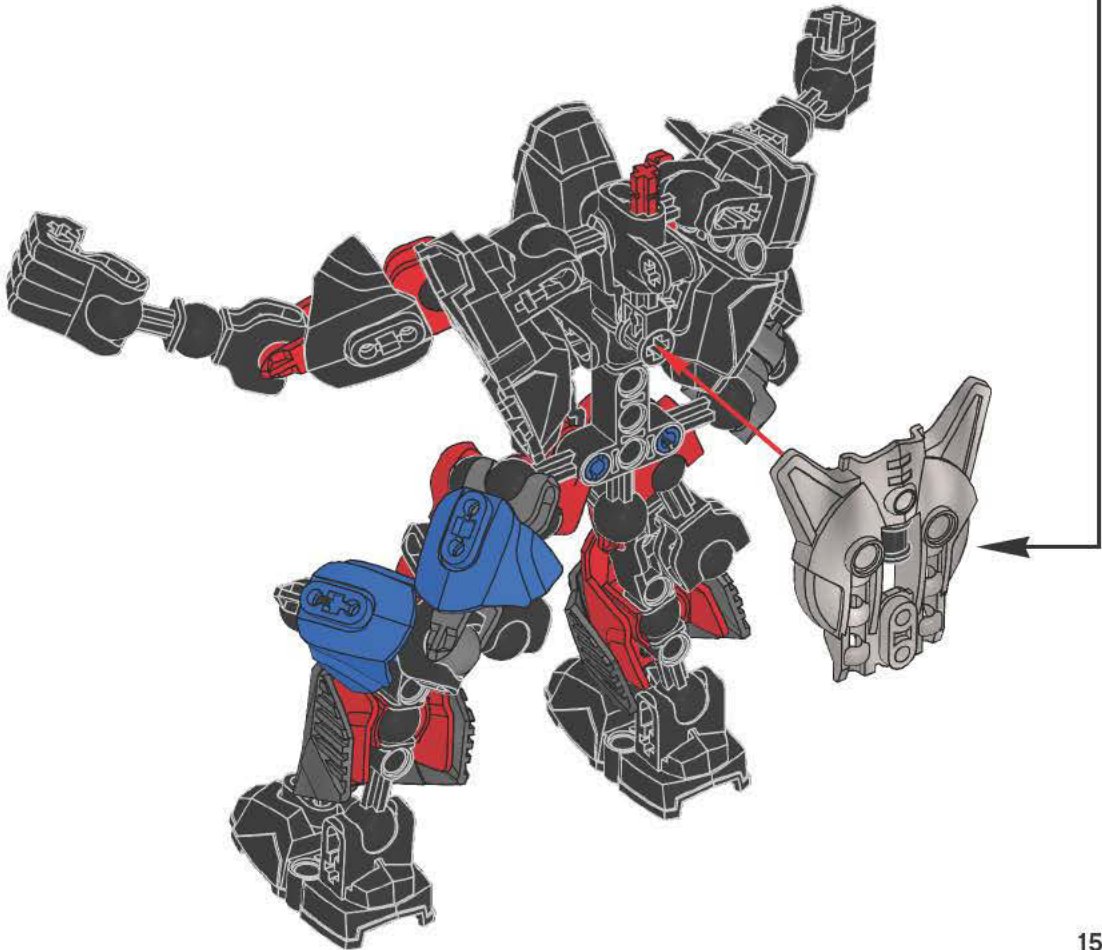
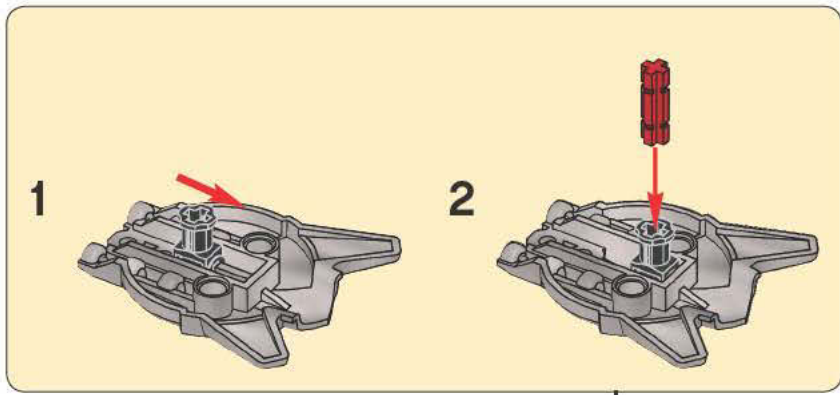

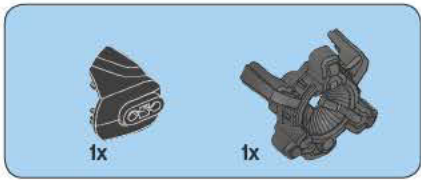

7

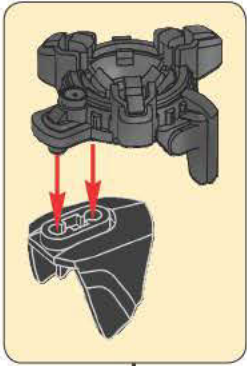
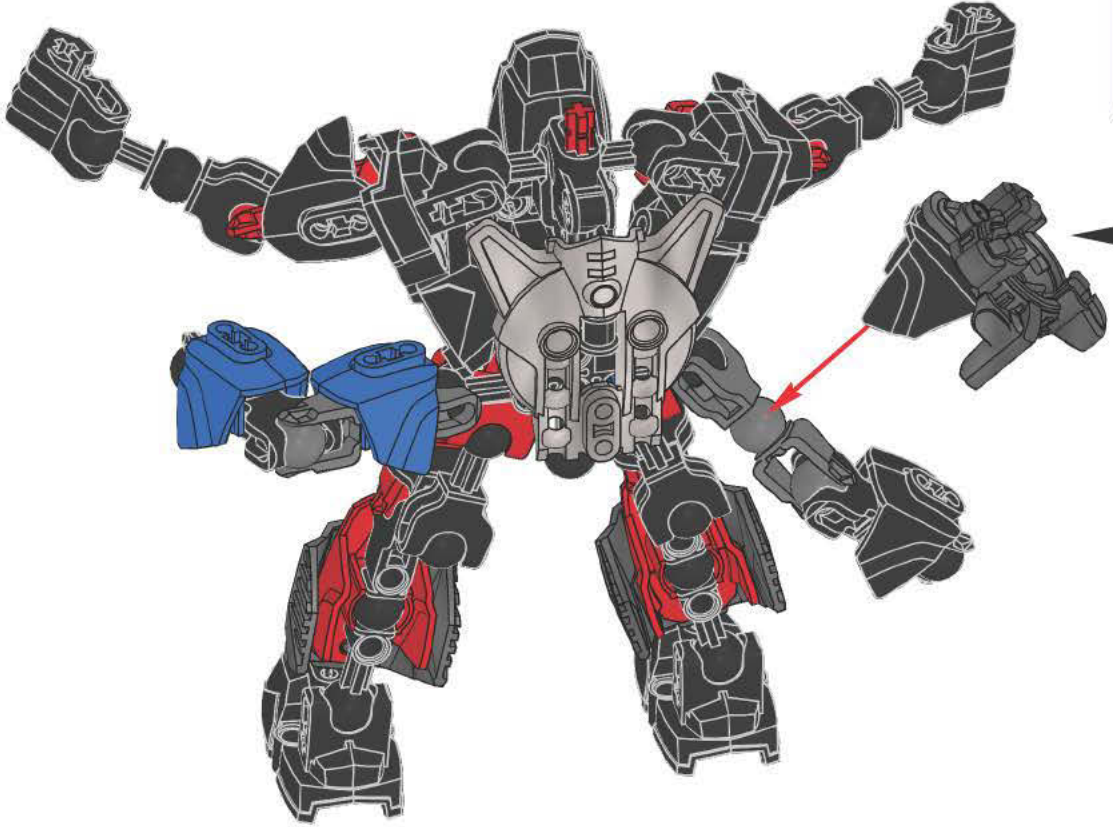



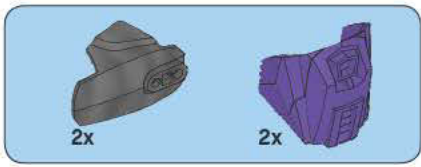

8

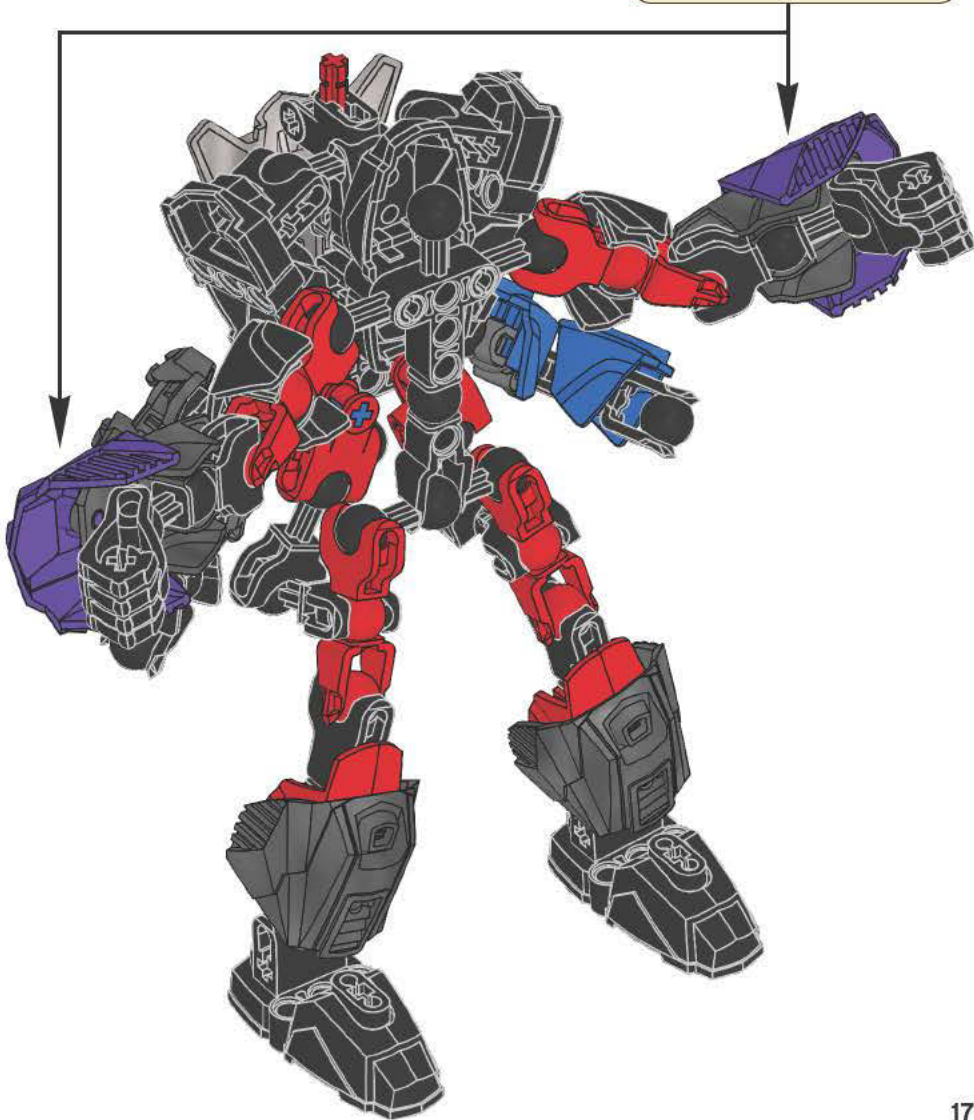
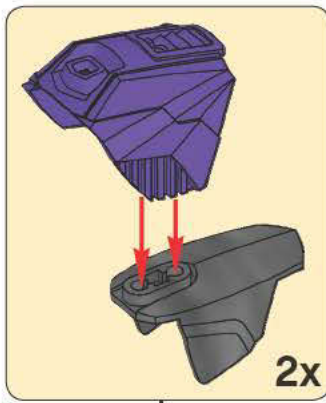

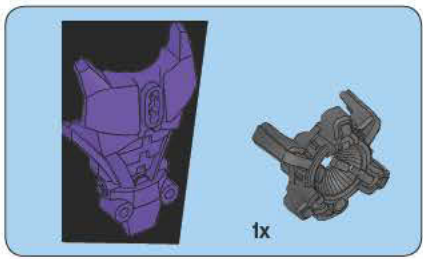

9

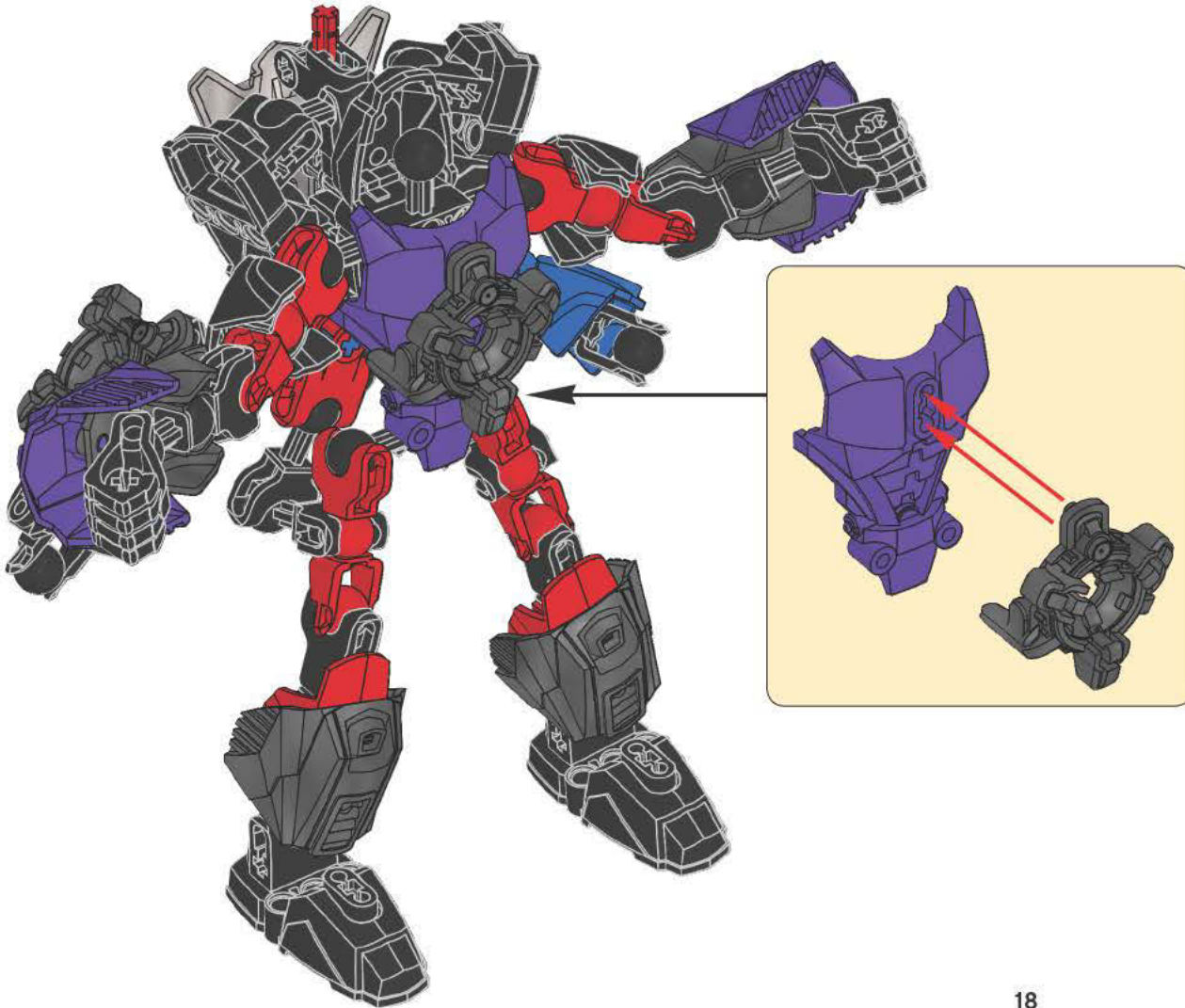

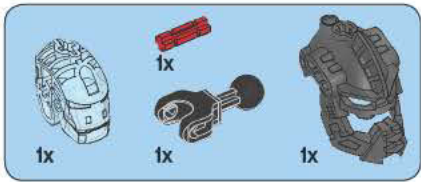

10

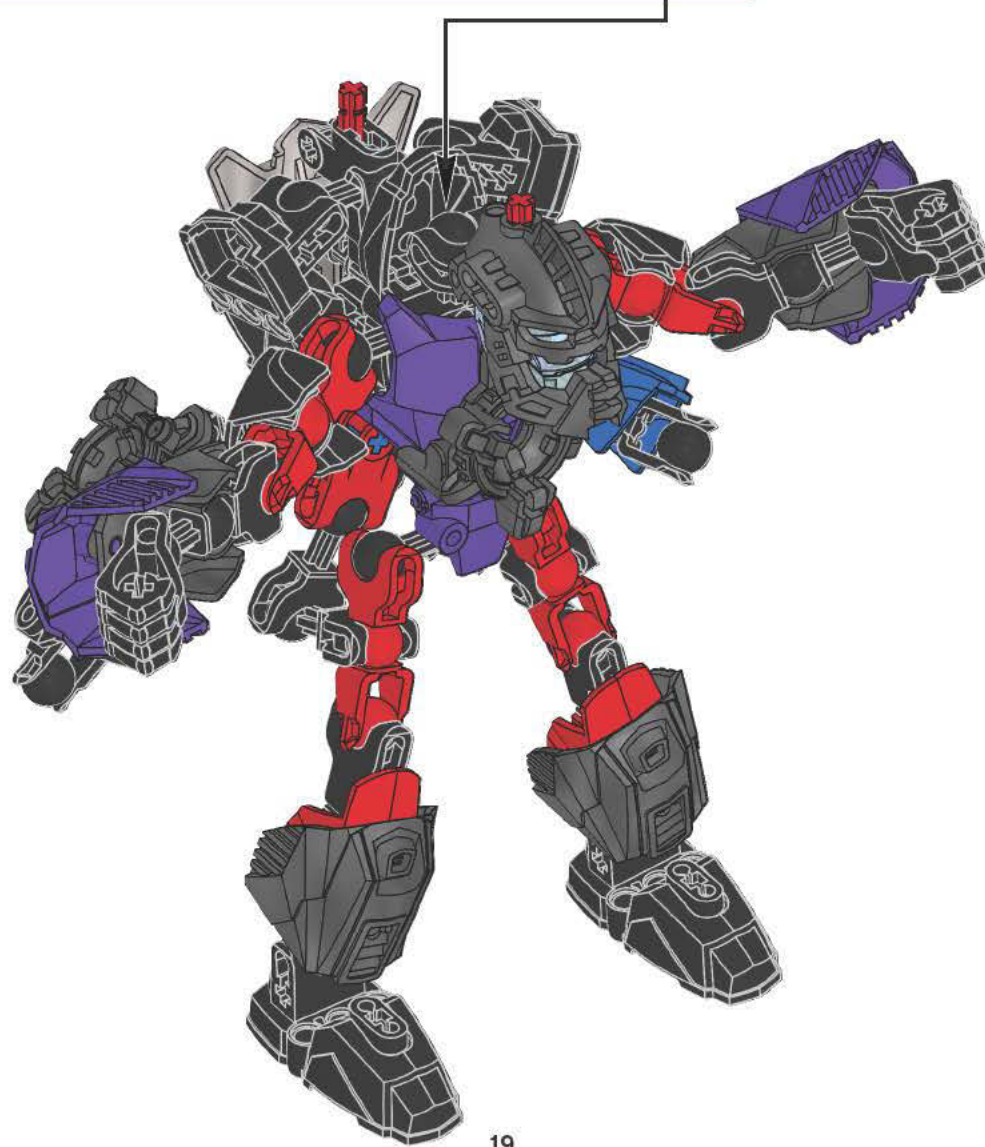
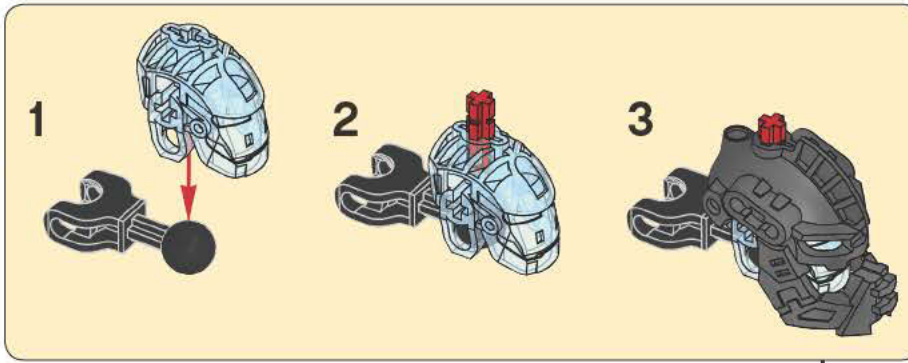



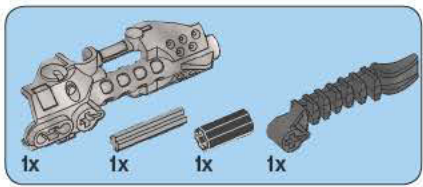

# 11

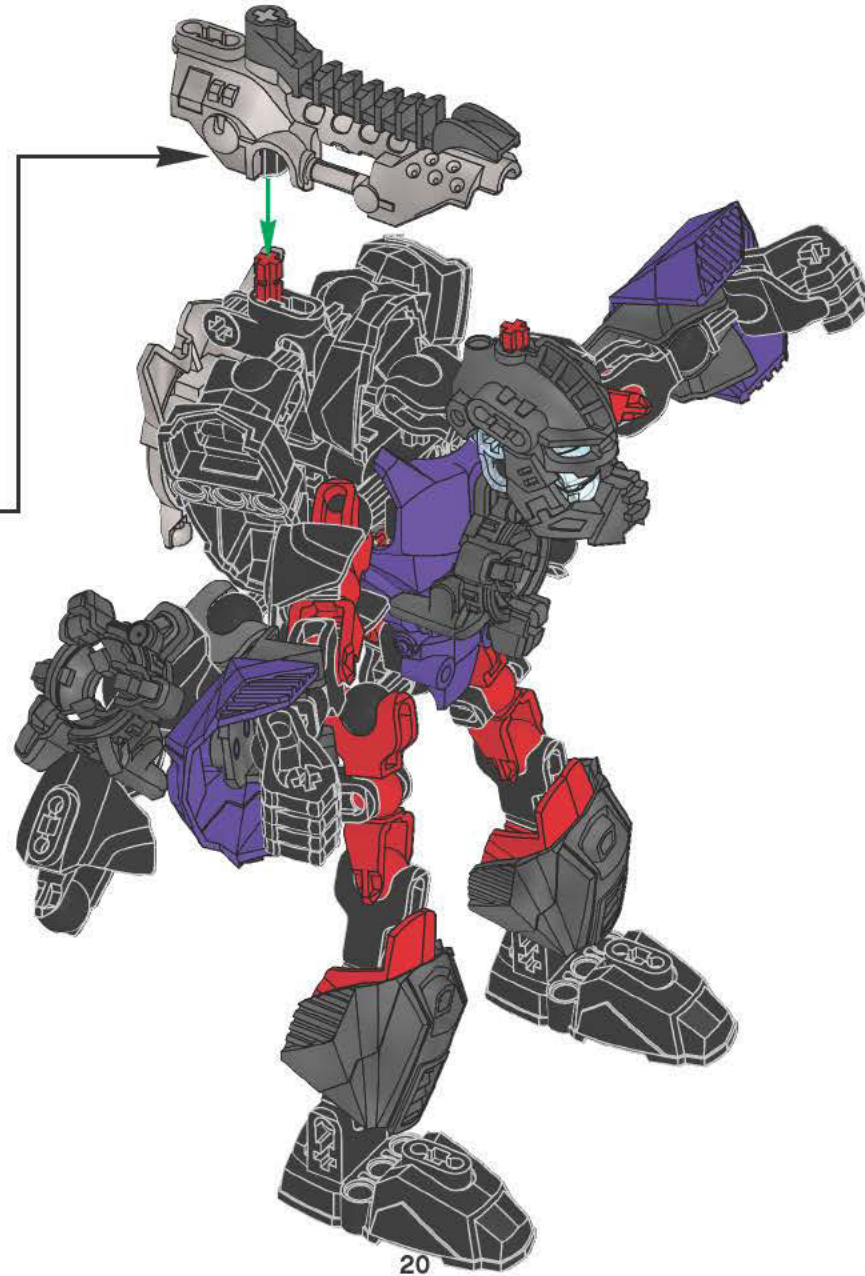
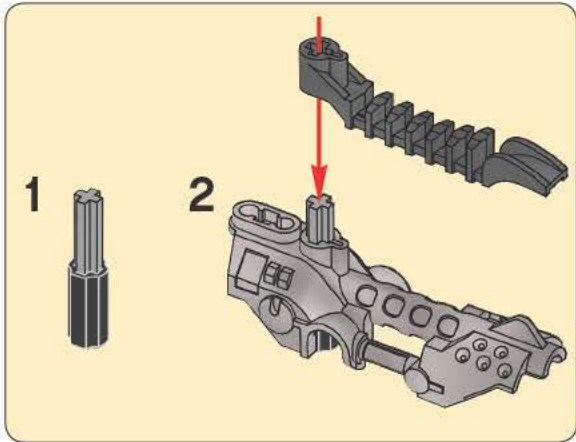

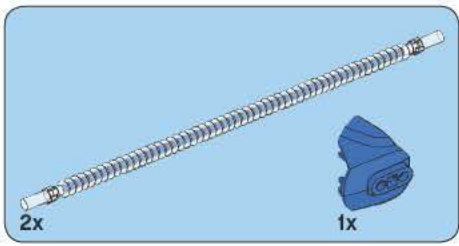

12



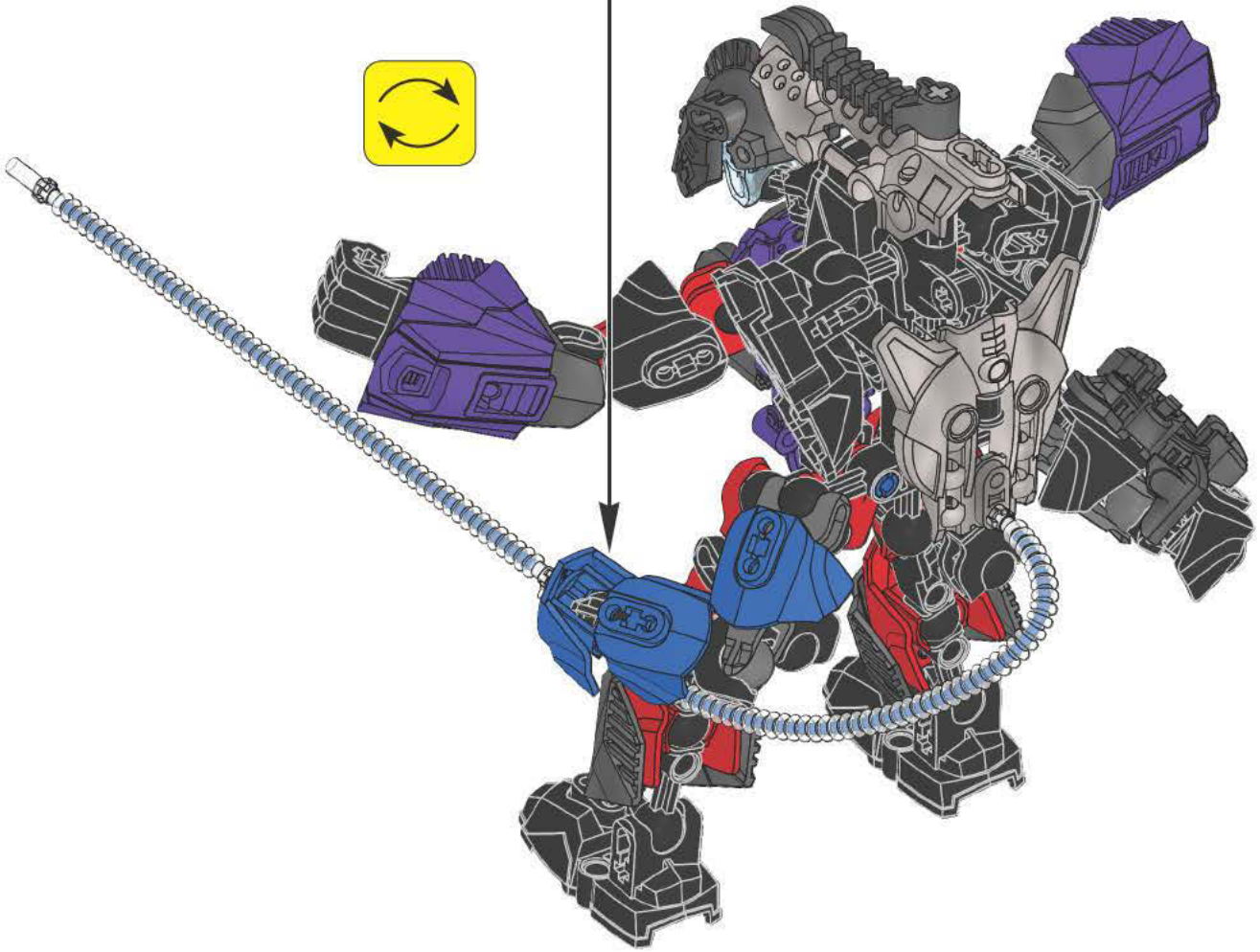

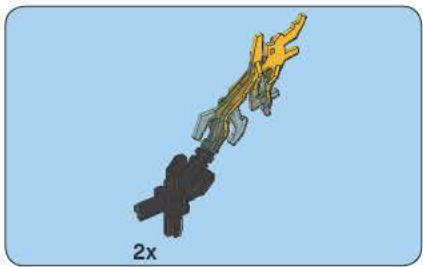

13

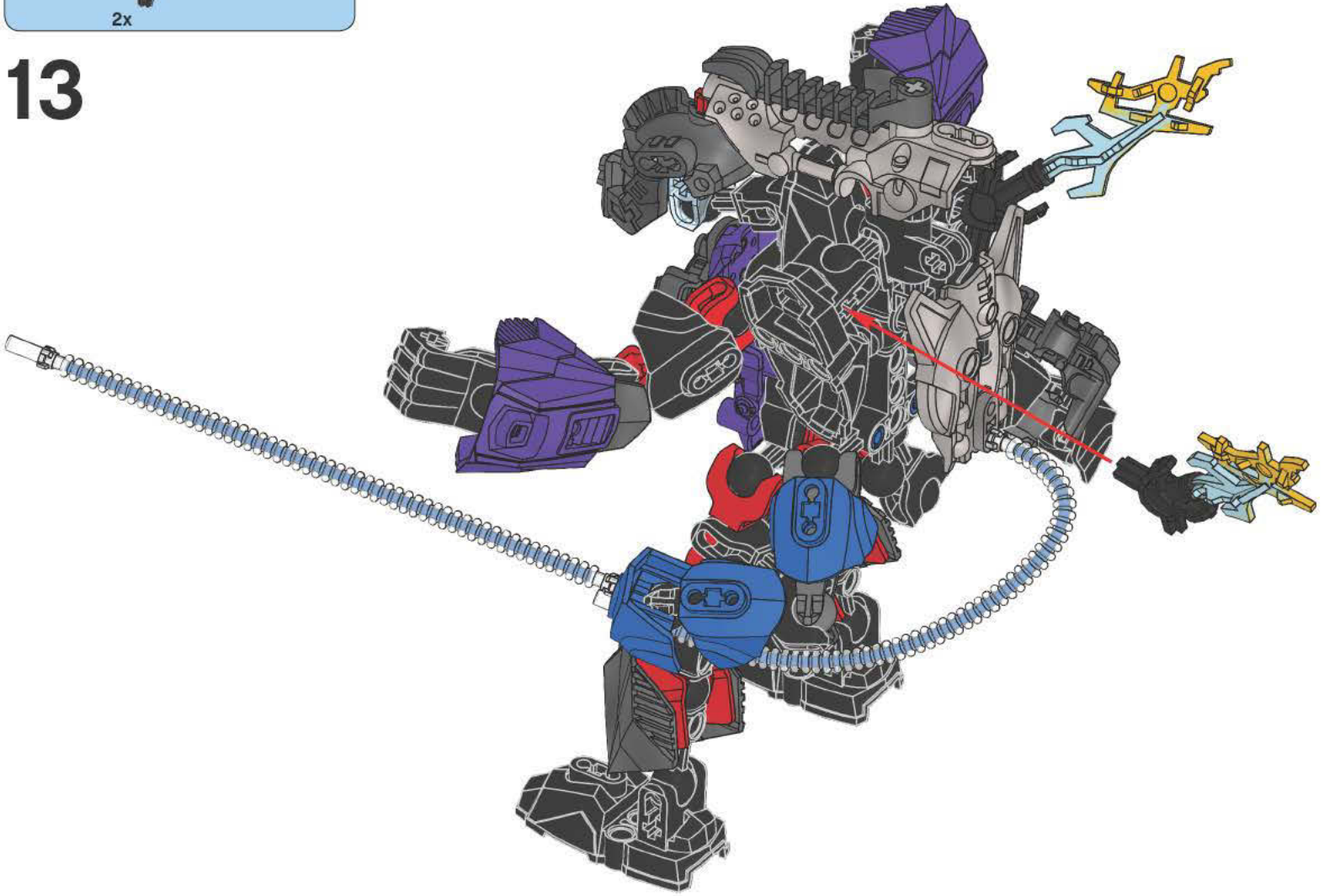

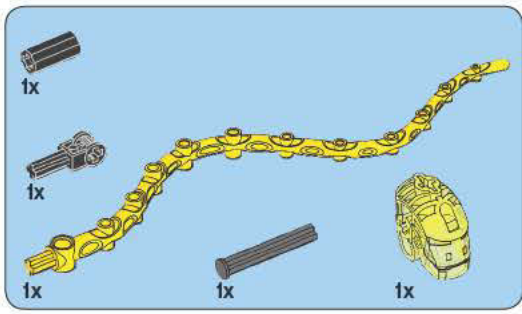

14

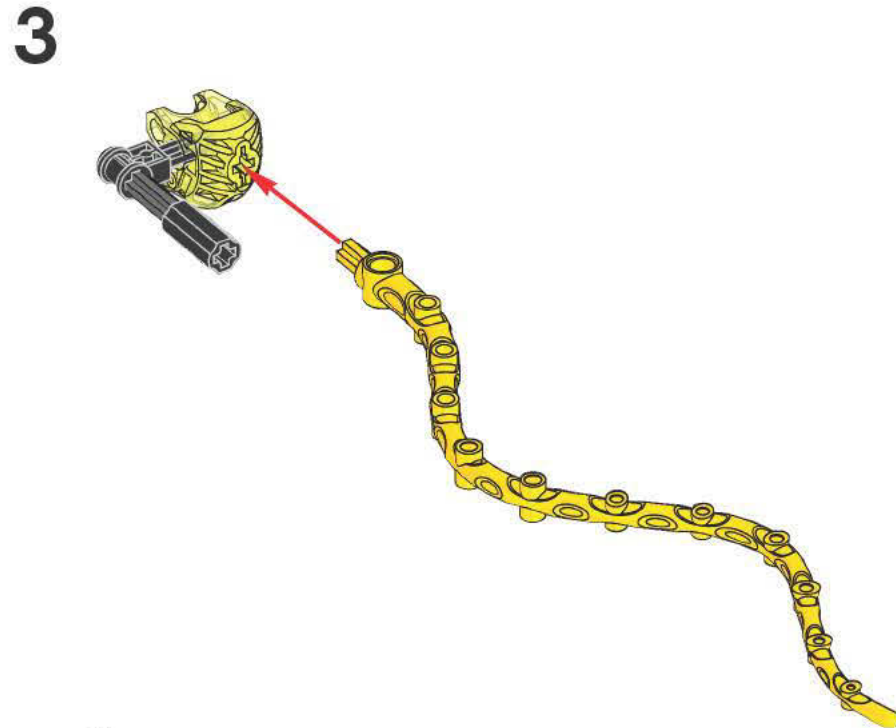



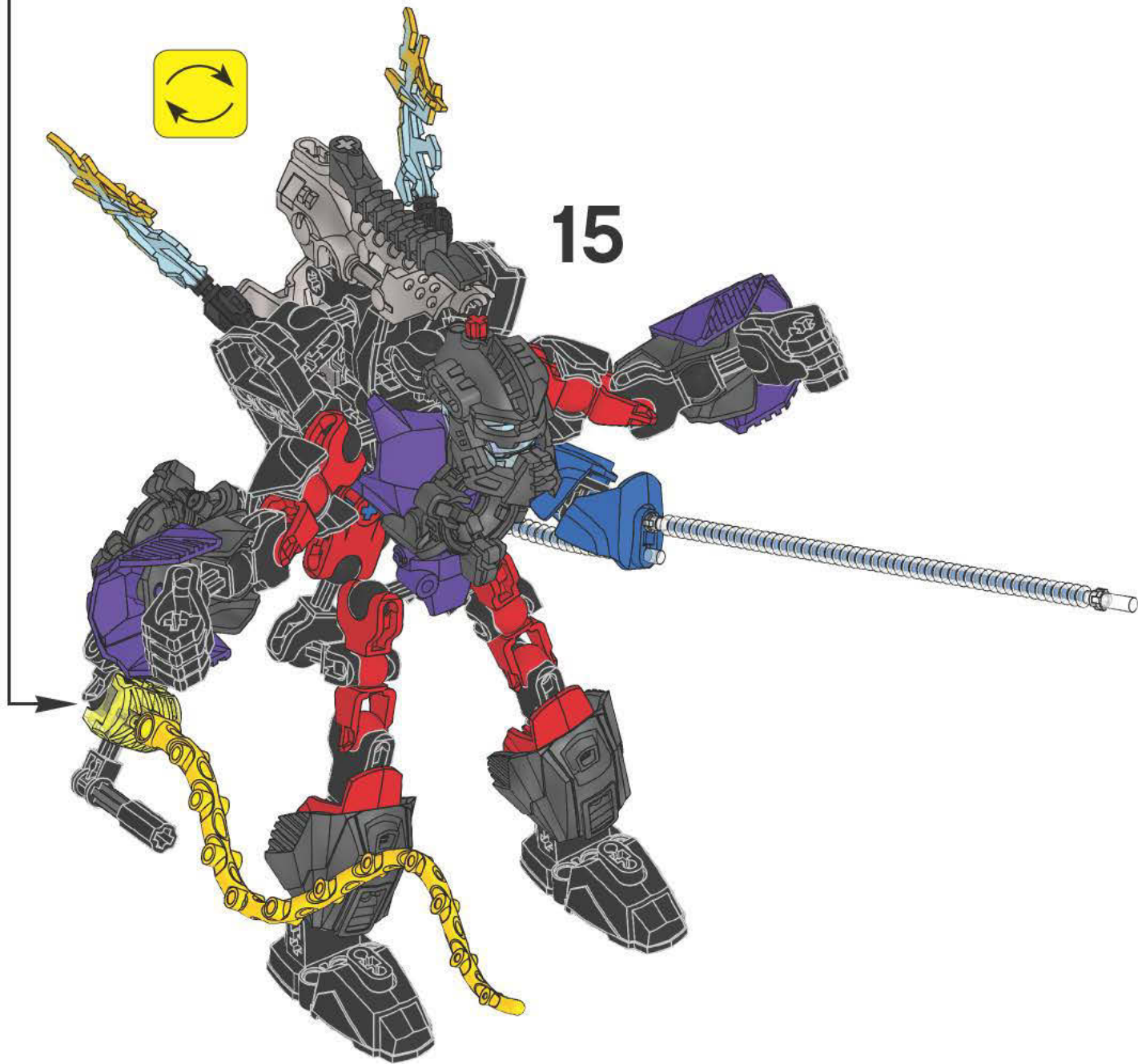

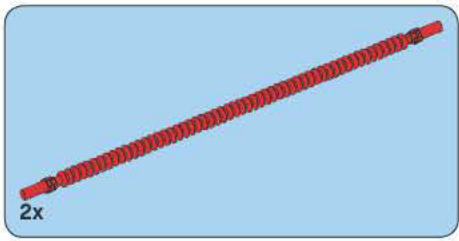

16

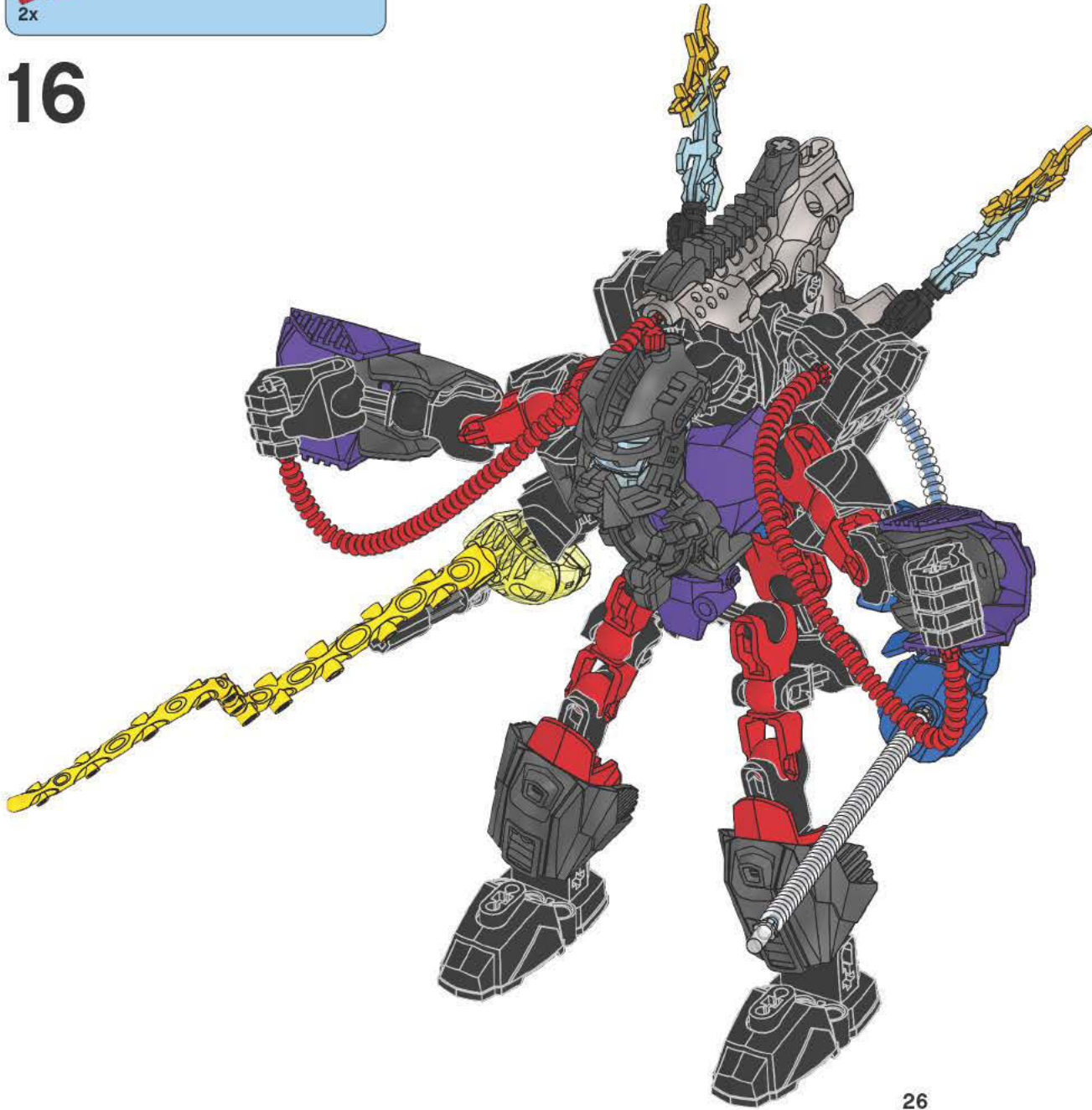

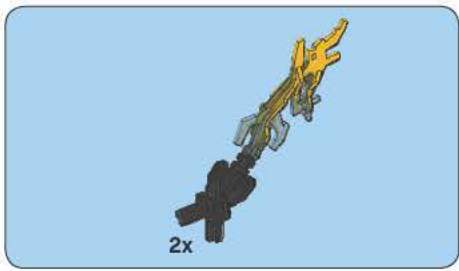

17

