



6193



2



1



2

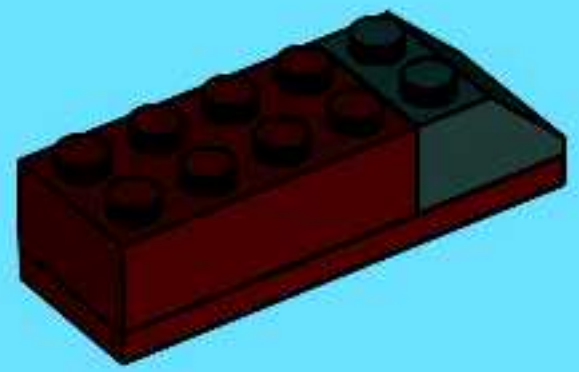

1



2



3

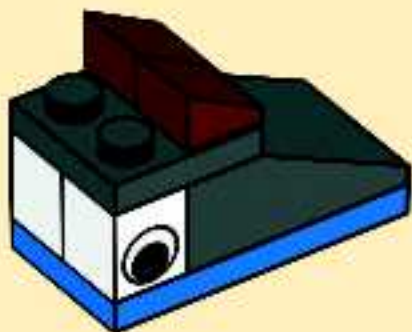

3

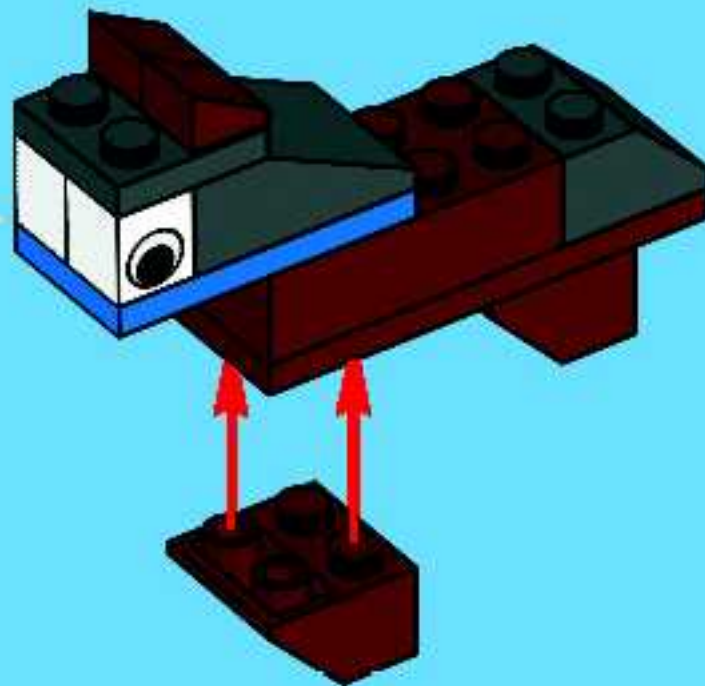

4

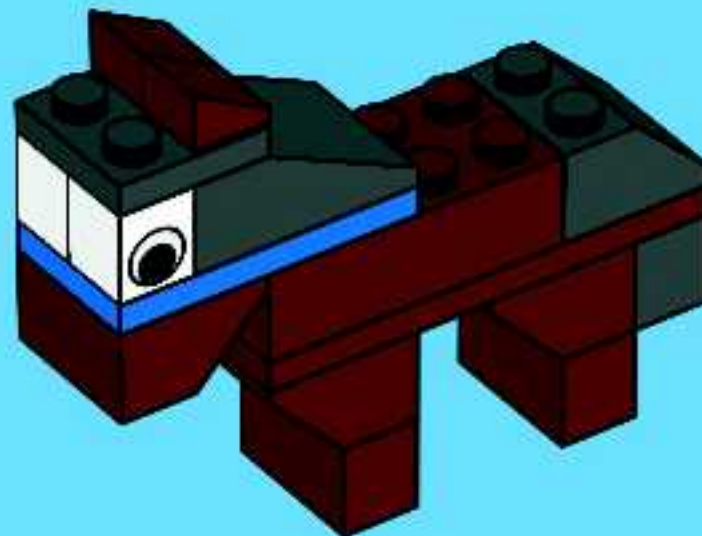



1

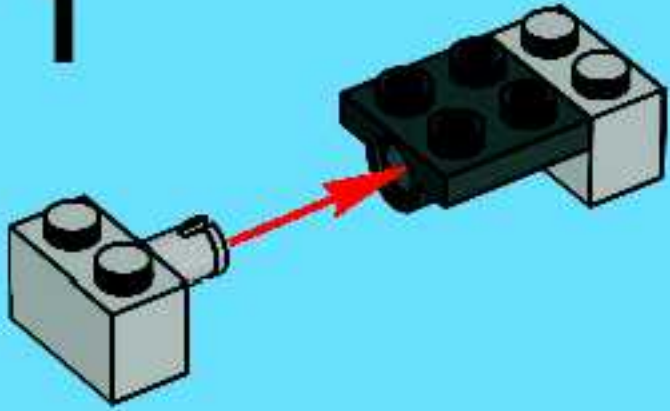

2

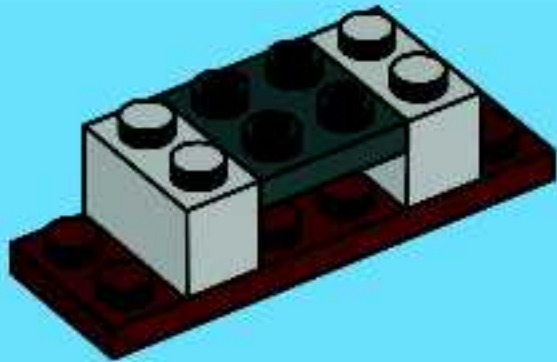

3

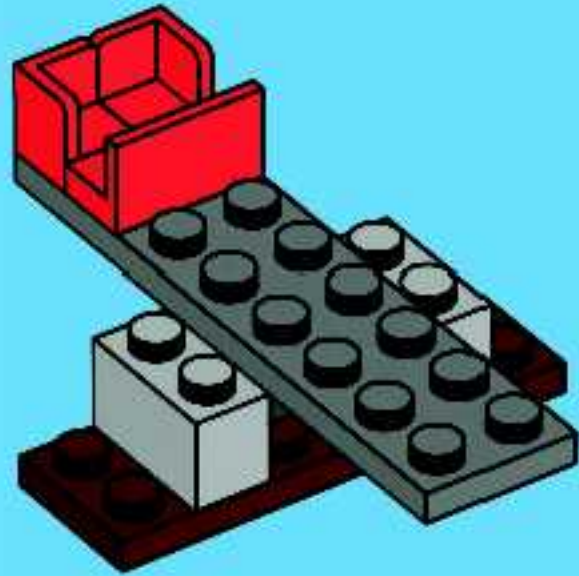

4

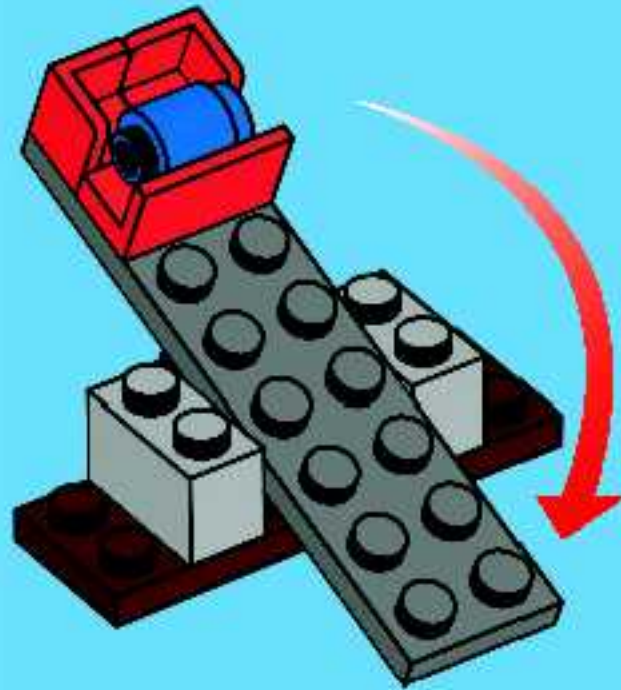



[www.LEGO.com](http://www.LEGO.com)





1

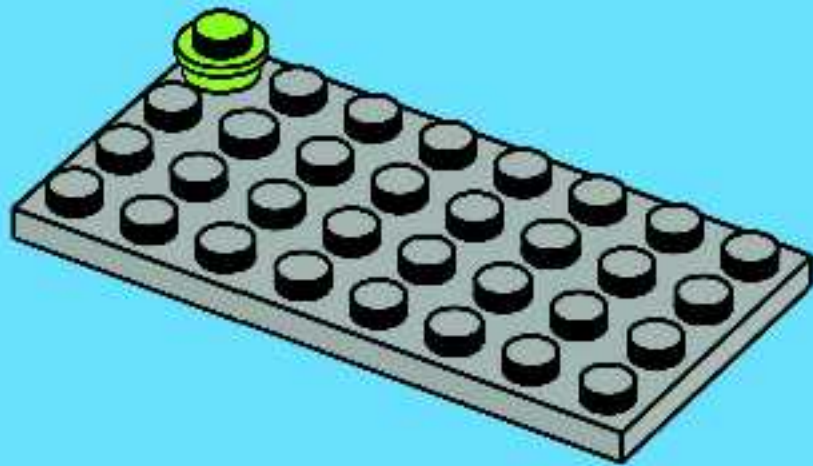

2

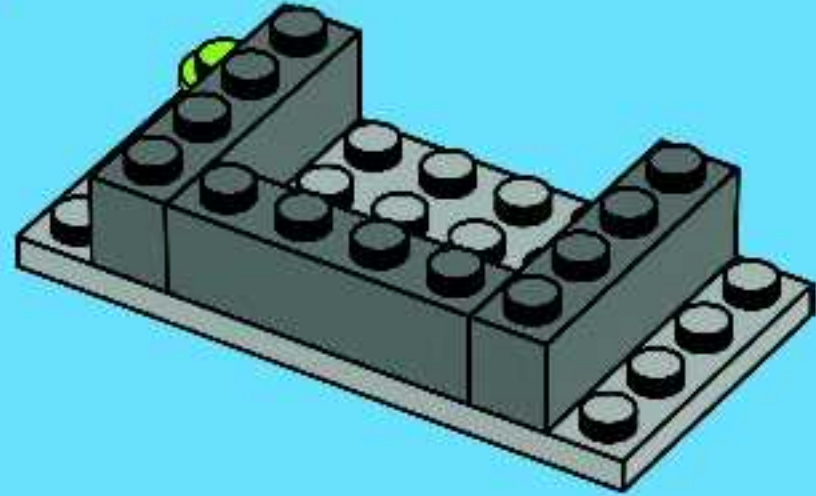

3

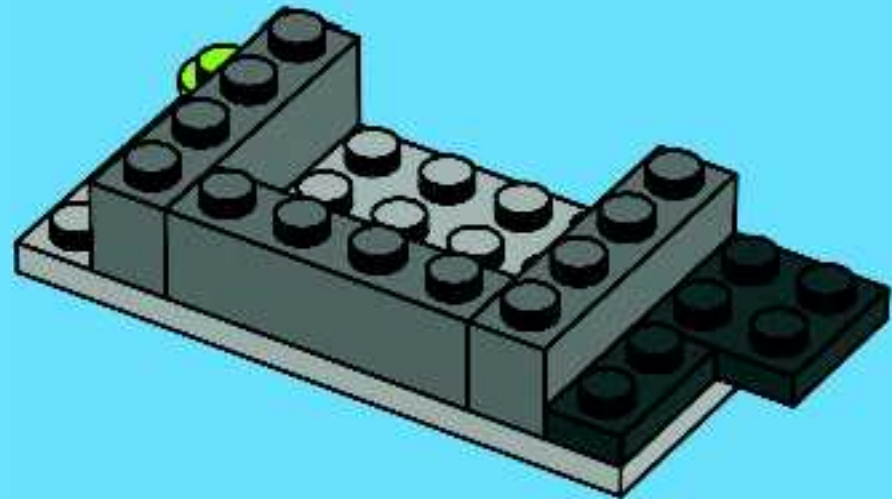

4

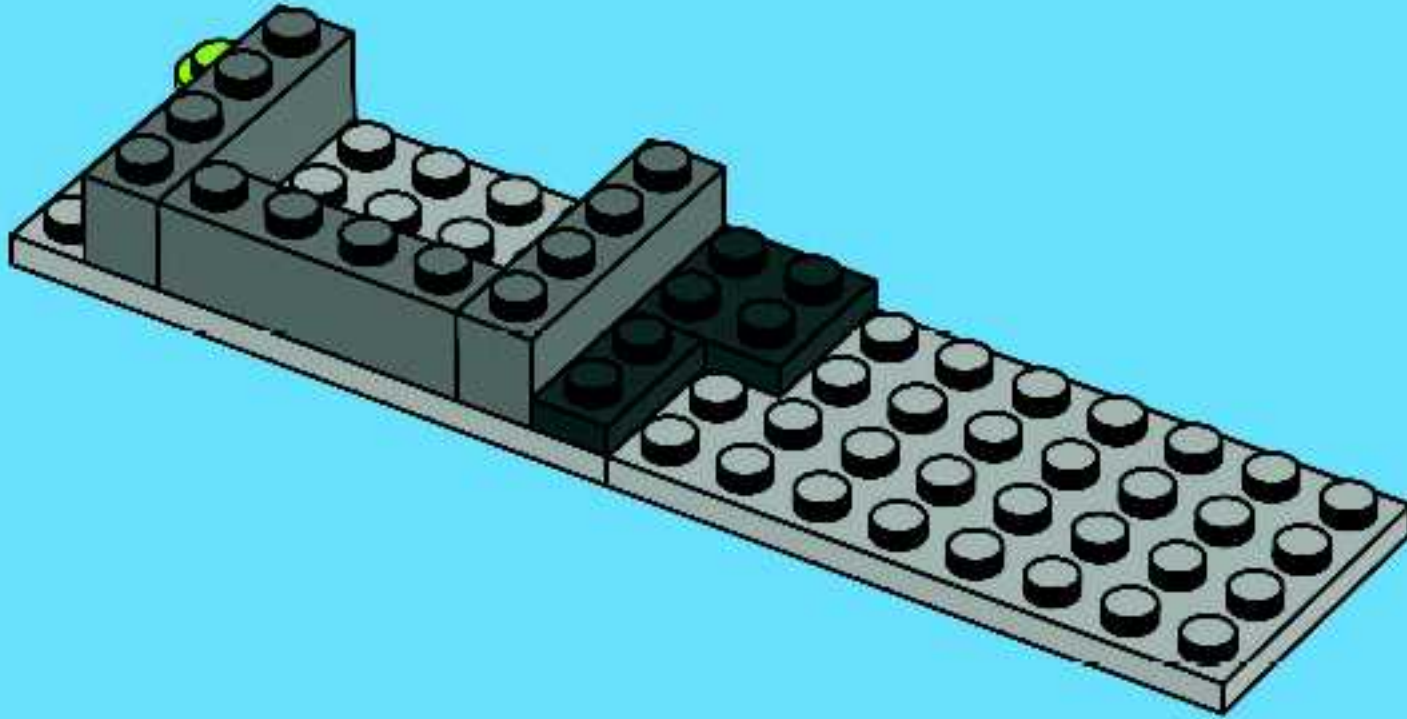

5

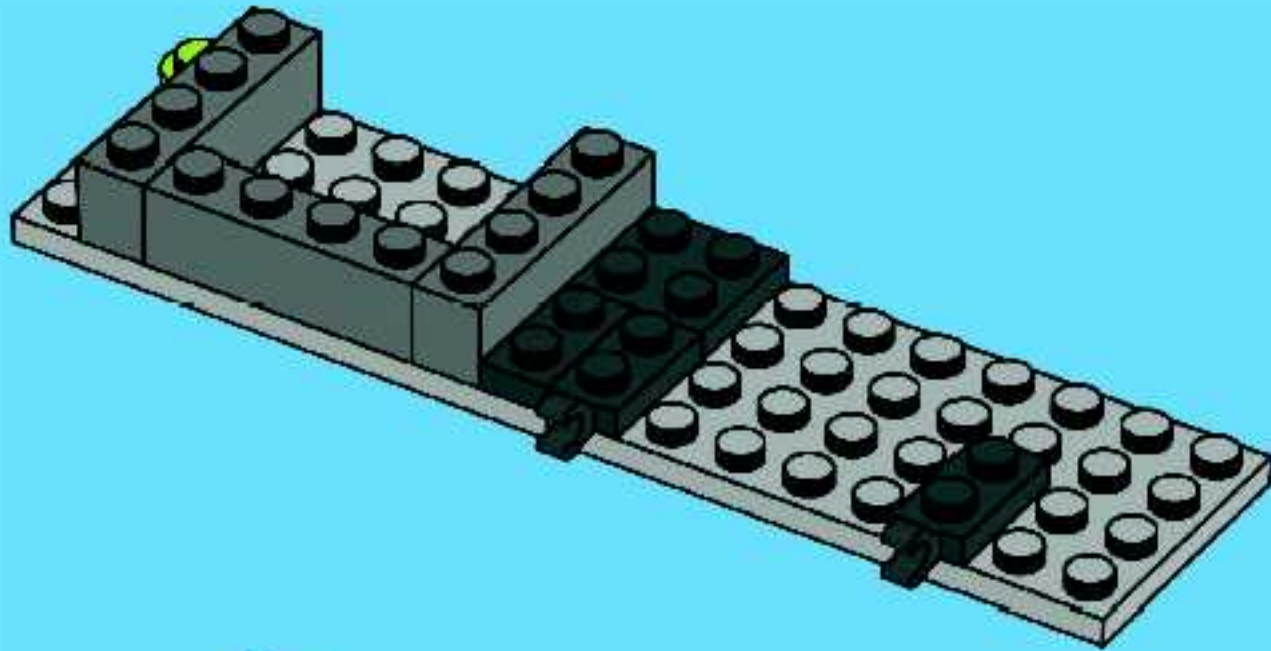

6

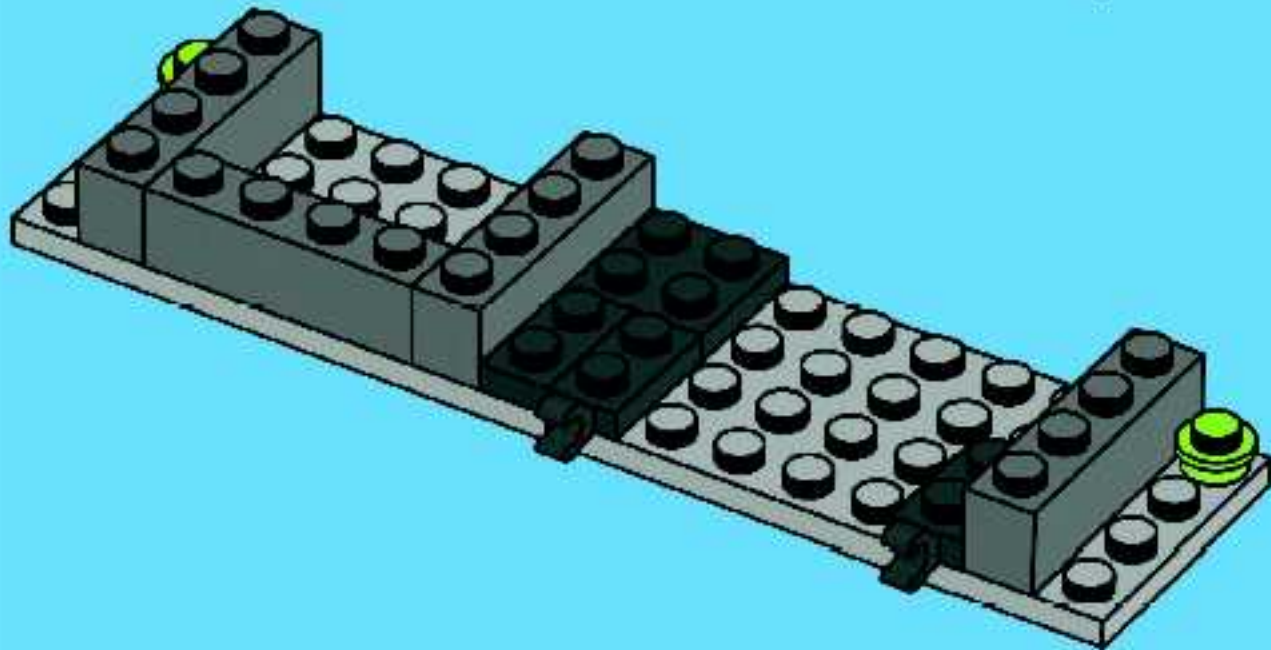



7

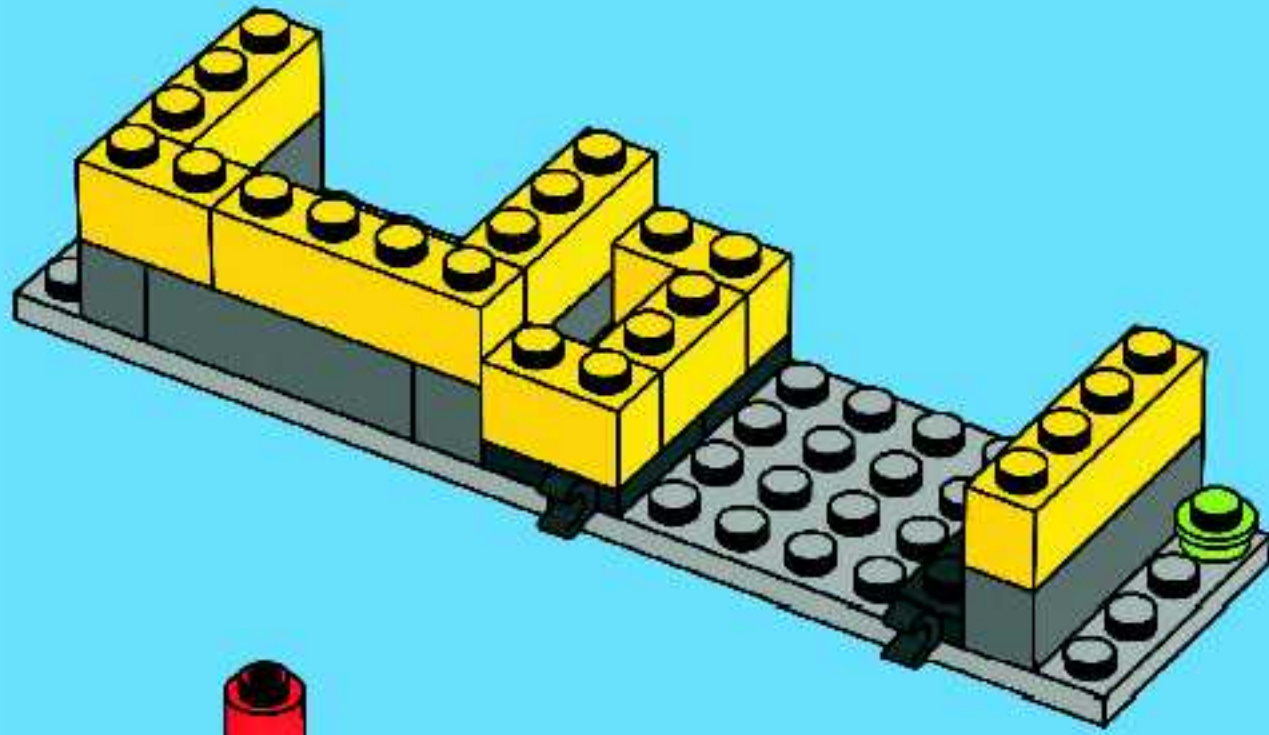

8

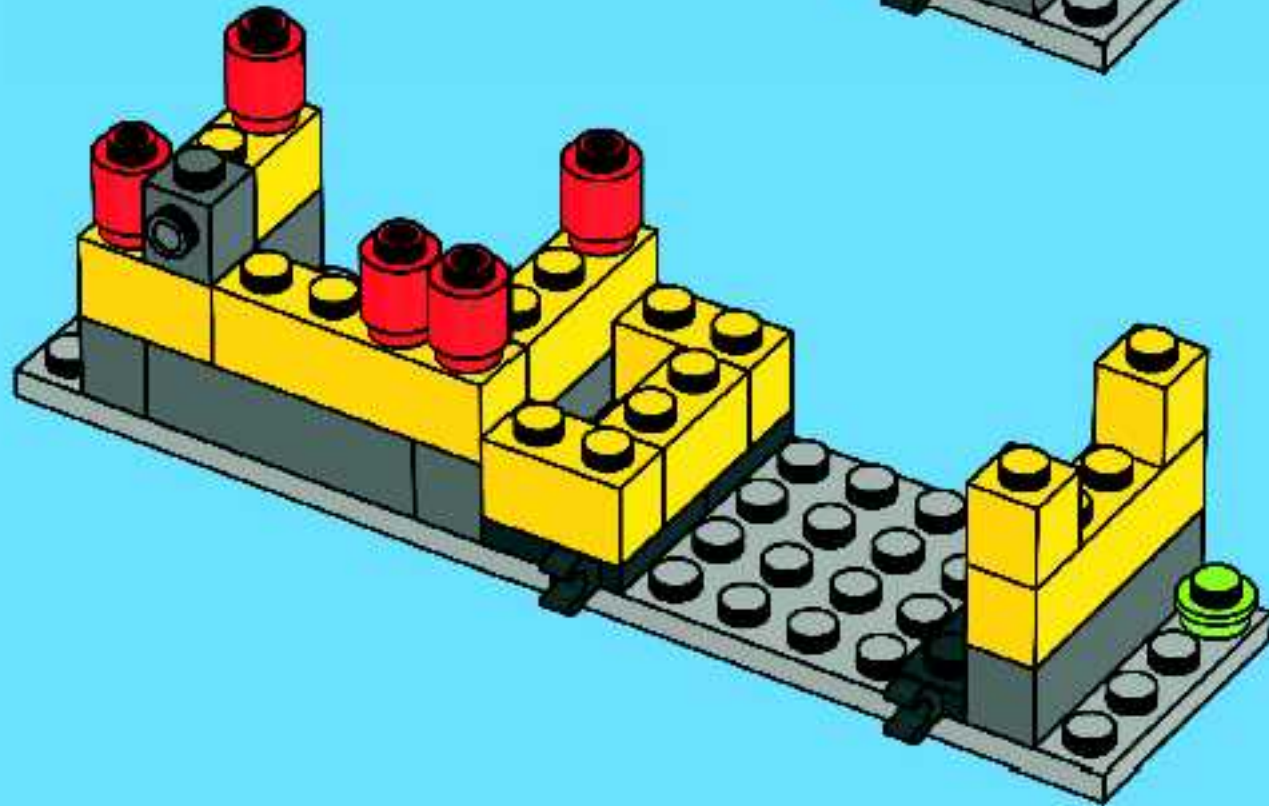

9

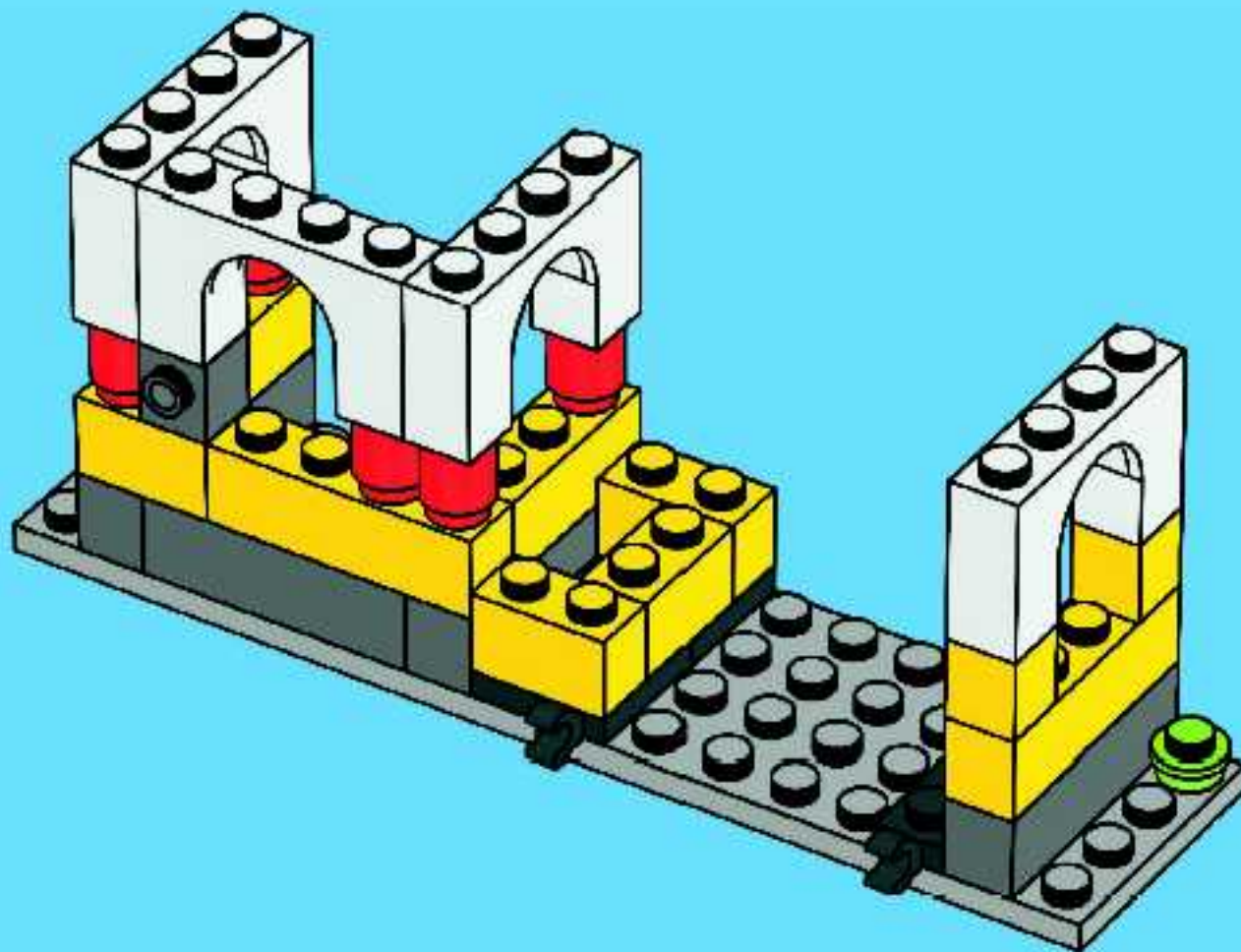

10

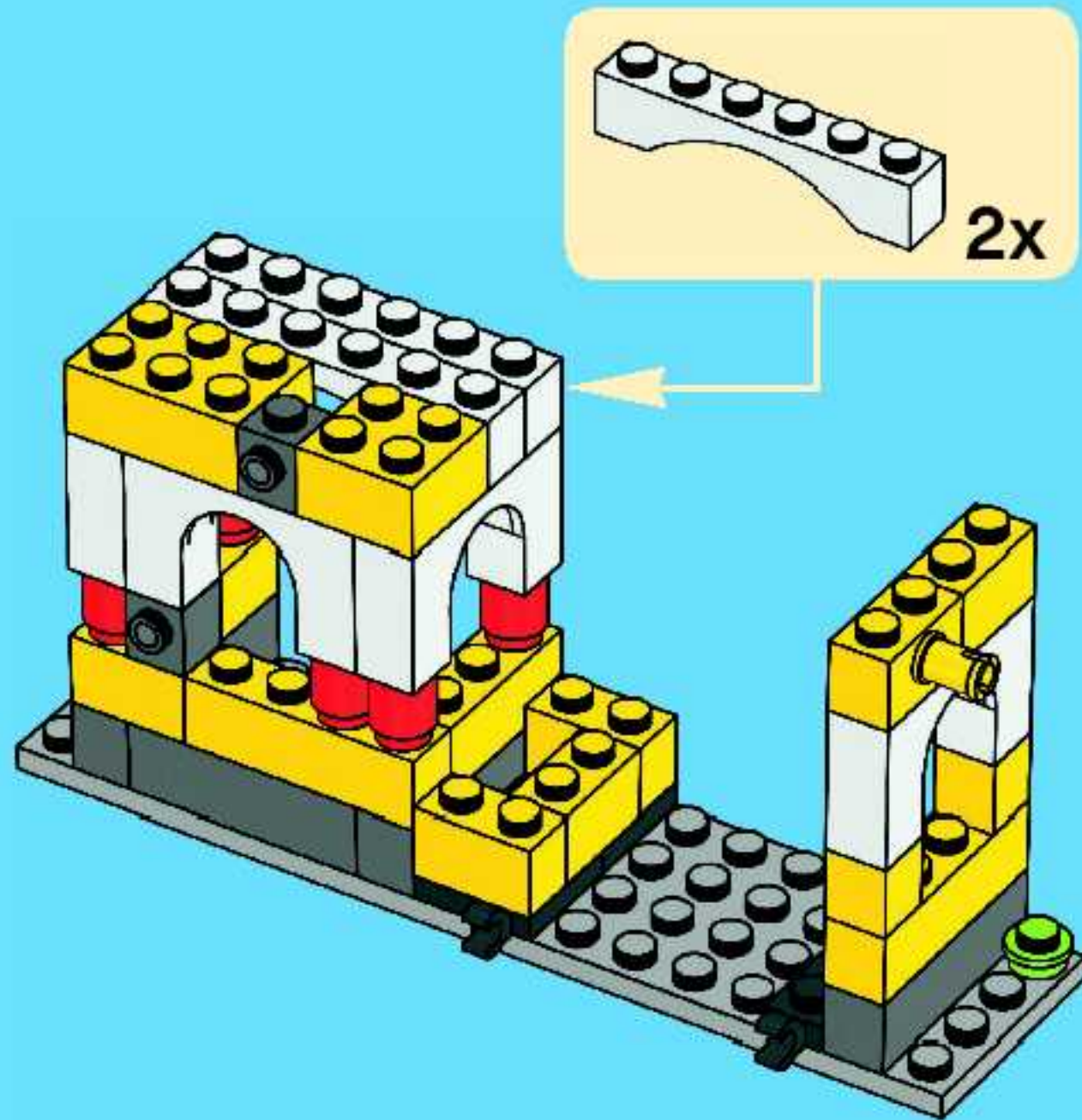

11

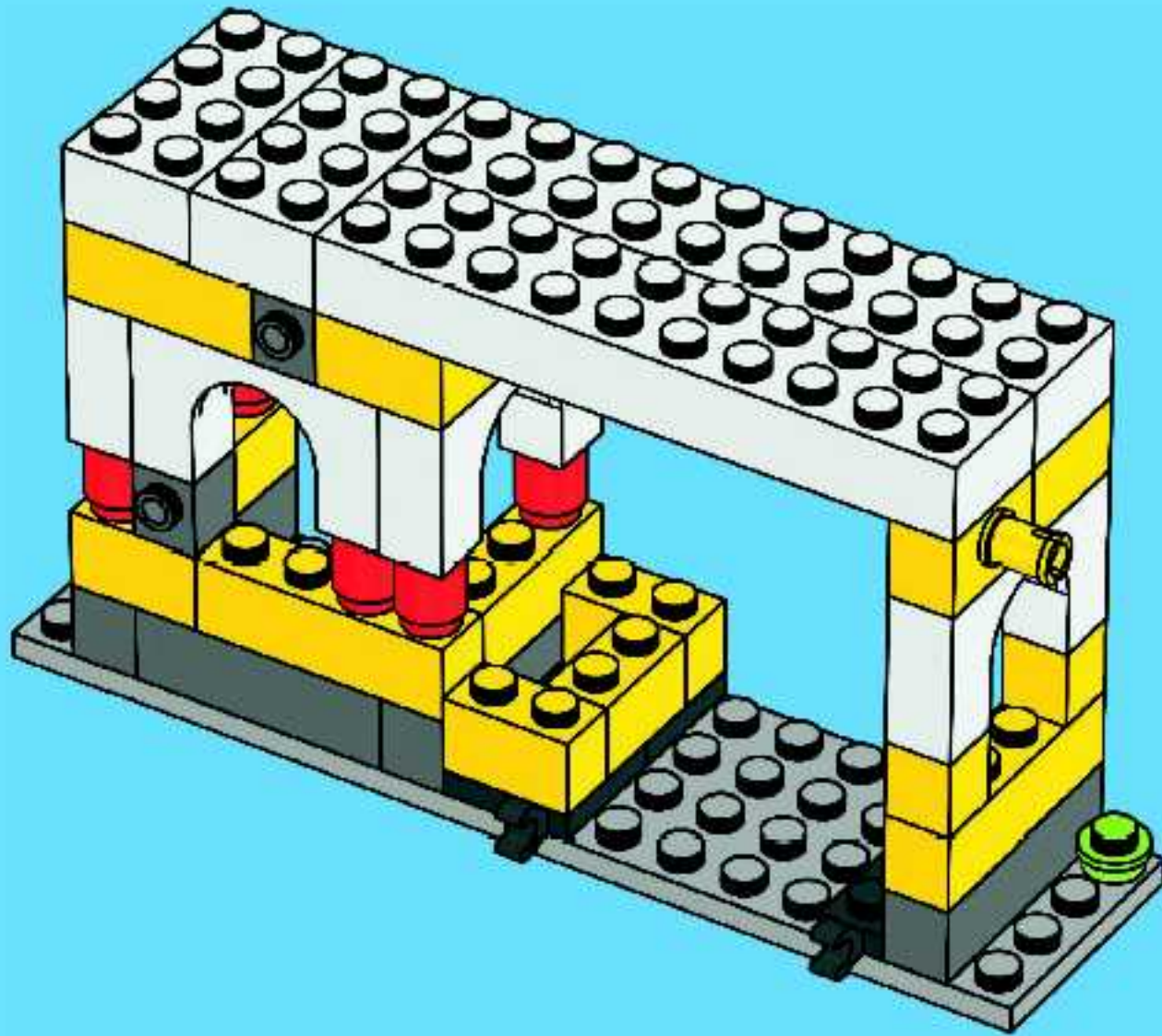

12

12

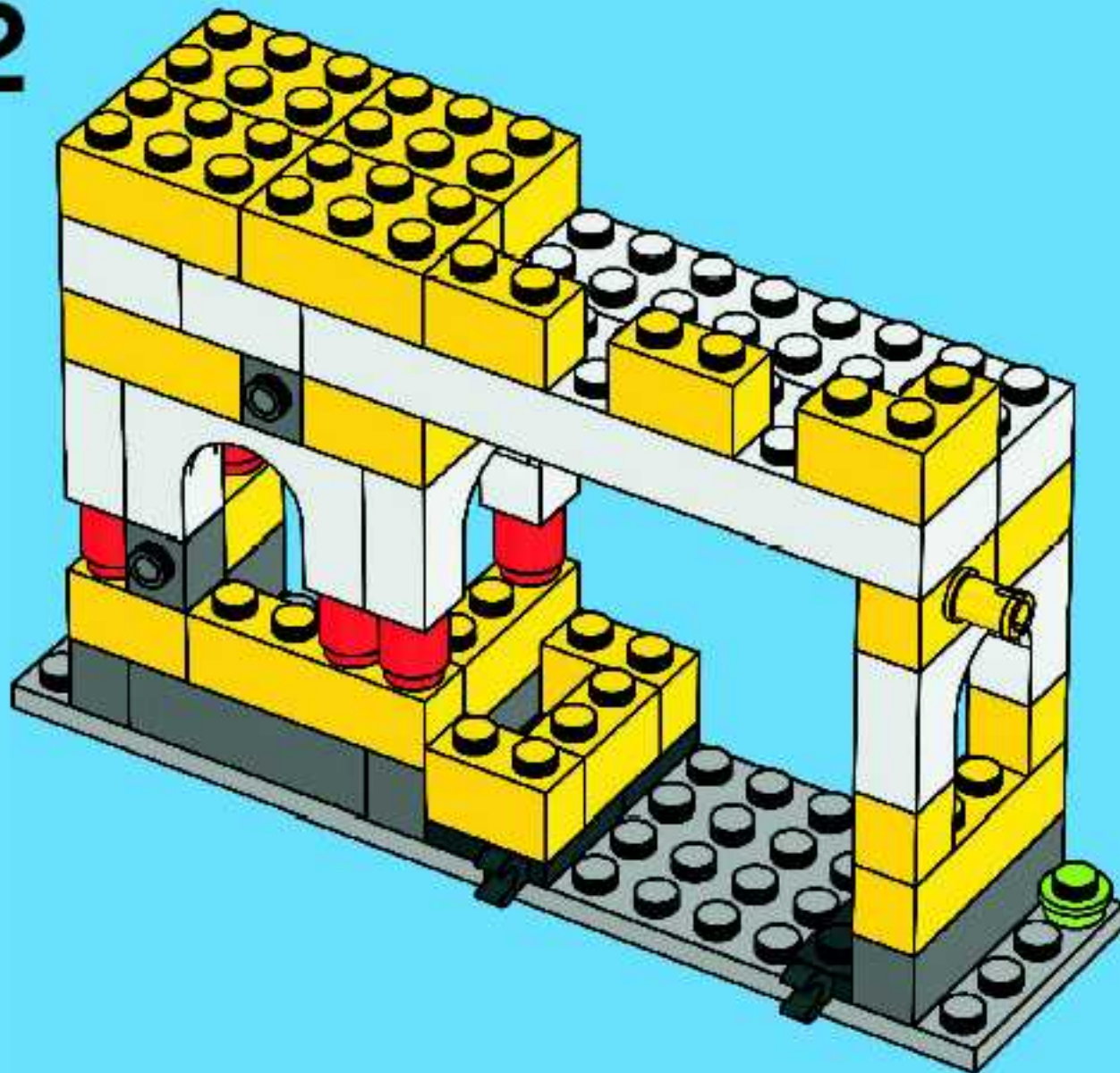

13

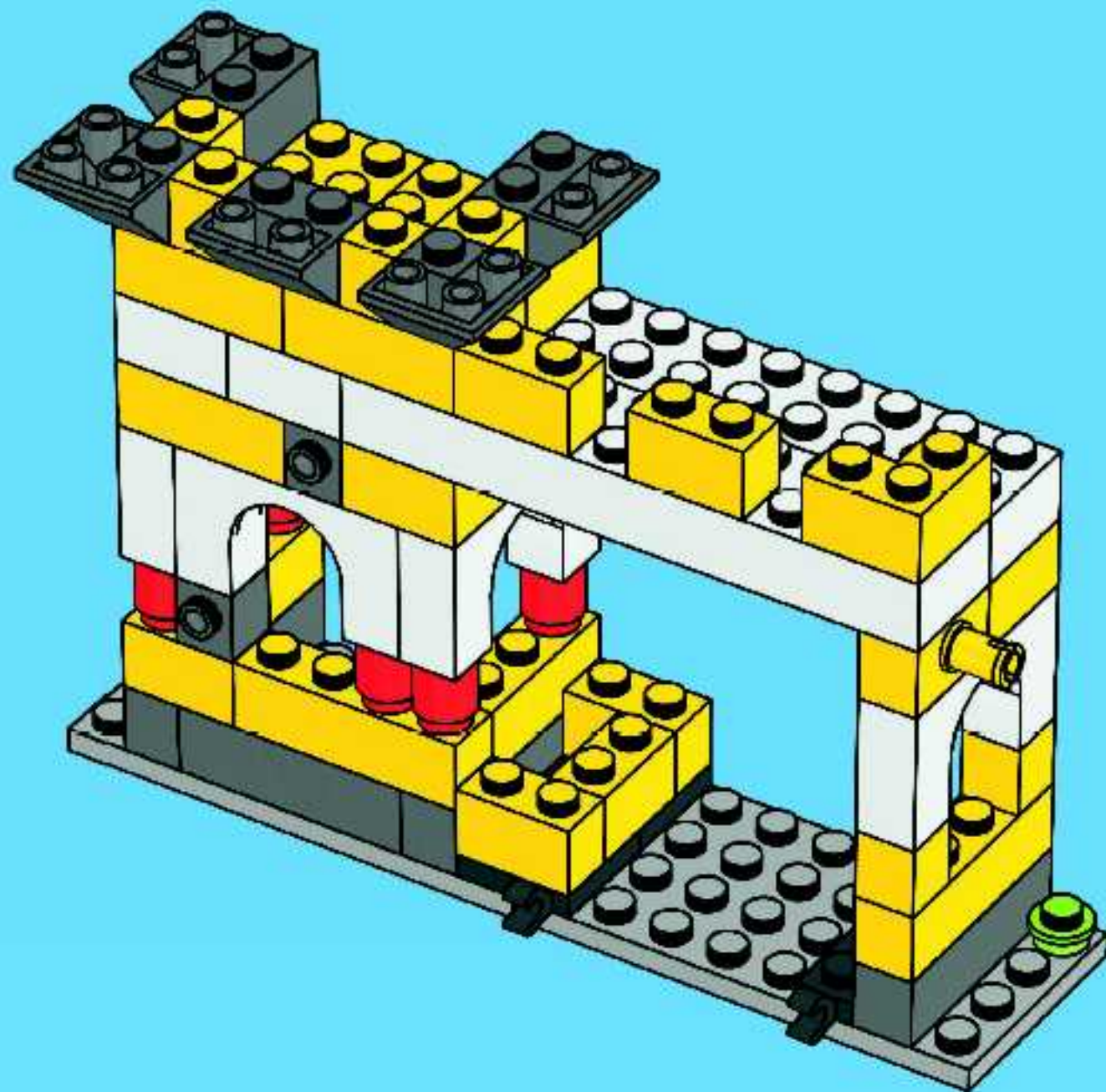

14

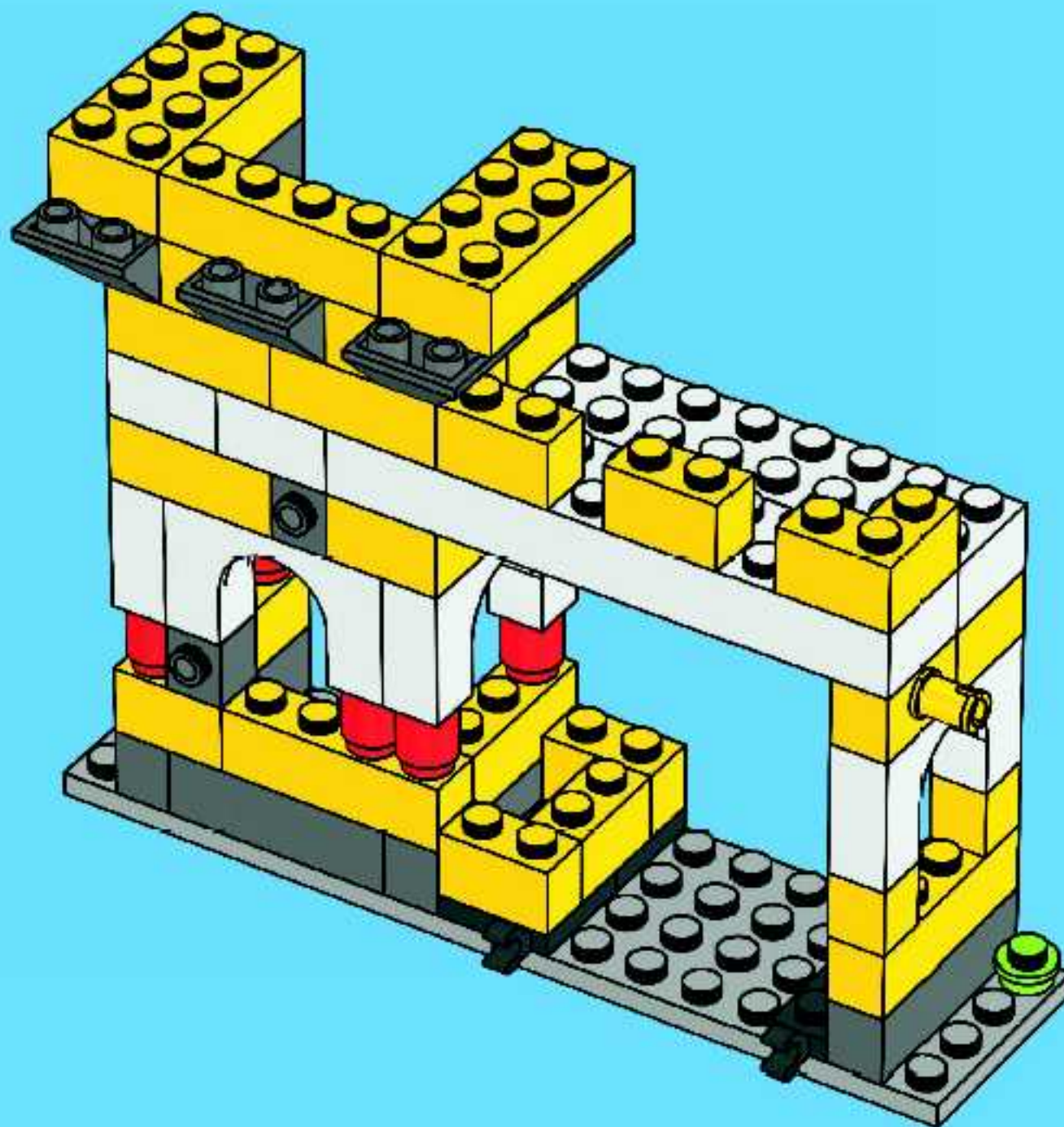

15

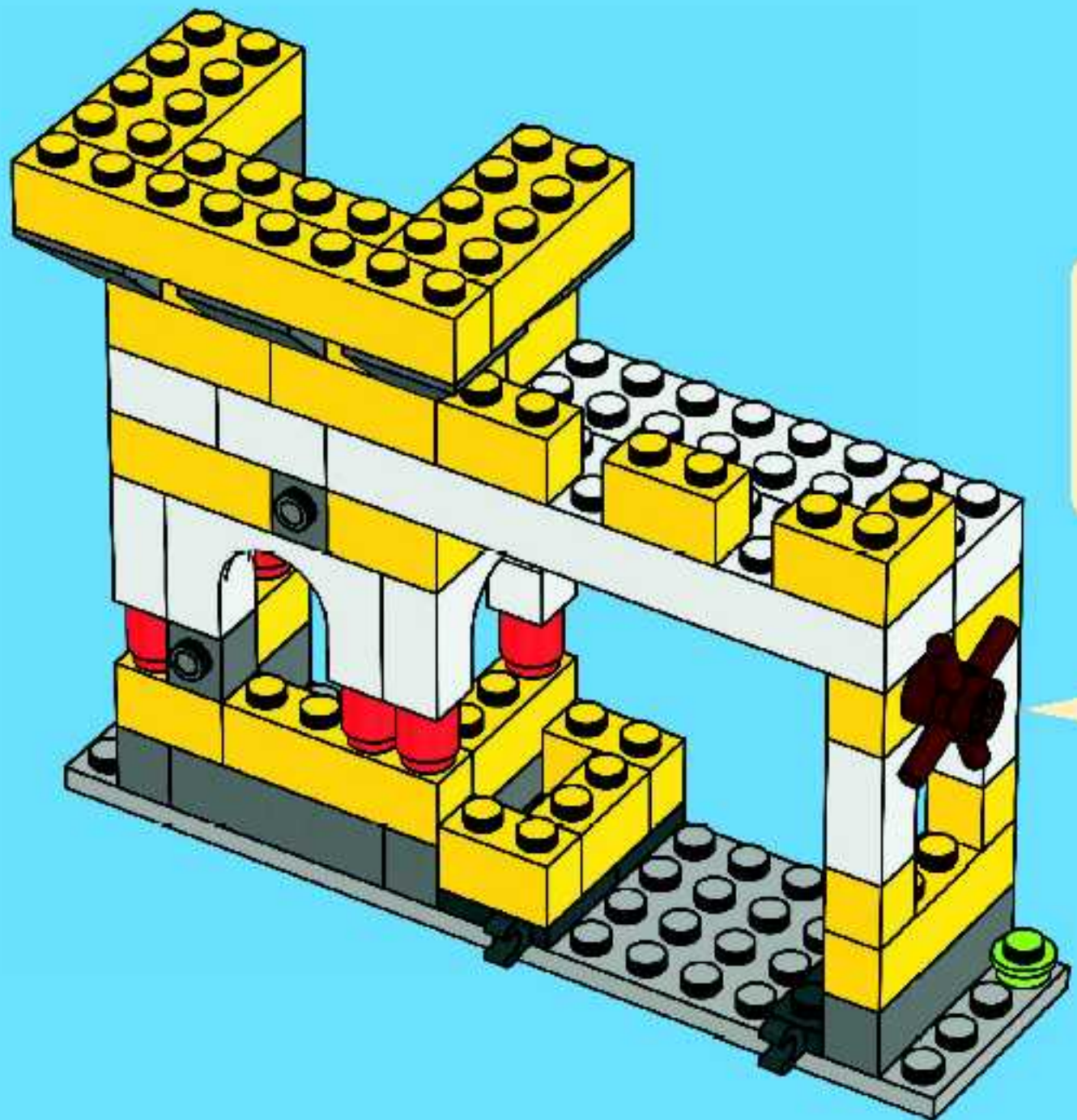

16



16

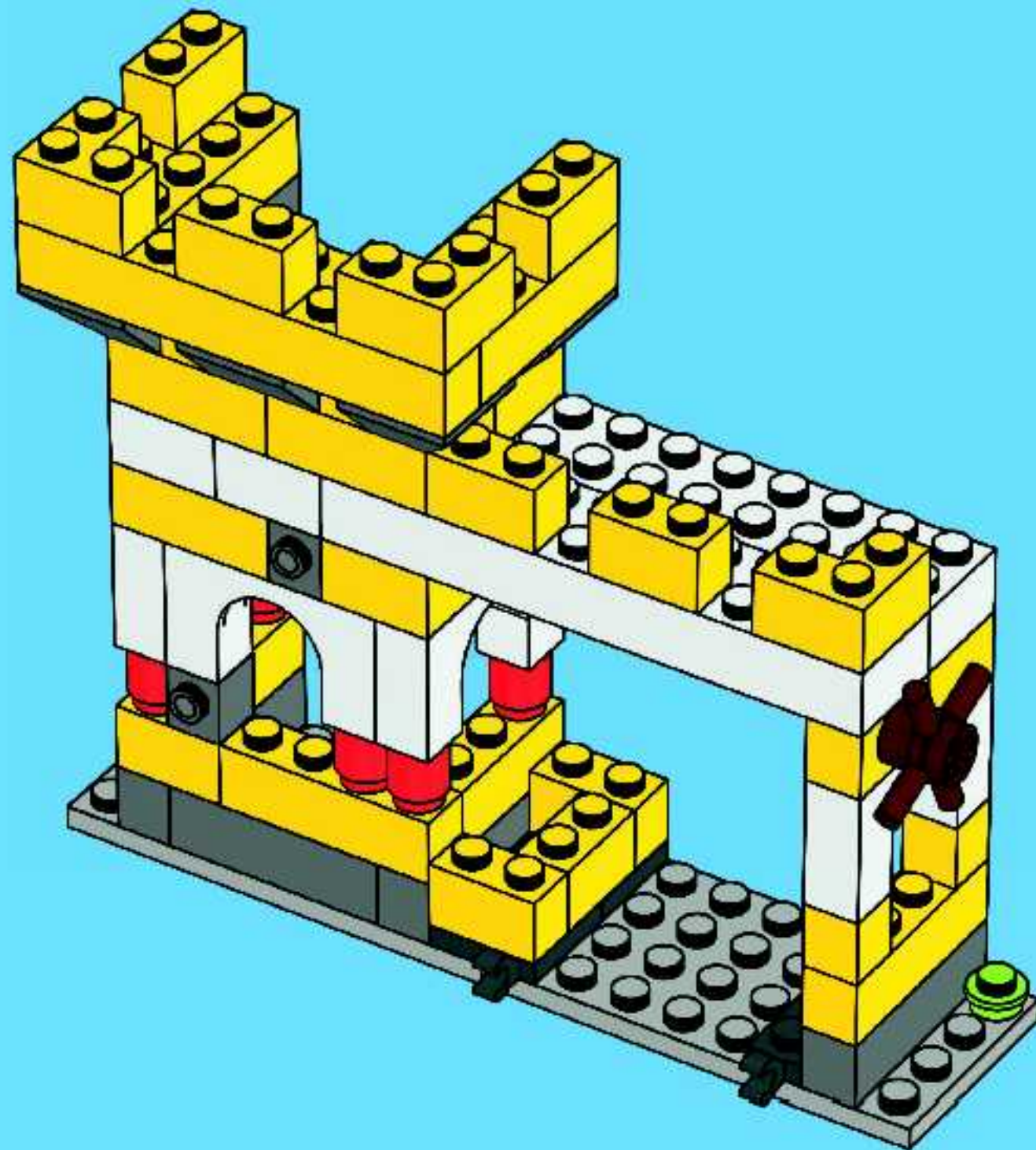



1



2

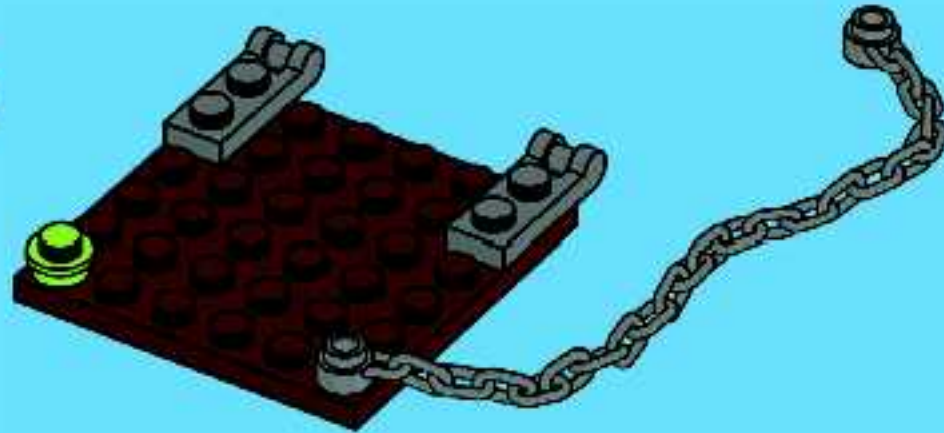

3

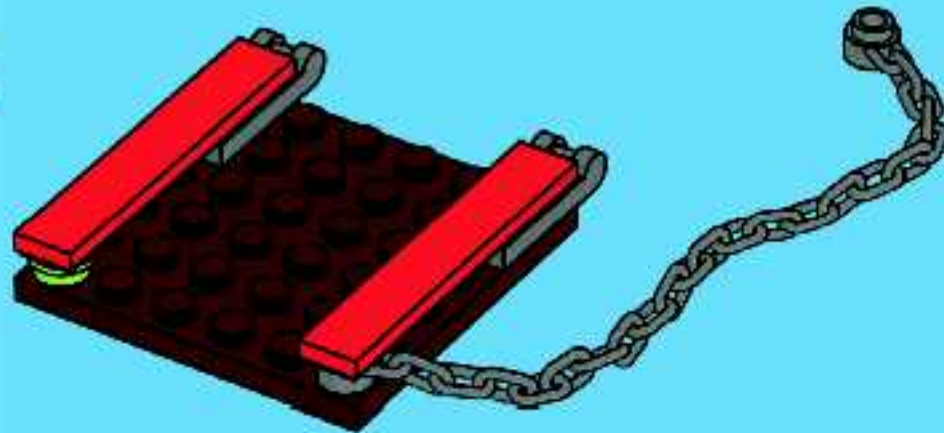

17

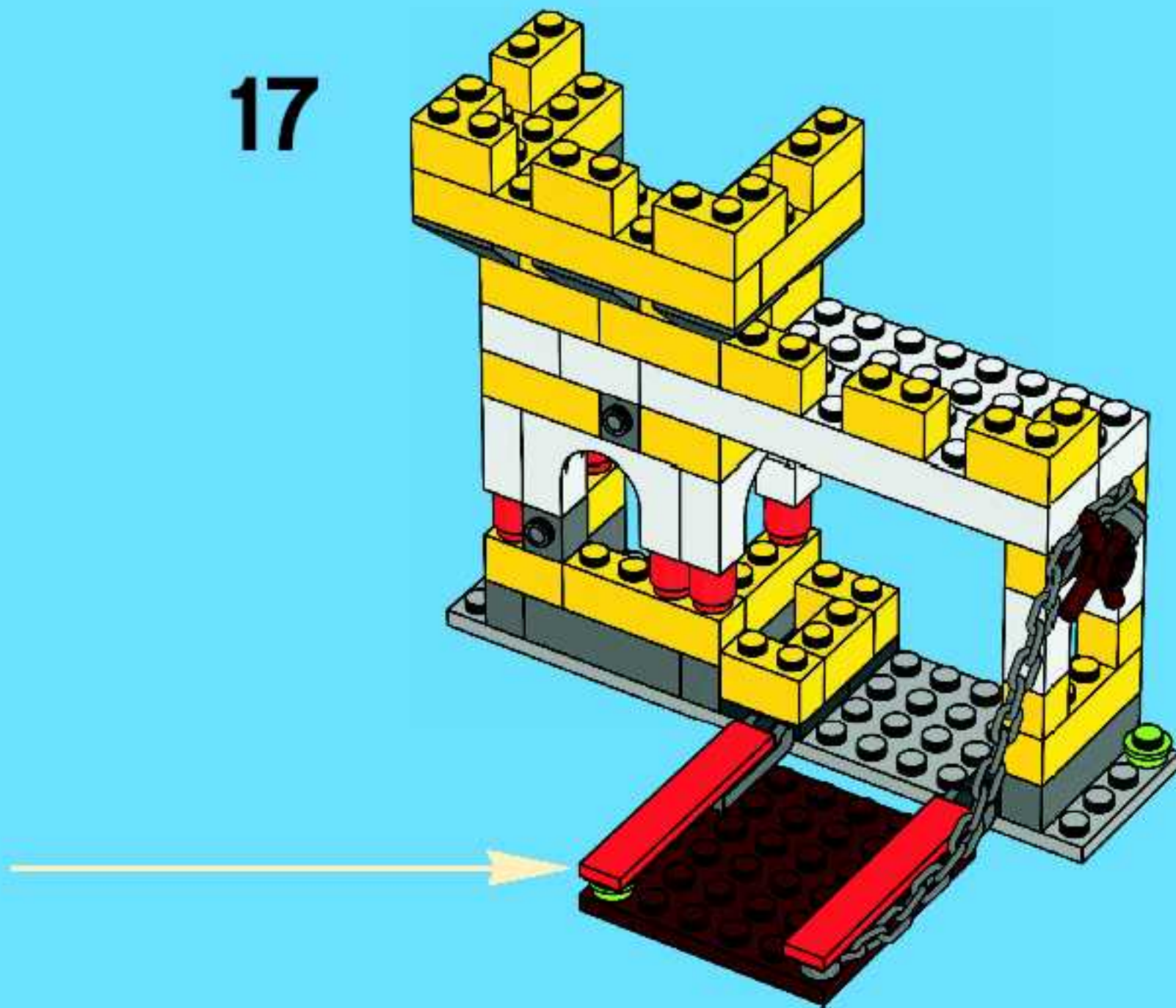

18

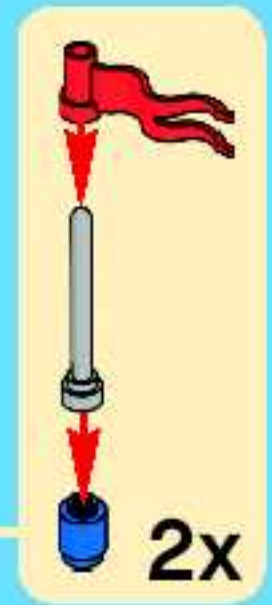
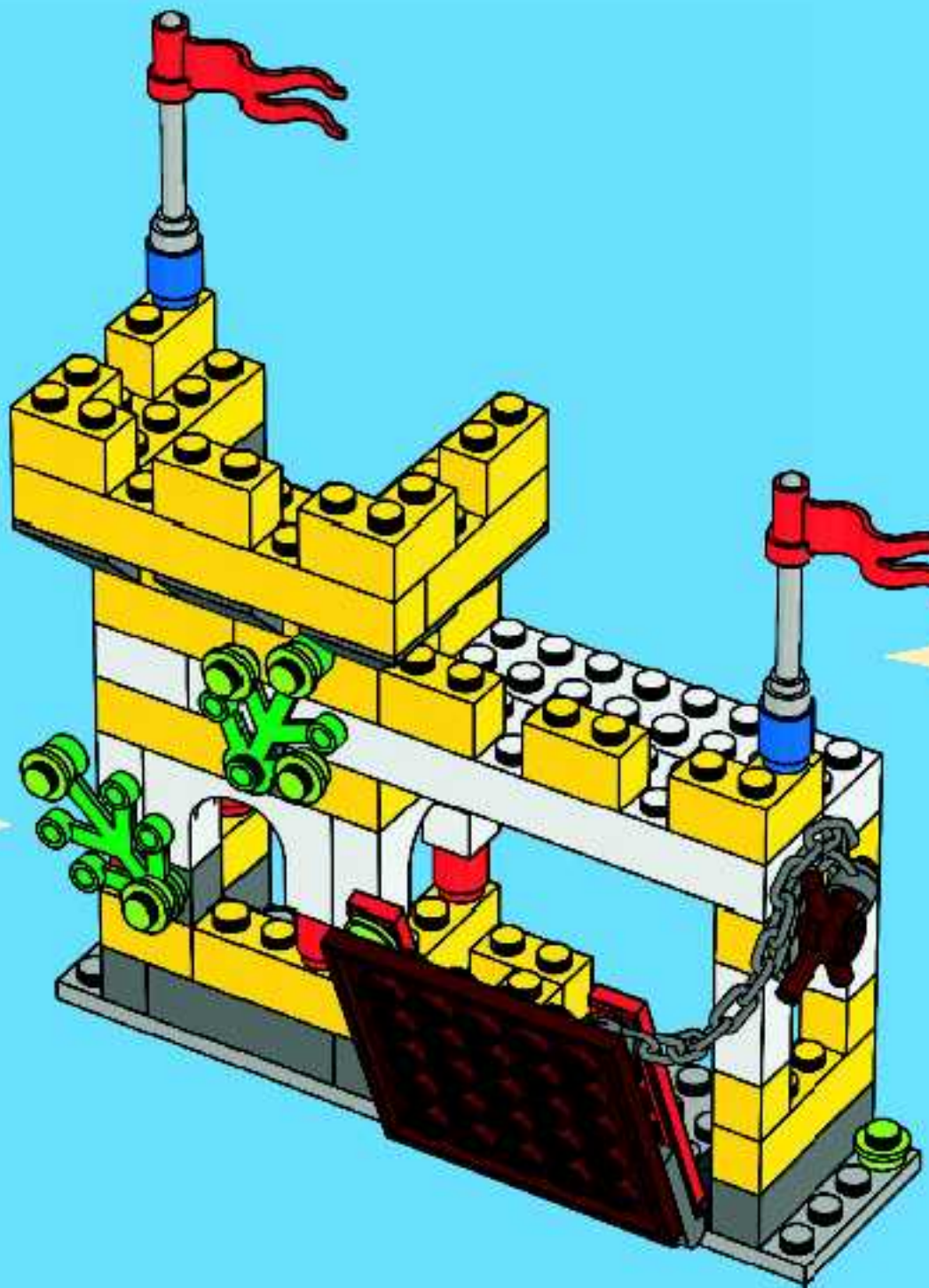
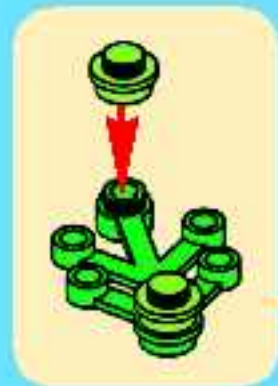





4x  
618201



2x  
4140002

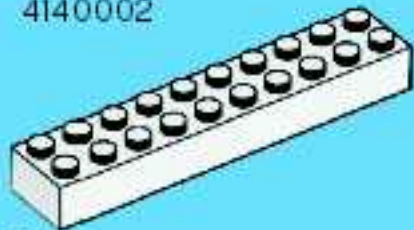

2x  
300601



2x  
300101



2x  
4161411



2x  
4504376

22



2x  
4211149



2x  
4211201



1x  
4252456



2x  
4211247



1x  
4217848



4x  
4211221



2x  
4113858



8x  
306221



2x  
449521



2x  
4190219



1x  
486521

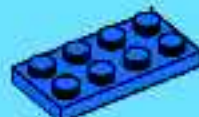

1x  
302023



4x  
306223



6x  
300524



11x  
300424



1x  
245824



2x  
362224

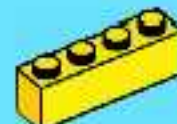

3x  
301024

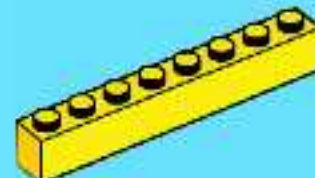

1x  
300824



1x  
300324



5x  
300224

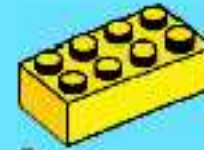

2x  
300124



4x  
235724



1x  
4186392



1x  
300426



1x  
302326



2x  
4535739



1x  
4222693



1x  
4544164



2x  
4521187



4x  
4211000



2x  
4210862



1x  
4505002



1x  
4506011



1x  
329826



1x  
281726



2x  
302226



2x  
242328



1x  
302228



4x  
303928



2x  
4142717



1x  
4164022



2x  
4211364



2x  
4211473



2x  
4213574

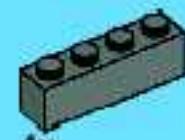

4x  
4211103



2x  
303926



8x  
4183133



1x  
4516456

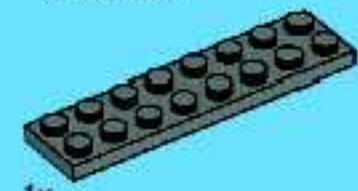

1x  
4210997



2x  
4211407



Customer Service

Kundenservice

Service Consommateurs

Servicio Al Consumidor

[www.lego.com/service](http://www.lego.com/service) or dial



Switzerland, Finland, Sweden, Austria, United Kingdom : 00800 5346 5555

USA, Canada : 1-800-422-5346

[www.nielsen.com/LEGO](http://www.nielsen.com/LEGO)



## WIN LEGO® PRODUCTS

Fill out a survey and you might WIN a cool LEGO product!  
NO PURCHASE NECESSARY

Open to all residents where not prohibited  
Go to [www.acnielsen.aim.dk/LEGO](http://www.acnielsen.aim.dk/LEGO) to fill out a survey for a chance to win a LEGO product.

## WIN LEGO® PRODUCTEN

Vul een enquêteformulier in en maak kans op een cool LEGO® product!

Kopen niet nodig  
Iedereen uit landen waar geen enquêteverbod geldt mag deelnemen.  
Ga naar [www.acnielsen.aim.dk/LEGO](http://www.acnielsen.aim.dk/LEGO), vul een enquêteformulier in en maak kans op een LEGO product.

## GEWINNE LEGO® PRODUKTE

Nimm an der Umfrage teil und GEWINNE ein tolles LEGO® Produkt!  
Die Teilnahme am Gewinnspiel führt zu keinerlei Kaufverpflichtungen  
Teilnahme in allen nicht ausgeschlossenen Ländern möglich  
Wir verlosen unter allen Teilnehmern der Umfrage auf [www.acnielsen.aim.dk/LEGO](http://www.acnielsen.aim.dk/LEGO) LEGO Produkte.

## GAGNE DES PRODUITS LEGO®

Réponds à un questionnaire et tu pourrais GAGNER un produit LEGO® très cool !

Aucune obligation d'achat

Ouvert à tous les résidents des pays autorisés.

Visite [www.acnielsen.aim.dk/LEGO](http://www.acnielsen.aim.dk/LEGO) pour répondre à un questionnaire et avoir une chance de gagner un produit LEGO.

## レゴ®製品を「当てよう」

アンケートに記入して、カッコいいレゴ®製品を当てよう！

お買い上げの必要はありません。

禁止されていない限り、すべての管轄にご利用いただけます。

[www.acnielsen.aim.dk/LEGO](http://www.acnielsen.aim.dk/LEGO)にアクセスして、アンケートにご記入ください。当選者にはレゴ製品を差し上げます。



©2009 The LEGO Group. 4547841