



# CITY

60418



2

3

4

5

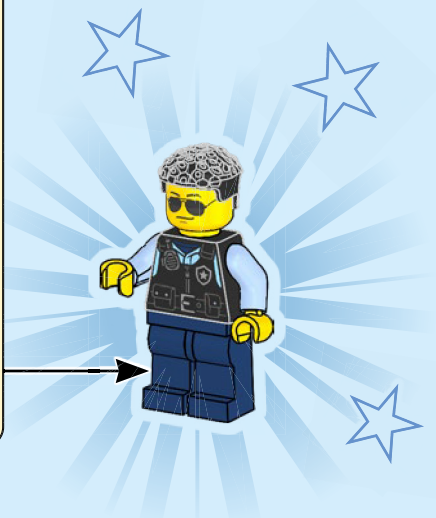
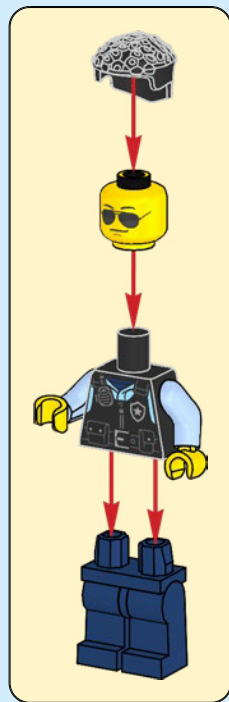

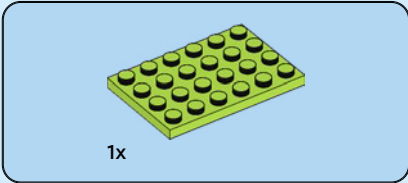
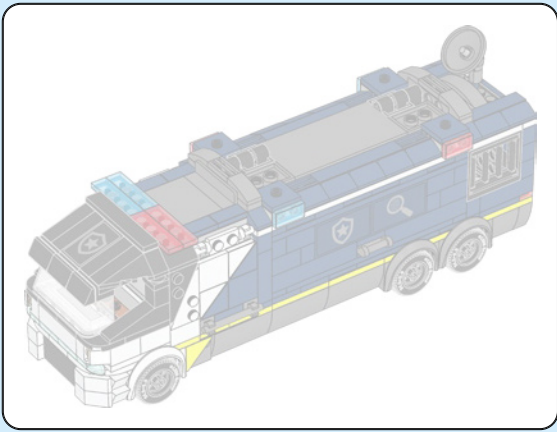

1

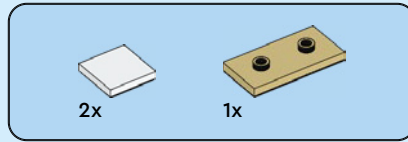
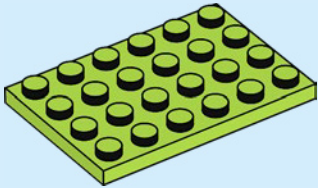

2

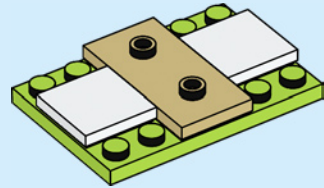

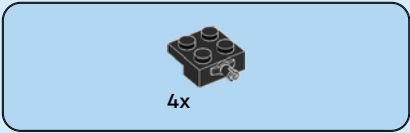

3

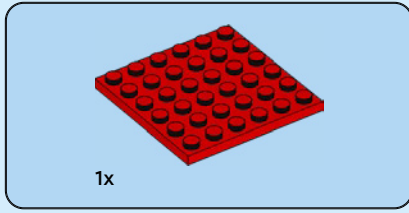
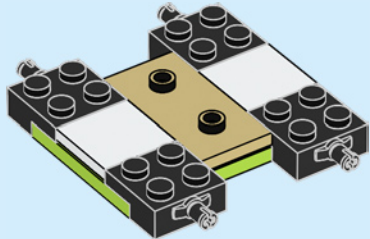

4

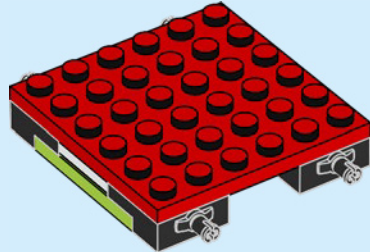

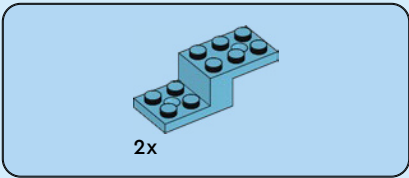

5

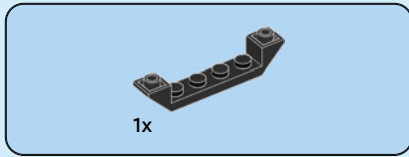
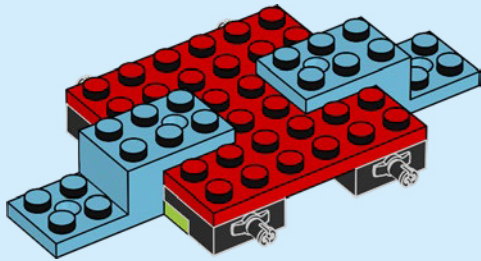

6

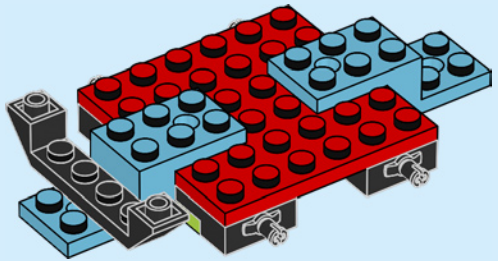

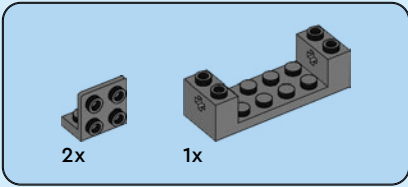

7

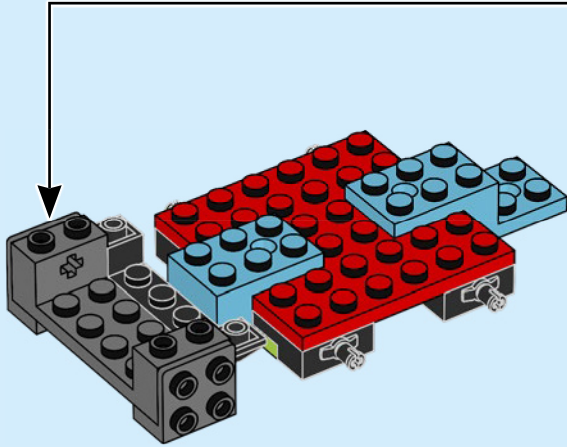
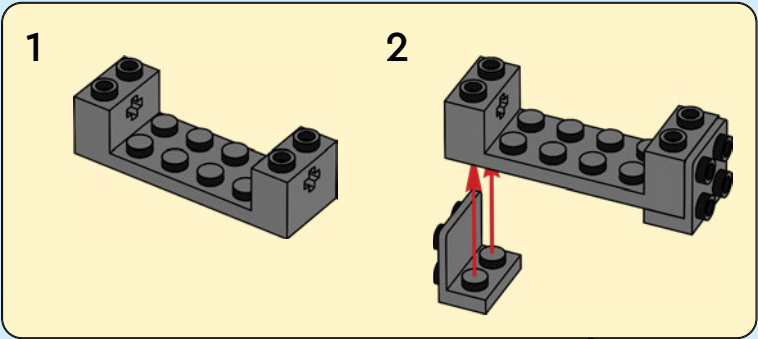

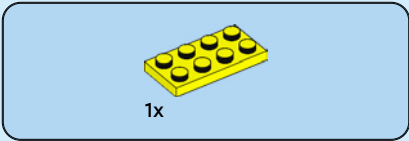

8

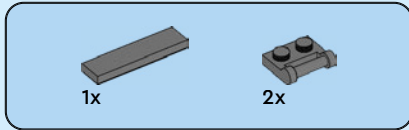
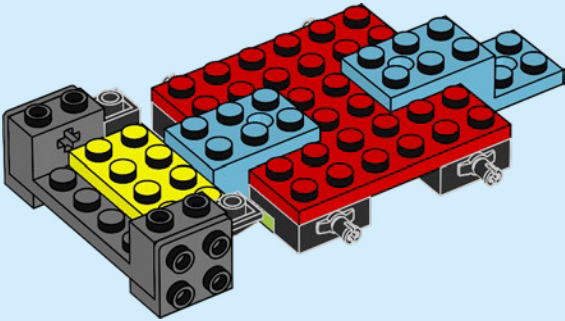

9

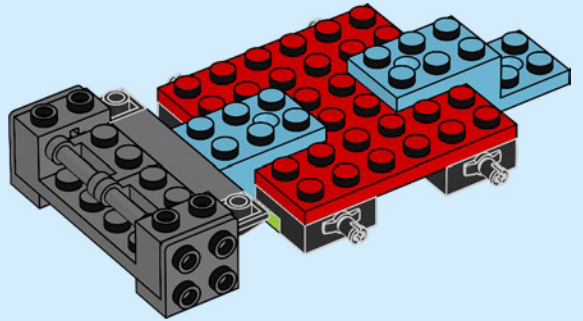







2x



2x

# 12

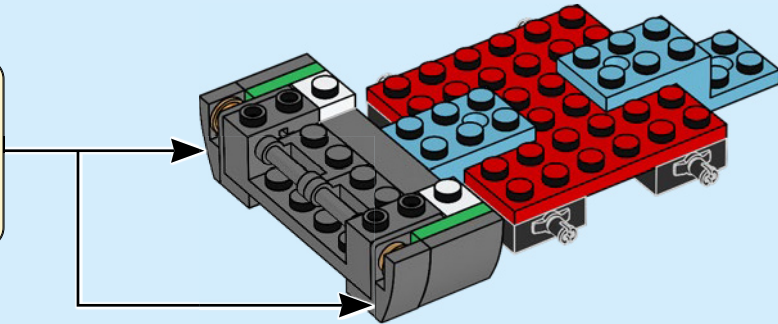
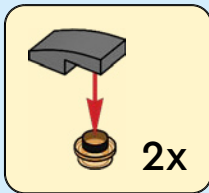

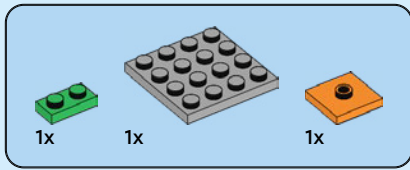

13

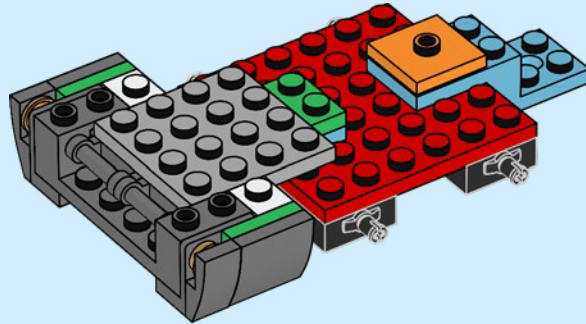

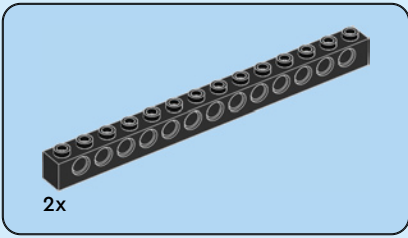

14

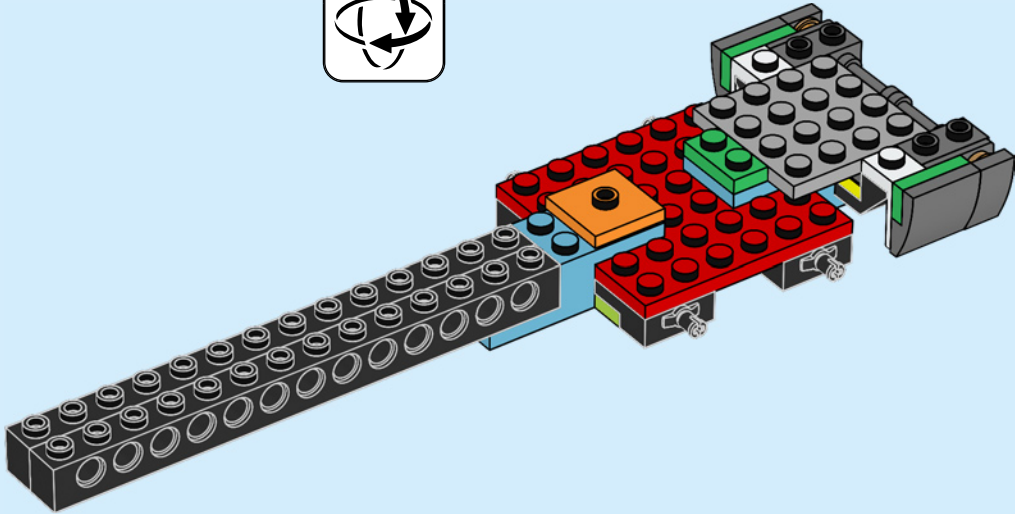

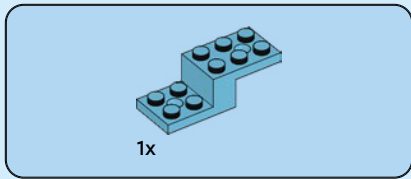

15

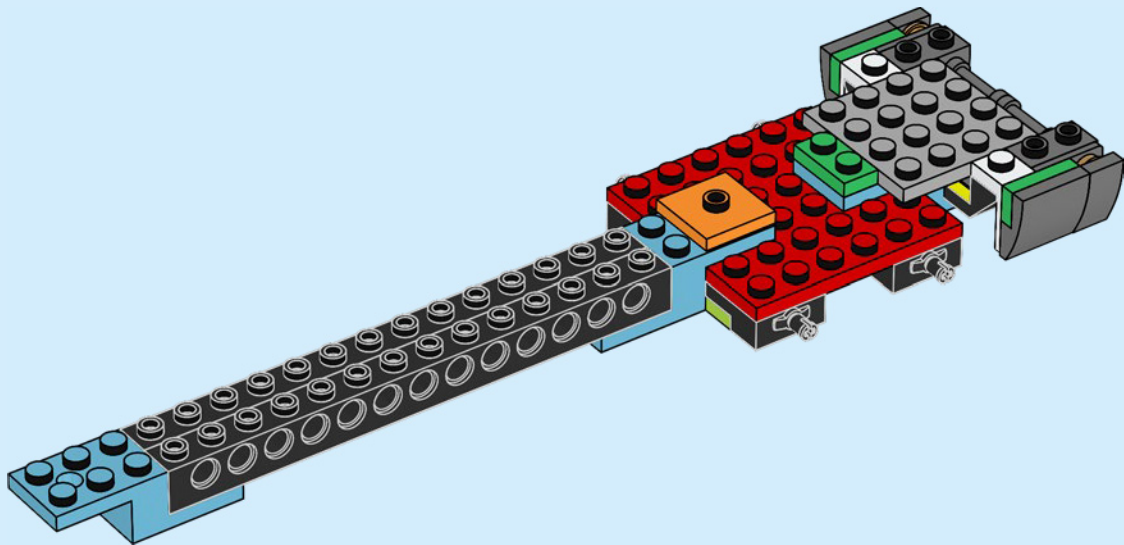

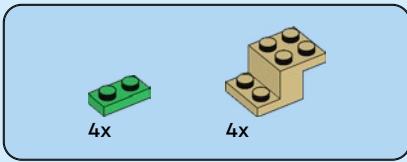

16

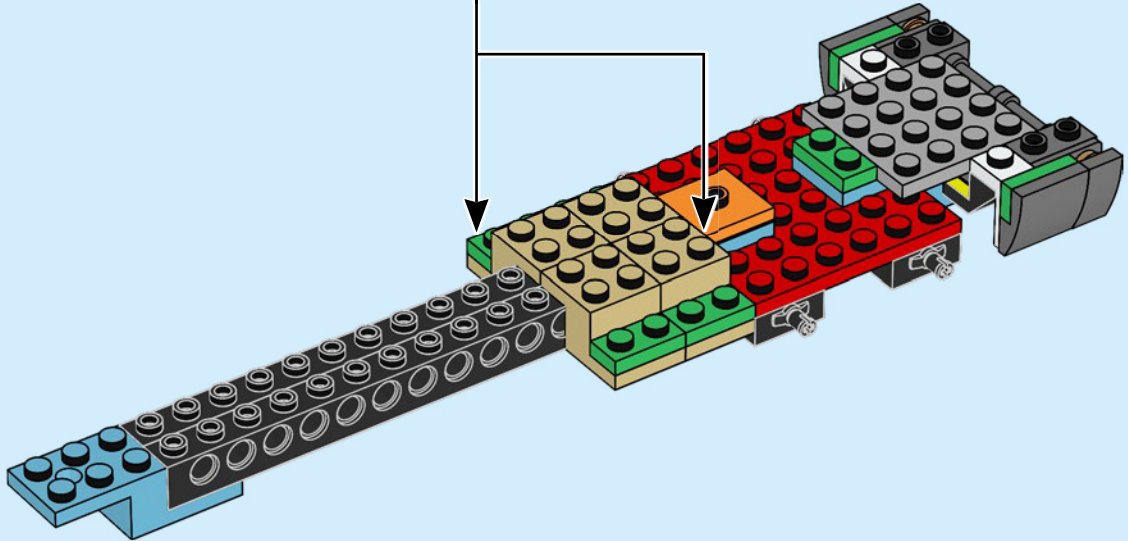
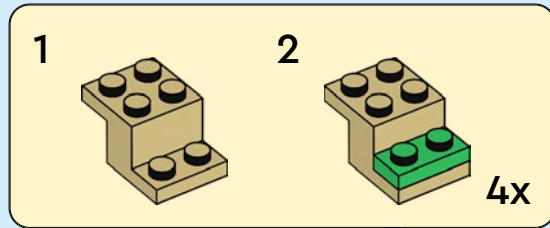

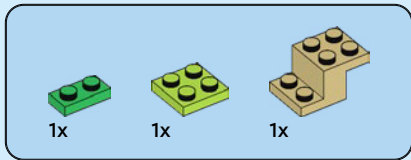

17

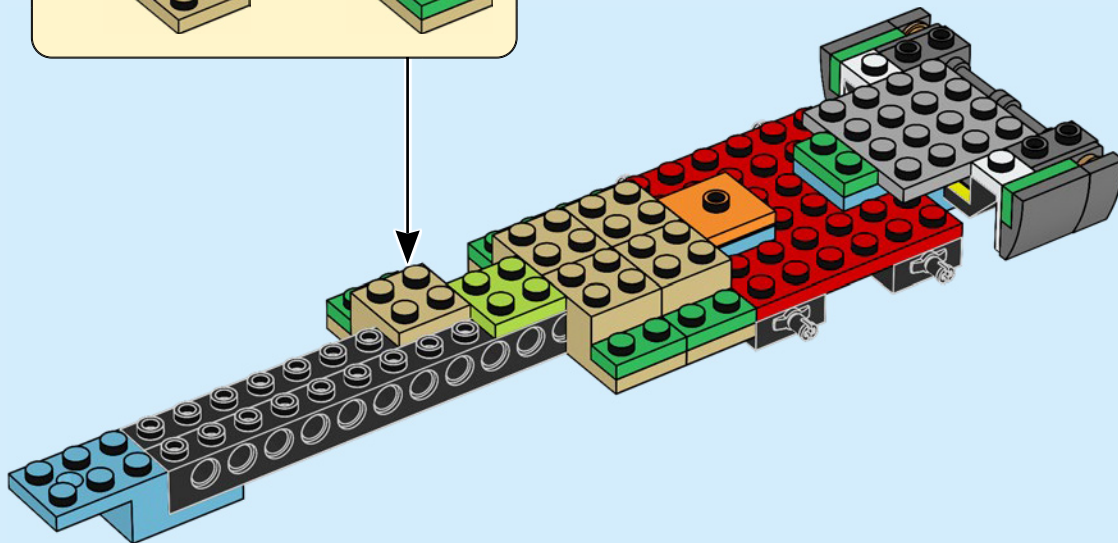
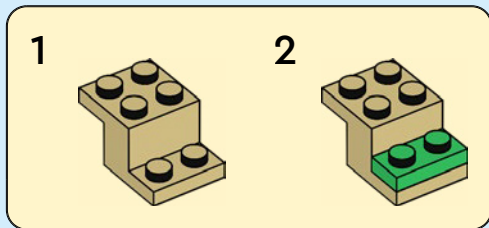

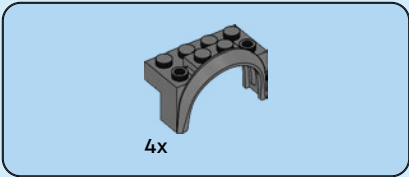

18

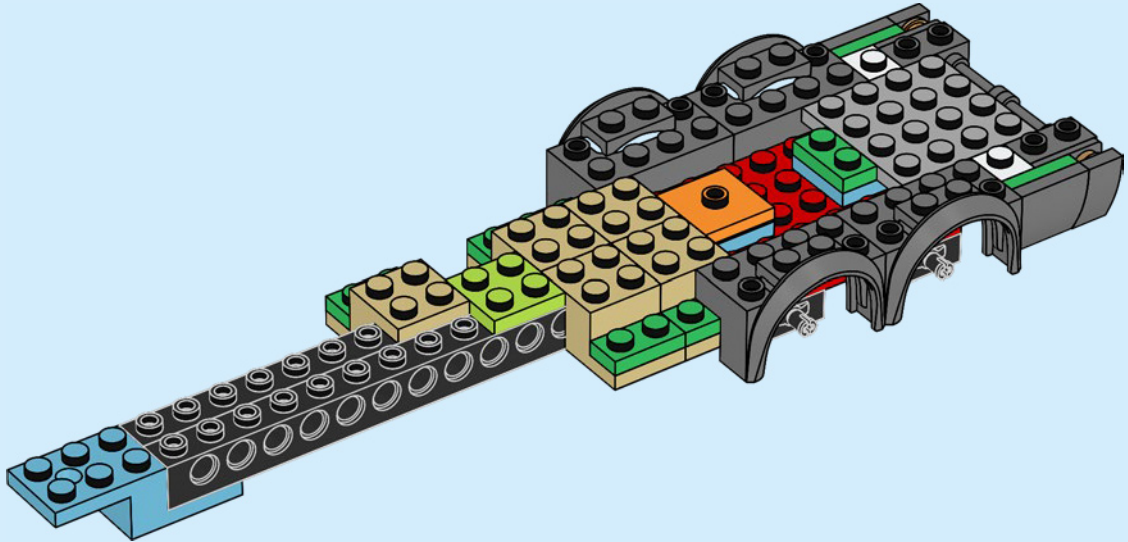

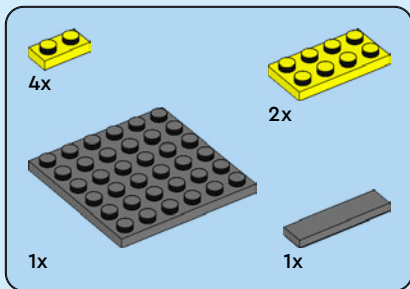

19

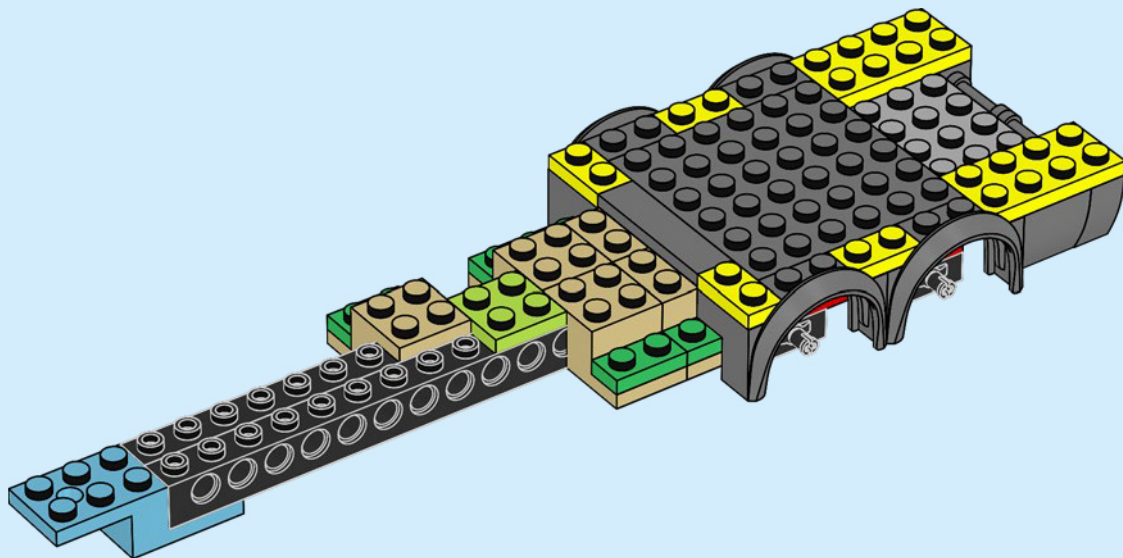



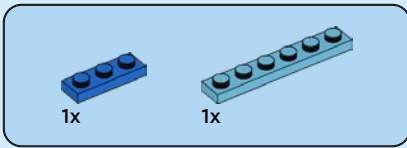

20

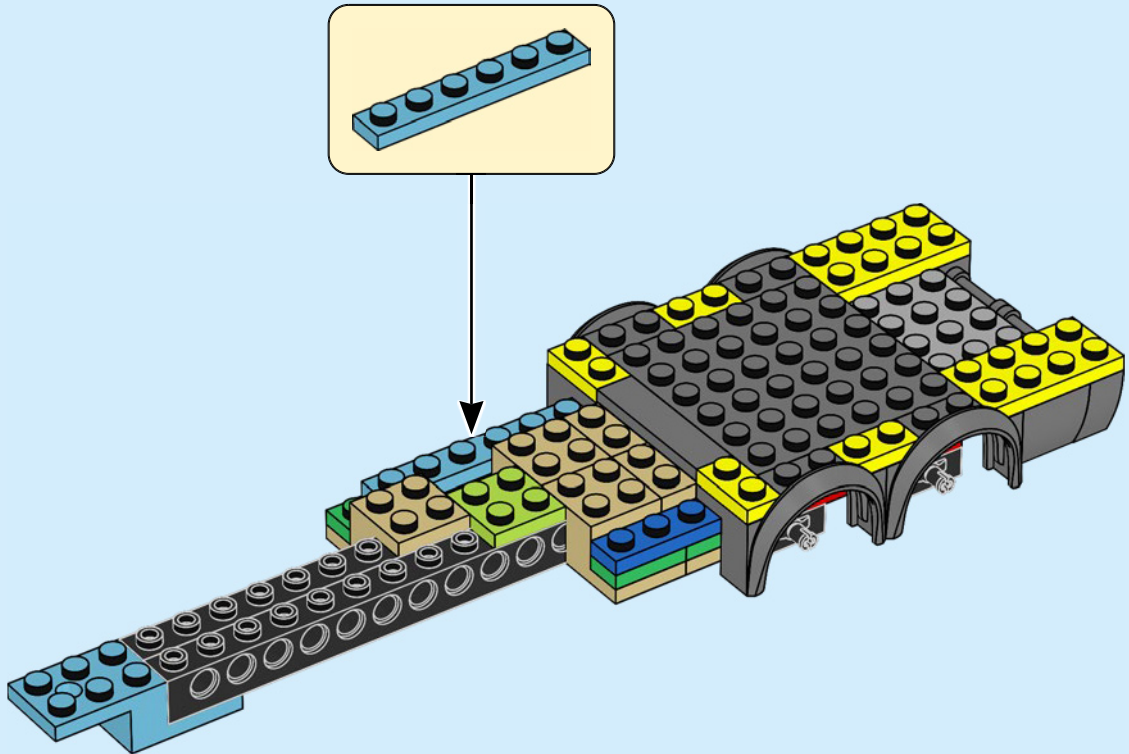

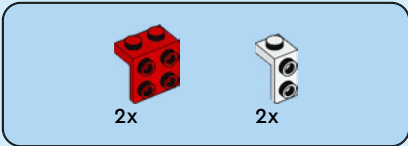

21

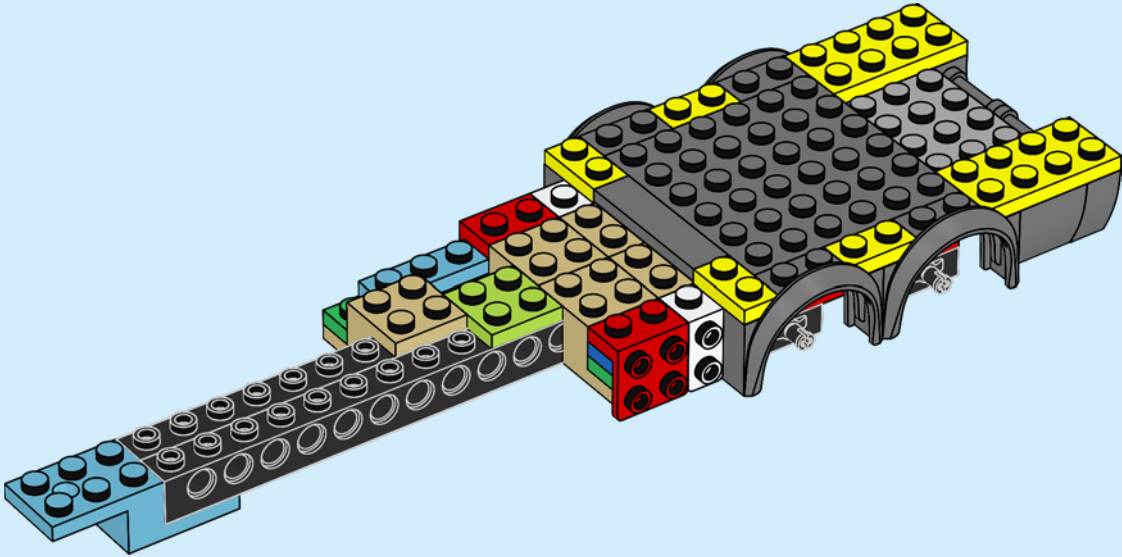

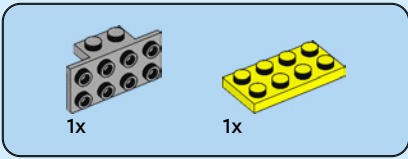

22

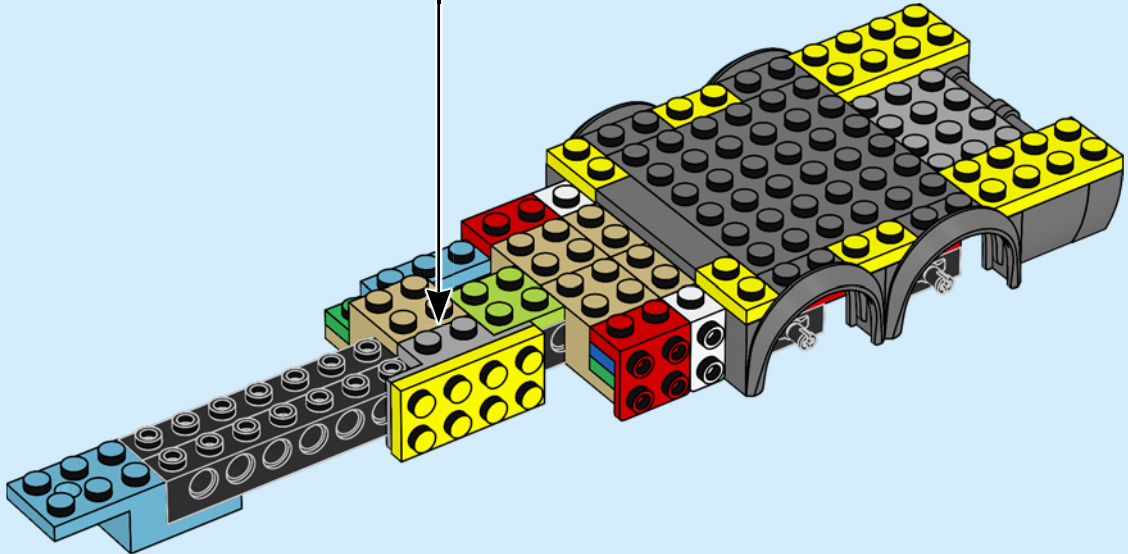
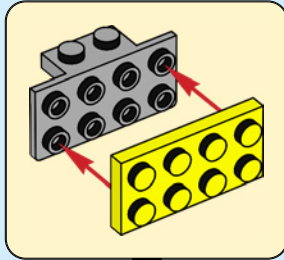



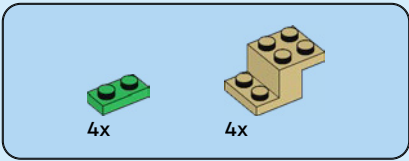

24

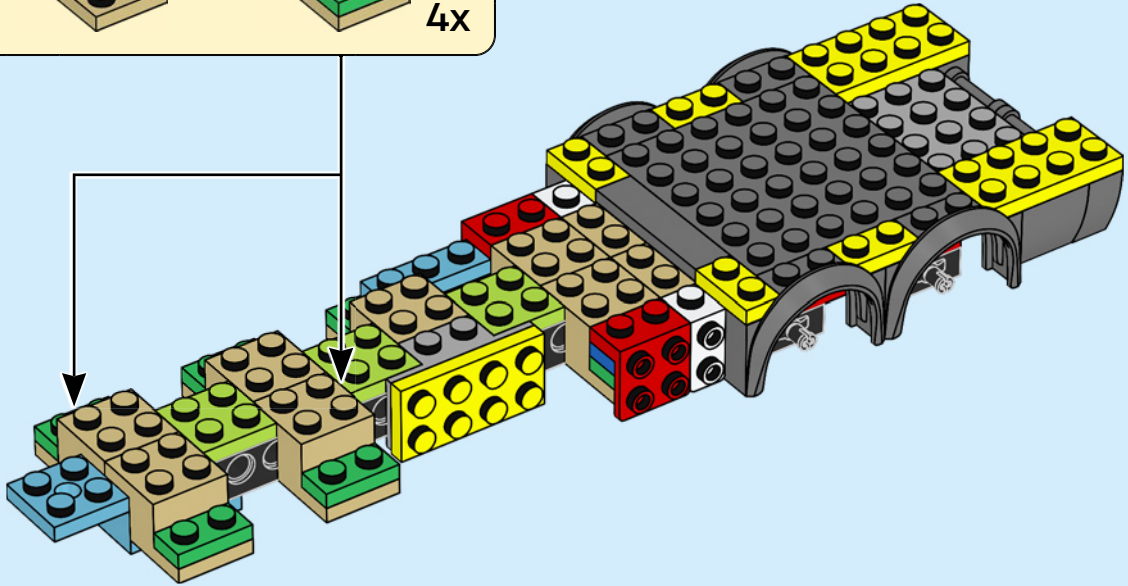
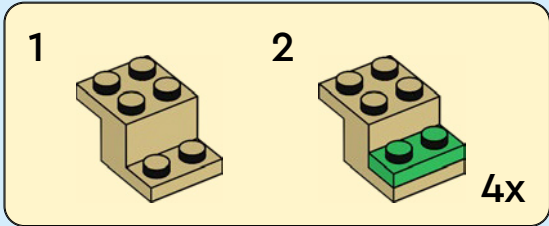





7x



2x

26

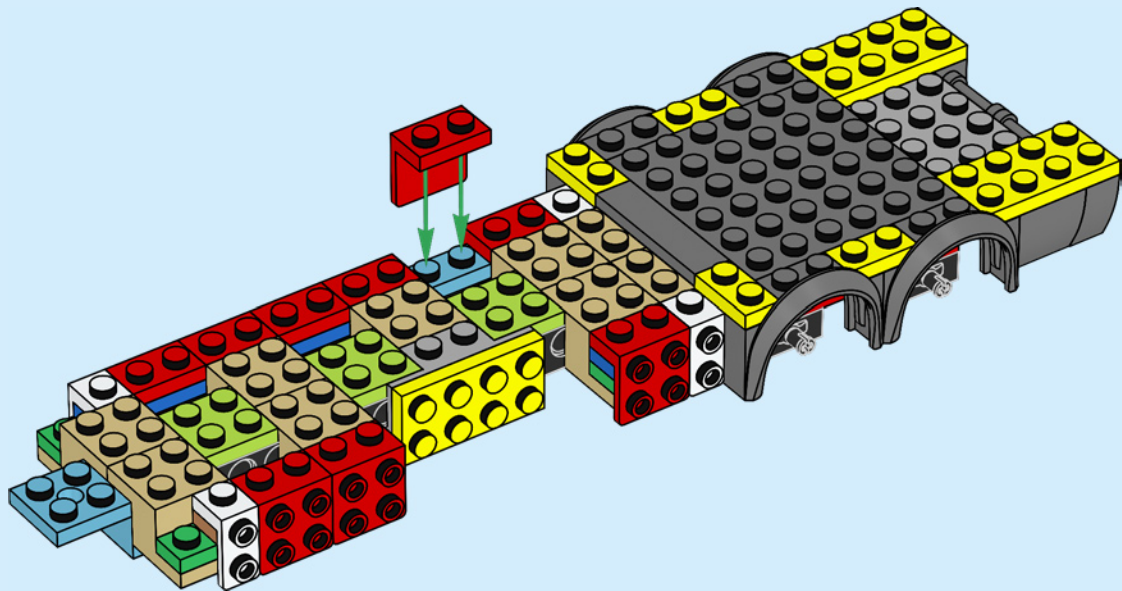

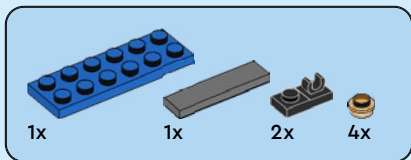

27

1

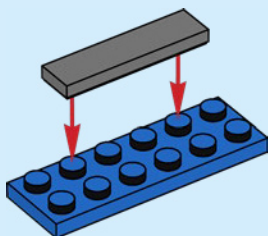

2

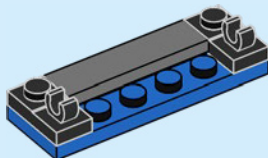

3

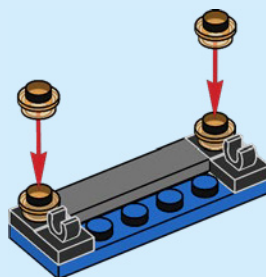



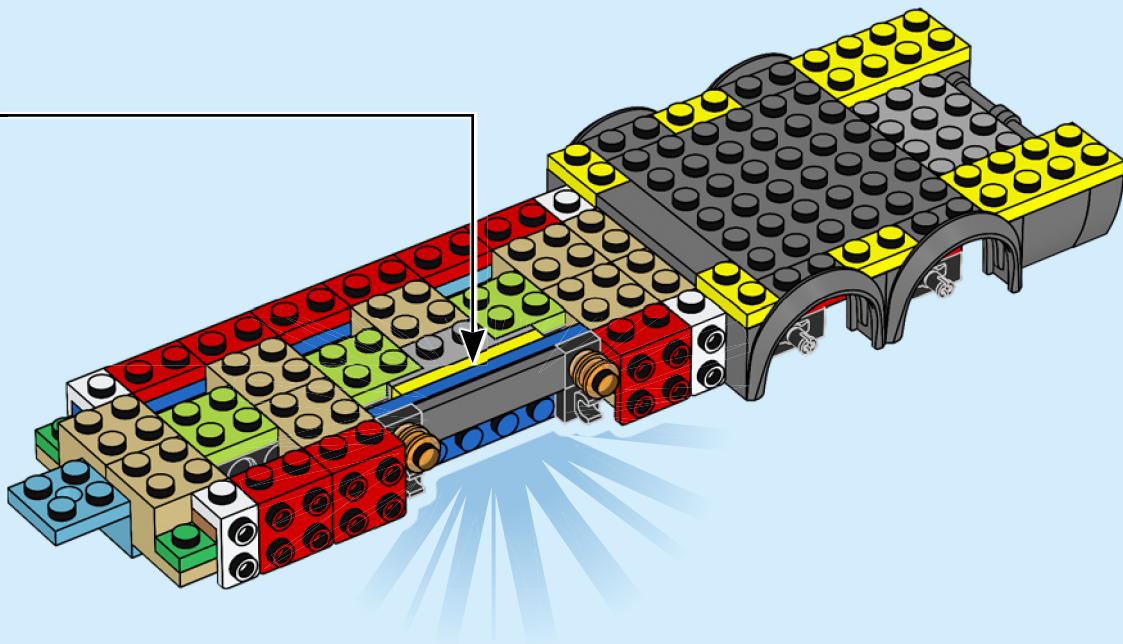

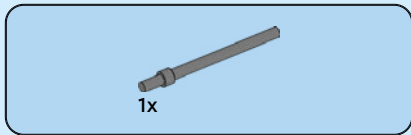

28

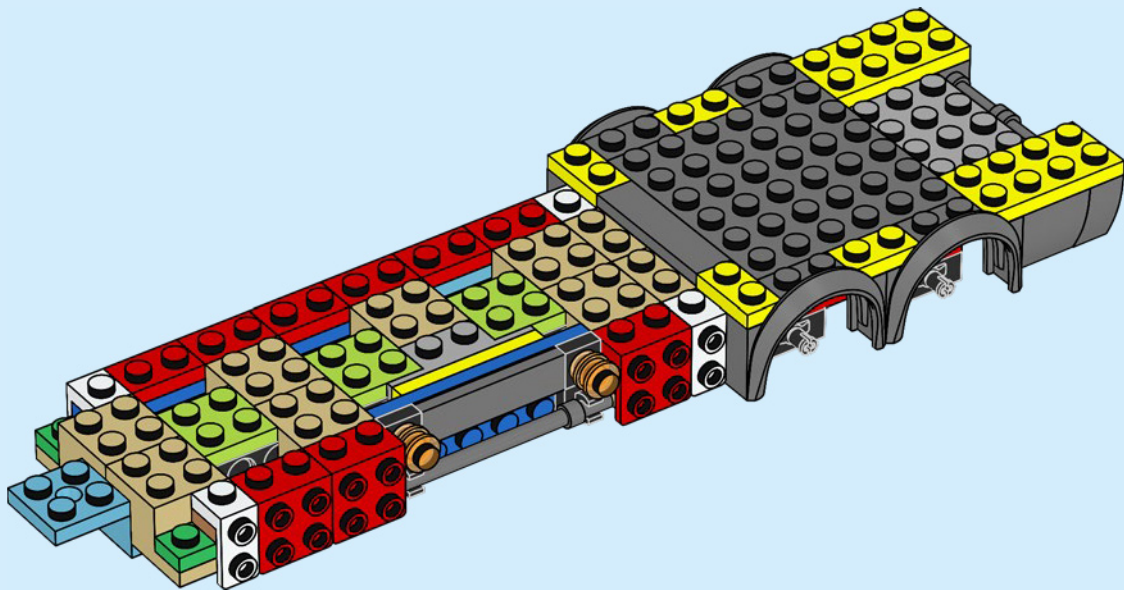

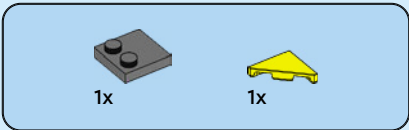

29

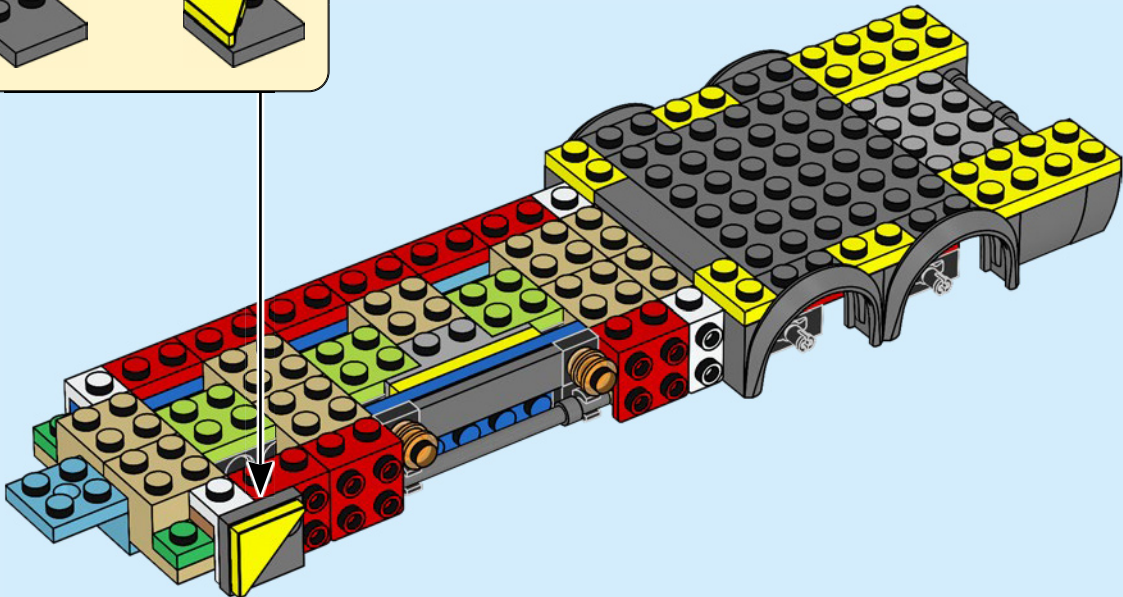
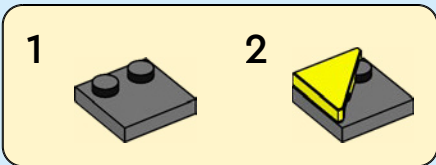

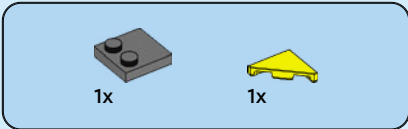

30

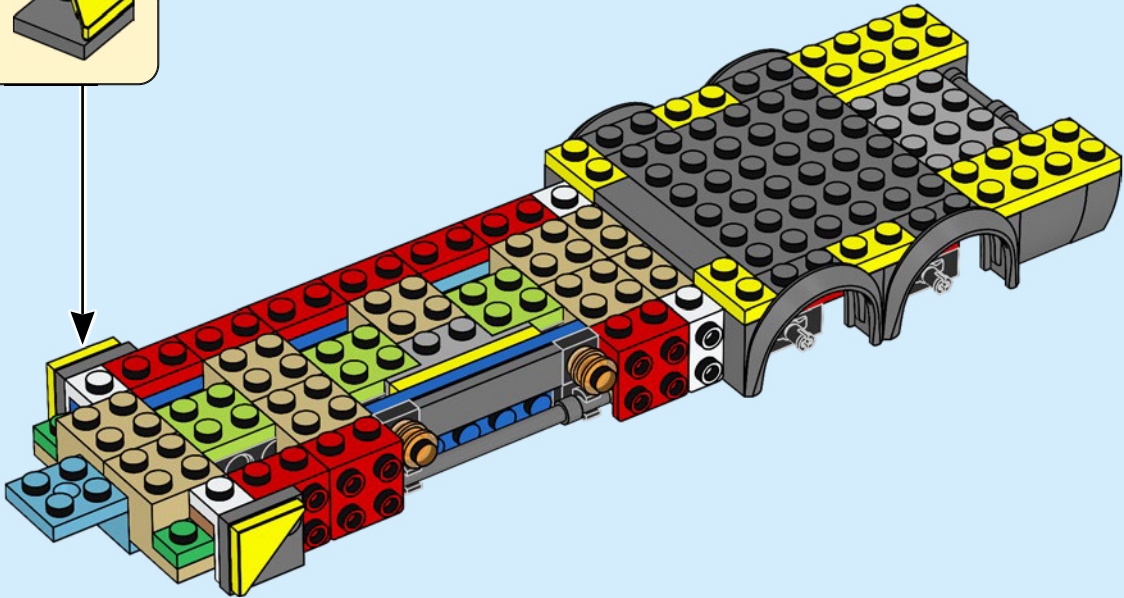
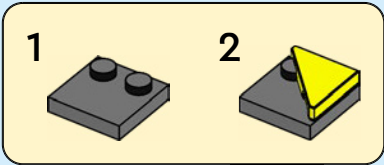

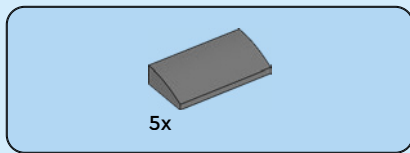

31

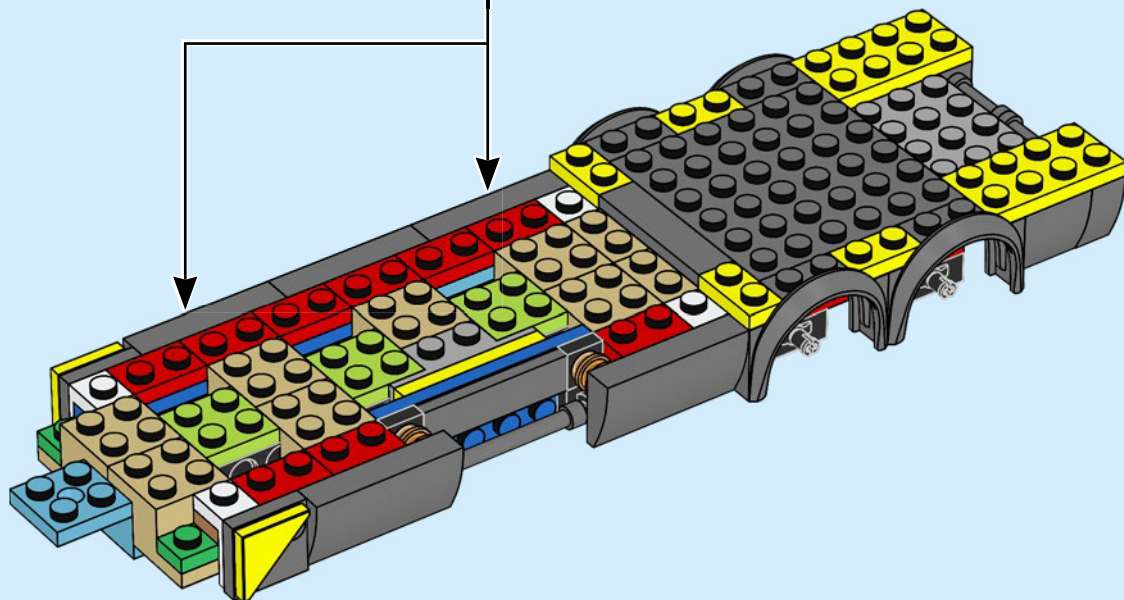
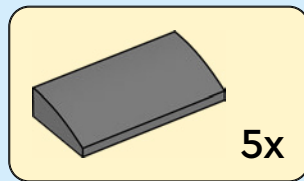

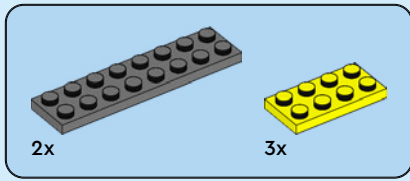

32

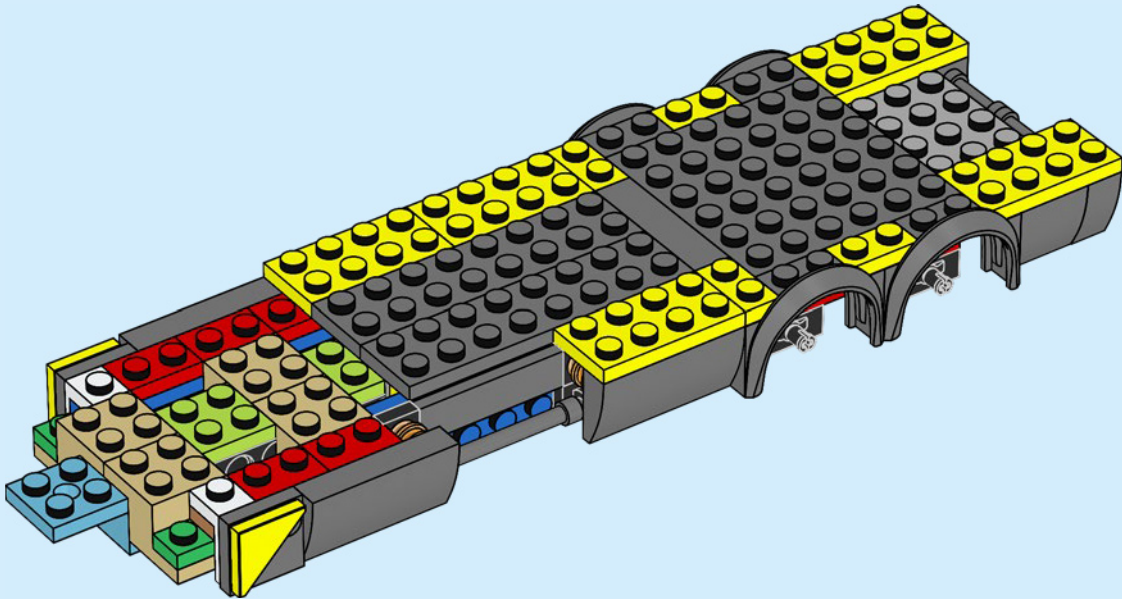

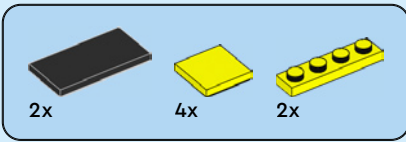

33

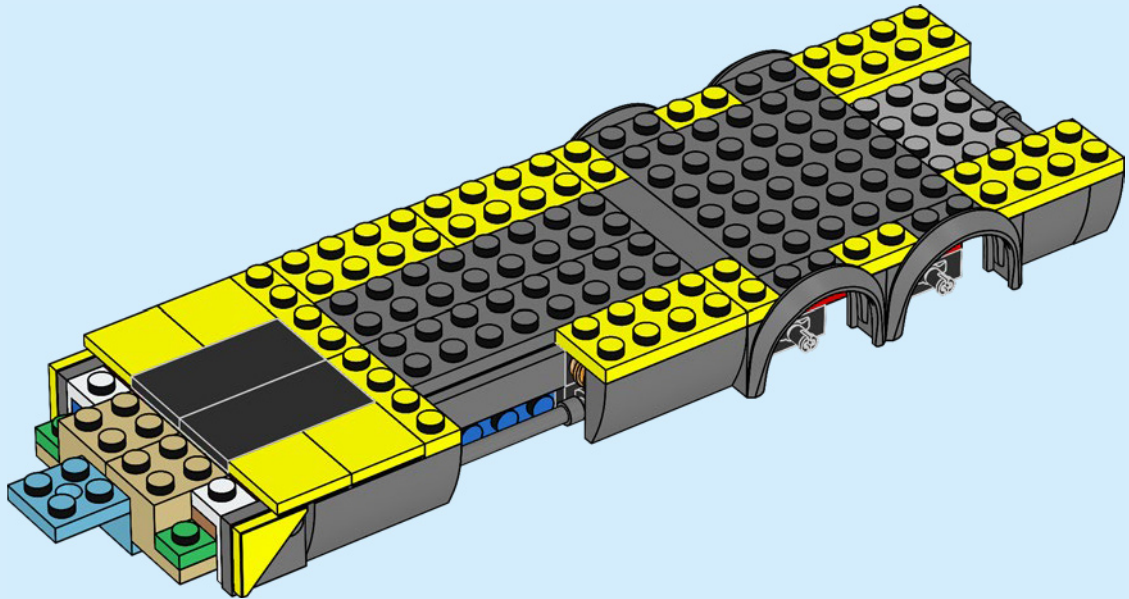

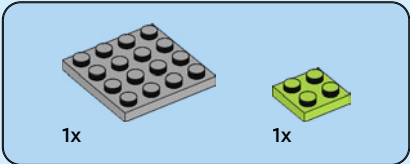
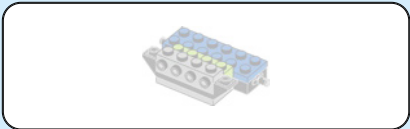

34

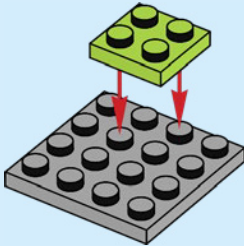





2x

35

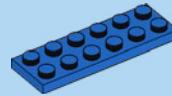
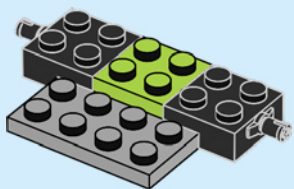

1x

36

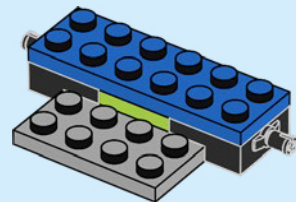

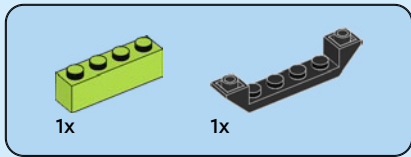

37

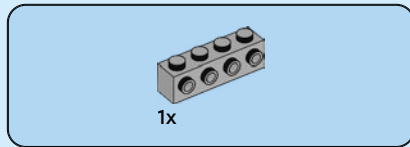
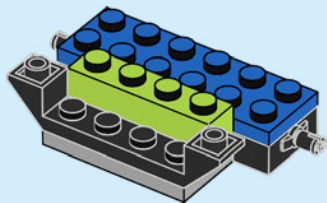

38

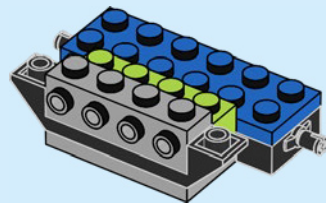

39

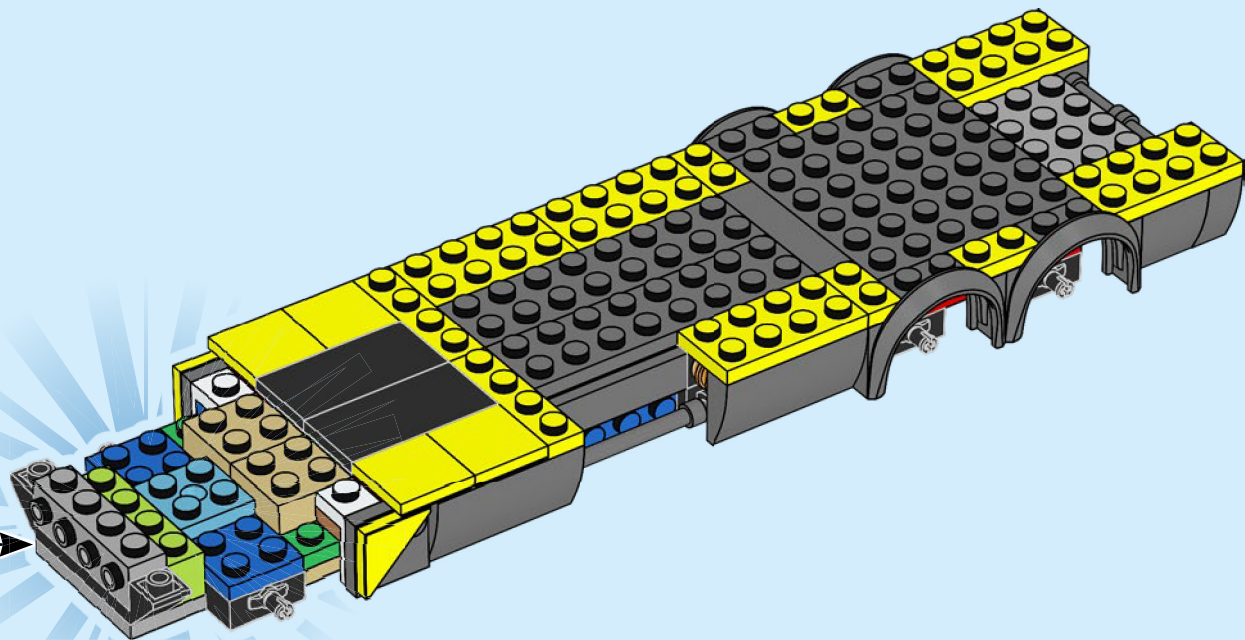



1x

40

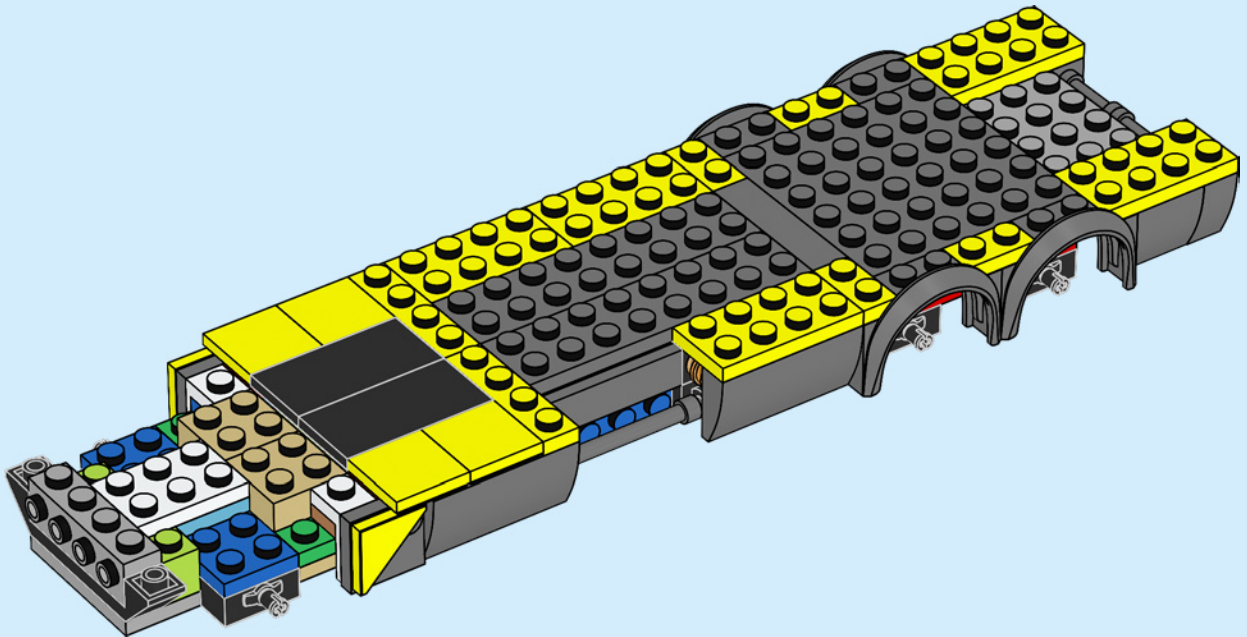



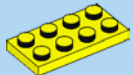

2x

42

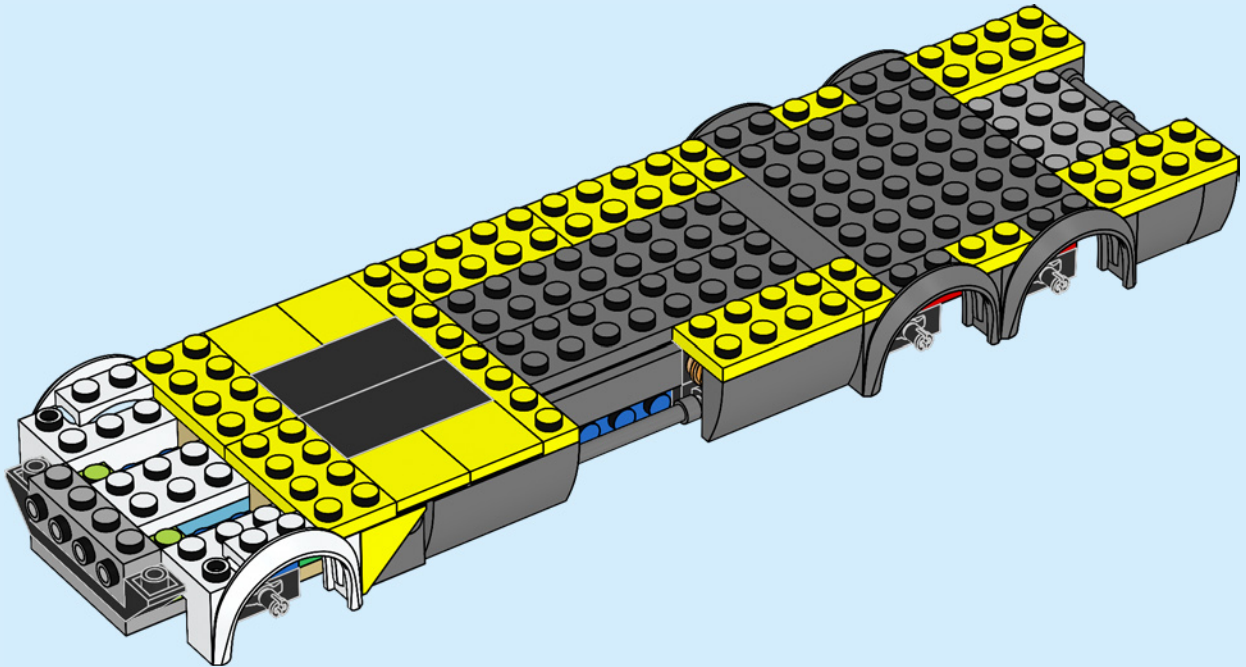

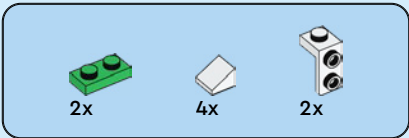

43

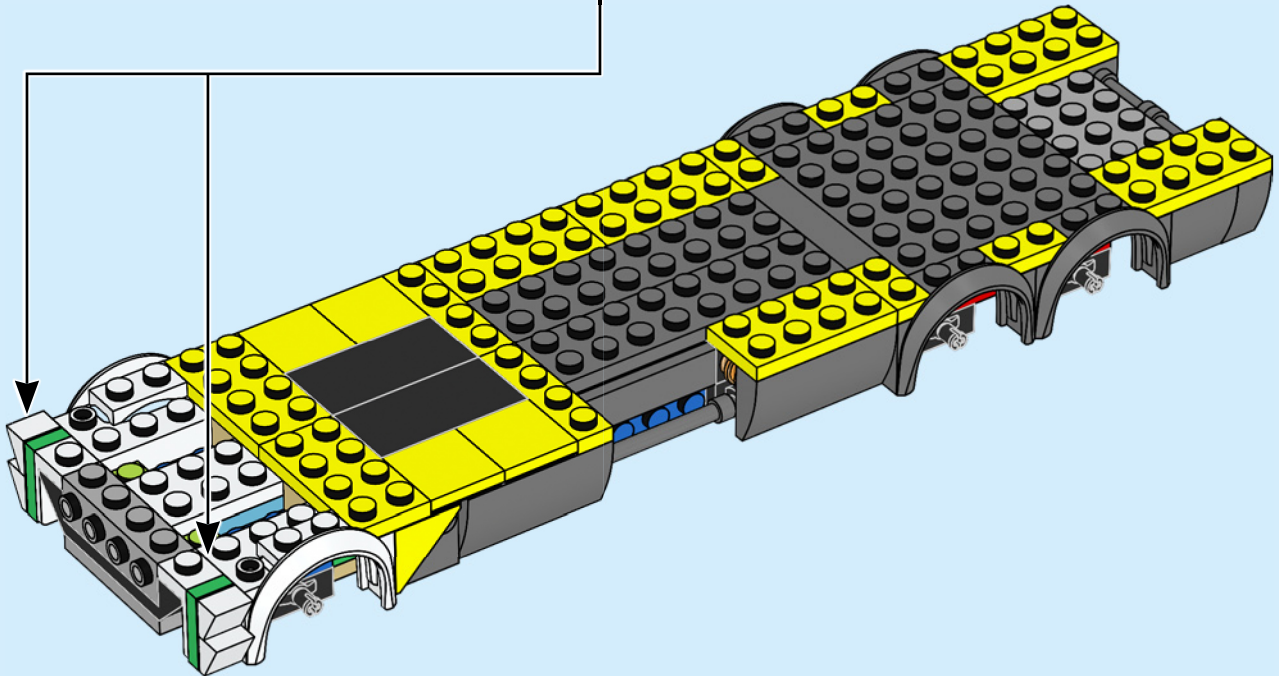
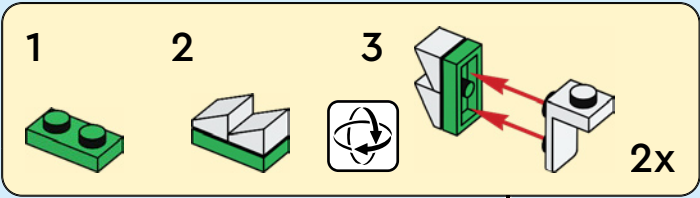

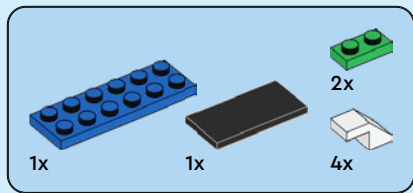

44

1

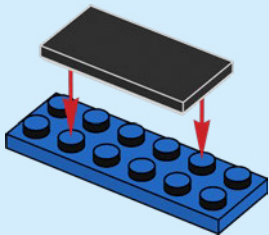

2

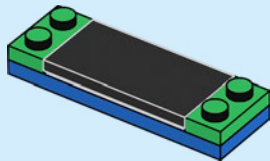

3

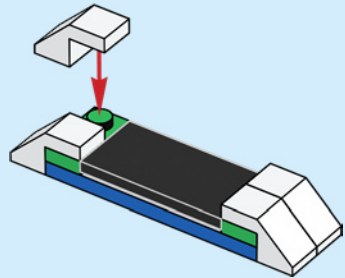



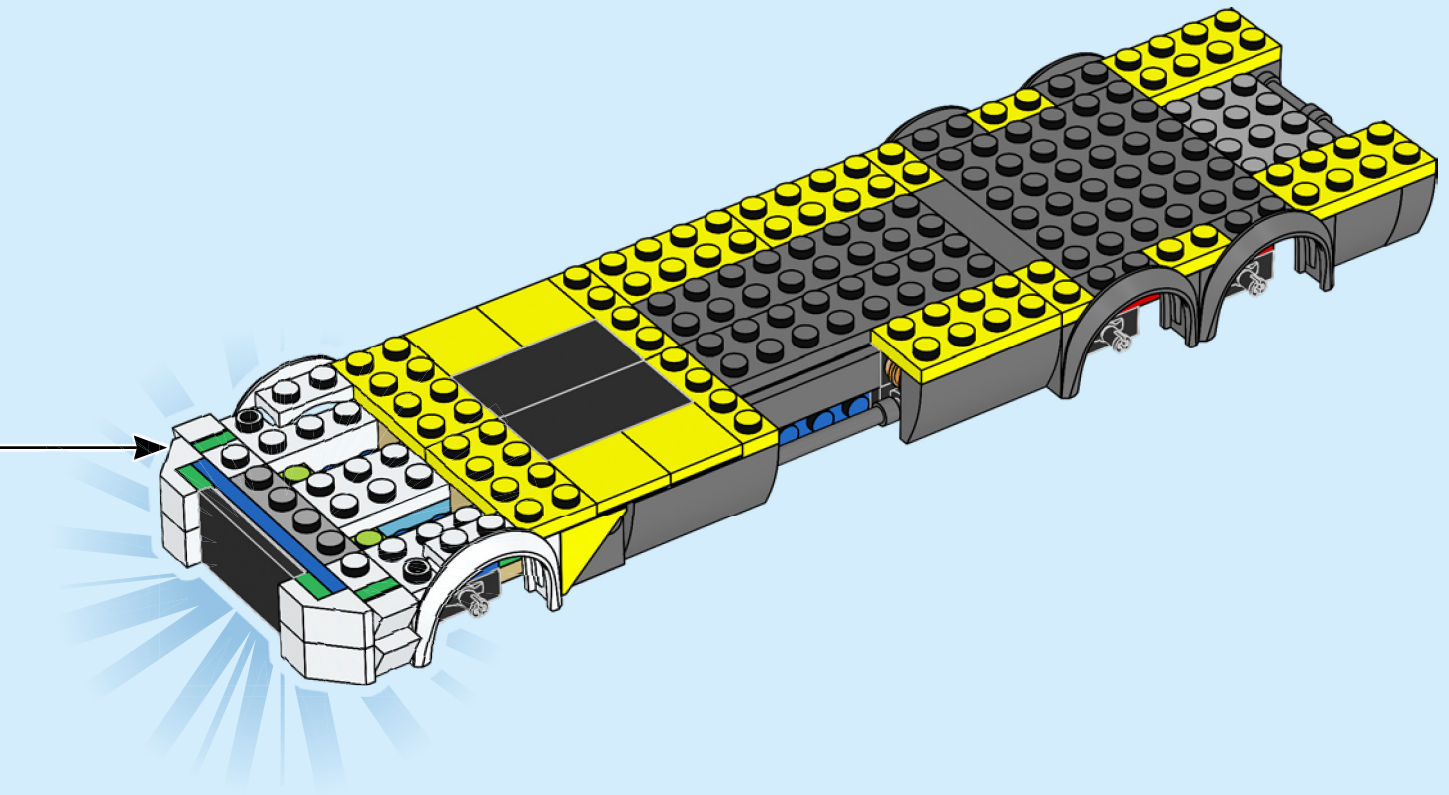



4x

45

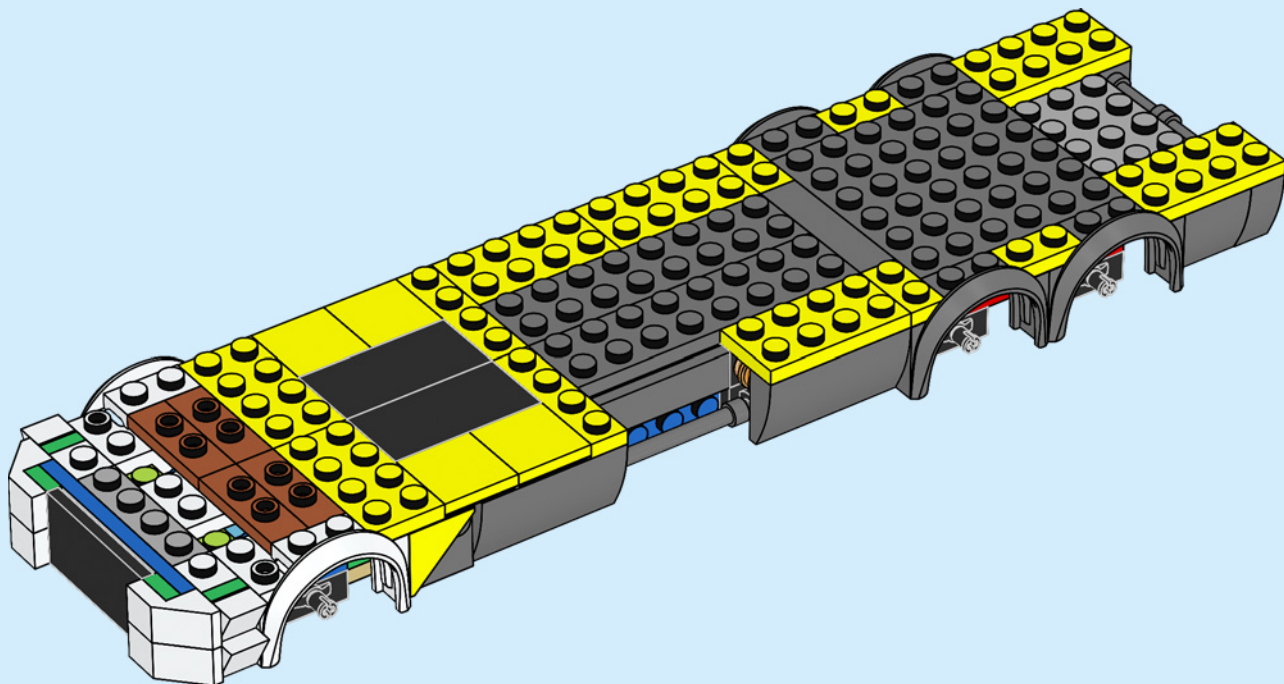

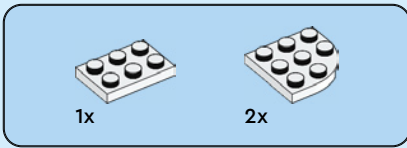

46

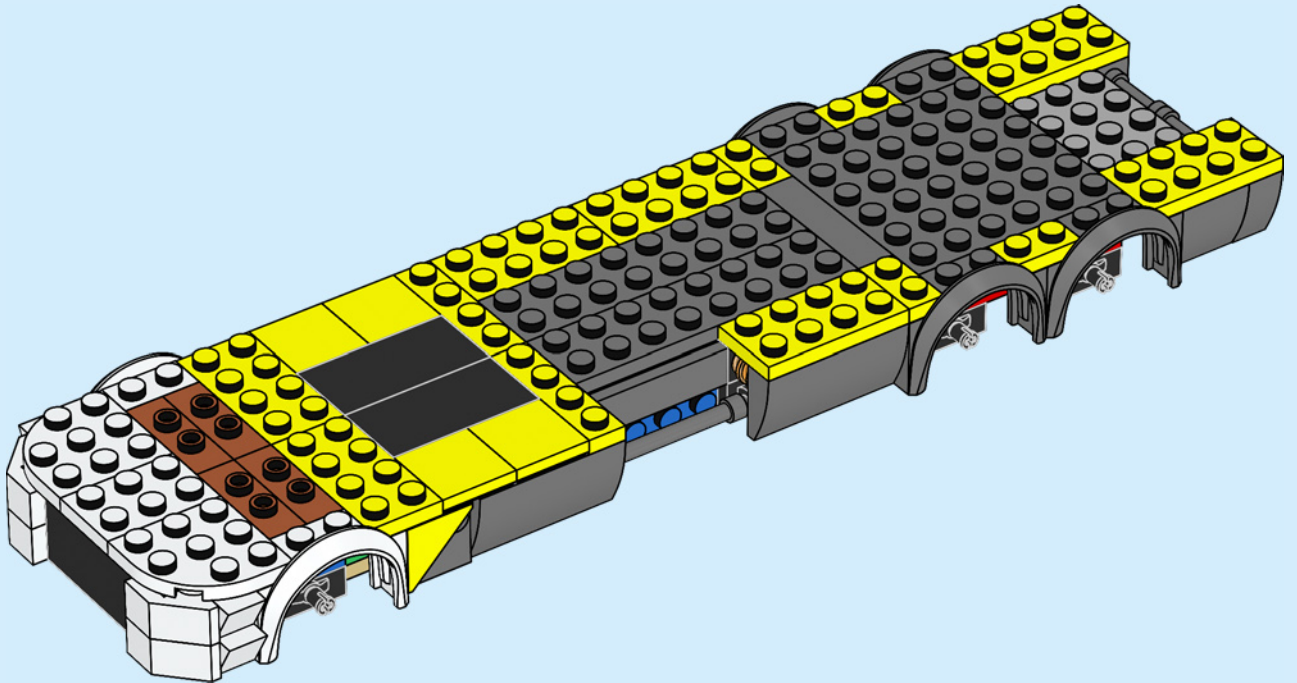

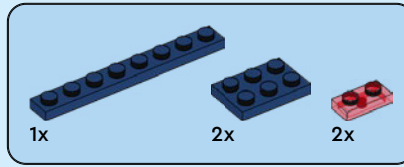

47

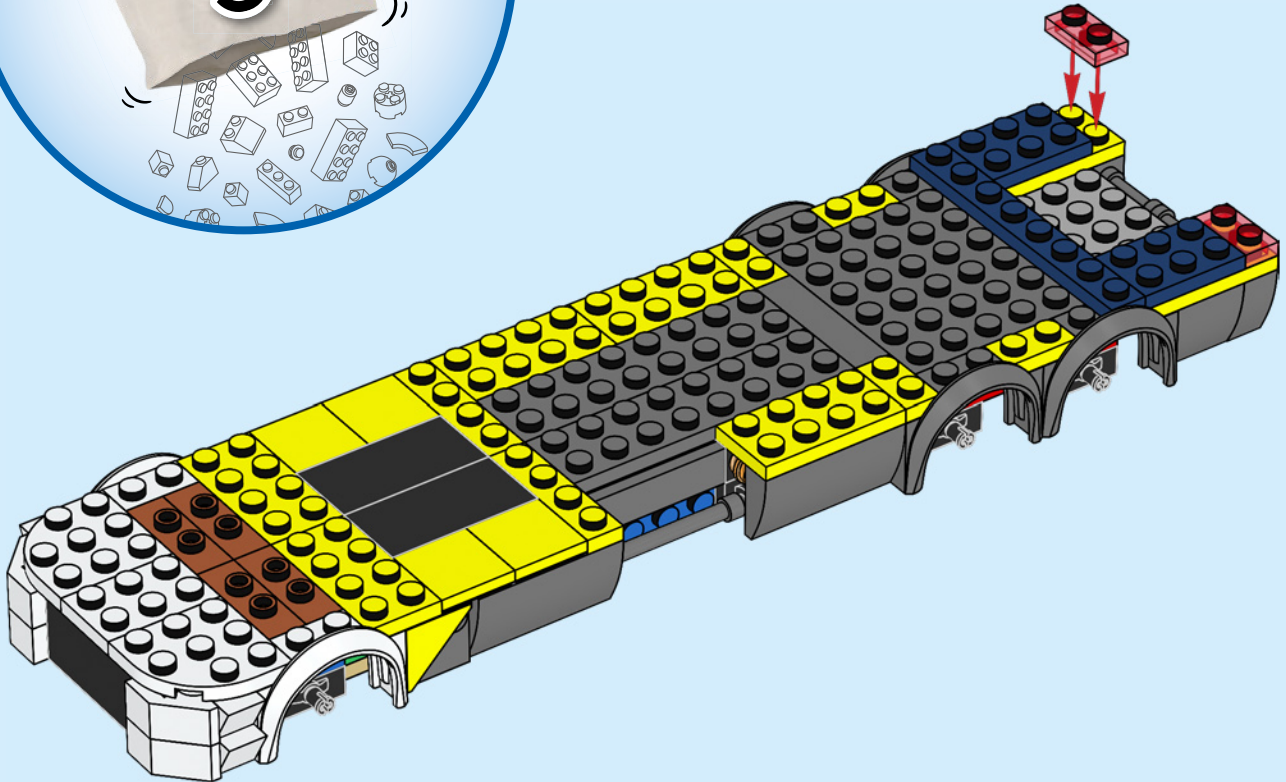

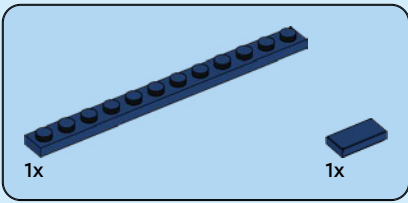

48

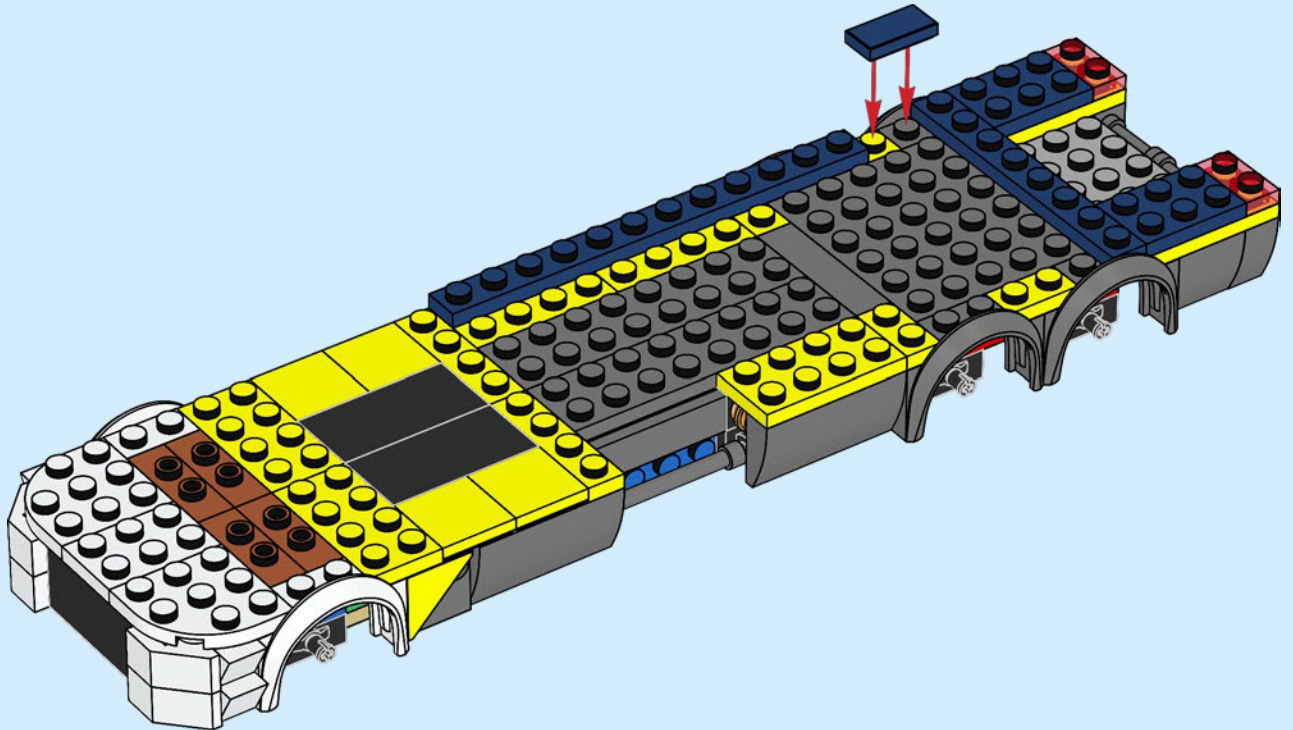

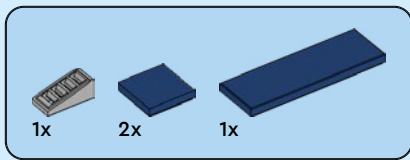

49

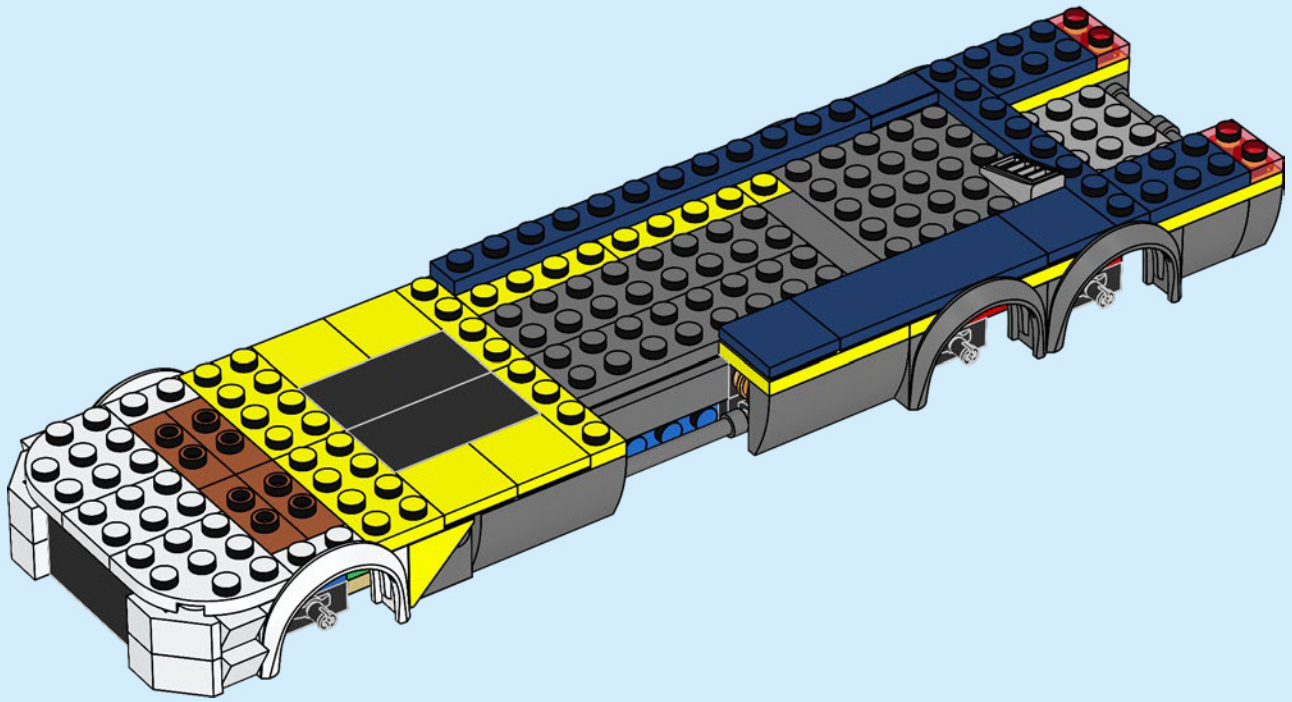

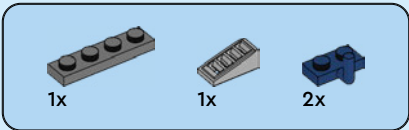

50

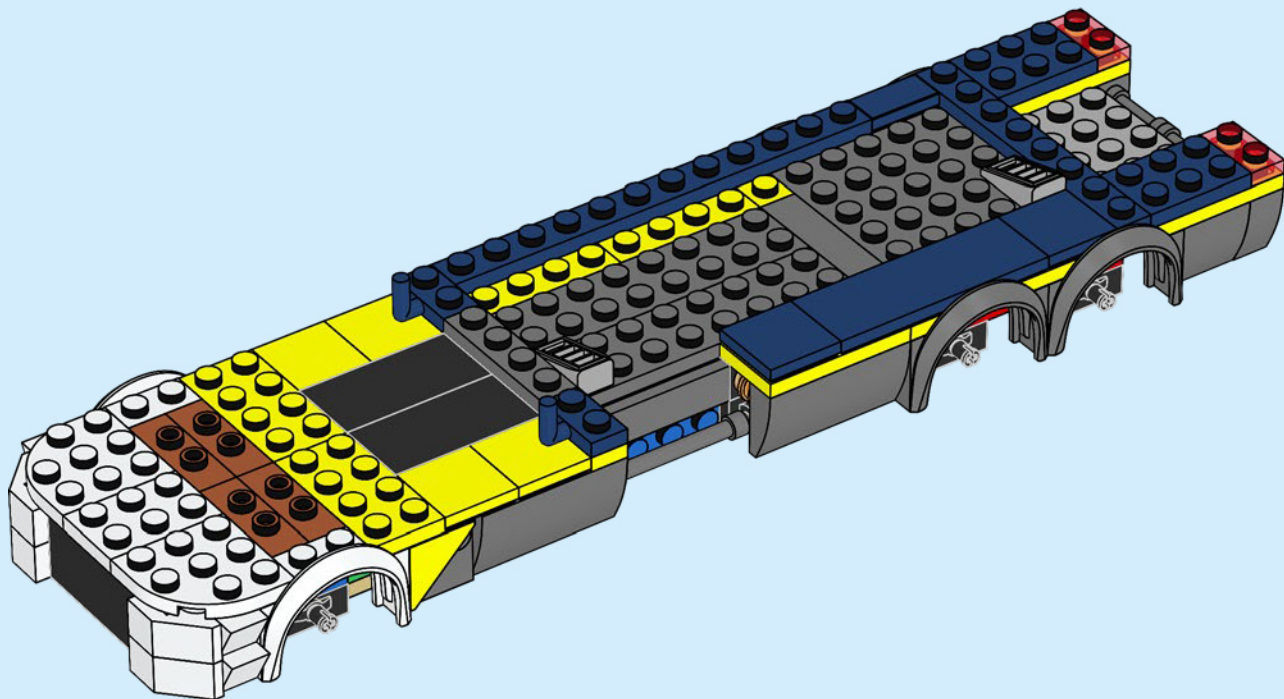

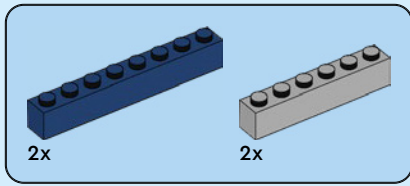

51

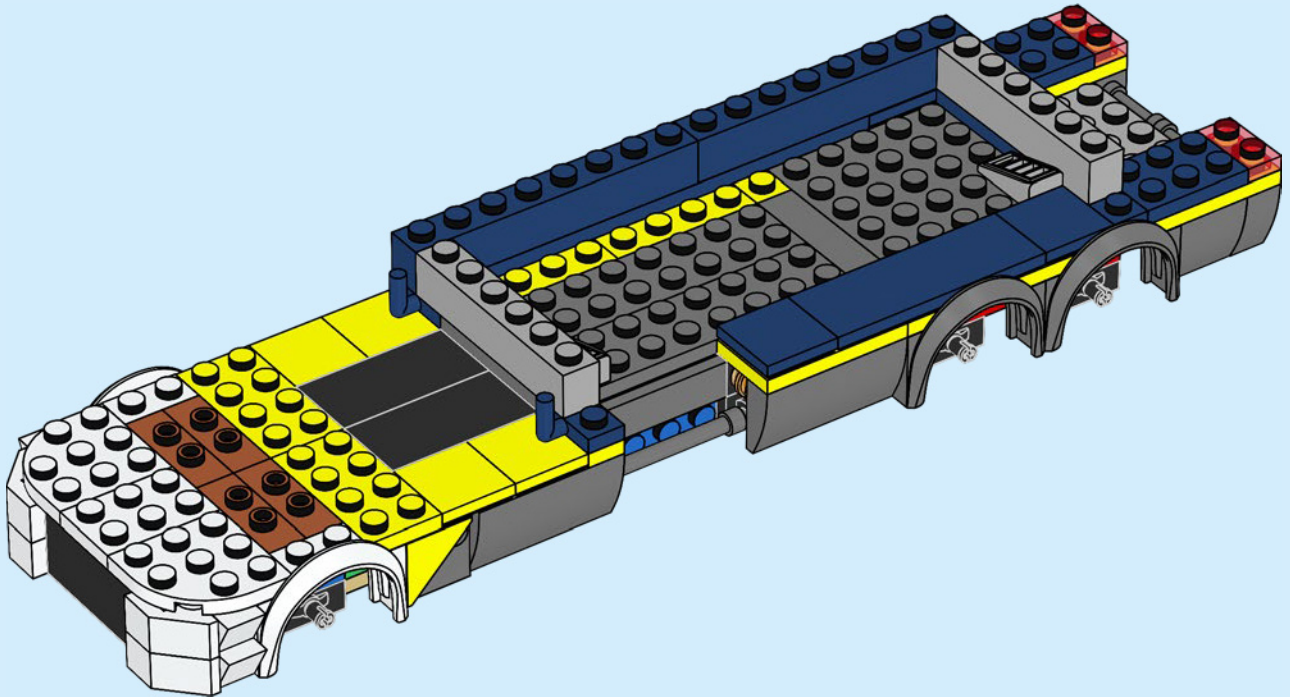



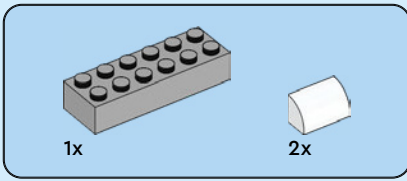

52

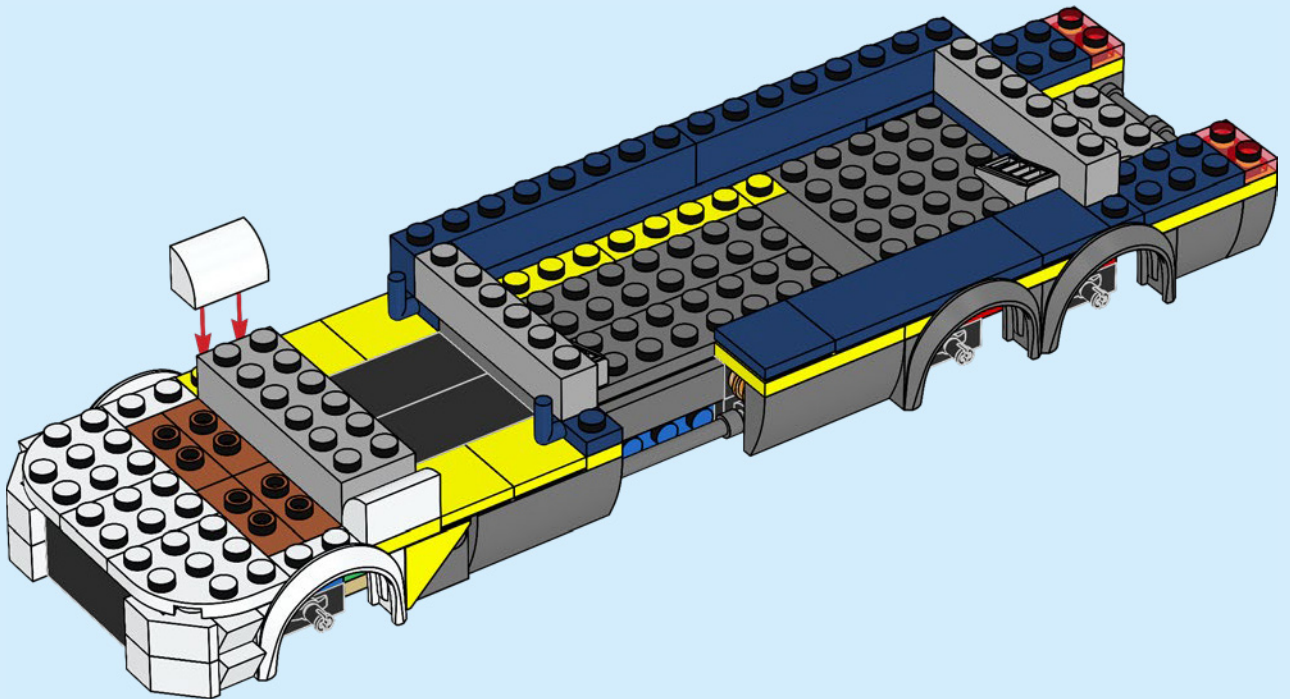



2x

53

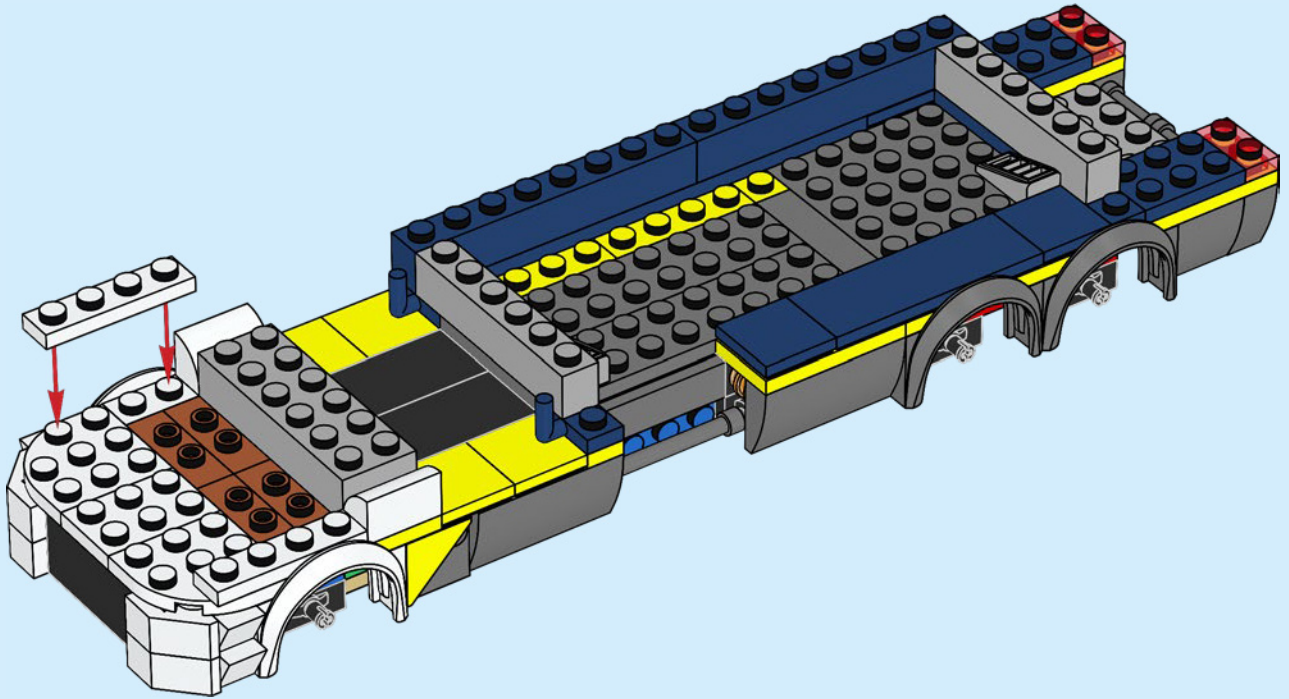

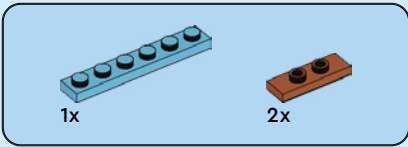

54

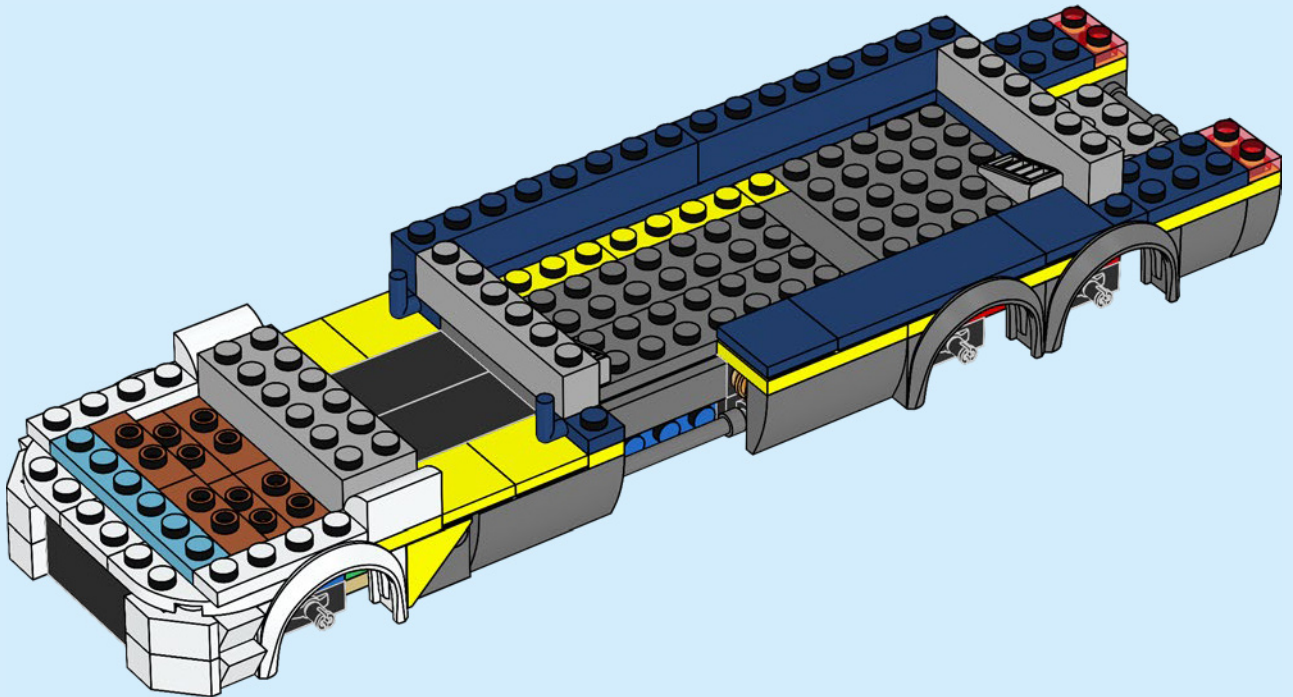

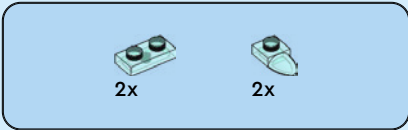

55

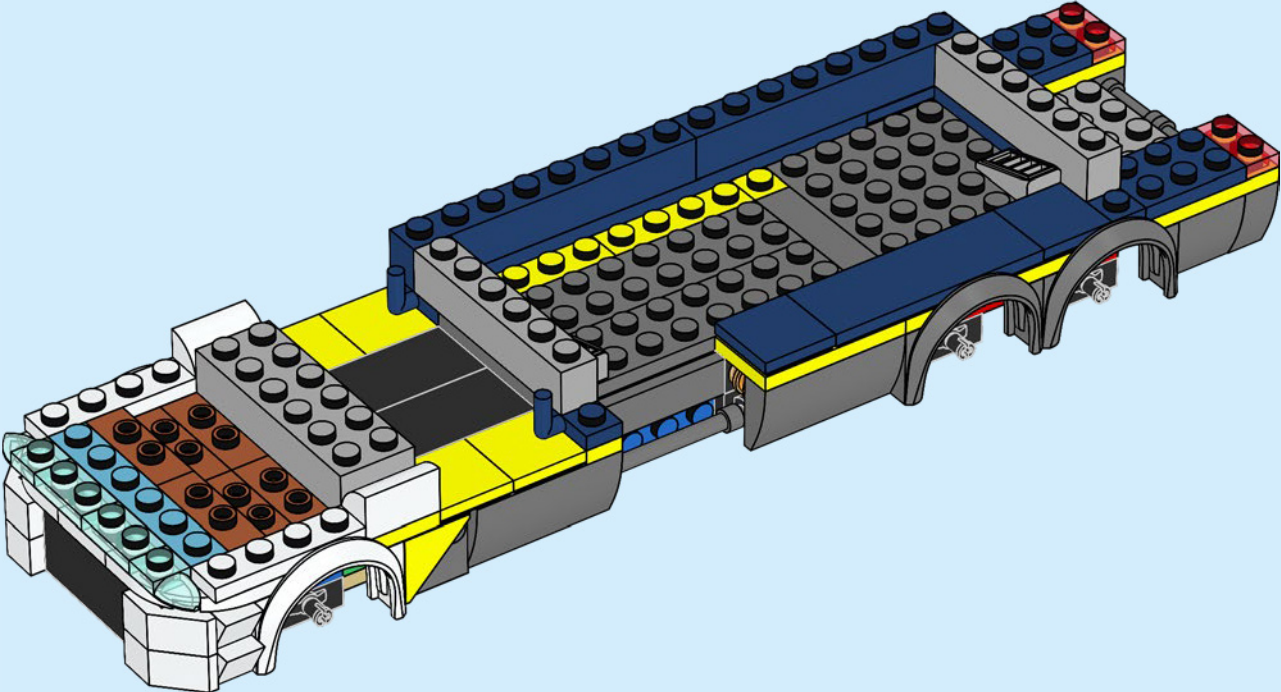



1x



1x

56

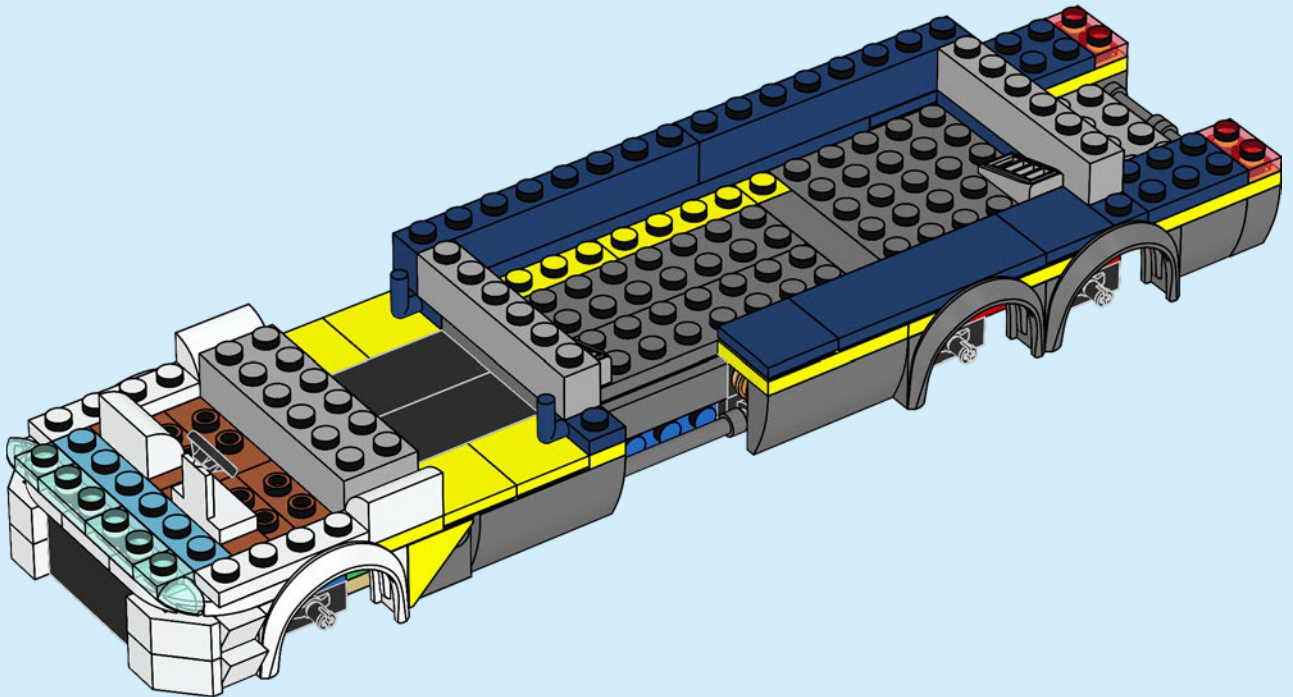

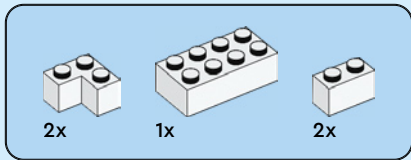

57

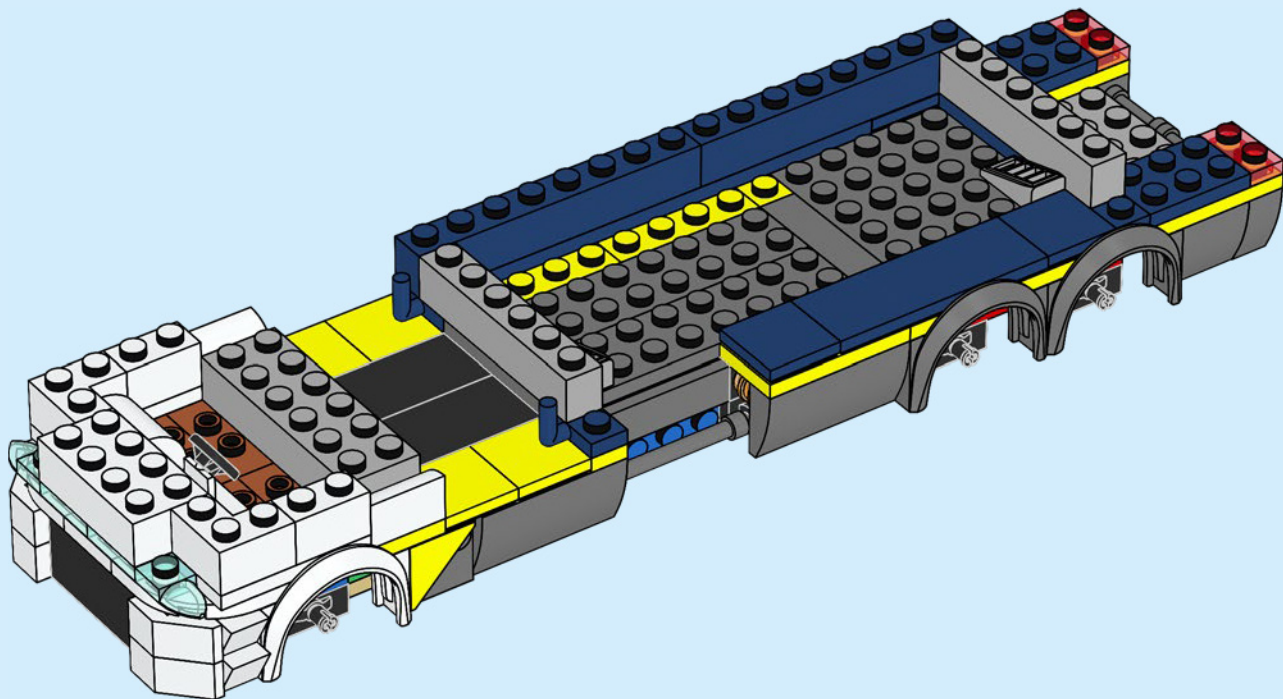

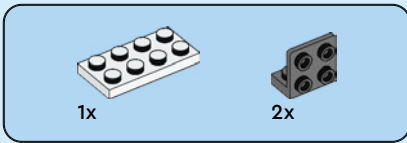

58

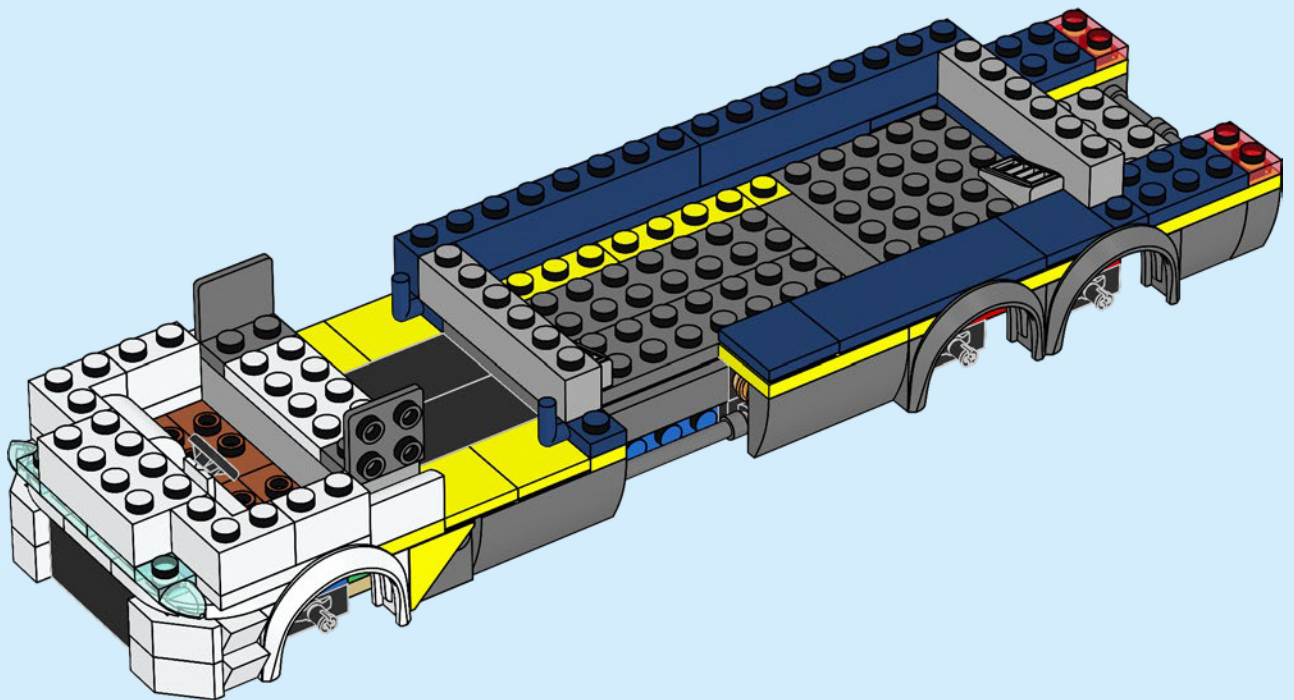

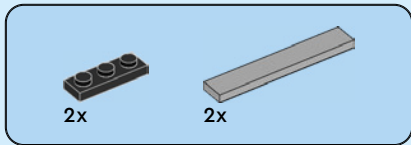

59

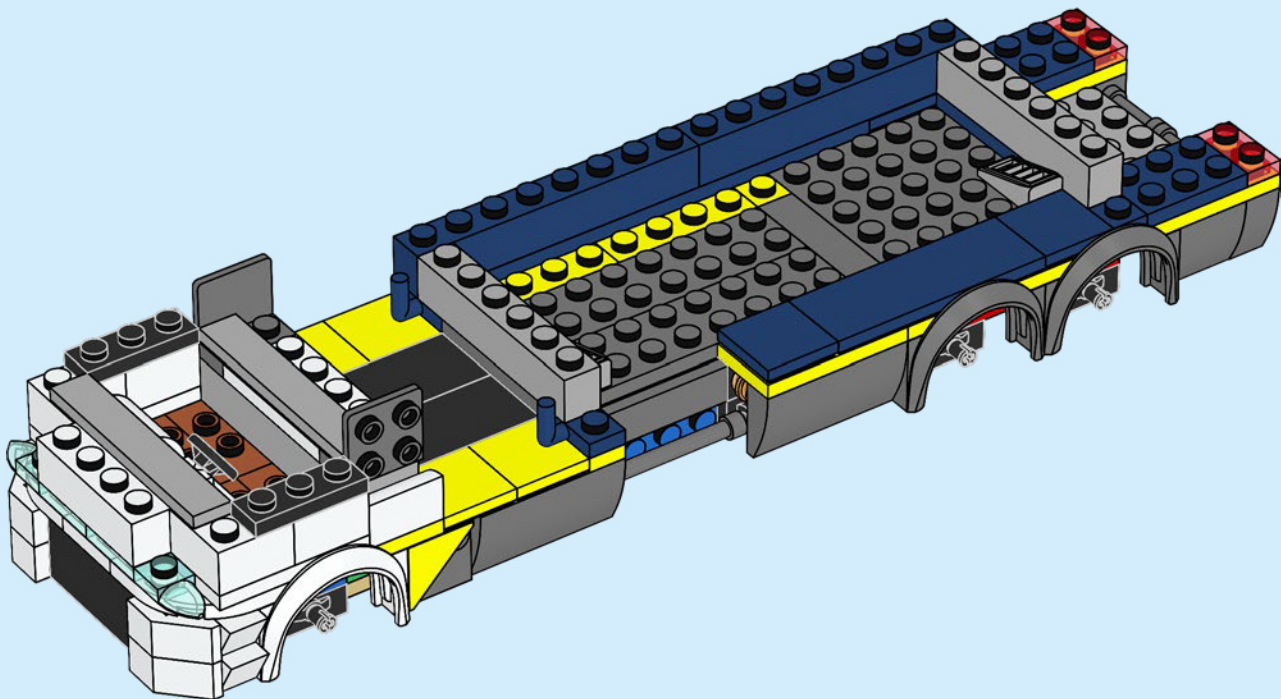





1x



1x



1x

# 60

1

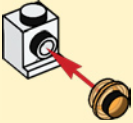

2

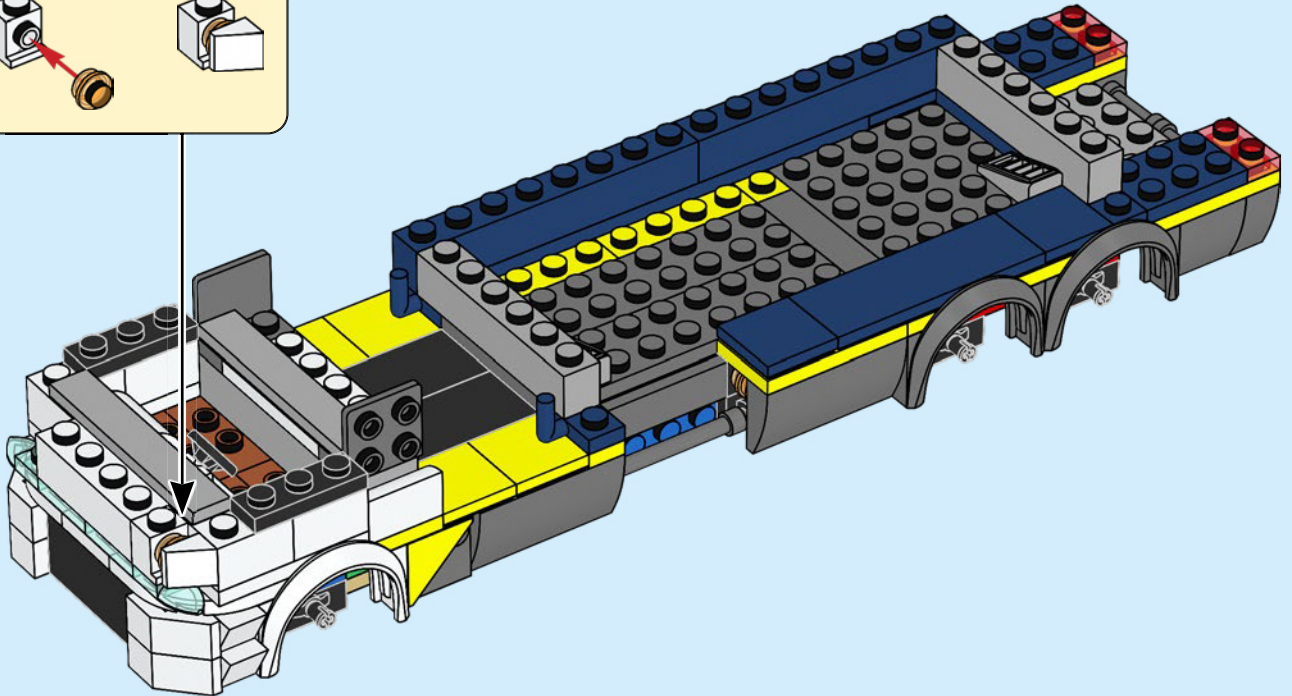



1x



1x



1x

# 61

1

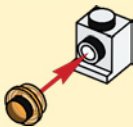

2

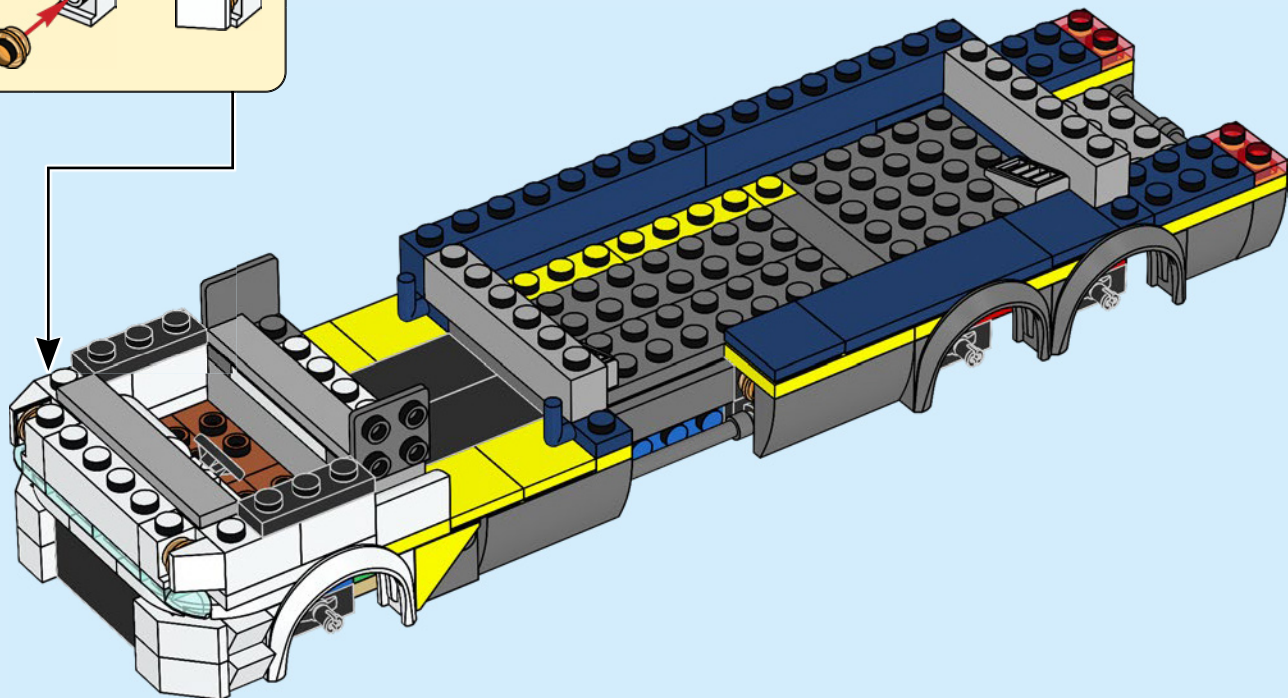



2x



2x

62

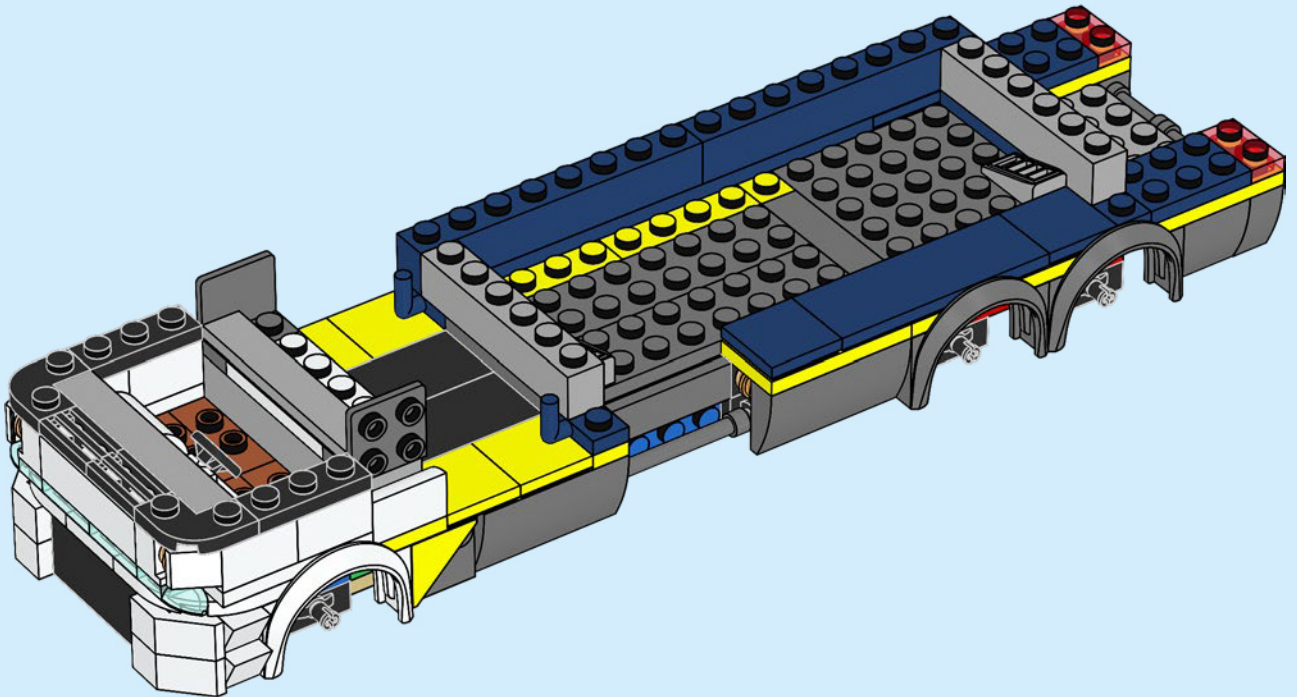

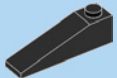

2x

63

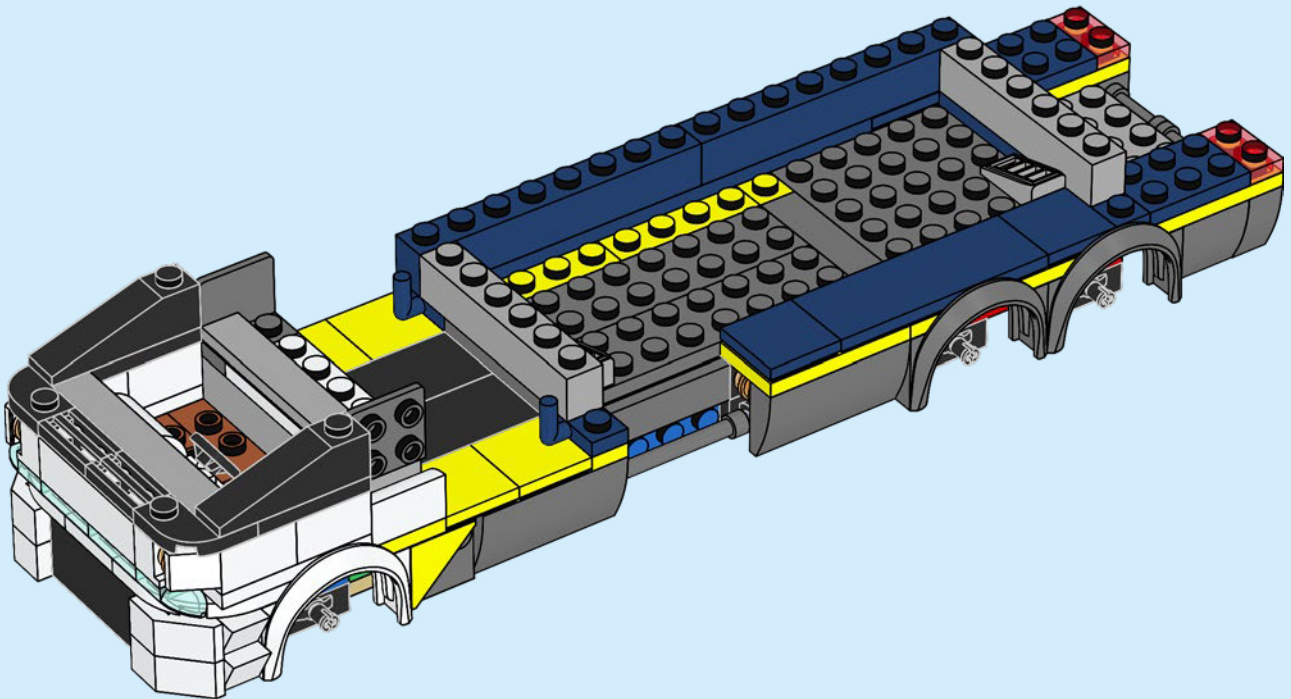



2x

64

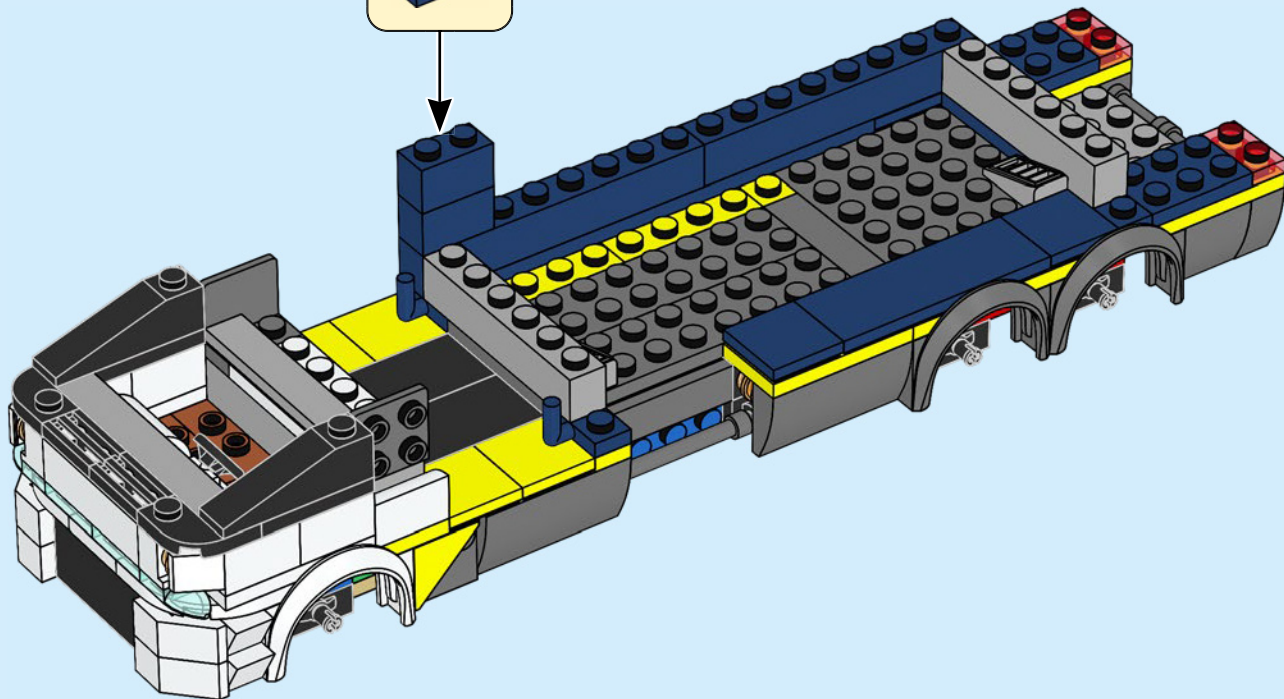
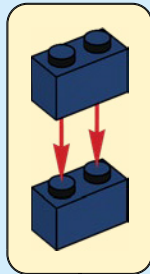



2x



2x

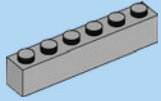

2x

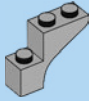

8x

65

1

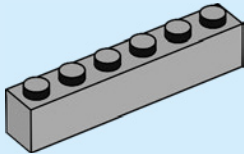

2

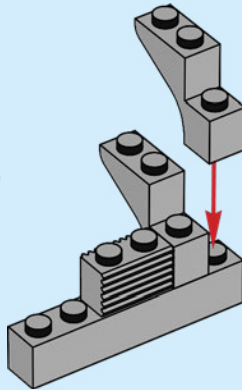

3

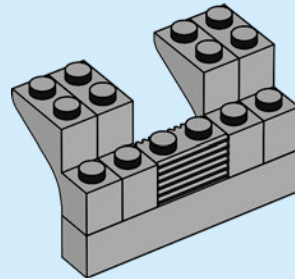

2x



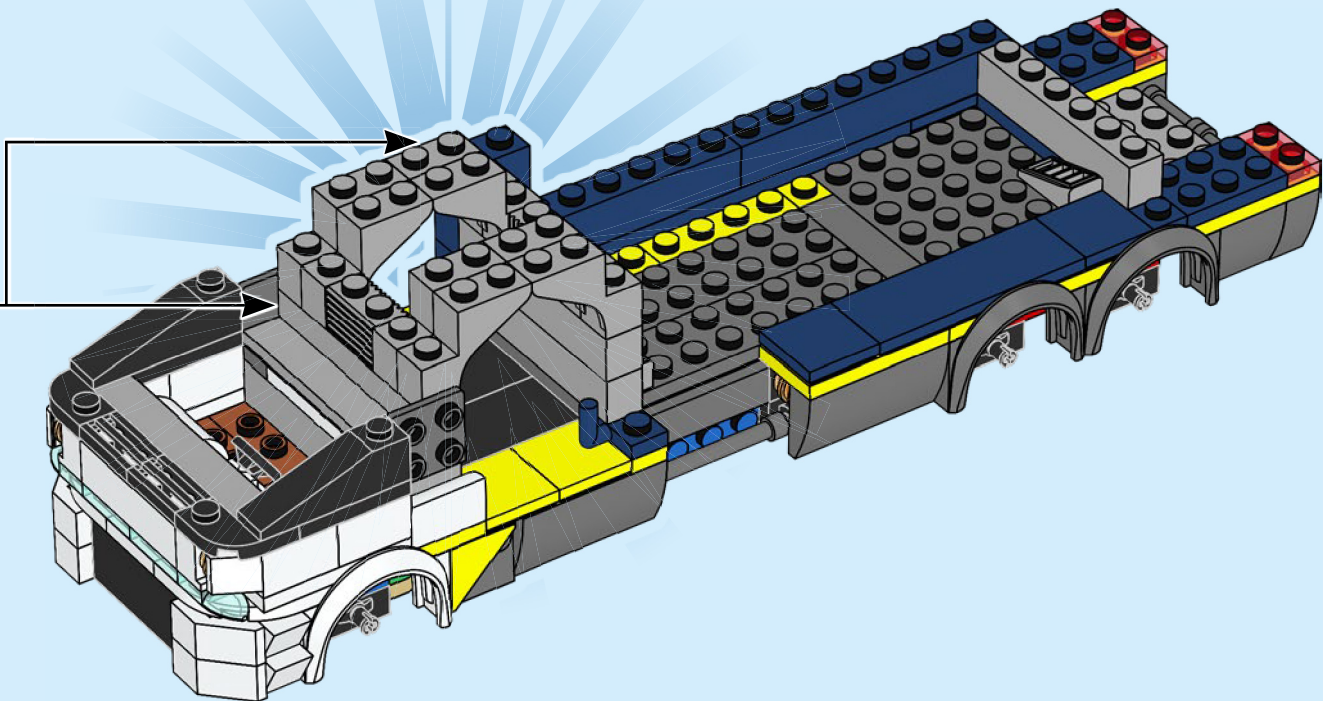



1x

66

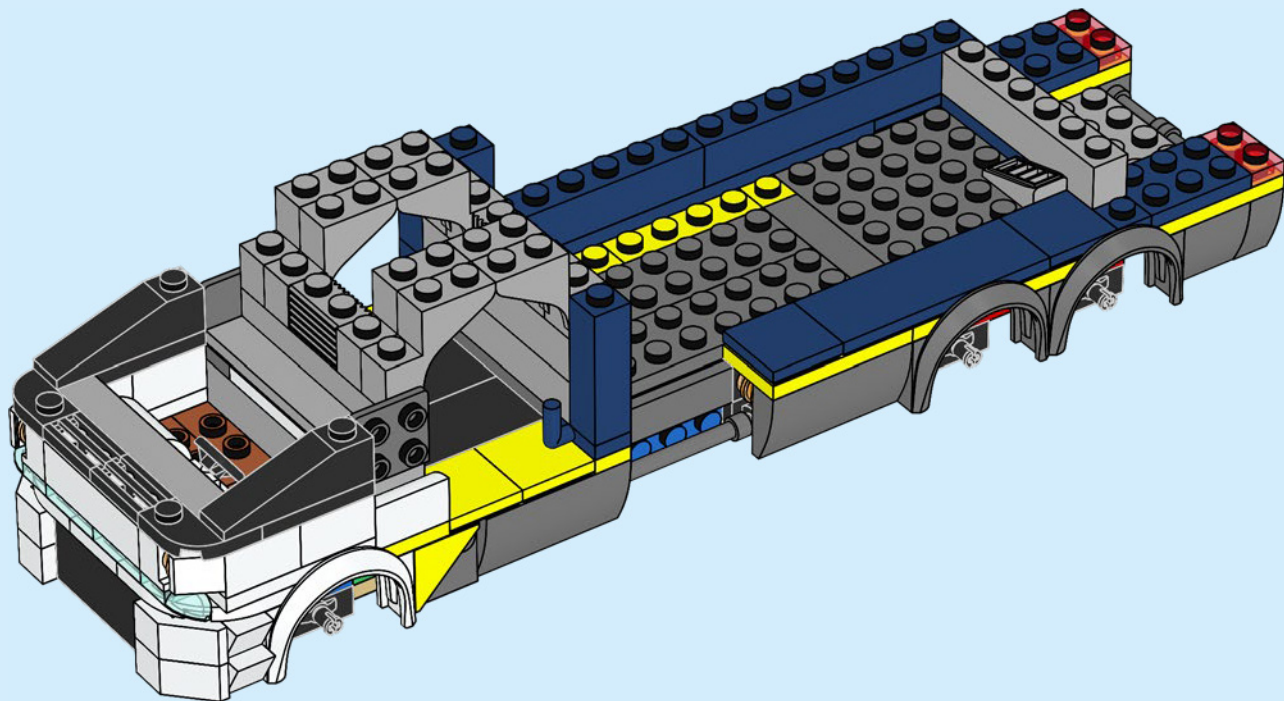



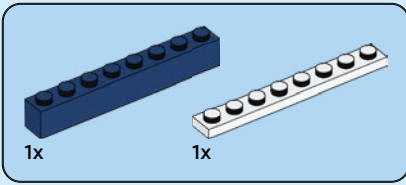

67

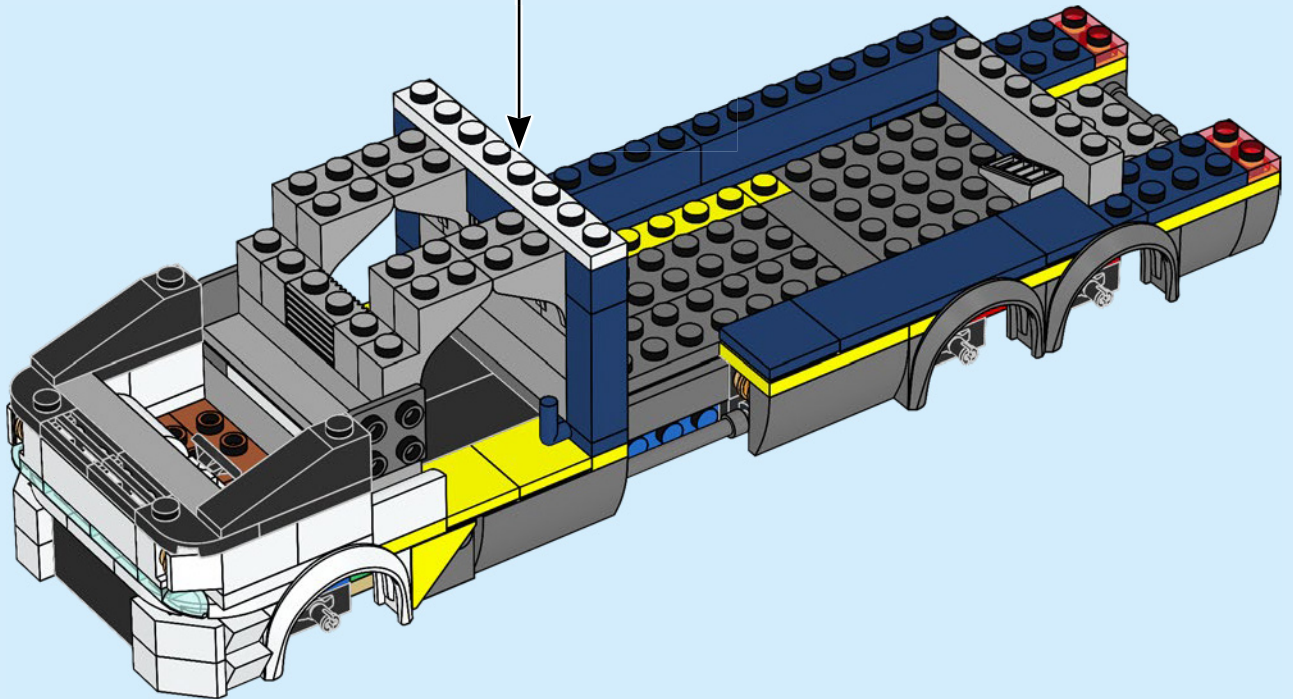
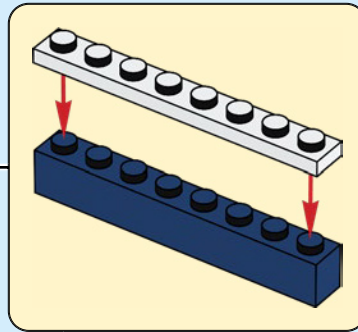



2x



2x



1x

68

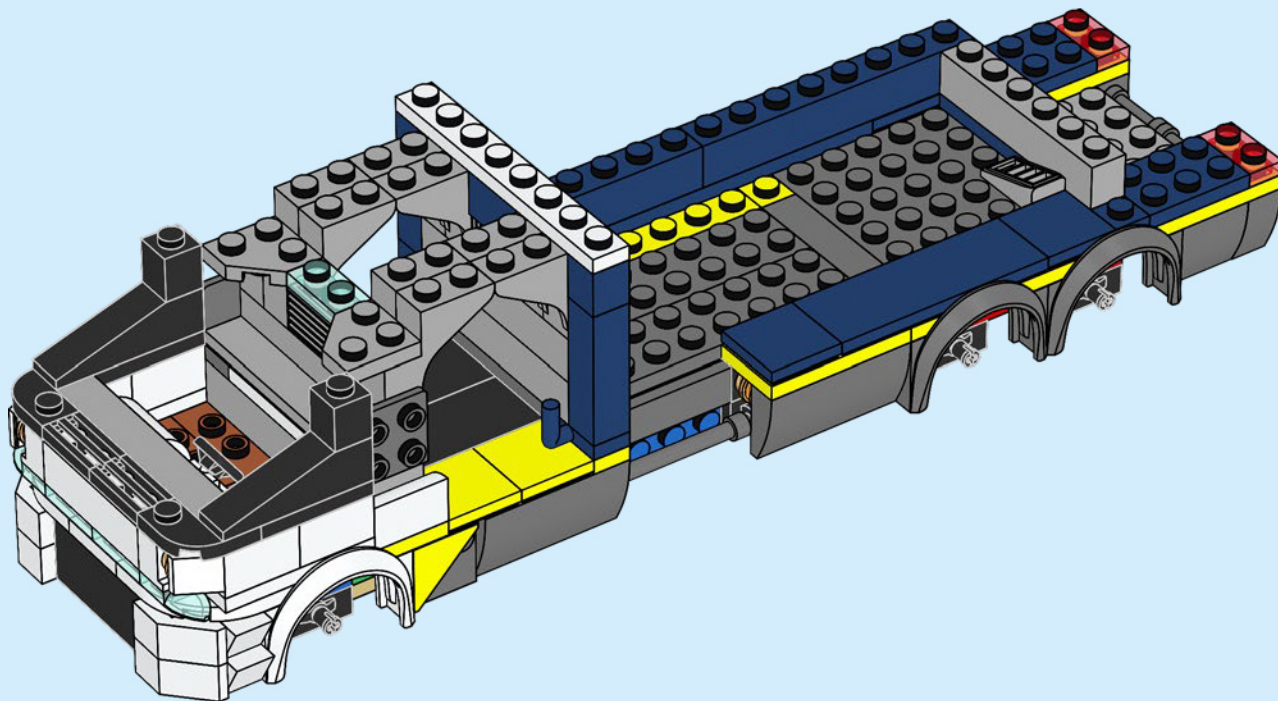

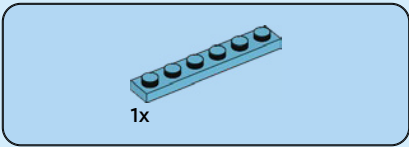

69

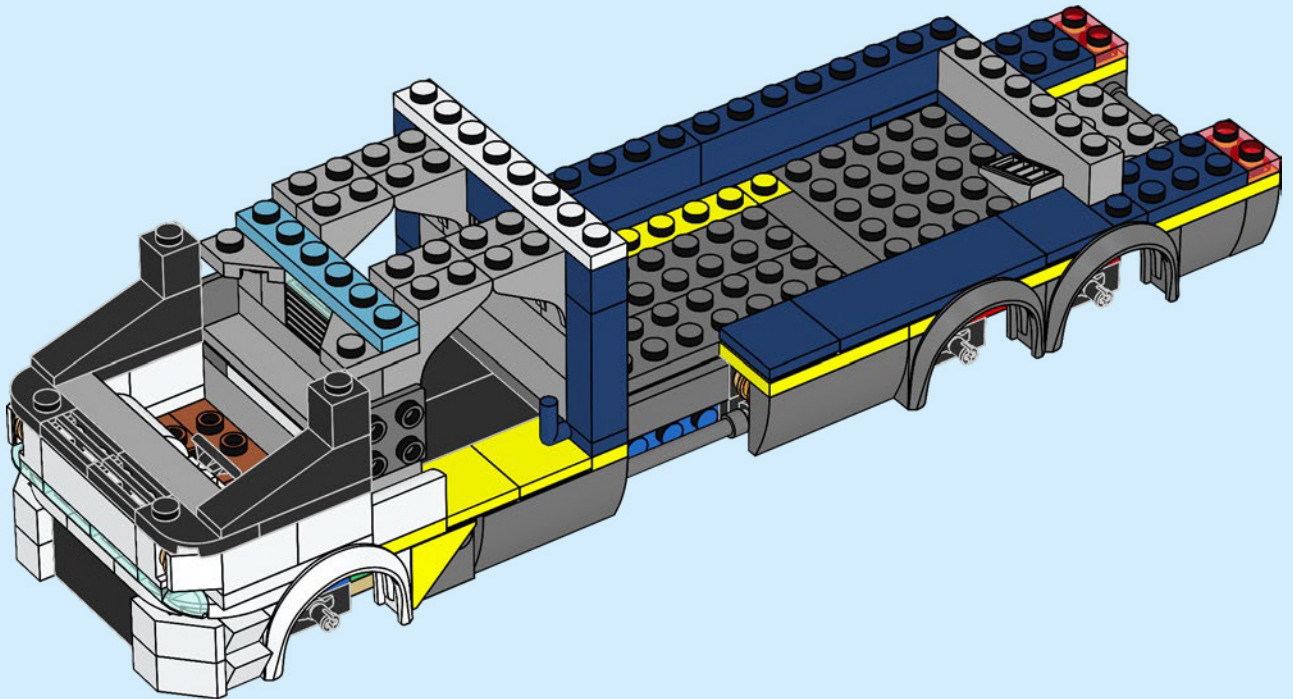



2x

70

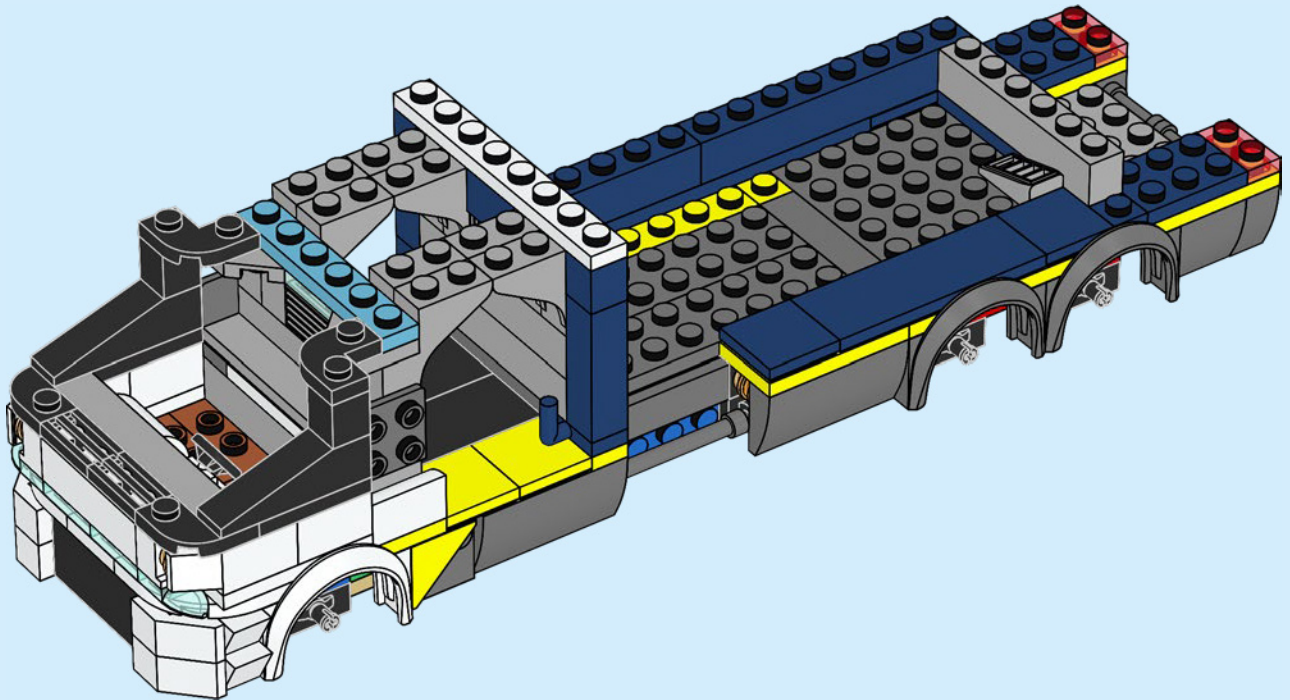



2x



2x

71

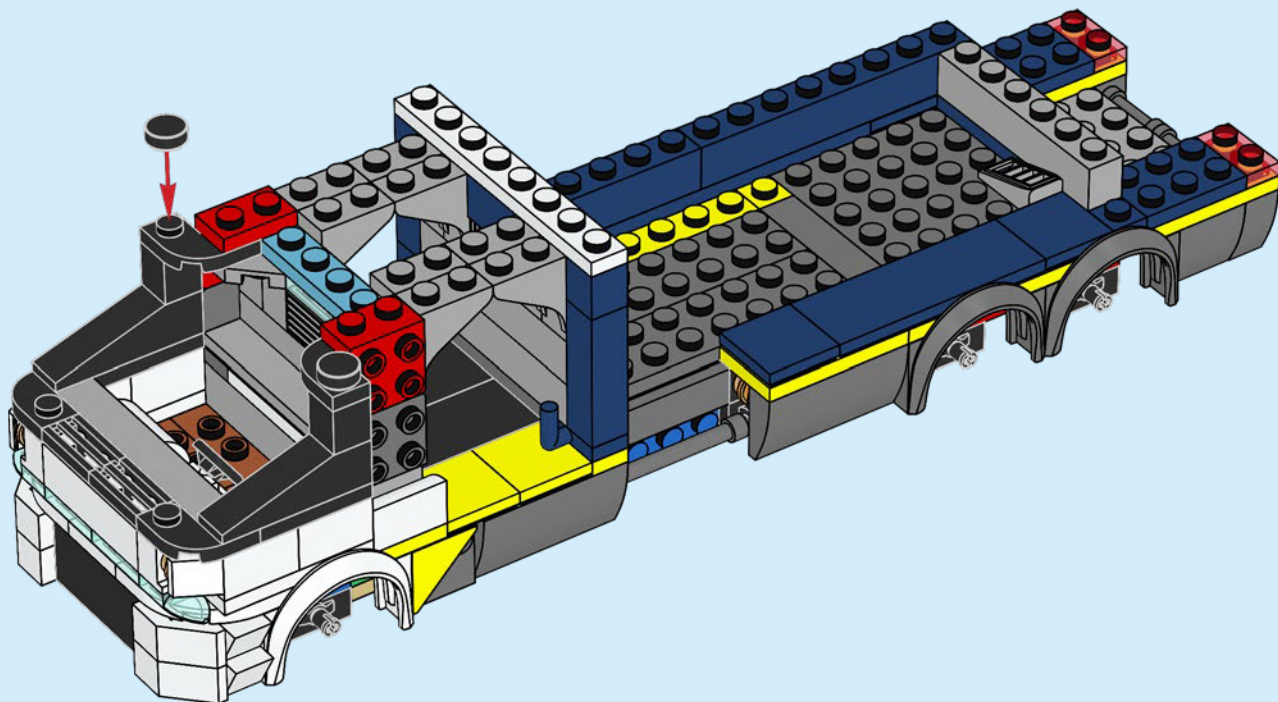

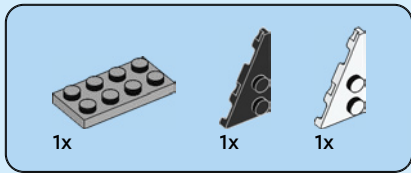

72

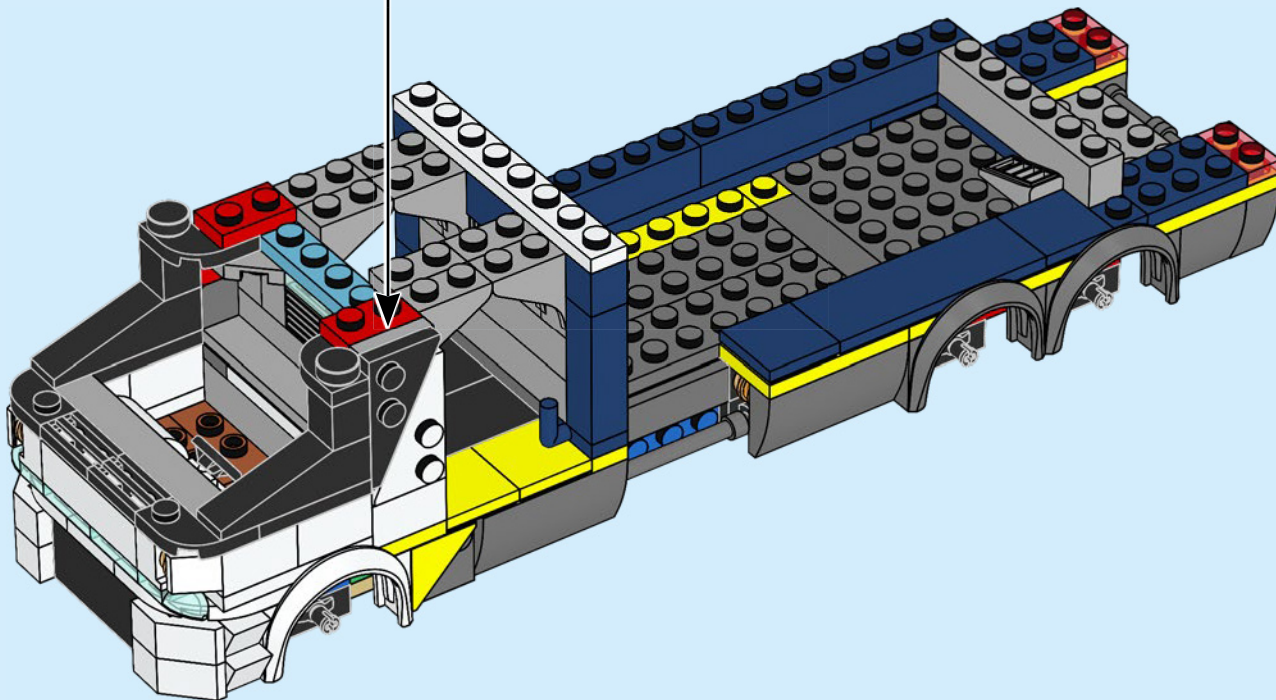
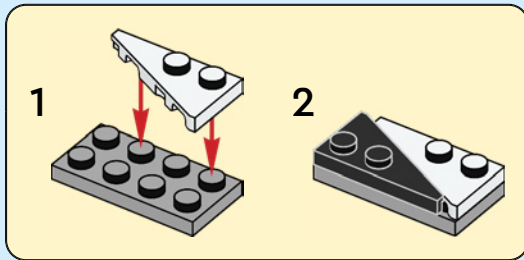

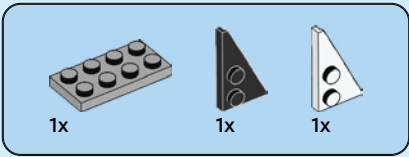

73

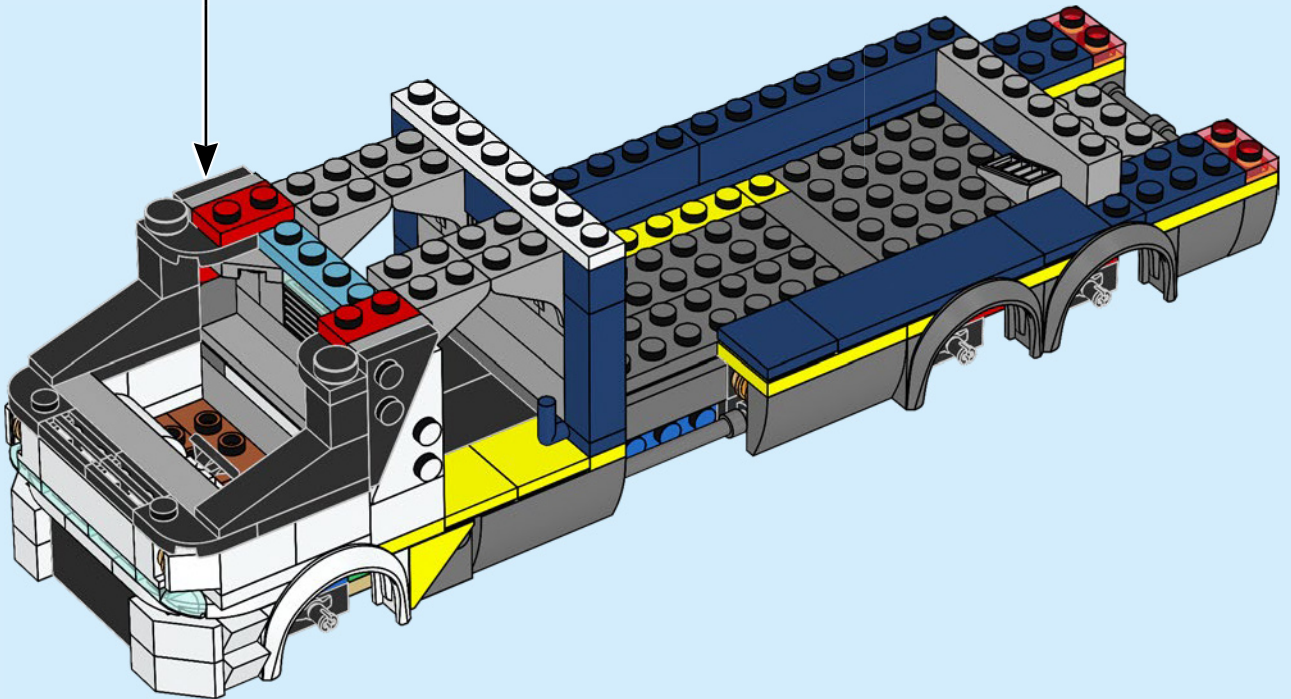
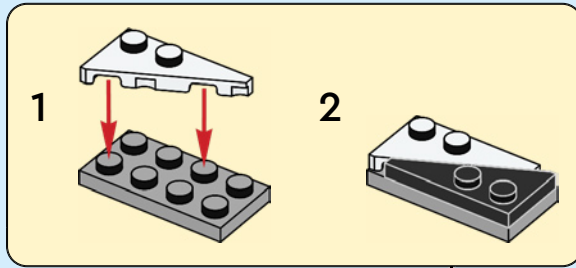



2x



4x

# 74

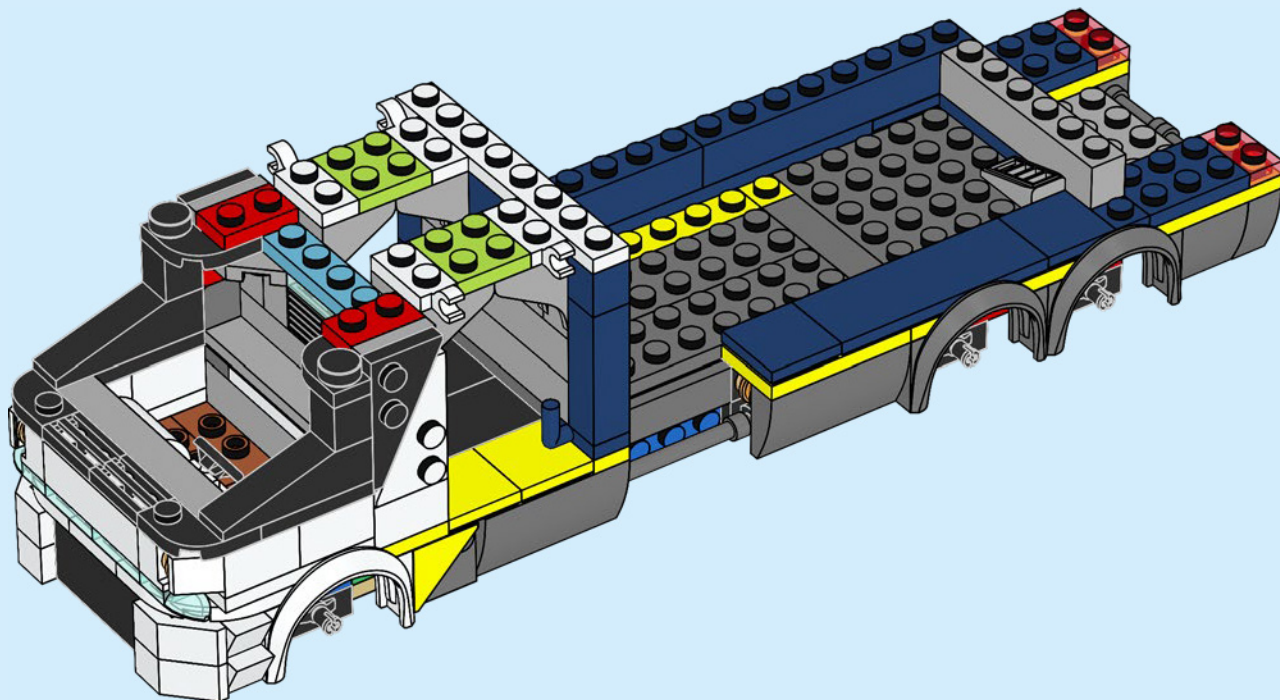



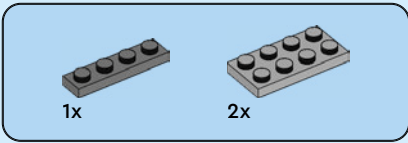

75

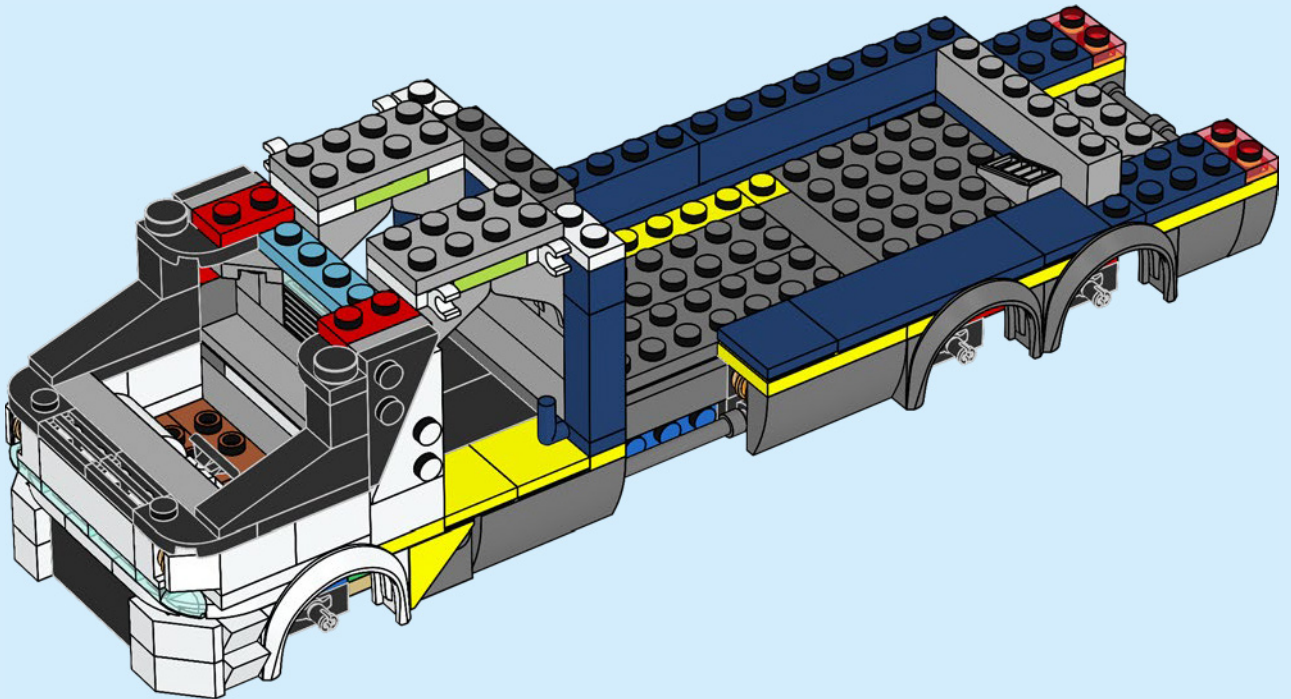

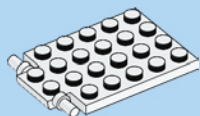
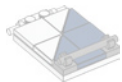

1x

76

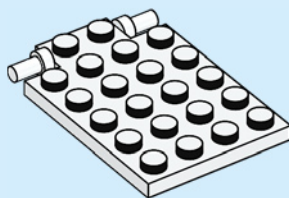

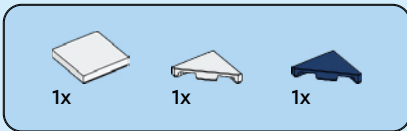

77

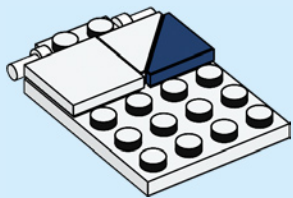

78

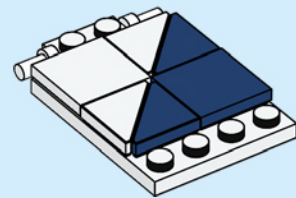



1x



2x

79

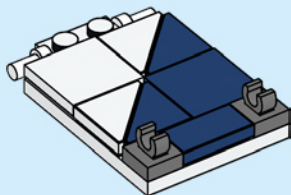

1x

80

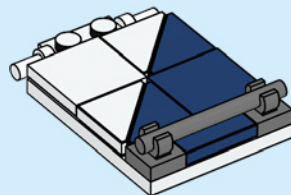

81

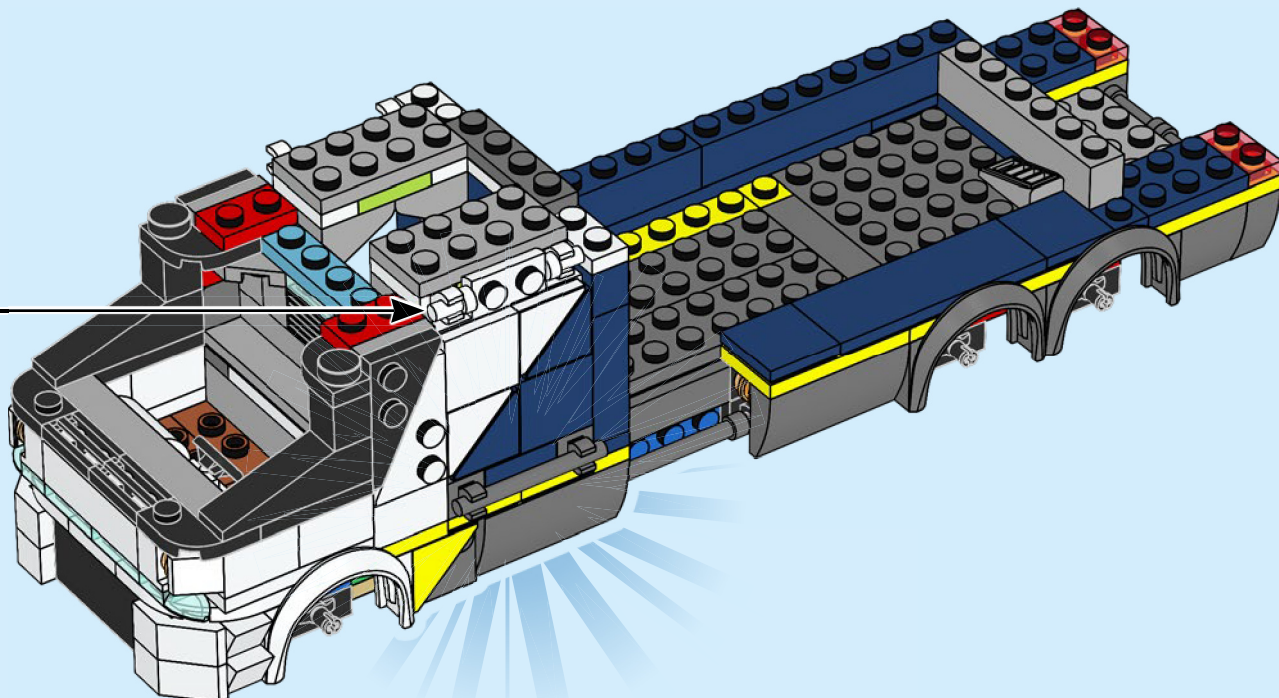

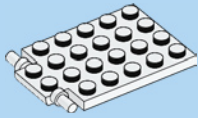
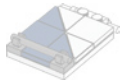

1x

82

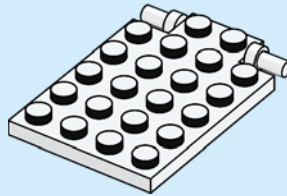

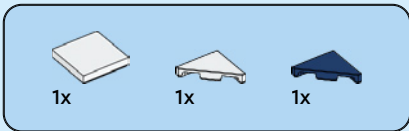

83

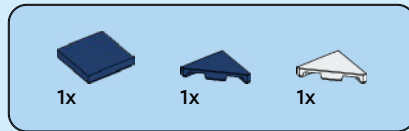
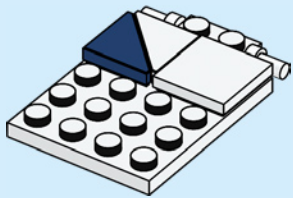

84

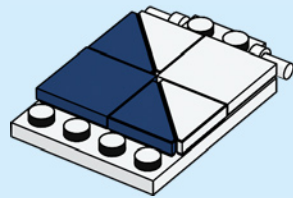

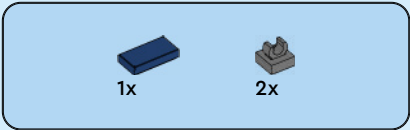

85

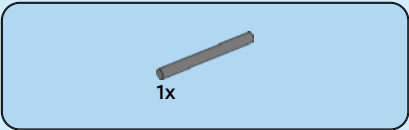
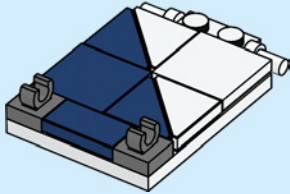

86

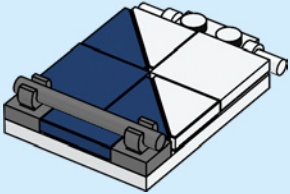



87

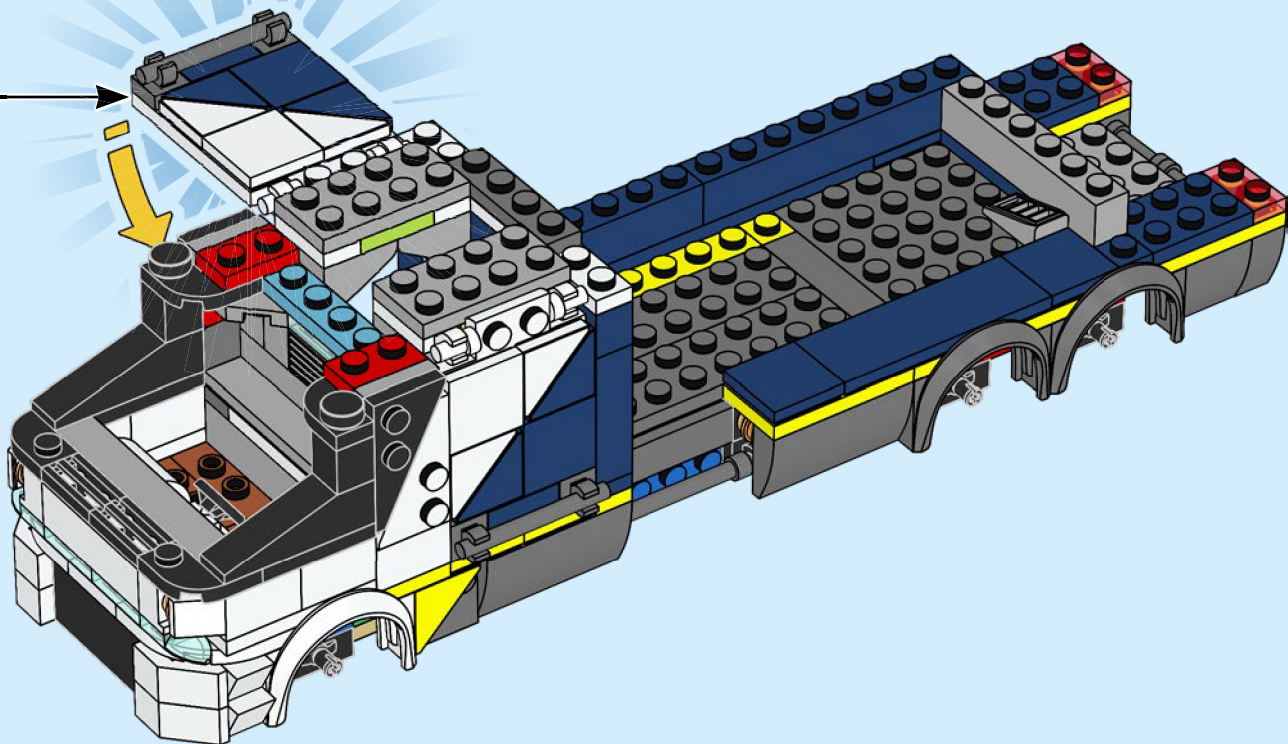

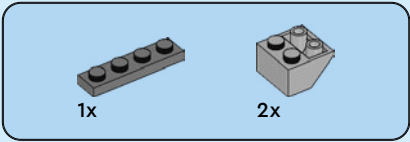

88

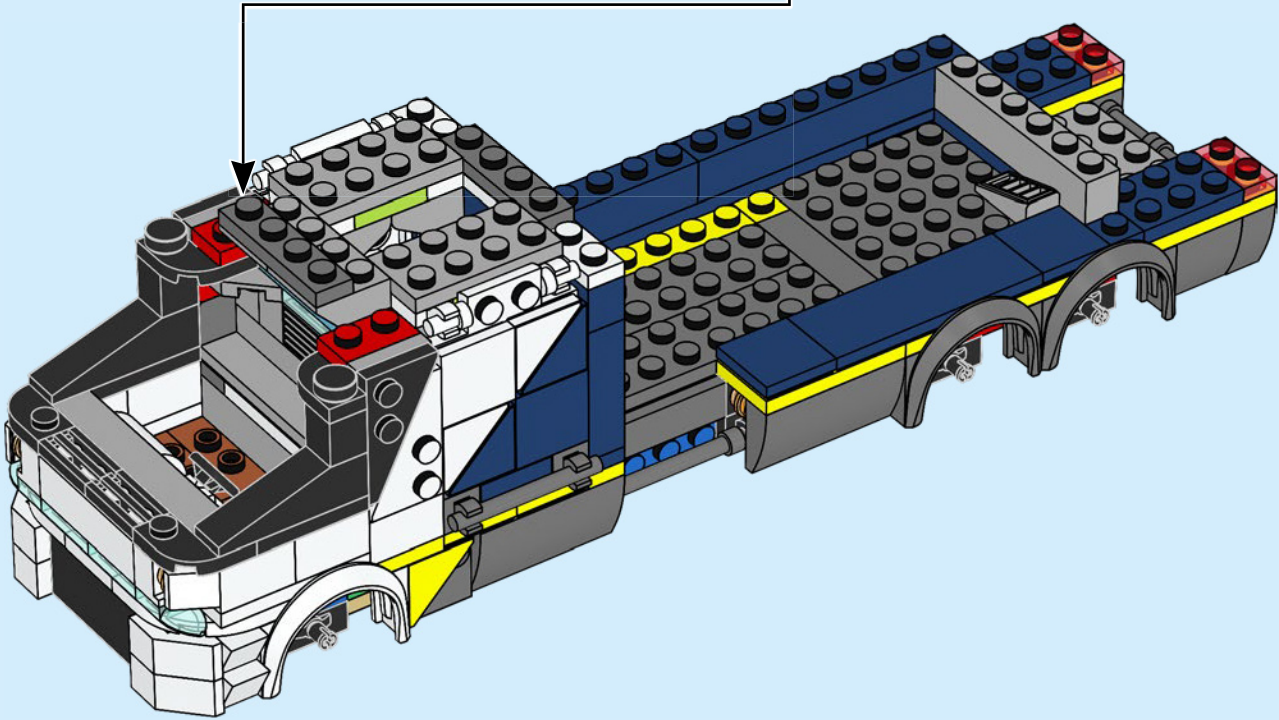
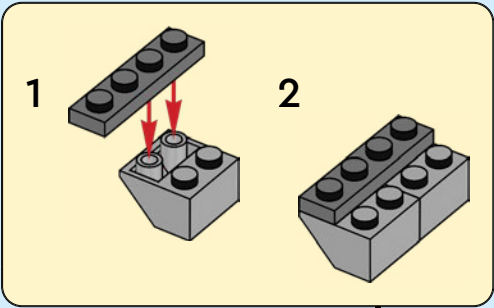



2x



4x

89

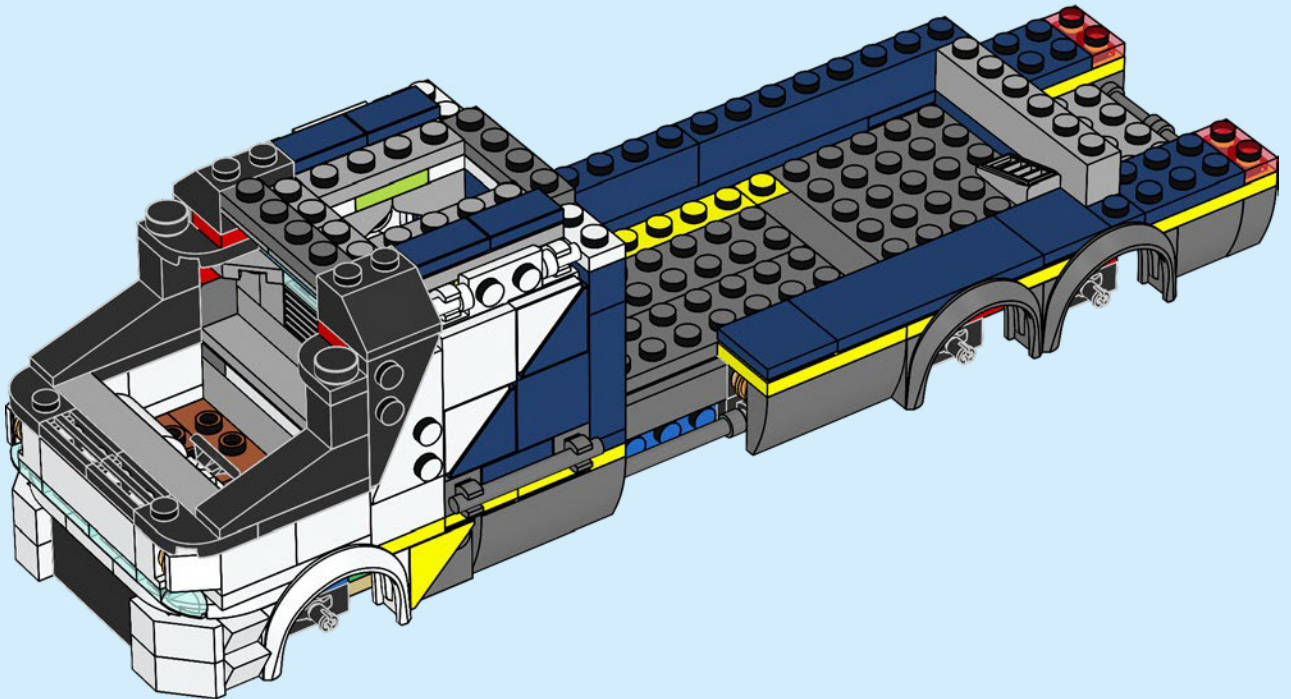

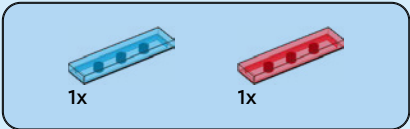

90

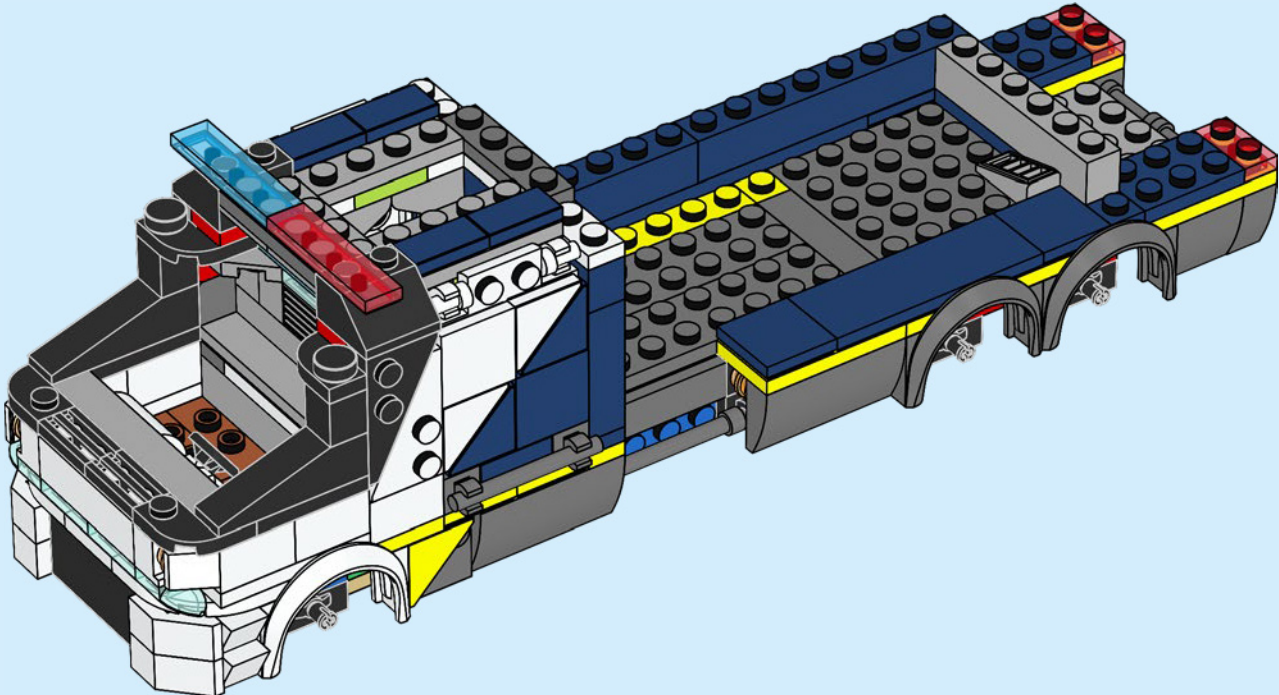

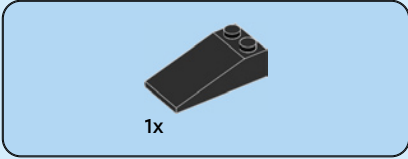

1x

91

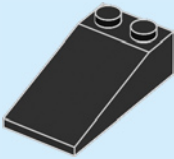

92

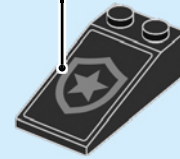

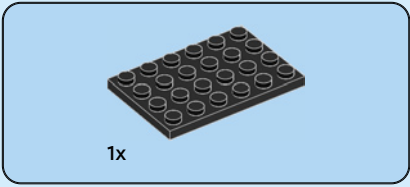

93

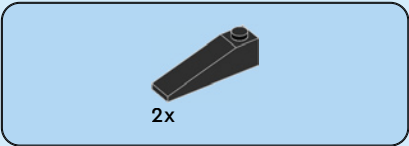
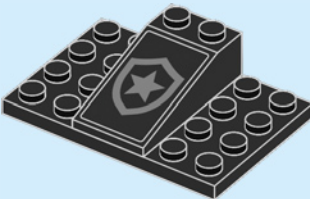

94

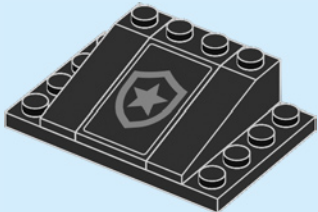

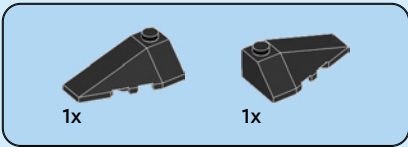

95

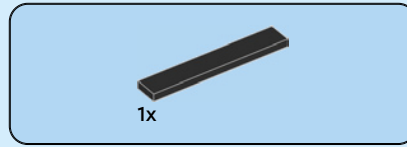
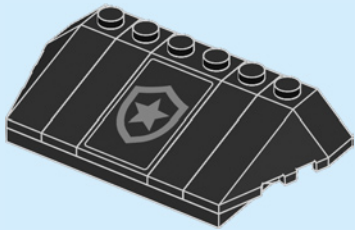

96

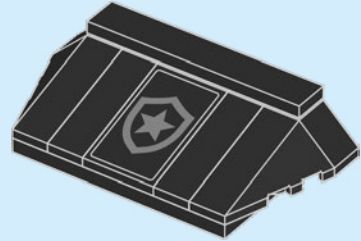



3x

97

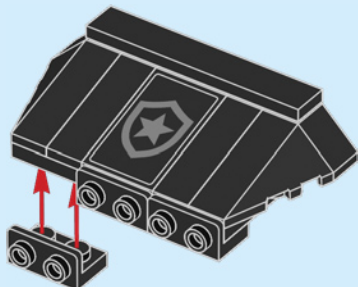

3x

98

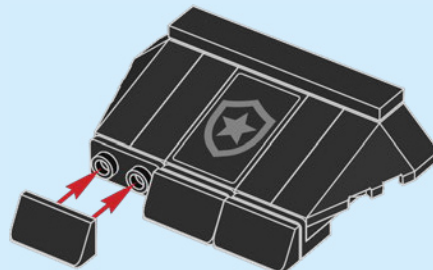



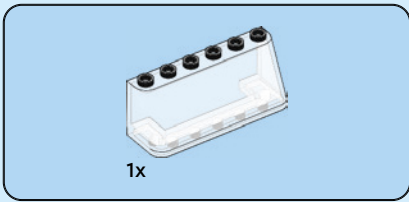

99

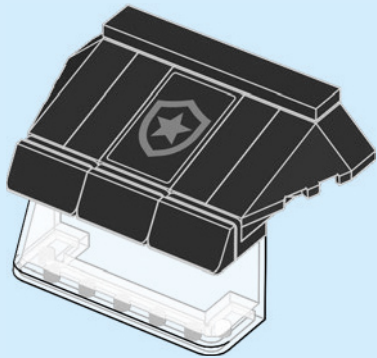

100

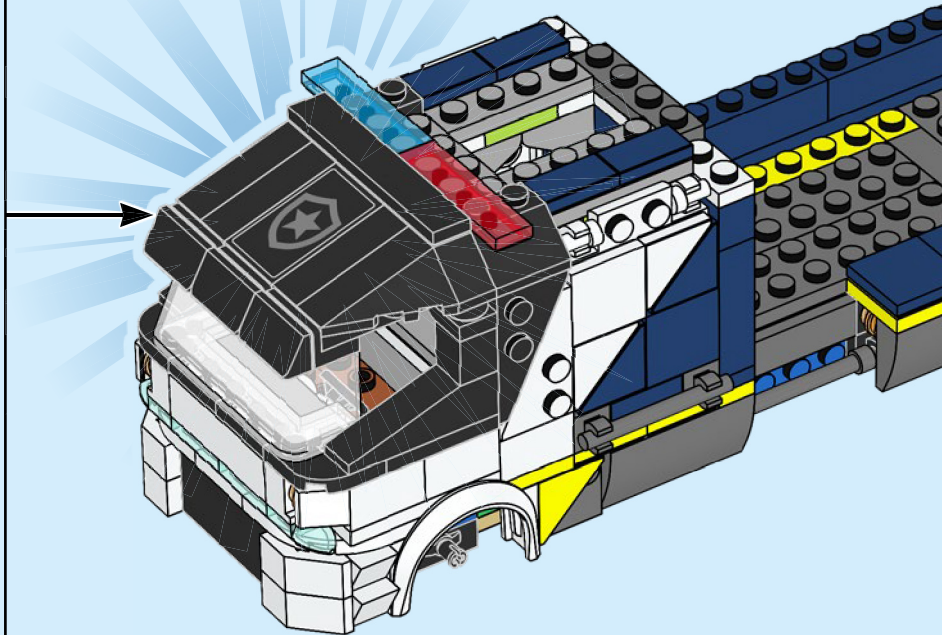

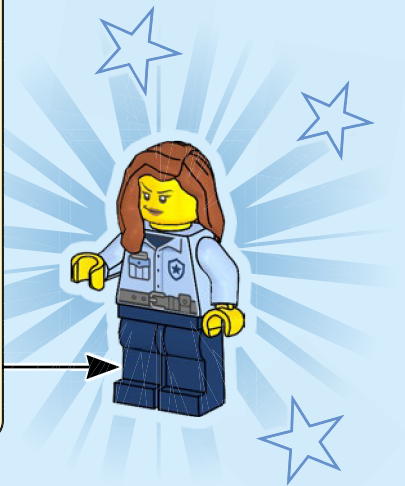
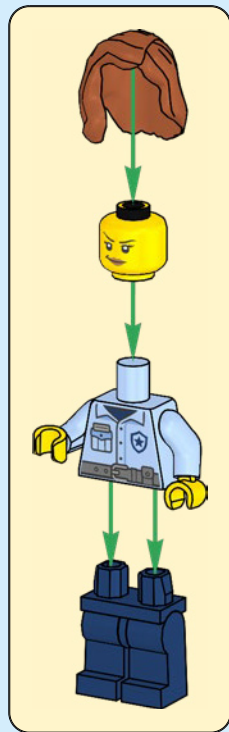

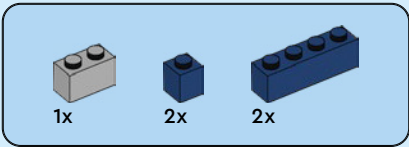

101

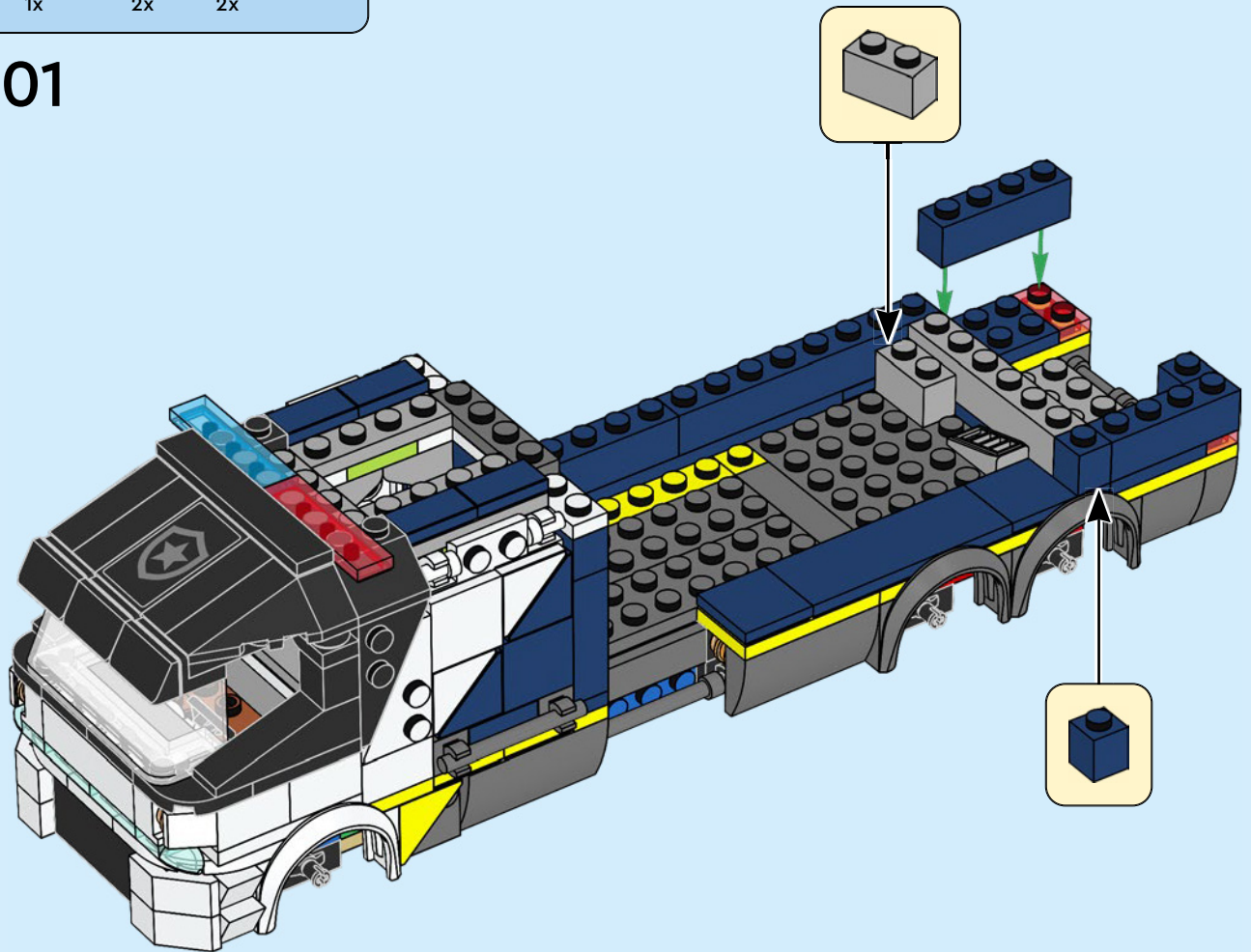



1x



1x

# 102

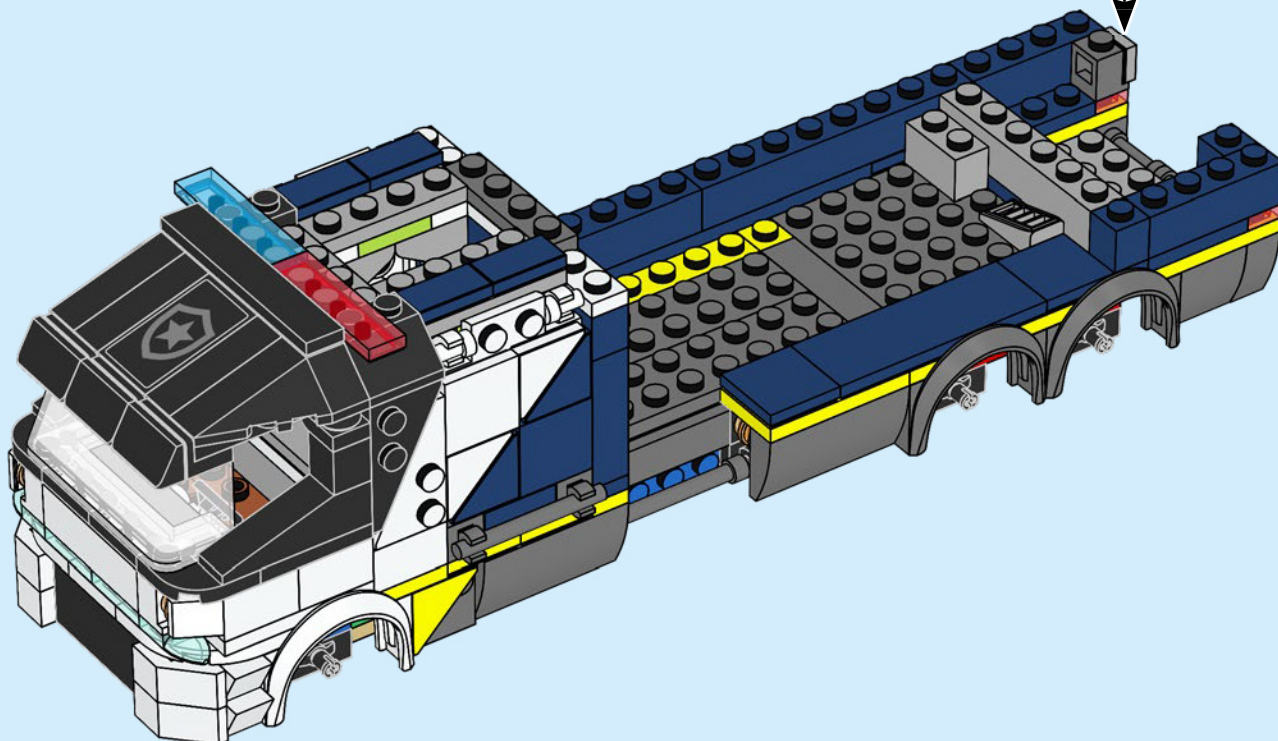
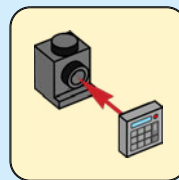



2x



2x

# 103

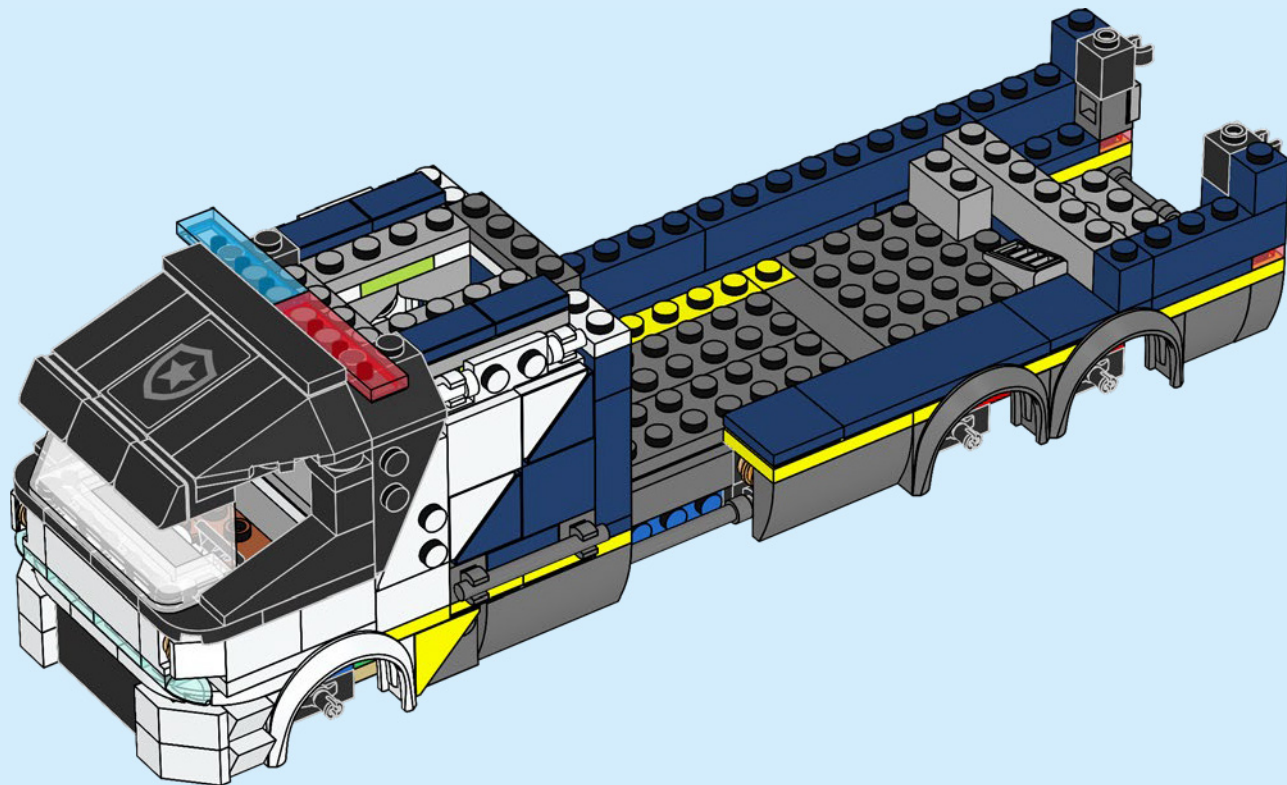

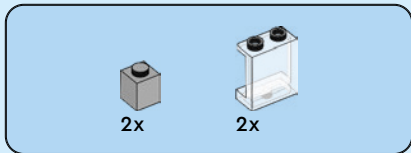

104

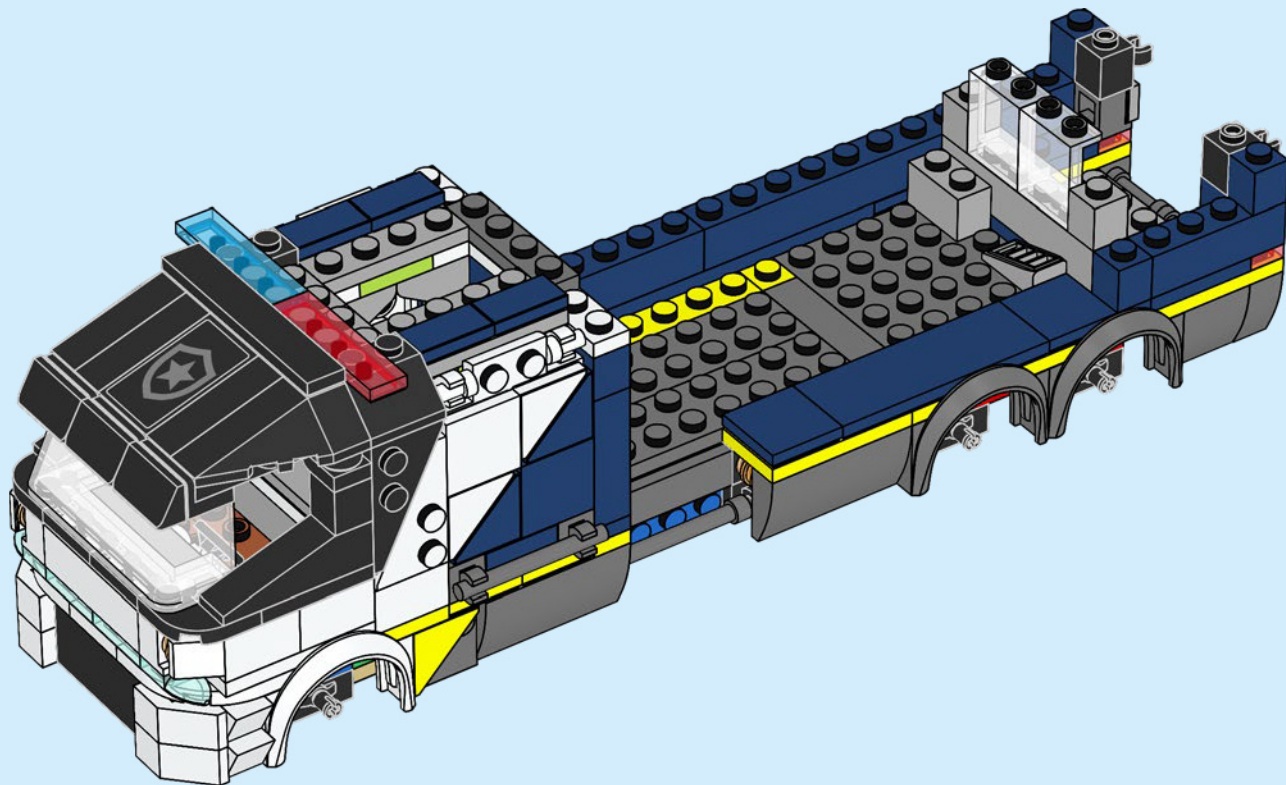



2x



2x

# 105

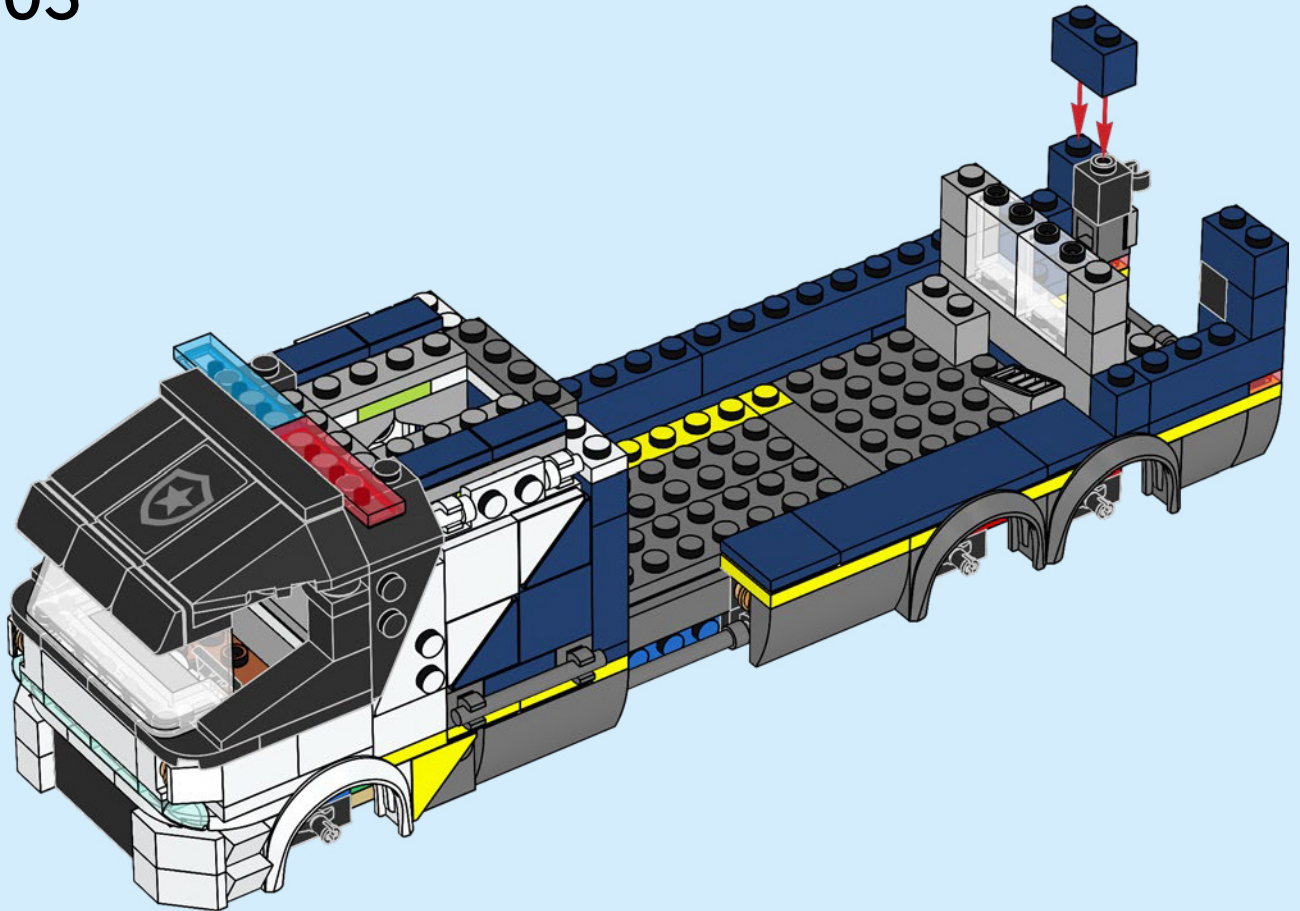

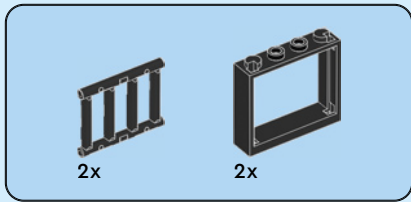

106

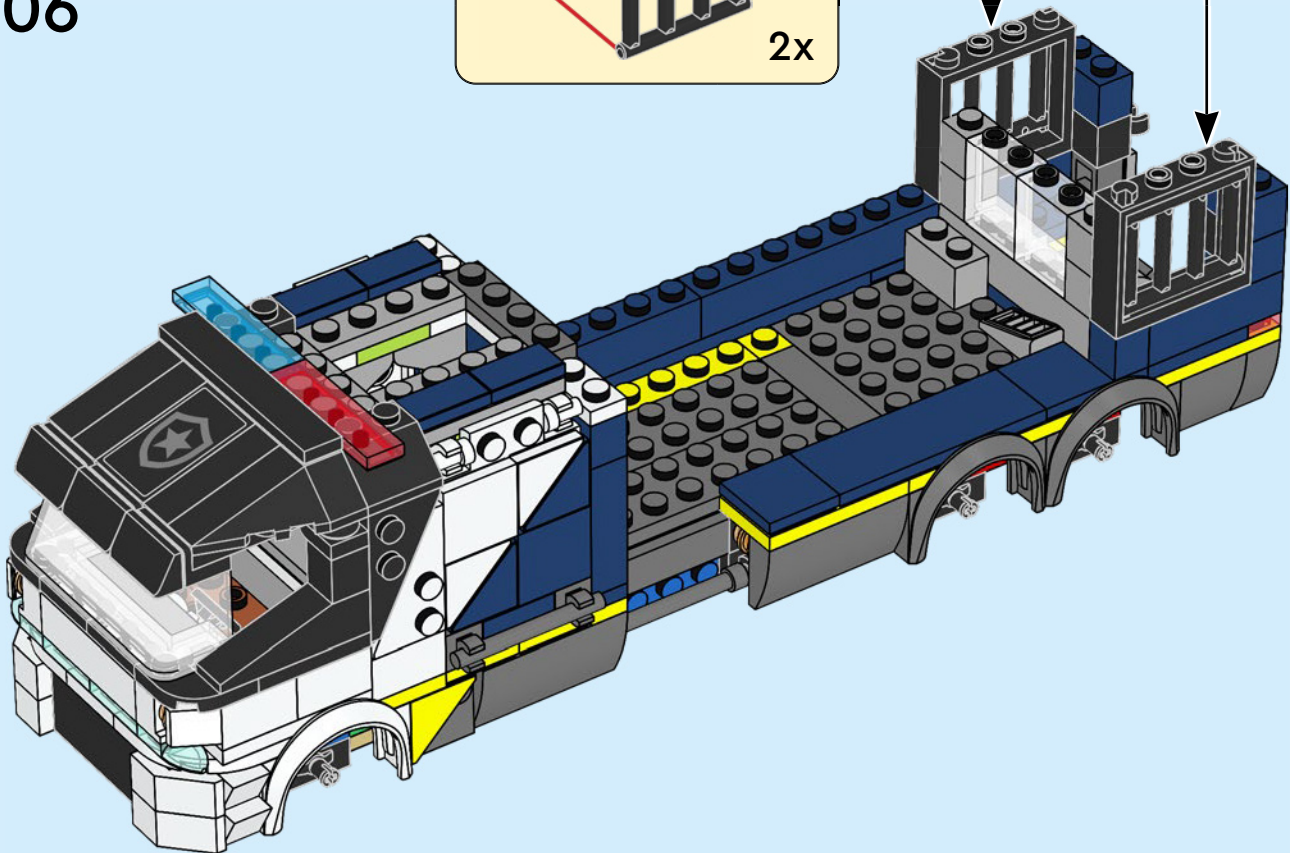
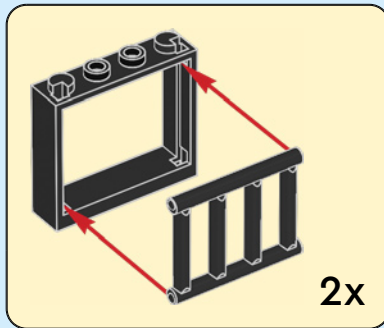





2x



2x

# 107

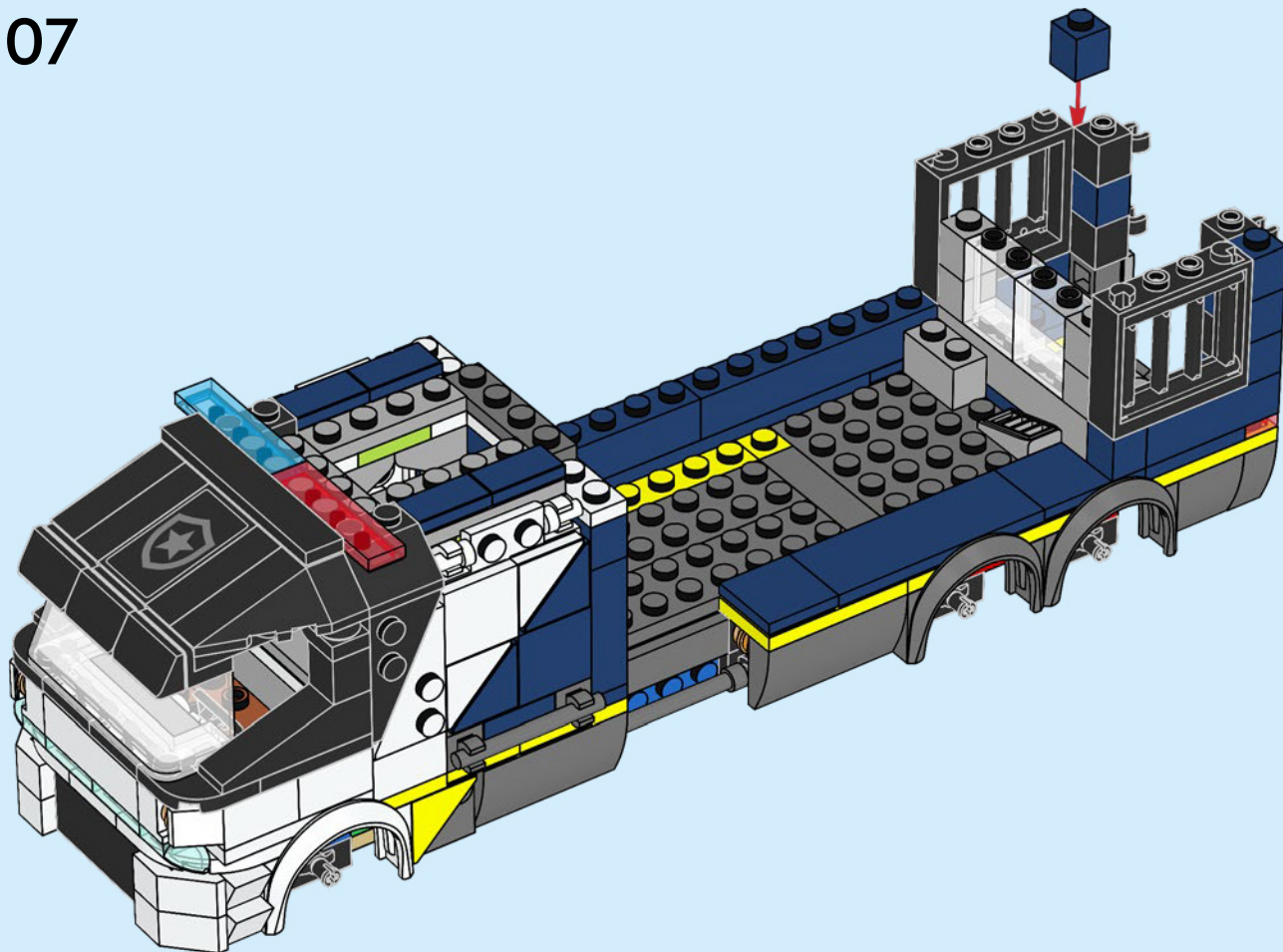



2x

108

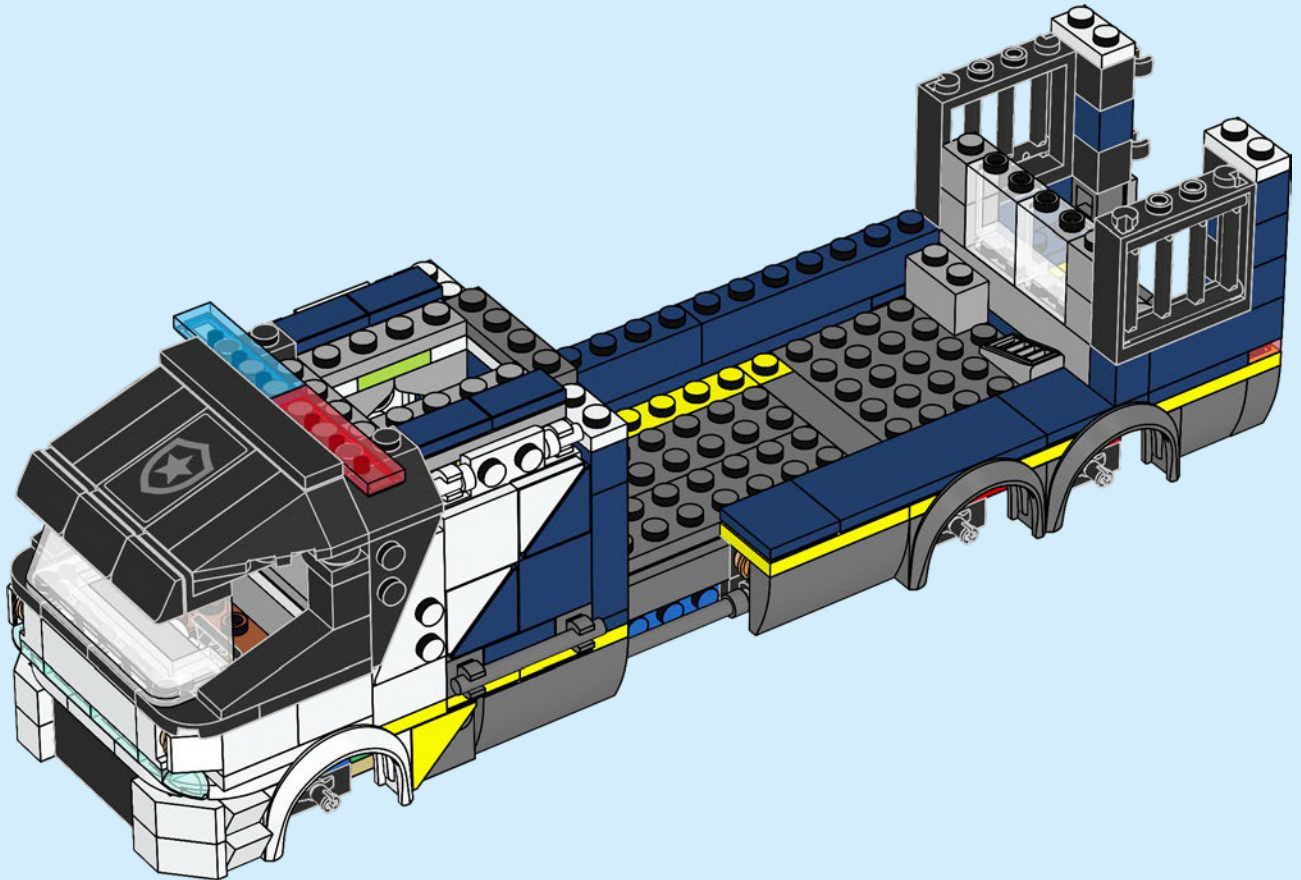

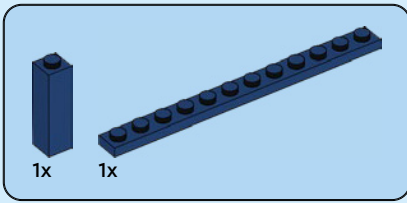

109

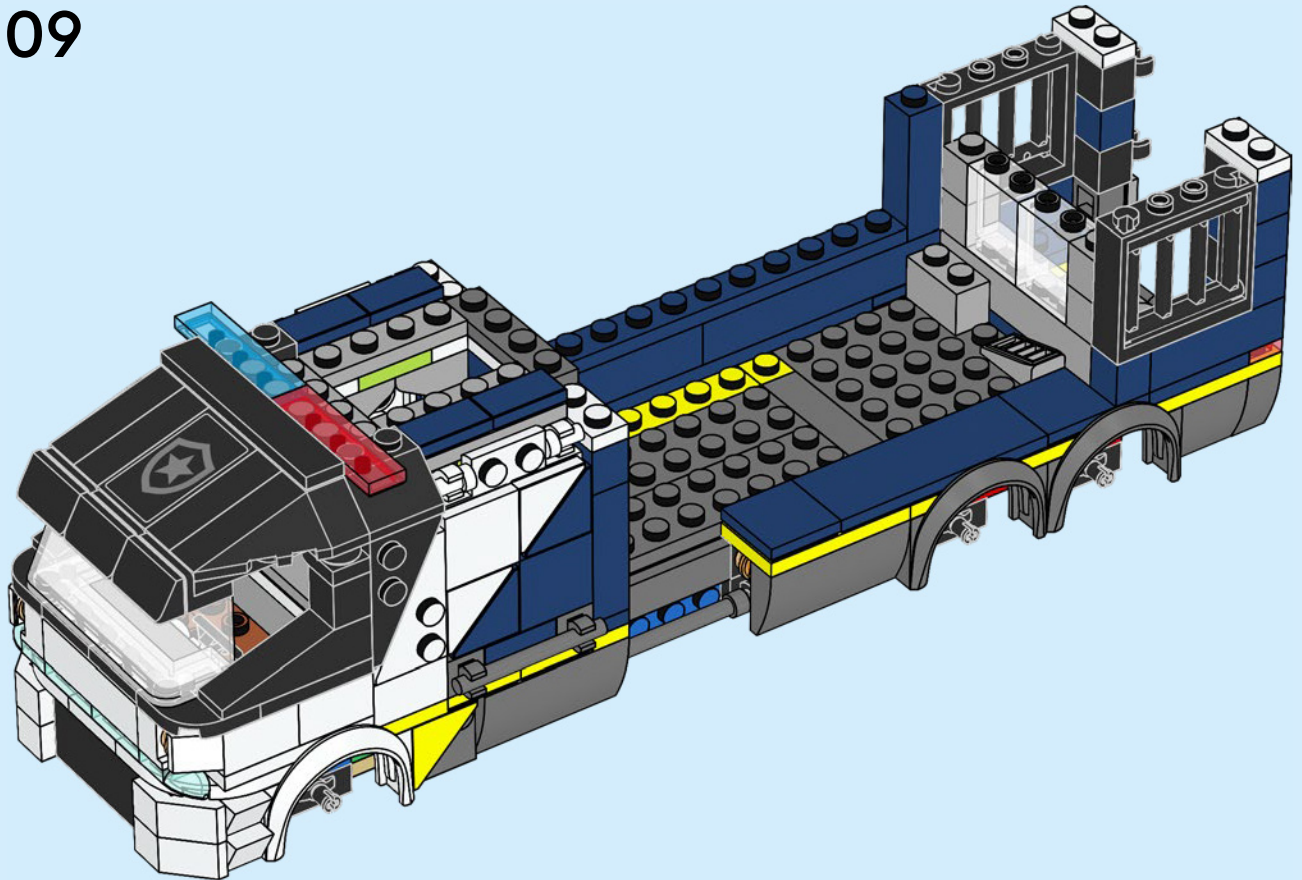

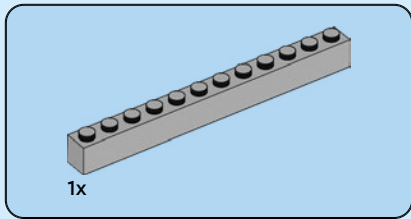

110

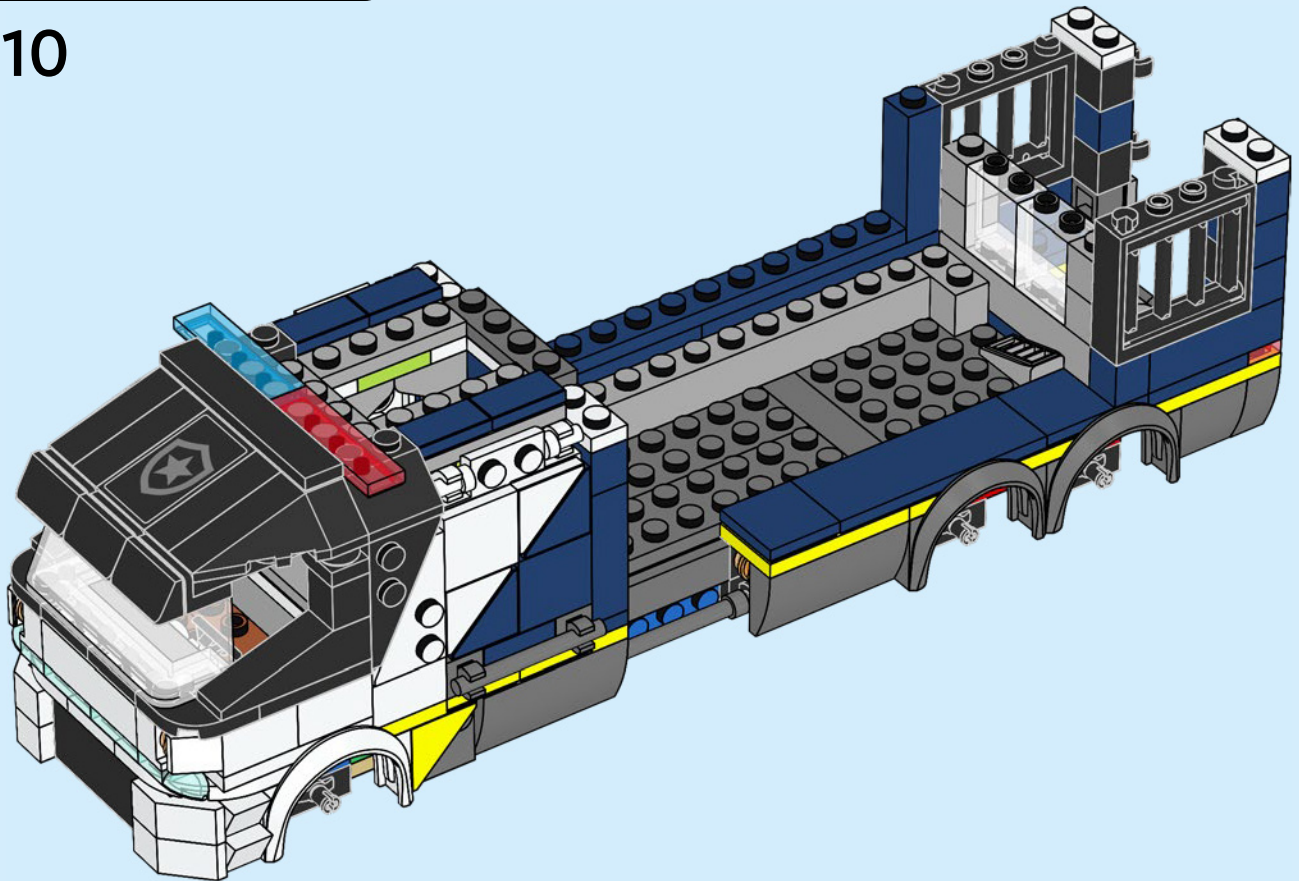

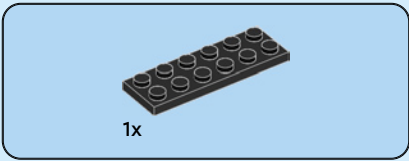

111

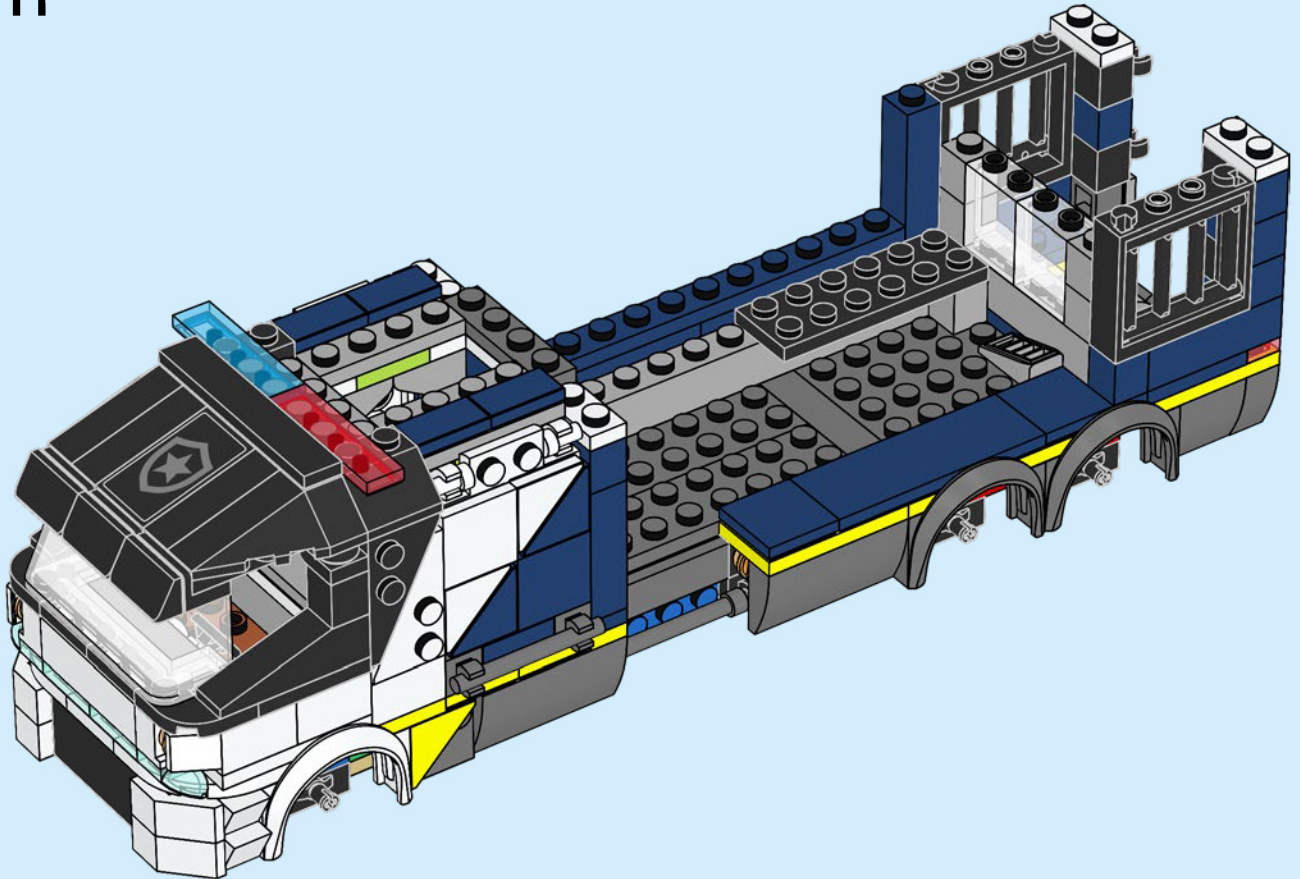



1x

112

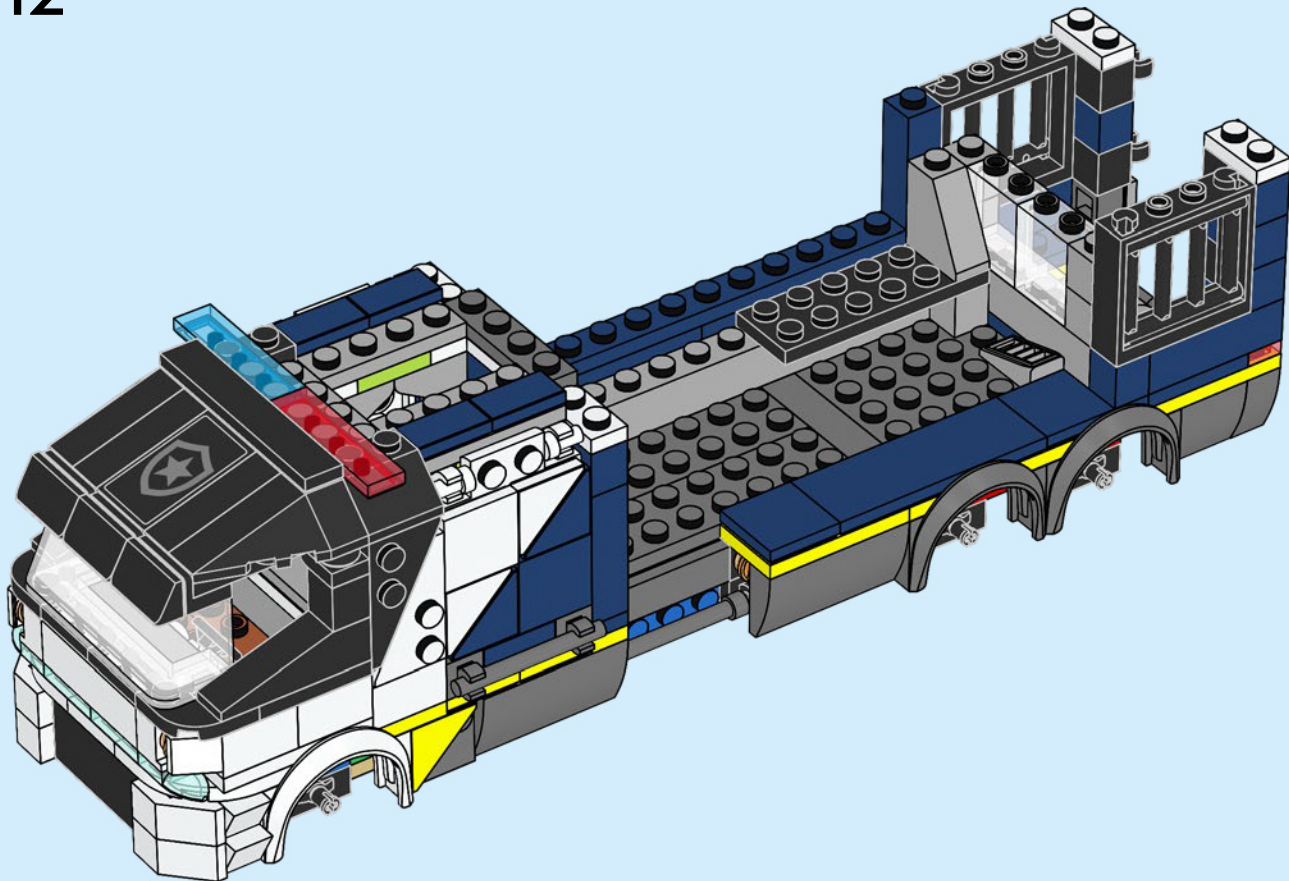

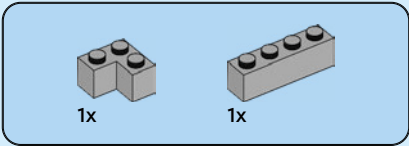

113

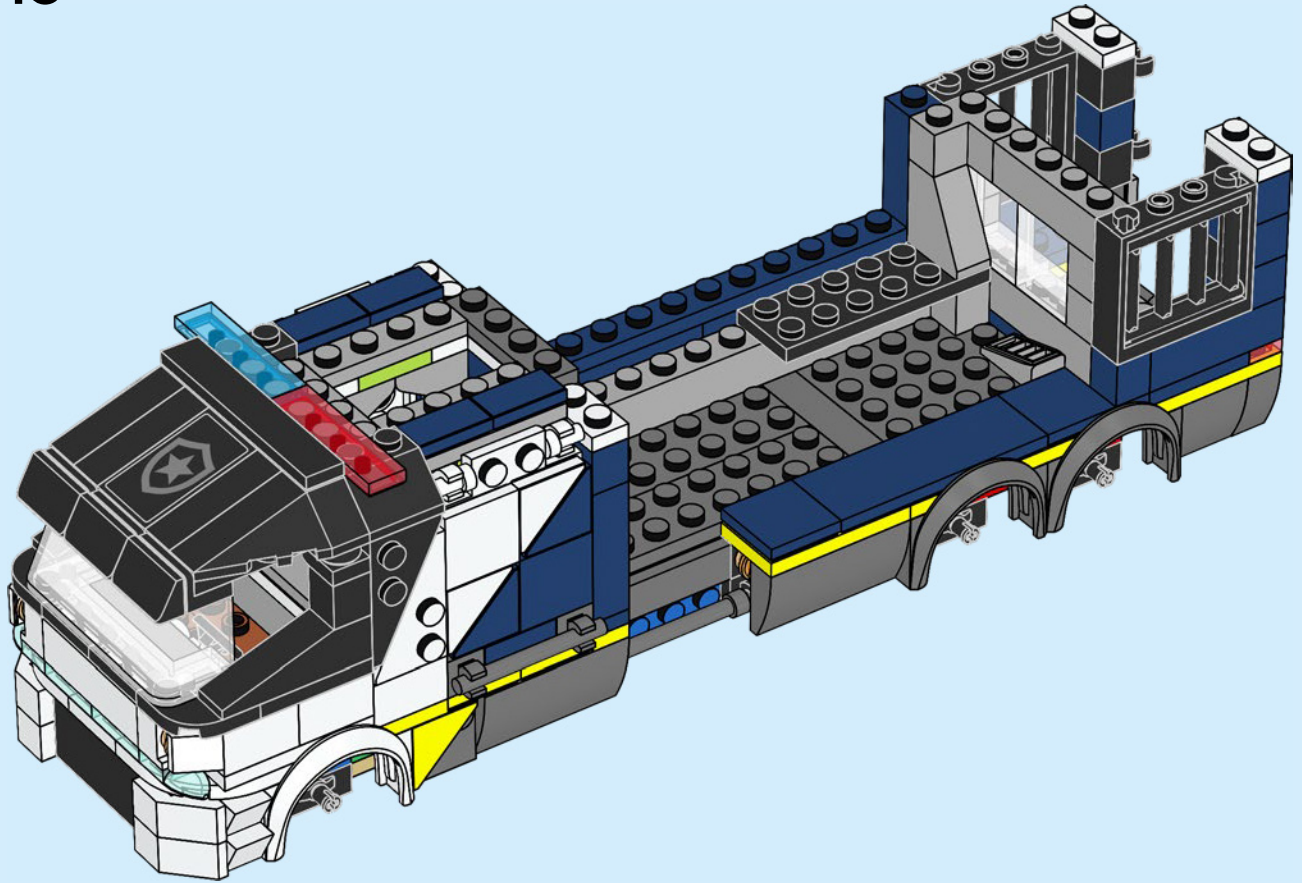

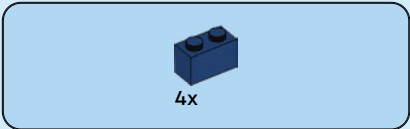

114

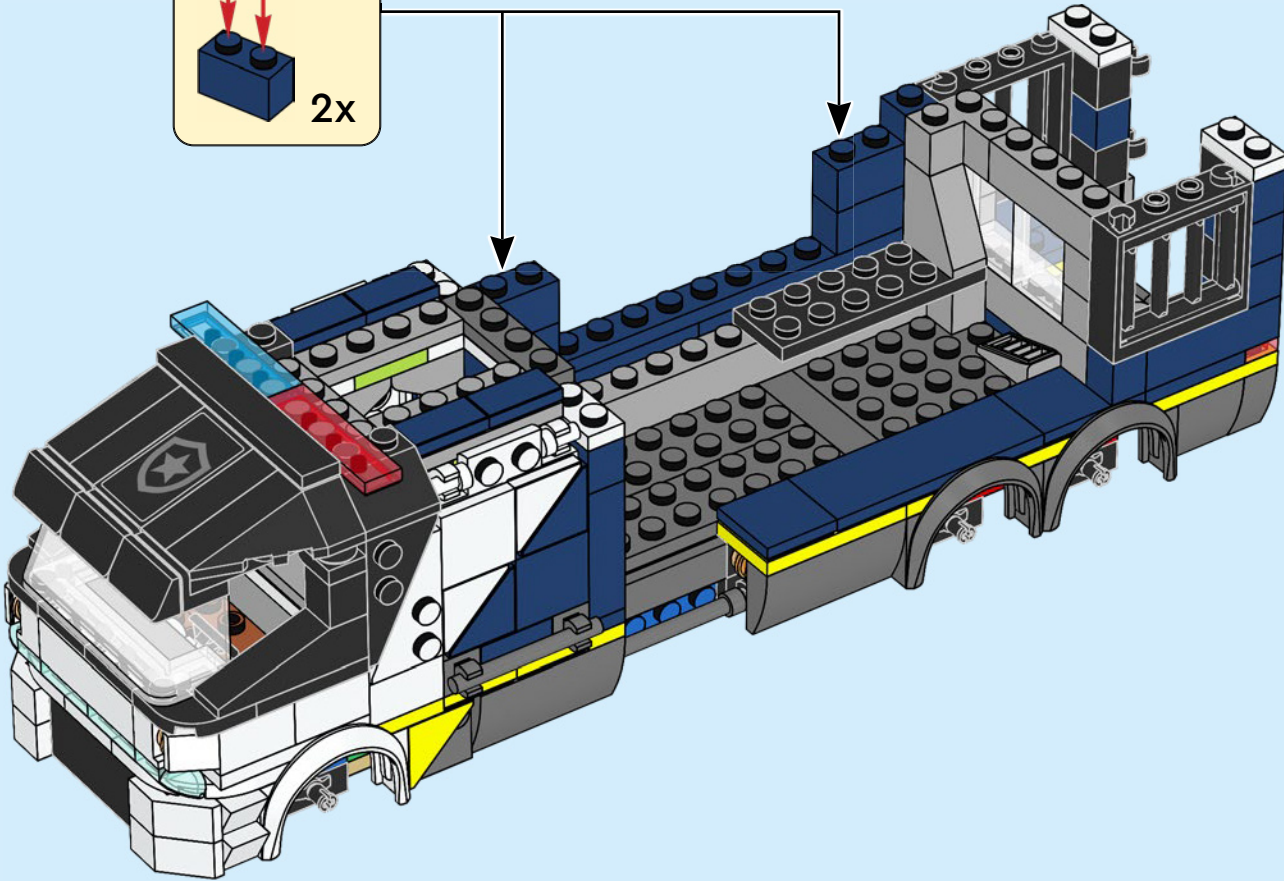
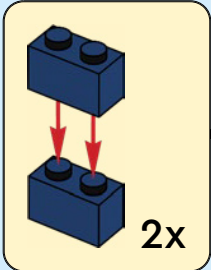



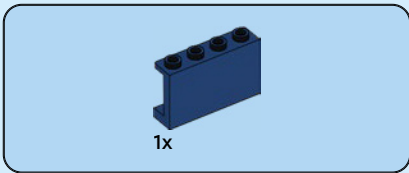

115

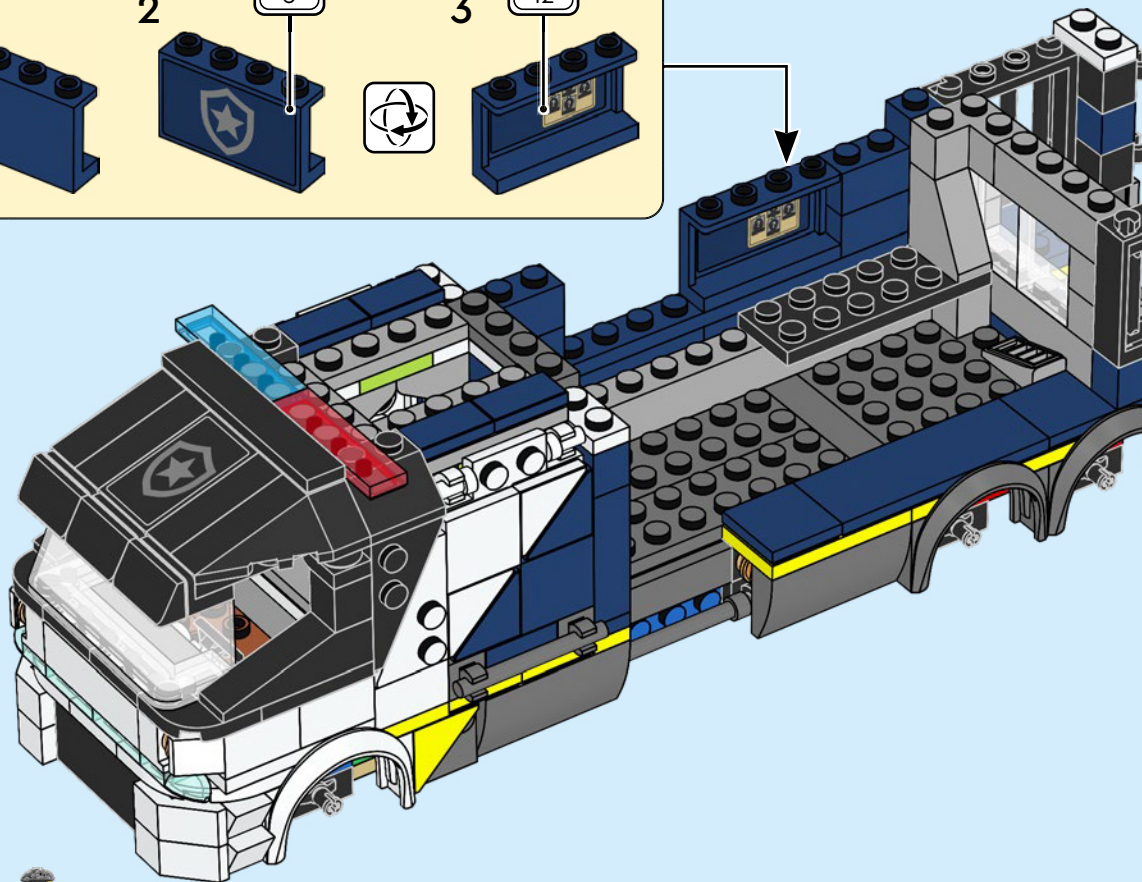
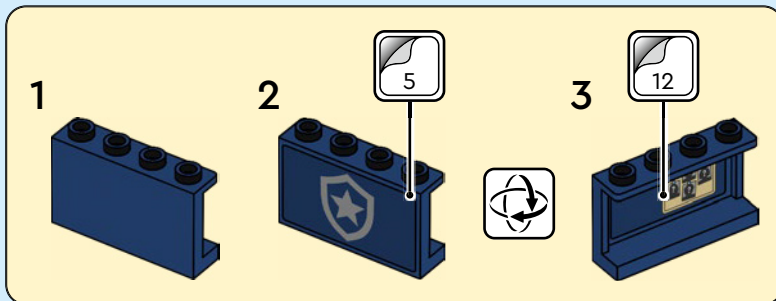

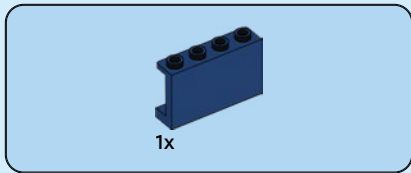

116

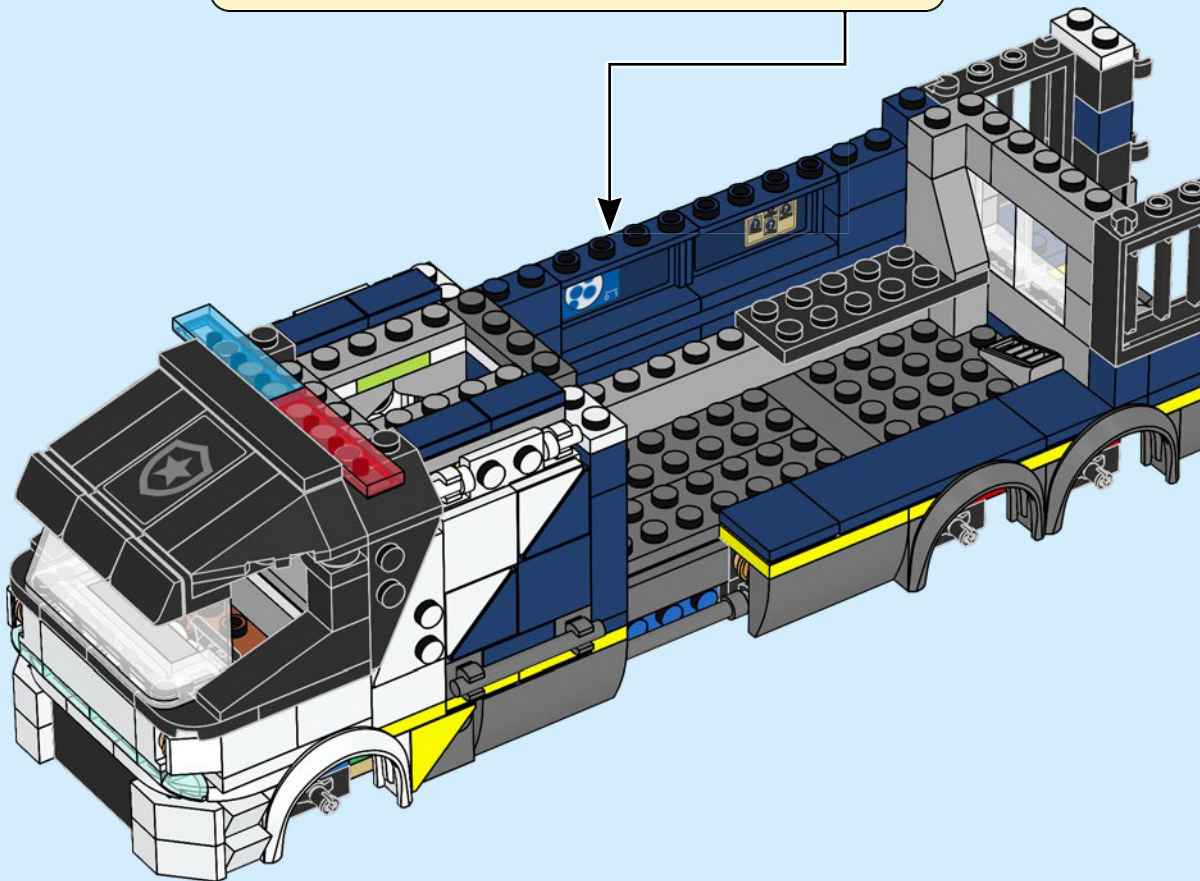
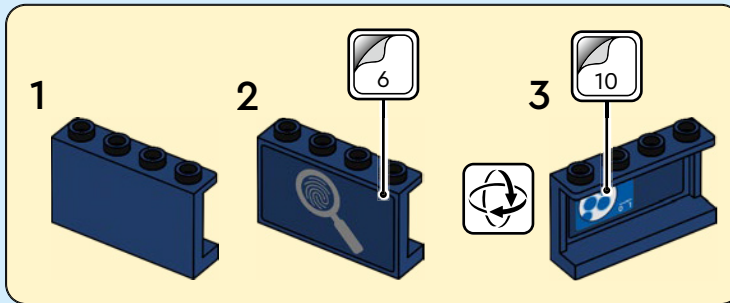

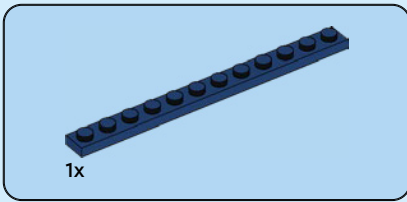

117

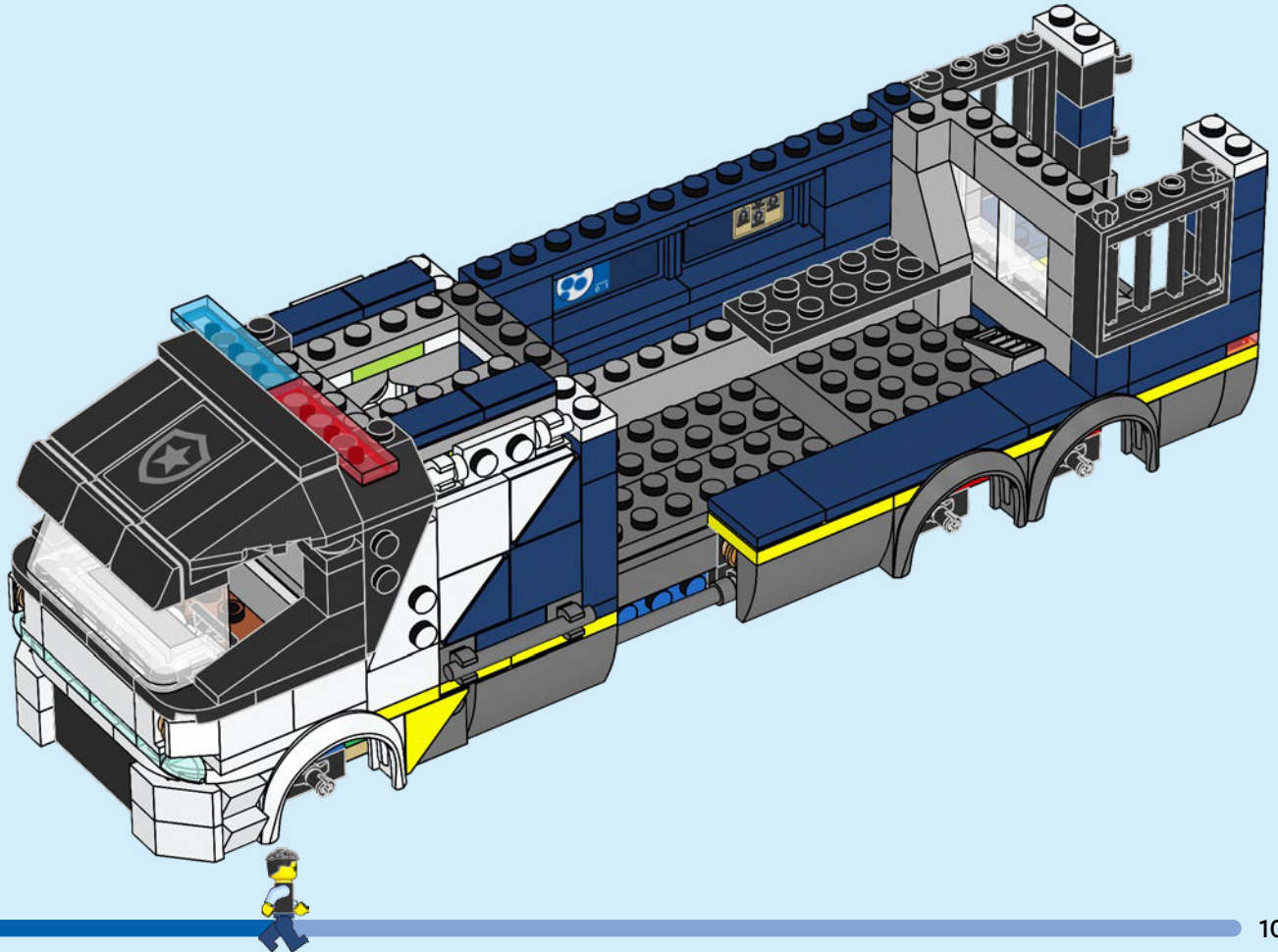



1x



1x

118

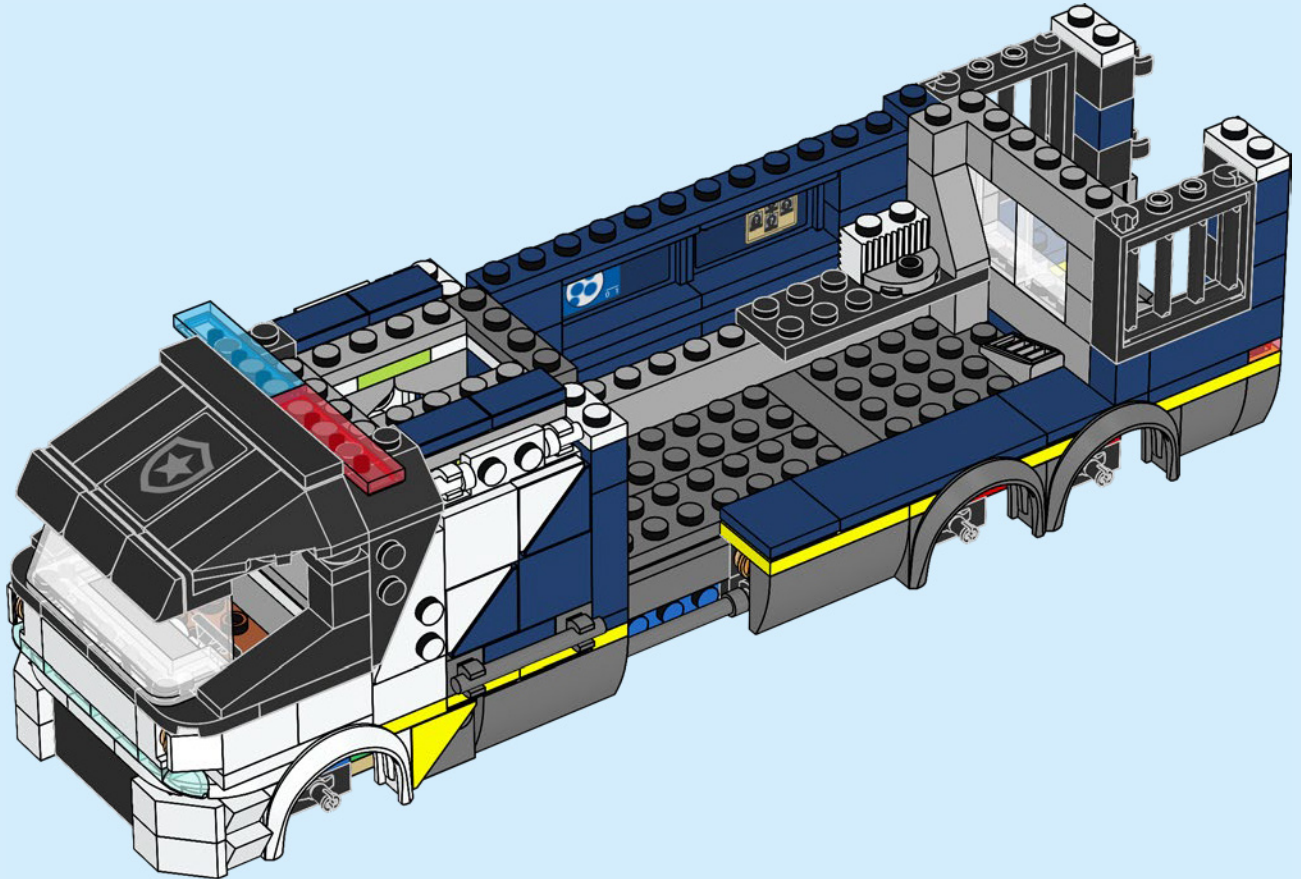



1x



1x

119

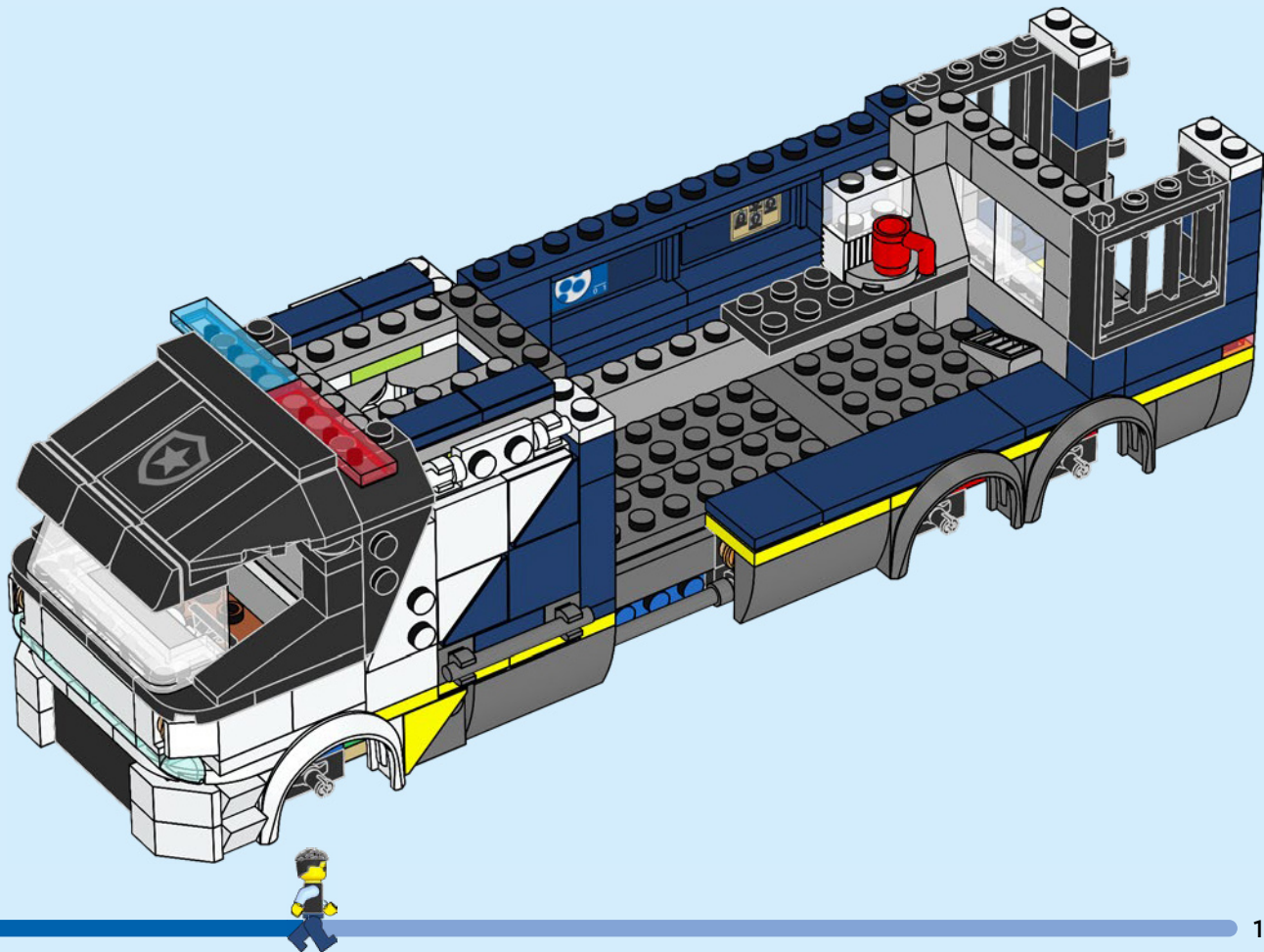

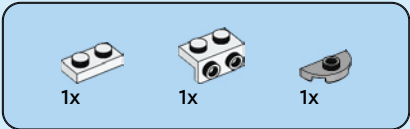

120

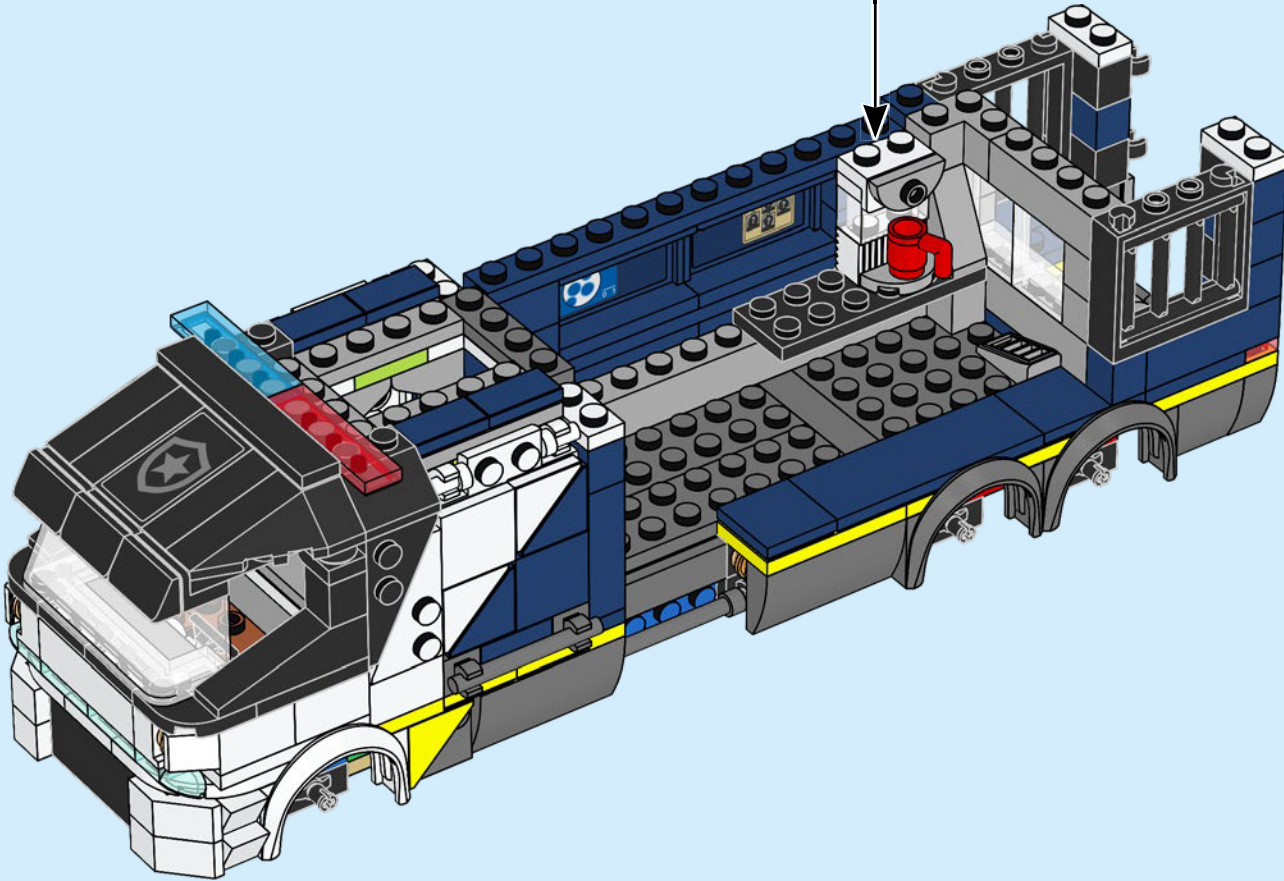
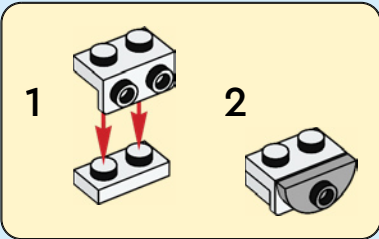



1x



1x

121

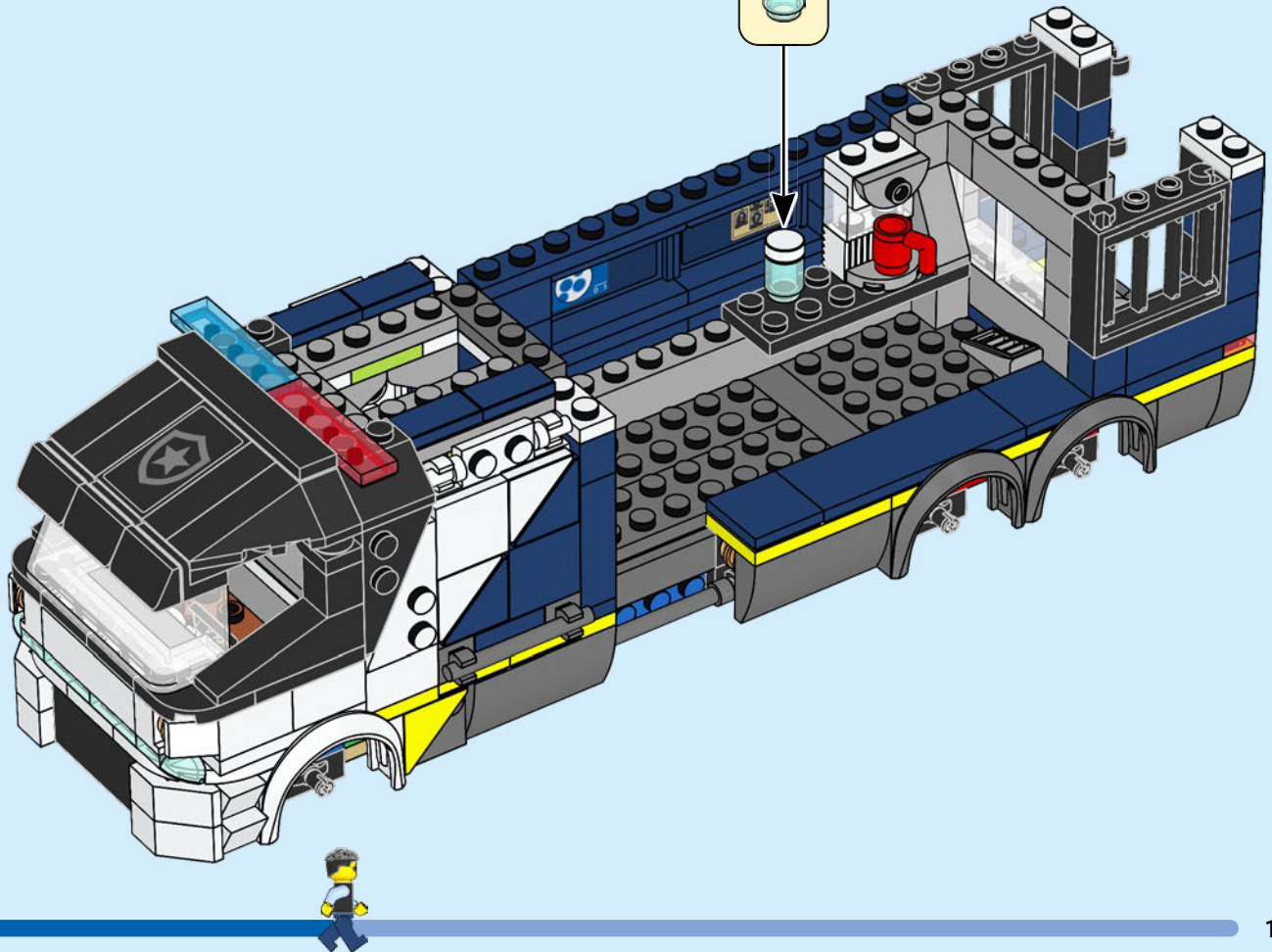
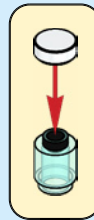



1x

122

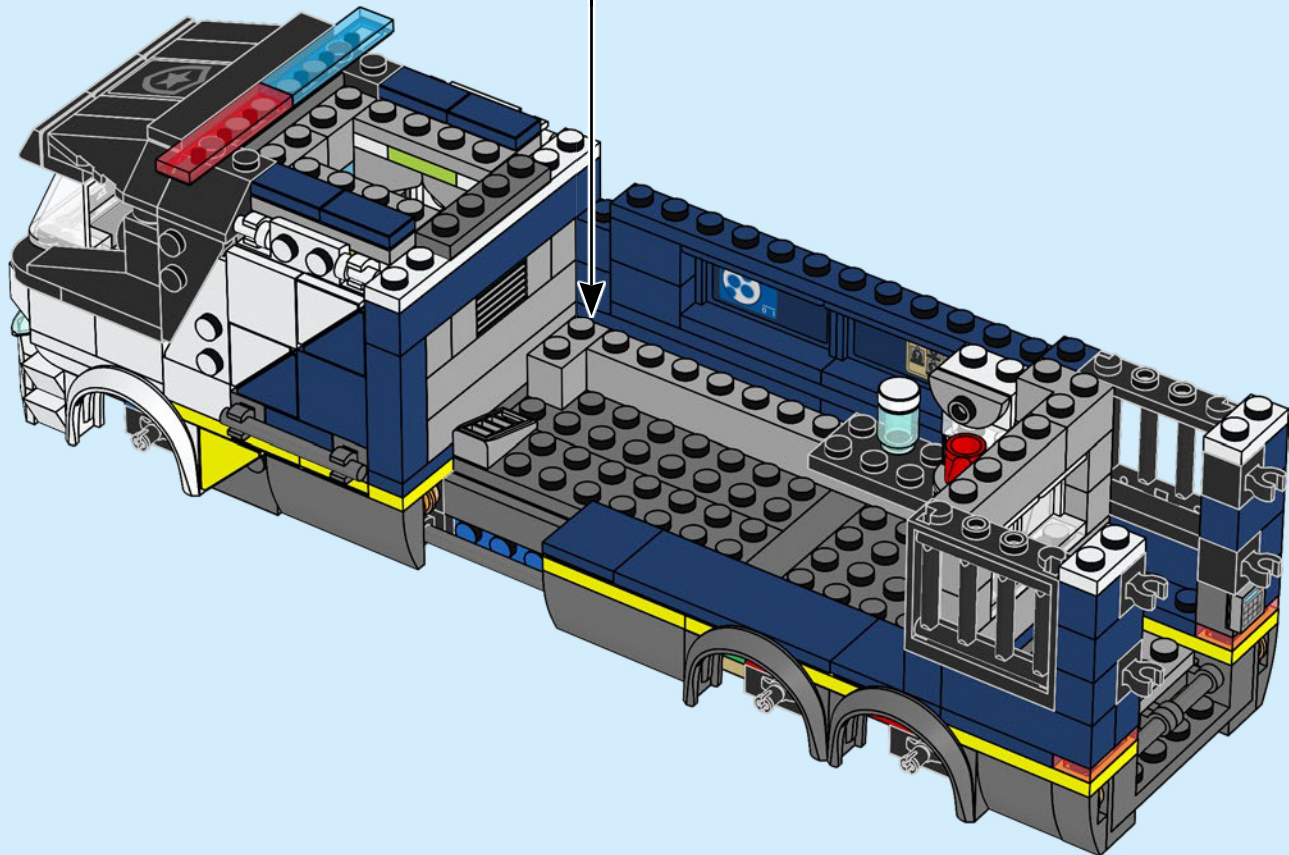
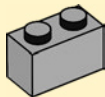



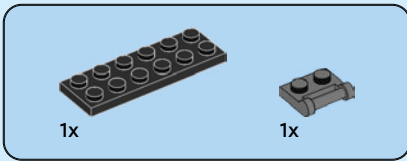

123

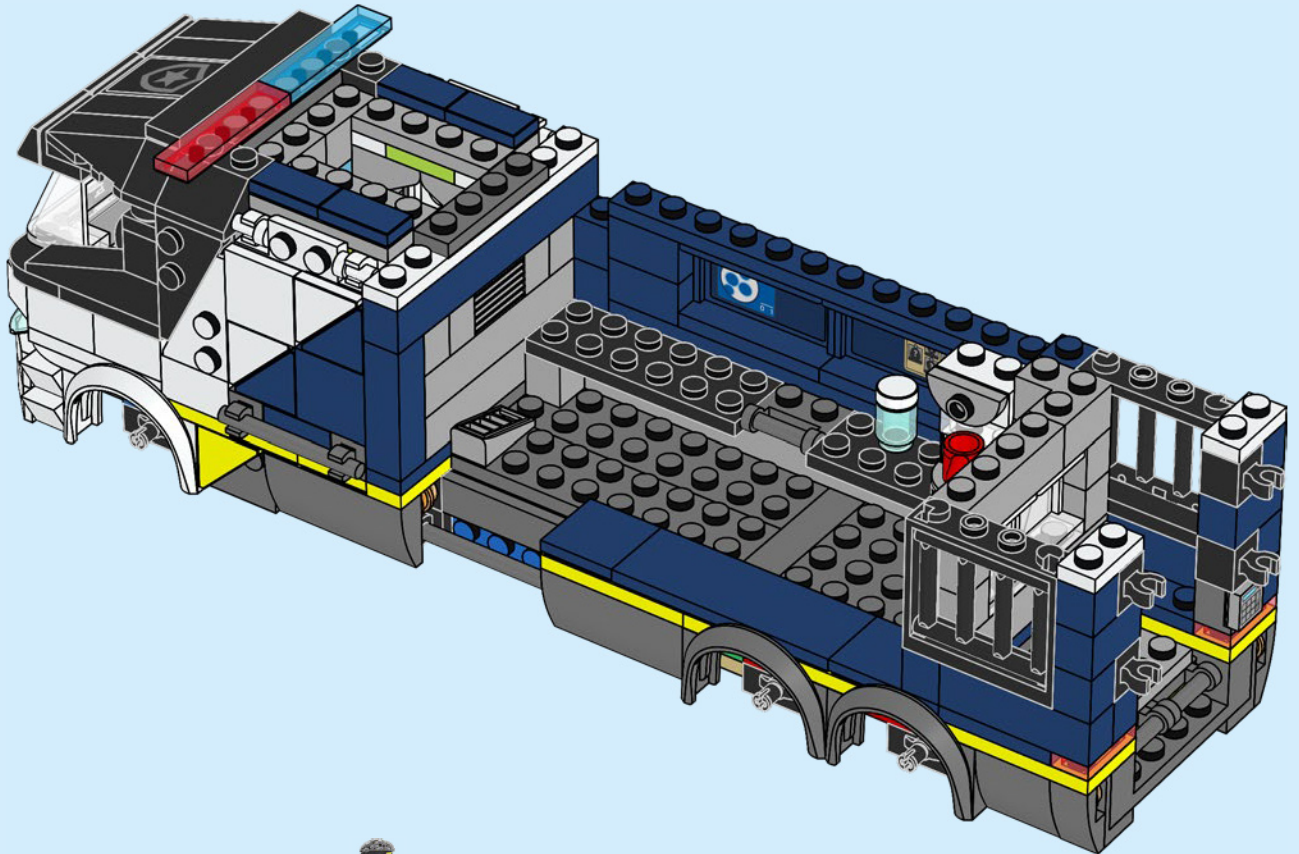



1x

124

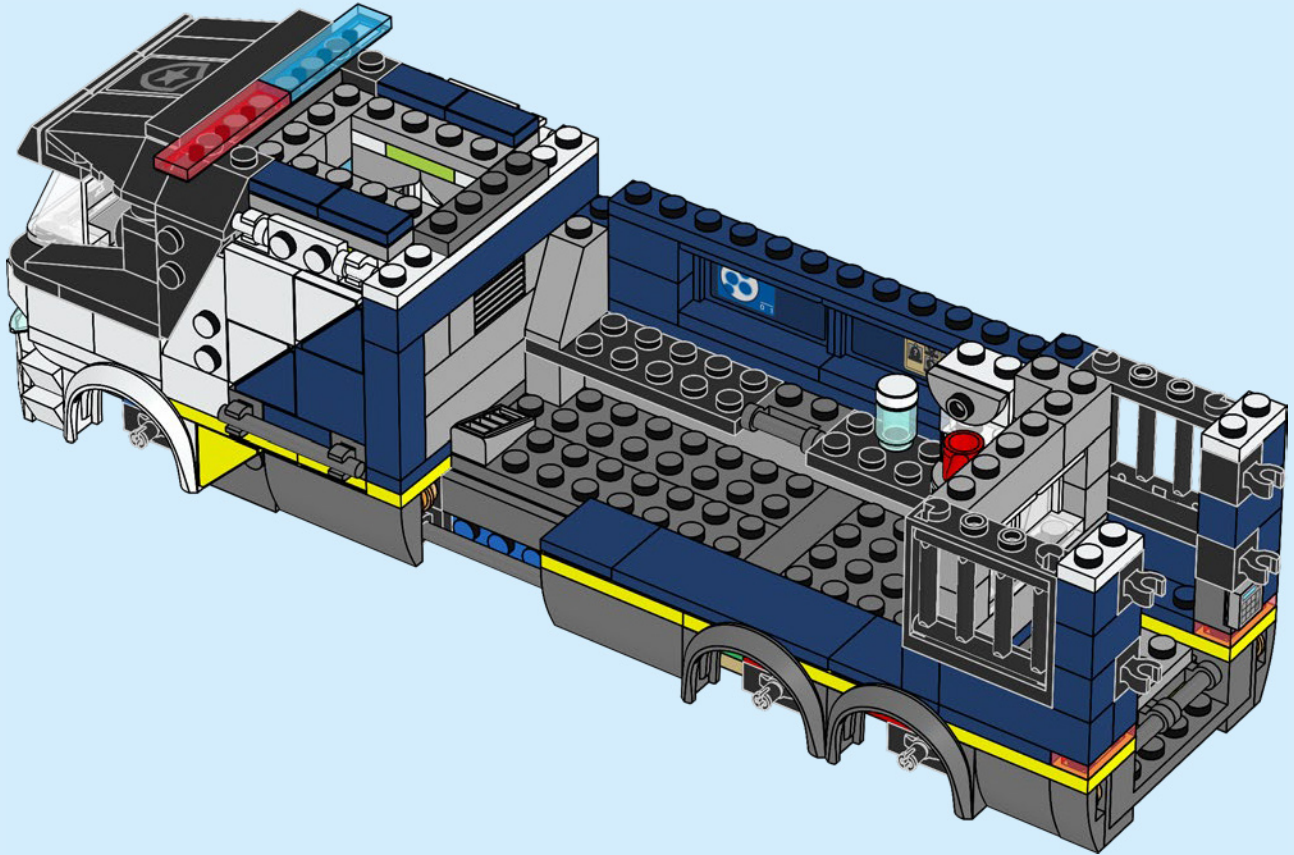

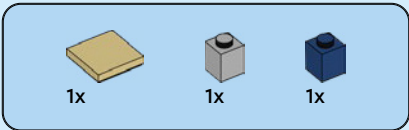

125

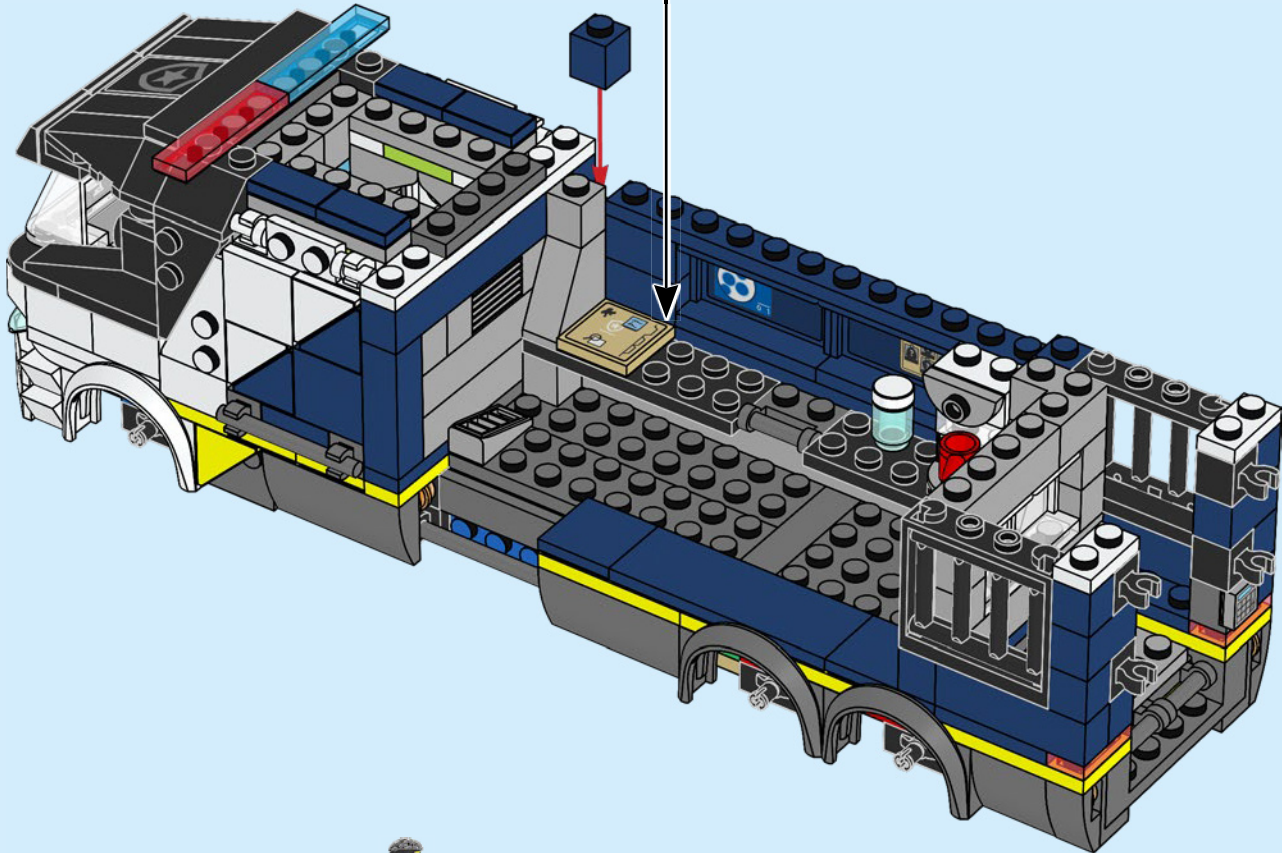
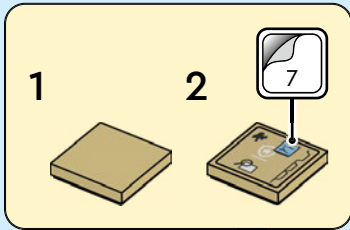

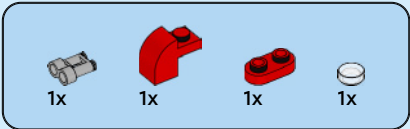

126

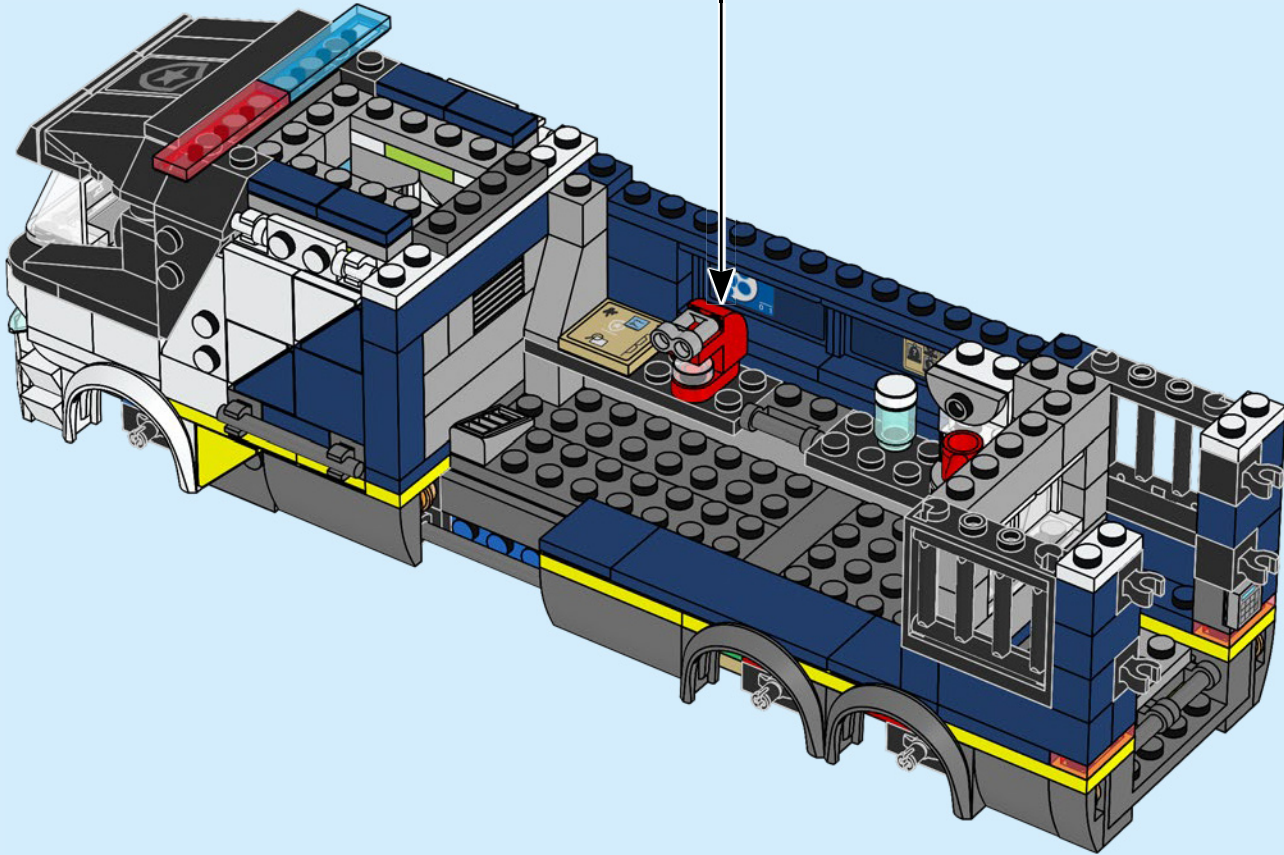
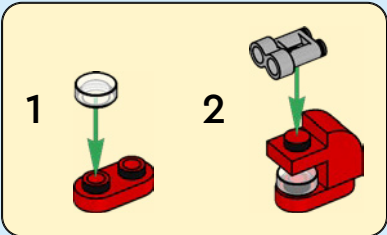

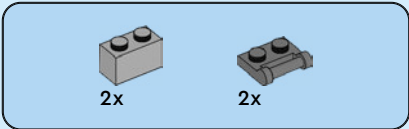

127

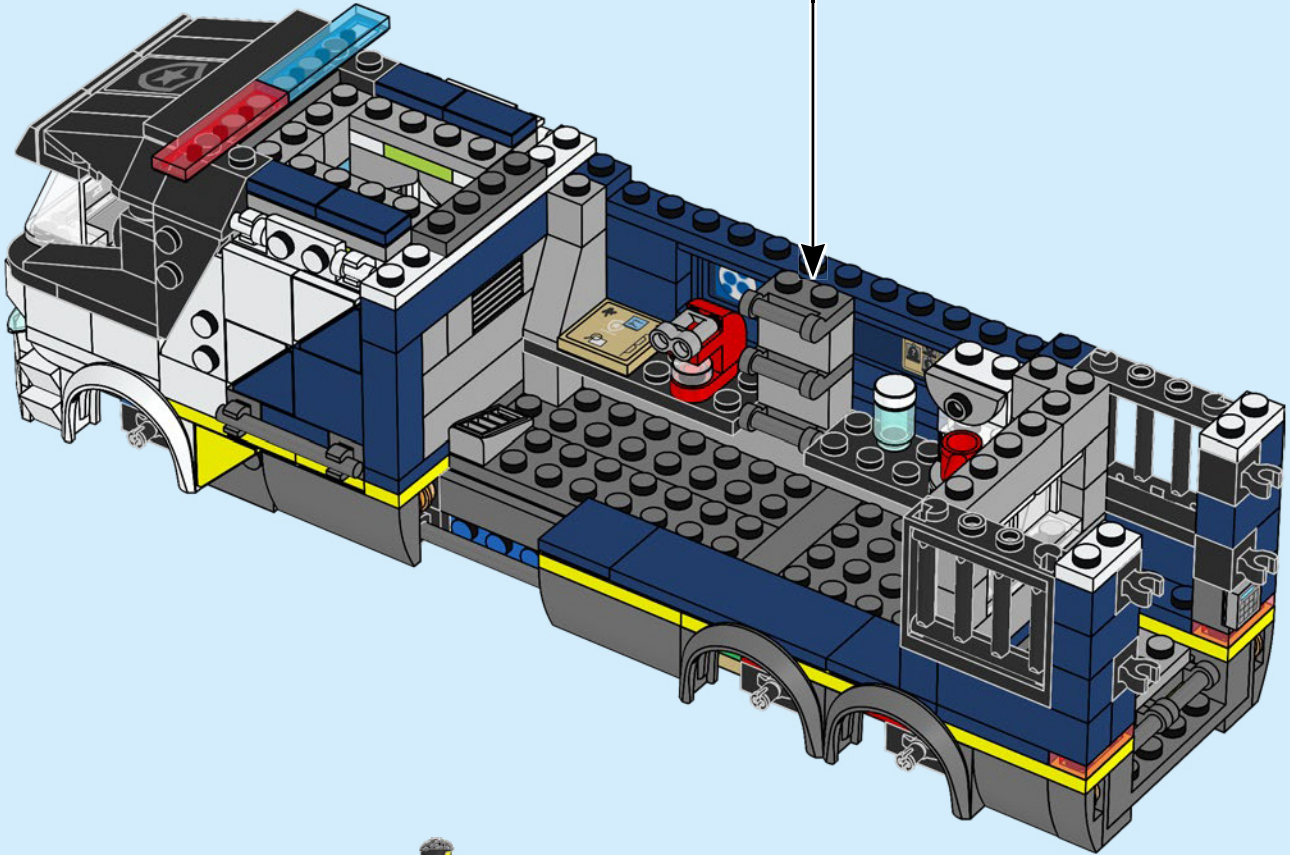
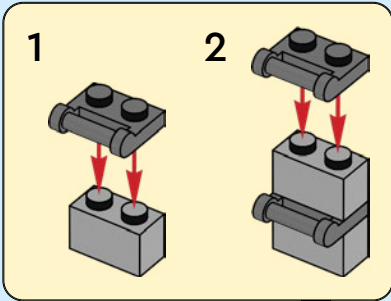

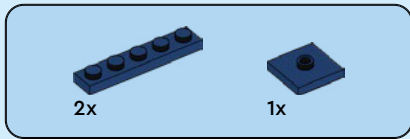

128

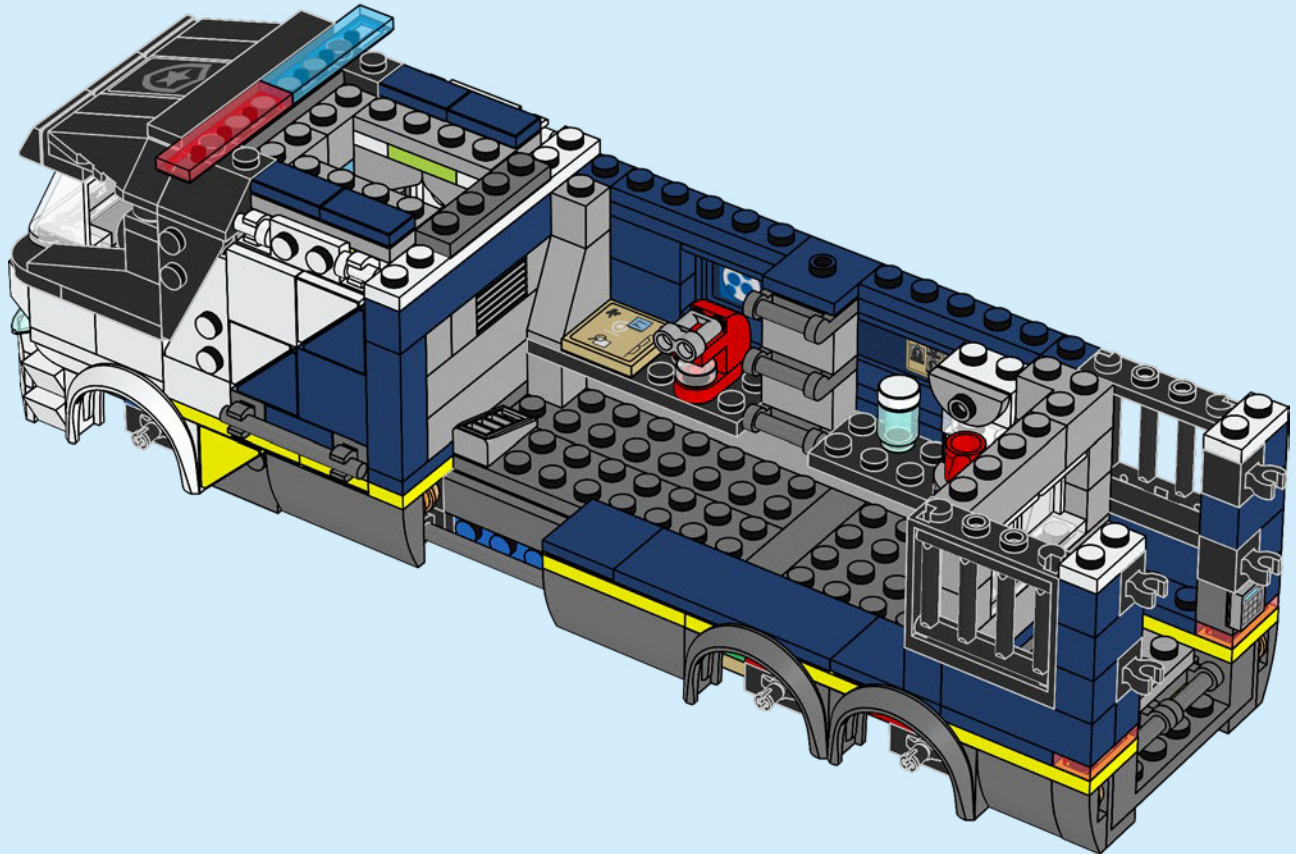

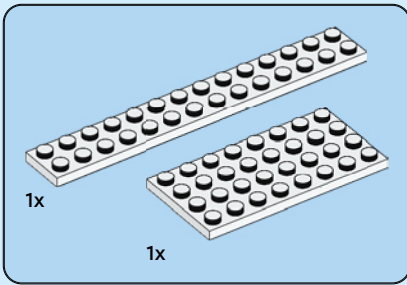

129

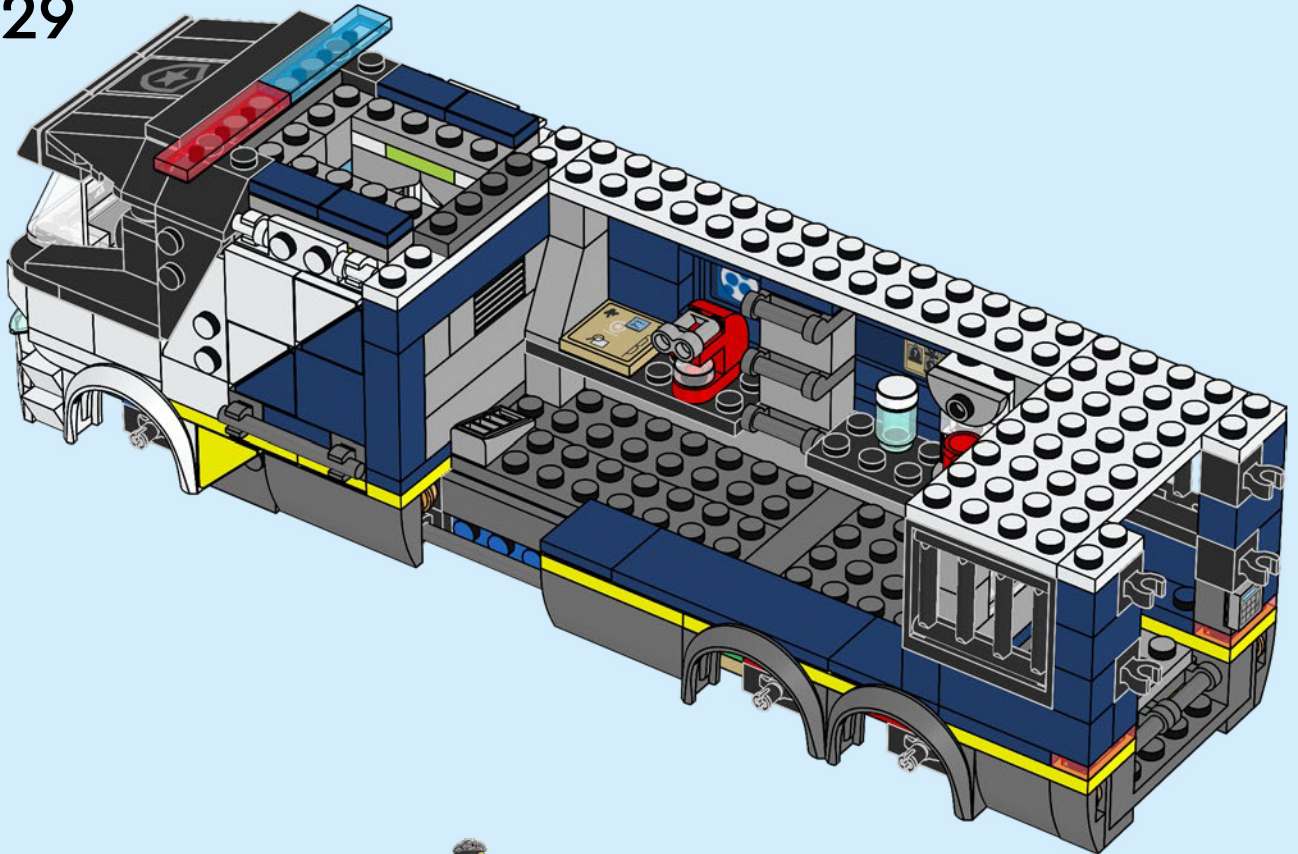

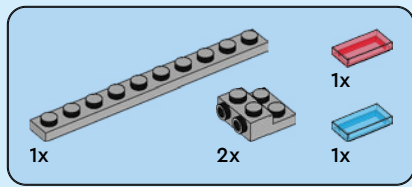

130

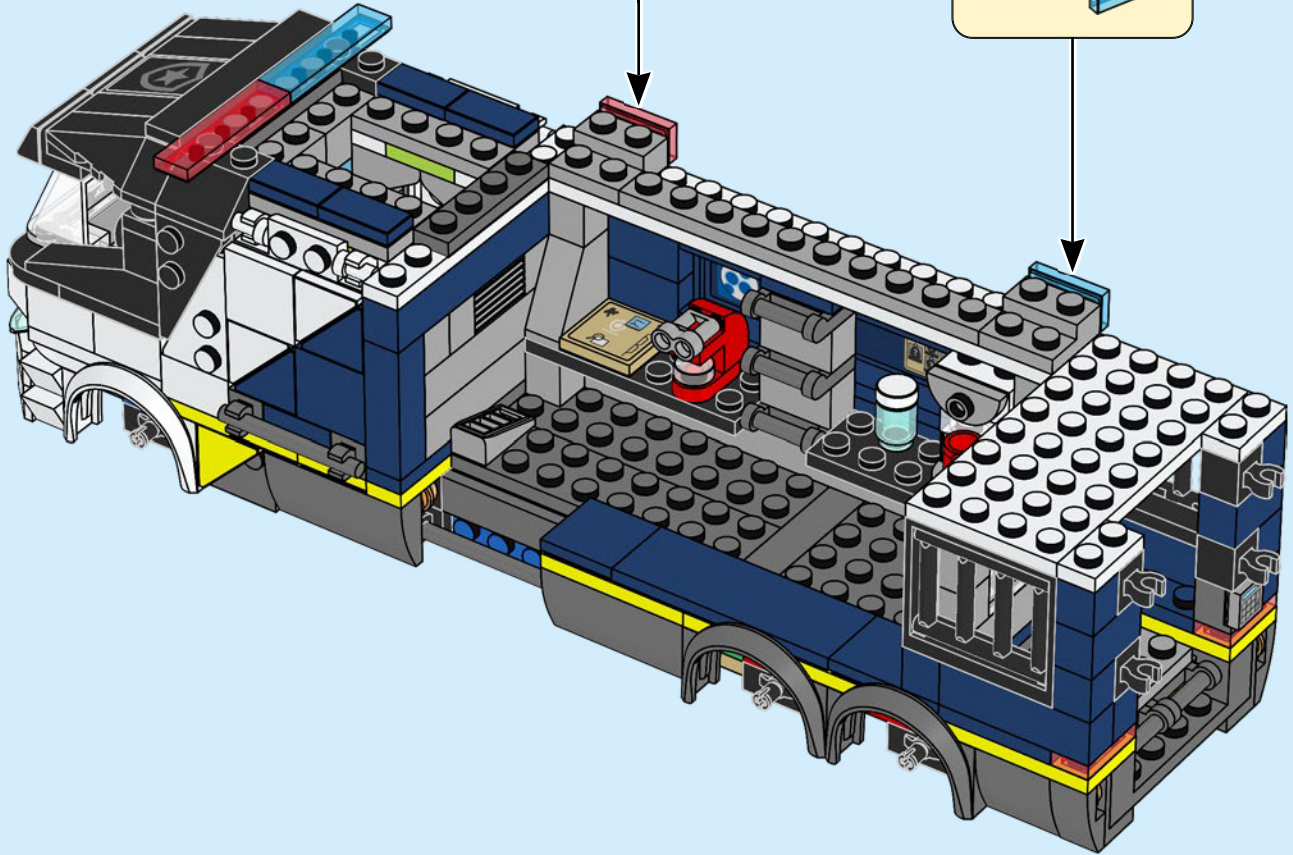
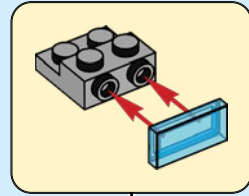
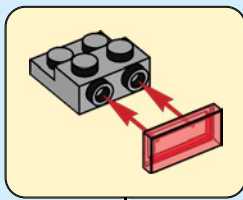





5x

131

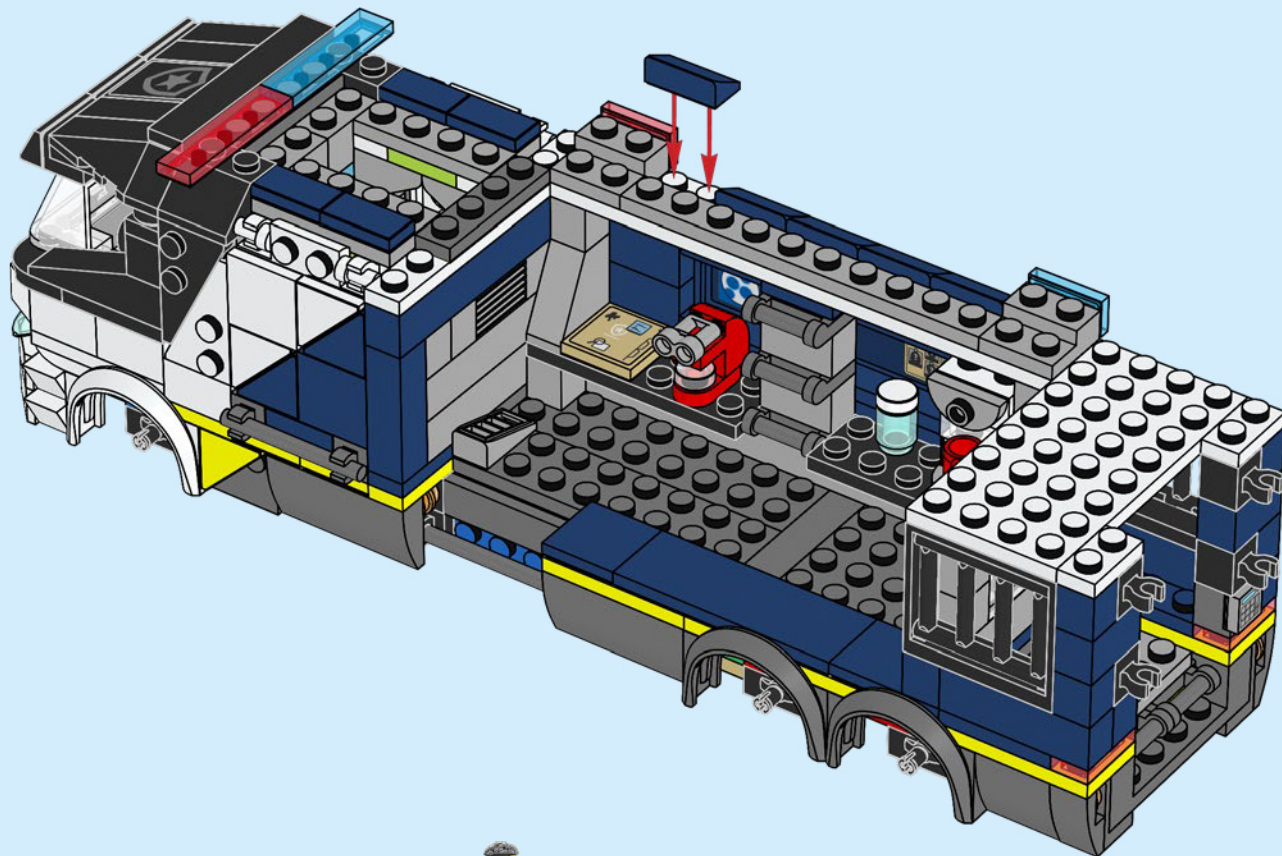

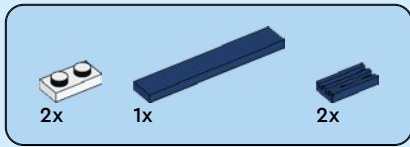

132

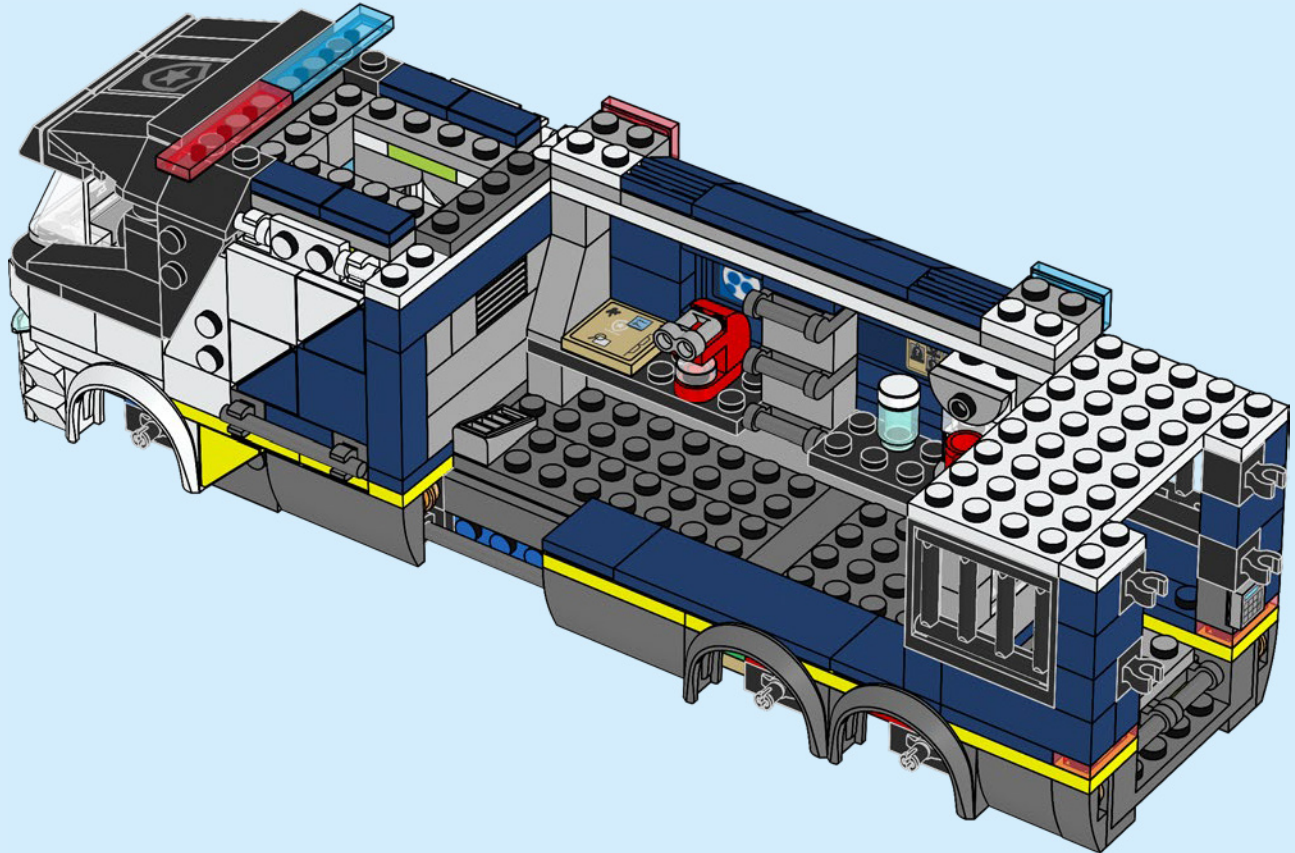



2x

# 133

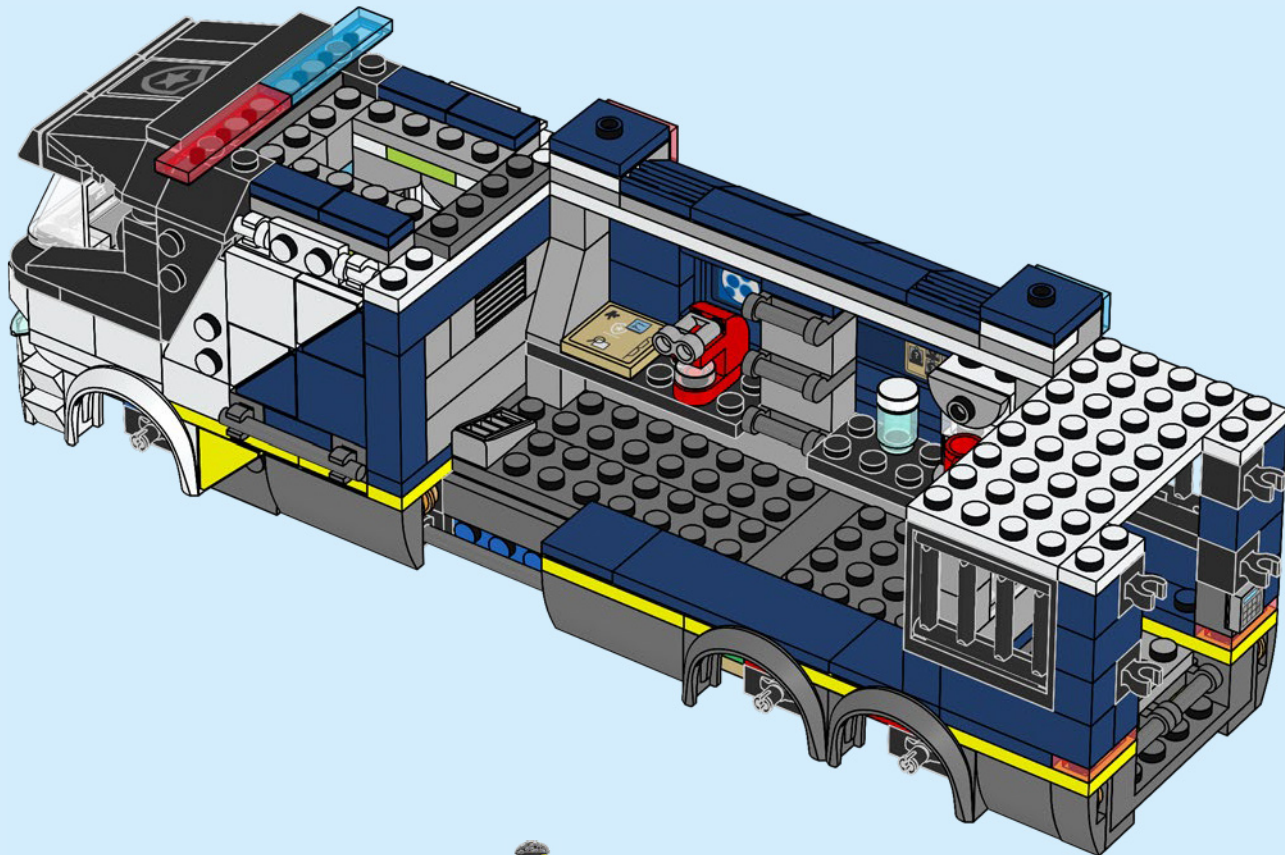



2x



4x

# 134

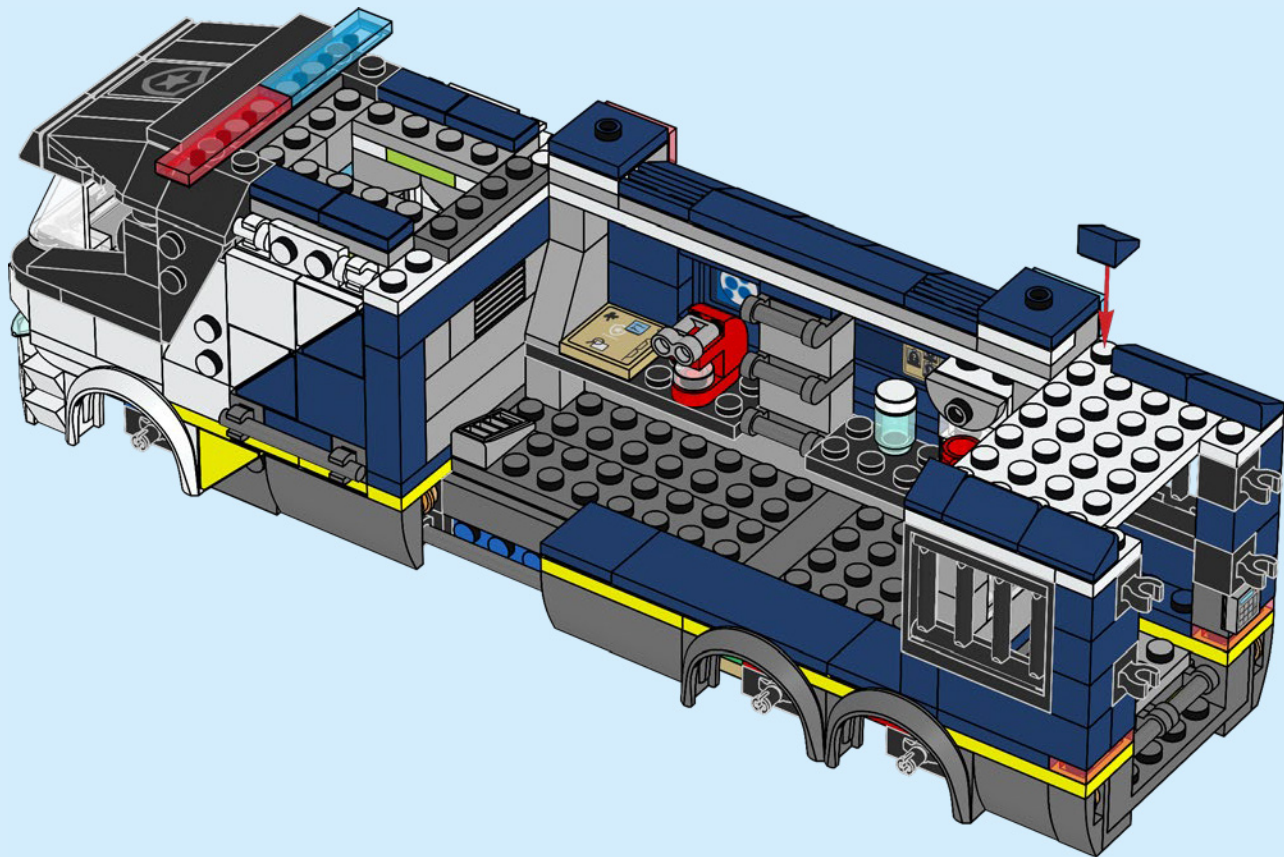

2x

135

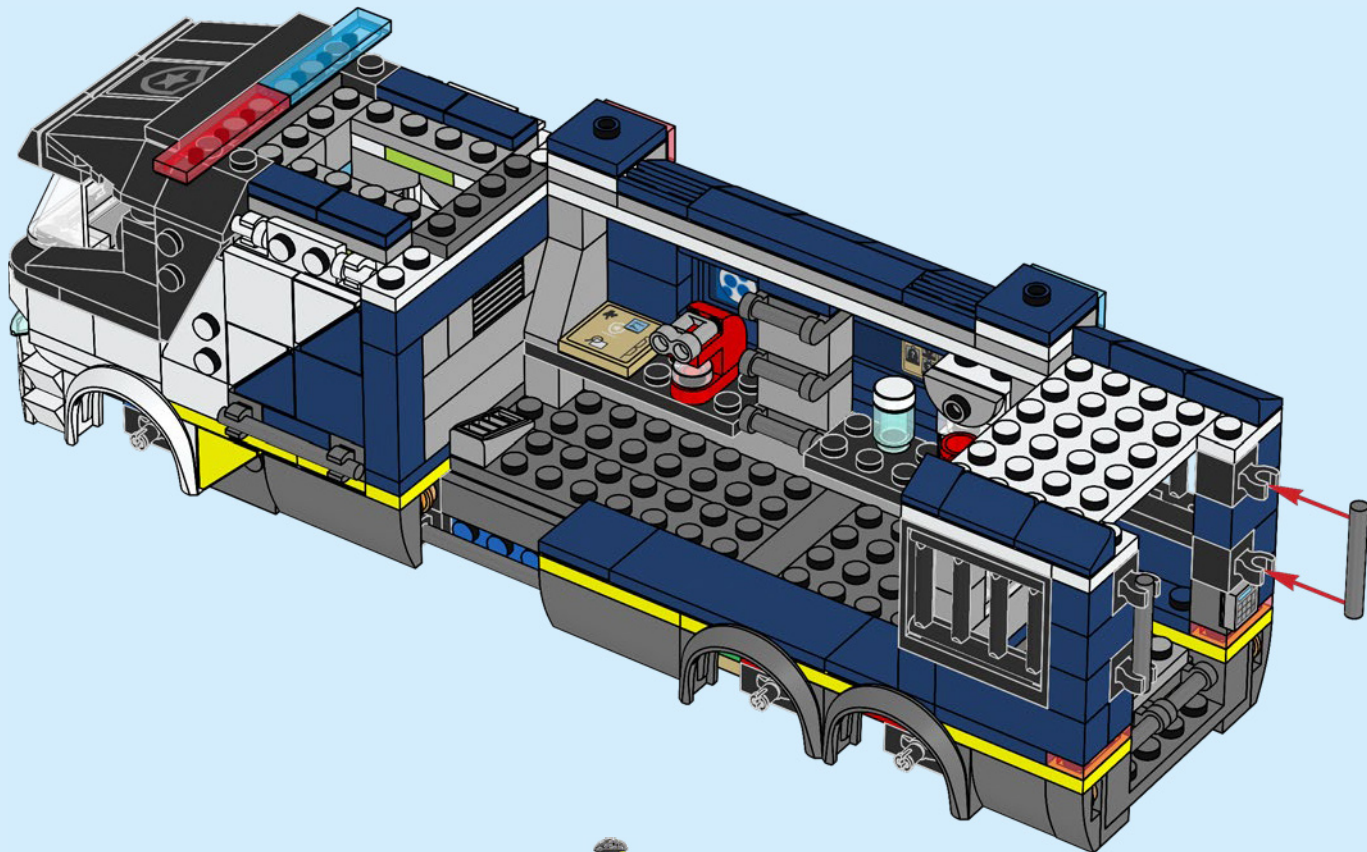

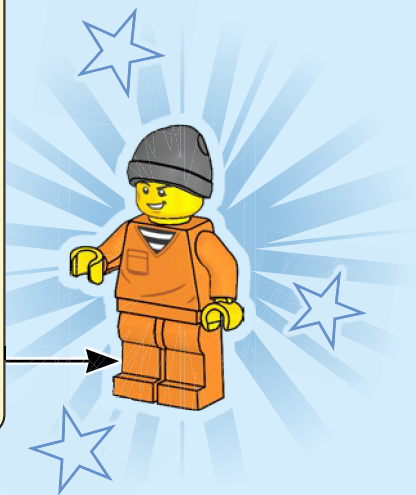
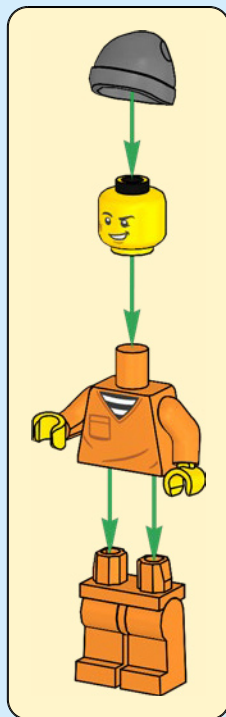



2x



2x

# 136

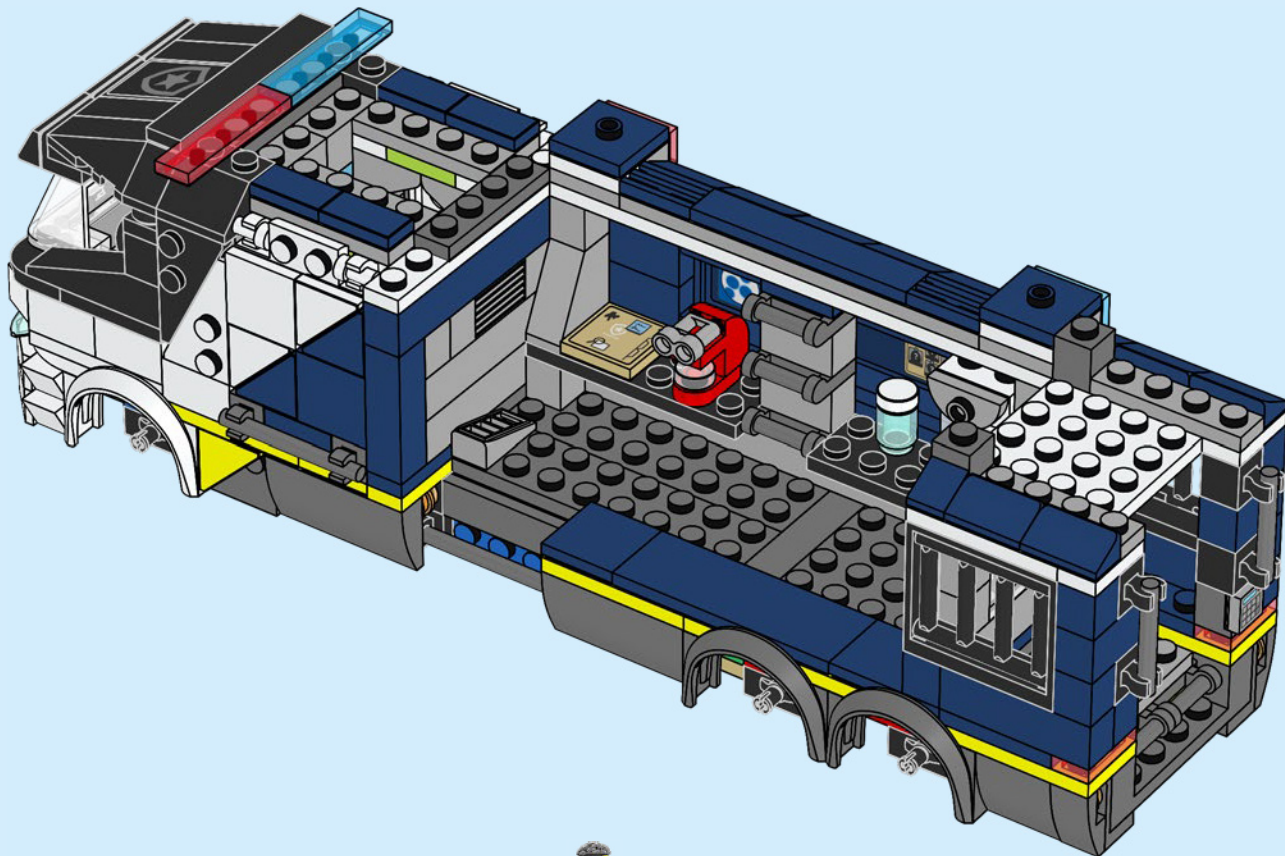

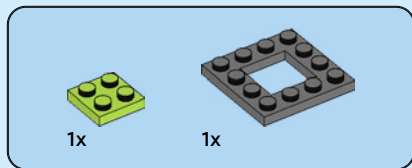

137

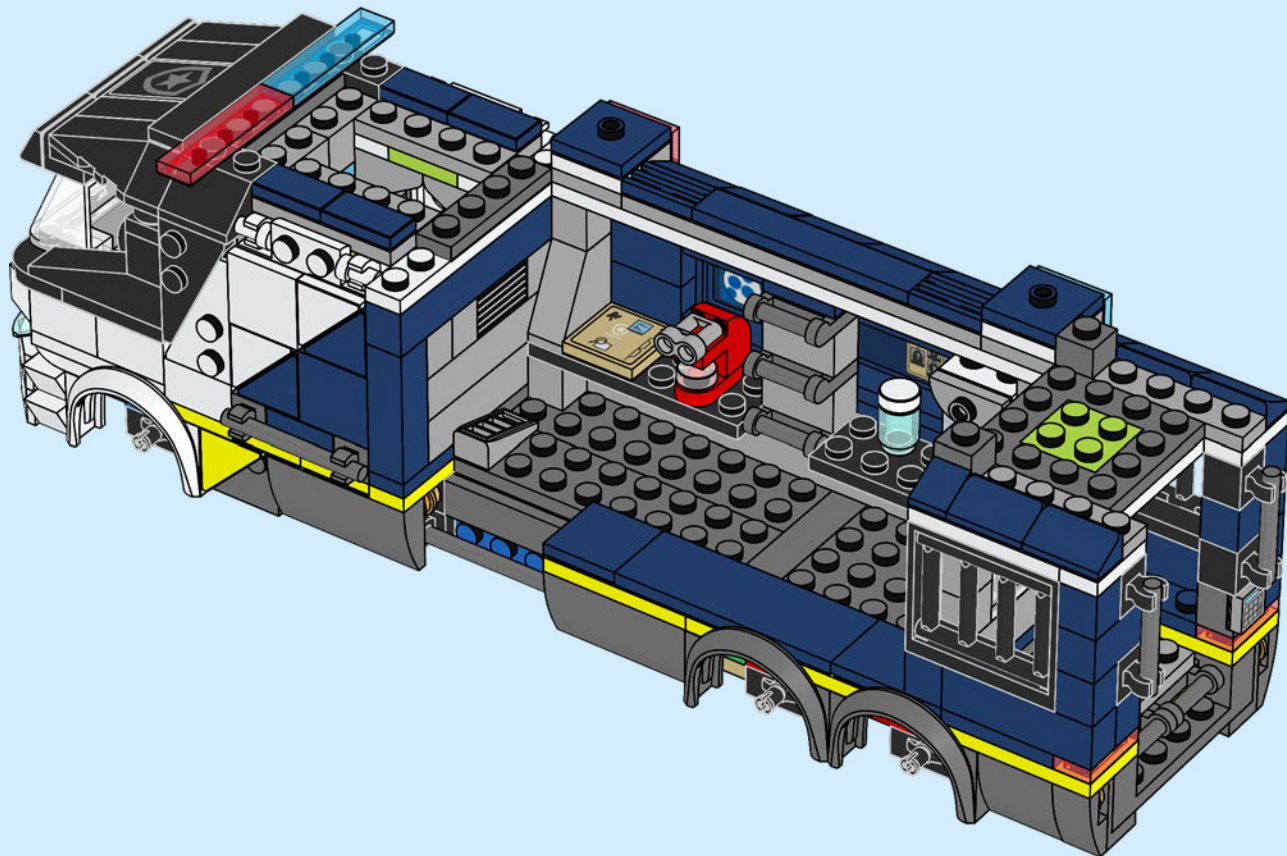





1x

138

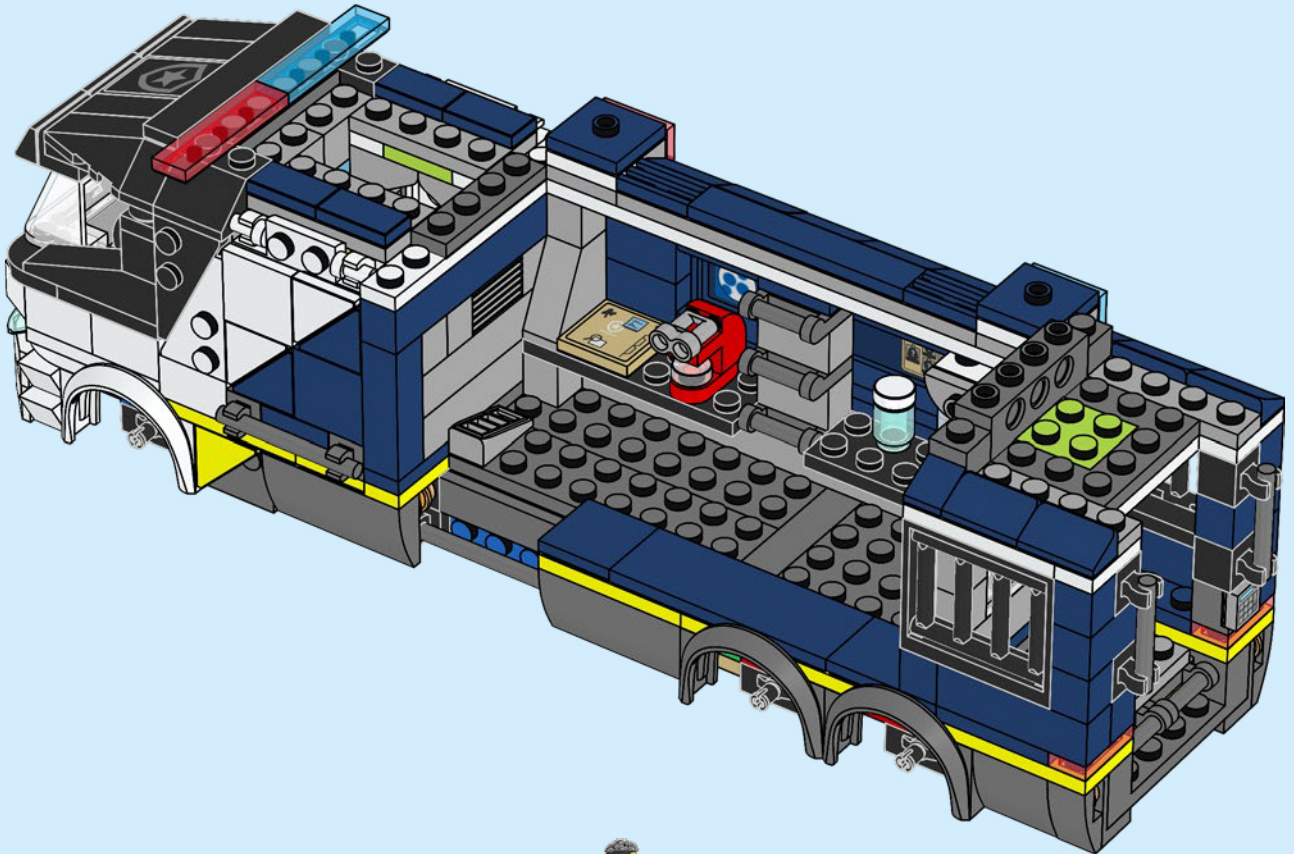



1x



2x

139

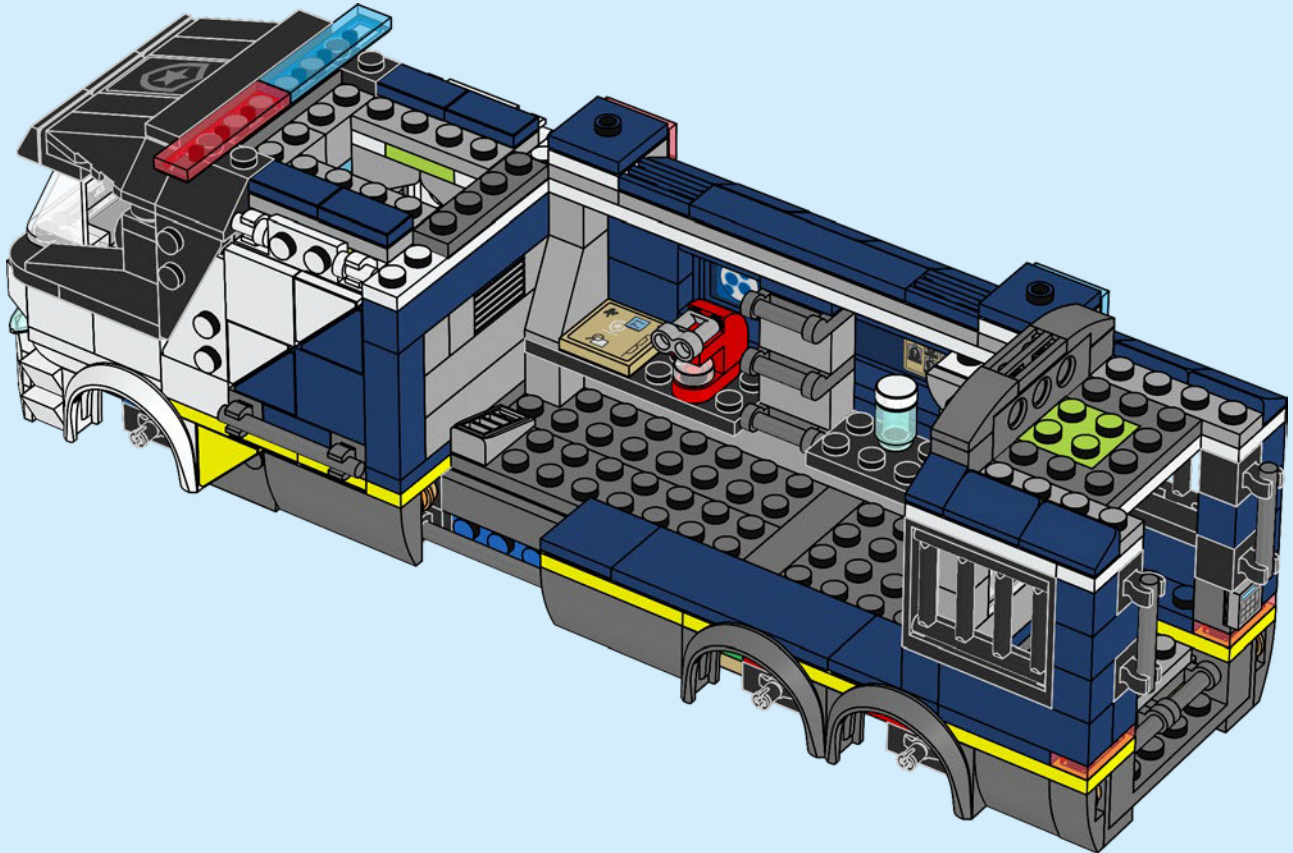



2x

140

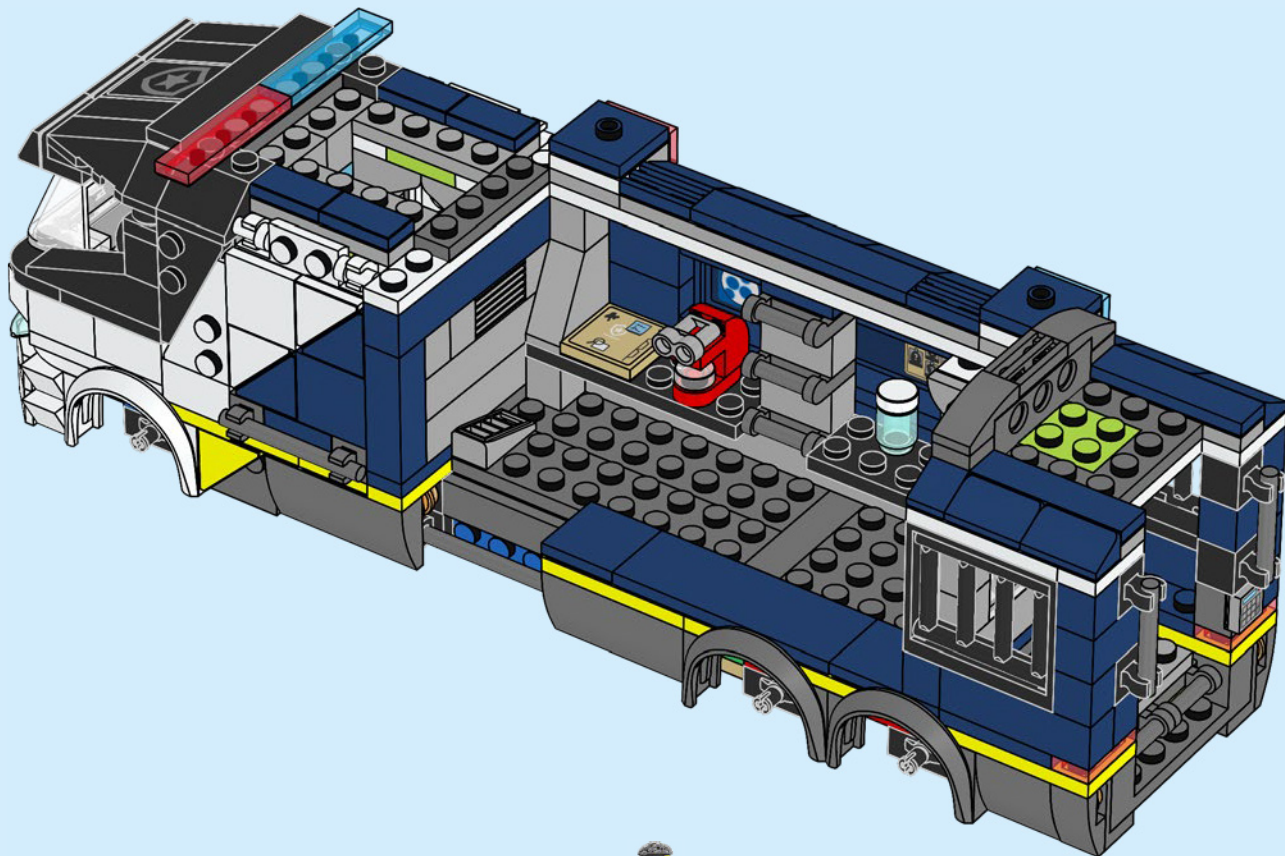

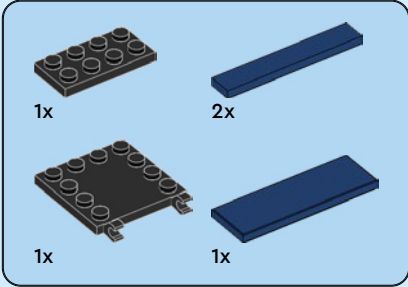
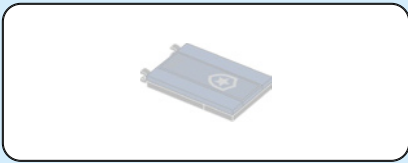

# 141

1

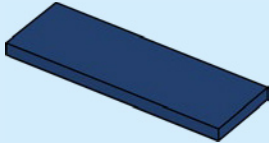

2



3

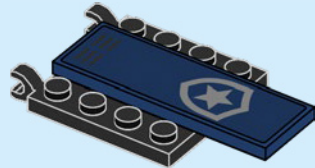

4

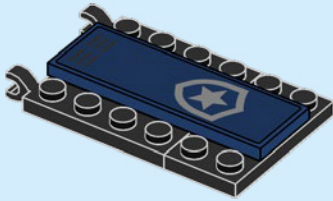

5

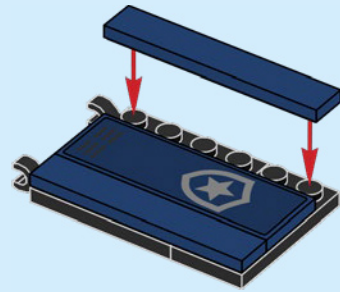

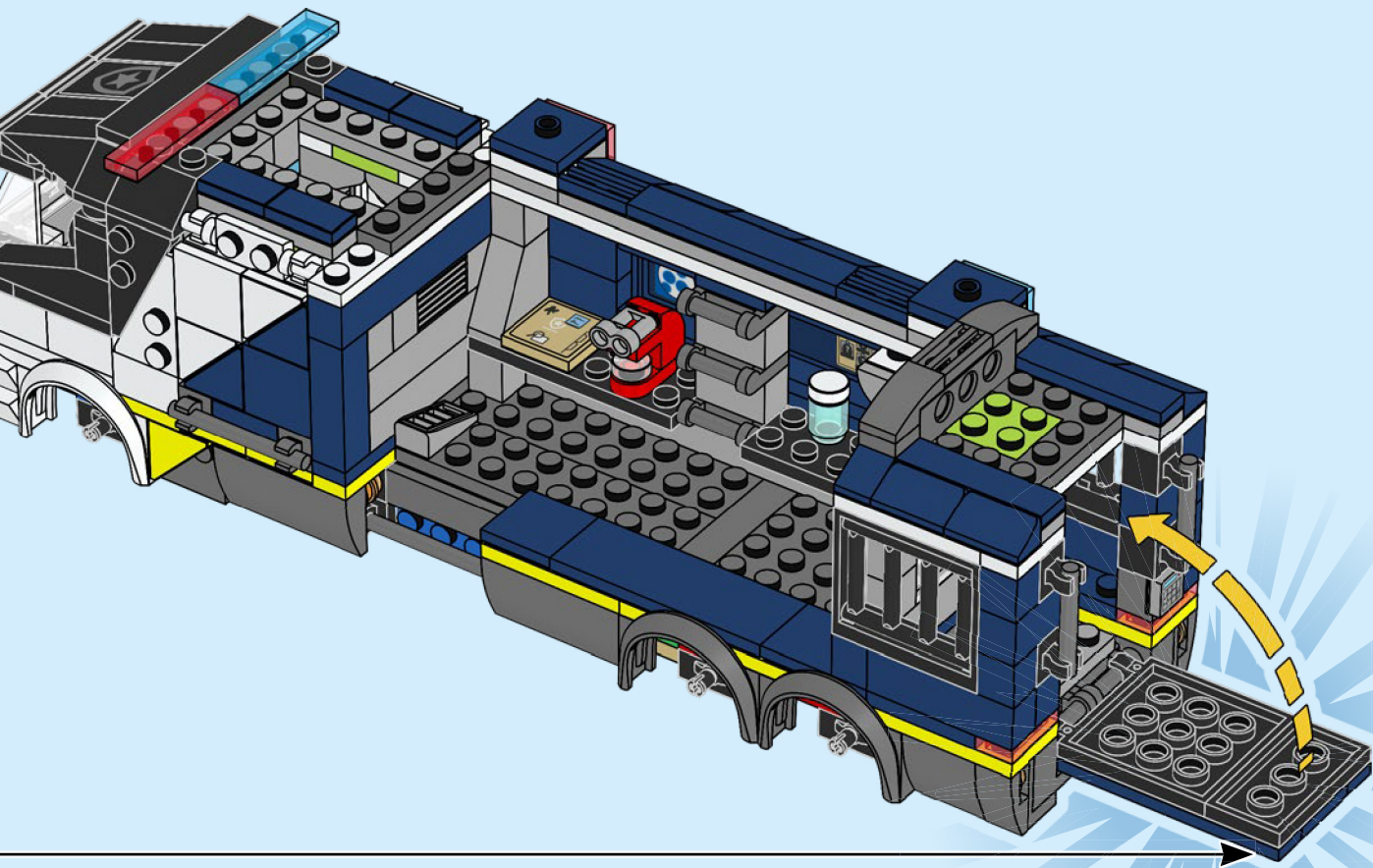

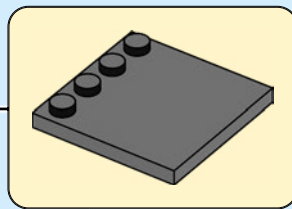
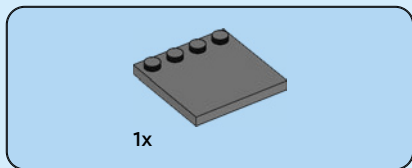

142

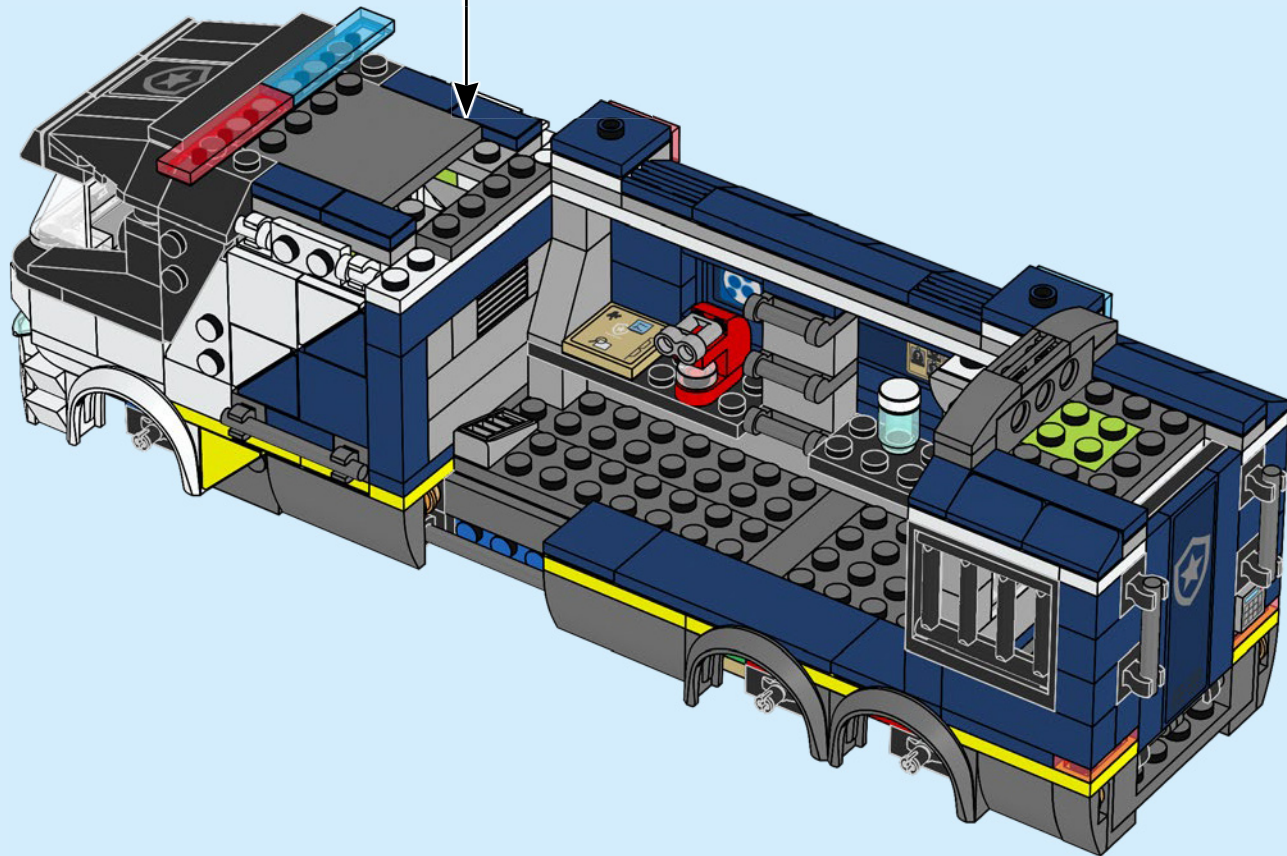

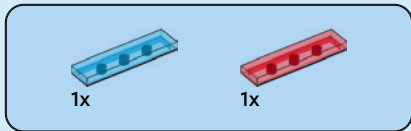

# 143

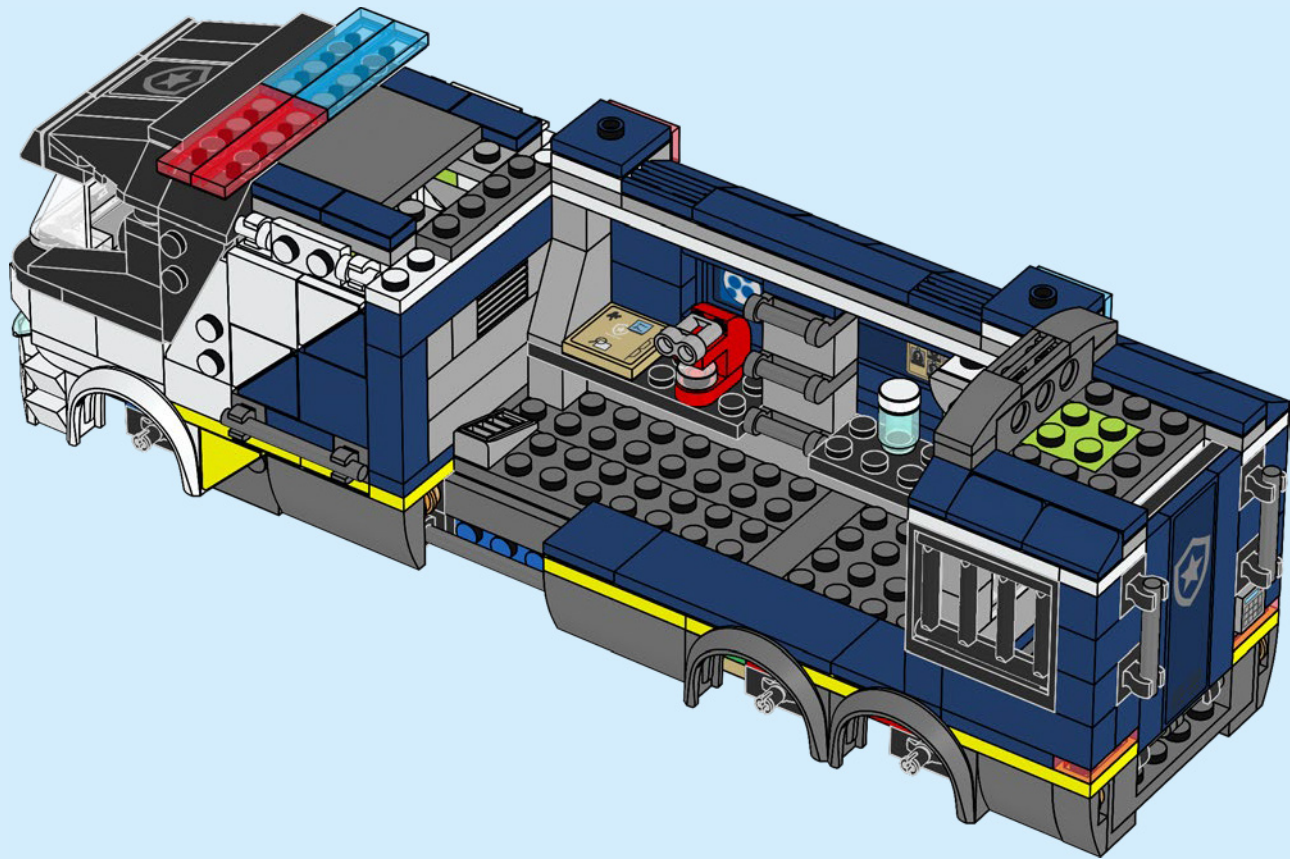





2x

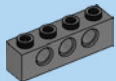

1x

# 144

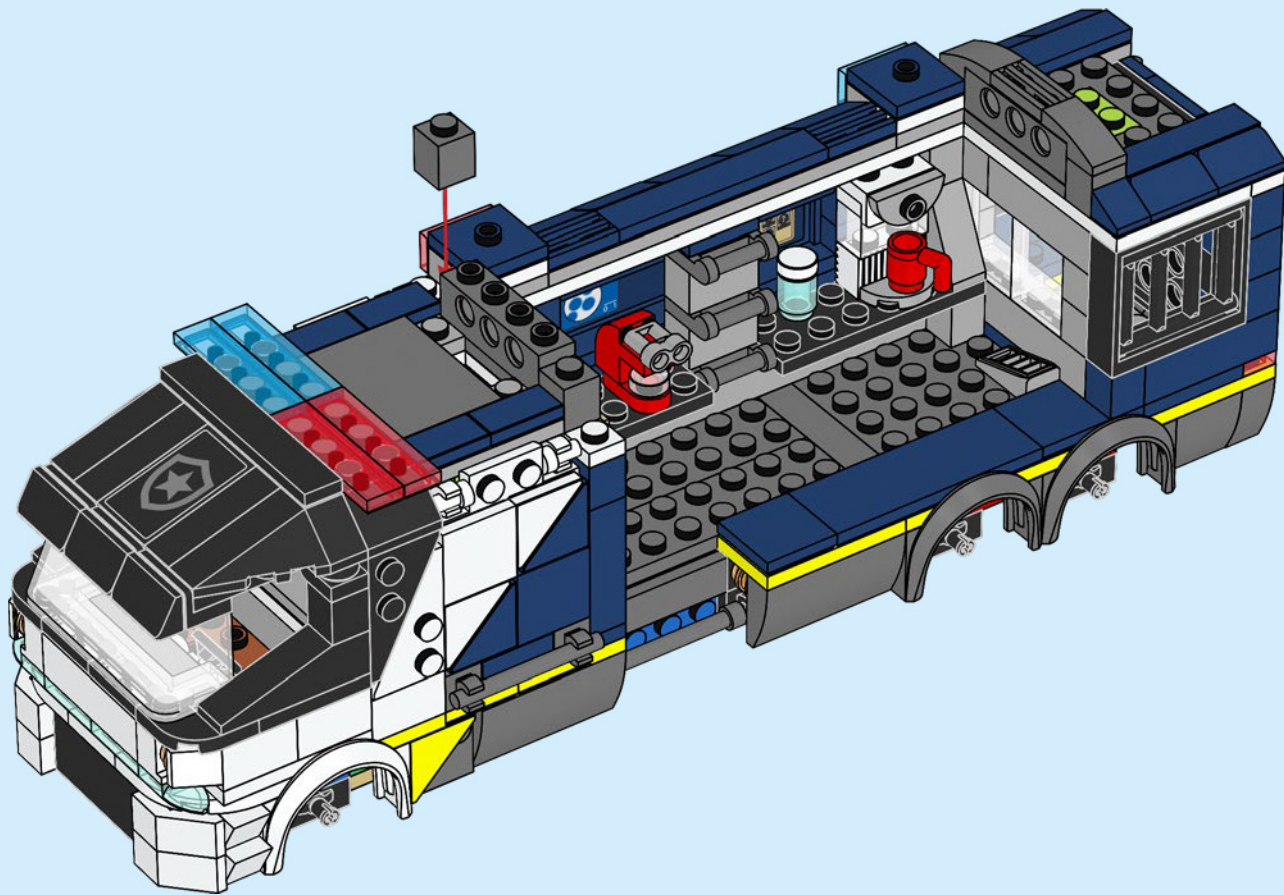



2x

145

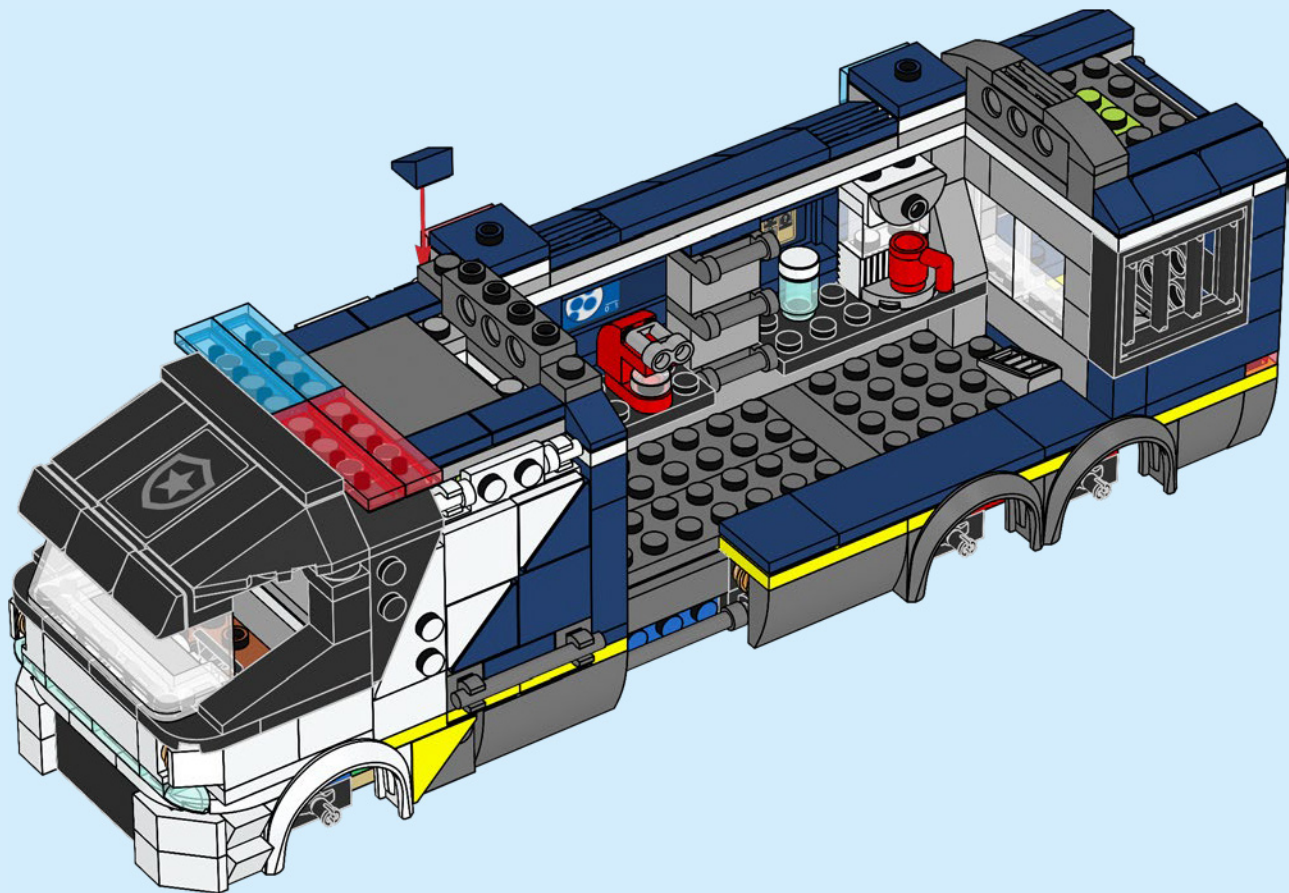



1x



2x

# 146

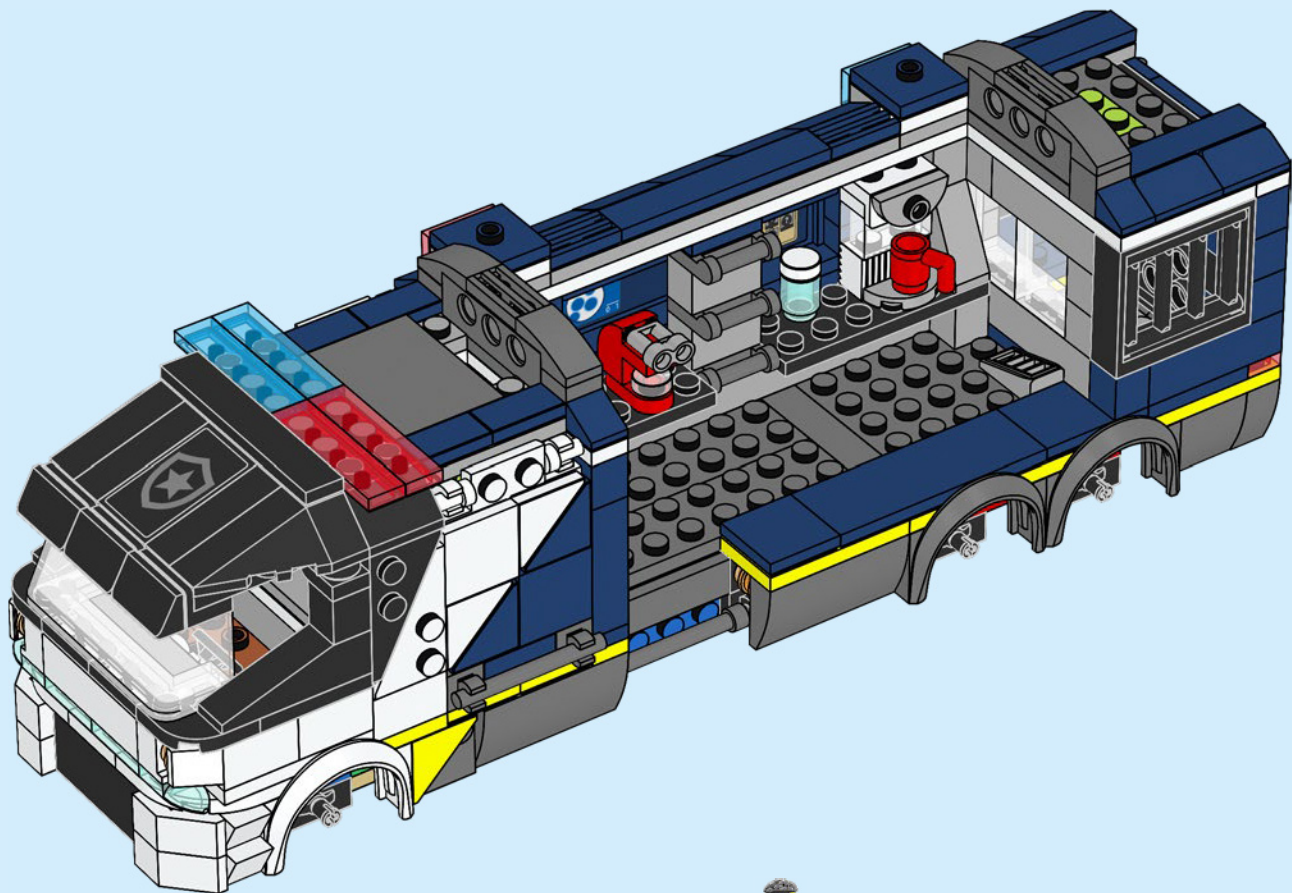

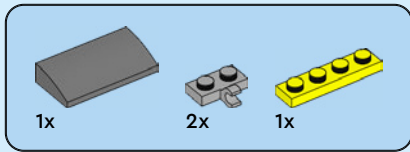

147

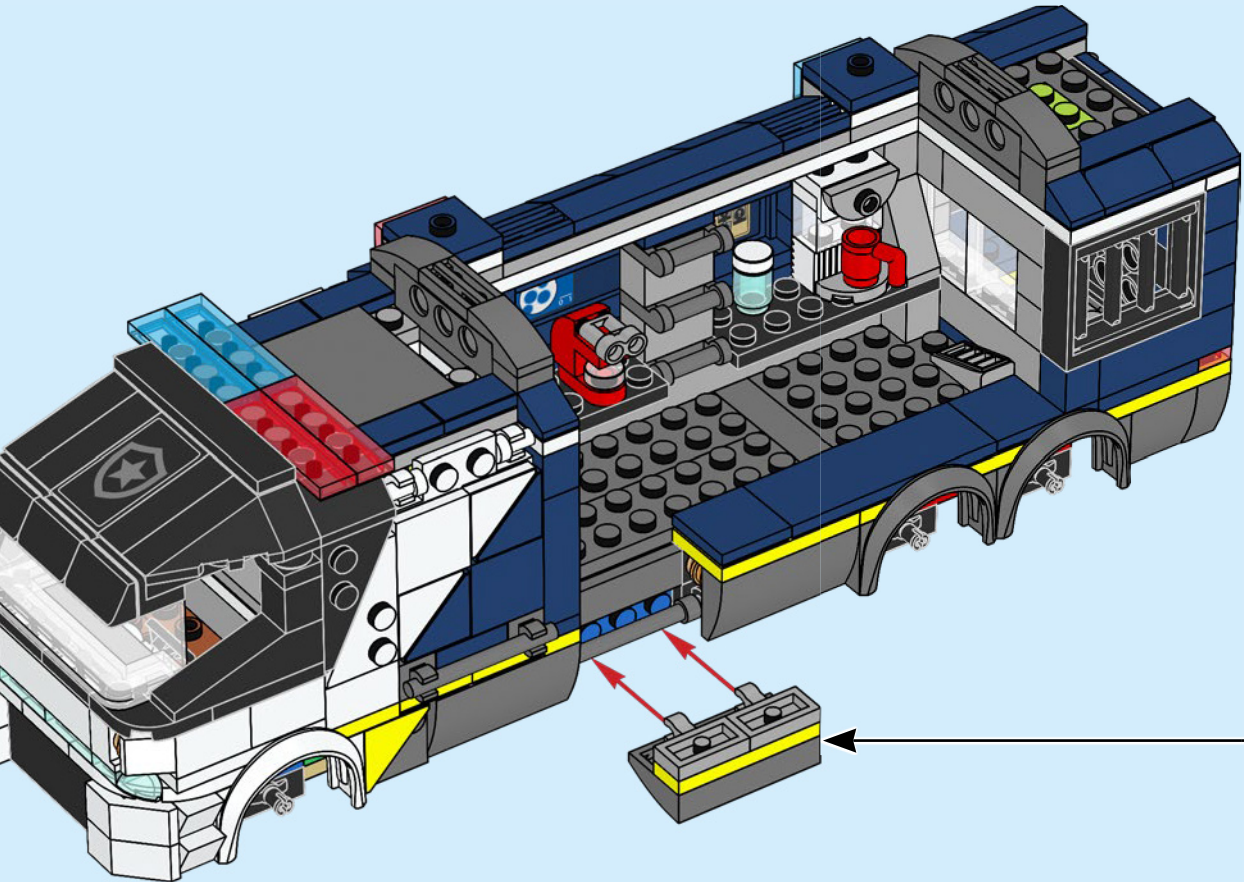
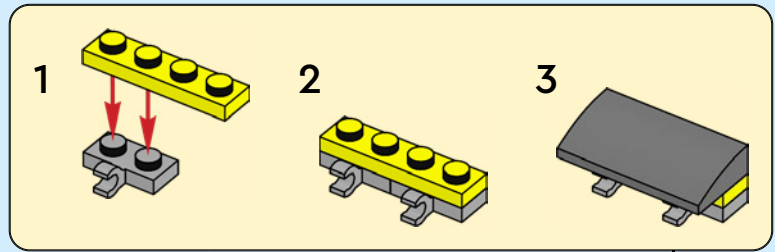

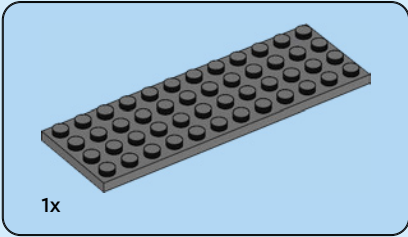
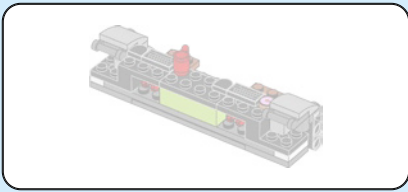

148

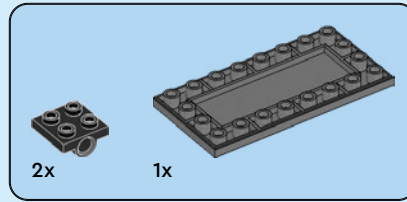
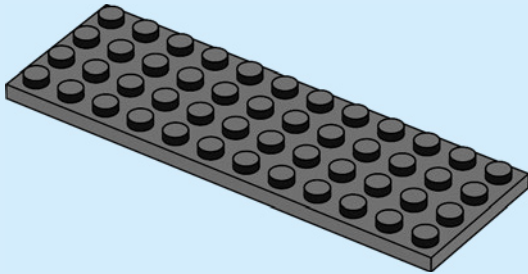

149

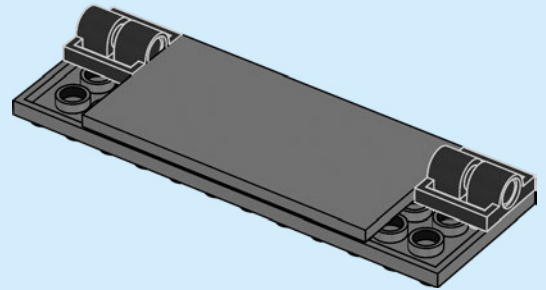
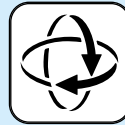

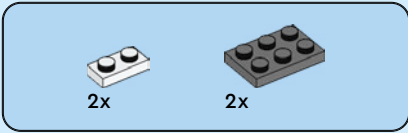

150

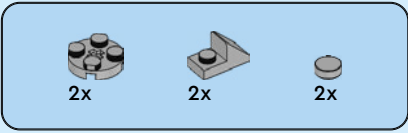
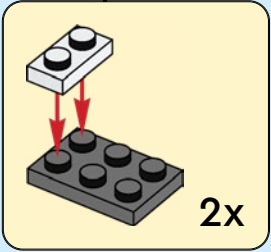
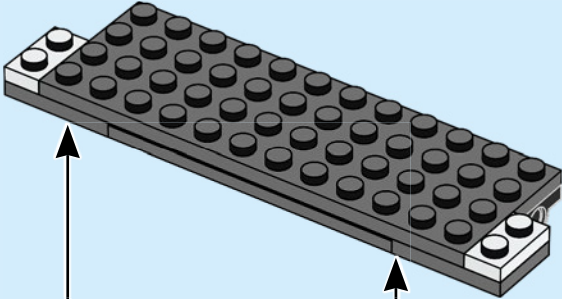

151

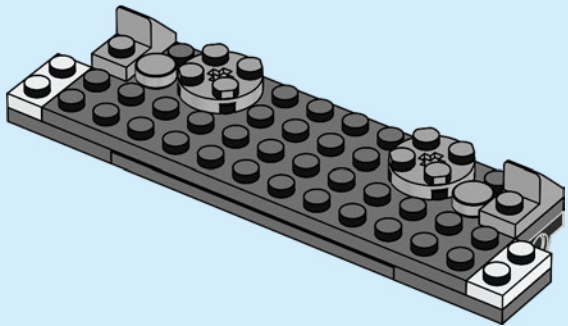



2x

152

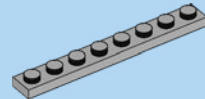
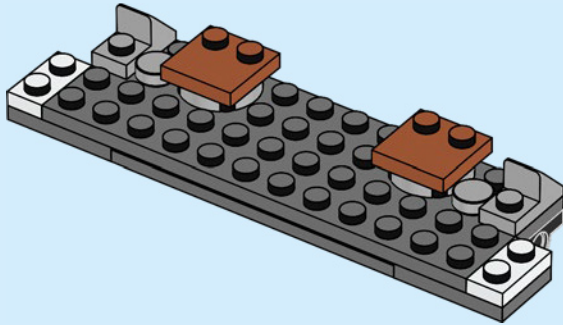

1x

153

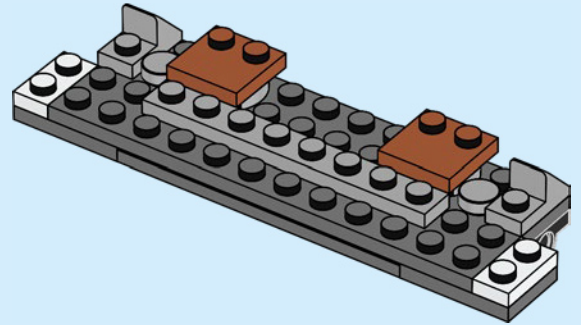

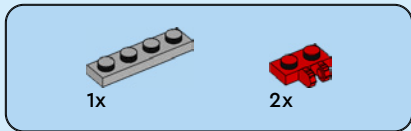

154

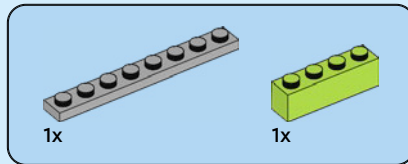
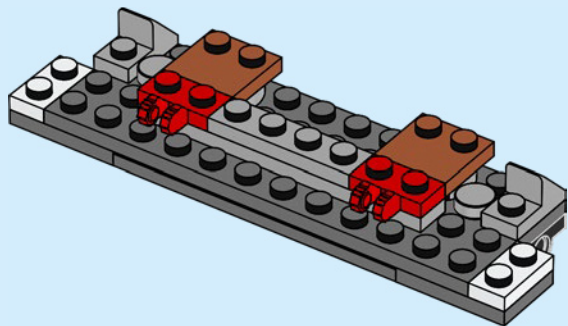

155

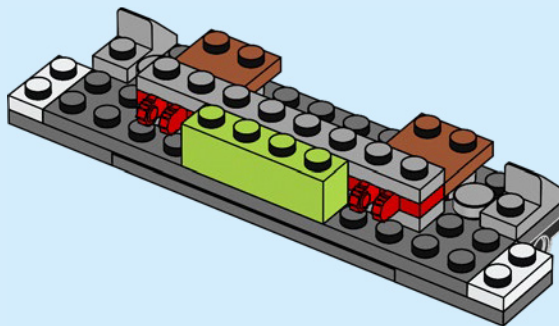



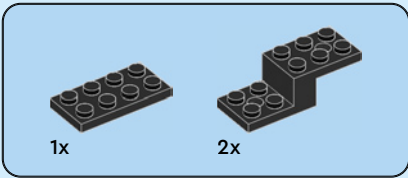

156

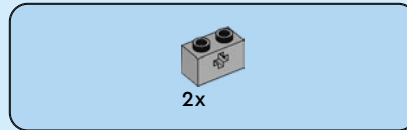
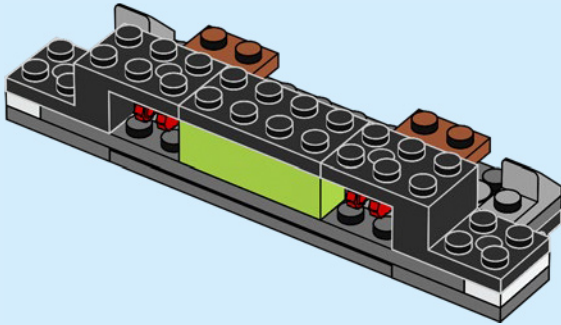

157

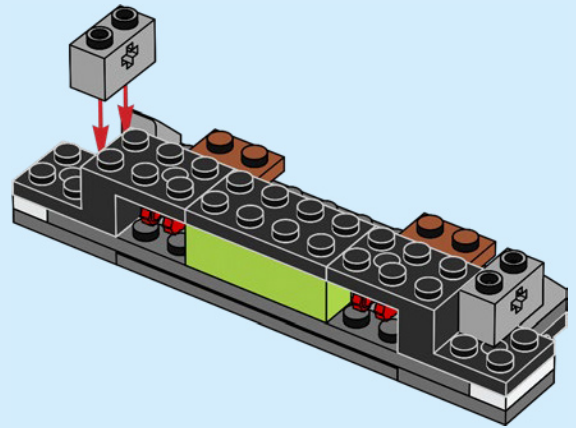





2x



2x

# 160

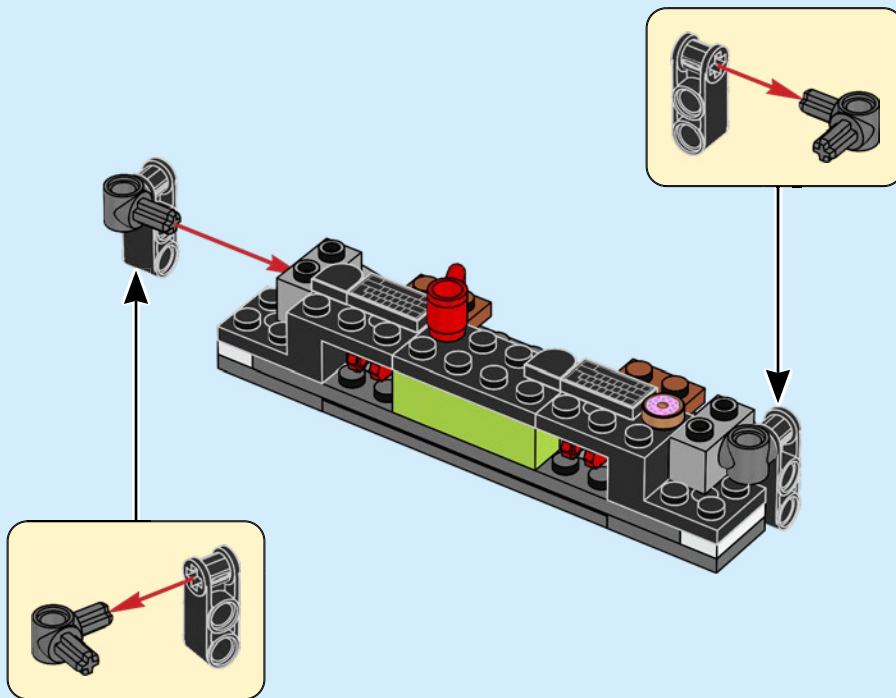

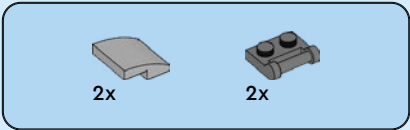

161

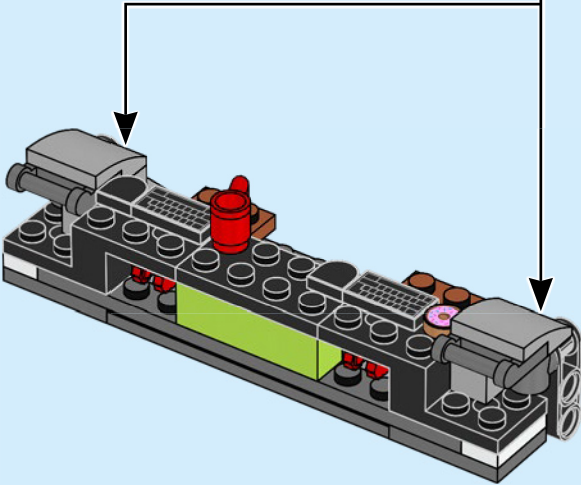
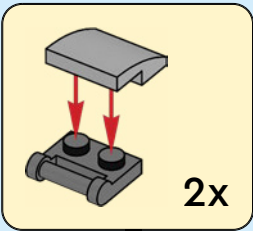

162

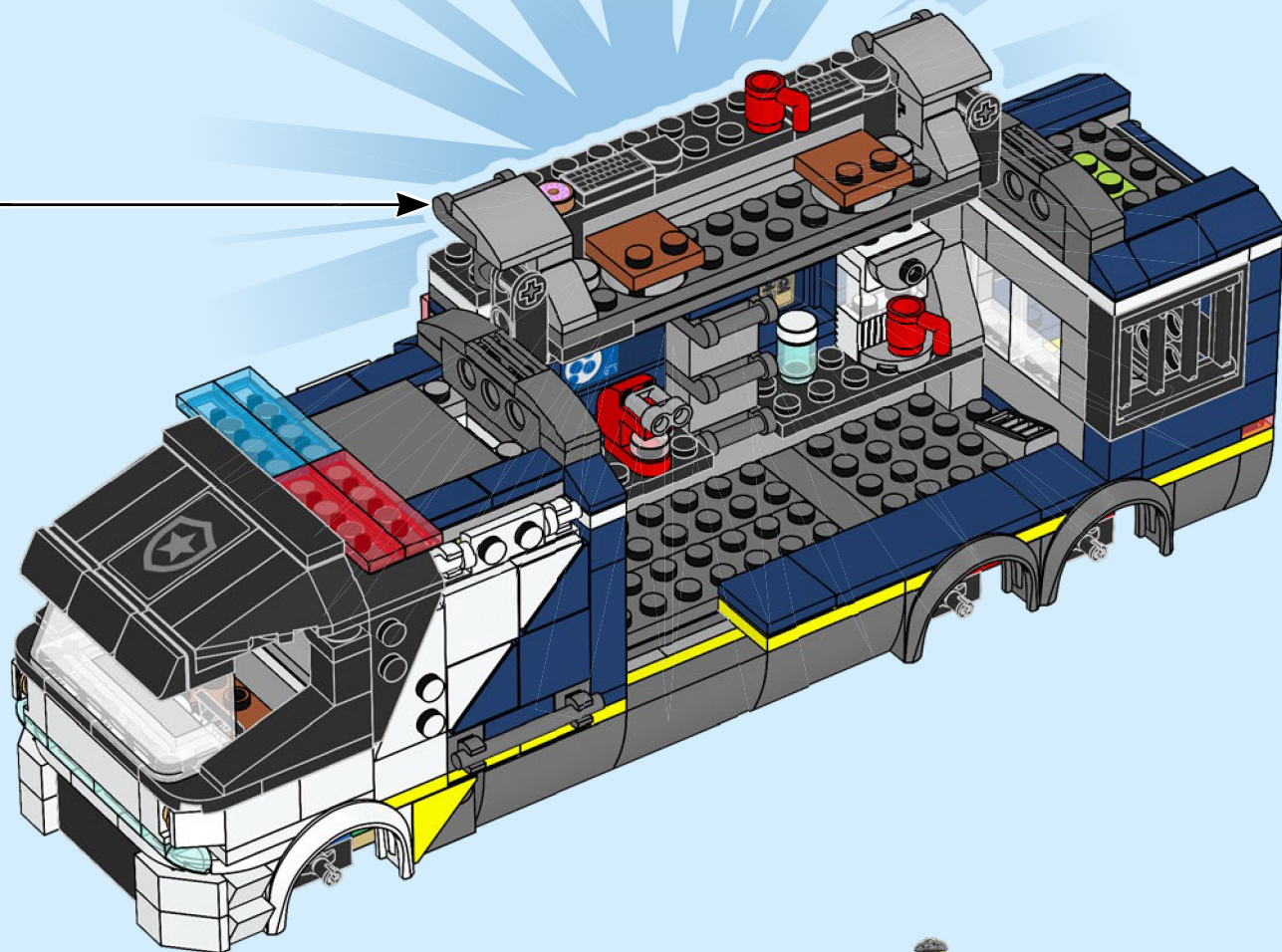

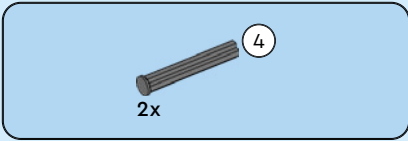

163

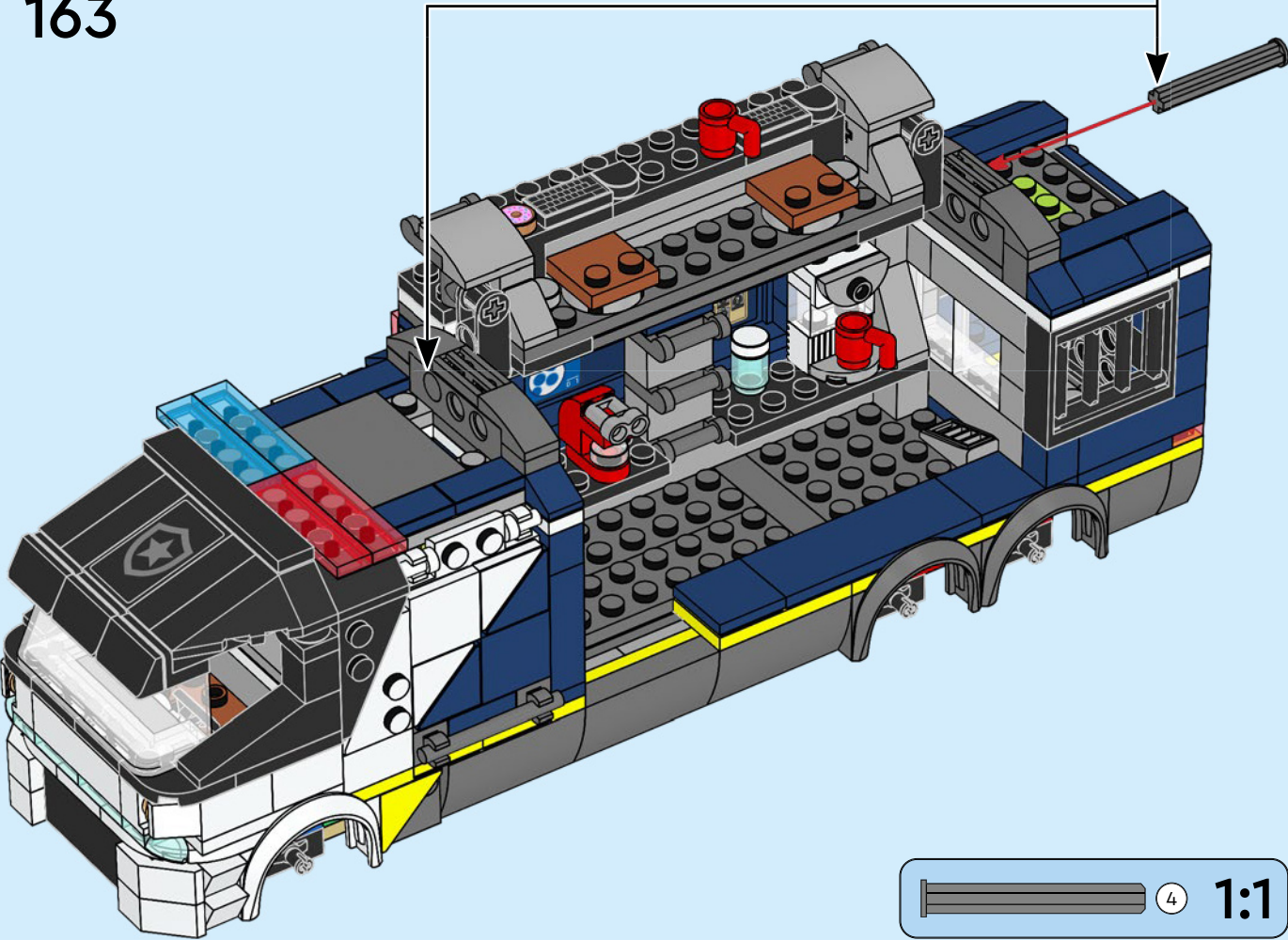
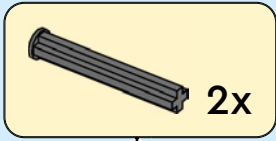

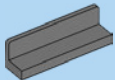

2x

164

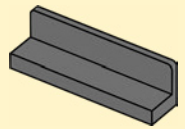

2x

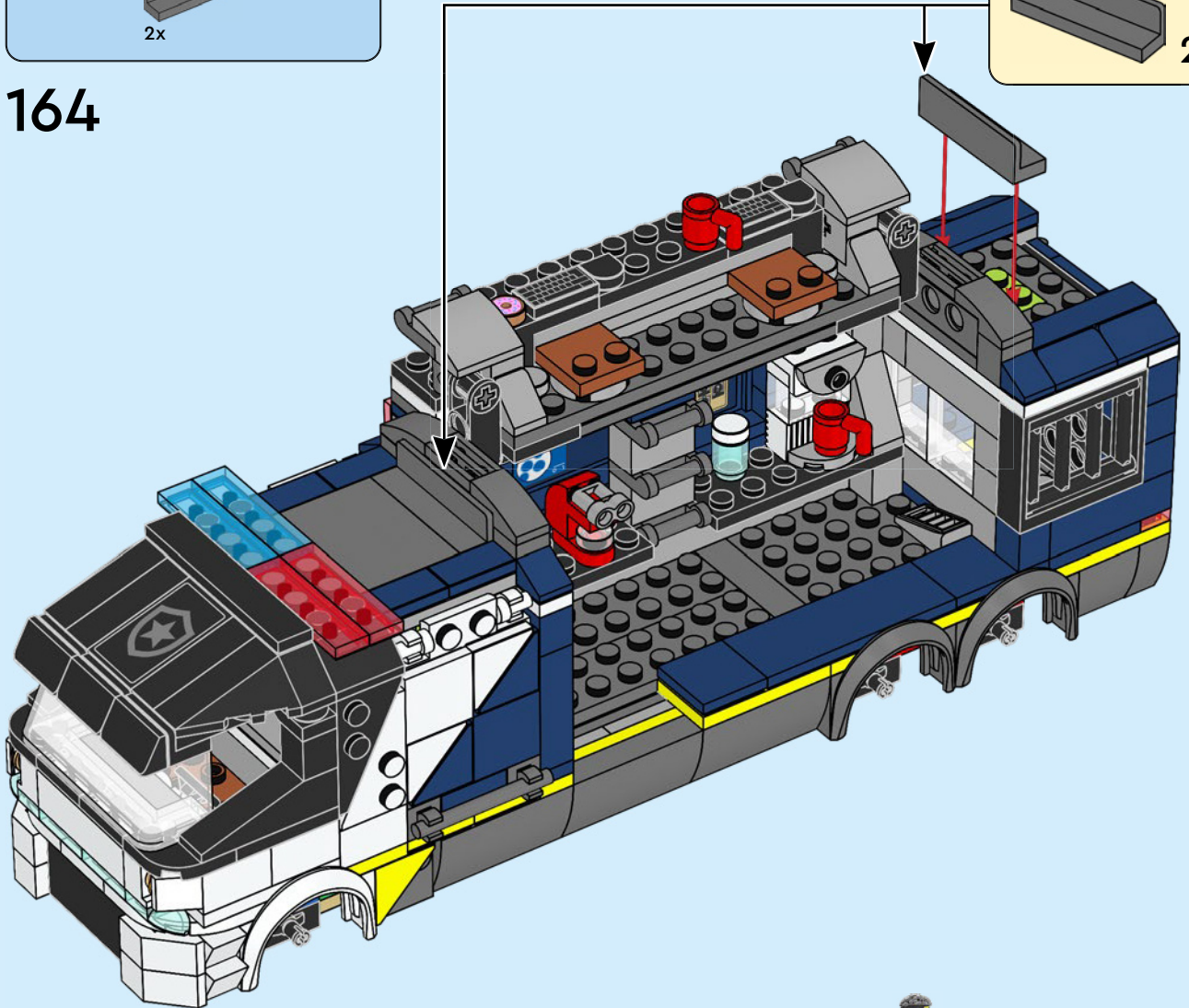

165

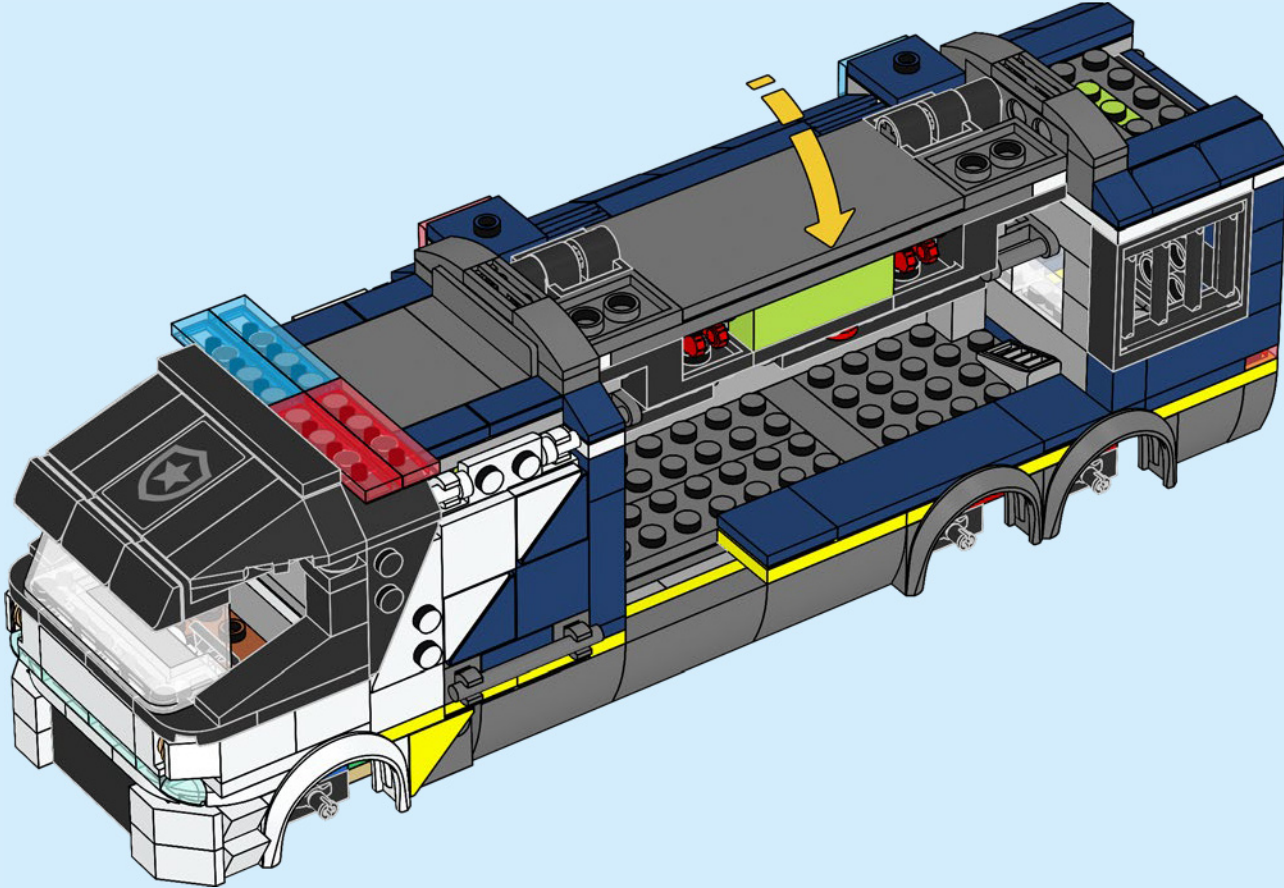



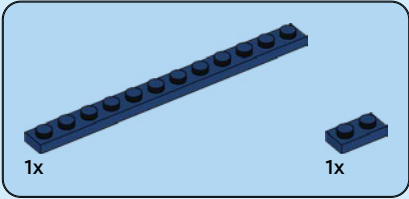
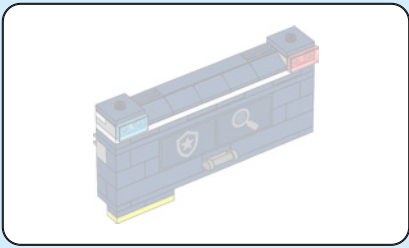

166

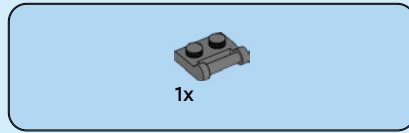
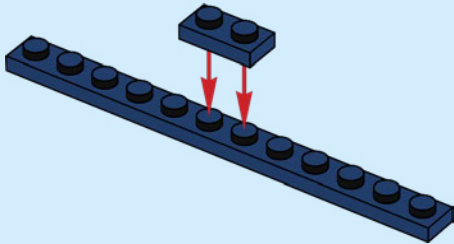

167

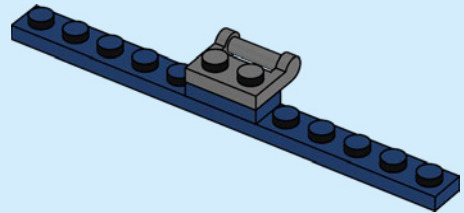

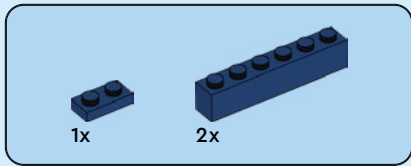

168

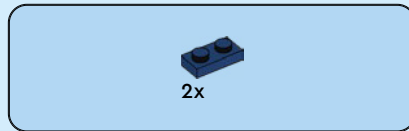
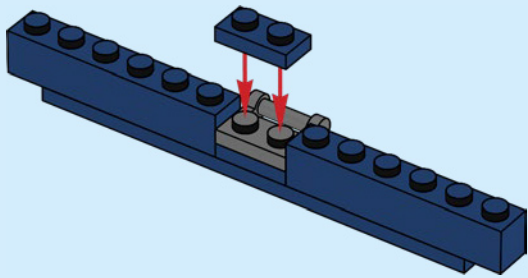

169

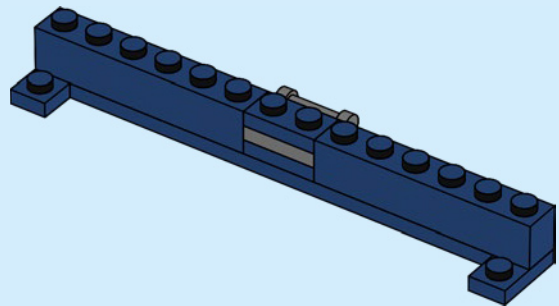



2x

170

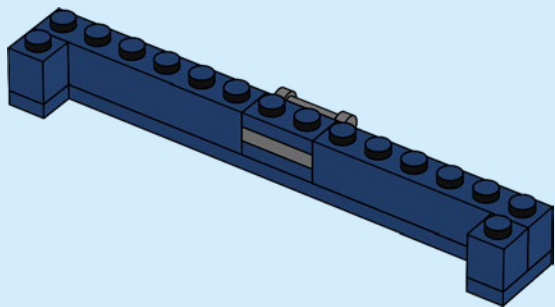

2x



2x

171

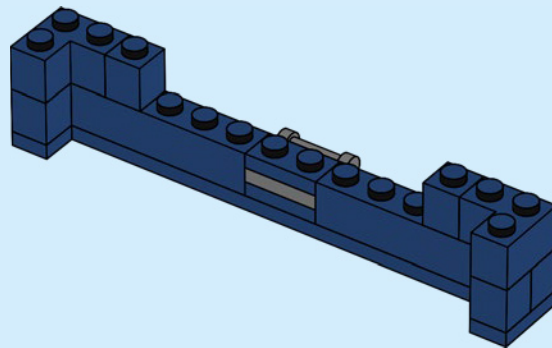

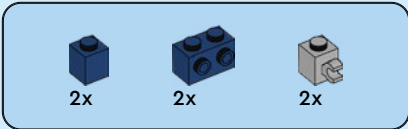

172

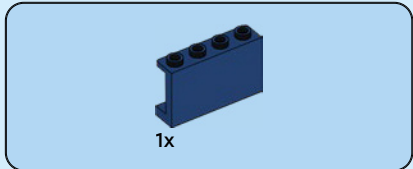
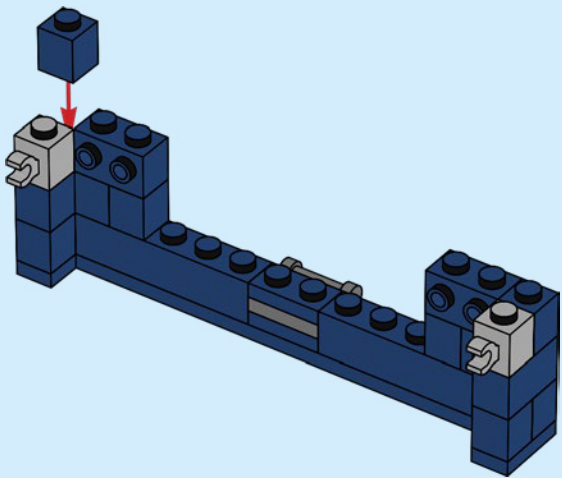

173

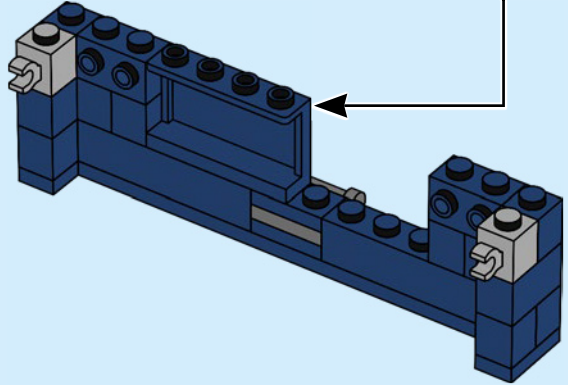
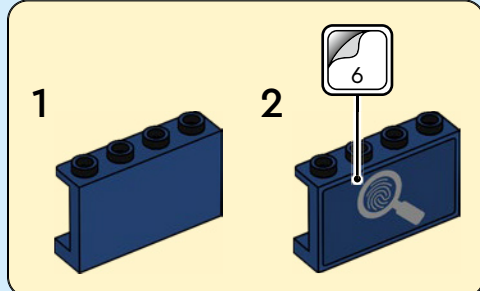

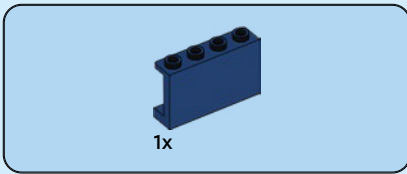

174

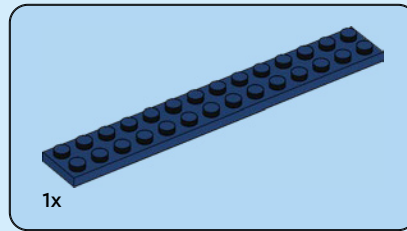
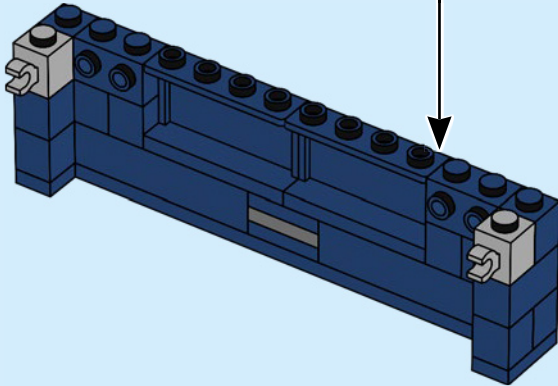
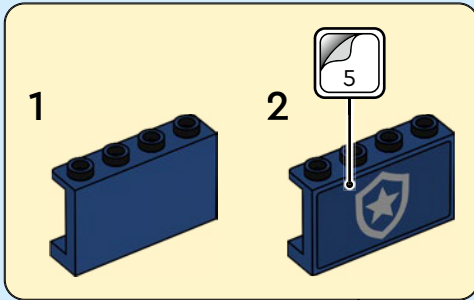

175

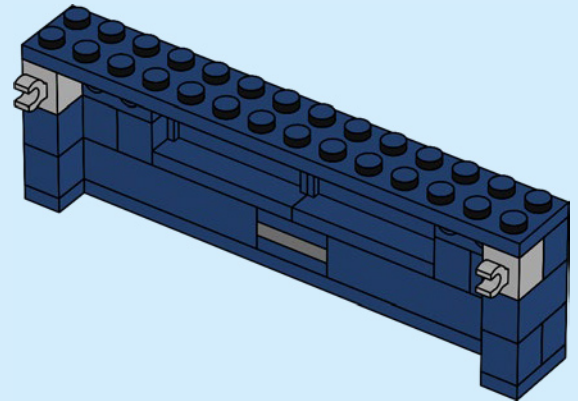

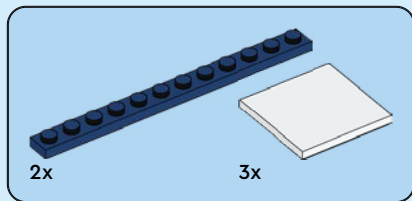

176

1

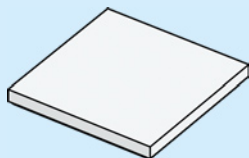

2

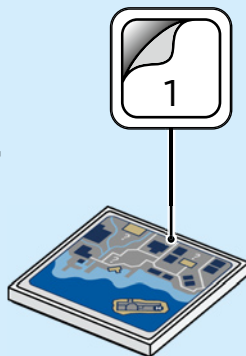

3

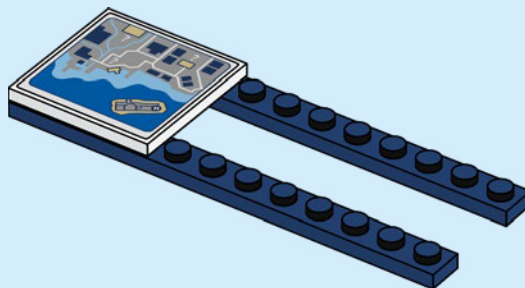

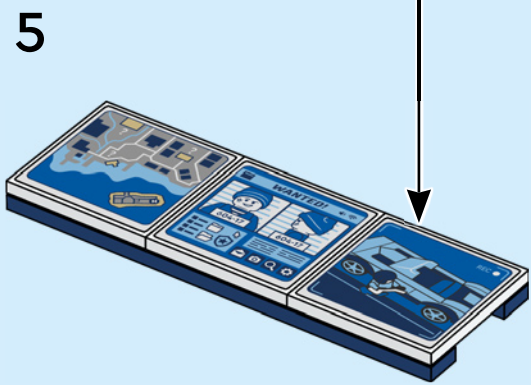
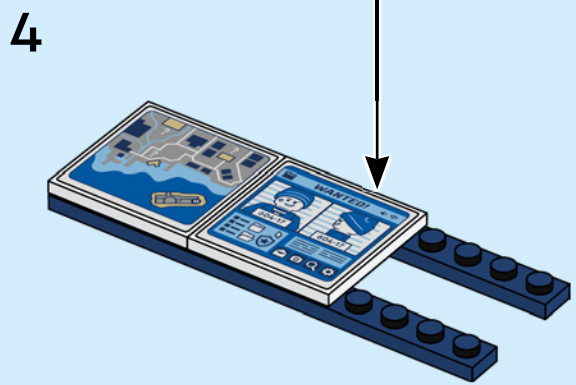
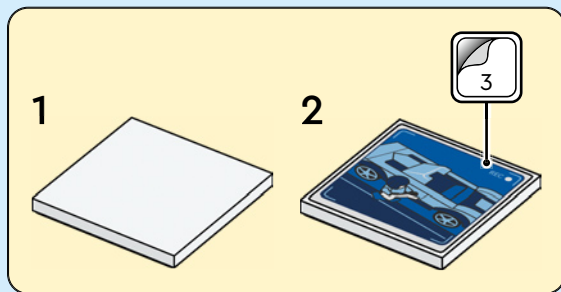
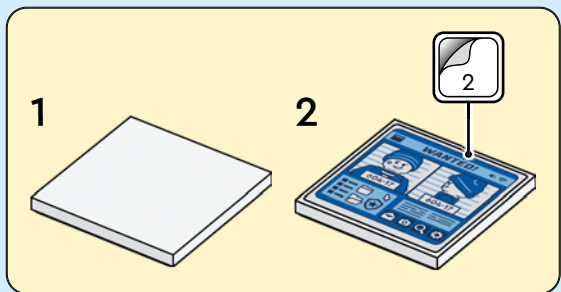



2x



2x



1x

# 177

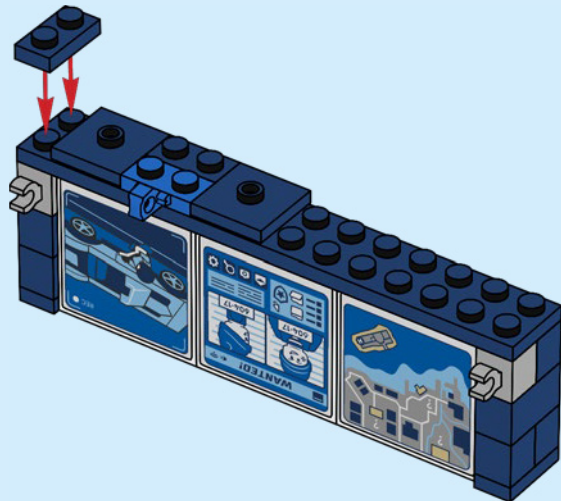
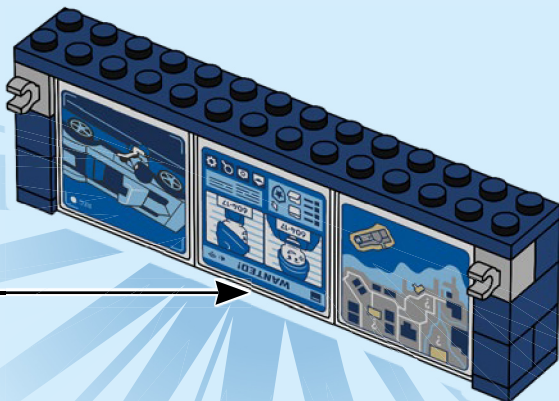



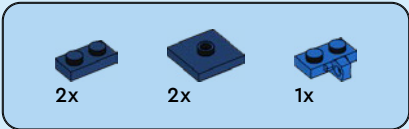

178

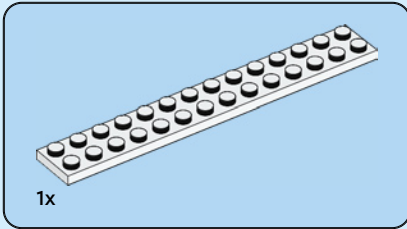
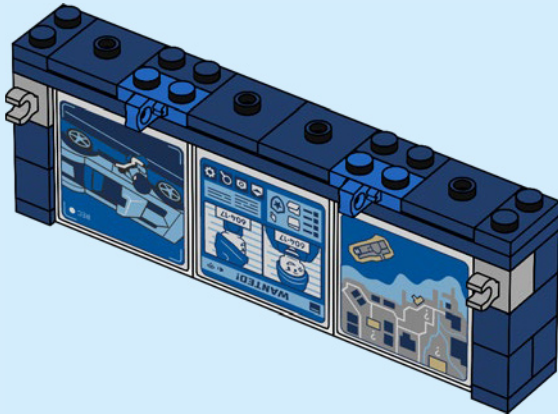

179

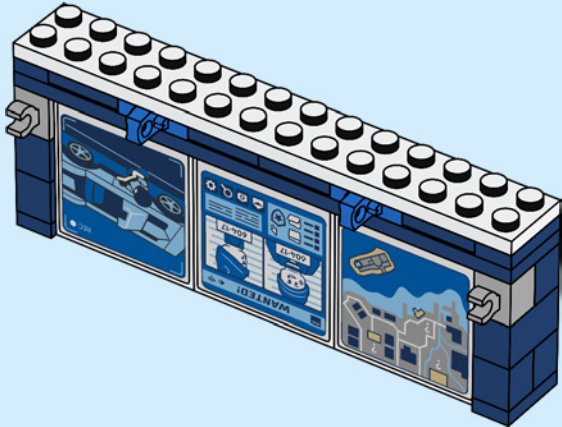



2x

180

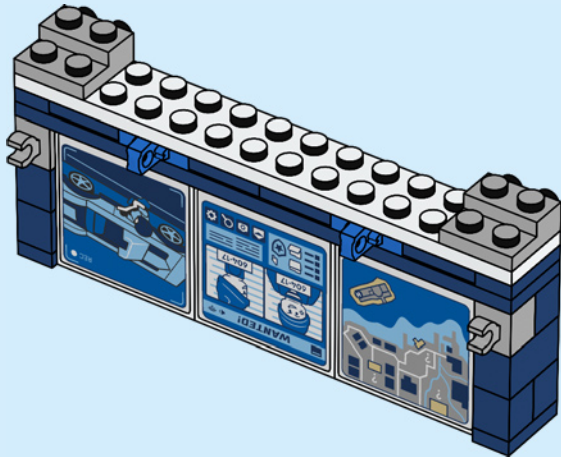

5x

181

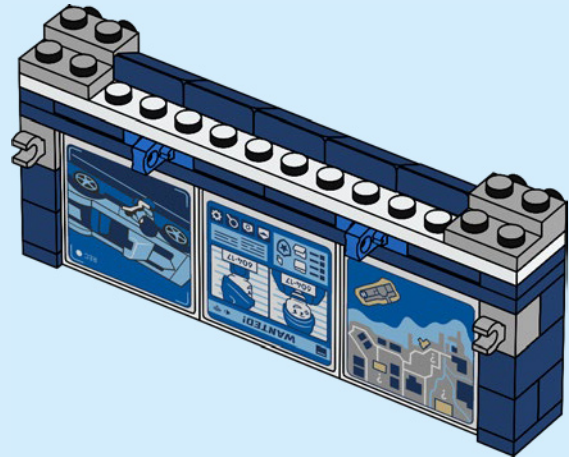

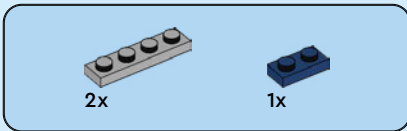

182

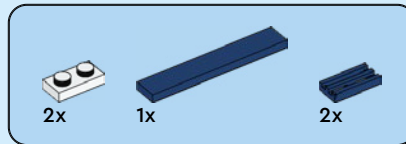
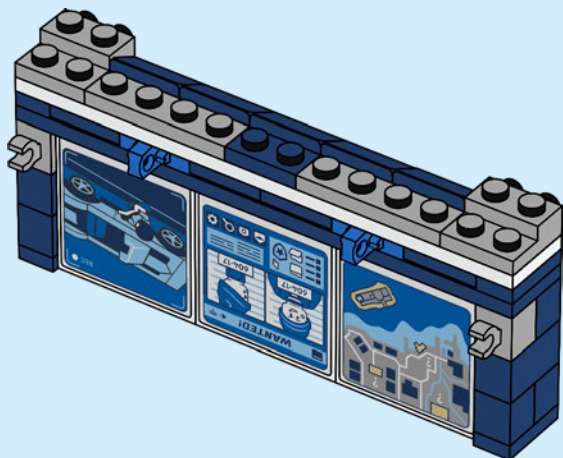

183

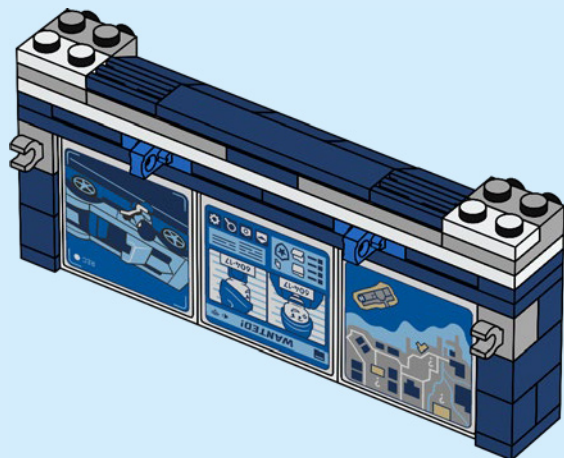

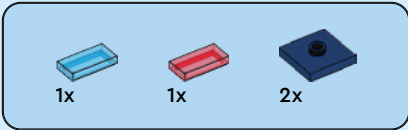

184

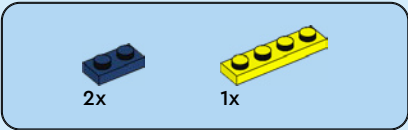
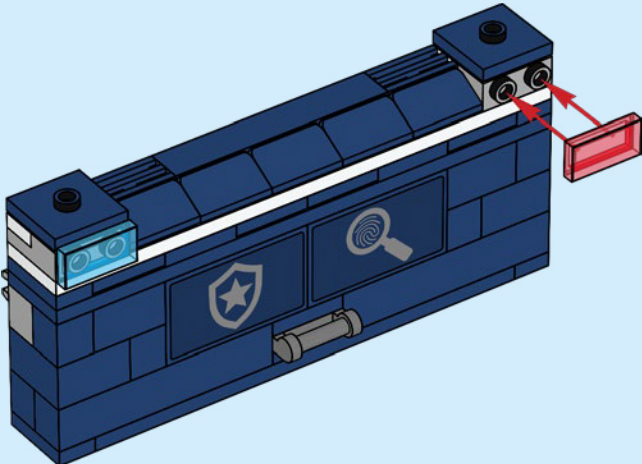

185

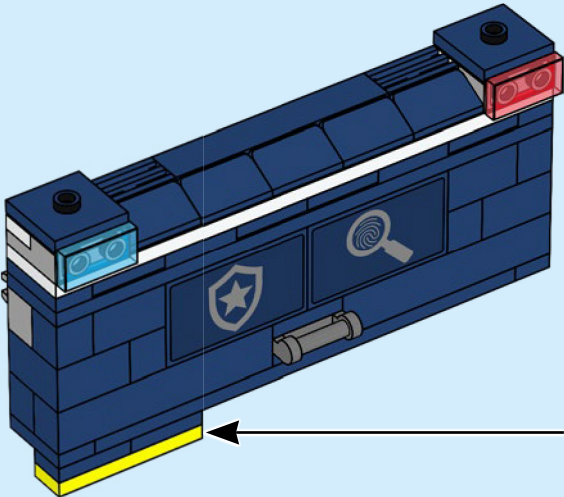
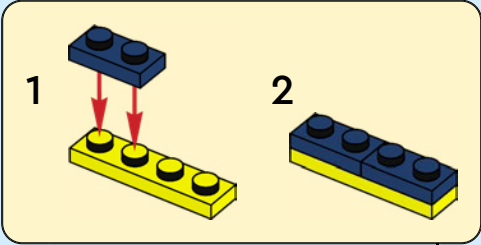

186

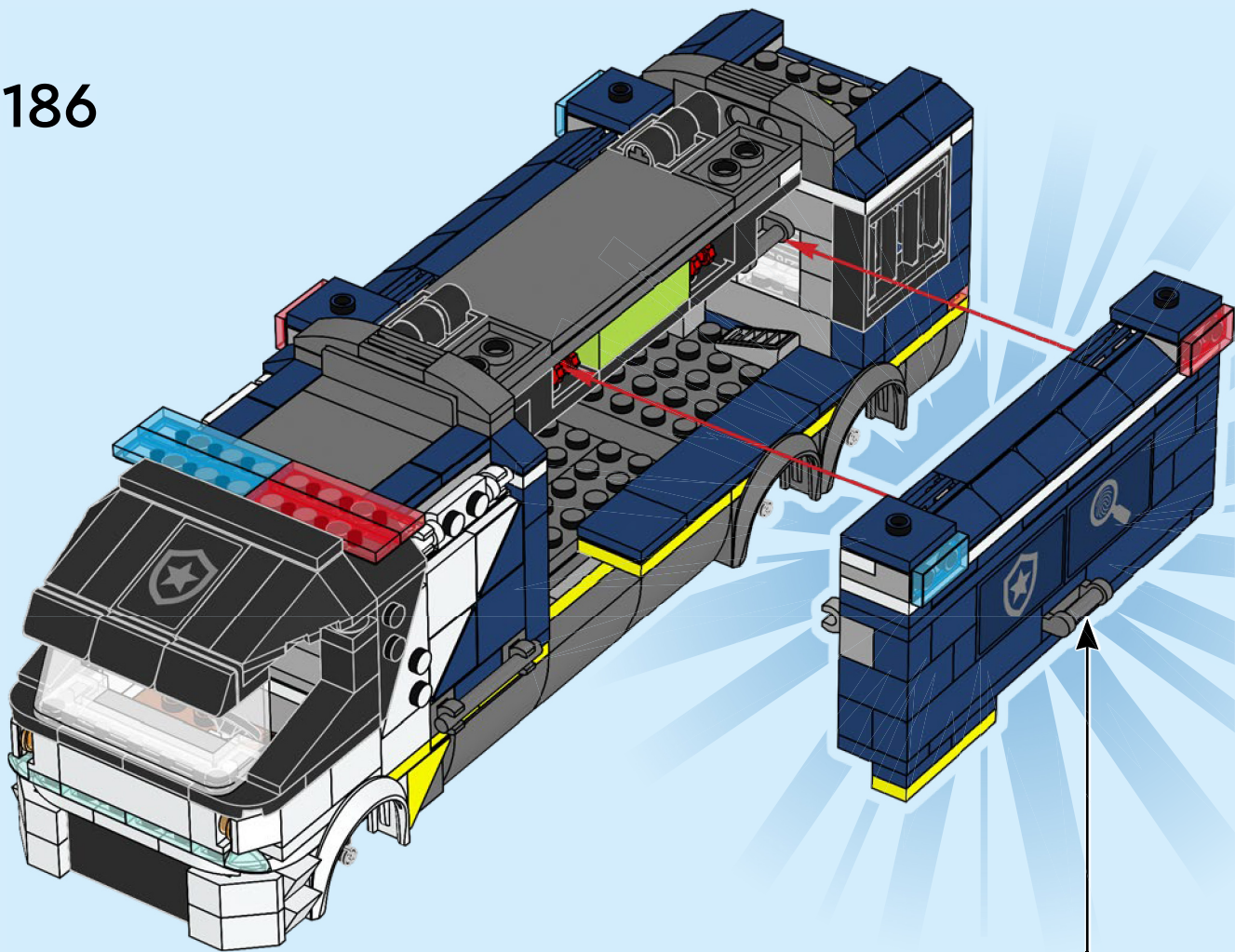

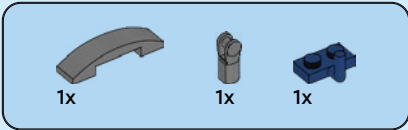

187

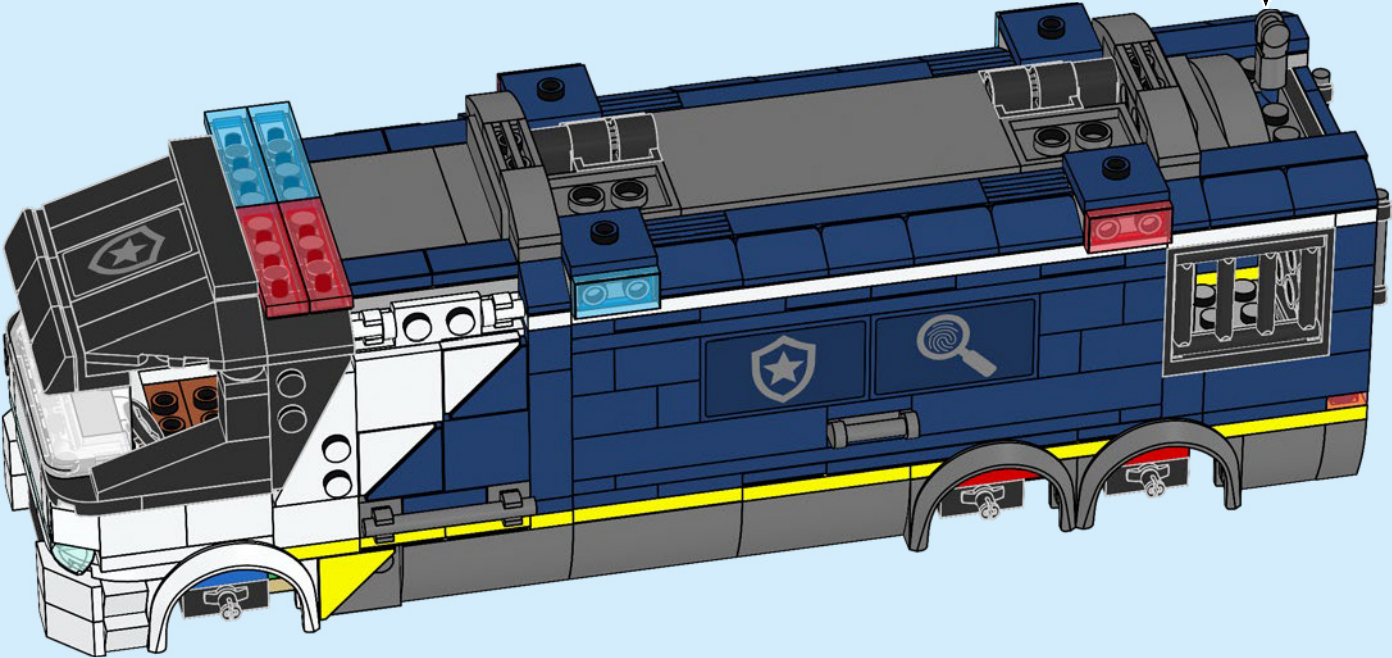
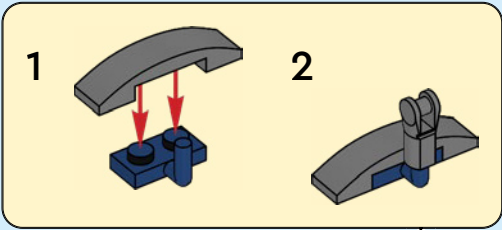



188

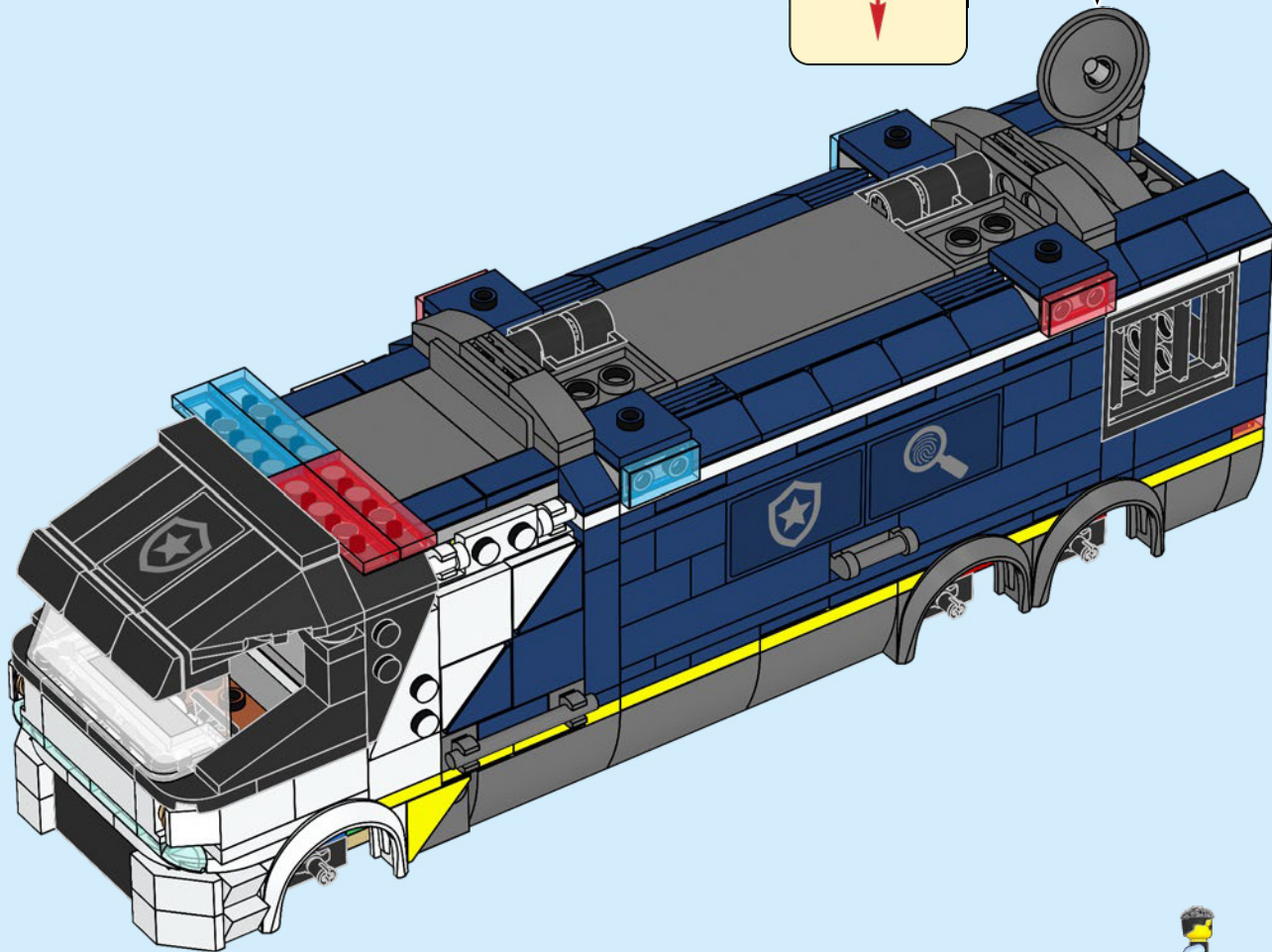
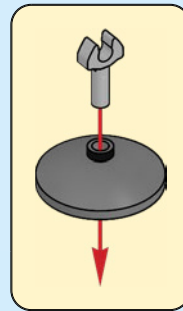

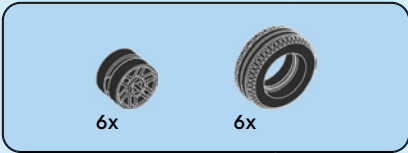

189

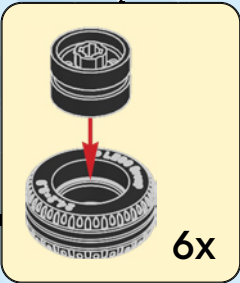
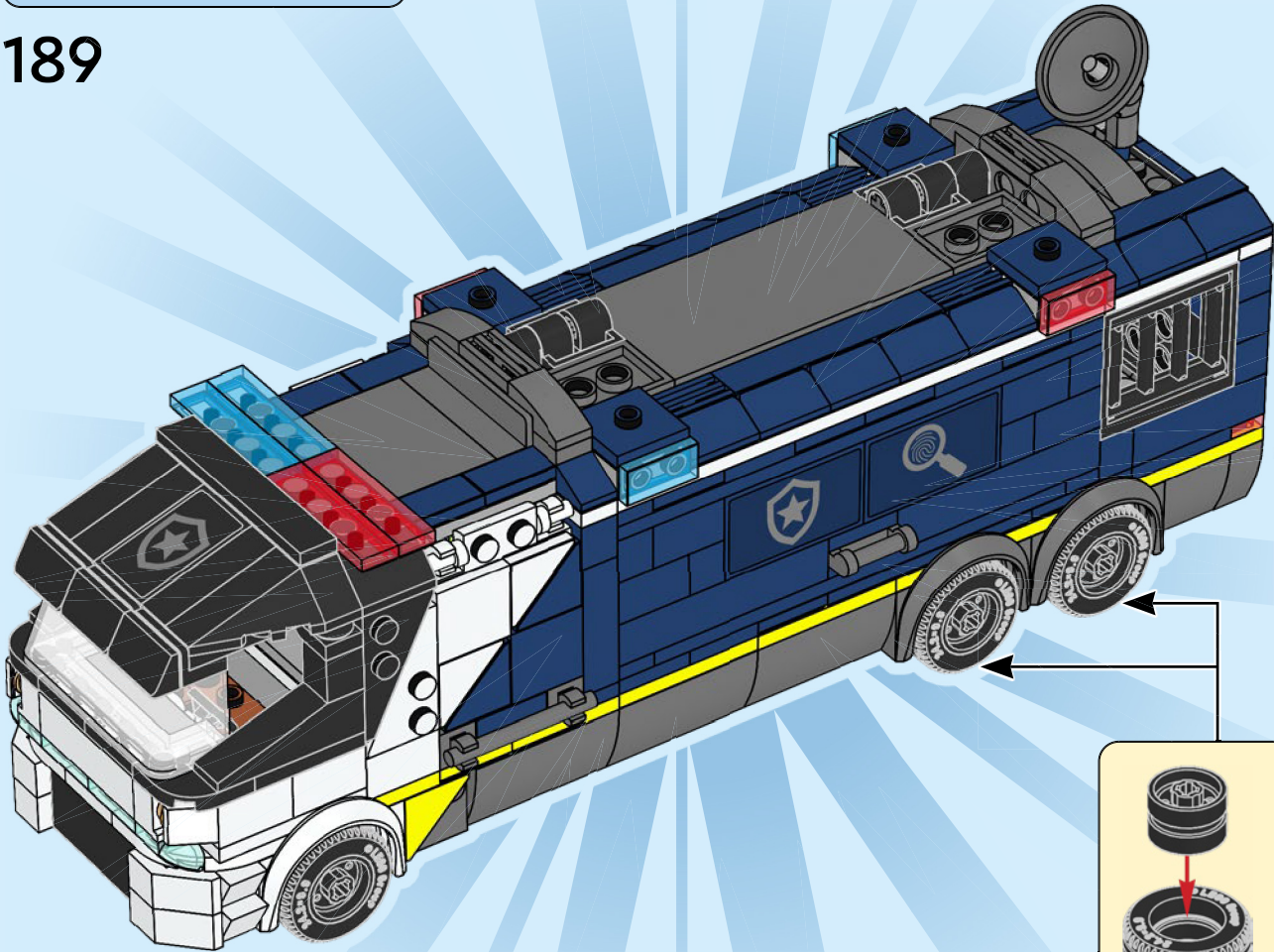



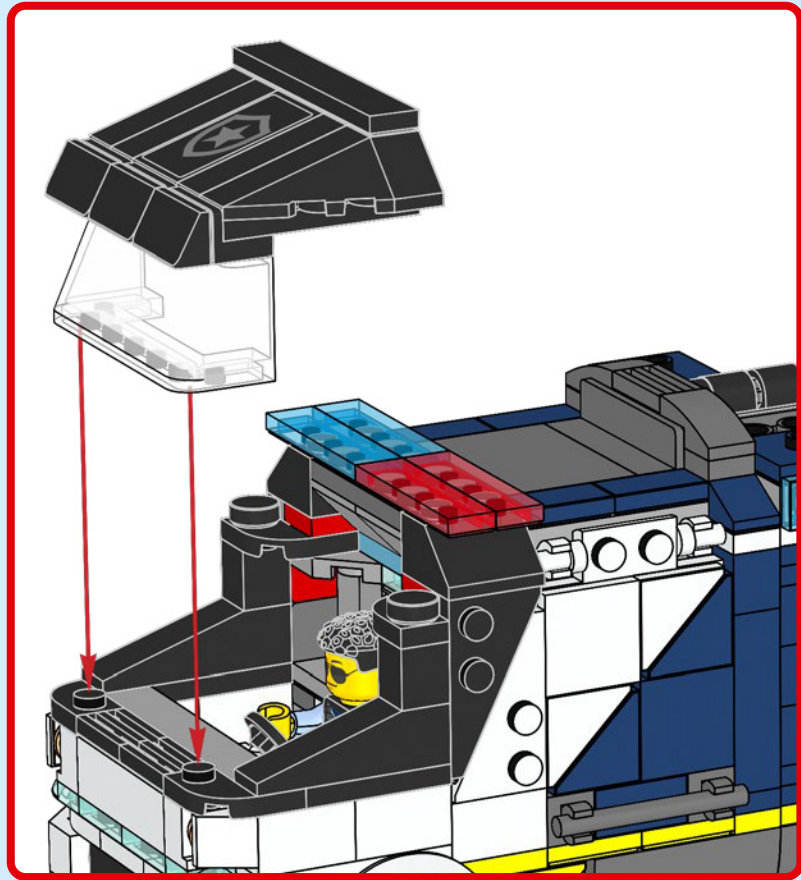







# CITY

60418



60415



60419



60414



60413



  
1x  
4599453

  
2x  
389921

  
1x  
6210269

  
1x  
6184782

  
2x  
6266205

  
11x  
6117974

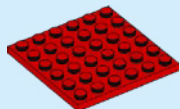

1x  
4144302

  
2x  
6274738

  
2x  
6251294

  
1x  
6244904

  
2x  
6253231

  
1x  
6245195

  
1x  
6341463

  
1x  
4525464

  
1x  
6174813

  
1x  
6283884

  
1x  
6465455

  
1x  
6112622

  
1x  
6174454

  
4x  
6469827

  
1x  
4140587

  
1x  
6126050

  
1x  
6116606

  
7x  
4537937

  
2x  
4234716

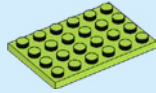
  
1x  
6060848

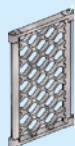

3x  
6469206

  
2x  
6284070

  
2x  
6256435

  
2x  
300526

  
1x  
6356861

  
4x  
6336977

  
1x  
6472859

  
1x  
6325525

  
1x  
6295295

  
1x  
6295293

  
3x  
4548180

  
1x  
6476480

  
10x  
6288175

  
1x  
6308912

  
1x  
302326

  
1x  
6329698

  
2x  
6347310

  
2x  
241226

  
1x  
9551

  
2x  
6403650

  
3x  
6020193

  
1x  
3003126

  
4x  
6029208

  
2x  
6273708

  
2x  
302226

  
1x  
6053077

  
6x  
6482959

  
4x  
6430580

  
2x  
303926

  
2x  
281726

  
6x  
6457145

  
2x  
362326

  
1x  
6470970

  
2x  
4521681

  
2x  
4530589

  
4x  
4515362

  
1x  
6040298

  
2x  
6325276

  
3x  
302026

  
3x  
4560182

  
1x  
6040297

  
1x  
4185583

  
2x  
6039194

  
1x  
663626

  
2x  
6064228

  
1x  
6310190

  
2x  
379526

  
1x  
303226

  
2x  
4107558

  
2x  
6261357

  
1x  
4185177

  
9x  
6395373

  
1x  
6294227

  
3x  
6135287

  
2x  
6210271

  
3x  
6411022

  
16x  
302328

  
1x  
302128

  
2x  
4120158

  
1x  
6126063

  
1x  
6471281

  
1x  
6240515

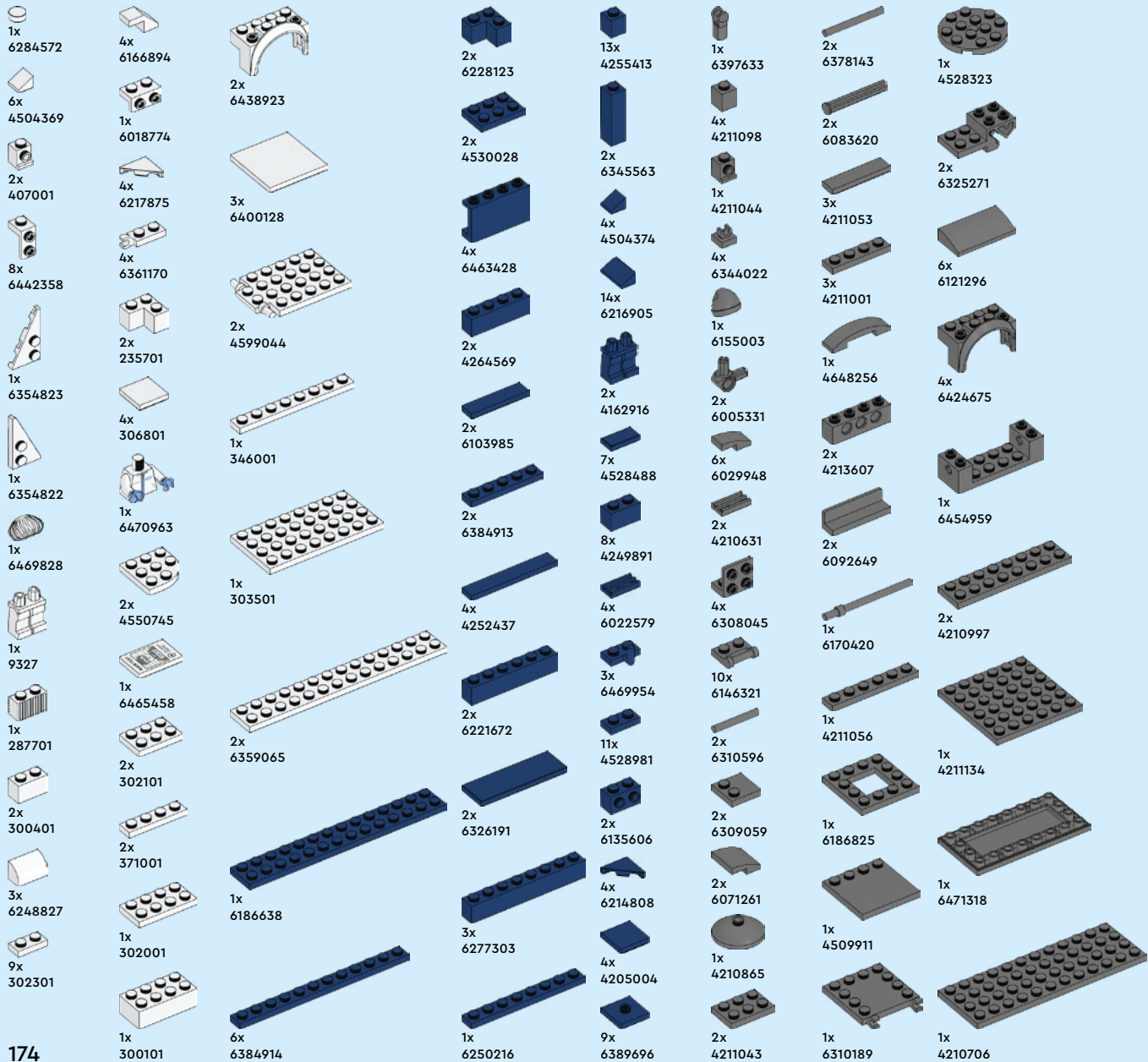



1x  
6450904



1x  
6470966



1x  
6471267



2x  
6213777

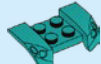

2x  
6291008



1x  
6329593



3x  
6167690



3x  
4569382



1x  
6058135



1x  
6347304



2x  
6055309



3x  
6343854



1x  
6106193



1x  
6004435



2x  
6394948



6x  
6290986



1x  
4211152



1x  
6073984



4x  
6382324



2x  
6425975



4x  
6380131



4x  
6380691



9x  
6388037



3x  
6355732



3x  
4625036



8x  
6240227



3x  
6240212



2x  
6251290



2x  
6390369



1x  
6238677



2x  
6292200



3x  
6240222



2x  
6251289



2x  
6252050



2x  
6266252



1x  
362323



3x  
379523



1x  
346023



2x  
6284071



1x  
6439041



2x  
6061702



2x  
4211415



1x  
6329583



5x  
4211389



2x  
6320306



1x  
4550170



2x  
4211475



2x  
4211383



2x  
6092111



2x  
6186657



4x  
4211388



2x  
4515374



2x  
6093859



4x  
6313114



2x  
6206249



1x  
6004990



1x  
6117967



2x  
4641048



1x  
6065824



2x  
6435857



1x  
4211349



2x  
6102357



4x  
6469440



1x  
6306721



8x  
6230234



1x  
6118827



2x  
6132207



6x  
4211445



1x  
4211636



1x  
4211394



3x  
6262961



4x  
4211395



1x  
6108560



3x  
4211549



4x  
4211393



1x  
4211393

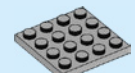

2x  
4243797

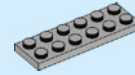

1x  
4211452



1x  
4211795



1x  
4211474

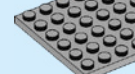

2x  
4211425



1x  
4251149



1x  
4211522



[LEGO.com/service](https://www.LEGO.com/service)

YOU COULD **WIN**



Scan this QR code or go to **LEGO.COM/PRODUCTFEEDBACK** and give us your short feedback about this LEGO® set for a chance to win a cool LEGO prize.

Terms and Conditions apply\*

**EN: YOU COULD WIN.** Terms and Conditions apply\* **DE: Du könntest GEWINNEN.** Es gelten die Teilnahmebedingungen\* **FR: Tu pourrais GAGNER.** Des conditions s'appliquent\* **IT: Potresti VINCERE tu.** Termini e condizioni sono applicabili\* **ES: Puedes GANAR.** Aplican términos y condiciones\* **PT: Poderá GANHAR.** Aplicam-se termos e condições\* **ZH: 轻松获奖. 条款和条件适用\*** **PL: Szansa na WYGRANĄ.** Obowiązują warunki korzystania\* **CS: Máte šanci VYHRÁT.** Platí všeobecné smluvní podmínky\* **SK: Máte šancu VYHRAŤ.** Platia všeobecné zmluvné podmienky\* **HU: TE IS NYERHETSZ.** Felhasználási feltételek érvényesek\* **RO: Ai putea CÂȘTIGA.** Se aplică termeni și condiții\* **BG: Можете да СПЕЧЕЛИТЕ.** Има определени правила и условия\* **LV: Tu vari LAIMĒT.** Ir spēkā noteikumi un nosacījumi.\* **ET: Sul on võimalus VÕITA.** Kehtivad tingimused\* **LT: Jūs galite LAIMĖTI.** Taikomos sąlygos\*

\*[LEGO.com/productfeedback-terms](https://www.lego.com/productfeedback-terms)