



# CITY

60413





LEGO® Builder



[LEGO.com/sustainable-packaging](https://LEGO.com/sustainable-packaging)



 <sup>FR</sup> **DONNEZ  
OU  
RECYCLEZ**  OU  OU   
ASSOCIATION MAGASIN DÉCHÈTERIE

Adresses sur [quefairedemesdechets.fr](https://quefairedemesdechets.fr)

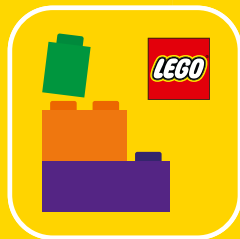

# BUILDER



Apple and the Apple logo are trademarks of Apple Inc., registered in the U.S. and other countries and regions. App Store is a service mark of Apple Inc. Google Play and the Google Play logo are trademarks of Google LLC. Tencent and the Tencent logo are trademarks of Tencent Inc.

Q [LEGO.com/devicecheck](https://www.lego.com/devicecheck)

**EN** Ask parents' permission before going online | **DE** Eltern um Erlaubnis bitten, bevor du online gehst | **FR** Demande l'autorisation d'un parent avant d'aller en ligne | **IT** Chiedi il permesso ai tuoi genitori prima di andare online | **ES** Pídeles permiso a tus papás antes de conectarte a Internet | **PT** Peça autorização aos pais antes de acederes online | **ZH** 上网前应先征得父母的同意 | **PL** Poproś rodziców o zgodę, zanim wejdziesz do Internetu | **CS** Než půjdeš na internet, požádej rodiče o svolení | **SK** Skôr než pôjdeš na internet, vypýtaj si povolenie od rodičov | **HU** Kérj szülői engedélyt, mielőtt online csatlakoznál! | **RO** Cere permisiunea părinților înainte de a te conecta online | **BG** Поискайте разрешение от родител, преди да влезете онлайн | **LV** Pirms došanās tiešsaistē palūdz atļauju vecākiem | **ET** Enne Interneti kasutamist küsi vanematelt luba | **LT** Prieš prisijungdami prie interneto, atsiklauskite tėvų

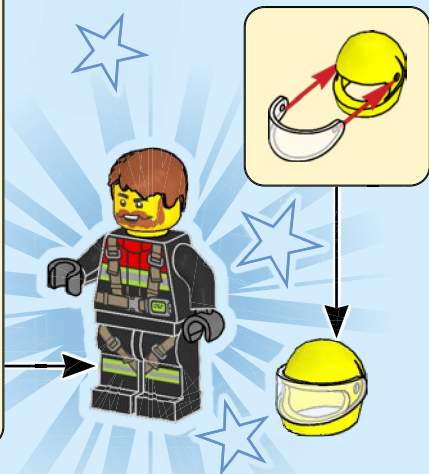
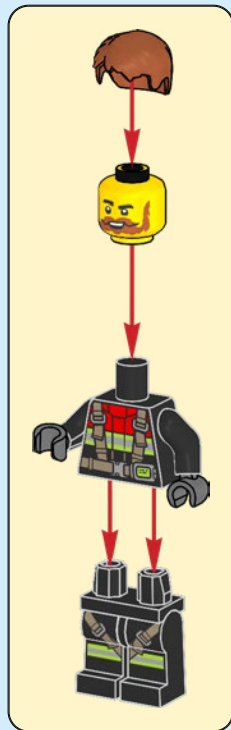

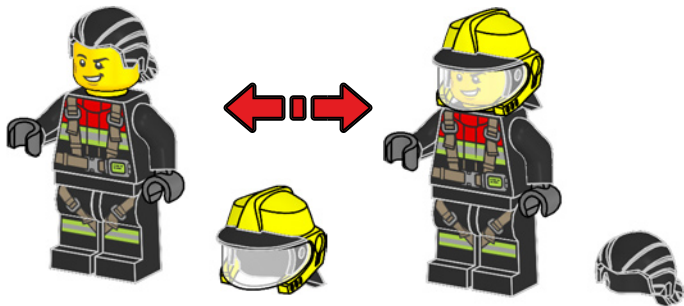
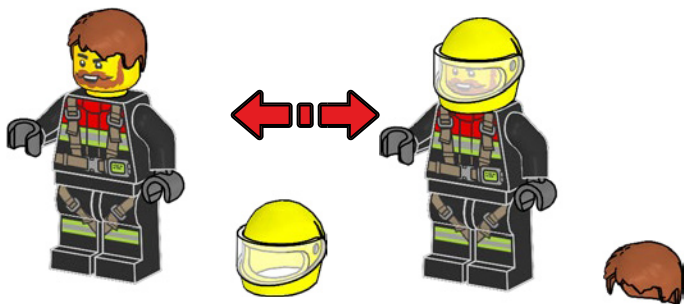
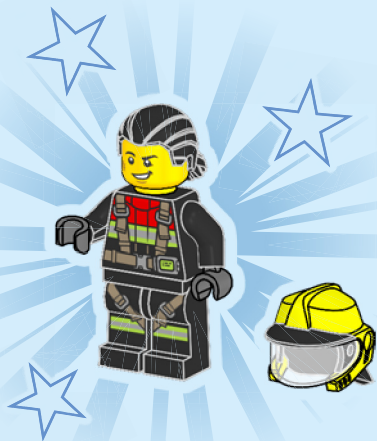

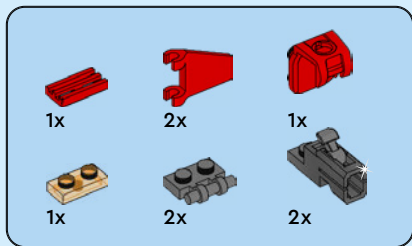

1

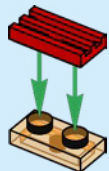

2

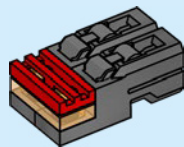

3

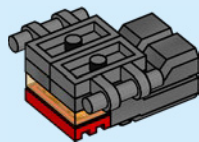

4

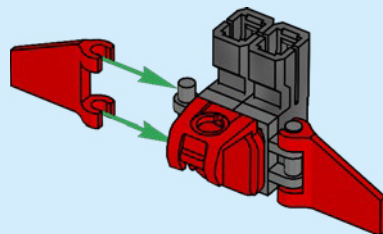

1

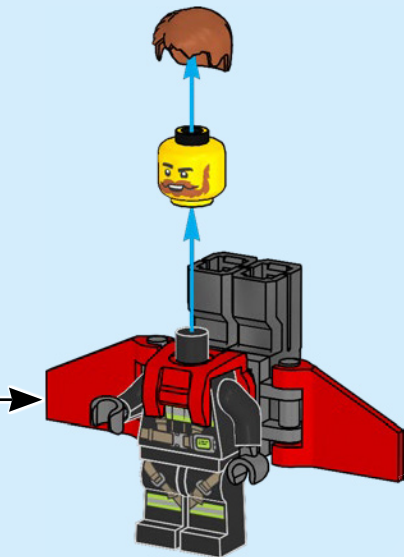

2

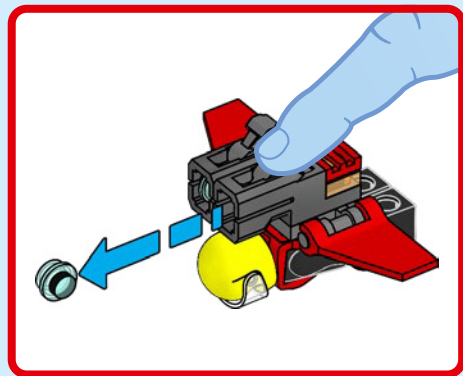
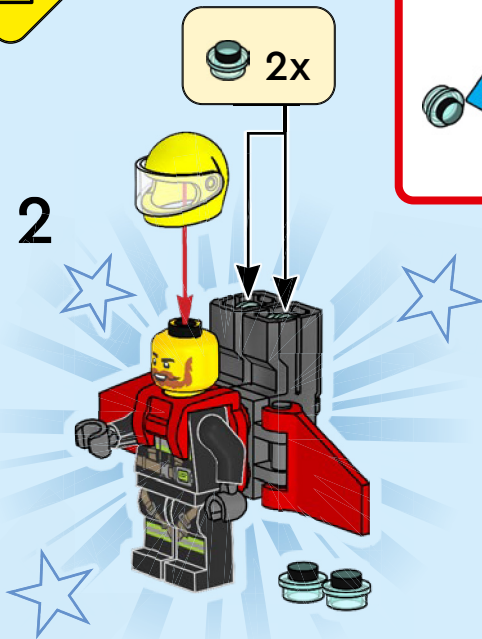

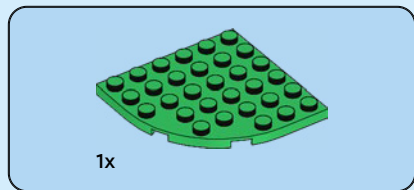

1

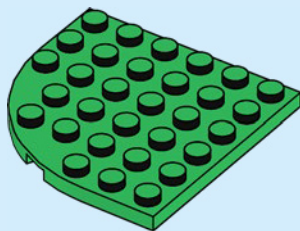





1x



1x

2

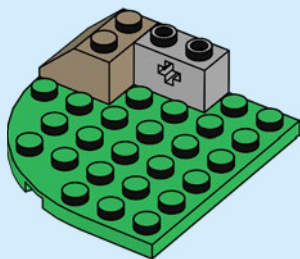

1x

3

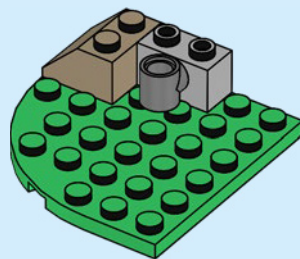



4

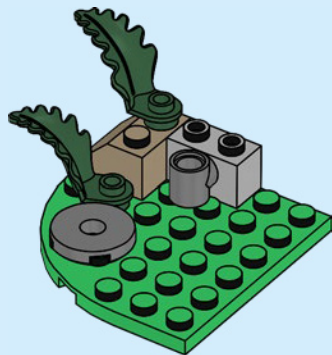



2x

5

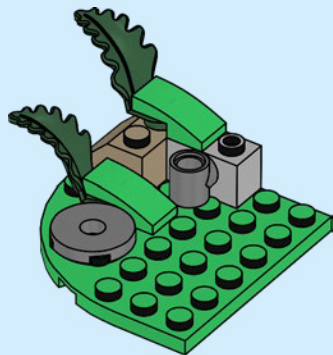

1x

6

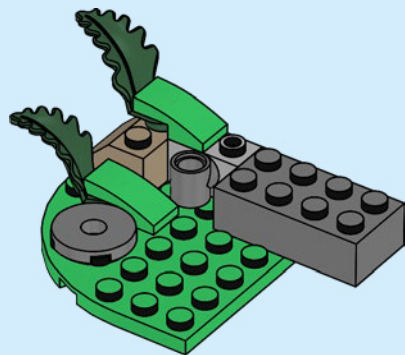

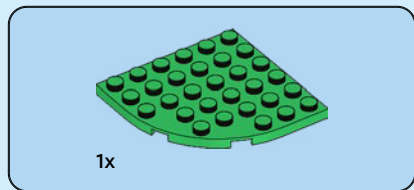

7

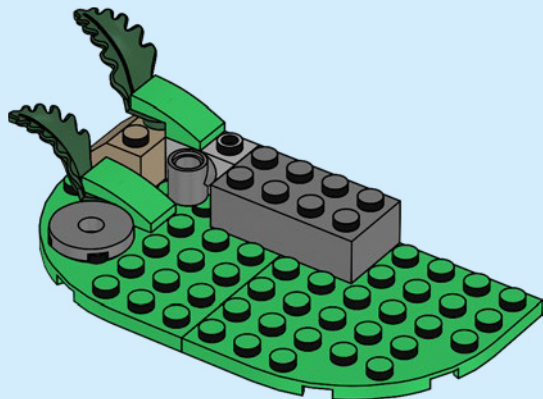







1x

11

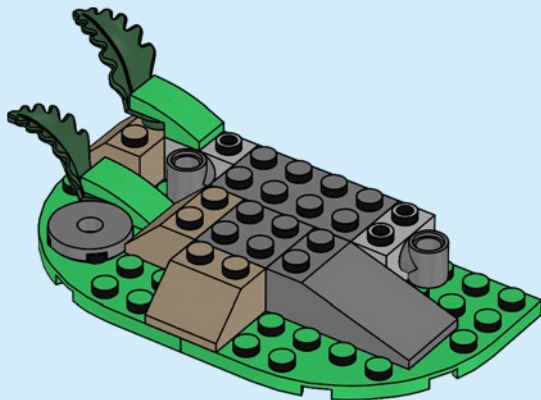

1x

12

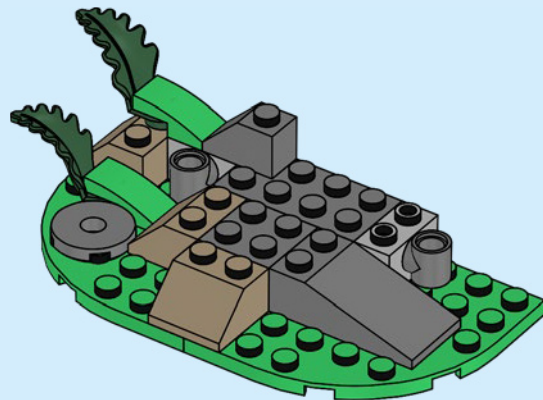

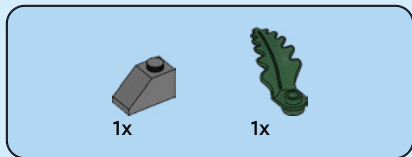

13

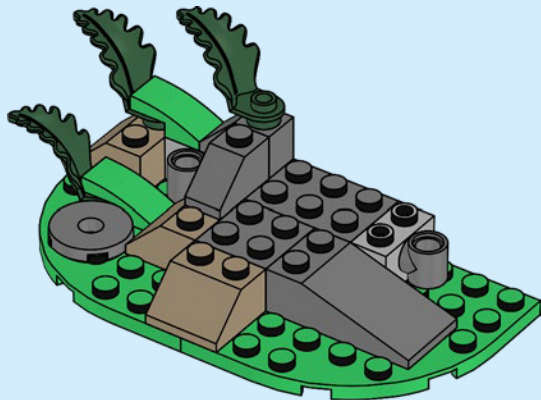





1x

14

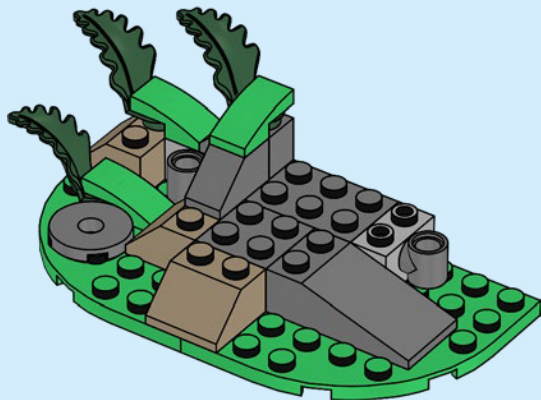

1x

15

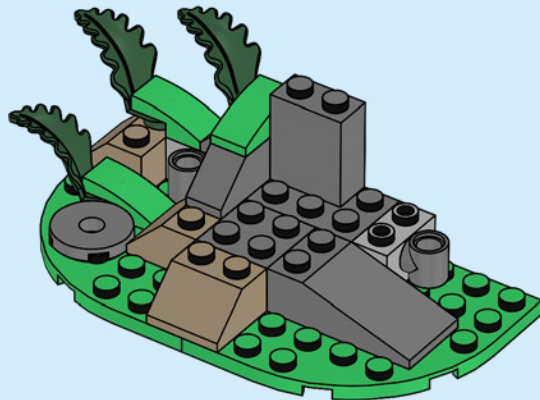



2x

16

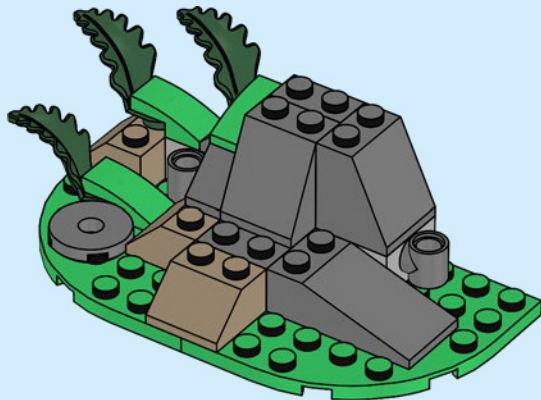



2x

17

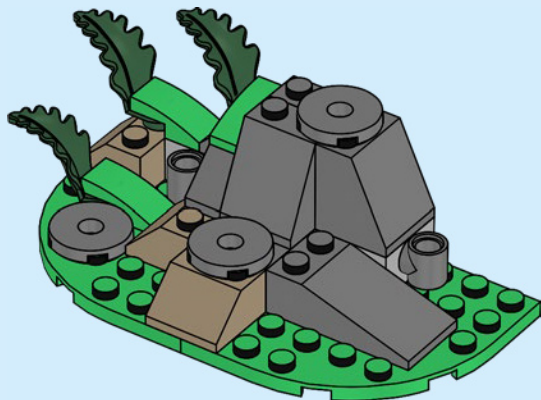

2x

18

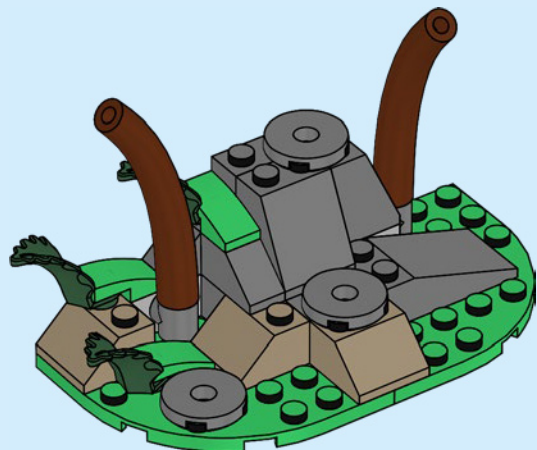

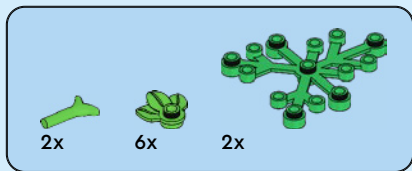
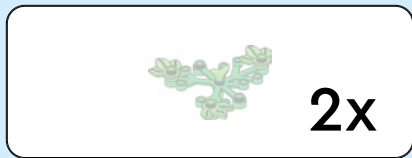

19

1



2

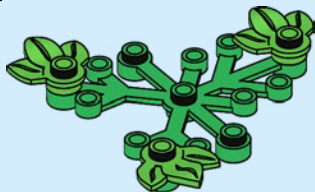

3

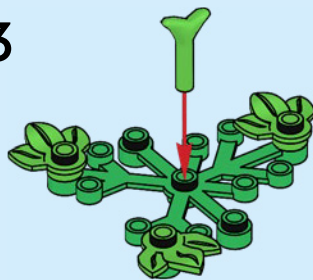

2x

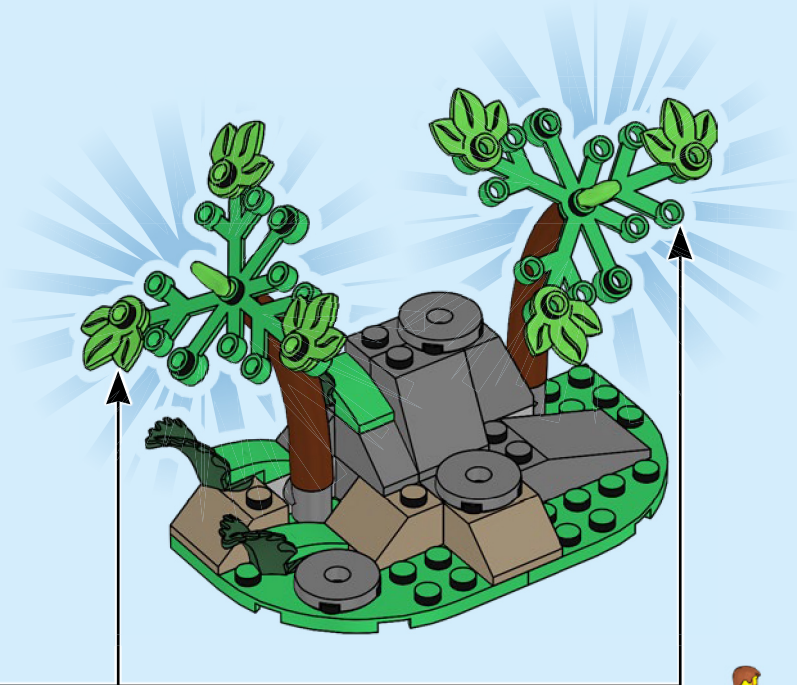



6x



3x

20

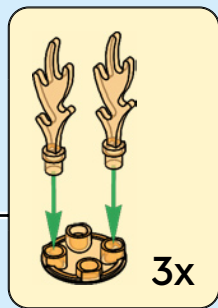



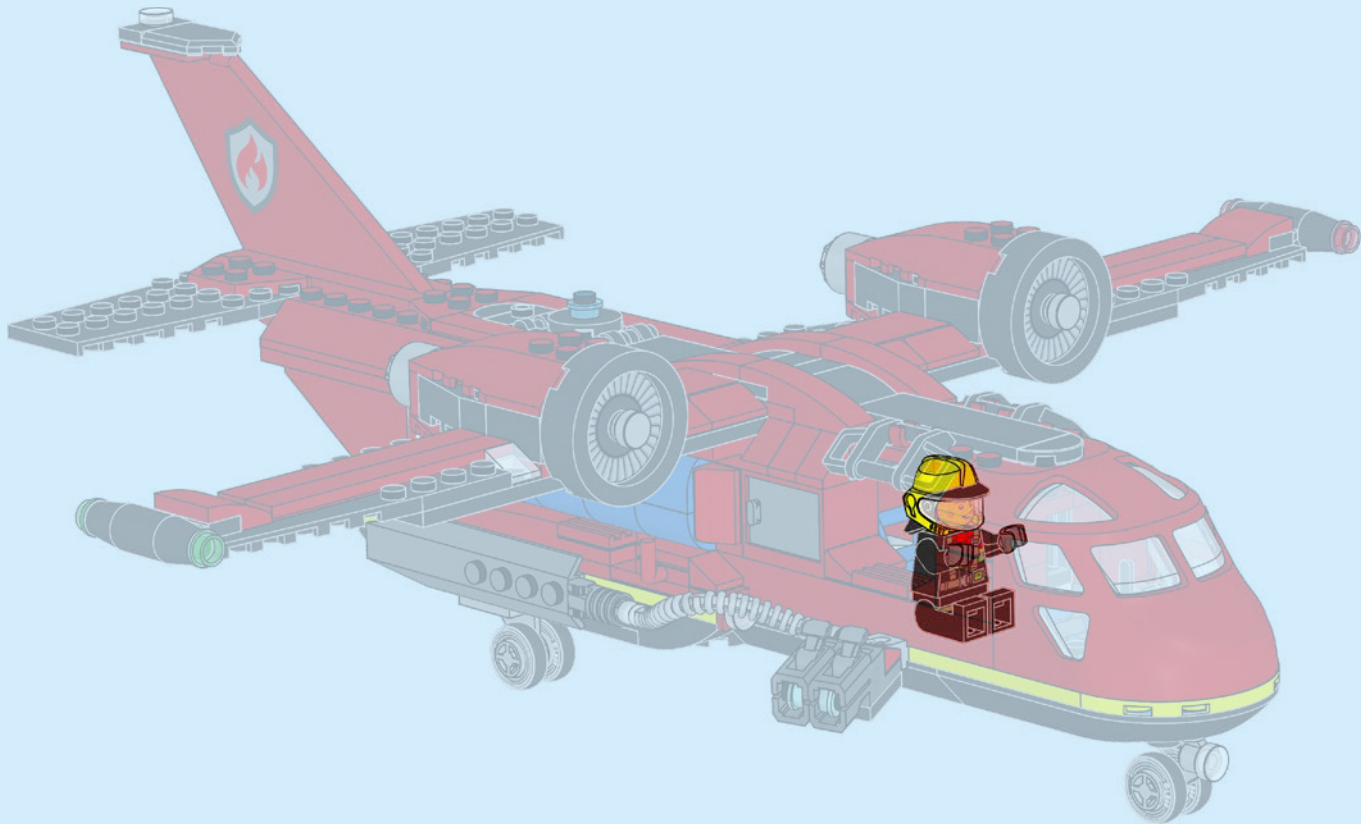







# CITY



60419



  
6x  
6383985

  
1x  
4544140

  
2x  
6347293

  
1x  
4649167

  
1x  
300401

  
2x  
243201

  
1x  
6117940

  
2x  
6218822

  
2x  
6329582

  
6x  
300801

  
1x  
6024495

  
4x  
6219794

  
1x  
6248495

  
1x  
6046924

  
2x  
4118790

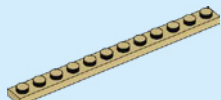
  
2x  
6156462

  
4x  
407021

  
4x  
4504379

  
2x  
6372478

  
20x  
4651524

  
4x  
6347308

  
4x  
302321

  
6x  
241221

  
2x  
6393320

  
4x  
6275178

  
3x  
6261351

  
1x  
303921

  
4x  
6105976

  
2x  
300321

  
2x  
306821

  
2x  
6465537

  
2x  
6365503

  
1x  
6472570

  
5x  
6023770

  
2x  
6189130

  
2x  
6395370

  
2x  
4619543

  
2x  
301021

  
10x  
371021

  
4x  
6045937

  
2x  
303721

  
2x  
4560179

  
1x  
4181138



2x  
6409628

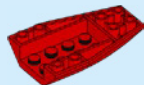

1x  
6096487



8x  
416221



2x  
346021



2x  
447721

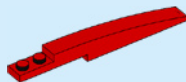

2x  
6208565

28

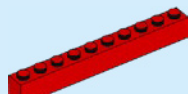

2x  
611121



1x  
6472561

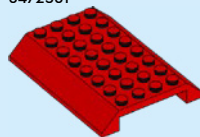

1x  
6472685

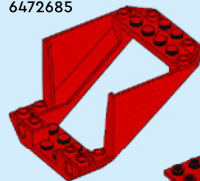

1x  
6472690



1x  
6465535

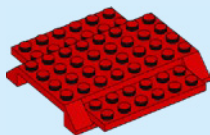

1x  
6472686



2x  
243223



8x  
6472562



5x  
302223



4x  
6427428



1x  
6328351



1x  
6283884



1x  
6434805



1x  
6380157



1x  
6245281



2x  
4273590



1x  
6292569



6x  
4516843



2x  
6420852



8x  
6279875



2x  
6195273



1x  
6195325



1x  
6143335



1x  
6315887



2x  
6092585



4x  
300426



1x  
6261348



1x  
6347310



1x  
6382697



2x  
6306819



5x  
6325254



2x  
6053077



2x  
6448318



1x  
6245251



1x  
6143834



2x  
6472092



2x  
6465534



2x  
6359942



2x  
6099483



2x  
4660876



4x  
6039869



3x  
6254045



1x  
4558209



2x  
6358291



1x  
6360129



2x  
6290416



2x  
663626



1x  
6318582



1x  
379526

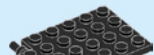

1x  
6057903



2x  
346026



1x  
6296083



1x  
6472689



1x  
6472683

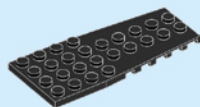

4x  
6290979



1x  
6472684

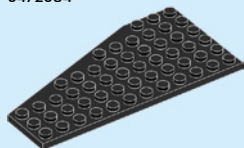

1x  
6394881

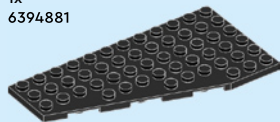

1x  
4143180



3x  
6047426



2x  
6266968

30

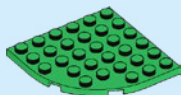

2x  
6021999



6x  
6182261



2x  
4119479



1x  
4529755



6x  
6274738



2x  
6245250



2x  
6244787



1x  
6469628



1x  
6472560



12x  
6240225



7x  
6273153



1x  
6240214



6x  
6240215



2x  
6240221



8x  
6325978



1x  
6273853



2x  
6291782



3x  
6184880



2x  
6031821



2x  
6208450



3x  
6447541



6x  
6167741



3x  
6171727



1x  
6240217



1x  
6443720



2x  
6326087



10x  
4211412



4x  
6329581



2x  
6284071



6x  
6194808



1x  
6331440



2x  
6307931



1x  
4211414



2x  
6329662



2x  
6206249



1x  
4244627



2x  
6296979



4x  
6177078



2x  
6043639



1x  
6302648



1x  
4217918



2x  
6061675



4x  
4251149



1x  
4211081



4x  
6228923



2x  
6265702



2x  
6281996



3x  
6055313



2x  
6135014



1x  
6302690



1x  
4210978



2x  
4211135



2x  
4210811



2x  
4210660



2x  
4234534



1x  
4211060



4x  
4211104



4x  
6271127



1x  
4210637



1x  
4211085



1x  
6186825

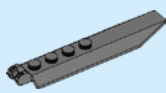

2x  
6410334



2x  
6194553



6x  
6426647



2x  
6376232



1x  
6468541



1x  
6431537



11x  
6382324



4x  
6380691



2x  
6389817



1x  
6421396



6x  
6391549

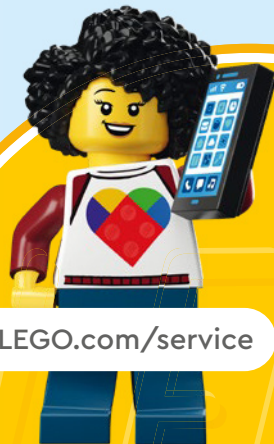

 [LEGO.com/service](https://www.LEGO.com/service)

YOU COULD **WIN**



Scan this QR code or go to **LEGO.COM/PRODUCTFEEDBACK** and give us your short feedback about this LEGO® set for a chance to win a cool LEGO prize.

Terms and Conditions apply\*



**EN: YOU COULD WIN.** Terms and Conditions apply\* **DE: Du könntest GEWINNEN.** Es gelten die Teilnahmebedingungen\* **FR: Tu pourrais GAGNER.** Des conditions s'appliquent\* **IT: Potresti VINCERE tu.** Termini e condizioni sono applicabili\* **ES: Puedes GANAR.** Aplican términos y condiciones\* **PT: Poderá GANHAR.** Aplicam-se termos e condições\* **ZH: 轻松获奖. 条款和条件适用\*** **PL: Szansa na WYGRANĄ.** Obowiązują warunki korzystania\* **CS: Máte šanci VYHRÁT.** Platí všeobecné smluvní podmínky\* **SK: Máte šancu VYHRAŤ.** Platia všeobecné zmluvné podmienky\* **HU: TE IS NYERHETSZ.** Felhasználási feltételek érvényesek\* **RO: Ai putea CÂȘTIGA.** Se aplică termenii și condiții\* **BG: Можете да СПЕЧЕЛИТЕ.** Има определени правила и условия\* **LV: Tu vari LAIMĒT.** Ir spēkā noteikumi un nosacījumi.\* **ET: Sul on võimalus VÕITA.** Kehtivad tingimused\* **LT: Jūs galite LAIMĖTI.** Taikomos sąlygos\*

\*[LEGO.com/productfeedback-terms](https://www.lego.com/productfeedback-terms)

LEGO and the LEGO logo are trademarks of the LEGO Group. ©2024 The LEGO Group.

6492730