



CITY

60411





LEGO.com/sustainable-packaging



FR
DONNEZ
OU
RECYCLEZ

 OU  OU 

ASSOCIATION MAGASIN DÉCHÈTERIE

Adresses sur quefairedemesdechets.fr

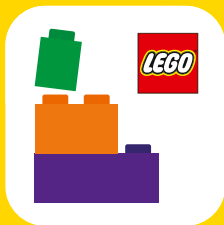

BUILDER



Apple and the Apple logo are trademarks of Apple Inc., registered in the U.S. and other countries and regions. App Store is a service mark of Apple Inc. Google Play and the Google Play logo are trademarks of Google LLC. Tencent and the Tencent logo are trademarks of Tencent Inc.

🔍 LEGO.com/devicecheck

EN Ask parents' permission before going online | **DE** Eltern um Erlaubnis bitten, bevor du online gehst | **FR** Demande l'autorisation d'un parent avant d'aller en ligne | **IT** Chiedi il permesso ai tuoi genitori prima di andare online | **ES** Pídeles permiso a tus papás antes de conectarte a Internet | **PT** Peça autorização aos pais antes de acederes online | **ZH** 上网前应先征得父母的同意 | **PL** Poproś rodziców o zgodę, zanim wejdiesz do Internetu | **CS** Než půjdeš na internet, požádej rodiče o svolení | **SK** Skôr než pôjdeš na internet, vypýtaj si povolenie od rodičov | **HU** Kérj szülői engedélyt, mielőtt online csatlakoznál! | **RO** Cere permisiunea părinților înainte de a te conecta online | **BG** Поискайте разрешение от родител, преди да влезете онлайн | **LV** Pirms došanās tiešsaistē palūdz atļauju vecākiem | **ET** Enne Interneti kasutamist küsi vanematelt luba | **LT** Prieš prisijungdami prie interneto, atsiklauskite tėvų





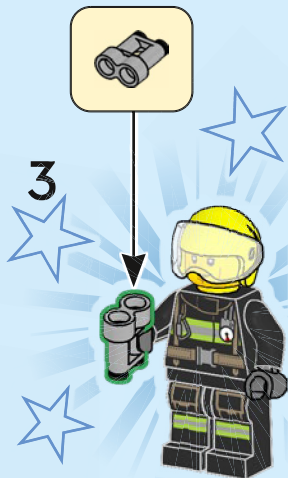
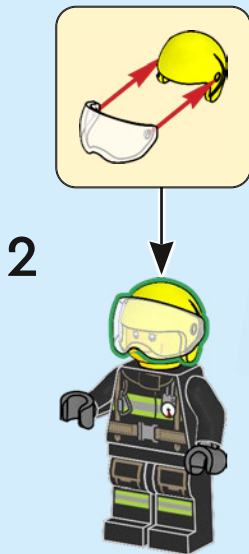
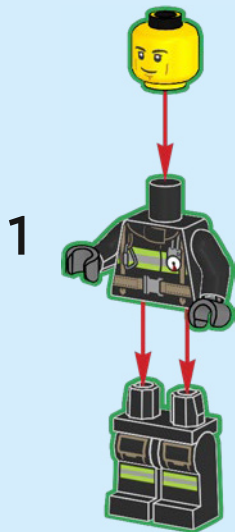

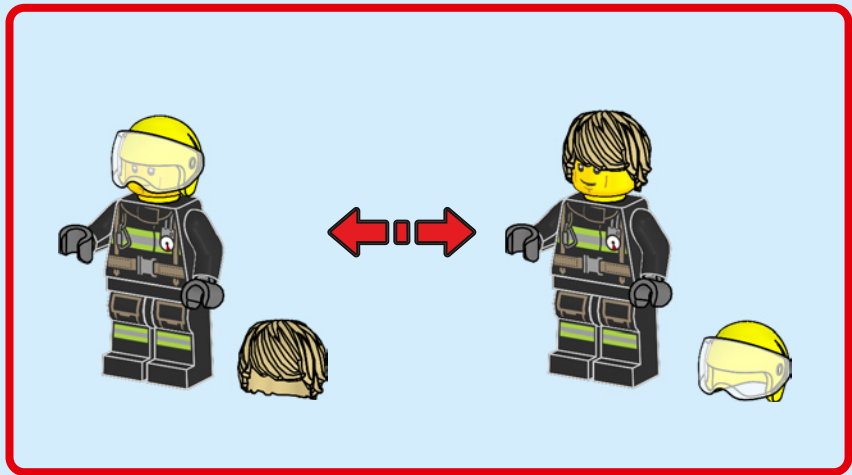



1



2



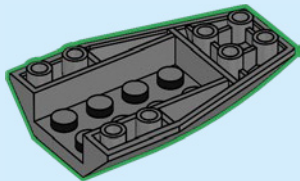
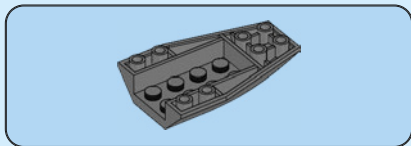
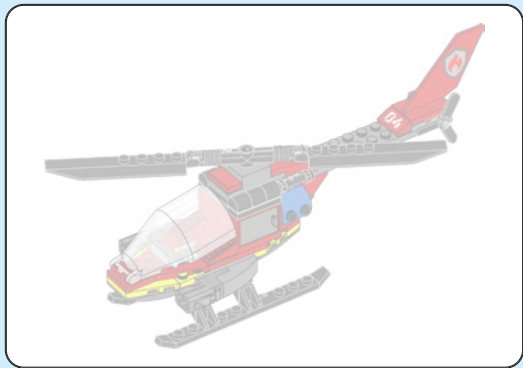

1

8



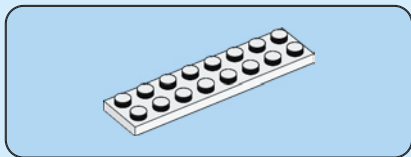

2

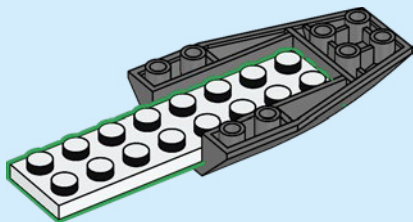

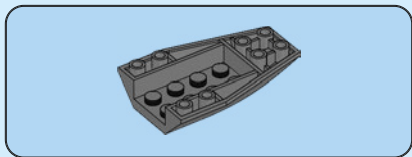

3

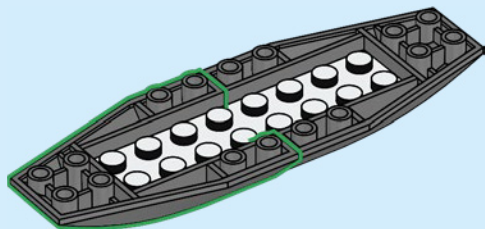

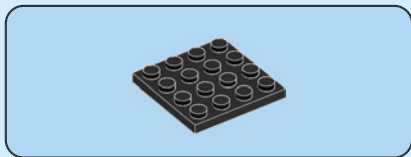

4

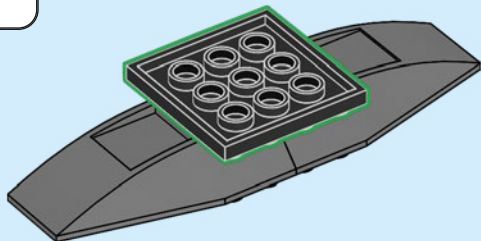

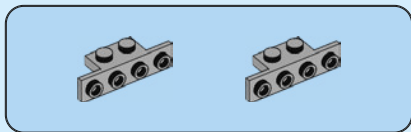

5

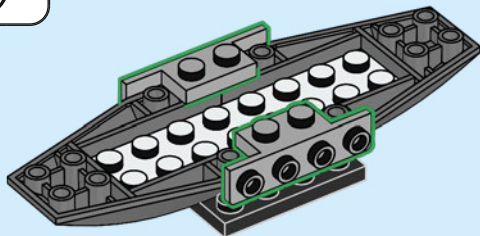

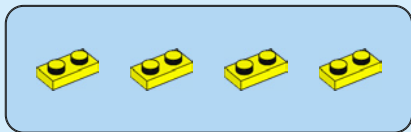

6

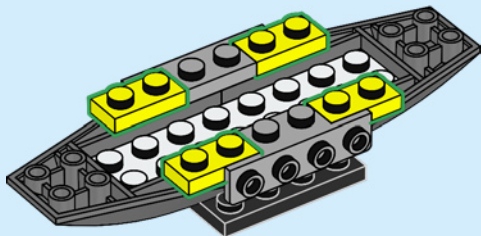

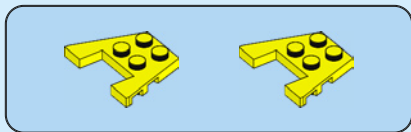

7

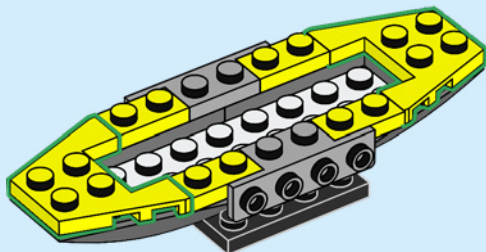

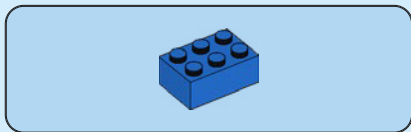

8

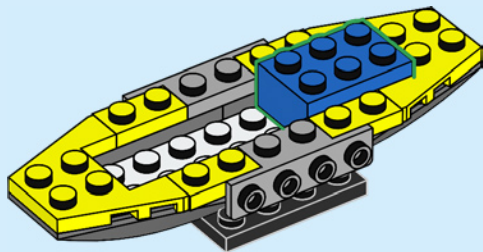



9

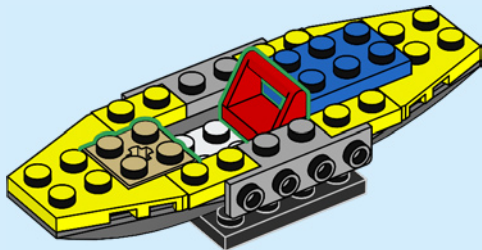

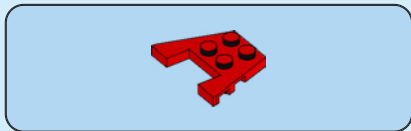

10

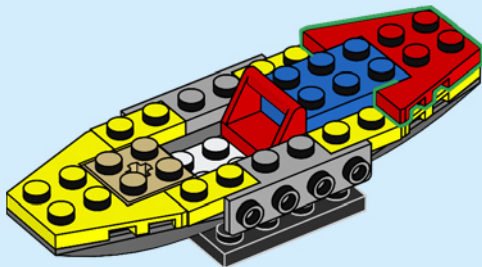

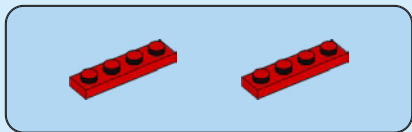

11

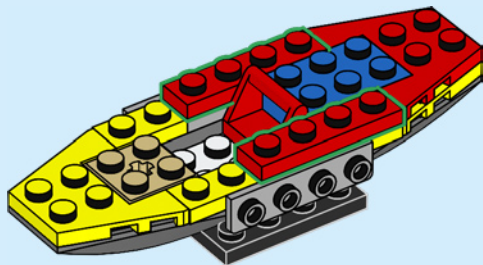

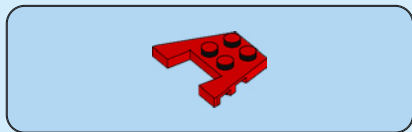

12

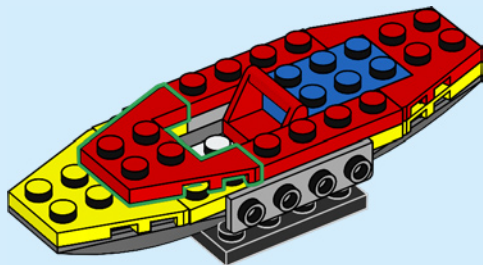



13

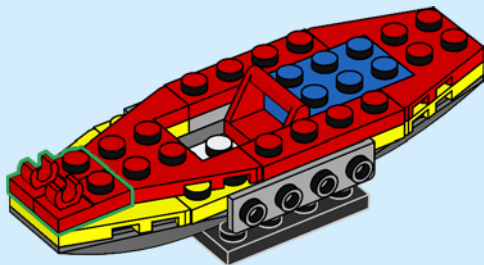

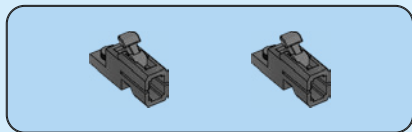

14

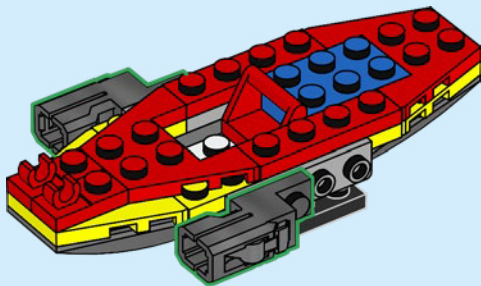

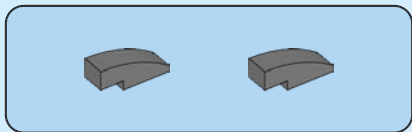

15

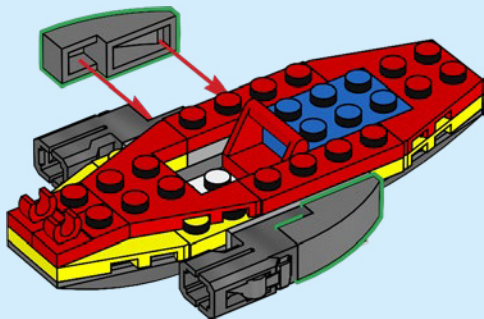

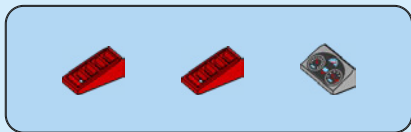

16

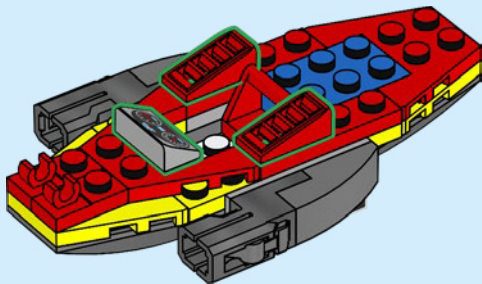

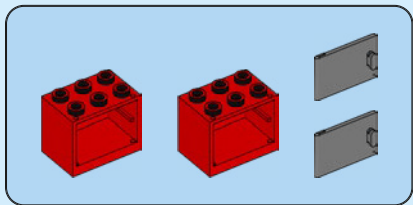
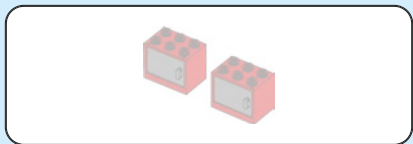

17

1

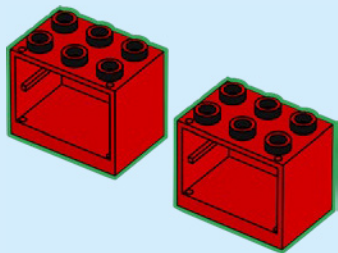

2

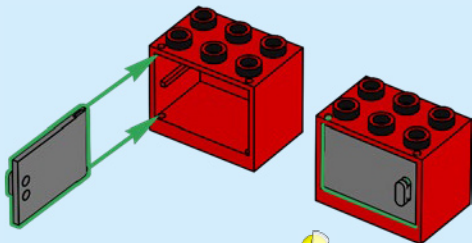

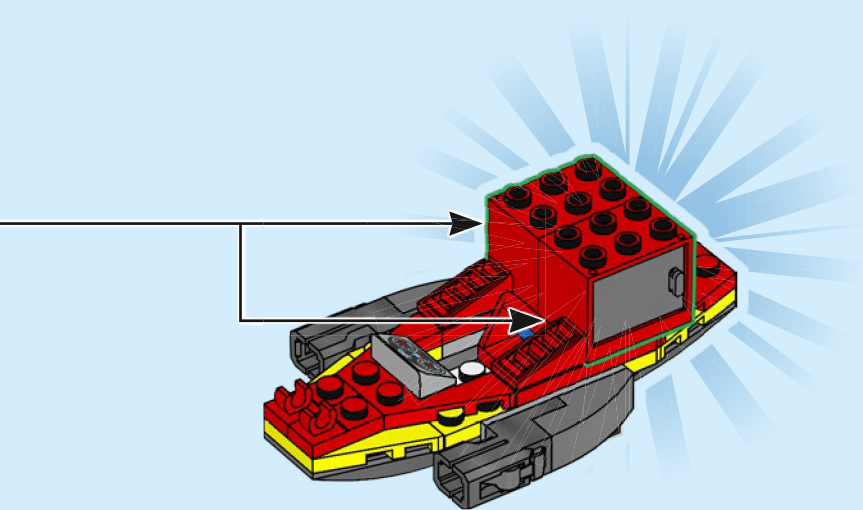

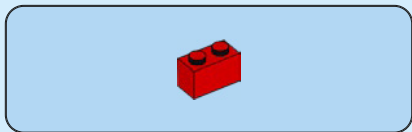

18

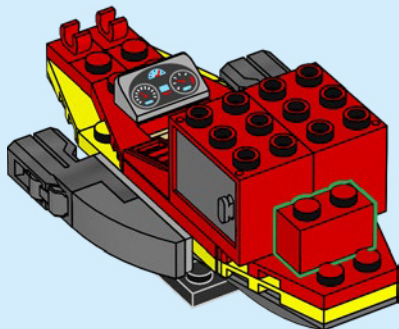

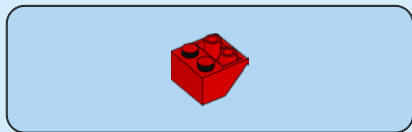

19

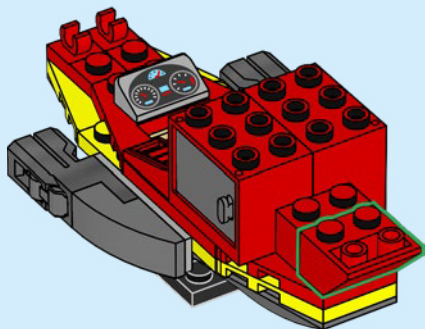



20

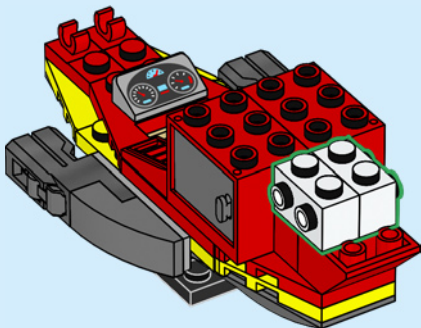



21

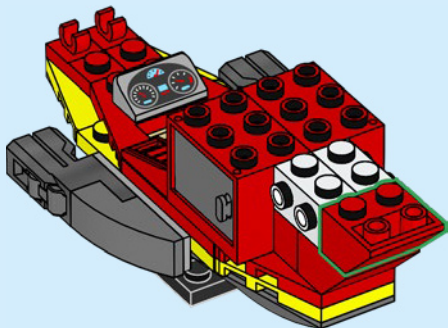

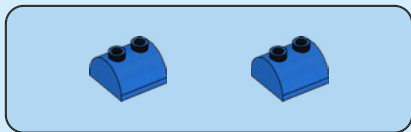

22

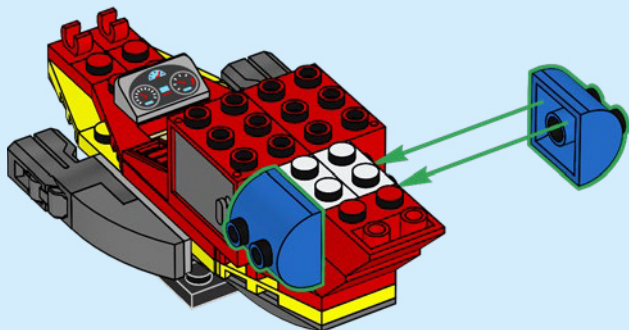

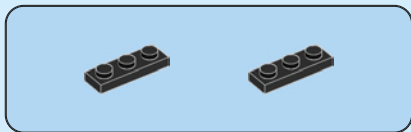

23

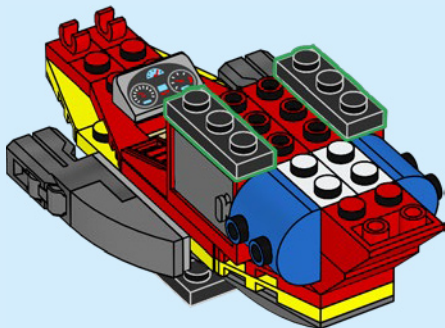



24

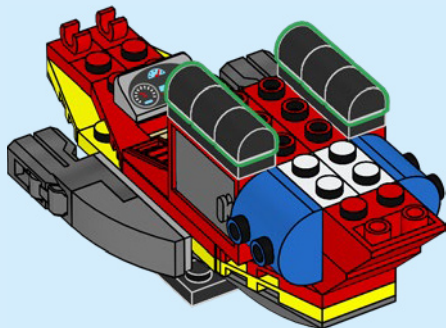

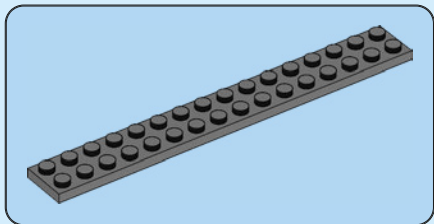
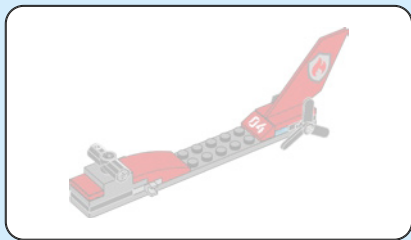

25

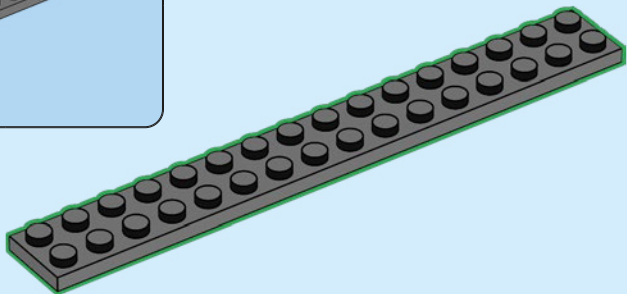

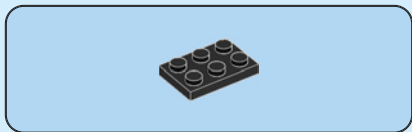

26

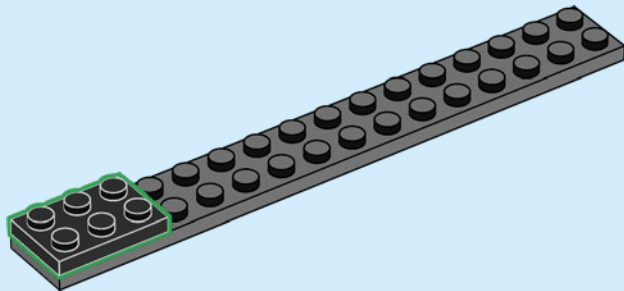

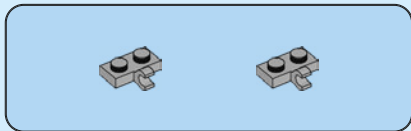

27

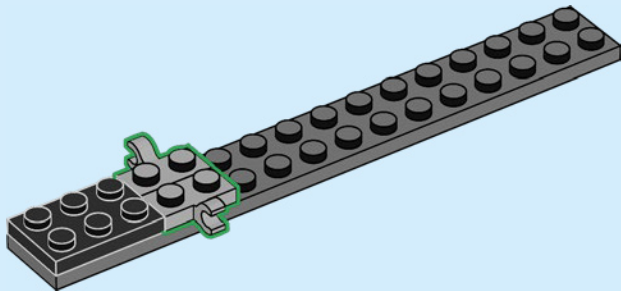

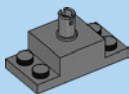

28

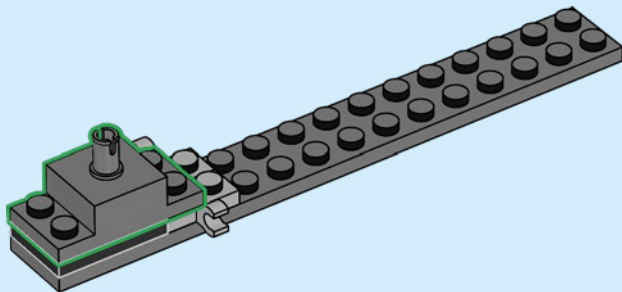

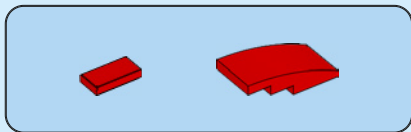

29

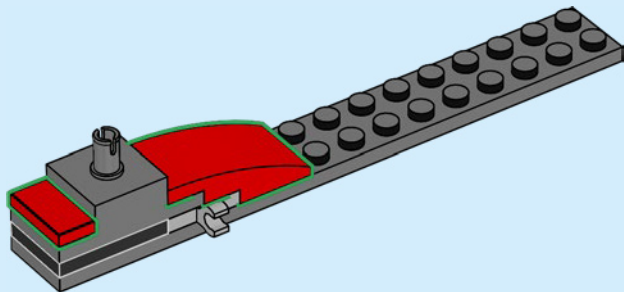



30

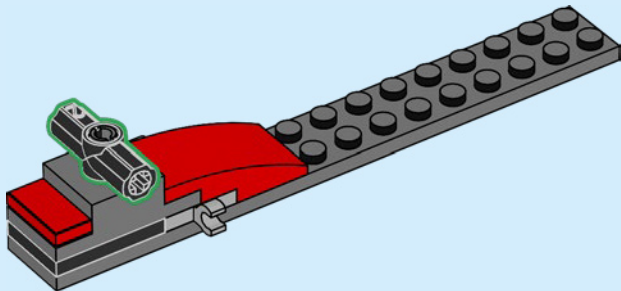

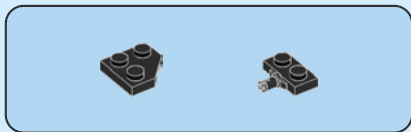

31

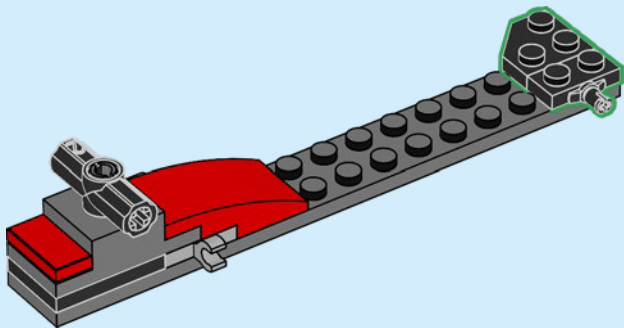



32

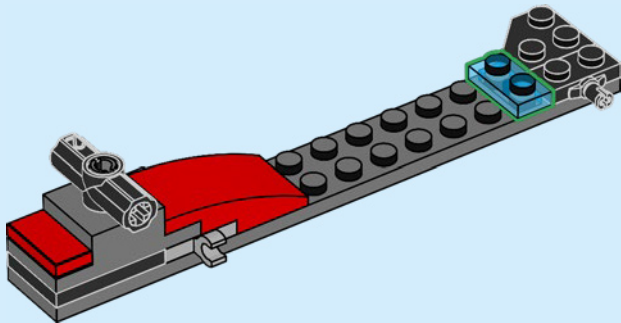



33

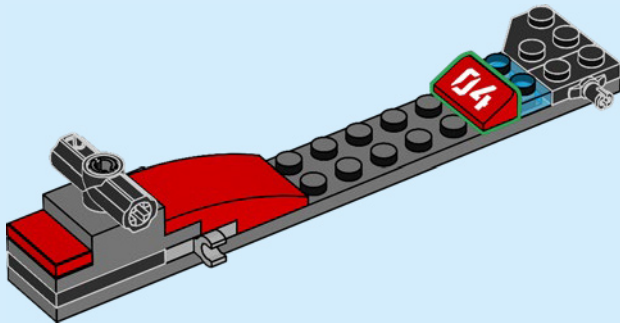



34

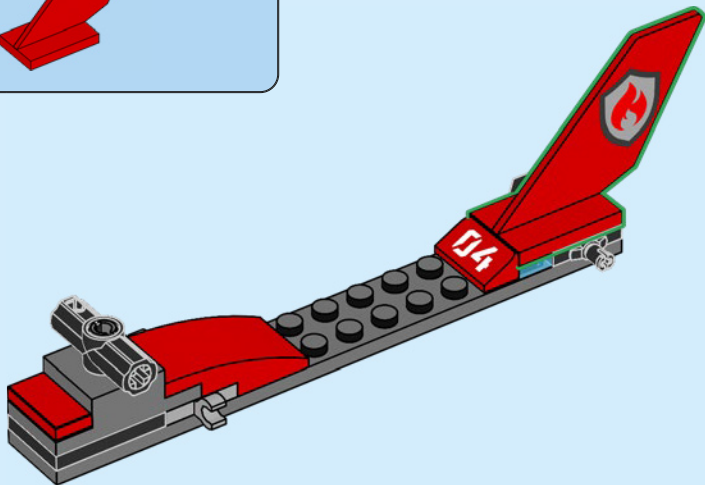



35

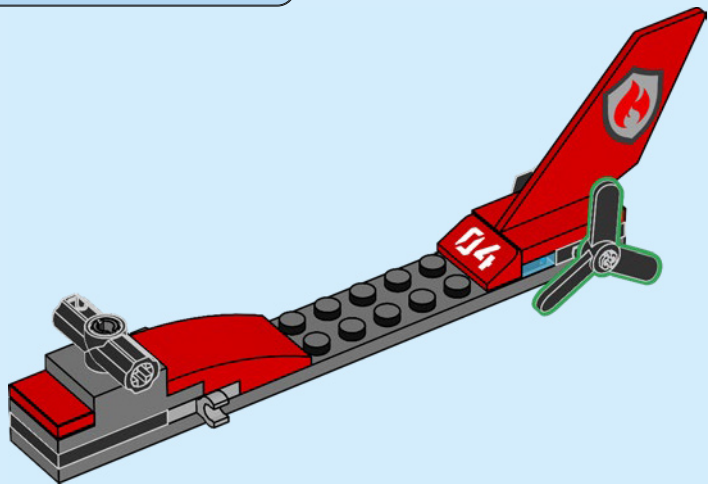

36

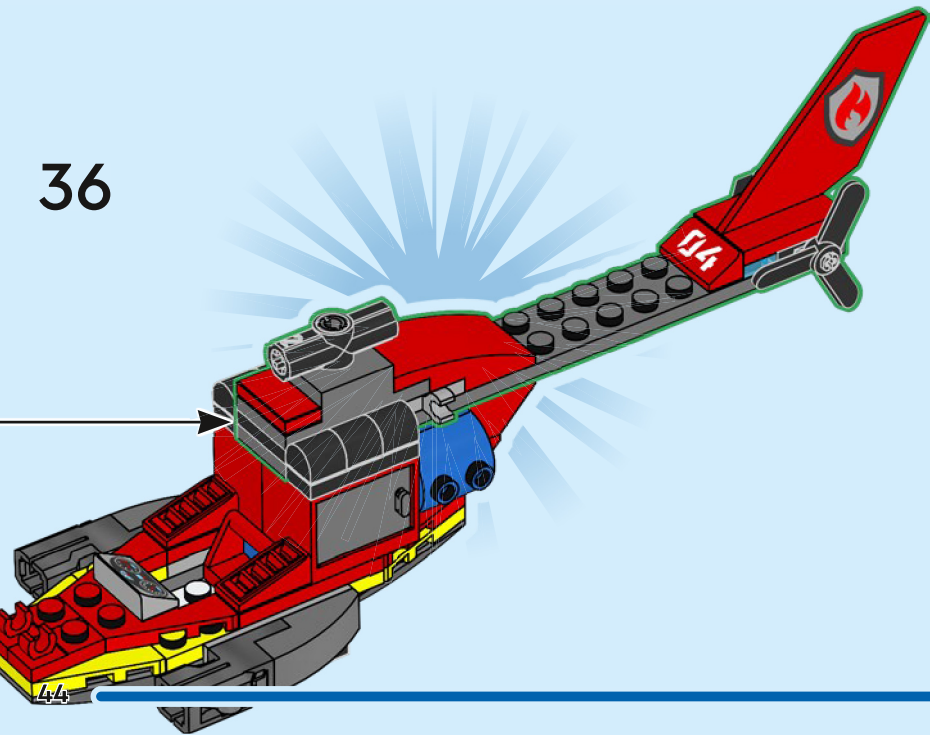



37

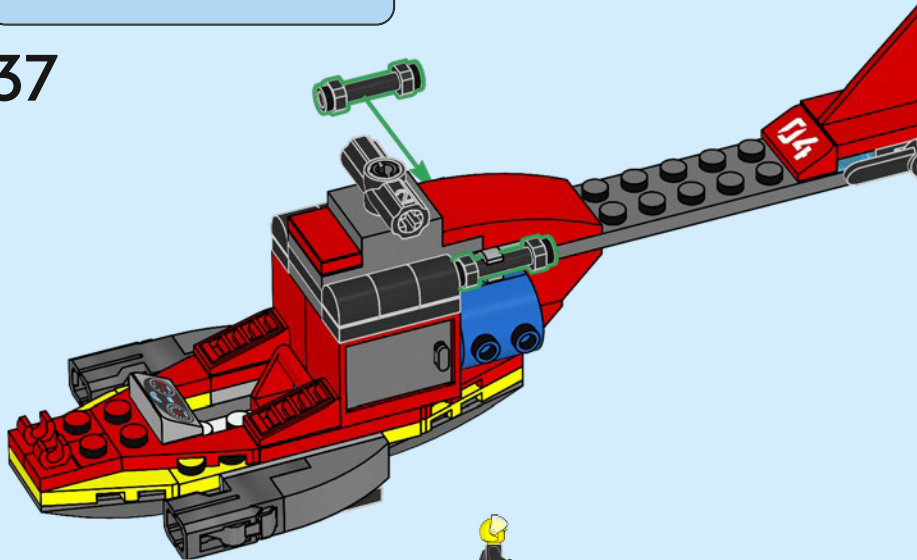

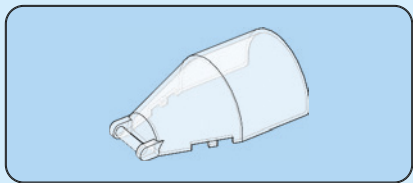

38

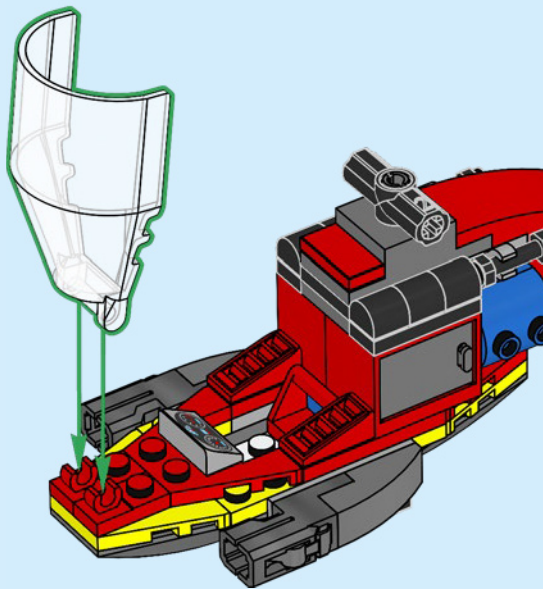

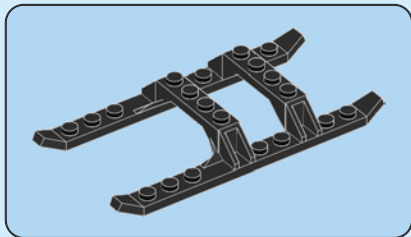

39

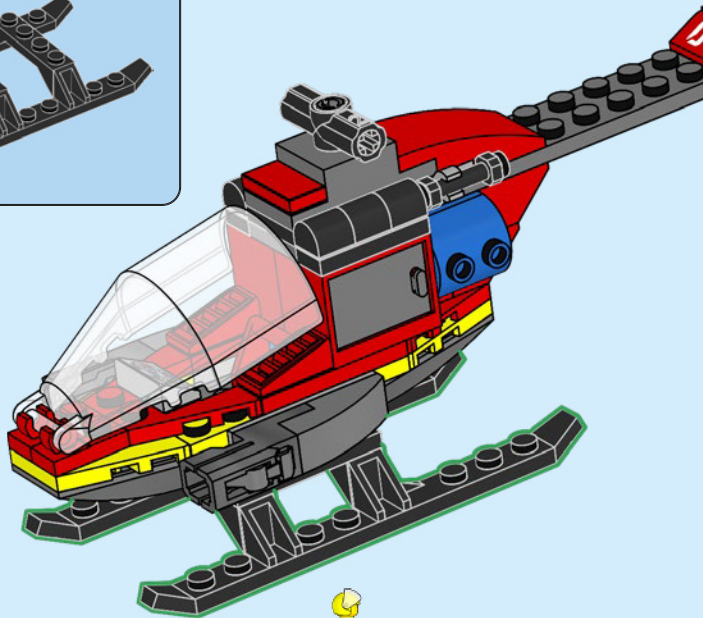

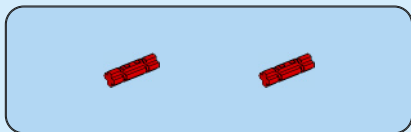
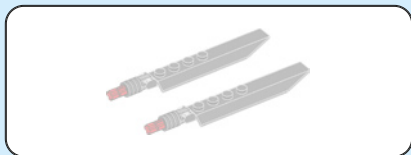

40

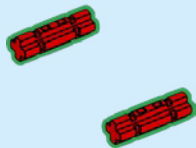

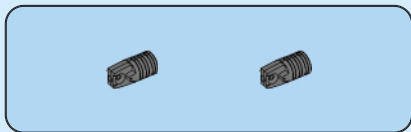

41

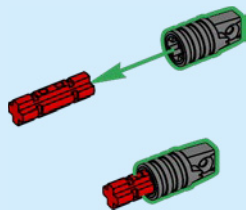

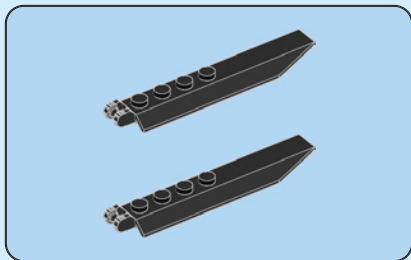

42

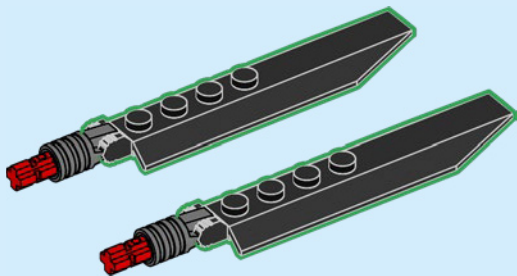

43

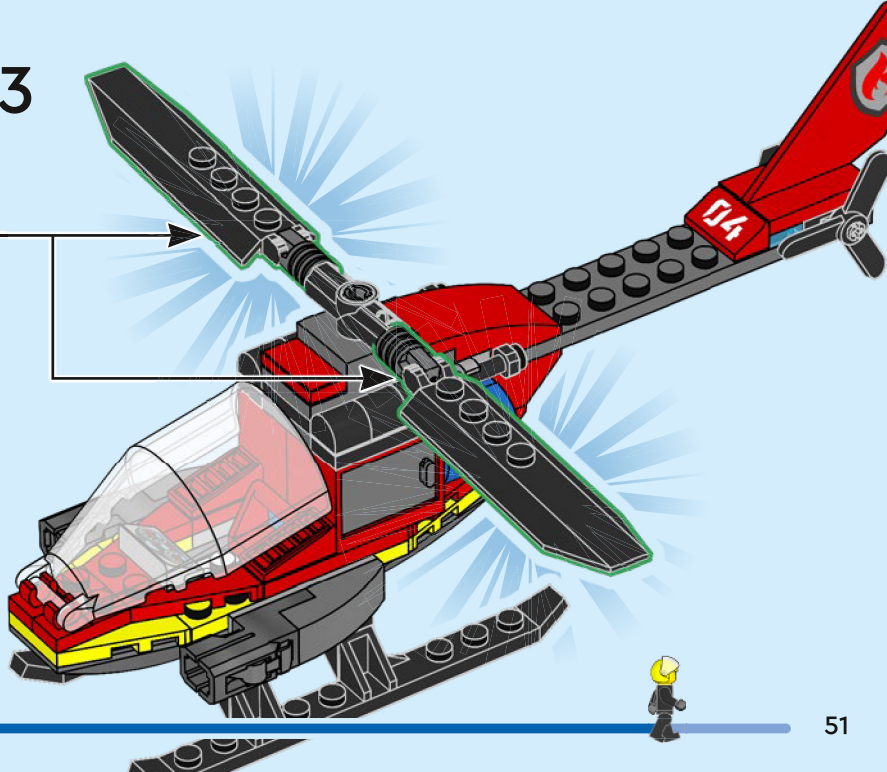

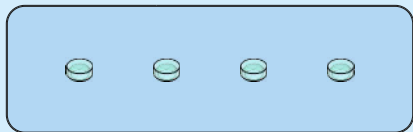

44

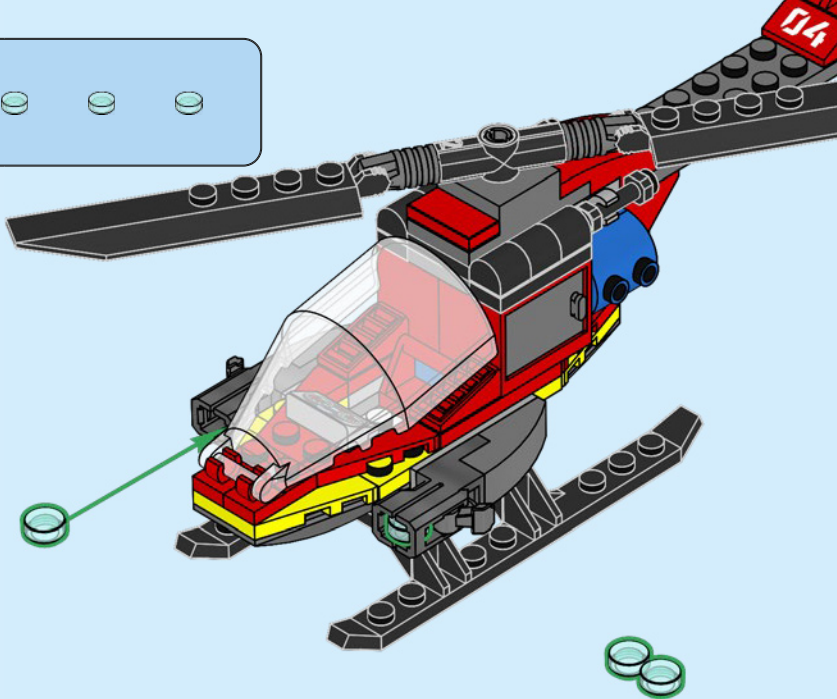

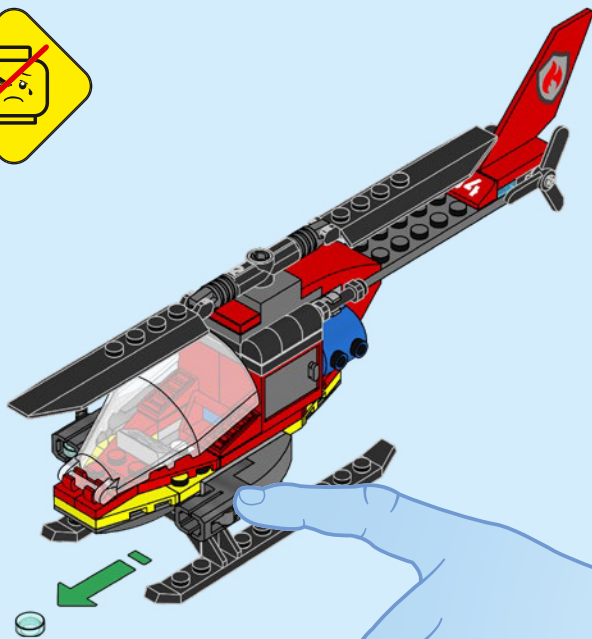

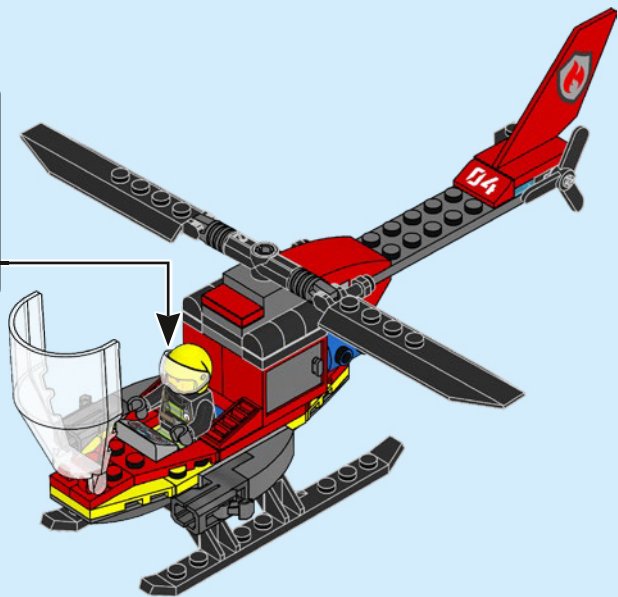





CITY



60419





CITY





2x
6058177



1x
303401



1x
6283875



1x
6240215



2x
6383194



1x
300223

58



2x
4142865



1x
306921



2x
4540382



1x
6465526



2x
6347308



1x
243221



1x
300421



2x
366021



2x
371021



1x
4613174



2x
6170523



2x
4619543



1x
6381760



2x
6331084



6x
6273589



1x
6370669



1x
6174243



2x
362326



1x
6143335



1x
6143834



1x
6170693



1x
6271869



1x
302126

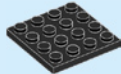

1x
4243819

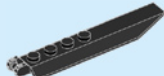

2x
6266348

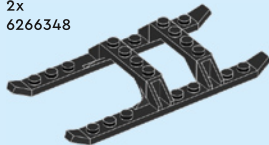

1x
6469627



1x
4550170



2x
6168615



2x
6167741



1x
6171727



1x
6468541



4x
6382324



2x
6381735



4x
6274739



1x
6329152



2x
6313114



1x
6093519



1x
6330903



1x
6469628



1x
6245241



2x
6265702



2x
4246896



2x
4210811



2x
6426647



1x
6301436

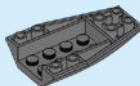

2x
4636417

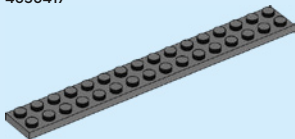

1x
4210796



[LEGO.com/service](https://www.lego.com/service)

SHARE YOUR FEEDBACK



Scan this QR code or go to
LEGO.COM/PRODUCTFEEDBACK and give us
your short feedback about this LEGO® set.

Terms and Conditions apply*

EN: SHARE YOUR FEEDBACK. Terms and Conditions apply* **DE: Teile dein FEEDBACK.** Es gelten die Teilnahmebedingungen* **FR: Partagez vos COMMENTAIRES.** Des conditions s'appliquent* **IT: Condividi il tuo FEEDBACK.** Termini e condizioni sono applicabili* **ES: Comparte tu OPINIÓN.** Aplican términos y condiciones* **PT: Partilha o teu FEEDBACK.** Aplicam-se termos e condições* **ZH: 请分享您的反馈. 条款和条件适用*** **PL: Podziel się swoją OPINIĄ.** Obowiązują warunki korzystania* **CS: Podělte se o ZPĚTNOU VAZBU.** Platí všeobecné smluvní podmínky* **SK: Podel' sa o svoj NÁZOR.** Platia všeobecné zmluvné podmienky* **HU: Oszd meg a VÉLEMÉNYED.** Felhasználási feltételek érvényesek* **RO: Trimite FEEDBACK.** Se aplică termenii și condiții* **BG: Споделете вашите ОТЗИВИ.** Има определени правила и условия* **LV: Sniedziet ATSAUKSMES.** Ir spēkā noteikumi un nosacījumi.* **ET: Jaga oma TAGASISIDET.** Kehtivad tingimused* **LT: Palikite ATSILIEPIMĄ.** Taikomos sąlygos*

*[LEGO.com/productfeedback-terms](https://www.lego.com/productfeedback-terms)

LEGO and the LEGO logo are trademarks of the LEGO Group. ©2024 The LEGO Group.

6490970