

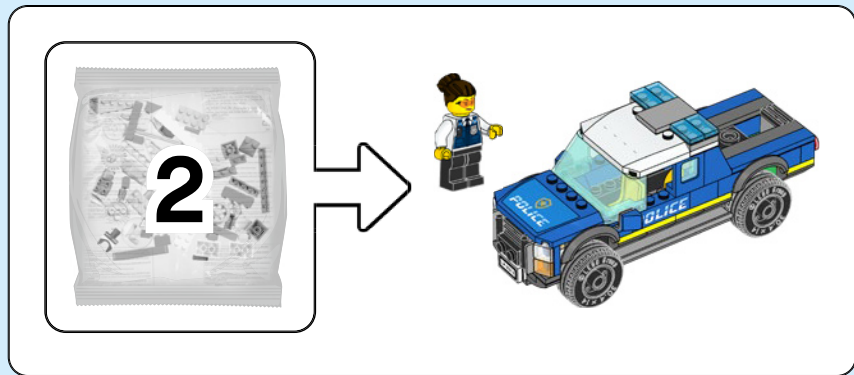

# CITY

60315





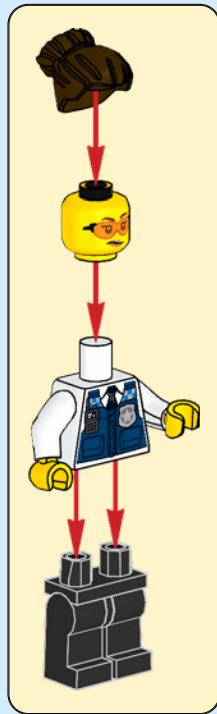

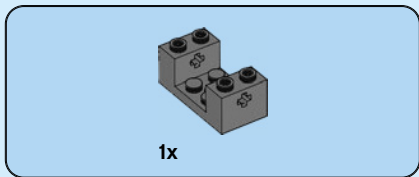

1x

1

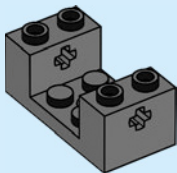

4



2x

2

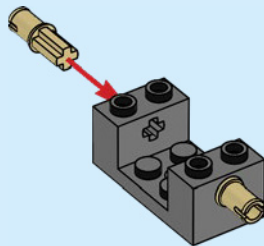



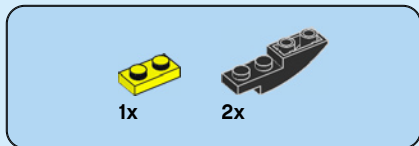

3

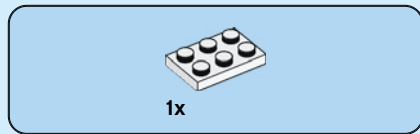
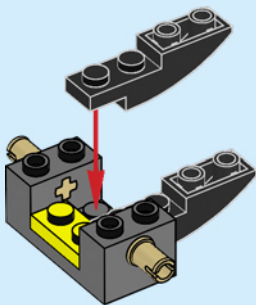

4

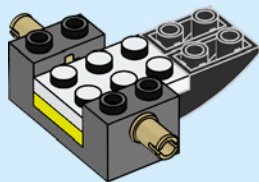

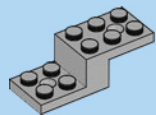

1x

5

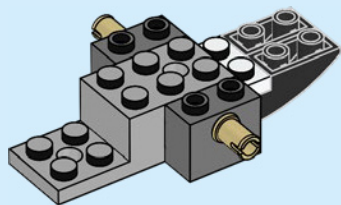

6





1x

6

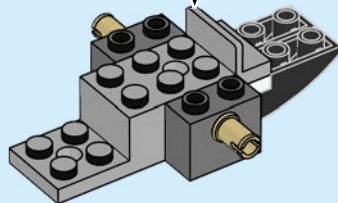
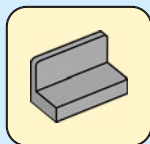

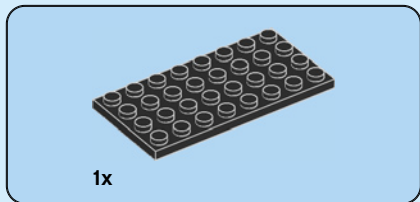
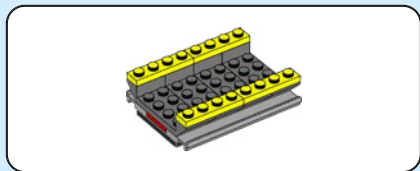

1x

7

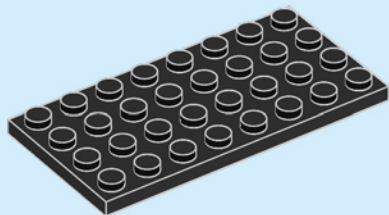

8



2x

8

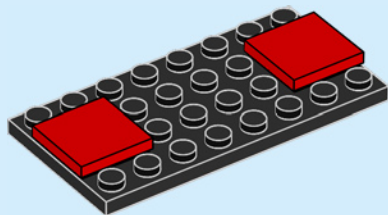

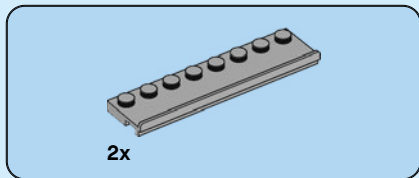

9

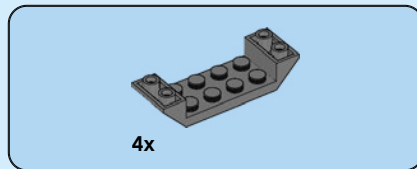
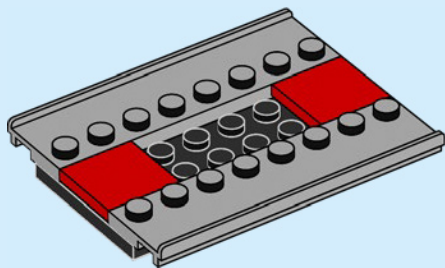

10

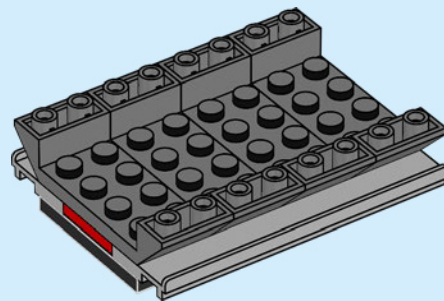

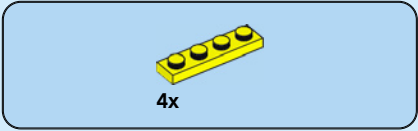

11

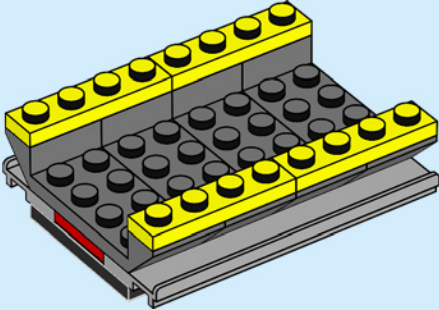

12

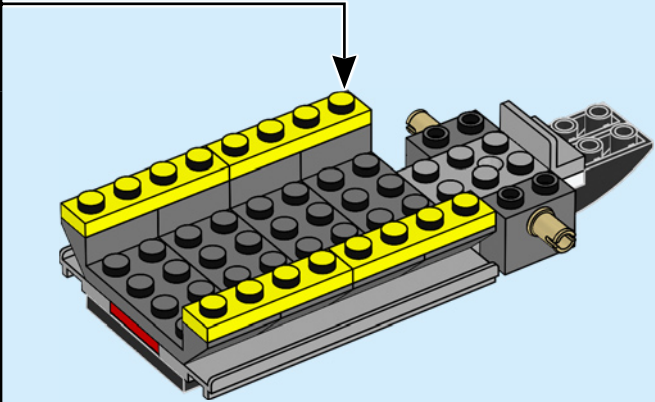

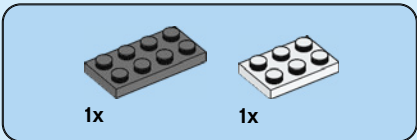
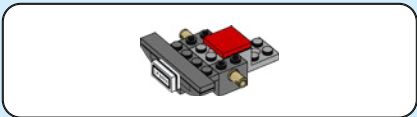

13

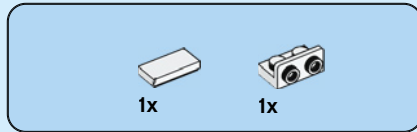
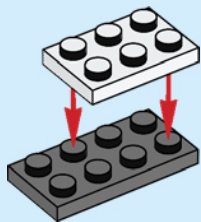

14

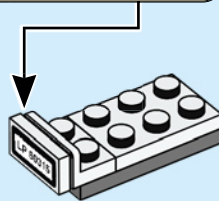
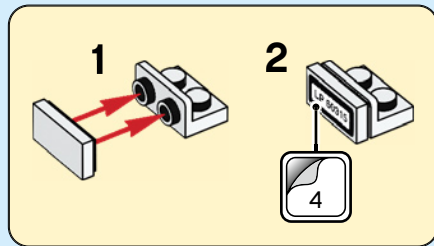



1x

15

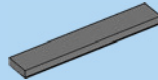
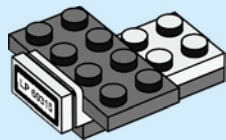

1x

16

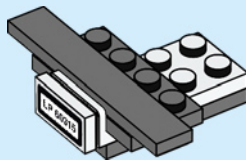





2x

17

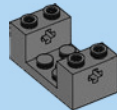
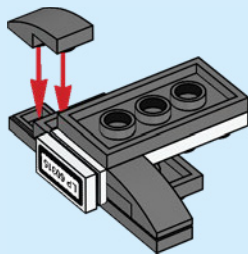
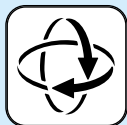

1x

18

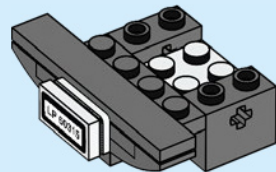



2x

19

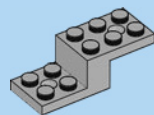
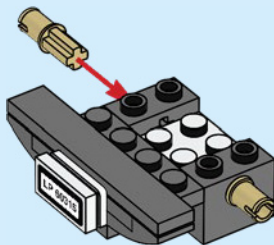

1x

20

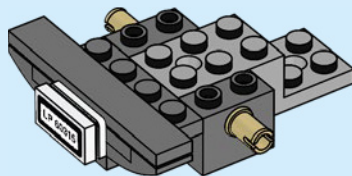

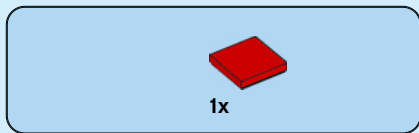

21

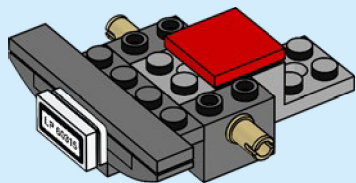

22

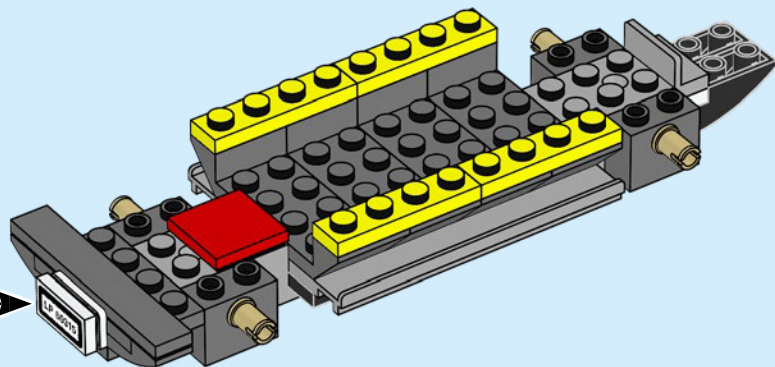

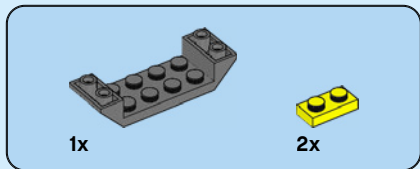

23

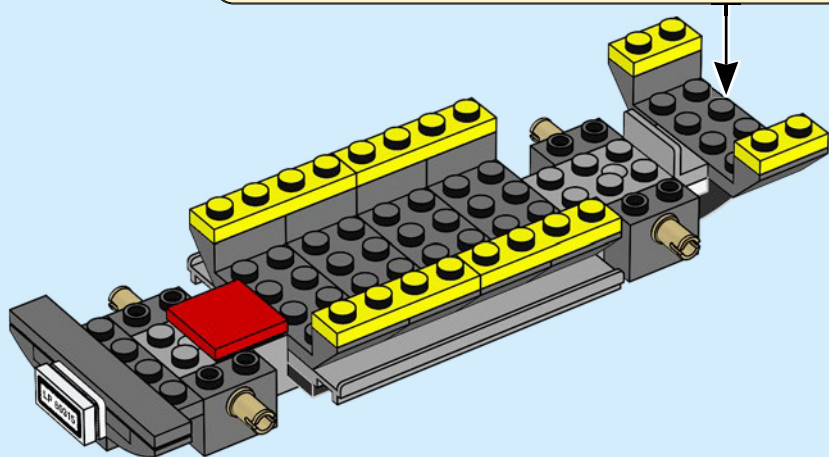
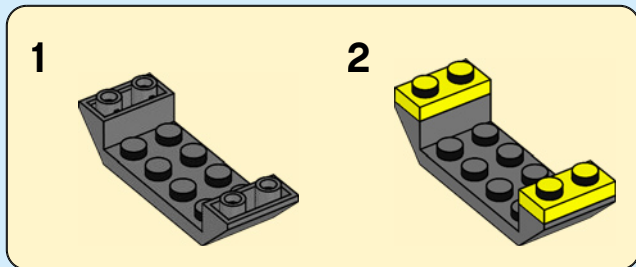

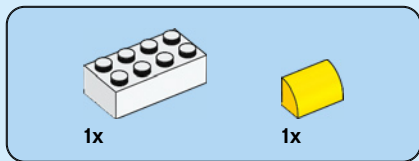

24

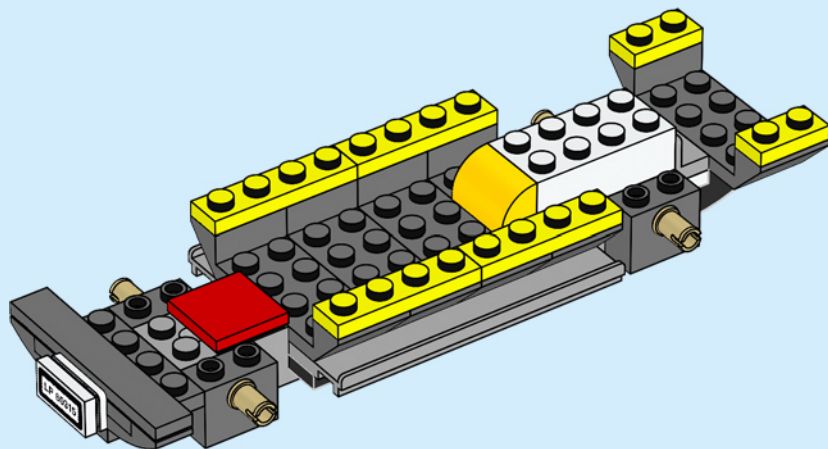

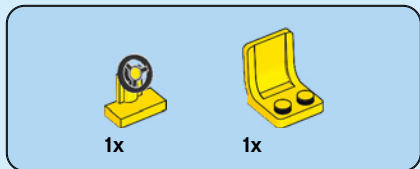

25

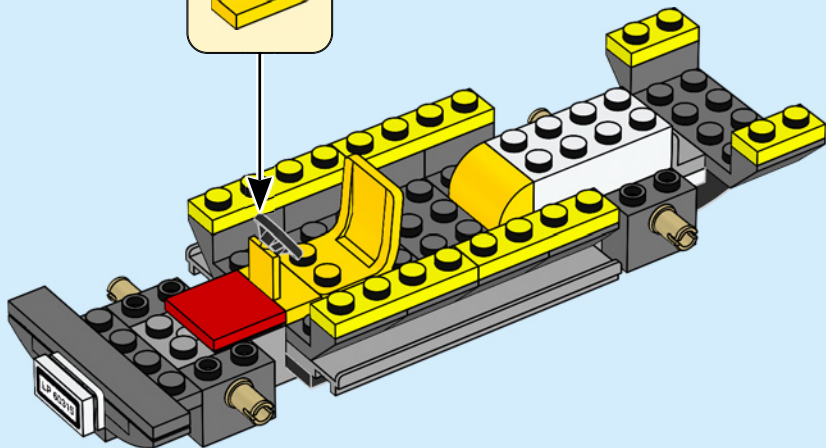



1x

26

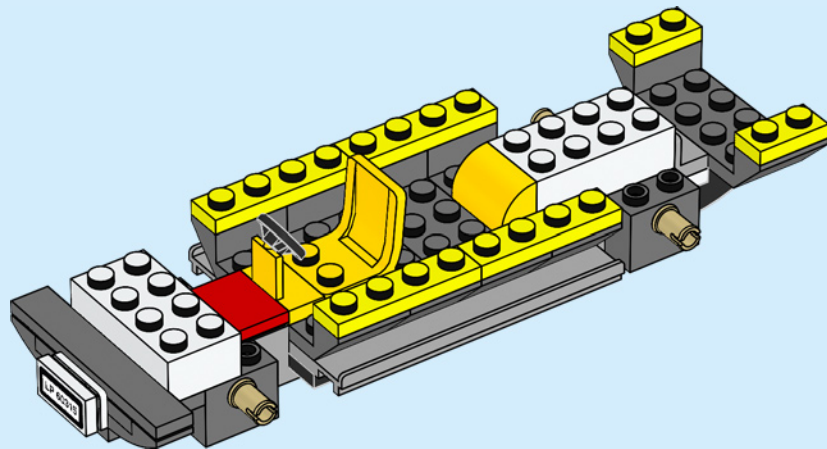

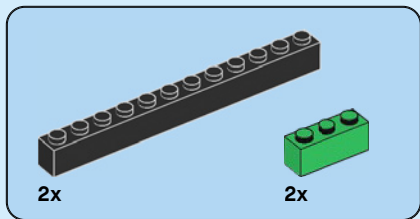

27

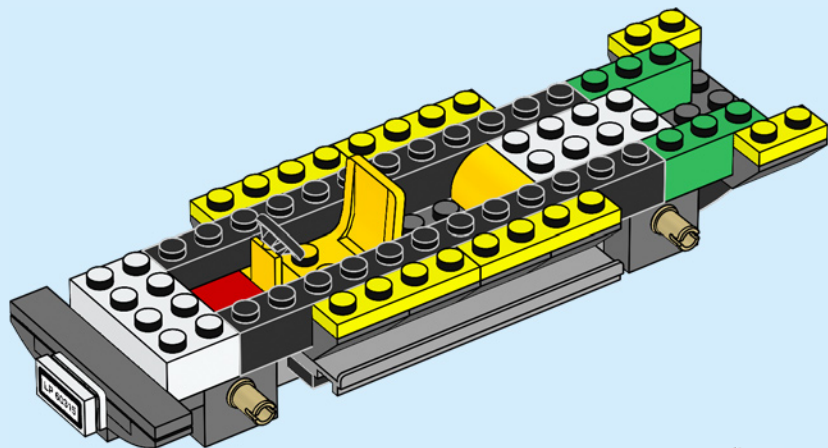



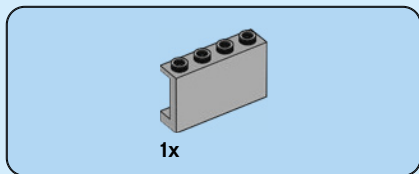

28

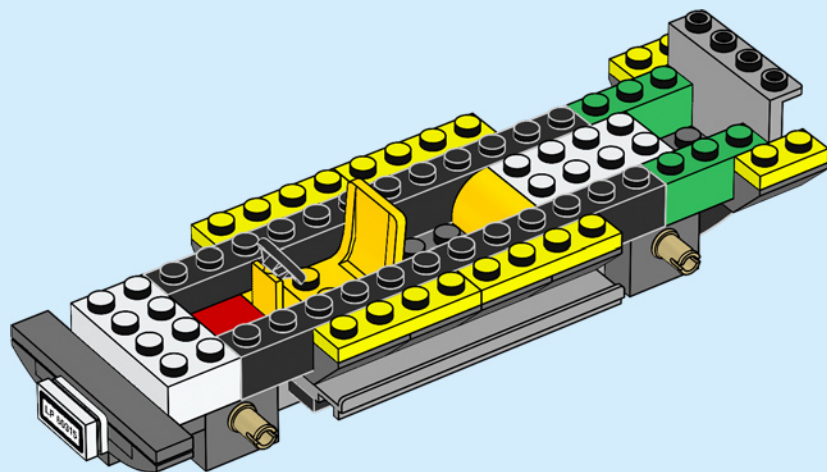



2x



2x

# 29

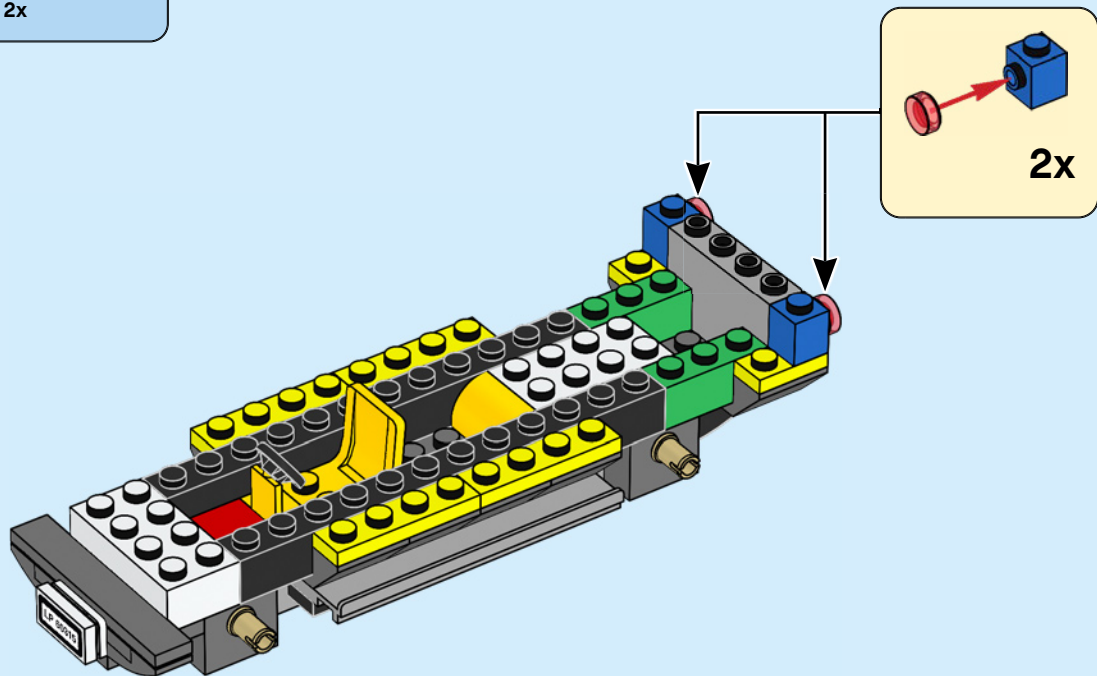



2x

30

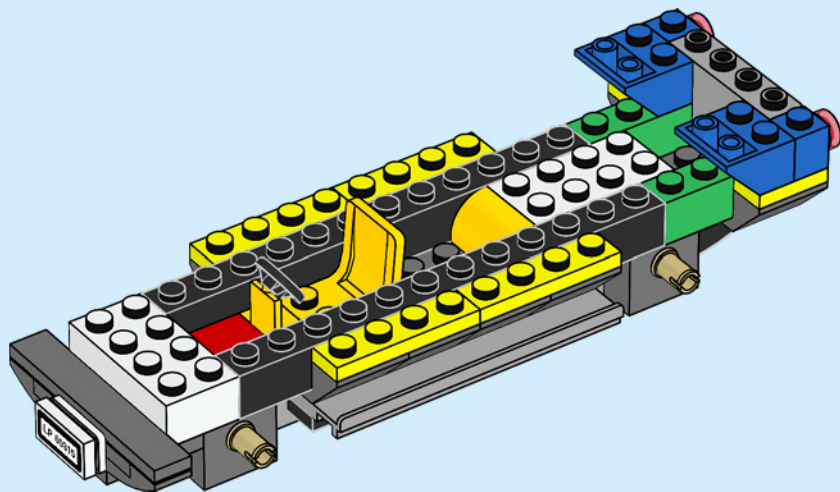



2x

31

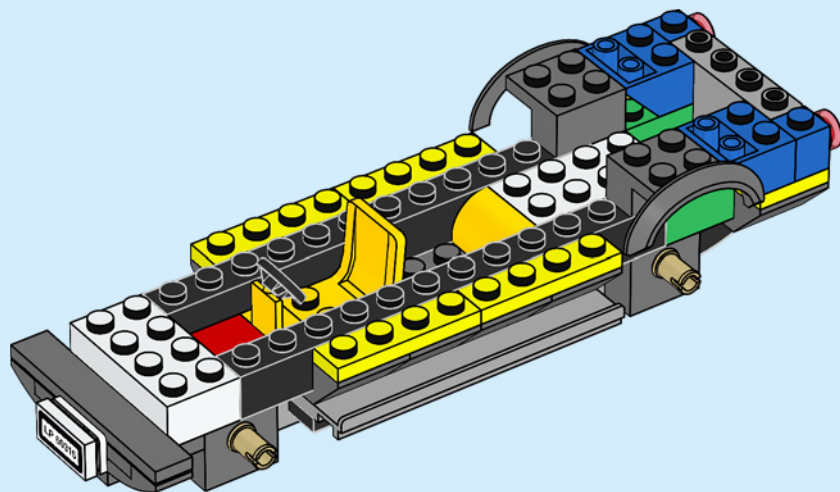

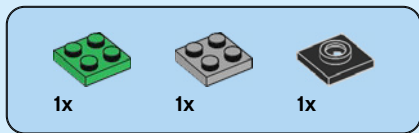

32

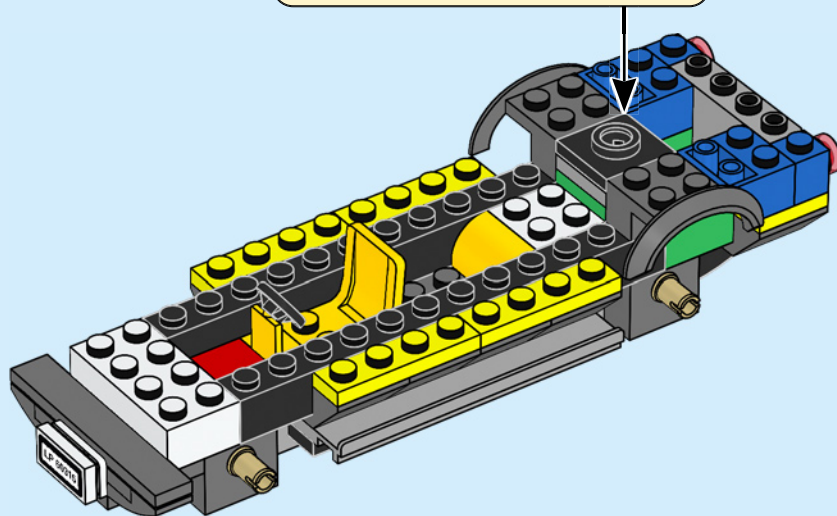
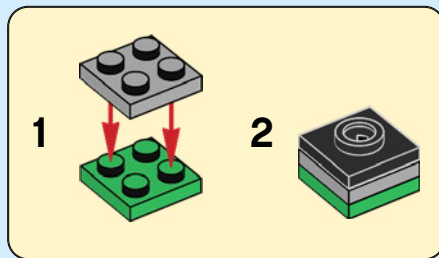



1x

33

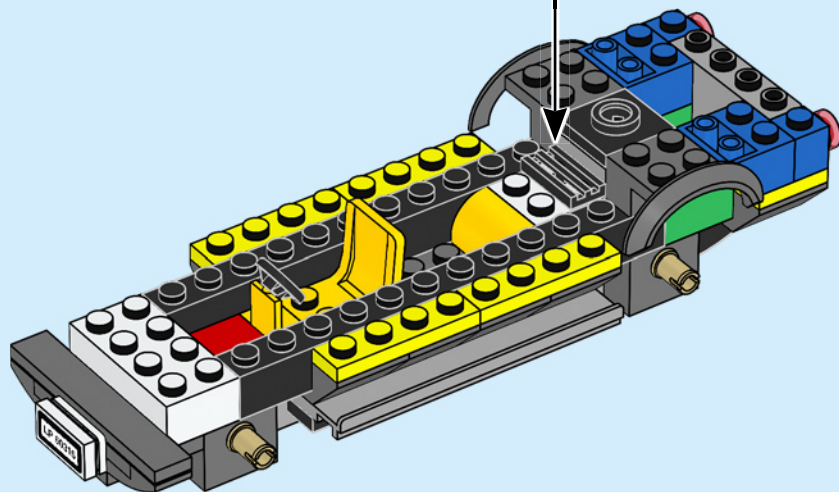
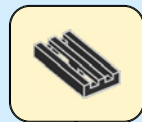



2x



1x

# 34

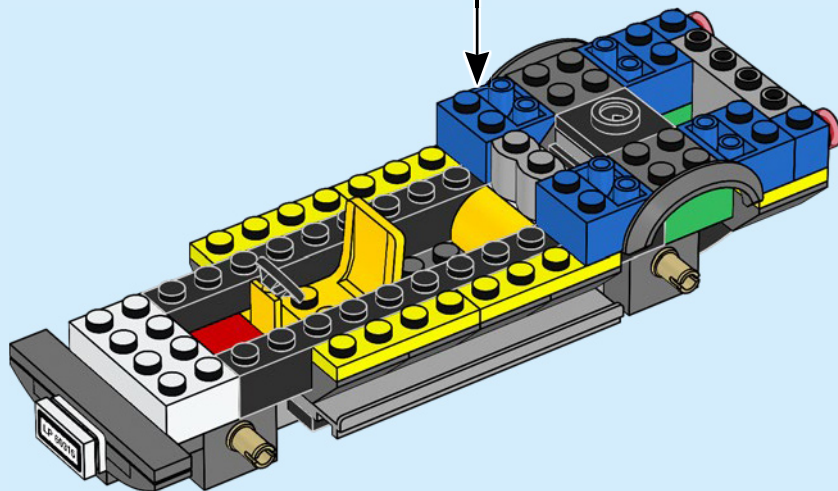
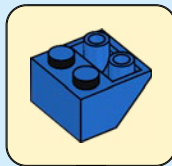



2x

35

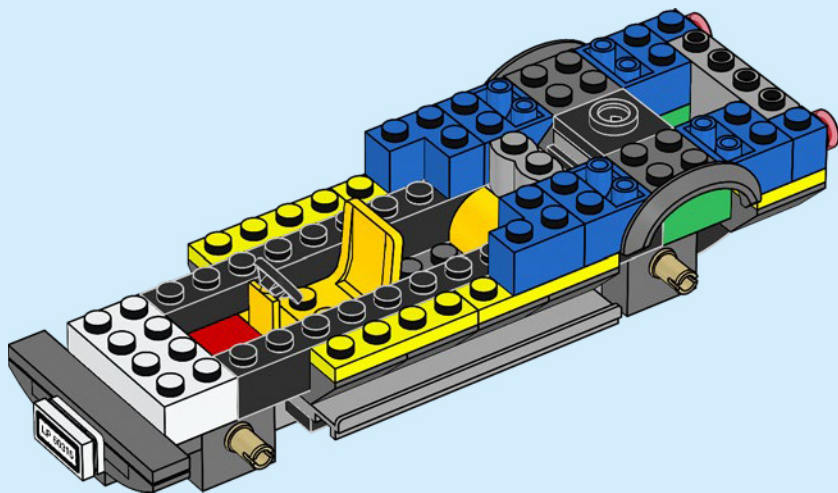





2x

36

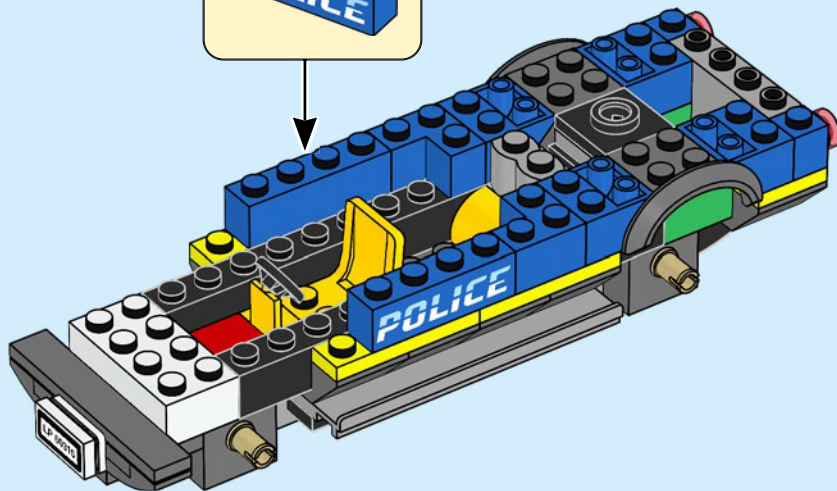



37

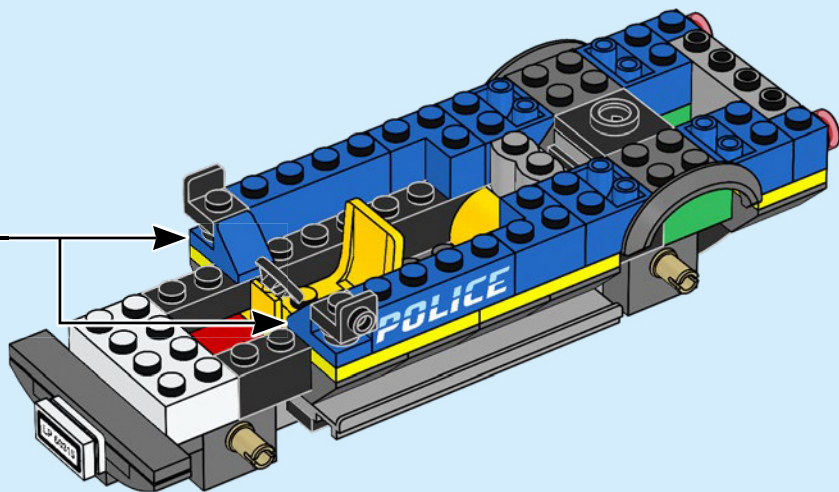
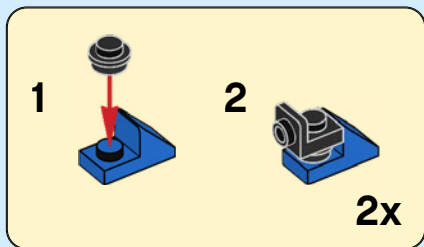

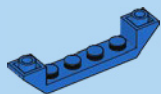

1x

38

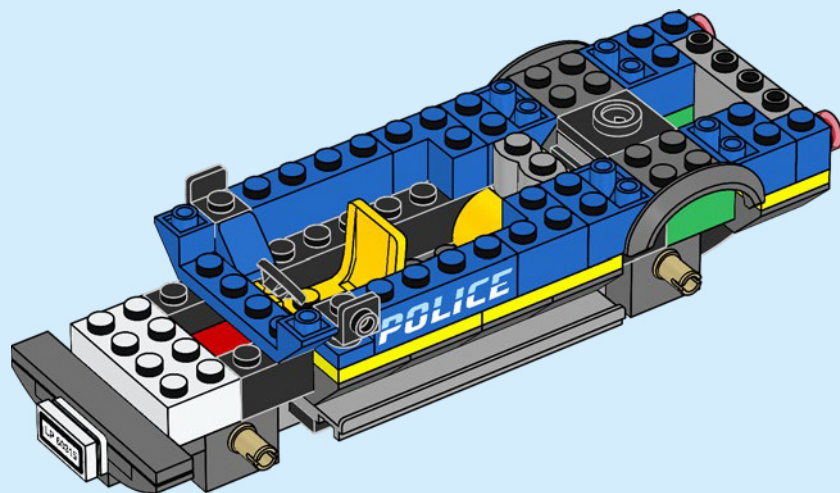

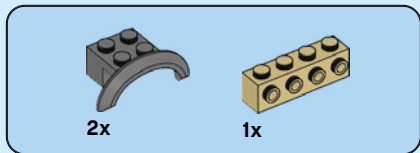

39

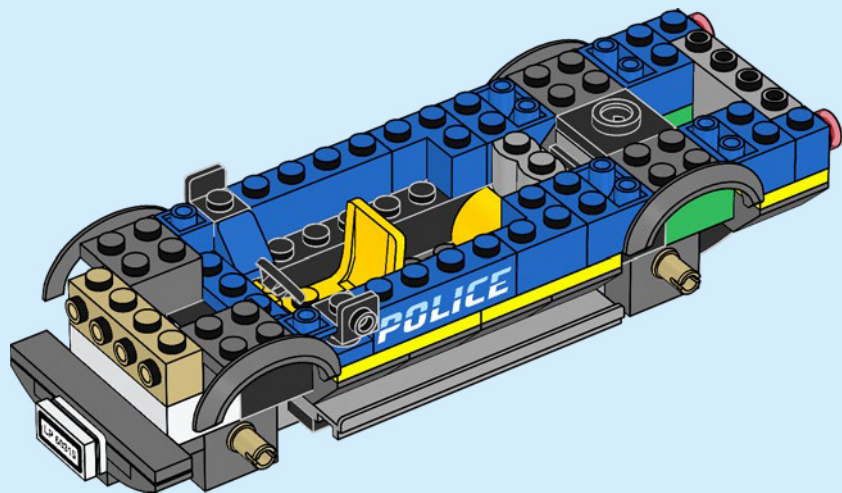

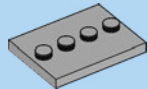

1x

40

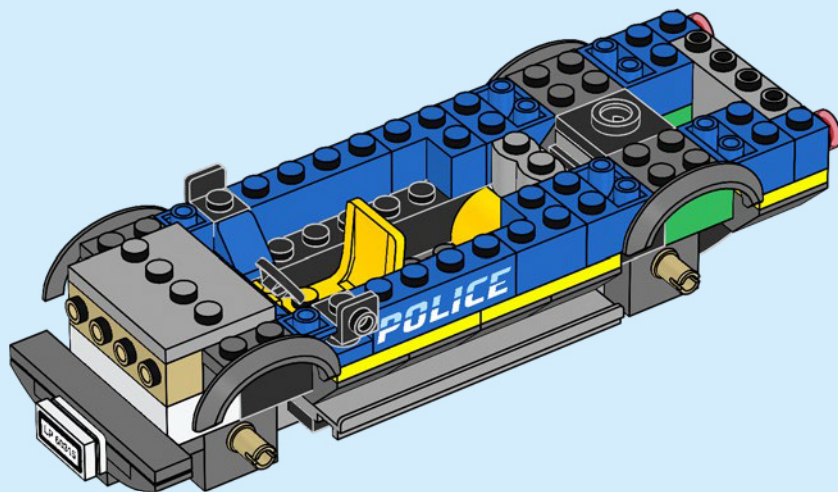

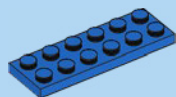

1x



1x

# 41

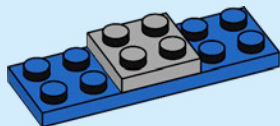

2x

# 42

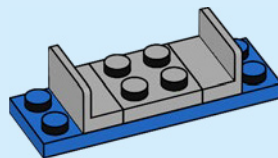



2x



2x

# 43

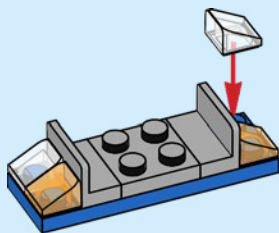

1x



1x

# 44

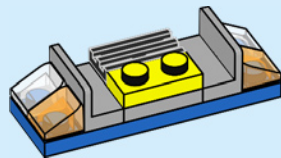



1x

45

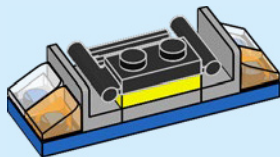



46

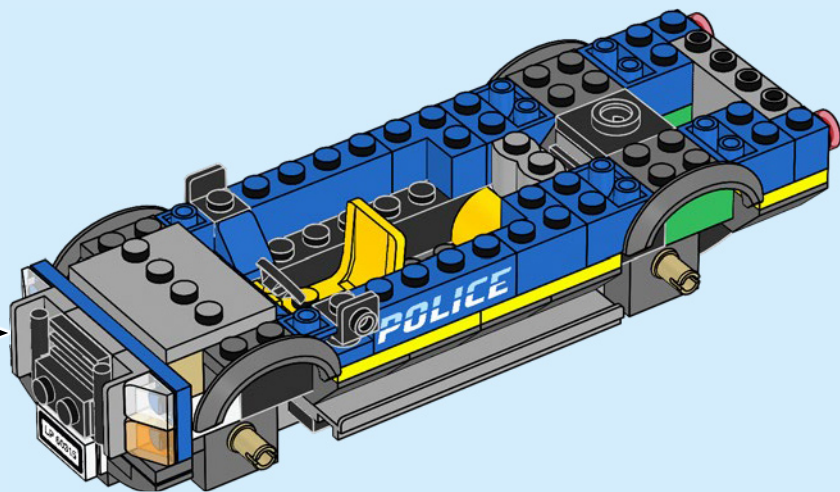

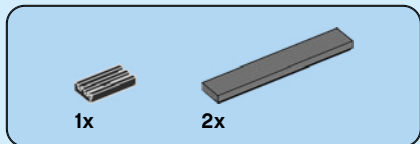

47

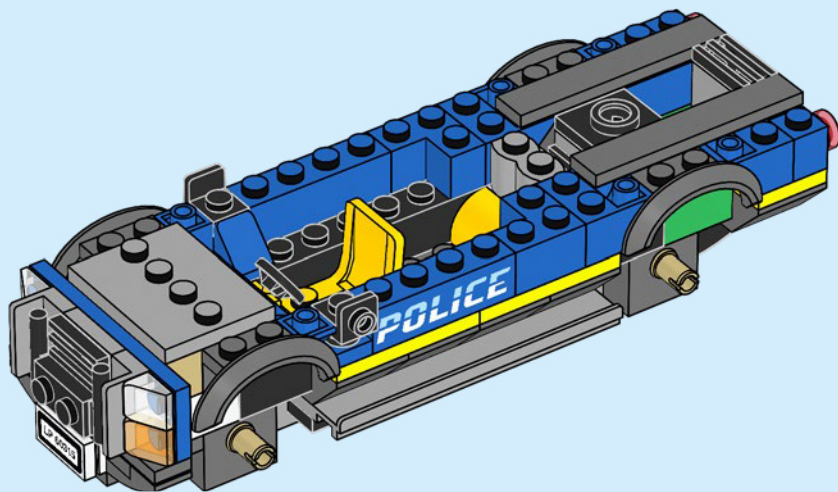



2x

48

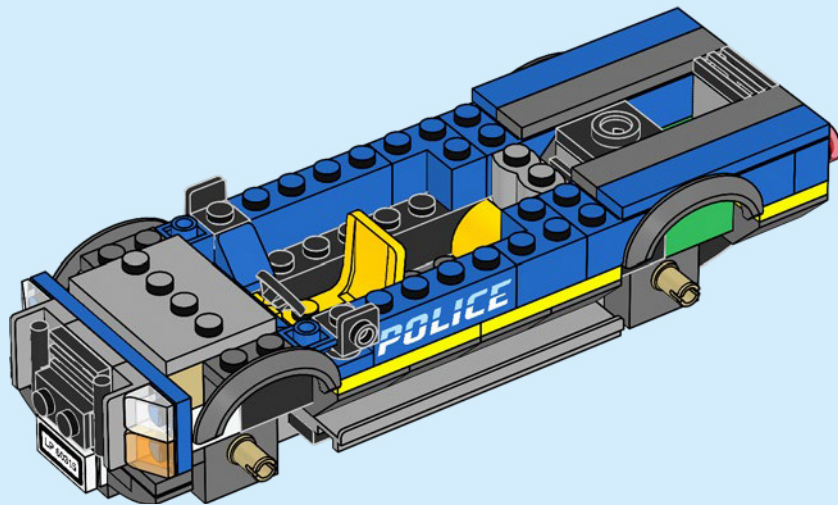

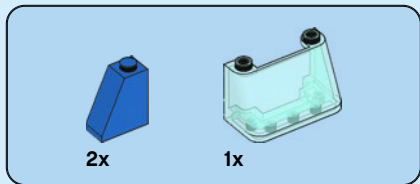

49

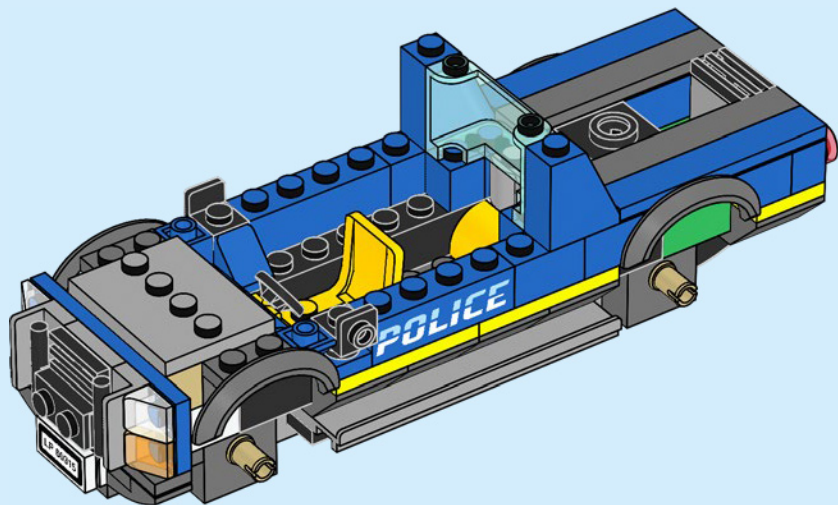

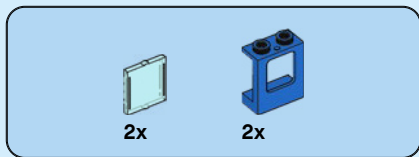

50

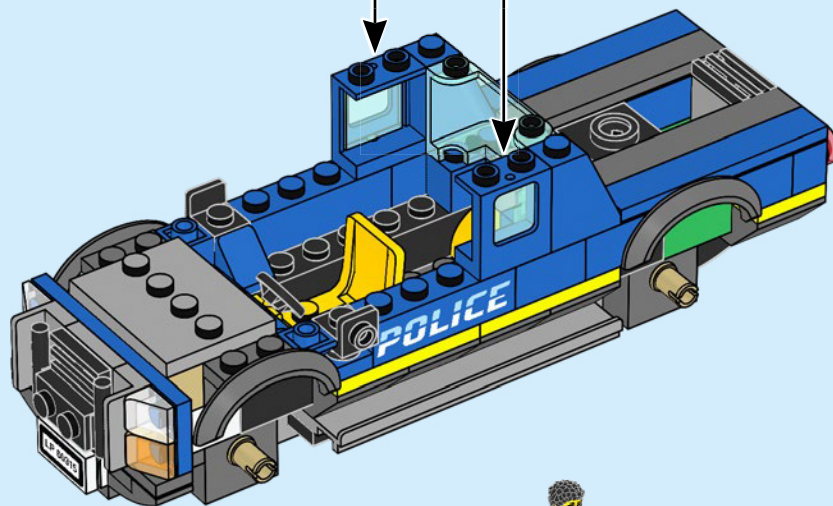
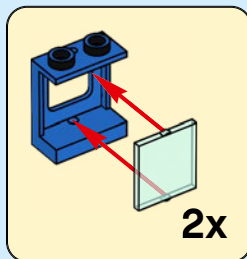



2x

51



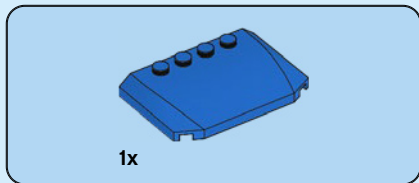

52

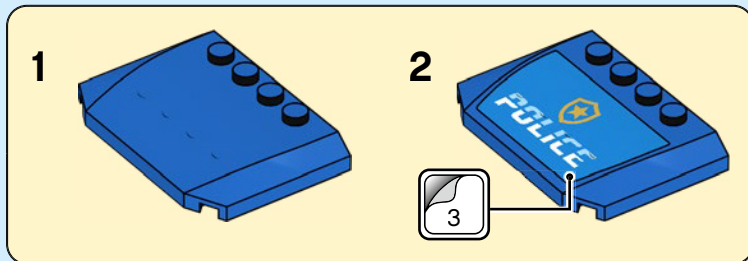

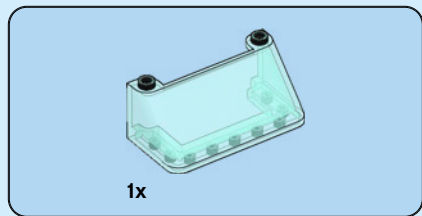

53







2x

# 54

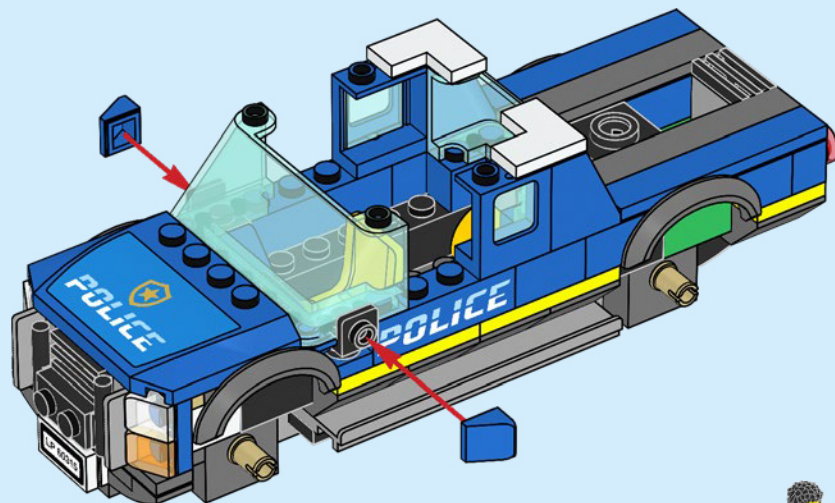

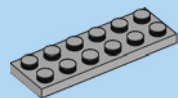
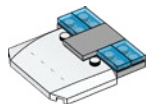

1x

55

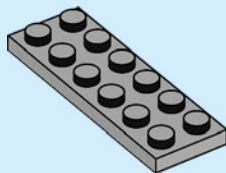

4x

56

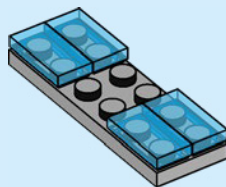



1x

57

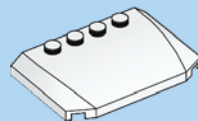
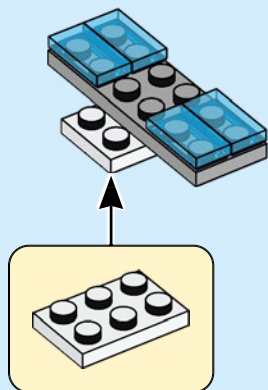

1x

58

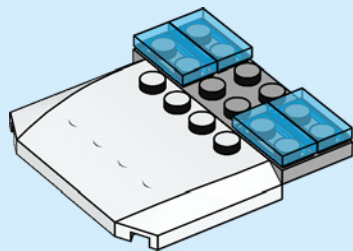



1x

59

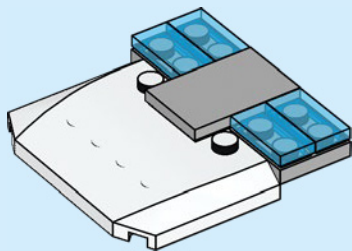

60



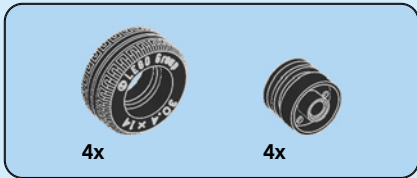

61

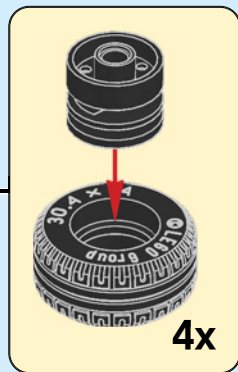
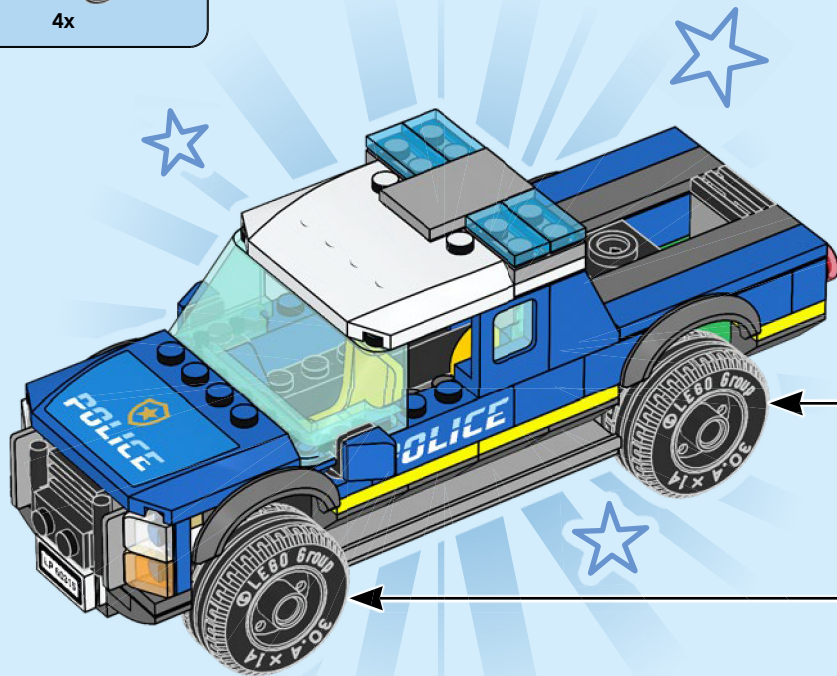

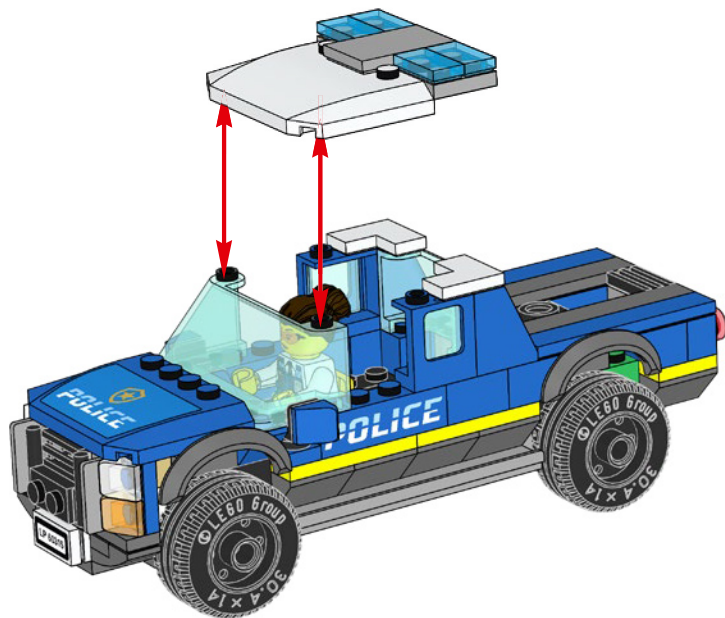







# CITY

