

The LEGO CITY logo, featuring the word "LEGO" in its signature font on a red background, followed by "CITY" in a bold, white, outlined font on a blue background.The LEGO CITY logo, featuring the word "LEGO" in its signature font on a red background, followed by "CITY" in a bold, white, outlined font on a blue background.

60306



1



**WARNING: CHOKING HAZARD.**  
Toy contains small parts and a small ball.  
Not for children under 3 years.

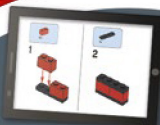



- 1 Scan the code on the front cover  
Scanne den Code auf der Titelseite  
Scanne le code sur la page de couverture  
Scanner le code sur la page couverture  
Scansiona il codice sulla copertina  
Escanea el código de la portada  
Faz scan do código na frente da capa  
Olvasd be a borítón látható kódot!  
Noskenë kodu uz priekšējā vāka  
扫描封面上的二维码

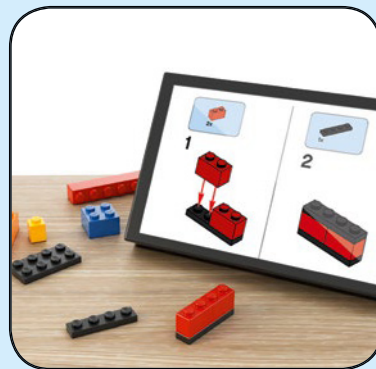

- 2 Get the Building Instructions  
Hol dir die Bauanleitung  
Obtiens les instructions de montage  
Obtenir les instructions de montage  
Scarica le istruzioni per la costruzione  
Consulta las instrucciones de construcción  
Obtém as Instruções de Construção  
Szerezd be az építési útmutatókat!  
Saņem būvēšanas instrukcijas  
获取拼搭说明

**LEGO.com/apps**

Check for compatibility  
Kompatibilität prüfen  
Vérifier la compatibilité  
Controlla la compatibilità  
Comprueba tu compatibilidad

Verificar a compatibilidade  
Ellenőrizd a kompatibilitást  
Pārbaudīt saderību  
检查兼容性

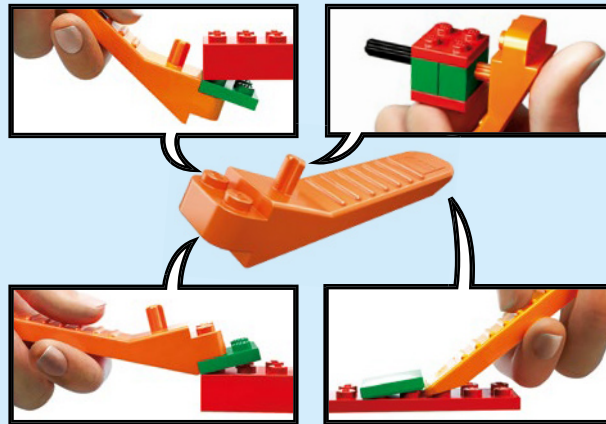

[LEGO.com/brickseparator](https://LEGO.com/brickseparator)



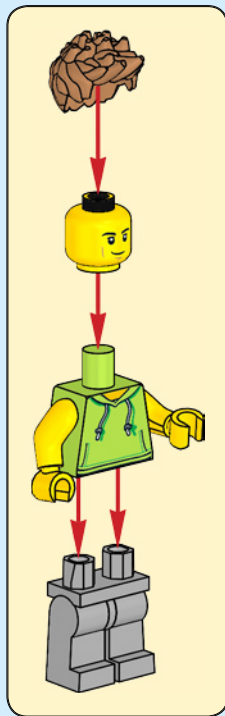
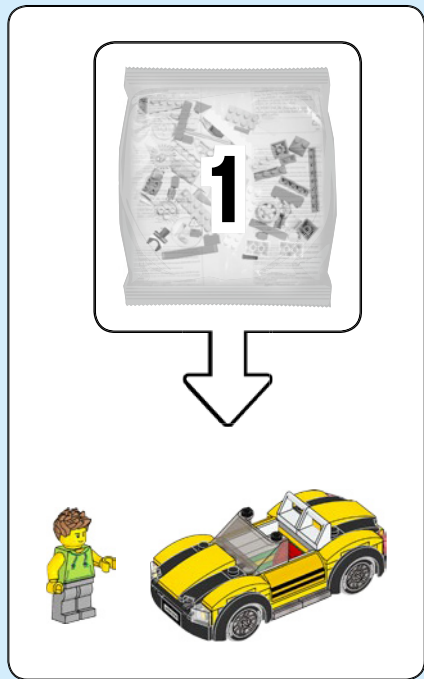

## AVERTISSEMENT :

RISQUE D'ÉTOUFFEMENT.

Le jouet contient des petites pièces ainsi qu'une petite boule. Il ne convient pas aux enfants de moins de 3 ans.



## ADVERTENCIA:

PELIGRO DE ASFIXIA. Juguete que contiene partes pequeñas y una pelota pequeña. No recomendado para niños menores de 3 años.



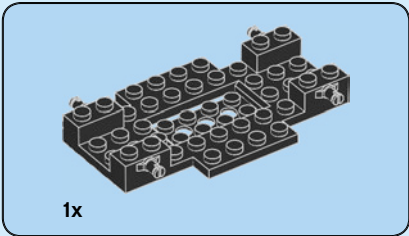
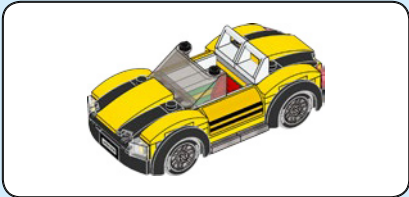

1

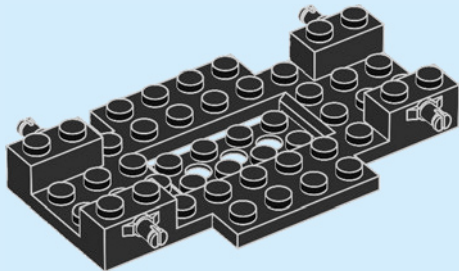

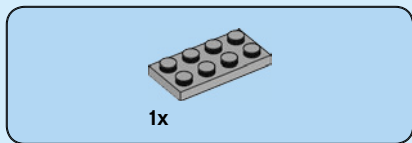

2

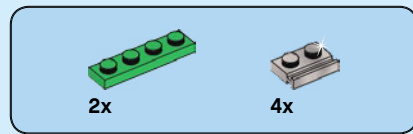
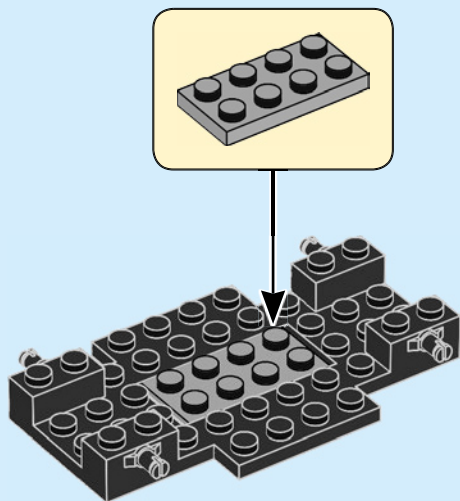

3

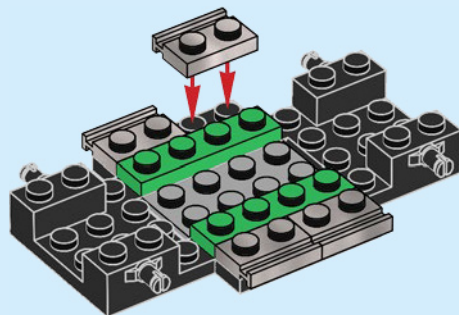



2x

4

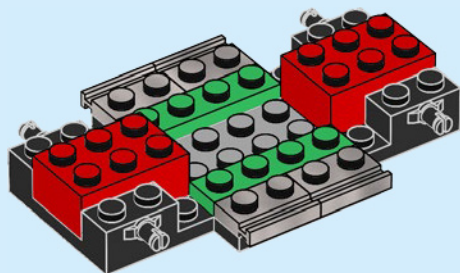

8





1x

5

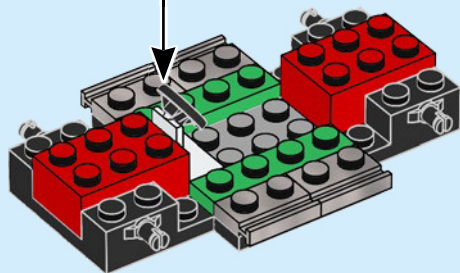

1x

6

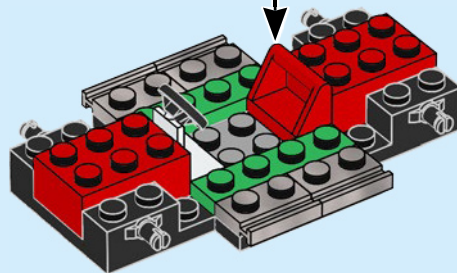
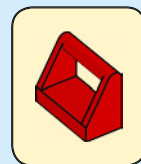

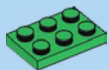

2x

7

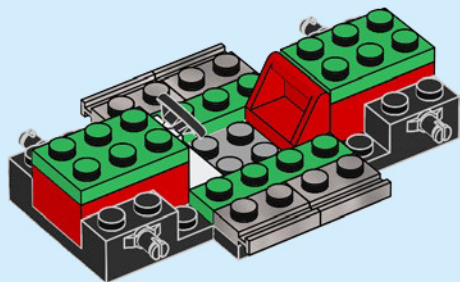

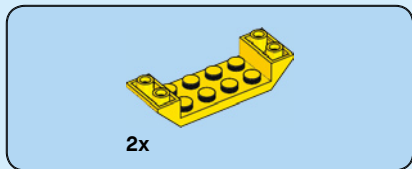

8

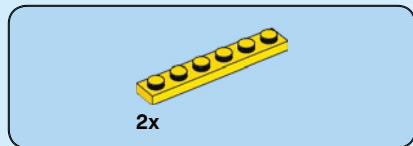
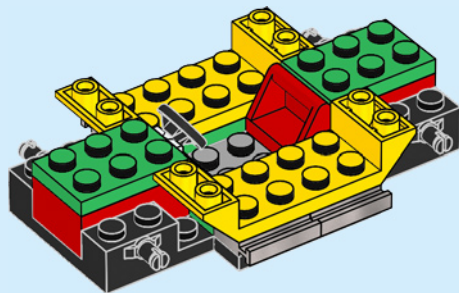

9

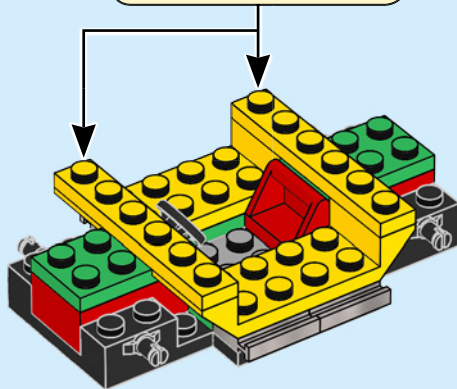
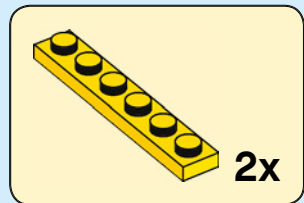



4x

10

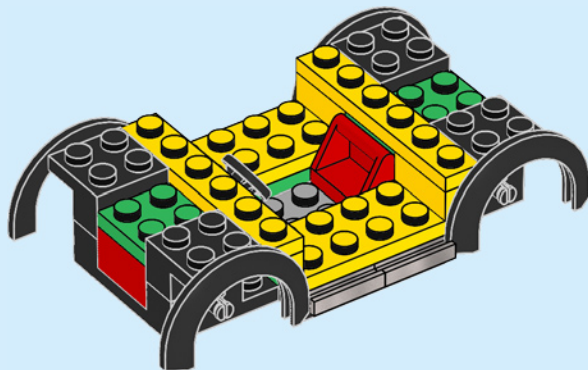

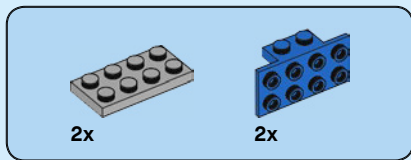

11

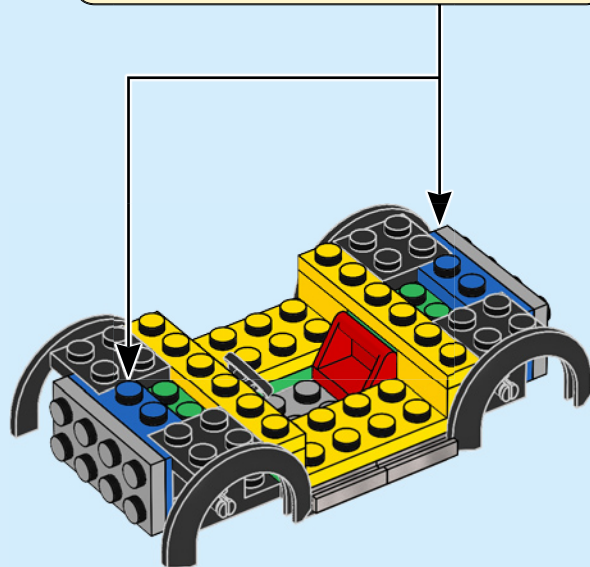
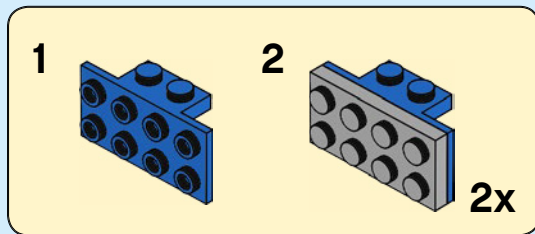

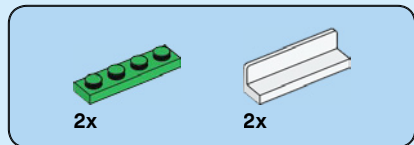

12

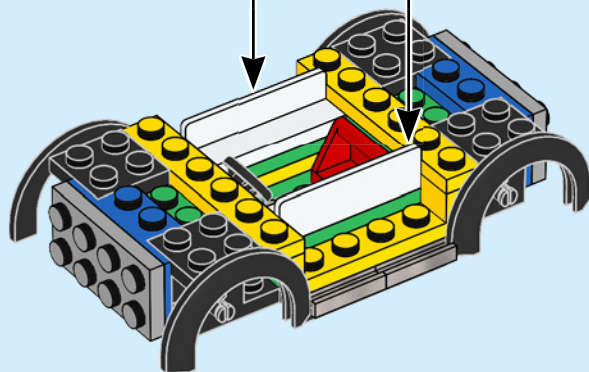
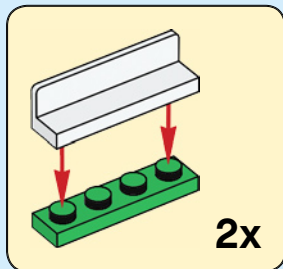

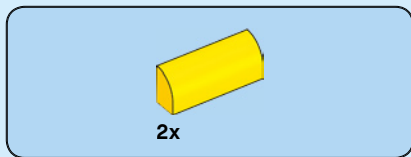

13

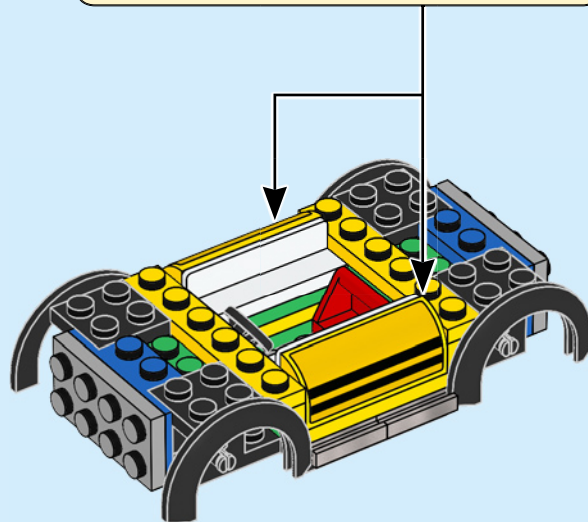
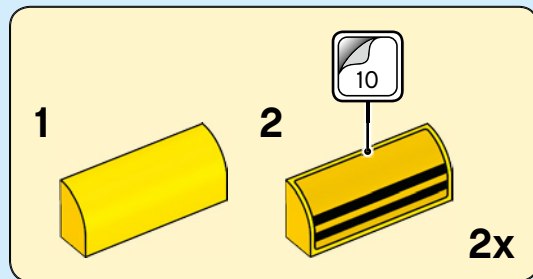



2x

14

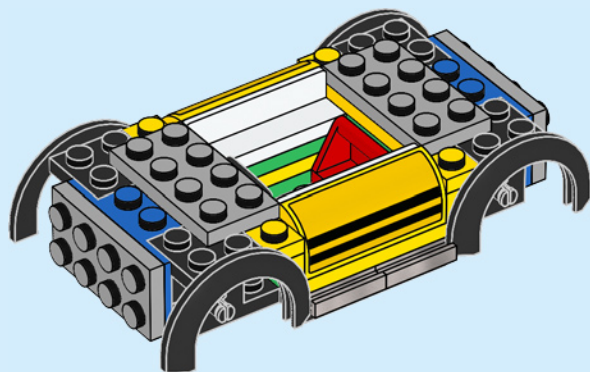





4x



4x

# 15



4x

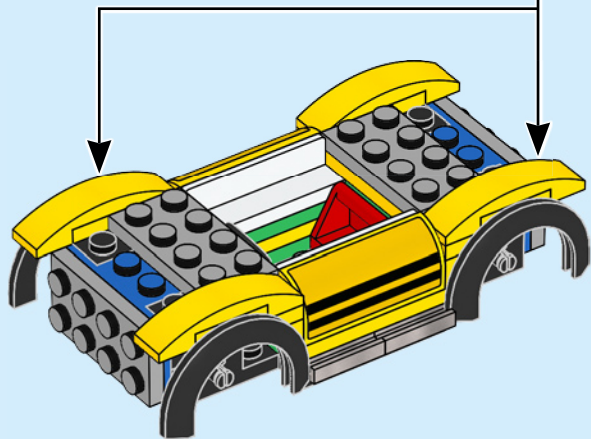



2x

16

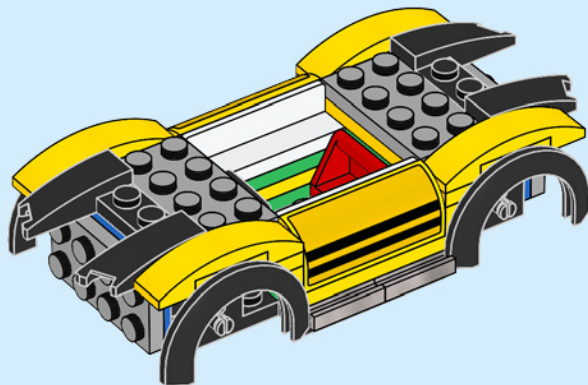

18

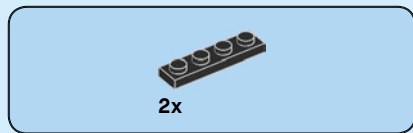

17

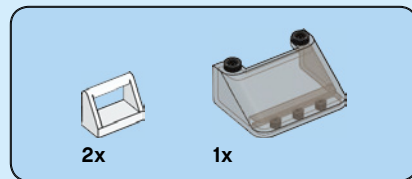
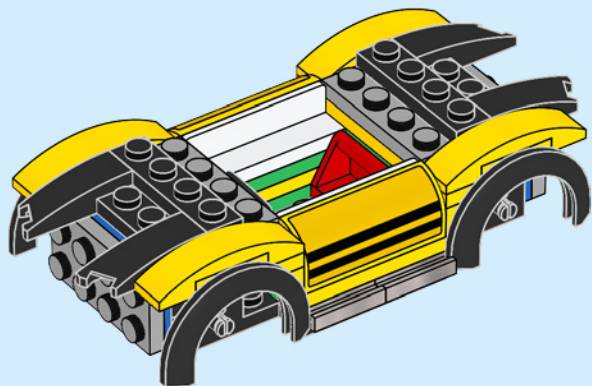

18

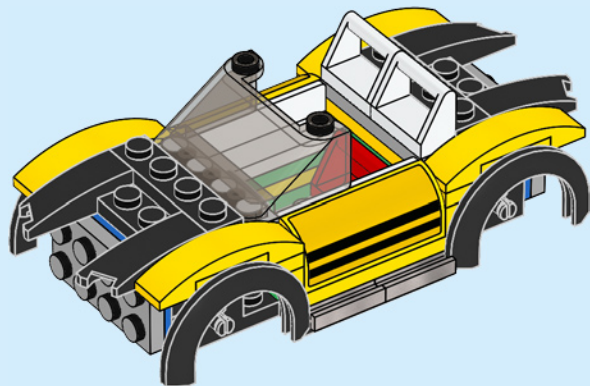



2x

19

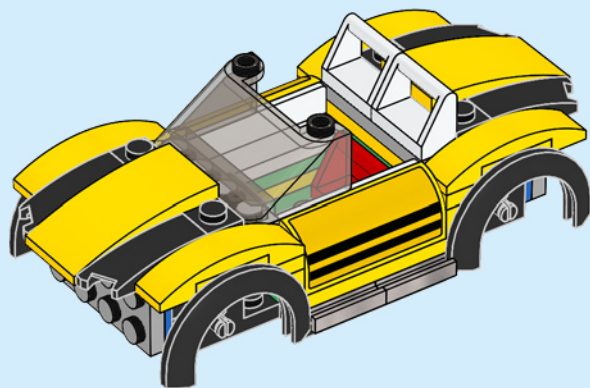

20

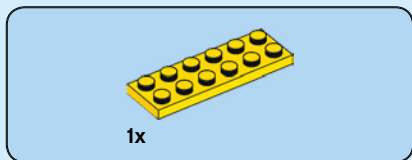

20

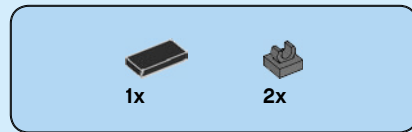
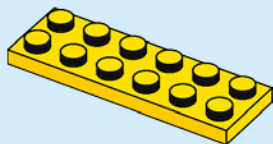

21

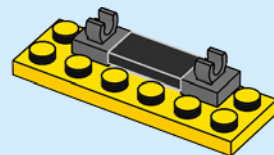



2x

22

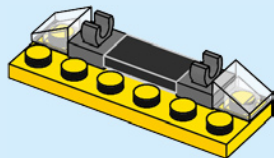

22



1x

23

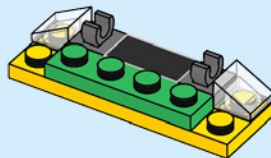



2x

24

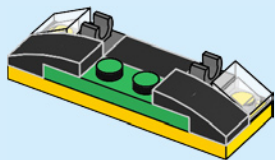

1x

25

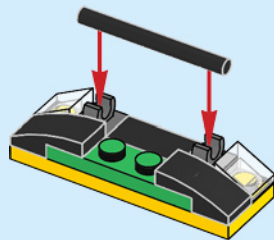



1x

# 26

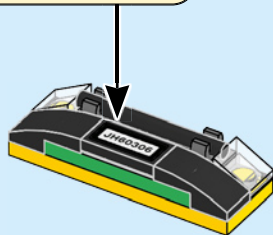
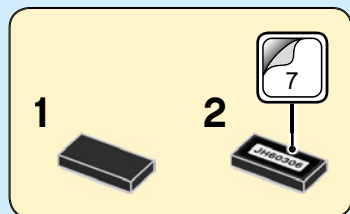



27

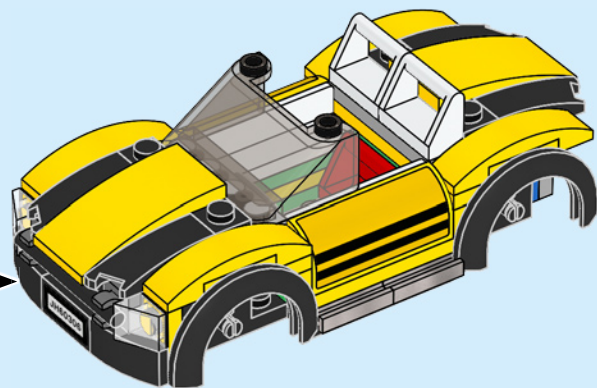



1x

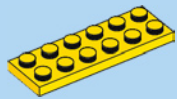

28

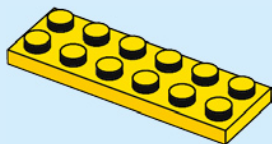

1x

29

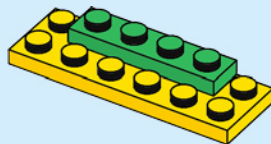



2x

30

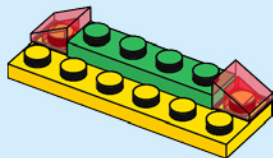

1x

31

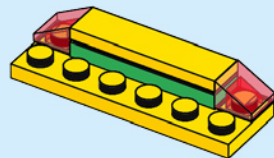



2x

32

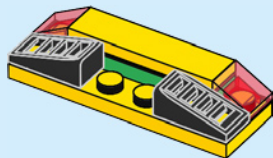

2x

33

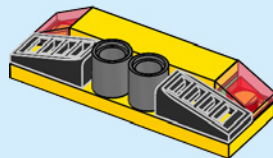

34

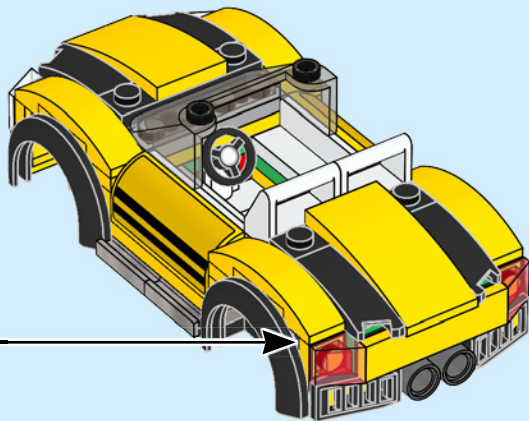
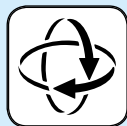



35

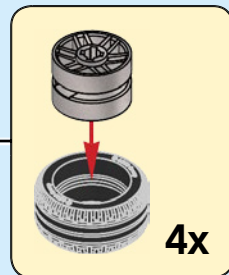
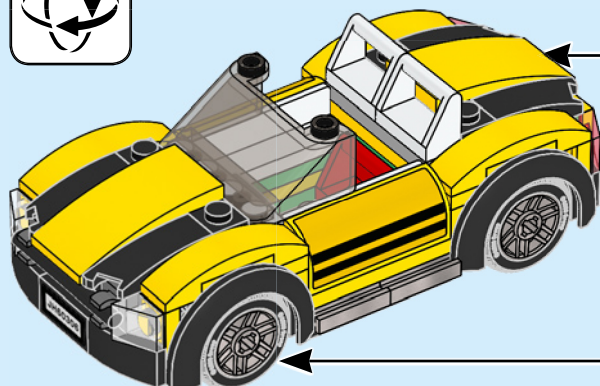
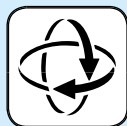

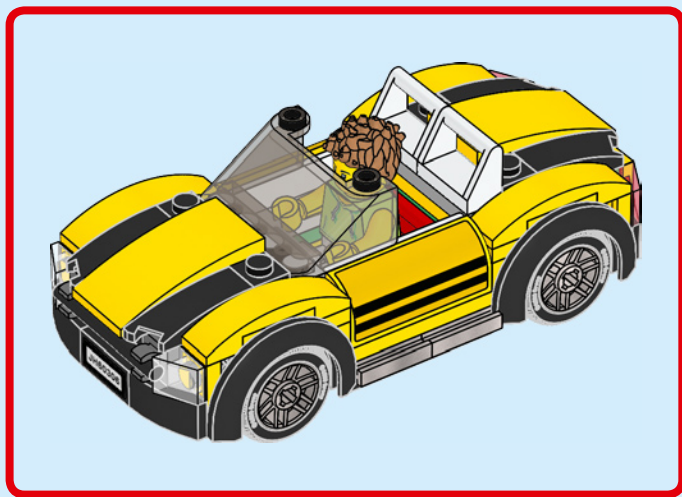

# CITY ADVENTURES

# AVENTURAS CITY



VITO

60242



SAM  
GRIZZLED

60243



SNAKE  
RATTLER

60243 • 60276



ROOKY  
PARTNUR

60244



FRANKIE  
LUPELLI

60244 • 60277



TOM  
BENNETT

60245



BIG  
BETTY

60245



WHEELER

60246



DAISY  
KABOOM

60246



CLARA  
THE CRIMINAL

60276



GRACIE  
GOODHART

60277



DUKE  
DETAIN

60242 • 60246 • 60276



FREYA  
MCLOUD

60248 • 60280



CLEMMONS

60247 • 60281



BOB

60282



FELDMAN

60282



TREAD  
OCTANE

60258



HARL  
WIBBS

60258 • 60266

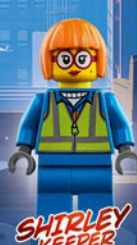

SHIRLEY  
KEEPER

60292



MADISON

60292