



# CITY

60098

4



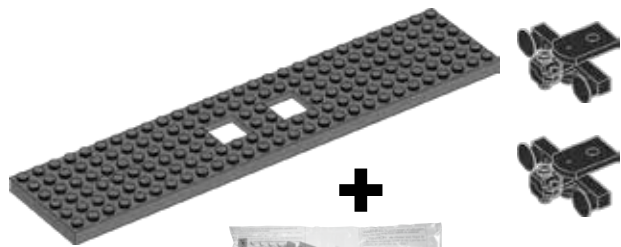

+

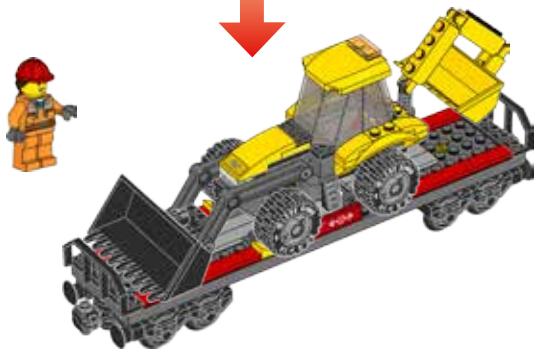

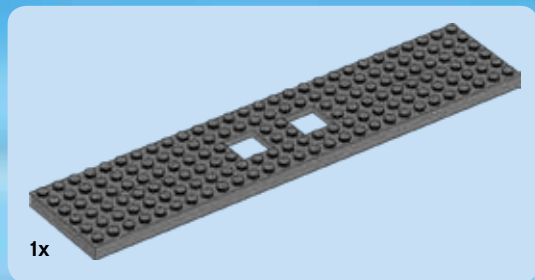

1x

**1**

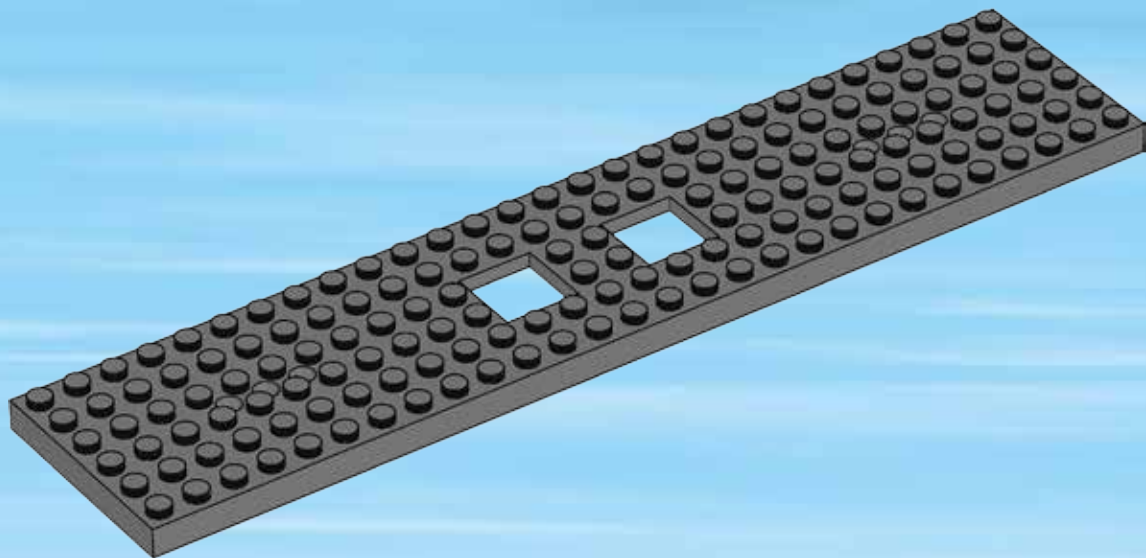

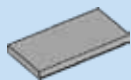

1x



2x

2

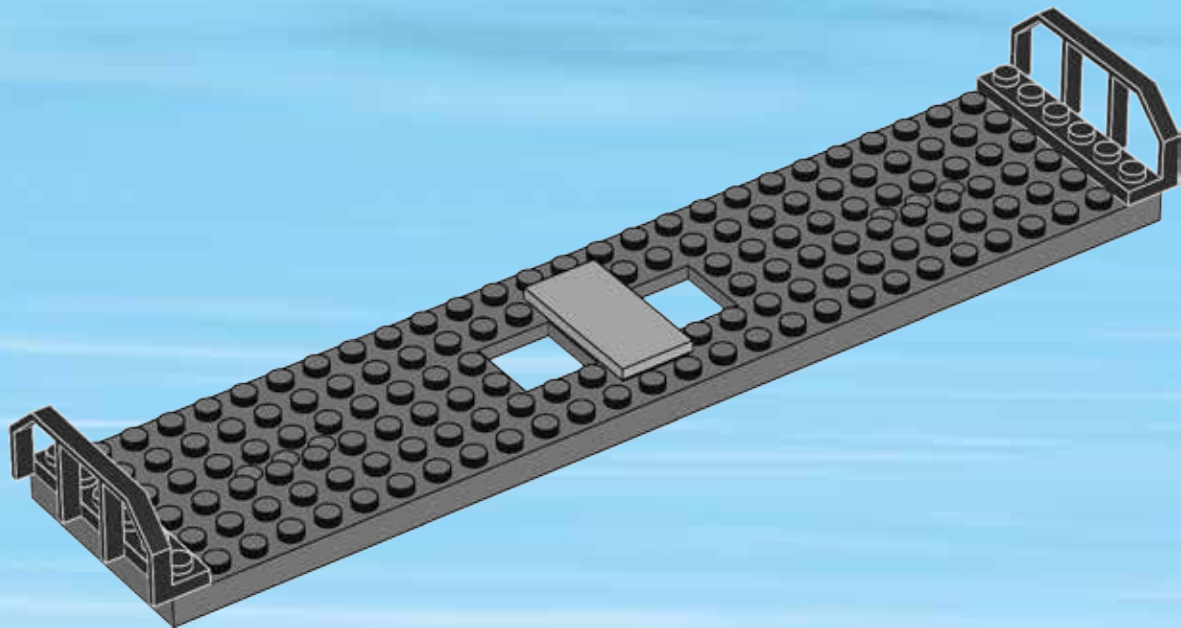

4



3

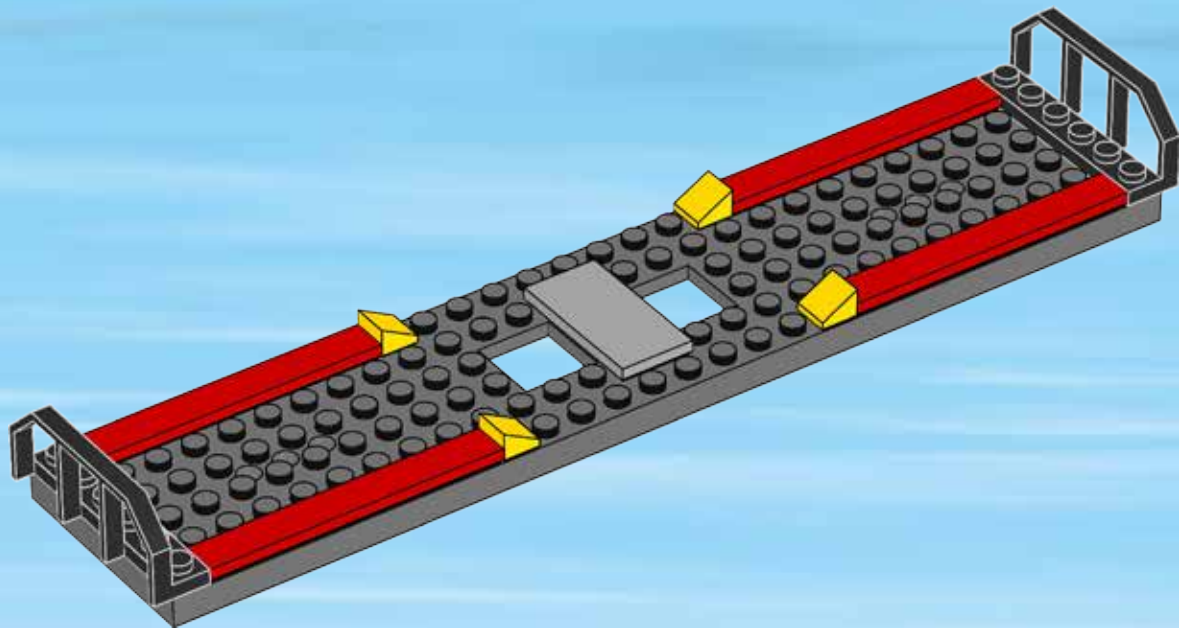

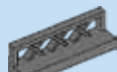

4x



4x

4

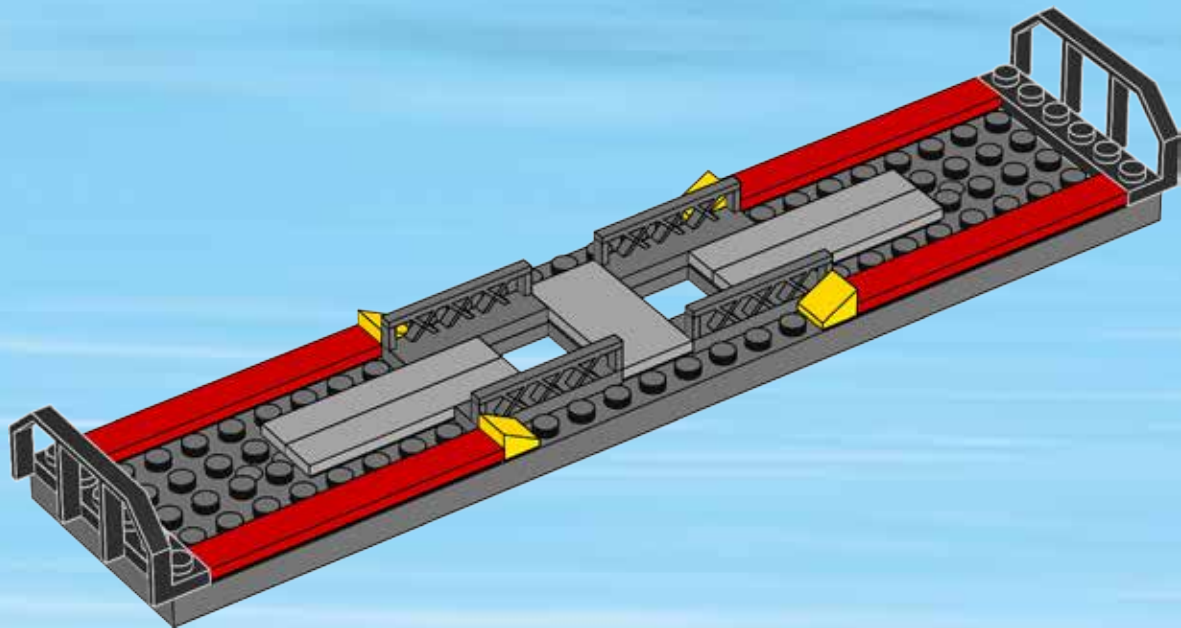

6





5

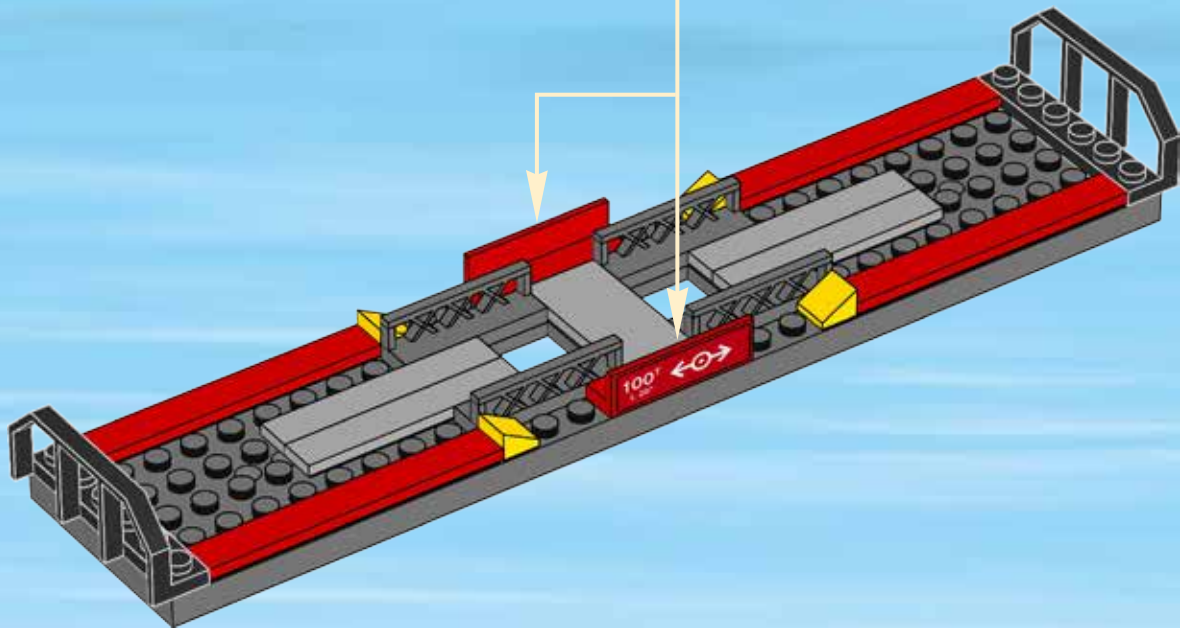
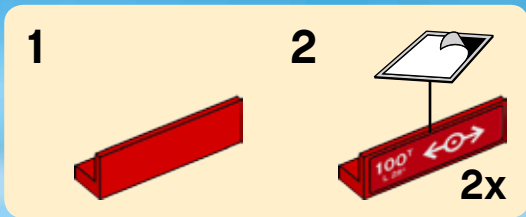

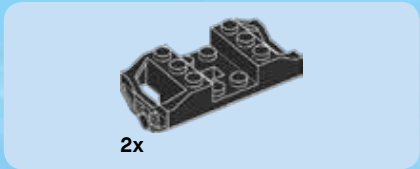
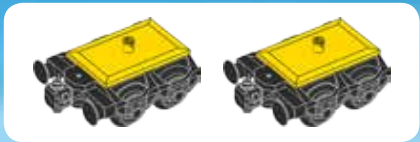

2x

1

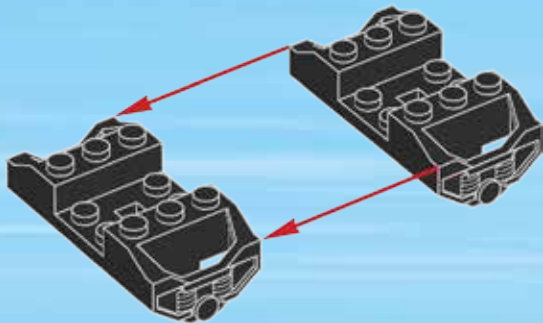





1x

2

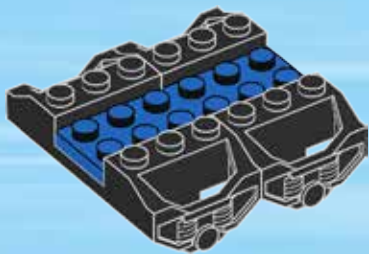

1x

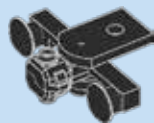

1x

3





4

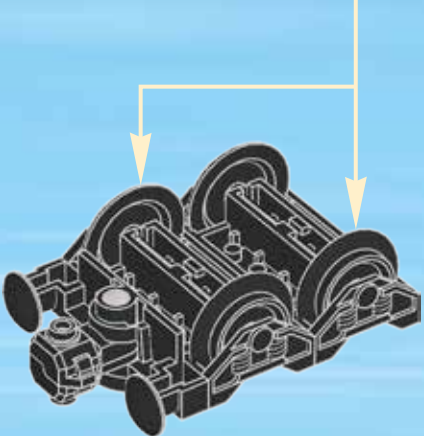
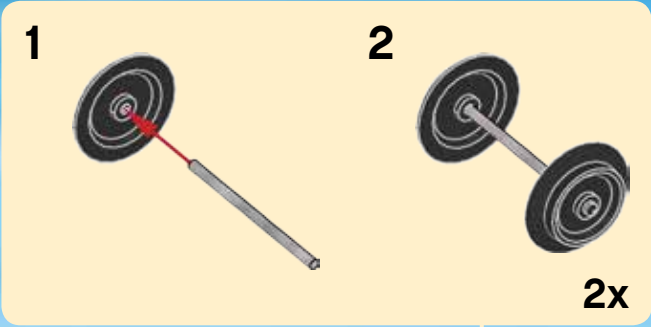



1x

5

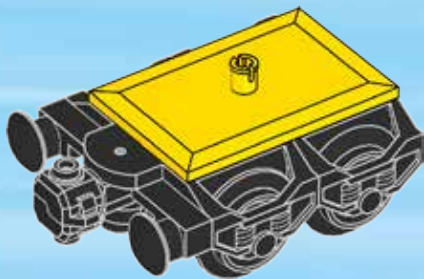

2x

6

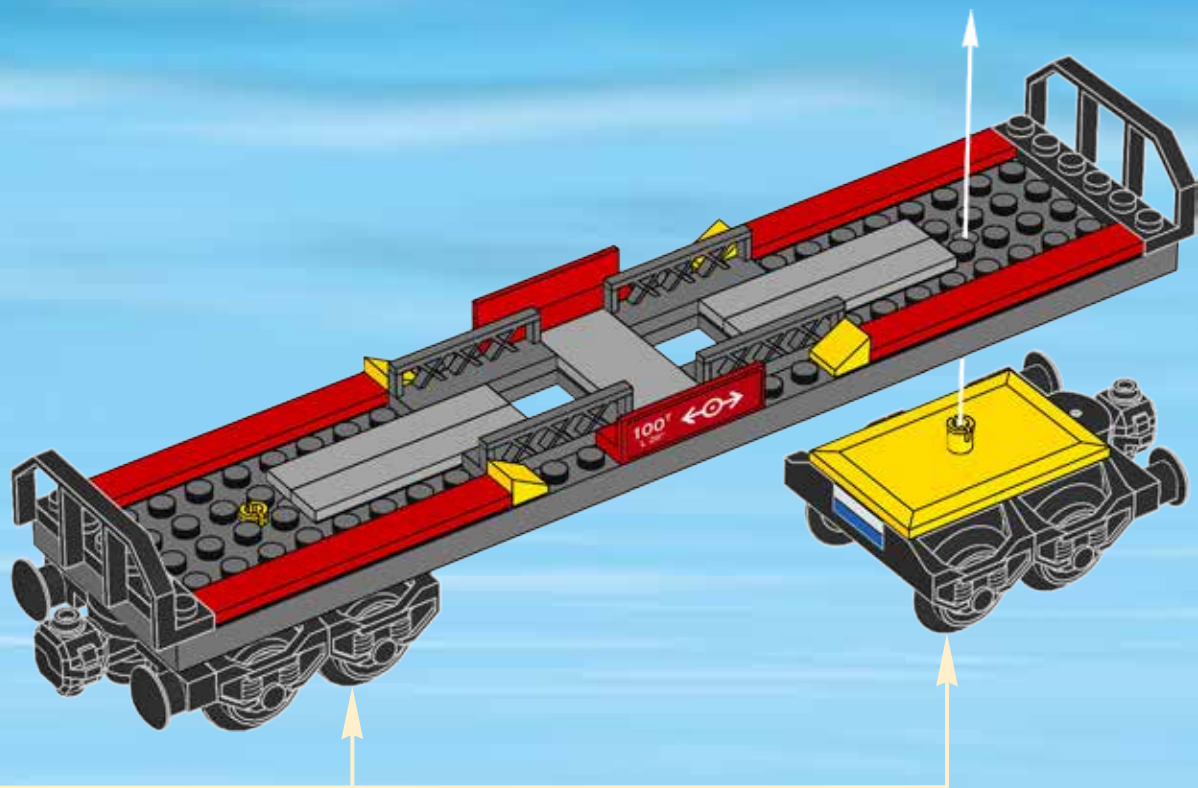

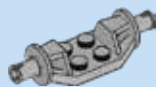

1x

1

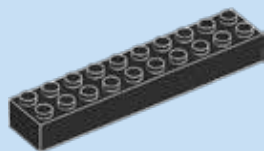

1x

2

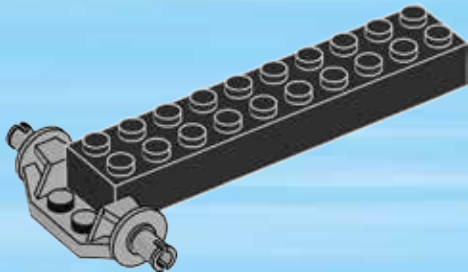



1x

3

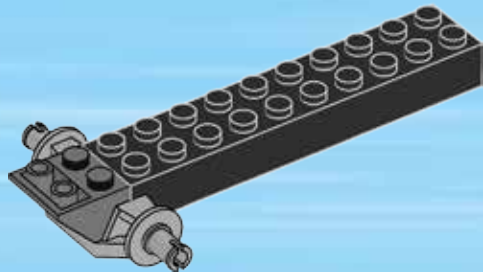



1x



1x

4

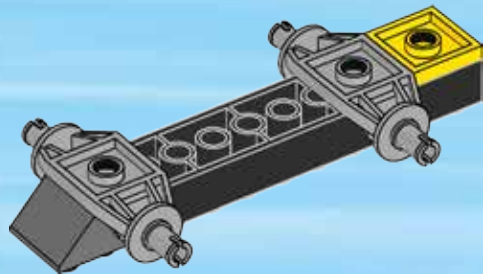





5

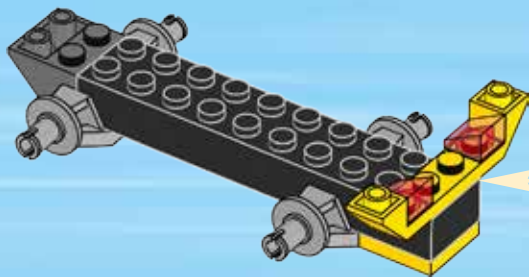
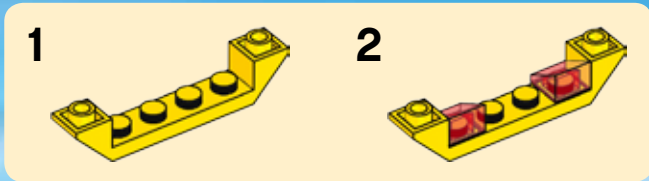



1x

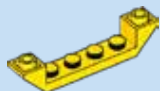

1x

6

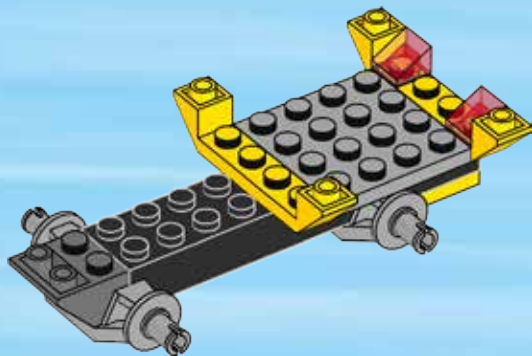



2x



2x

# 7

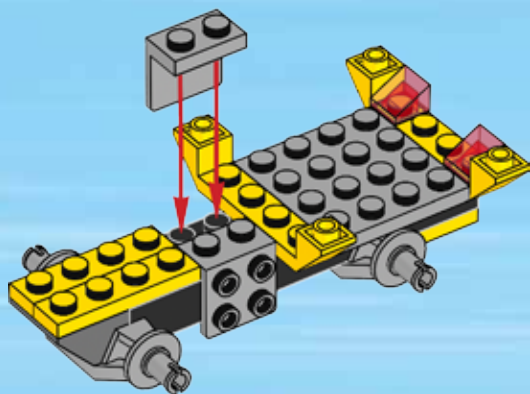



1x



2x

8

1

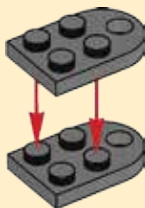

2

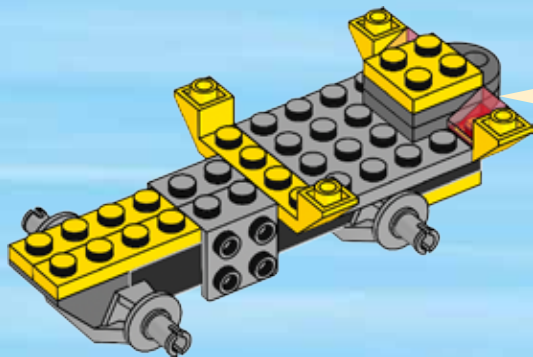



2x



1x

9

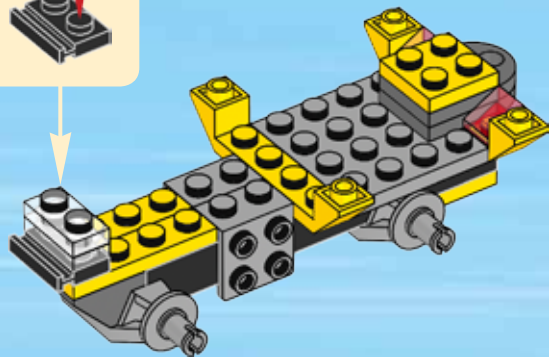
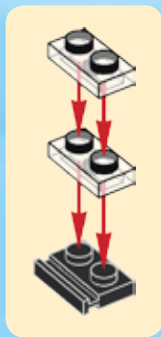



1x

# 10

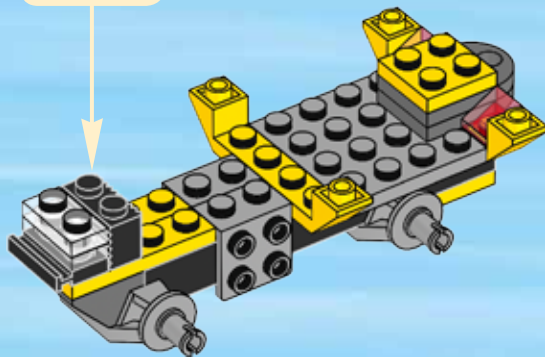



4x



2x

# 11

## 1



## 2

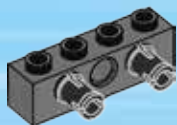

## 3

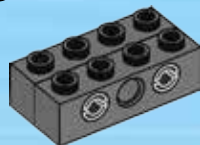



4

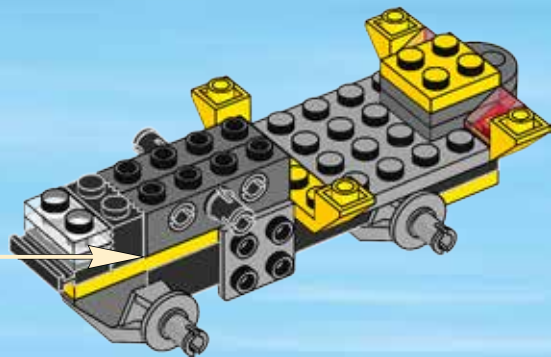
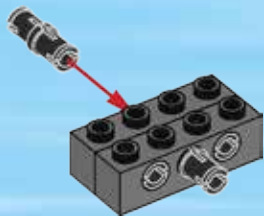



1x



2x

# 12

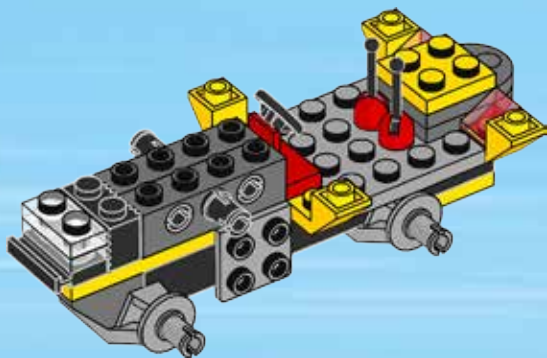

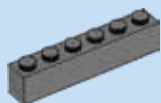

2x

13

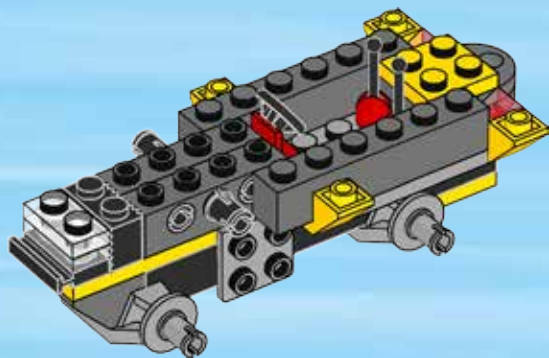



4x



2x

# 14

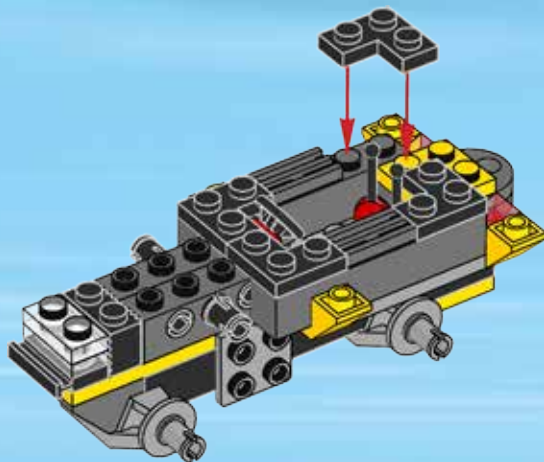



1x



1x

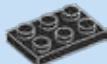

1x



1x

# 15

1

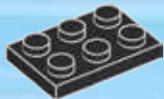

2

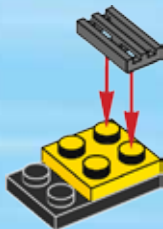

3

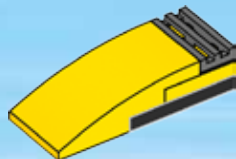

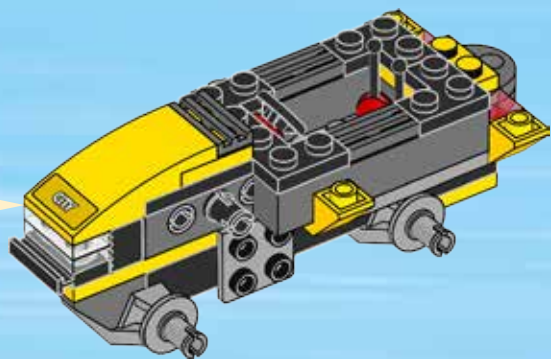
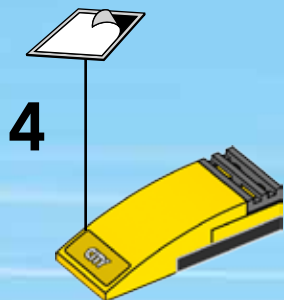



4x



2x

# 16

1



2

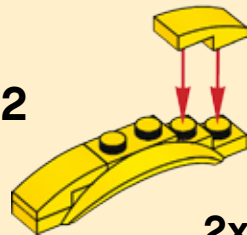

2x

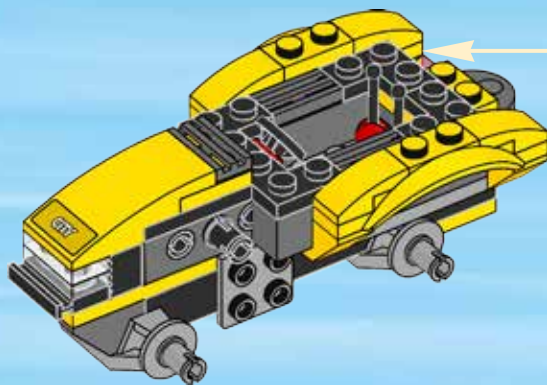





1x



1x

# 17



1



2

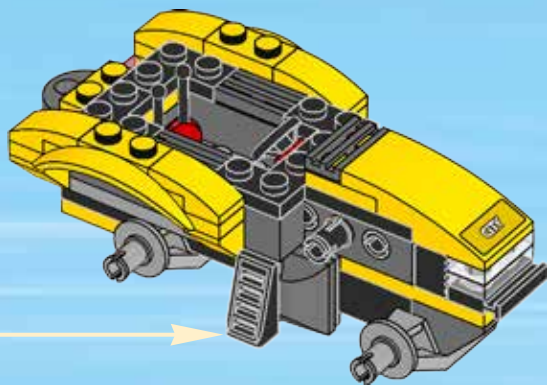



1x



1x

# 18

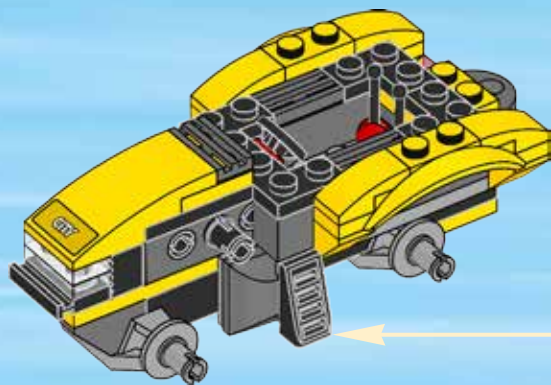

1



2





2x

# 19

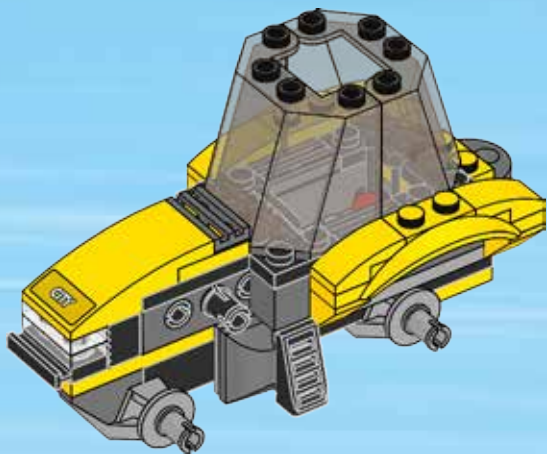

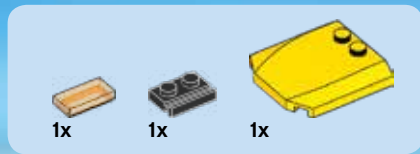

20

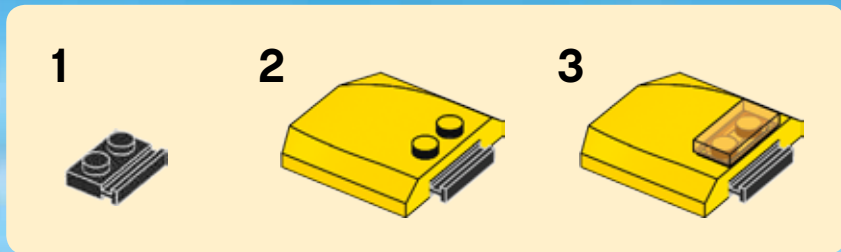

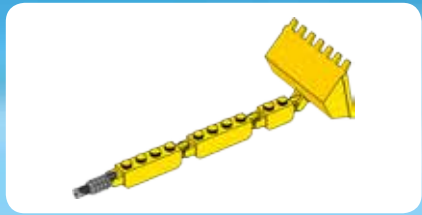

1

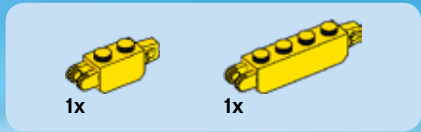
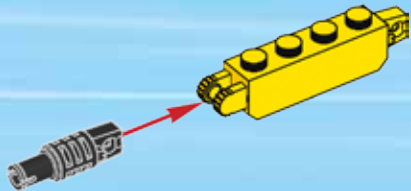

2

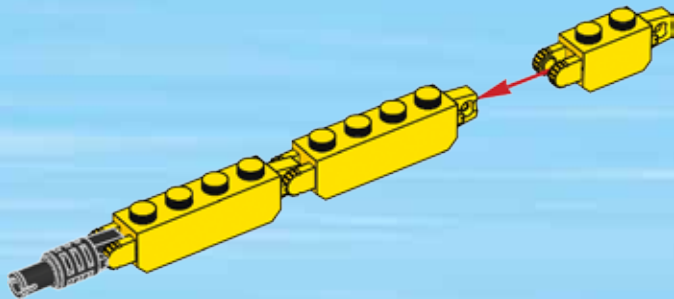

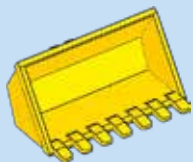

1x

3

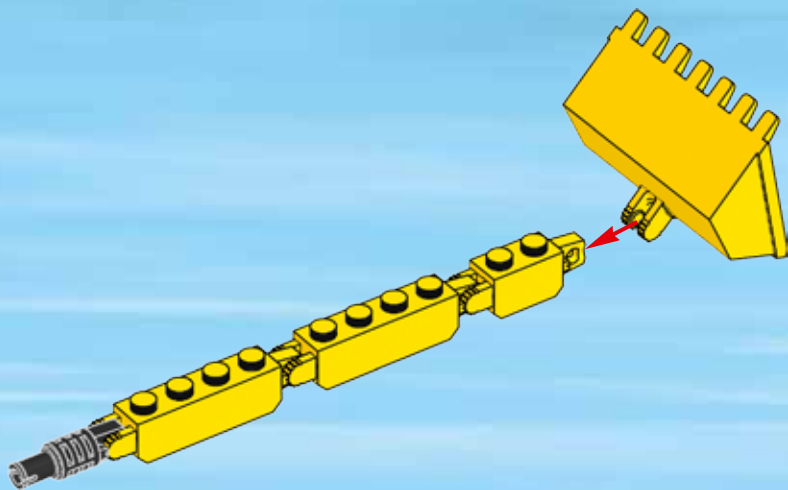

21

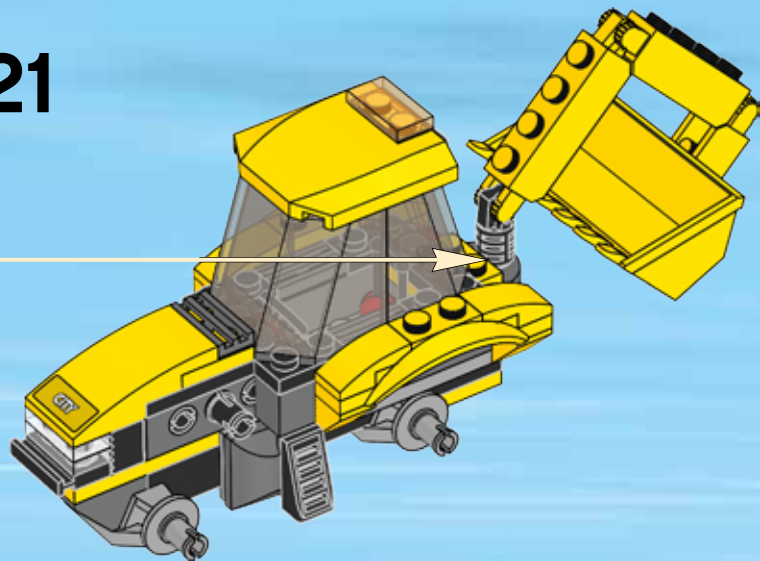



1x

1



2x

2

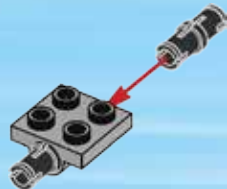





1x

3

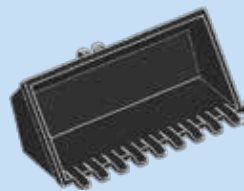

1x

4

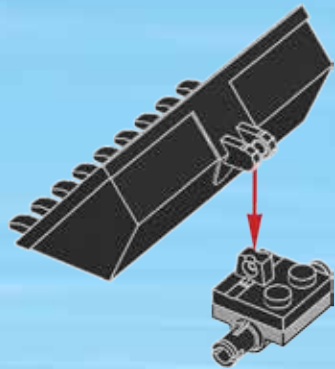



1x

5

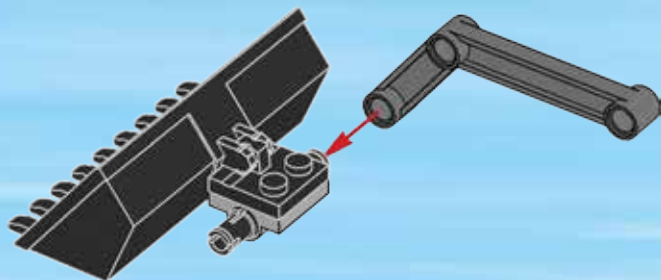

22

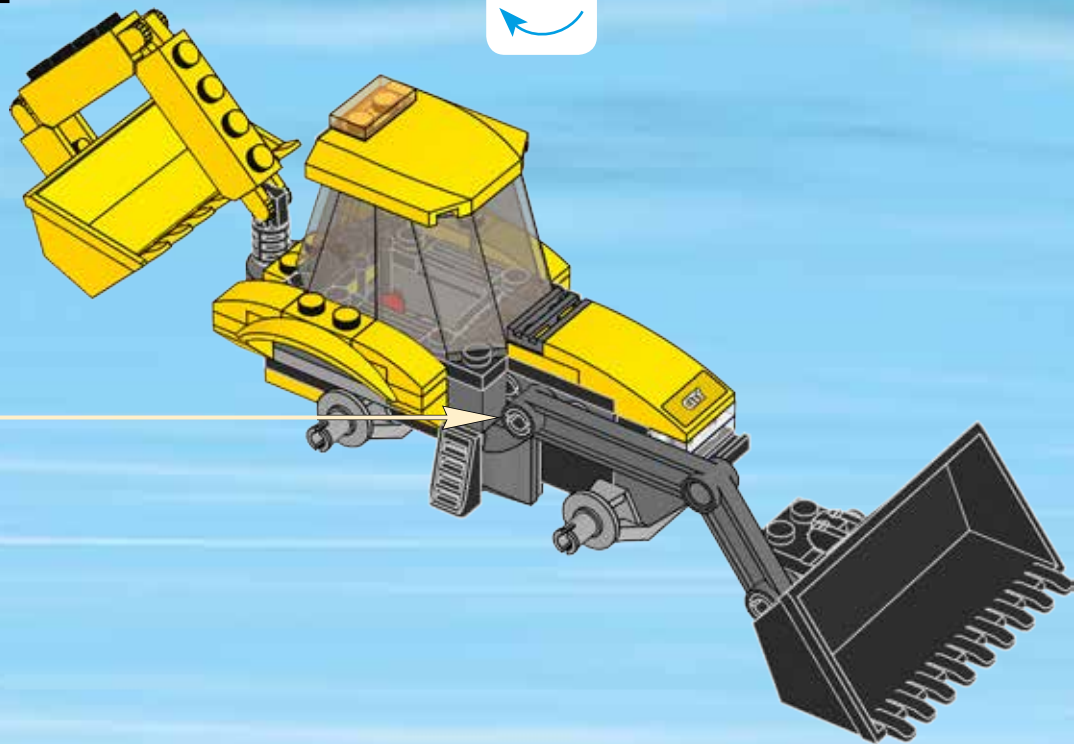



1x



23

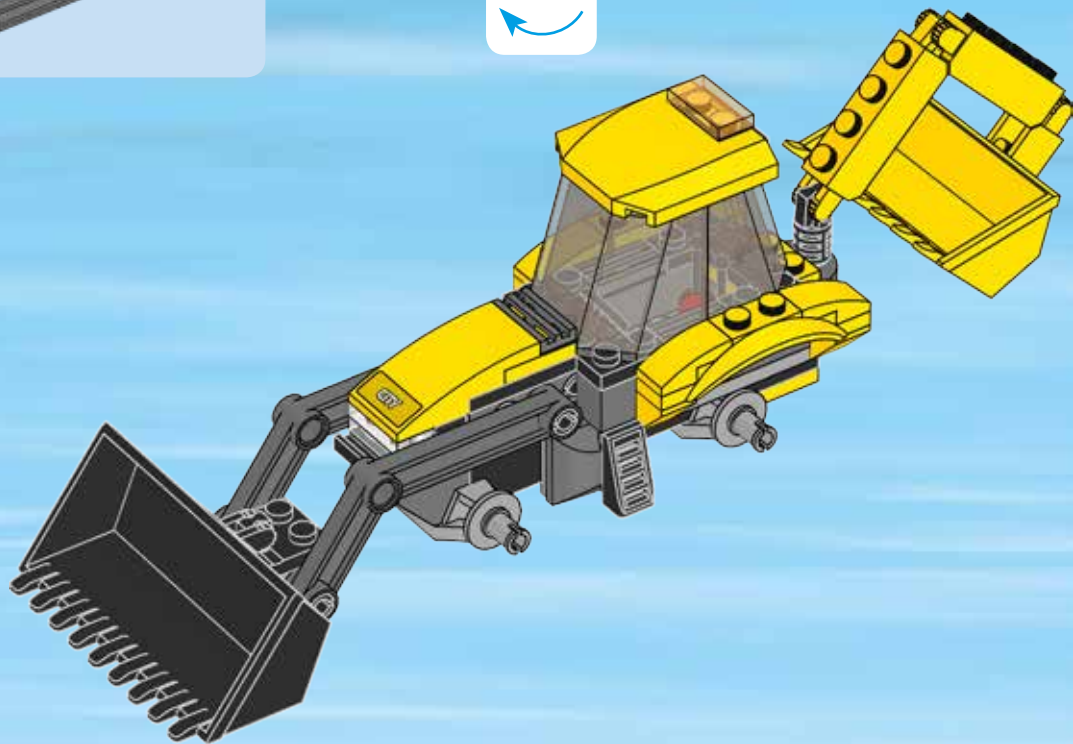



4x



4x

# 24

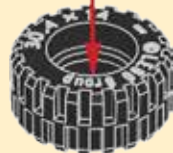
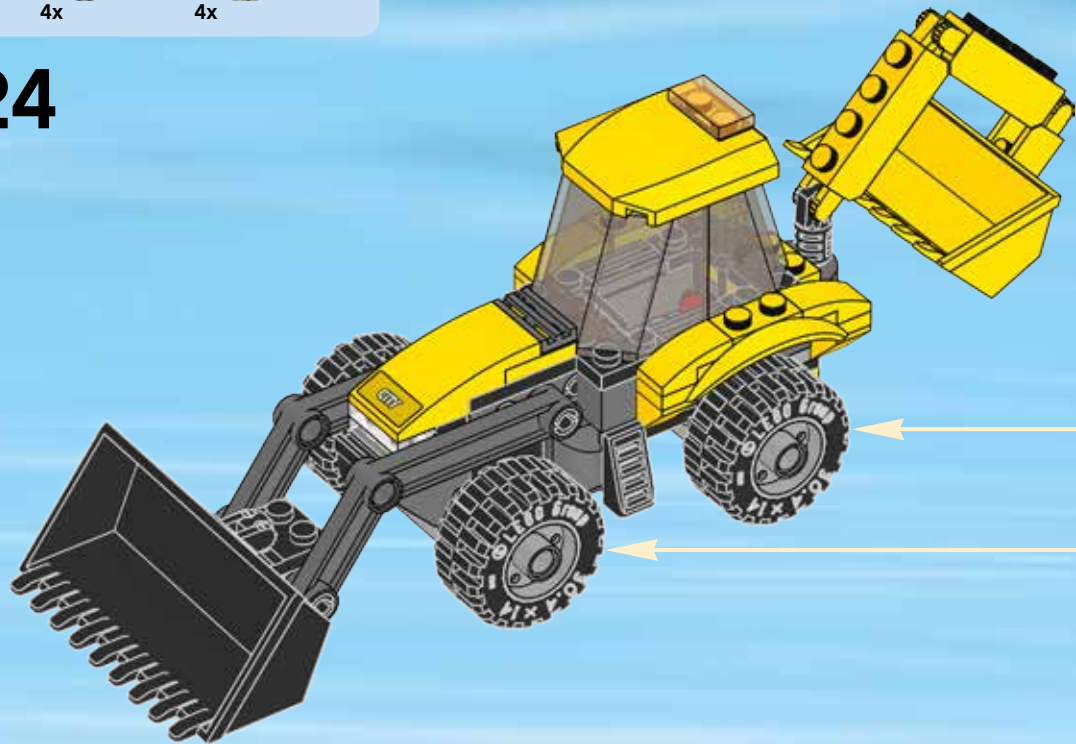

4x

