



CITY

60050



 LEGO.com/city

 **WARNING: CHOKING HAZARD.**
Small parts. Not for children under 3 years.

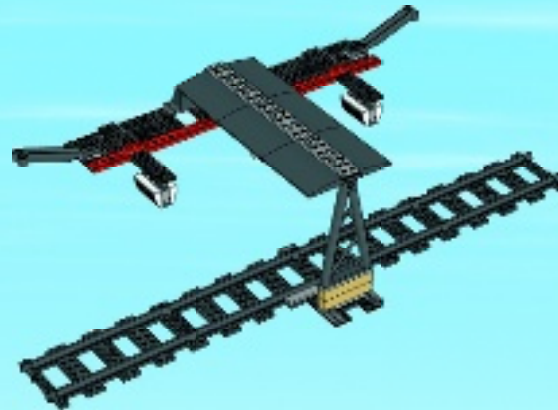
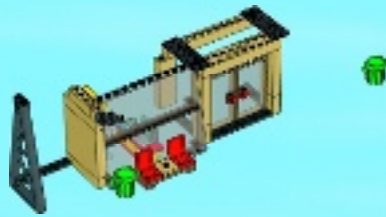
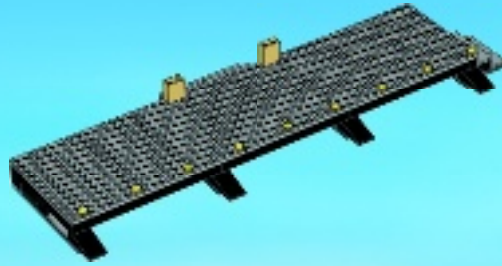

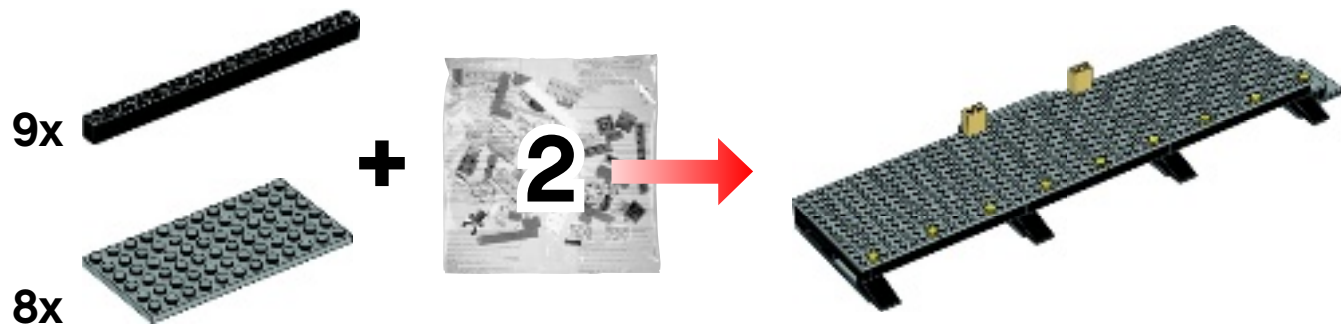

1

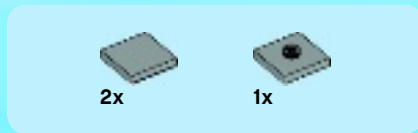

2

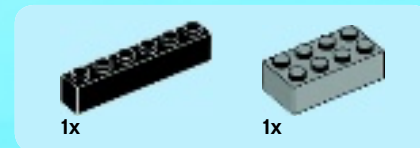

3

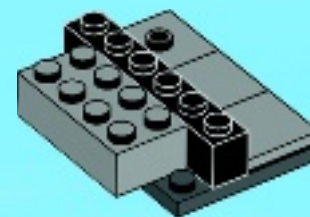

⚠ **AVERTISSEMENT :**
 RISQUE D'ÉTOUFFEMENT.
 Contient des petites pièces. Ne convient pas aux enfants de moins de 3 ans.

⚠ **ADVERTENCIA:**
 PELIGRO DE ASFIXIA.
 No recomendado para niños menores de 3 años. Contiene piezas pequeñas.



2x

4

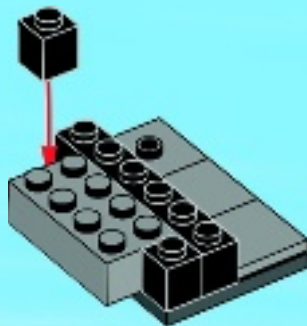

2x



1x

5

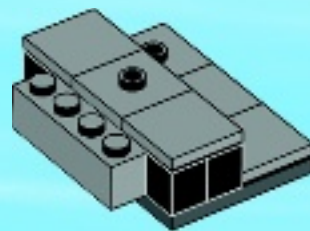

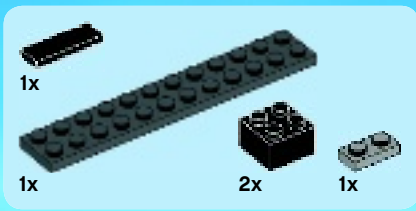

6

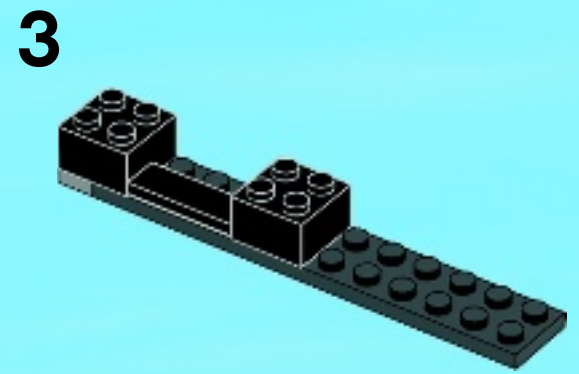
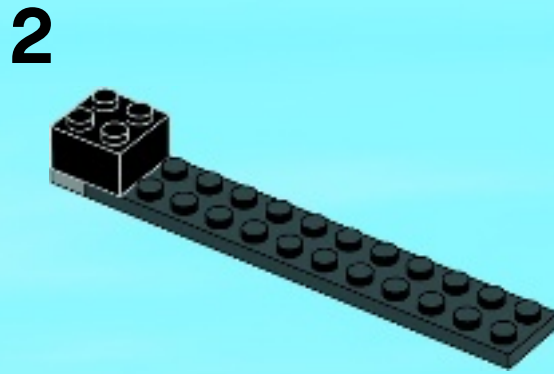
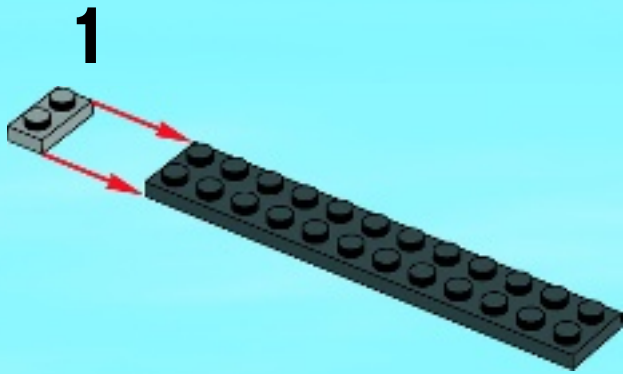



1x

7

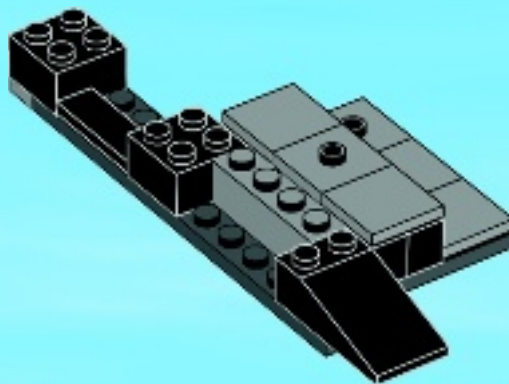
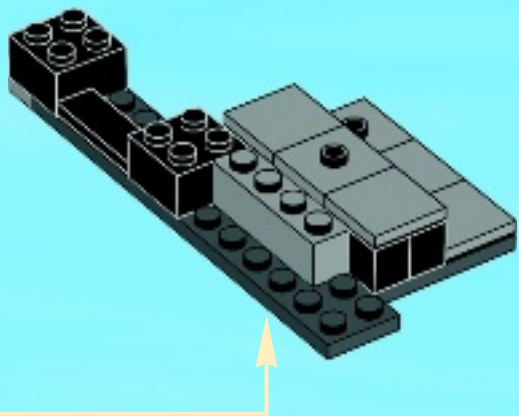



8

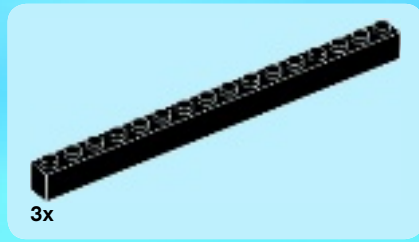
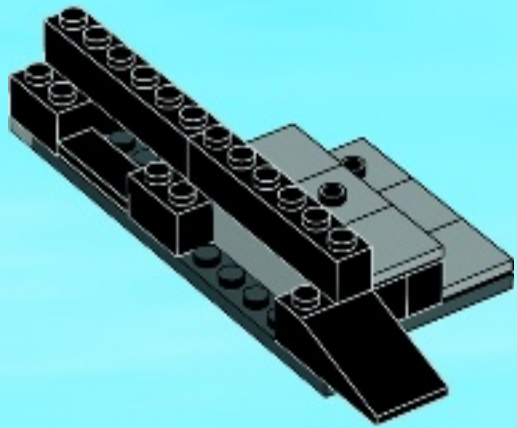

9

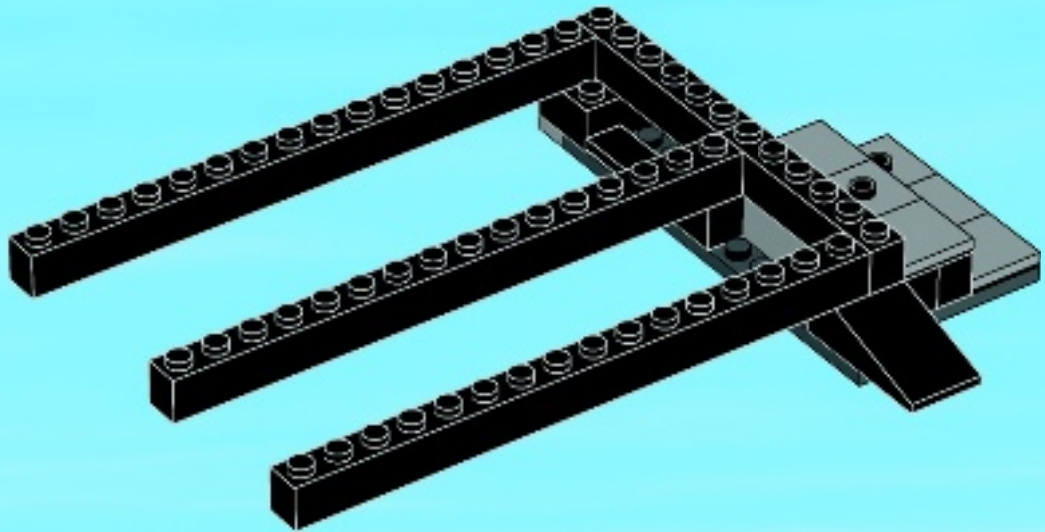

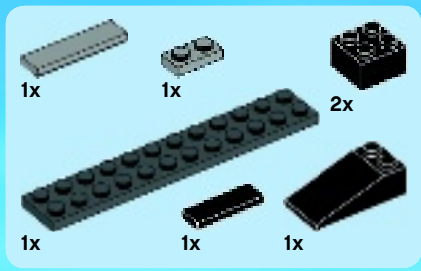

10

1

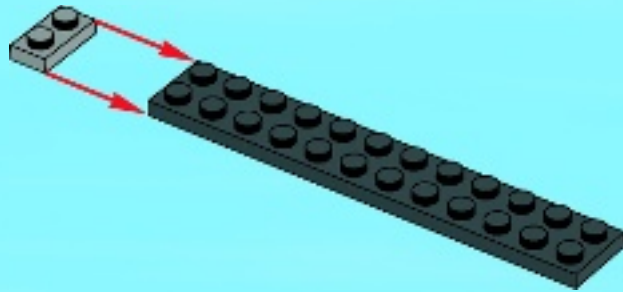

2

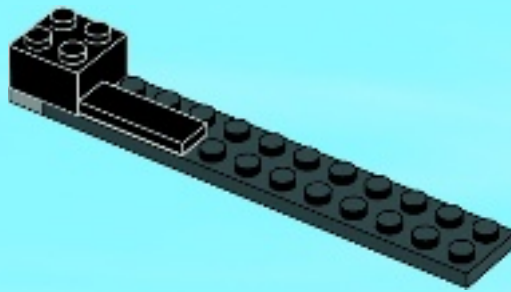

3

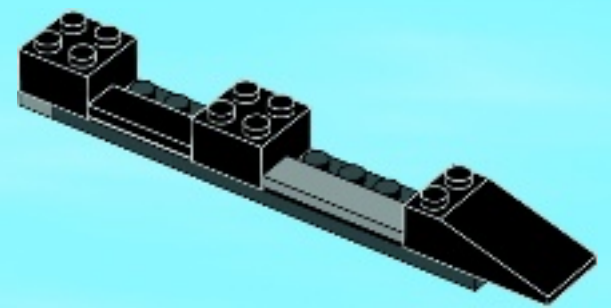

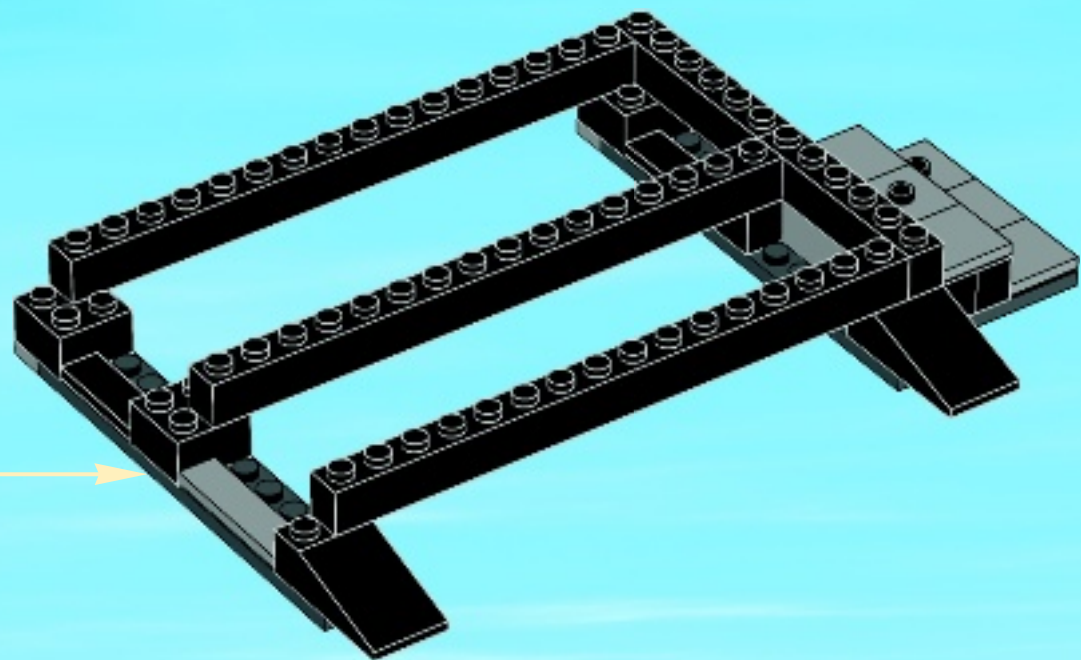



11

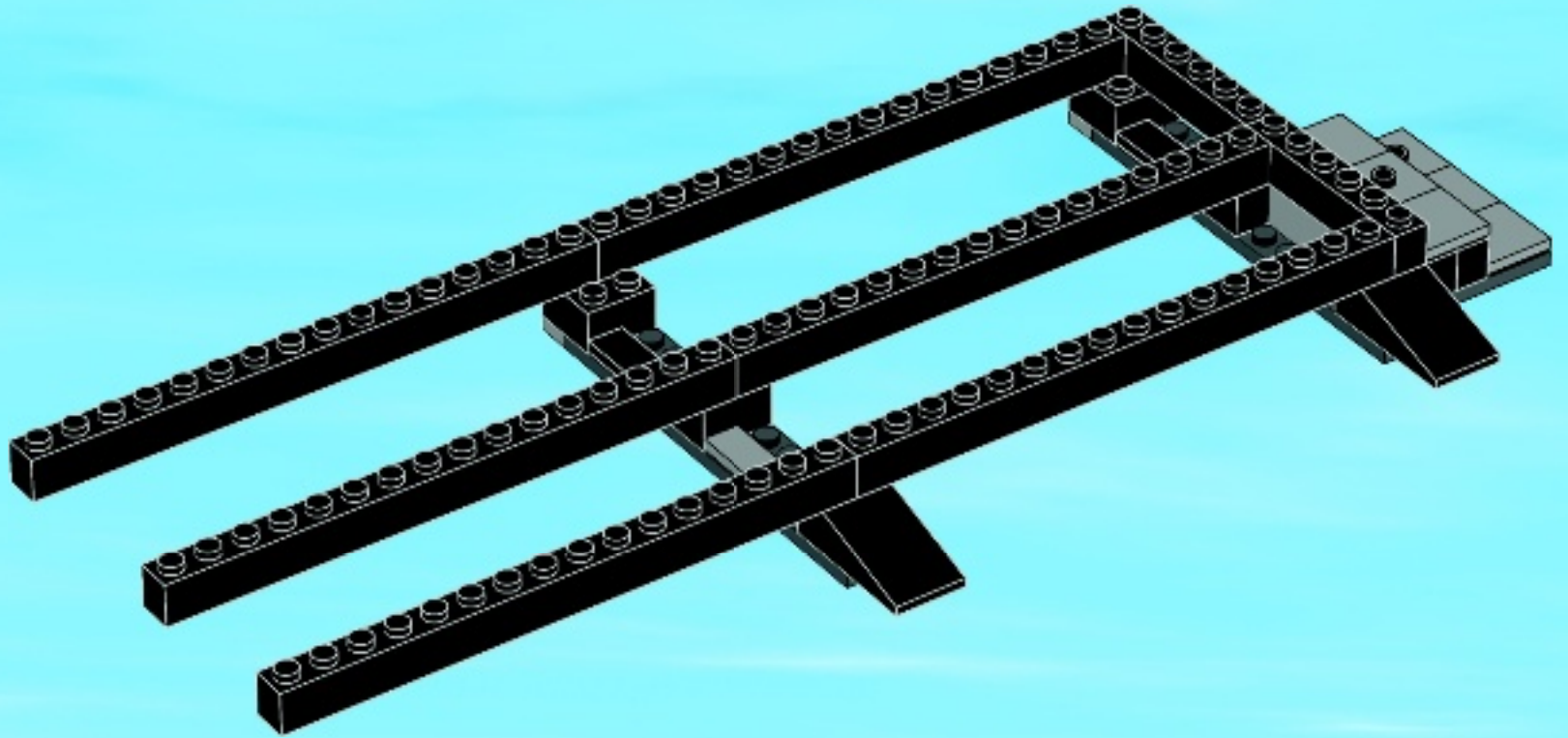

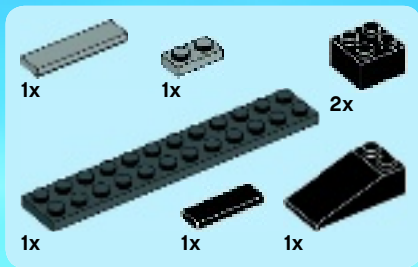

12

1

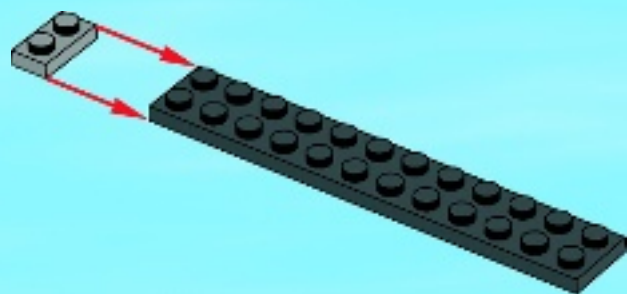

2

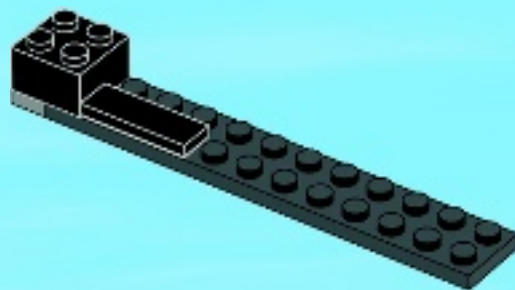

3

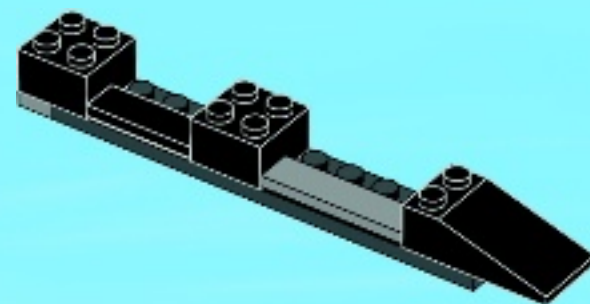

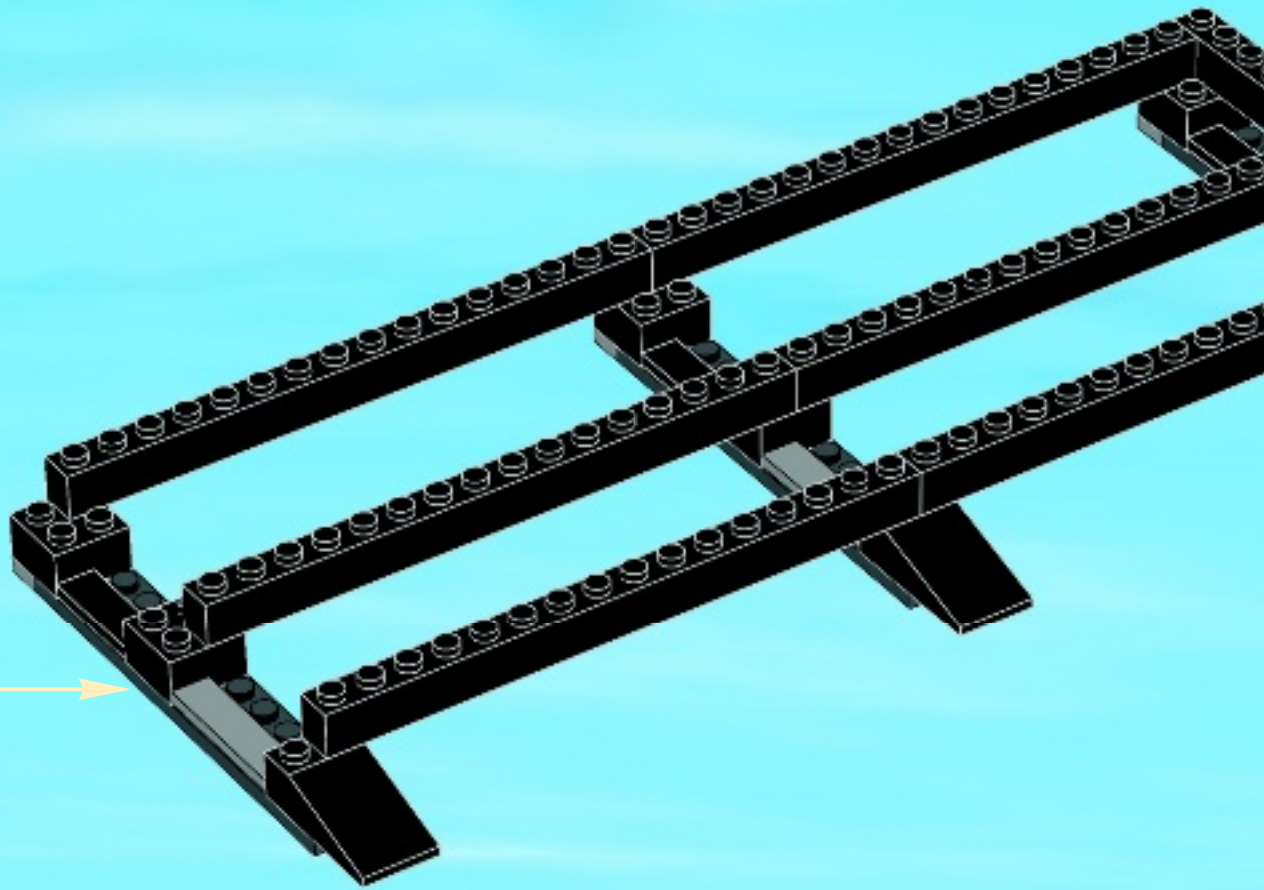



13

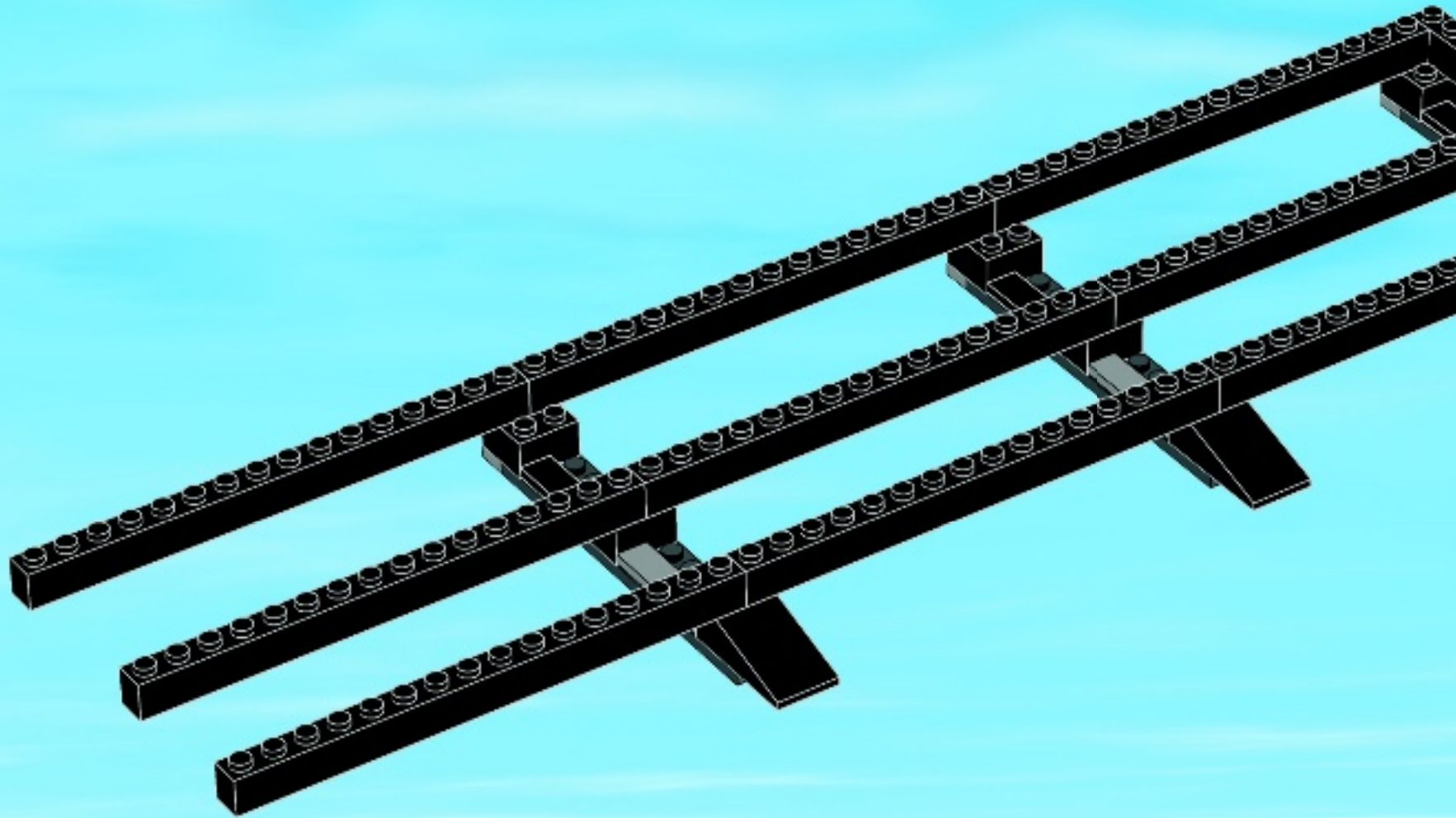

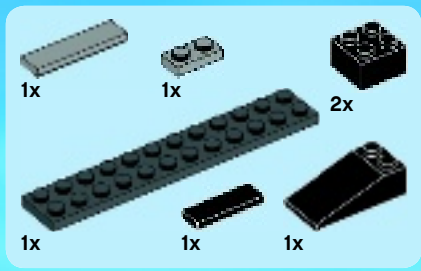

14

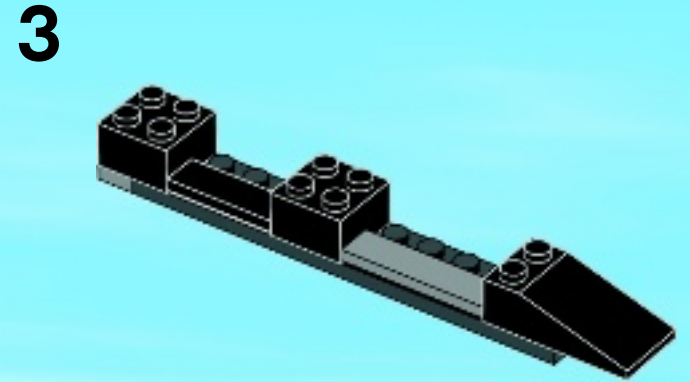
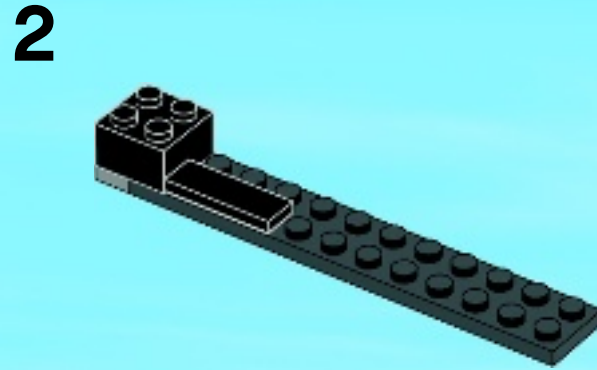
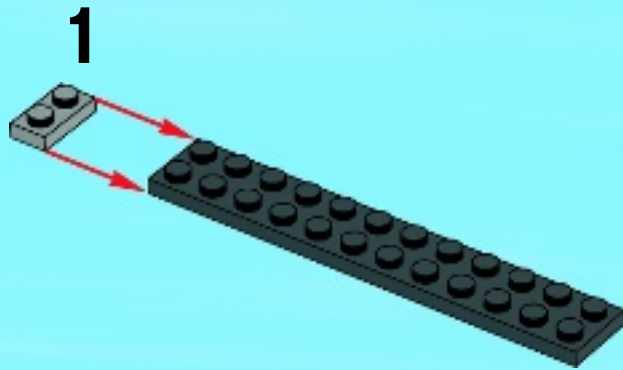

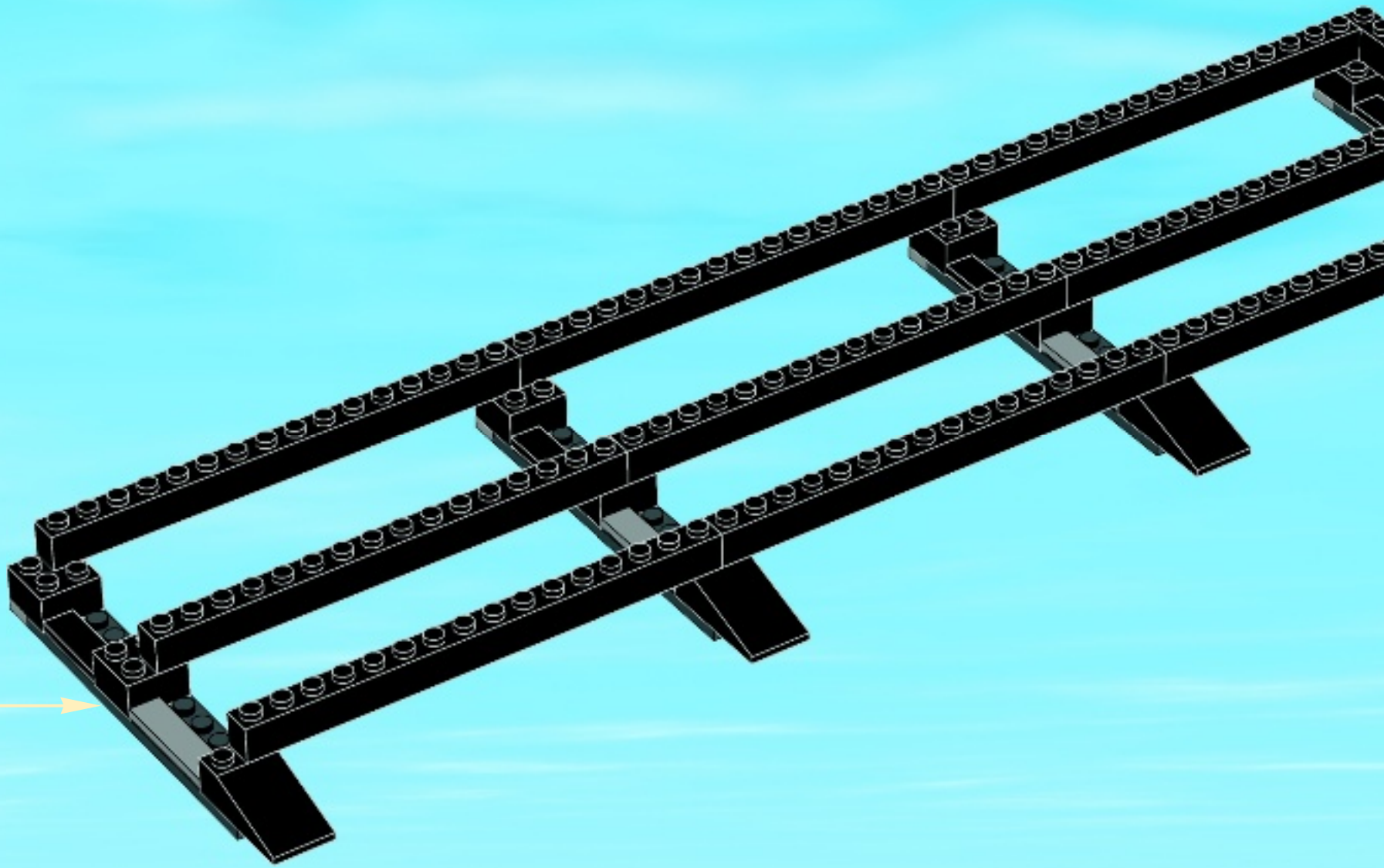



15

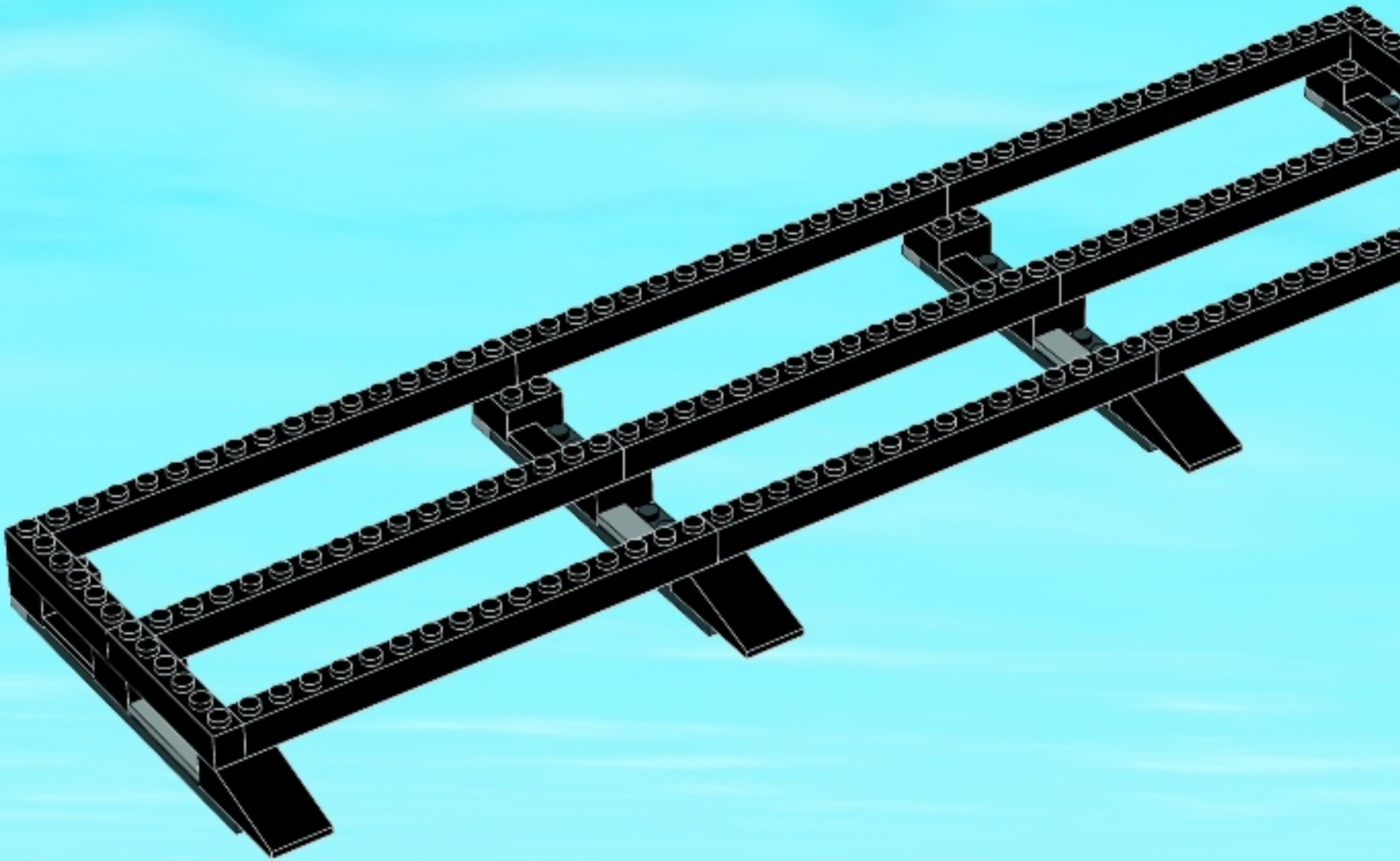

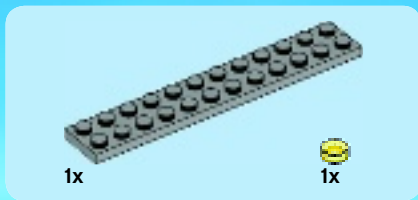

16

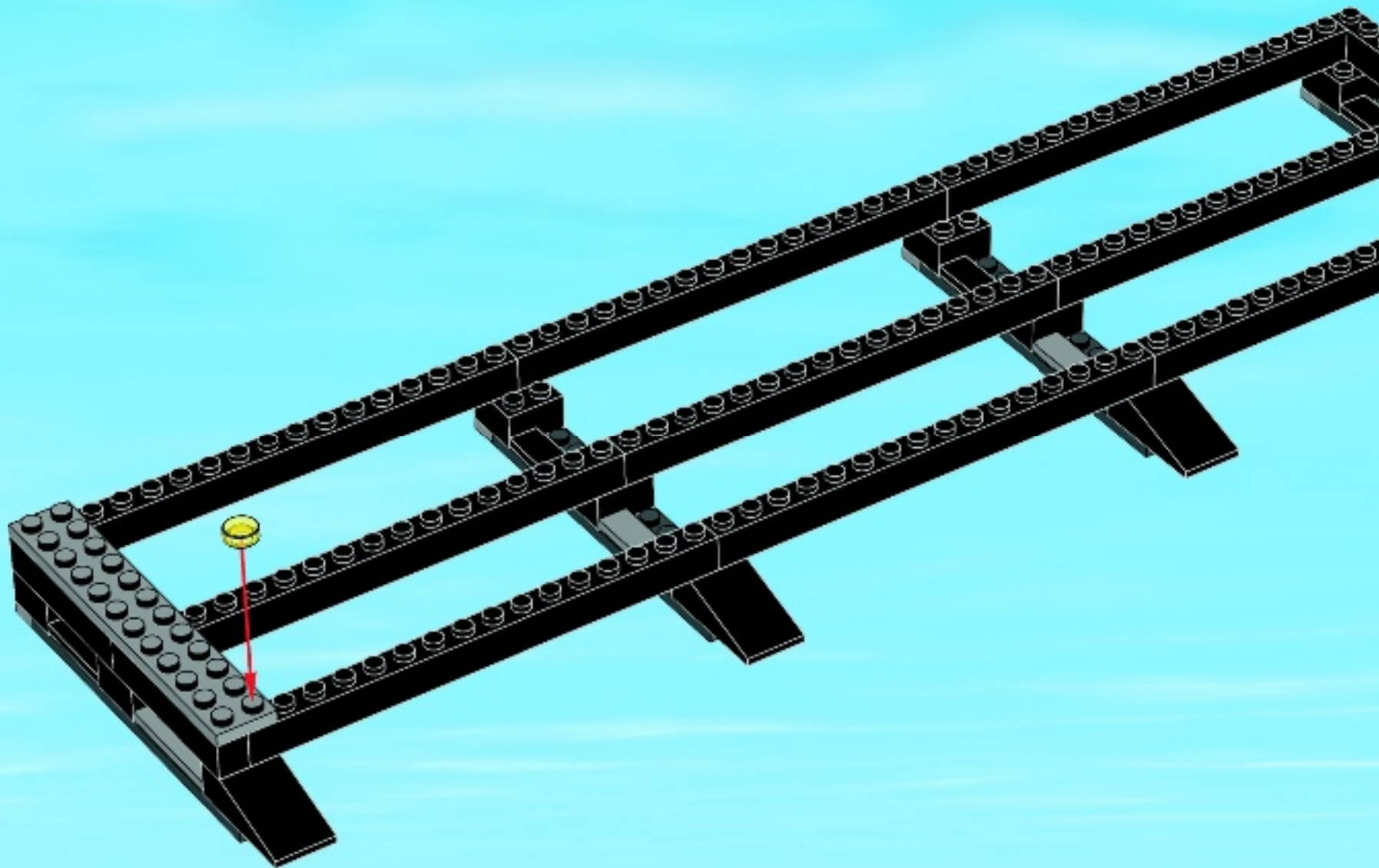

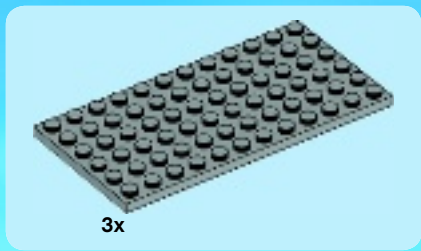

17

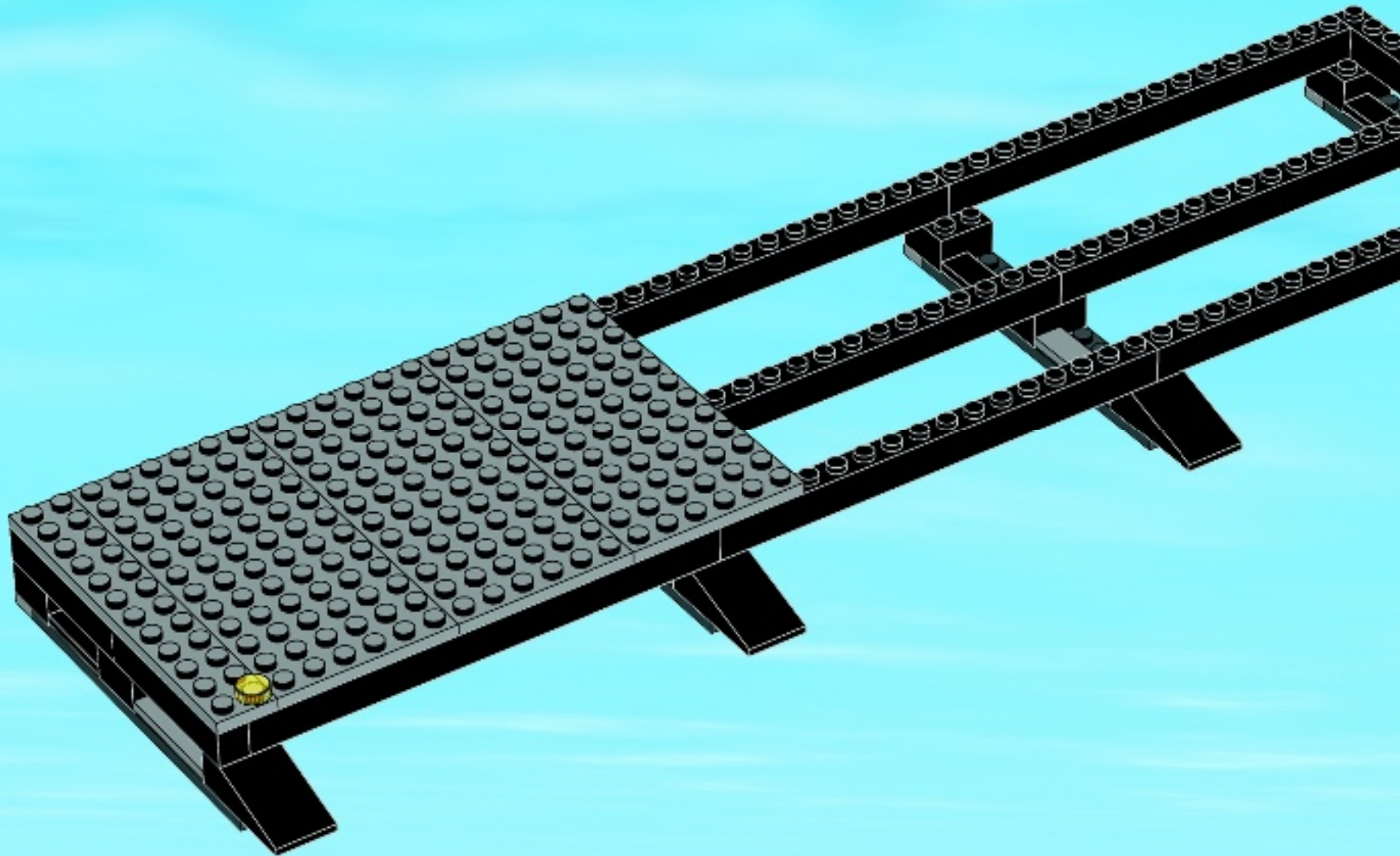



1x



3x

18

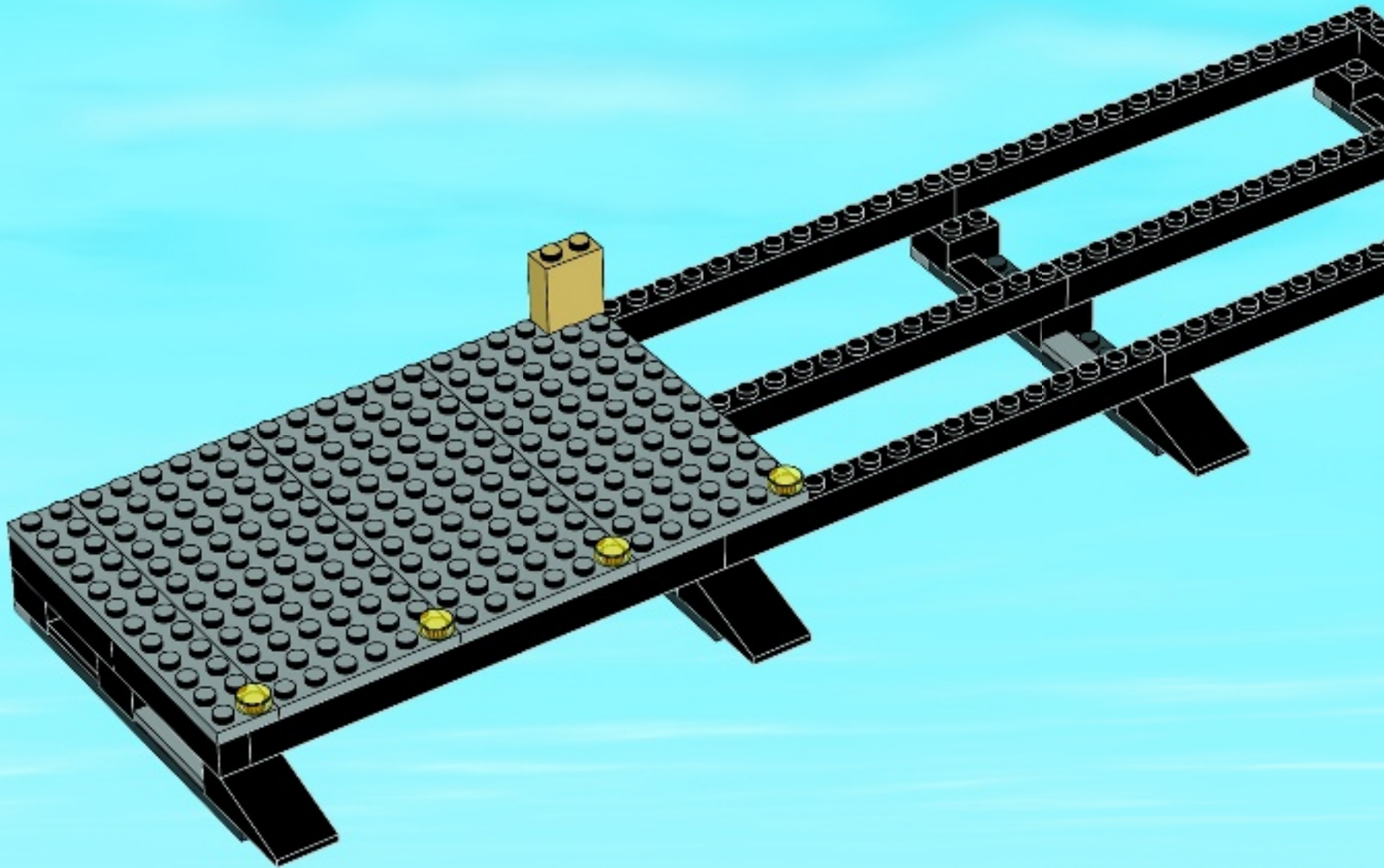

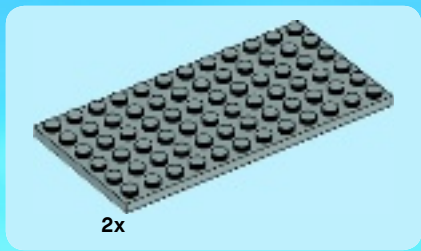

19

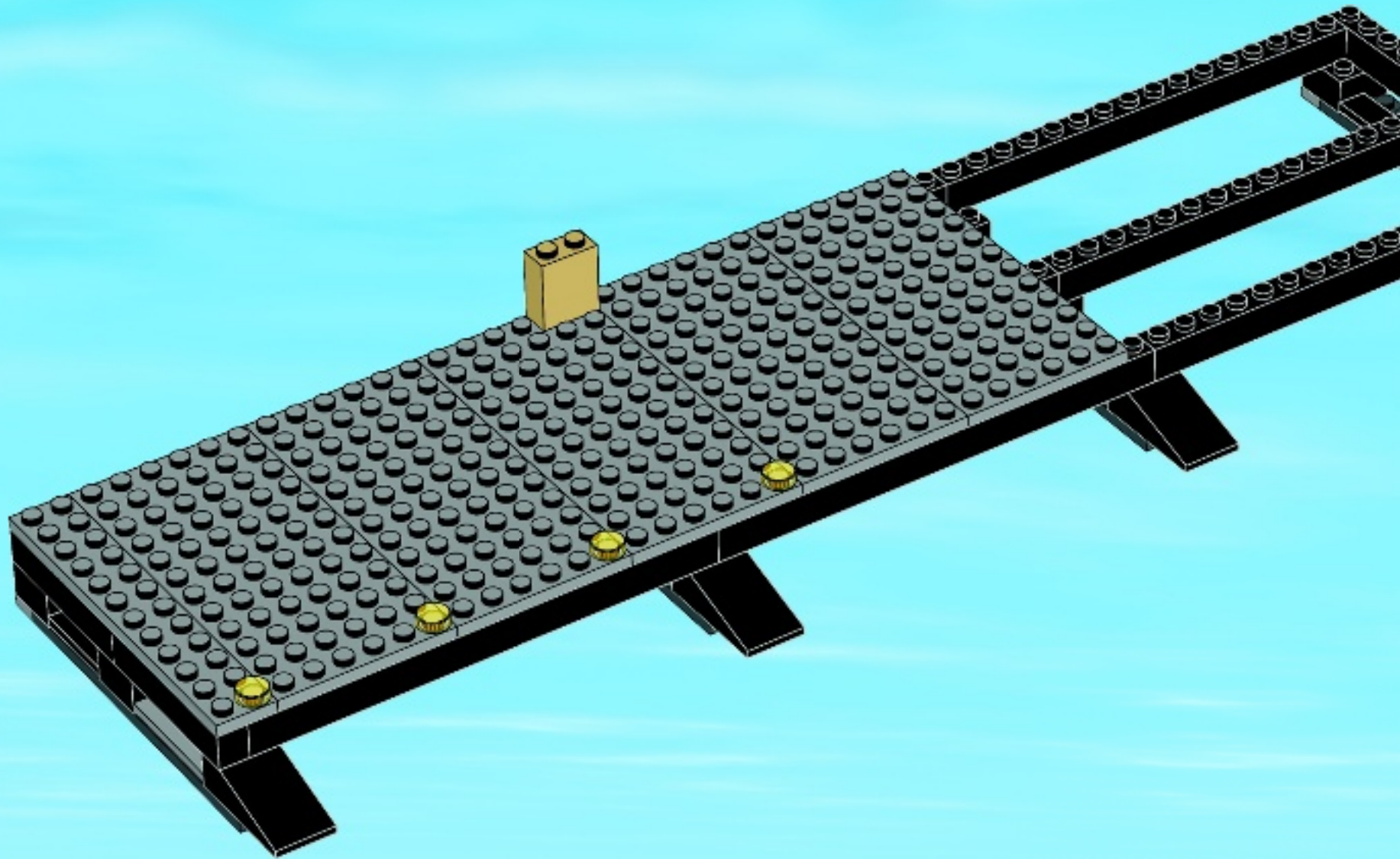



1x



2x

20

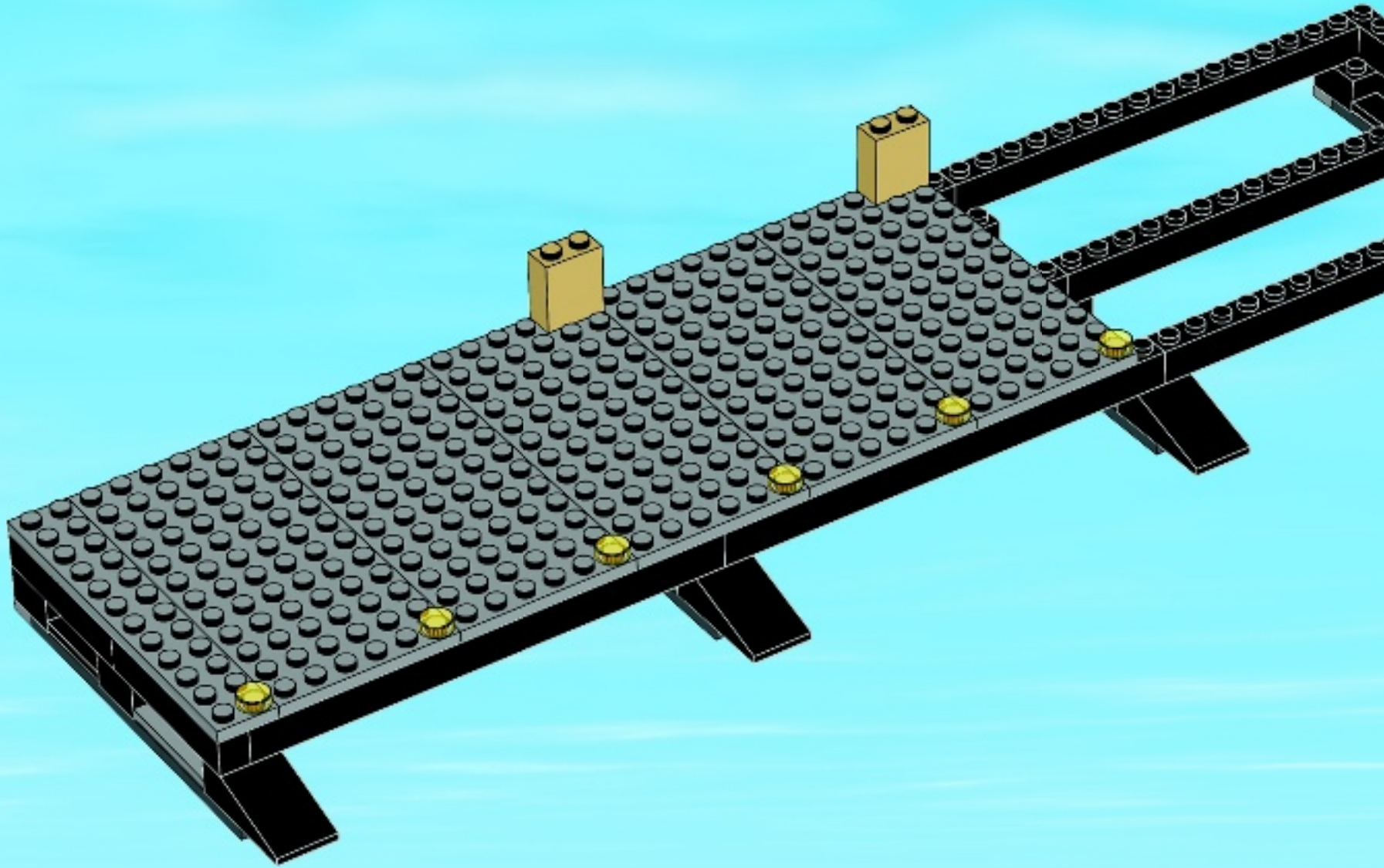

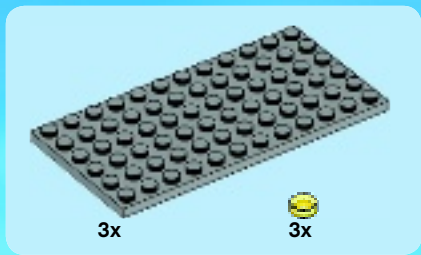

21

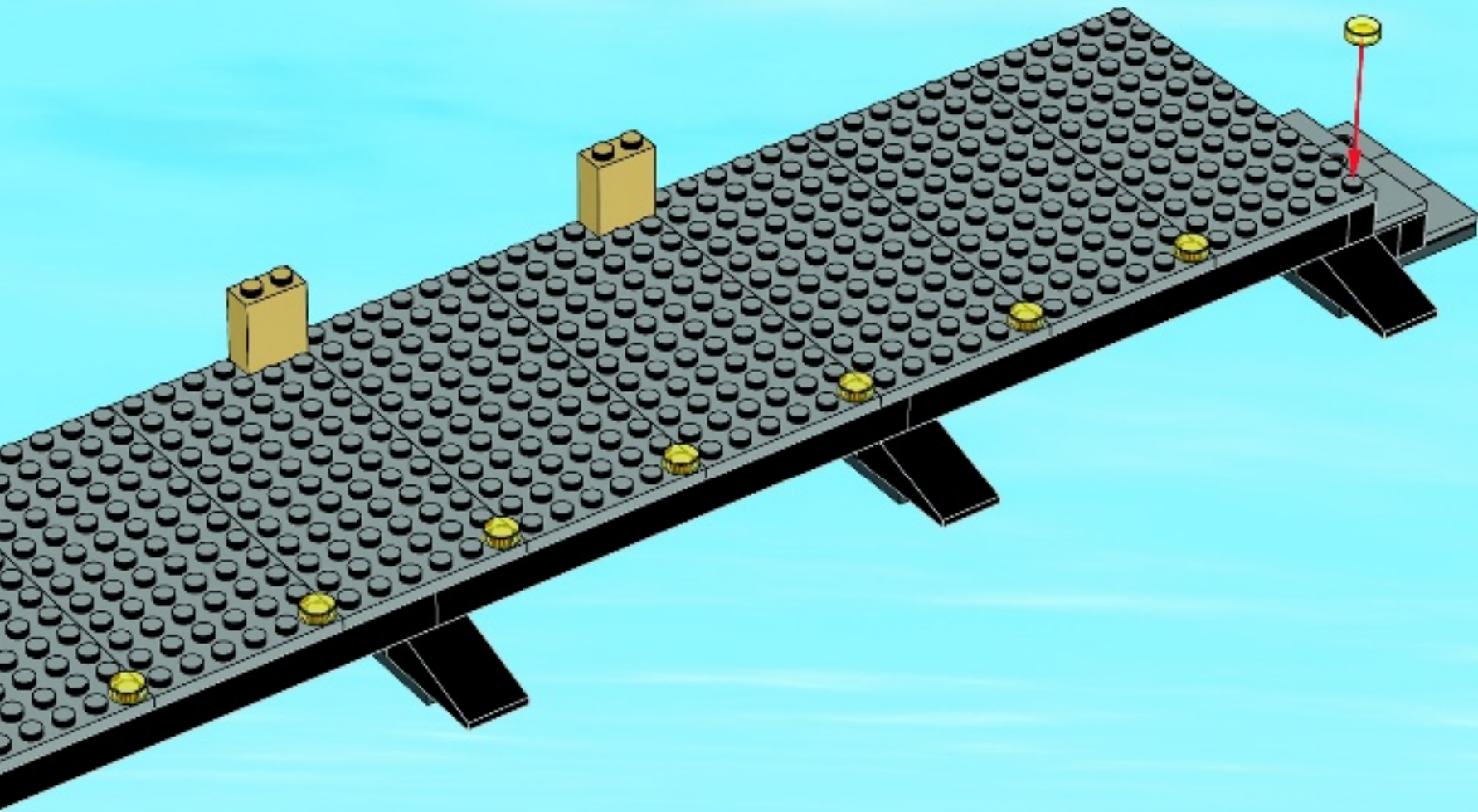

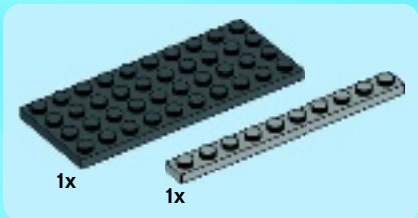
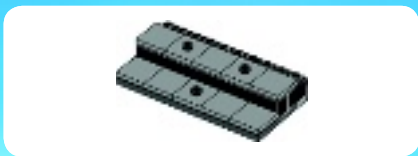

1

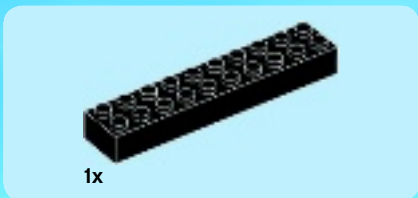
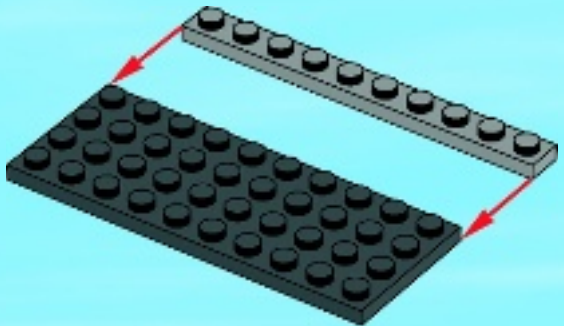

2

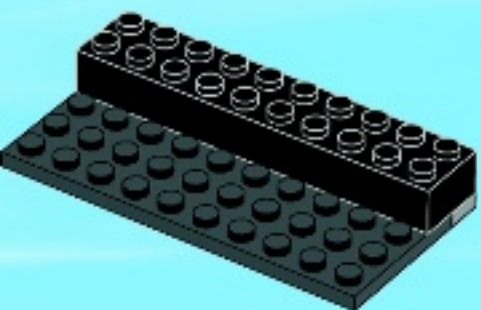

3

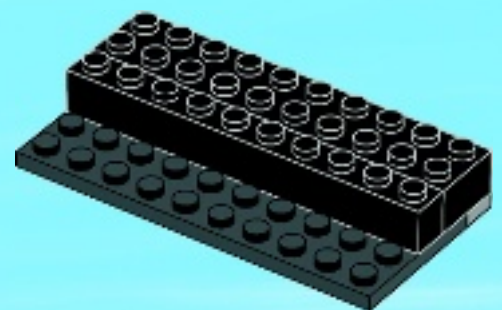



4x



1x

4

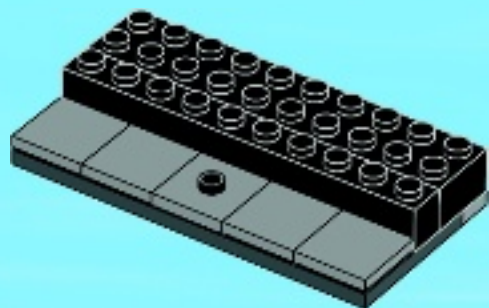

3x



2x

5

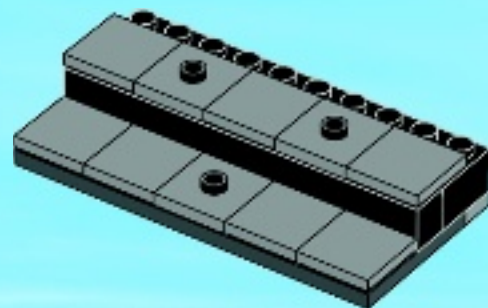

22

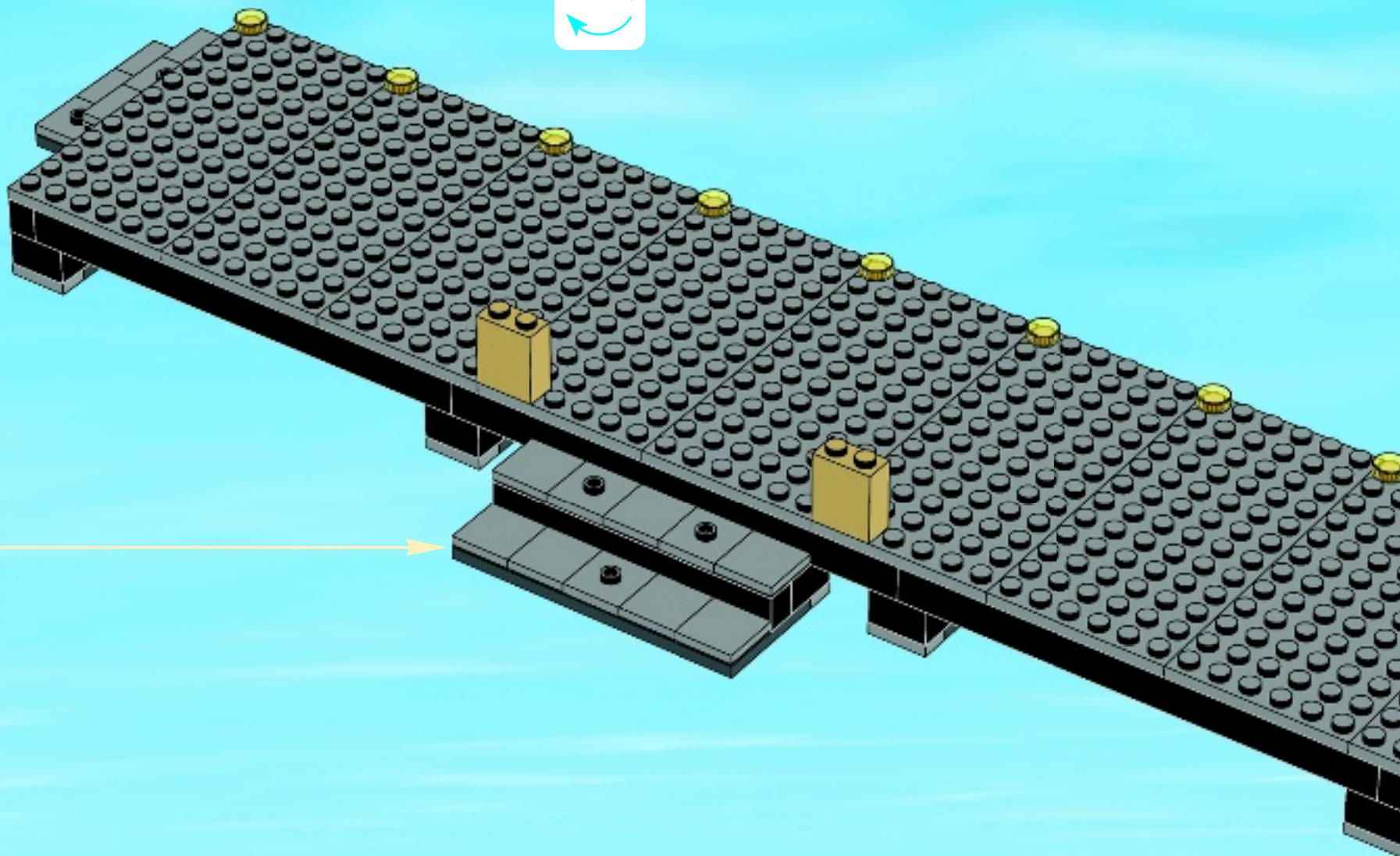

3

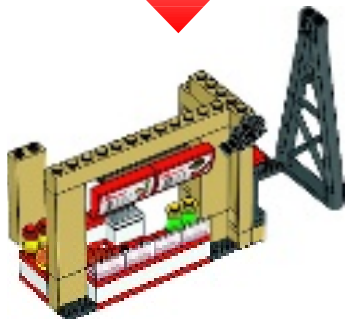

1x

23

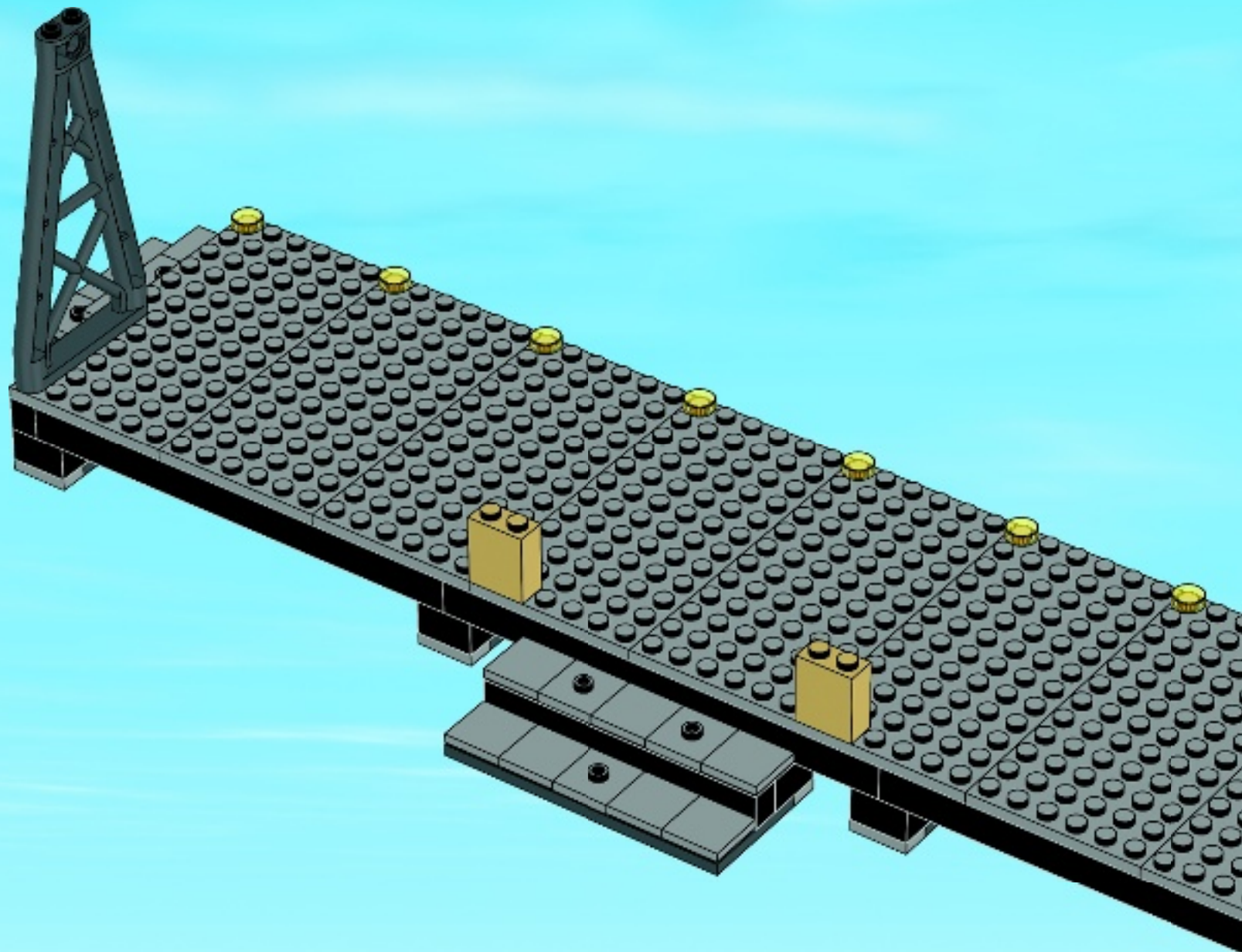



2x

24

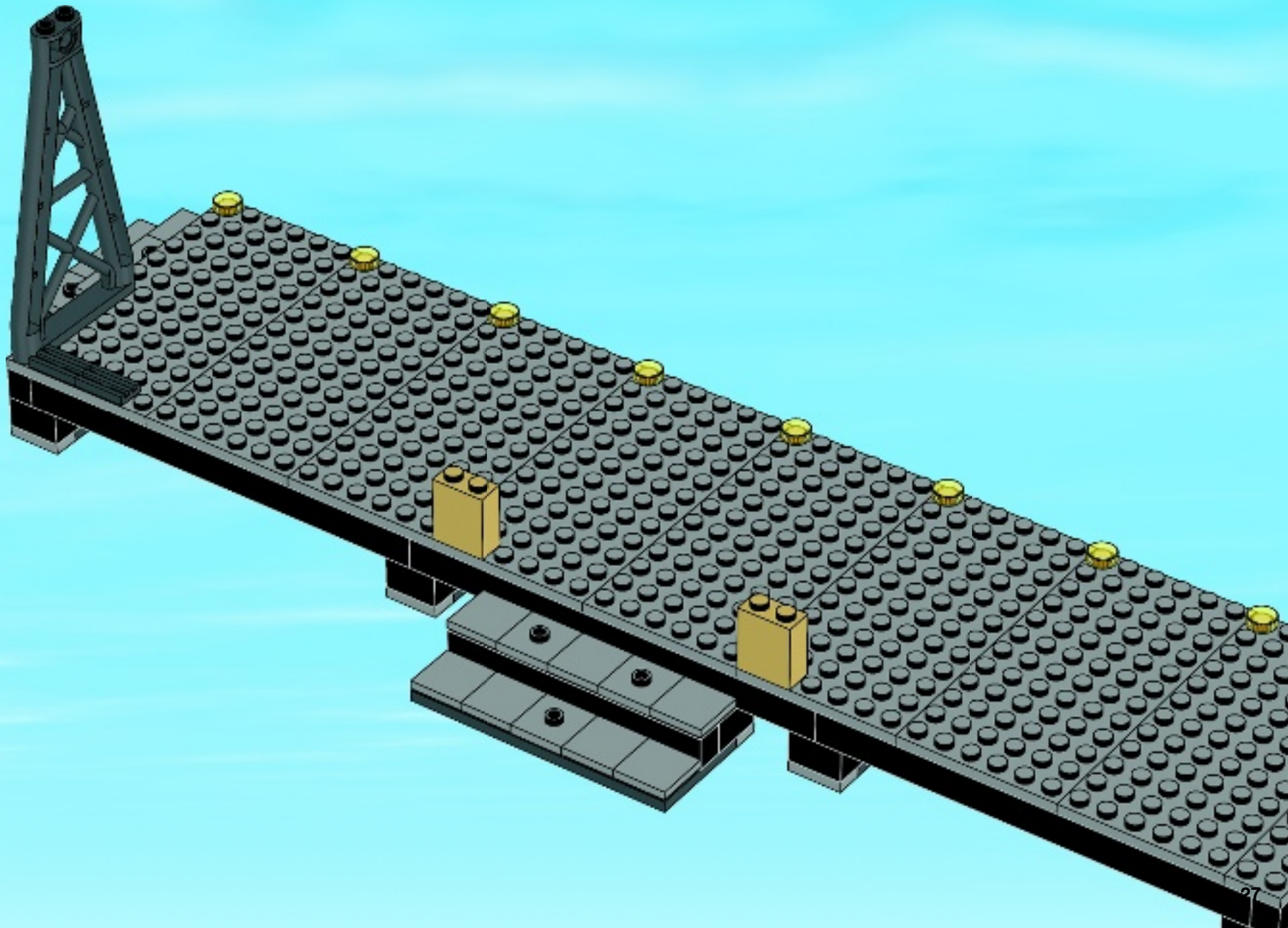



1

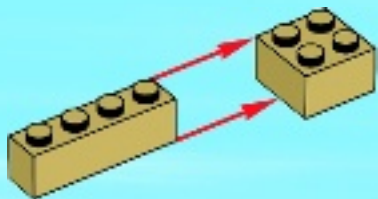

2

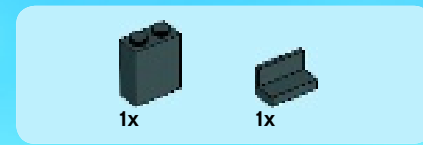
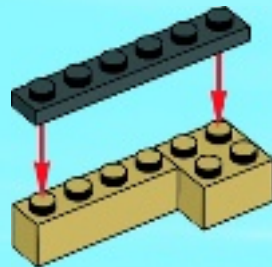

3

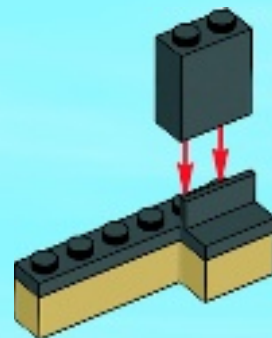

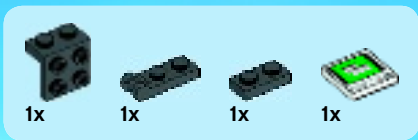

4

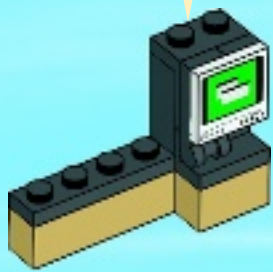
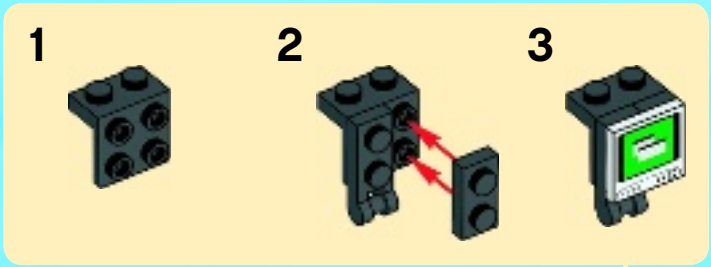

5

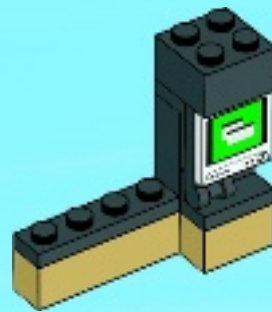

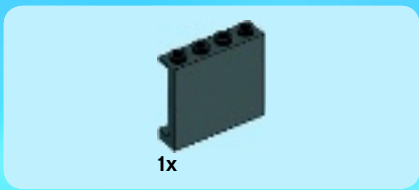

6

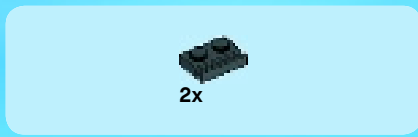
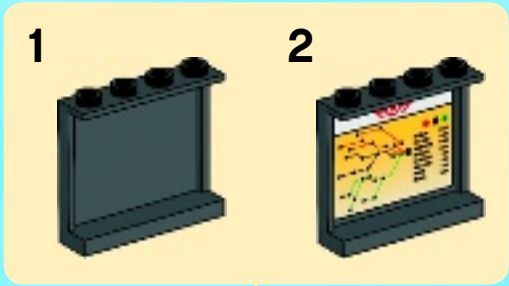

7

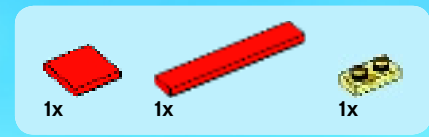

8

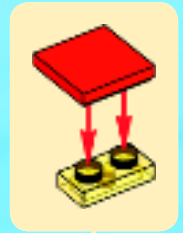

25

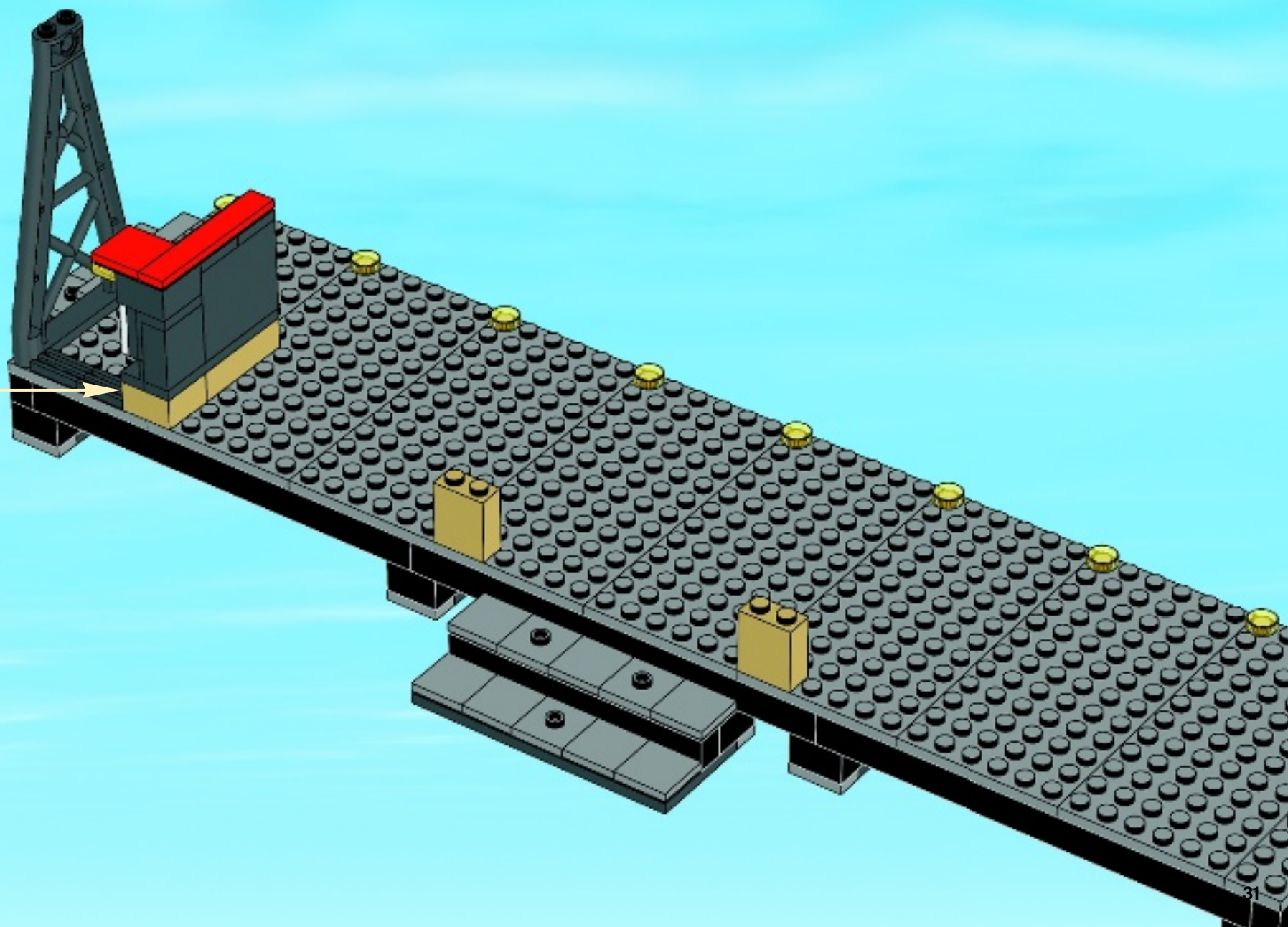

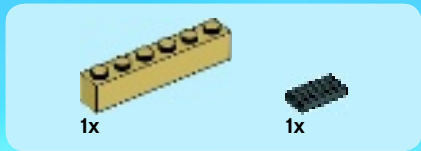

26

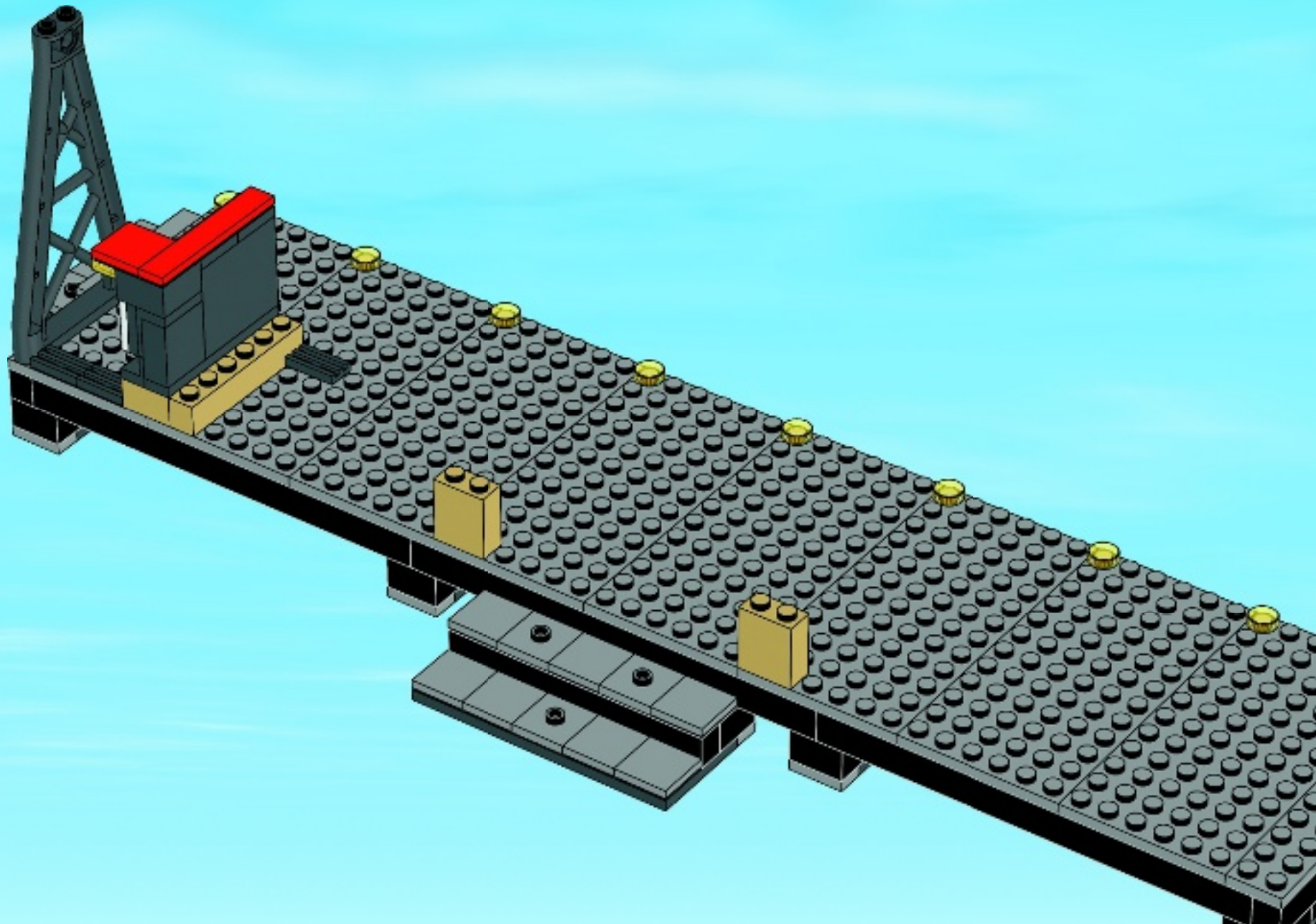

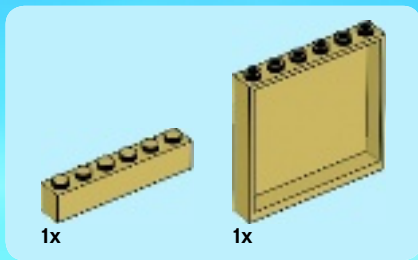

27

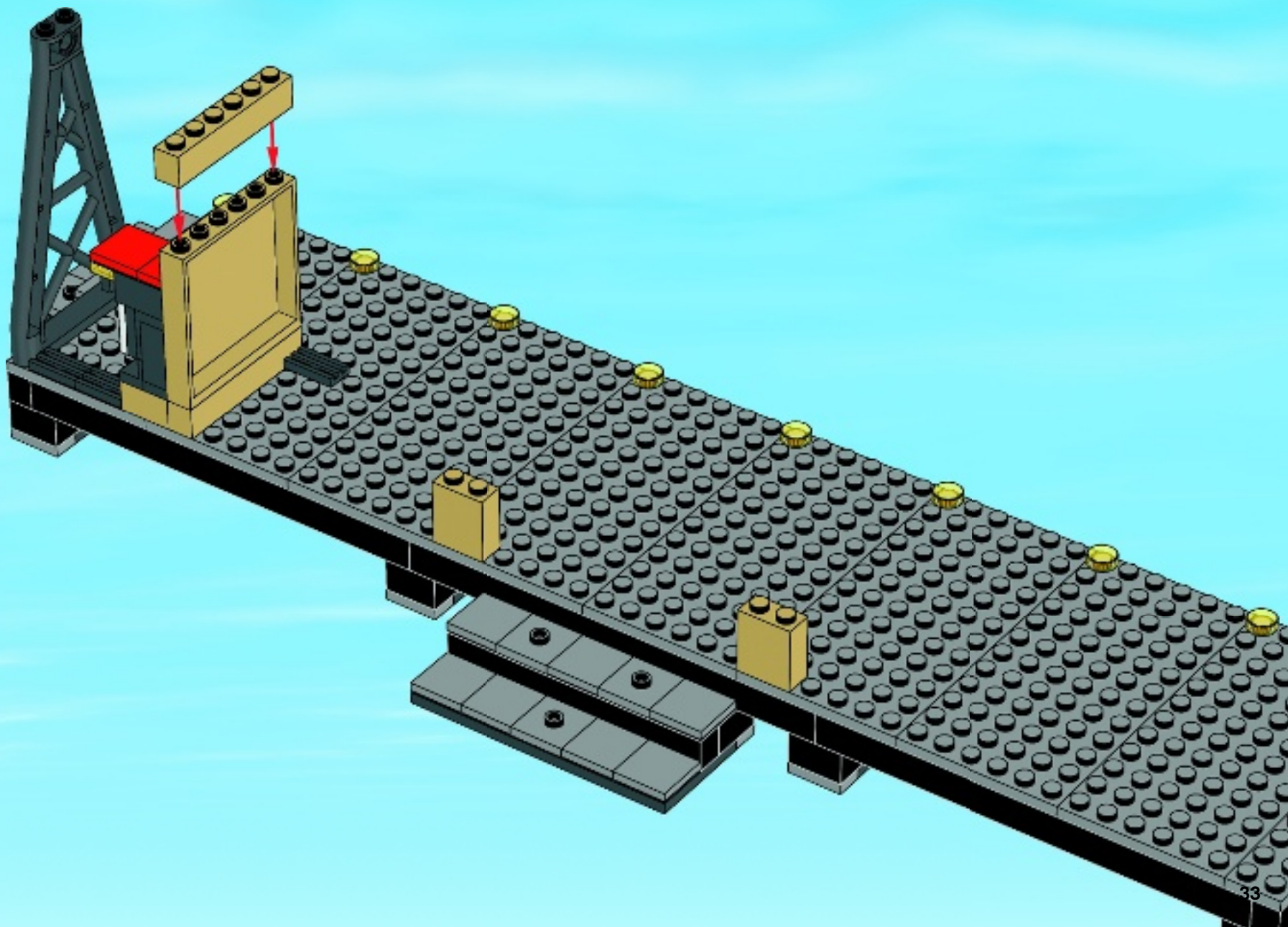

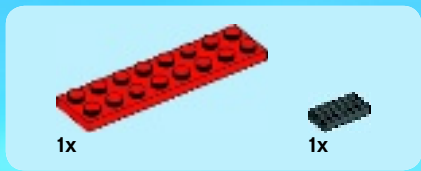

28

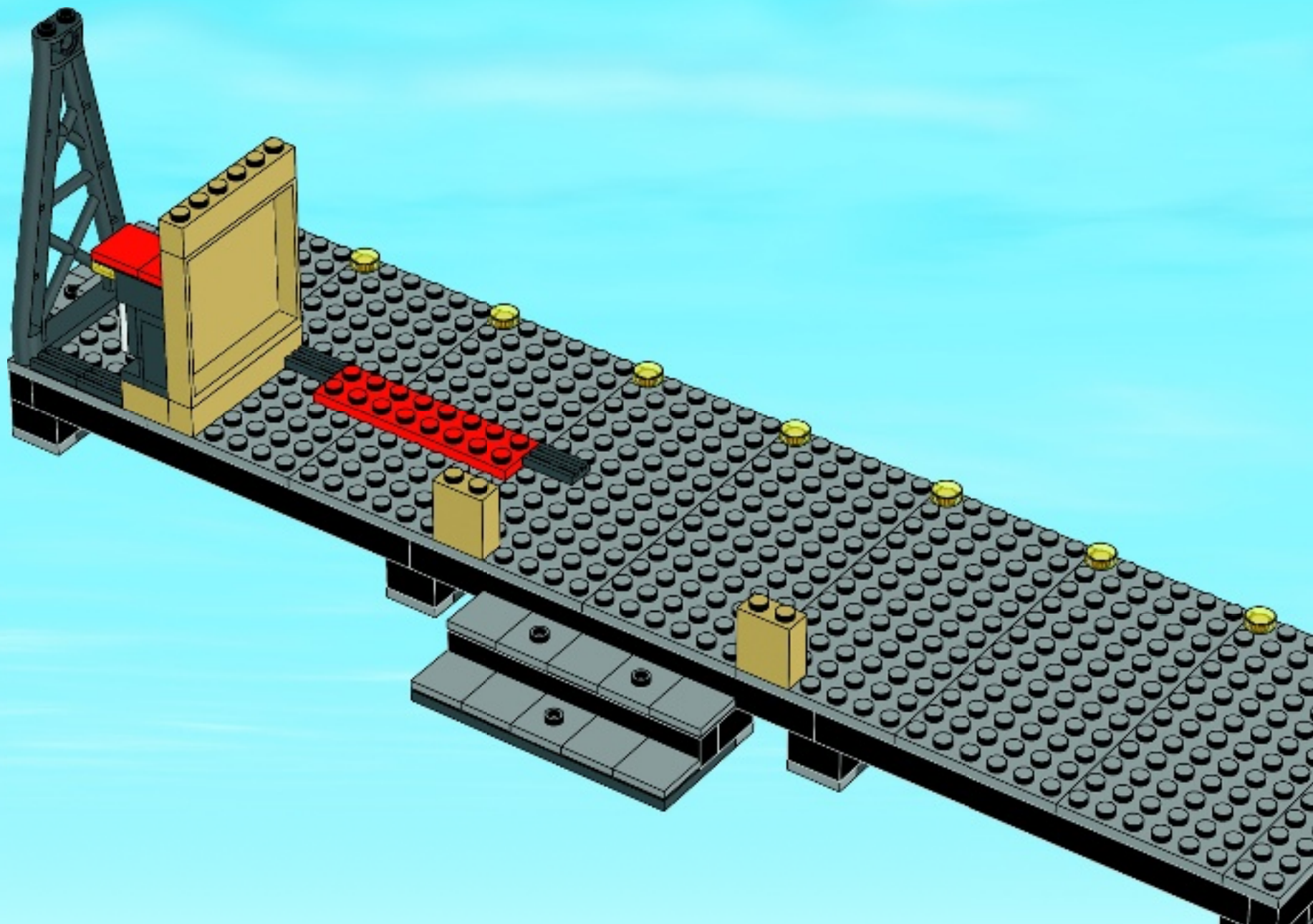



2x

29

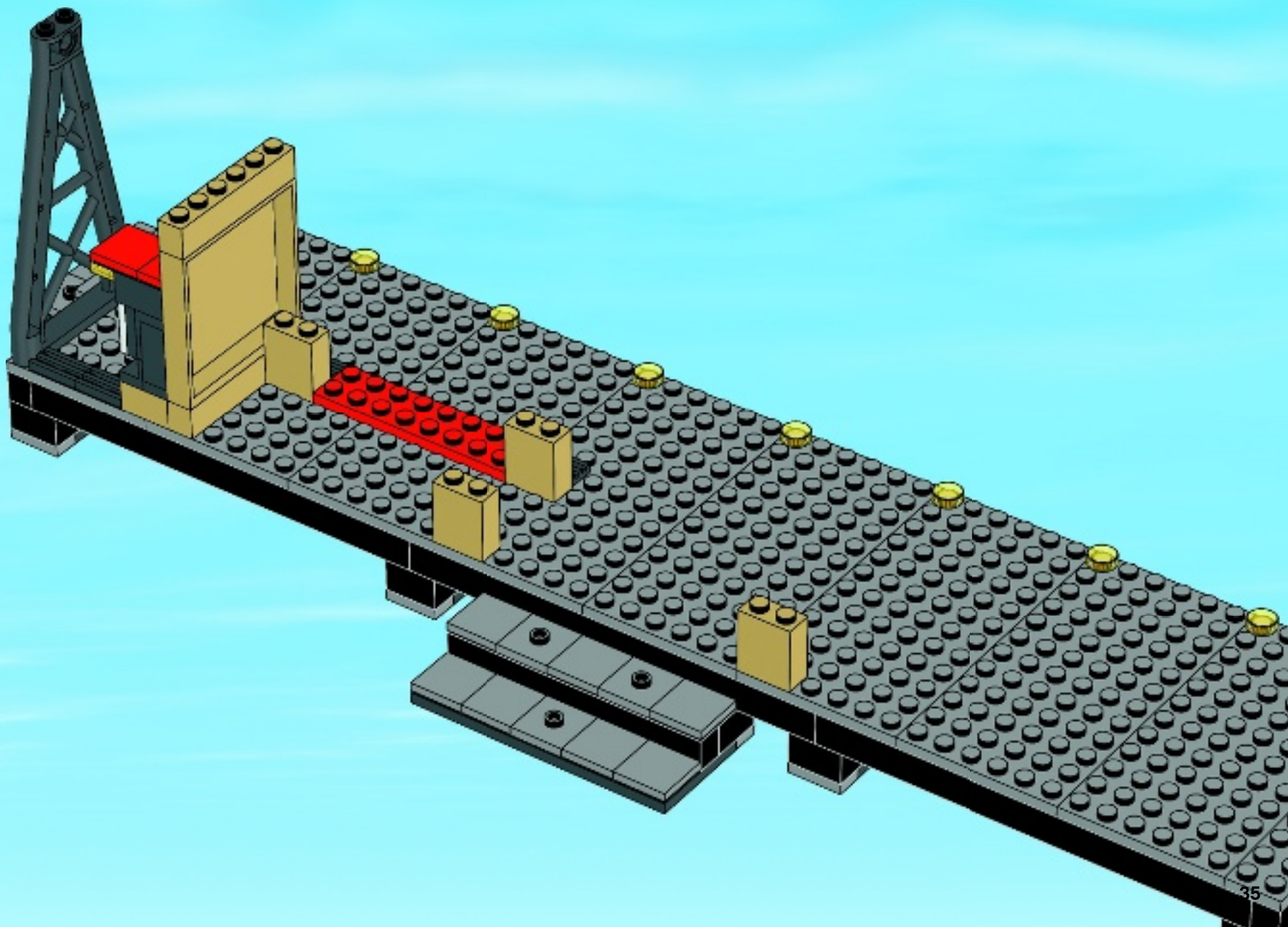

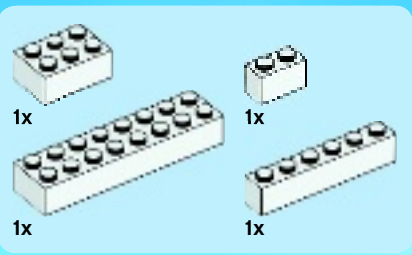

31

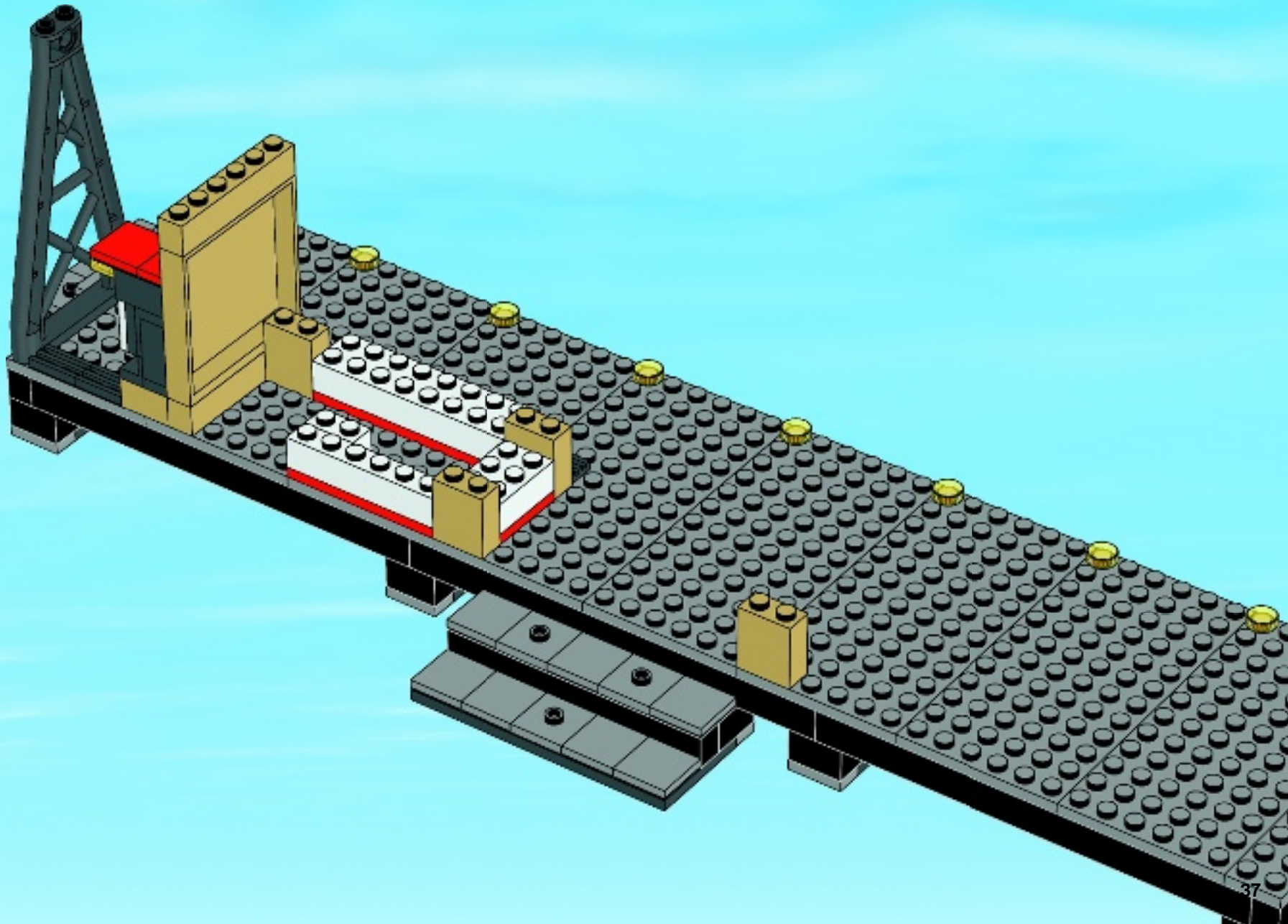

2x



3x



32

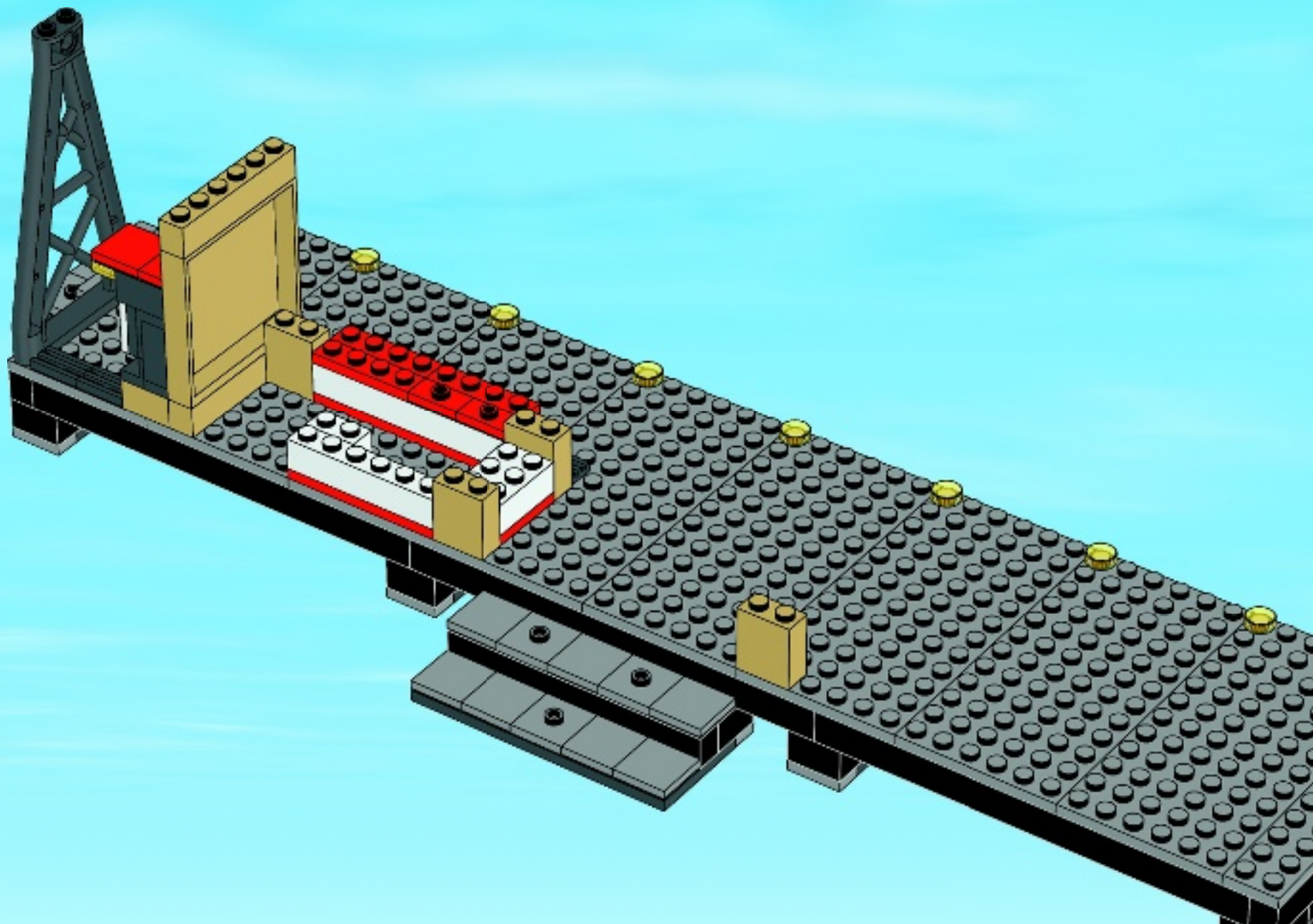



1x



1x



1x

33

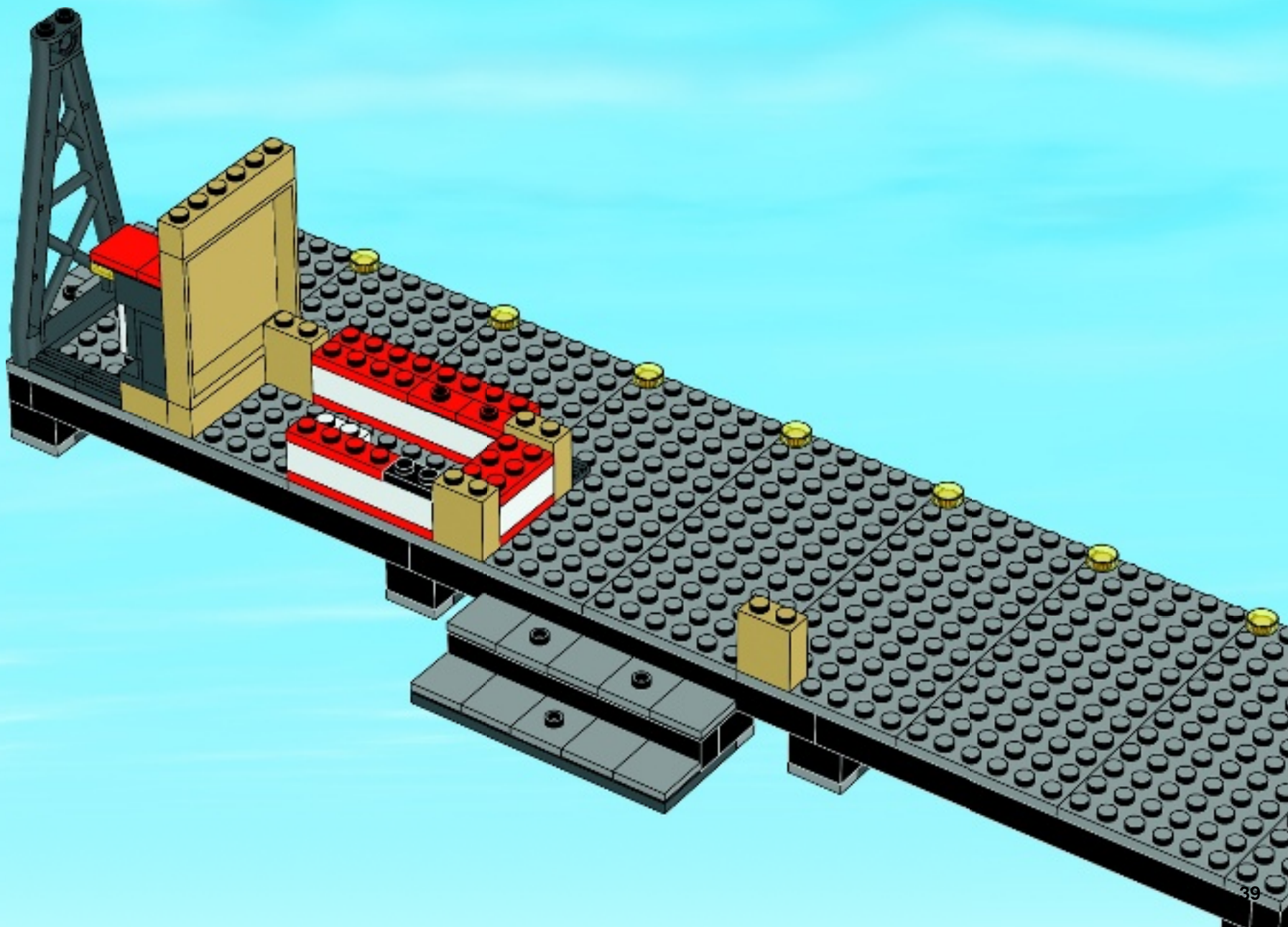



4x

34

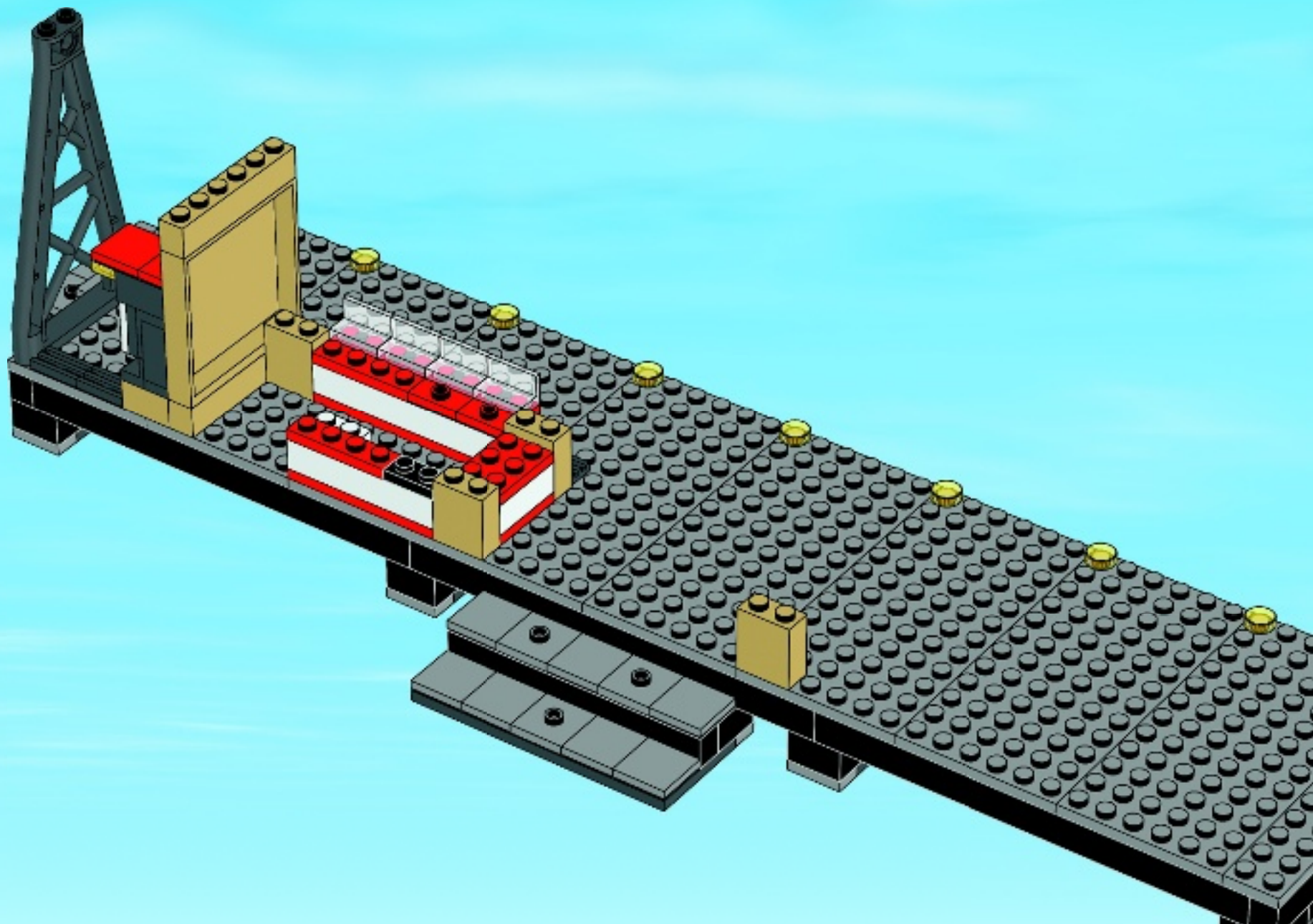

1x  1x  1x  1x 

35

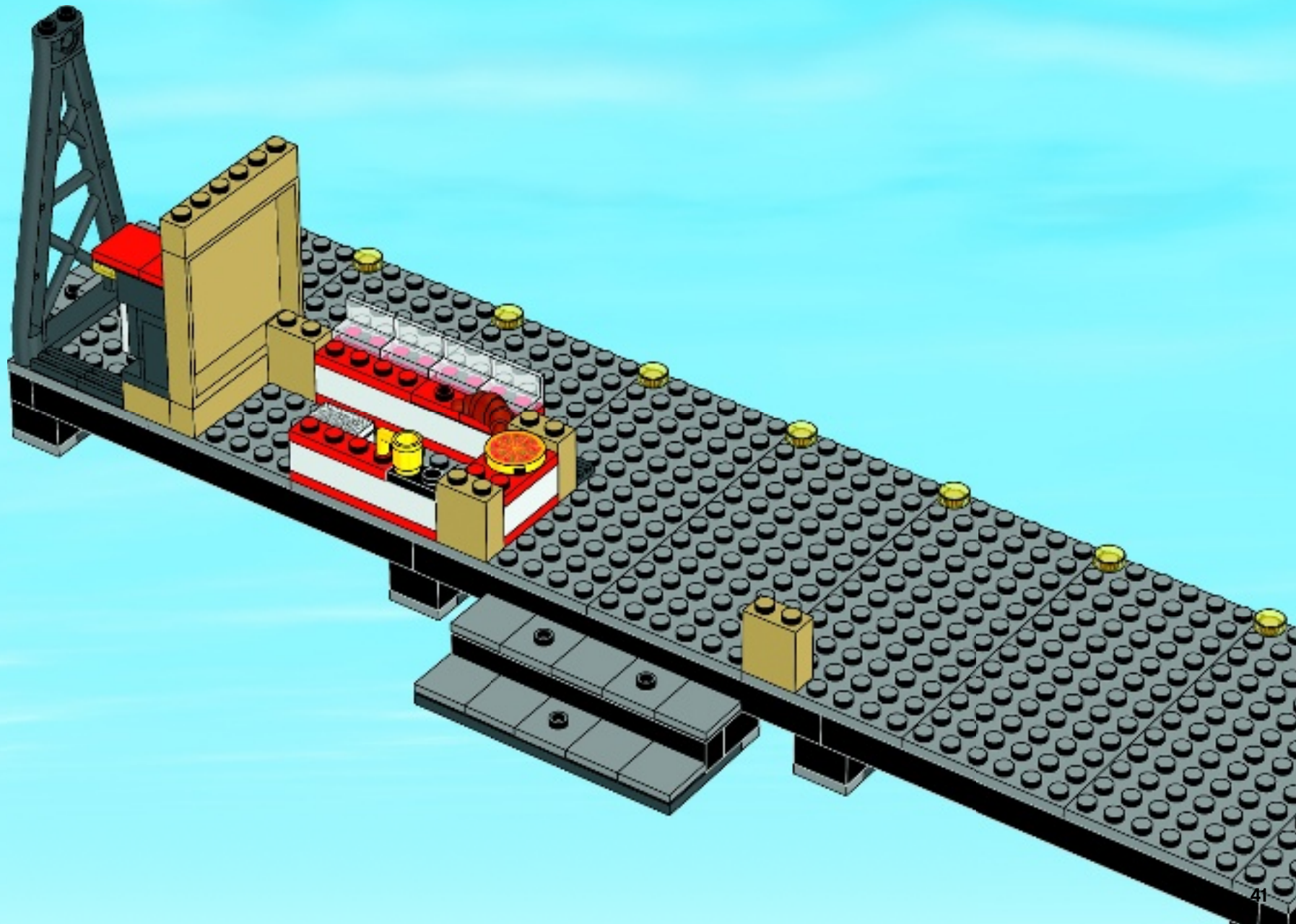



1x



1x



2x

36

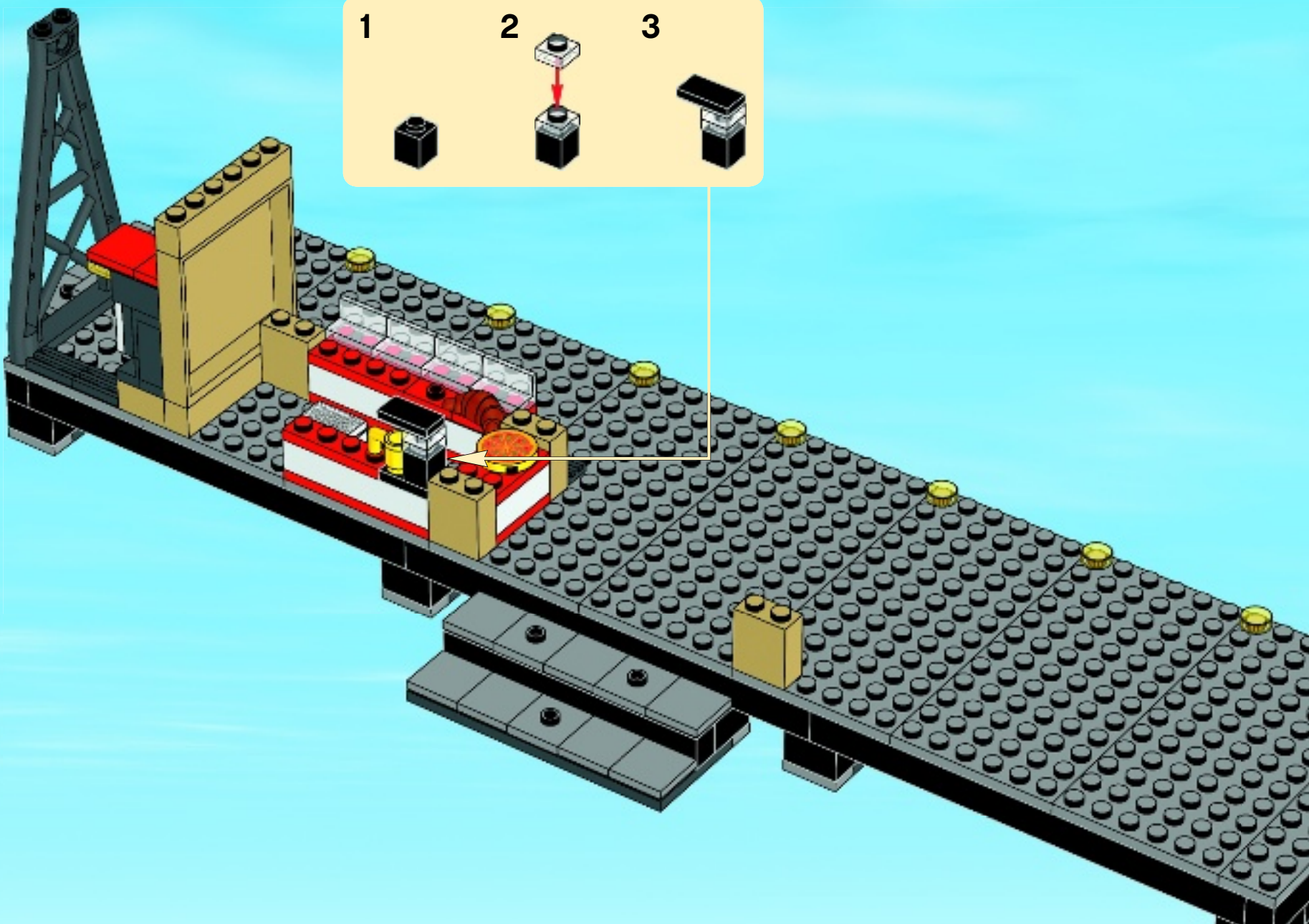

1

2

3

- 2x 
- 2x 
- 2x 
- 2x 

37

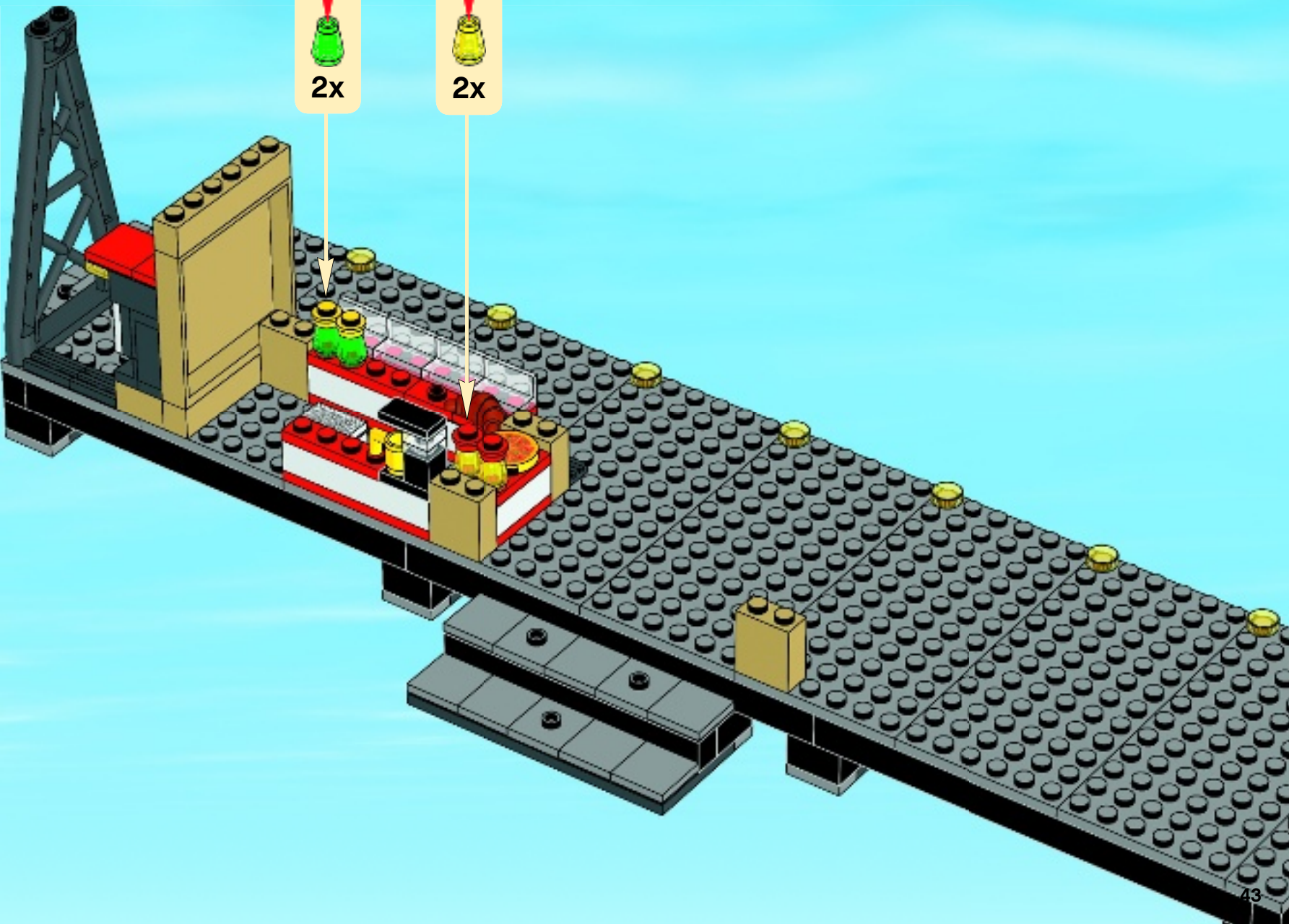



1x



1x

38





3x

39

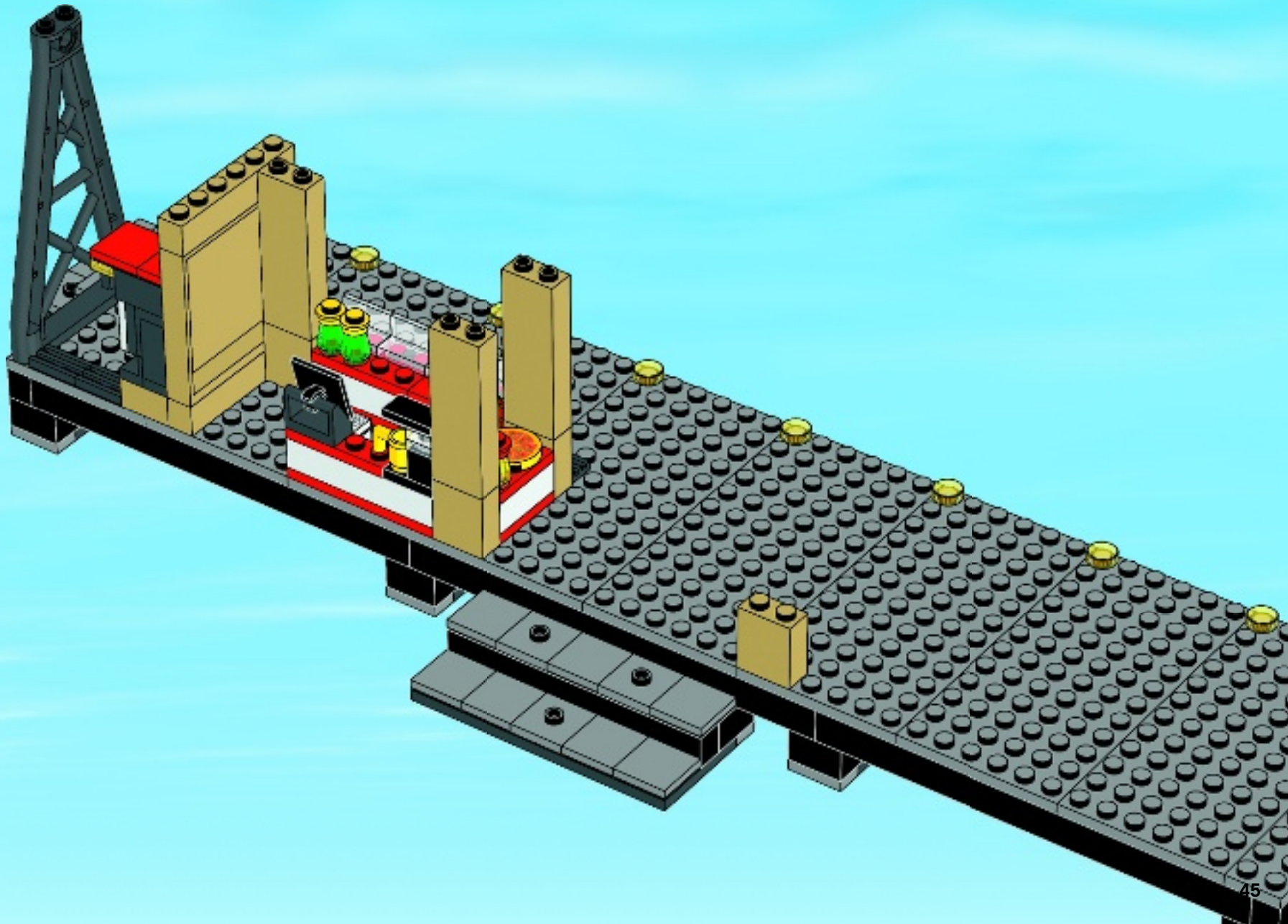

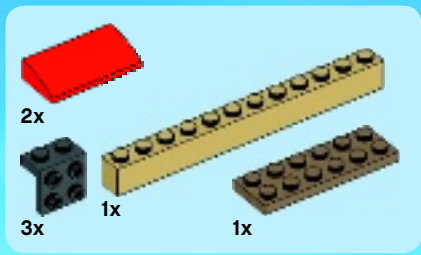

40

1

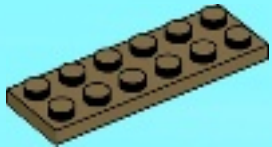

2

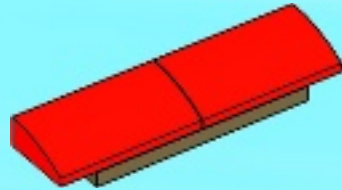

3

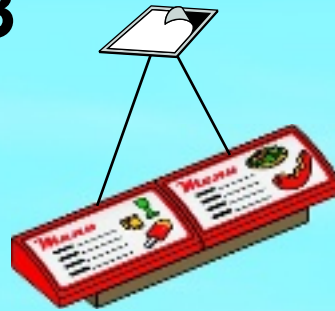

4

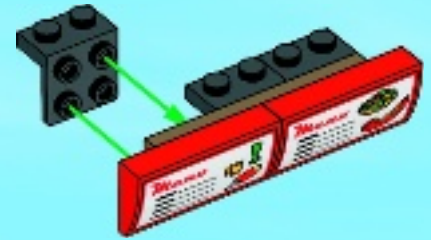

5

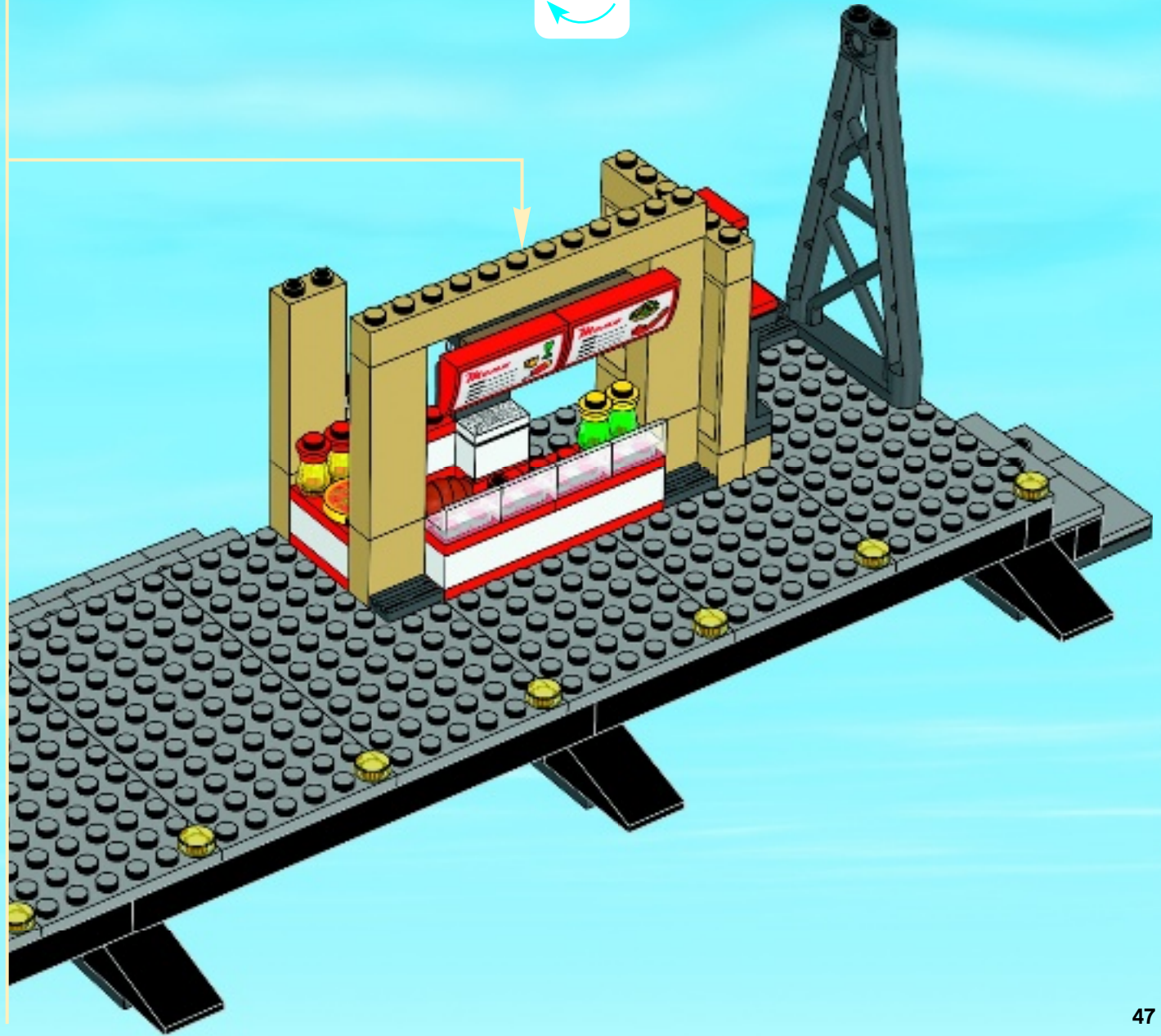



41

