



# CITY

60045





1x

1





2x

2

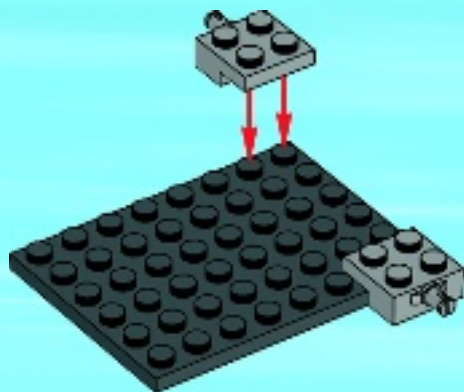

2x



2x

3

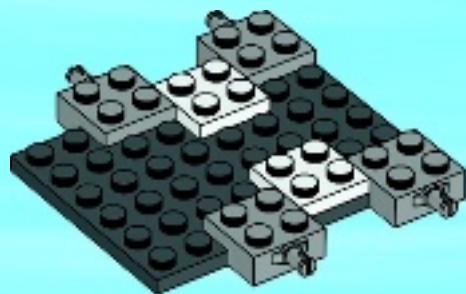



1x



1x

4

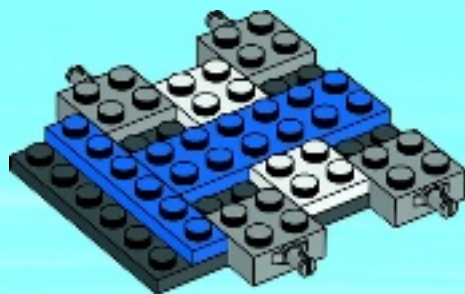



1x

5

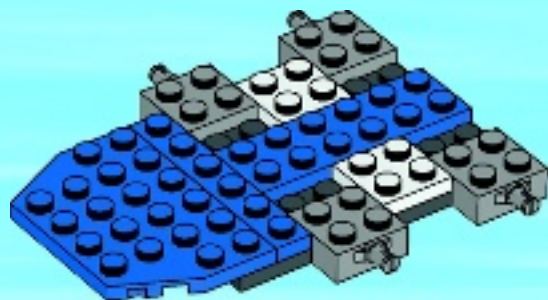

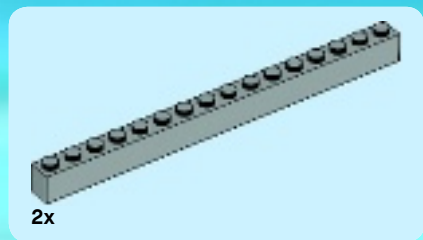

6

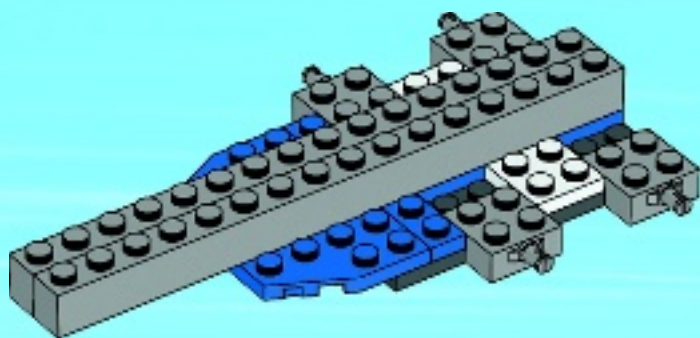



2x

7

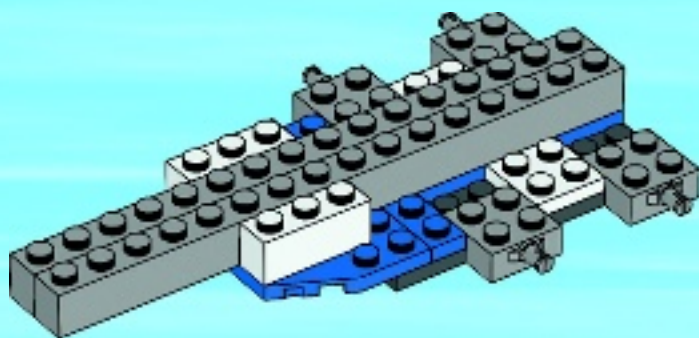



2x

8

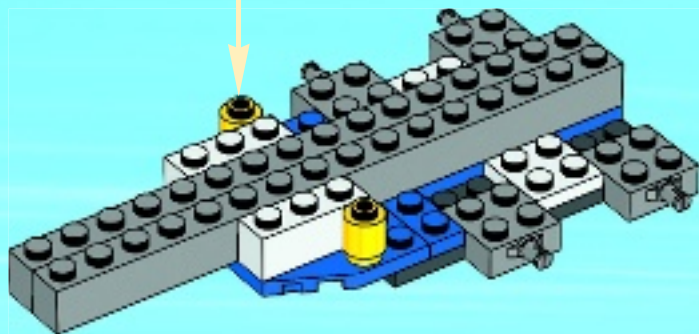

8





1x

1

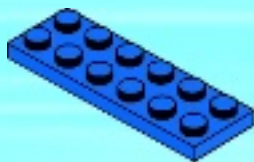

1x

2





2x

3



2x

4





2x

5

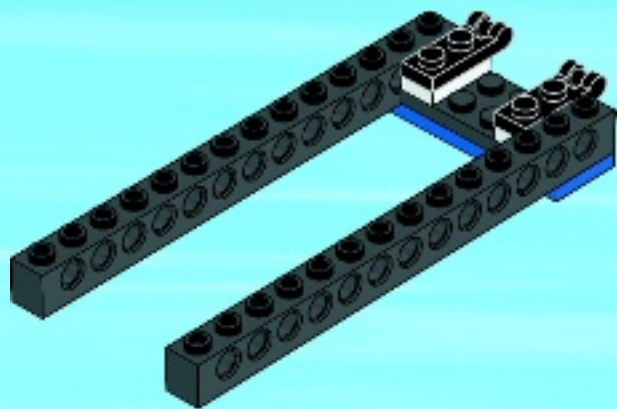

2x

6

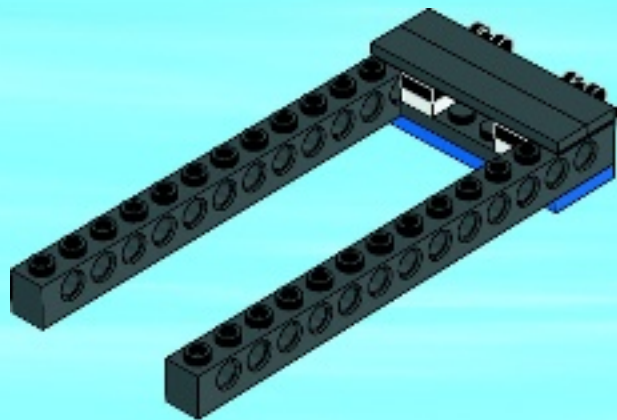

9

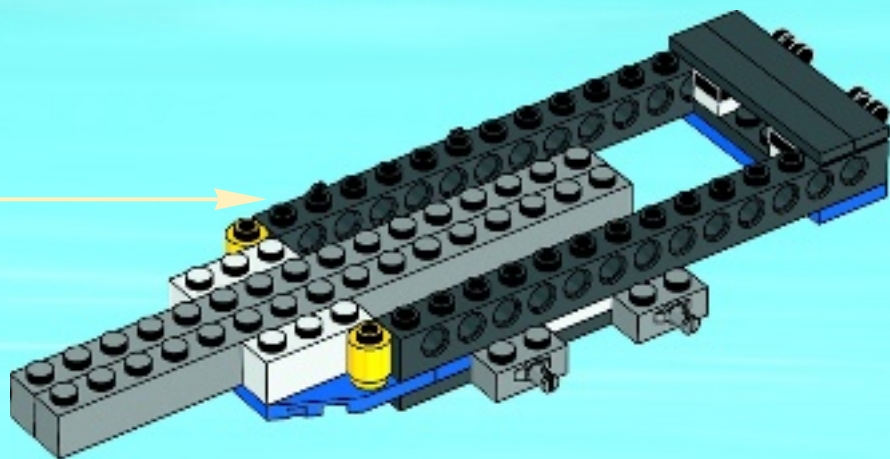



4x

10

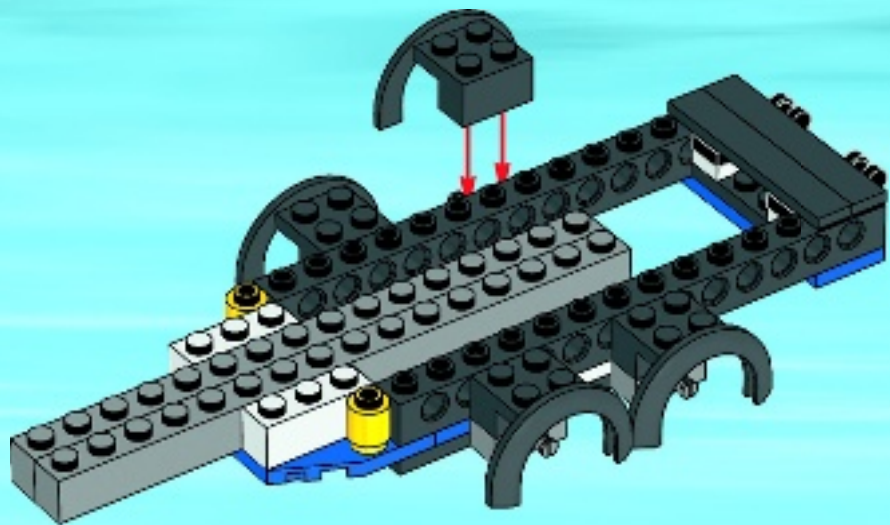



2x



2x

# 11

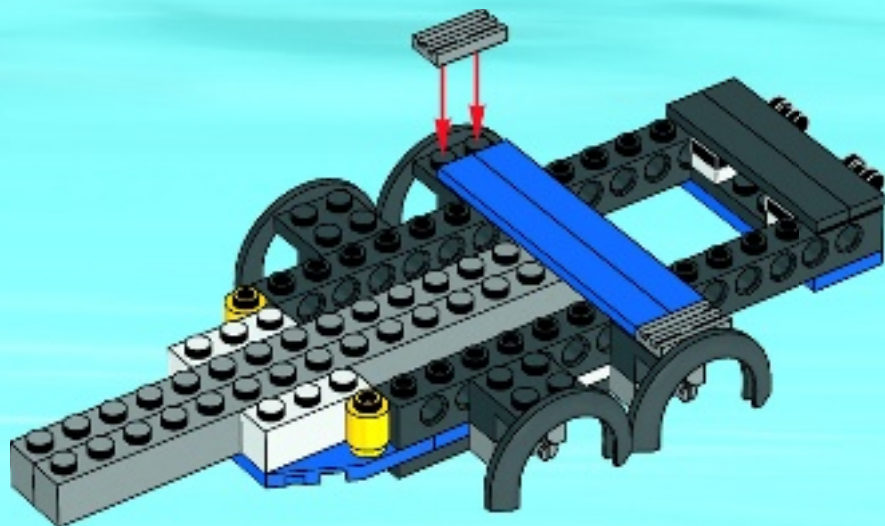



2x

# 12





2x



2x

# 13

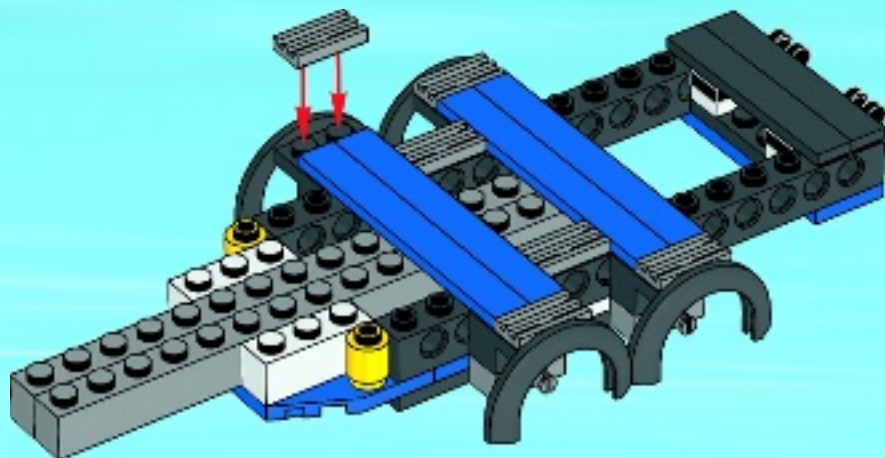





1x

14

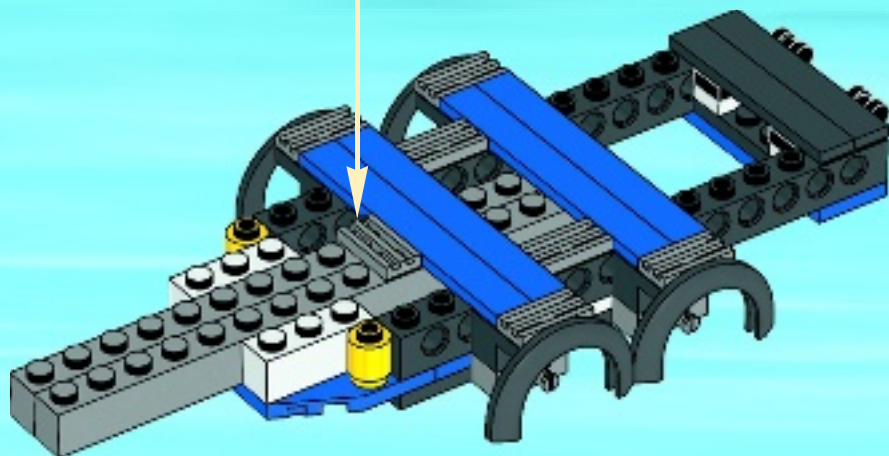

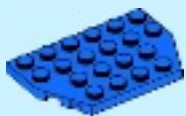

1x

15

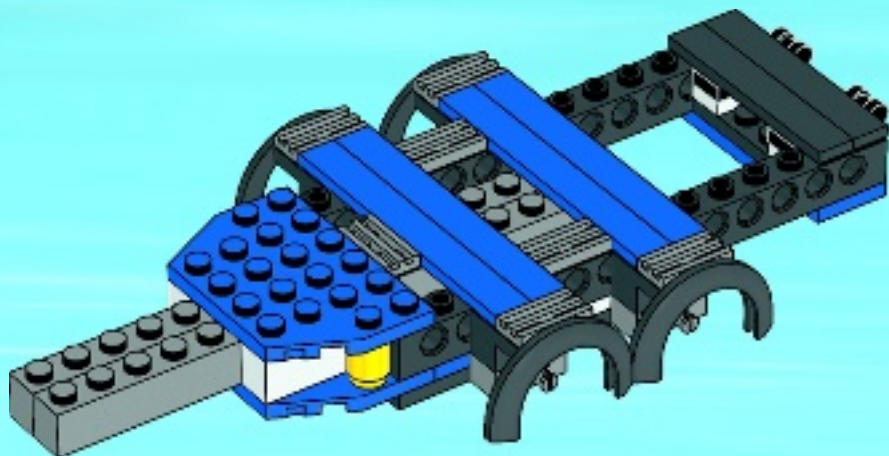



1x



1x

# 16

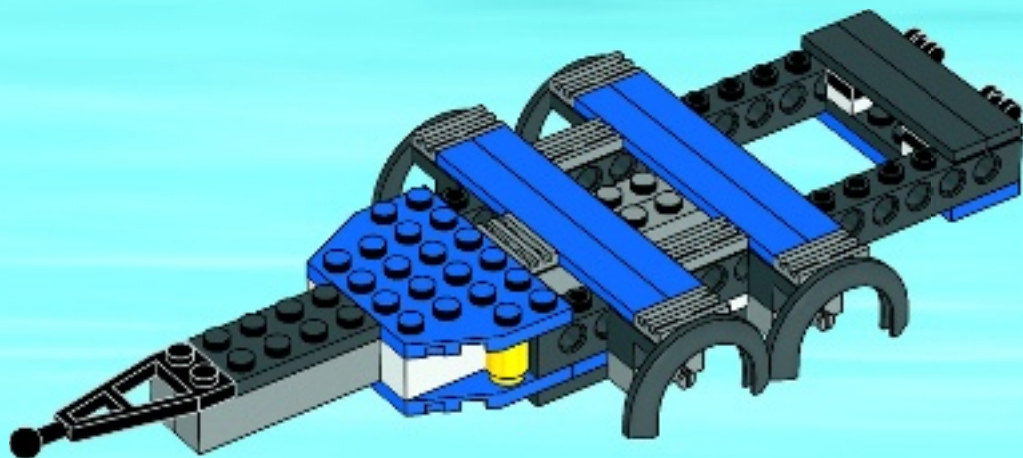



1x

17

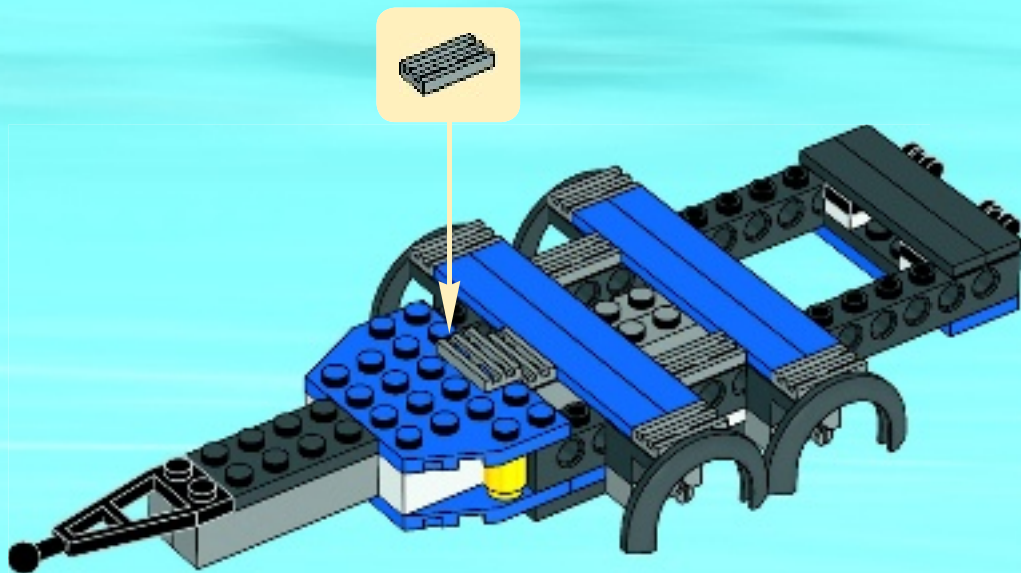



1x

1

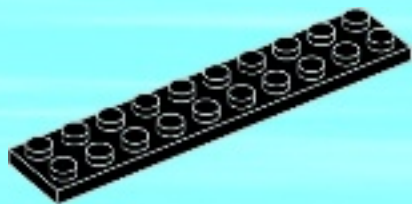

1x



1x

2

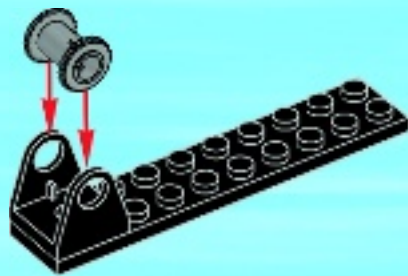



2x



1x

3

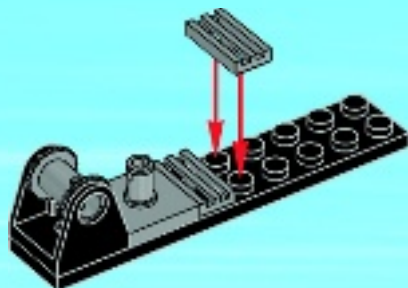



1x



1x

4

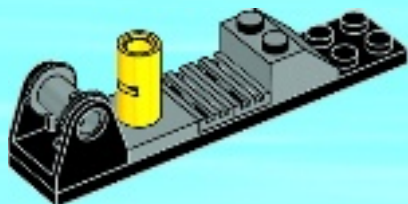

1x



1x



1x

5

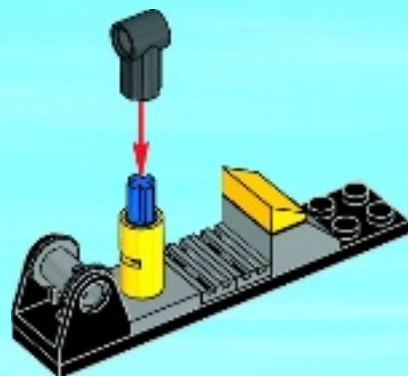



1x

6

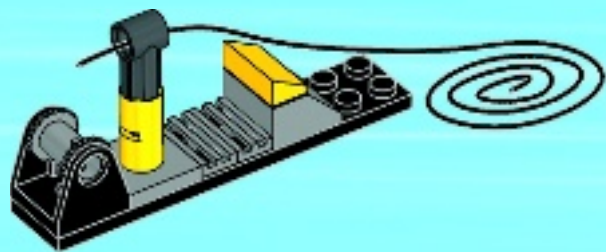

7

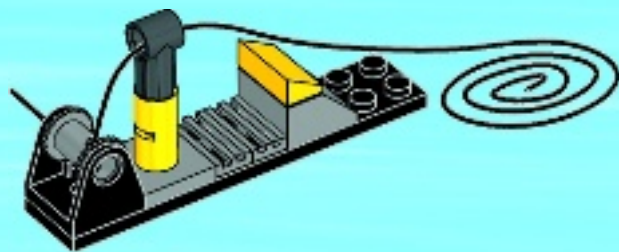



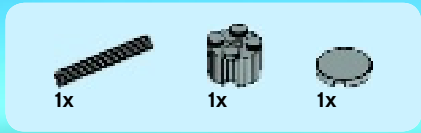

8

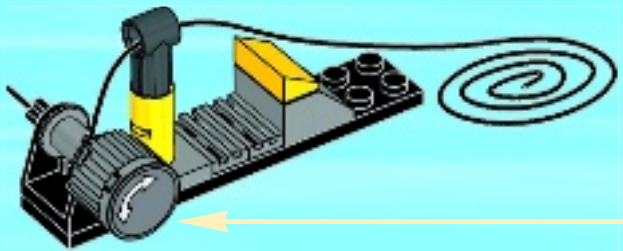
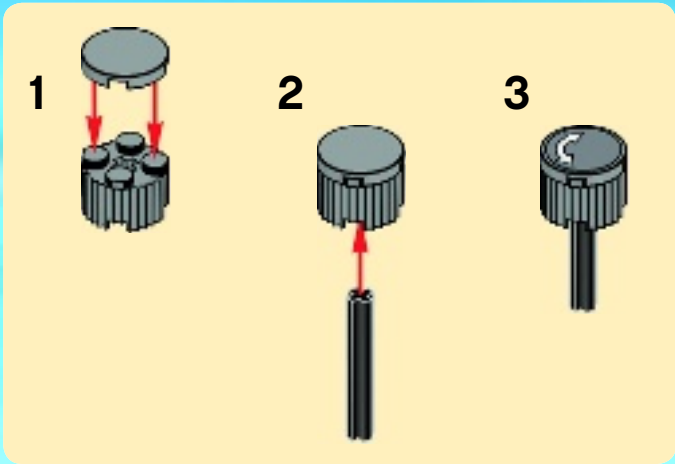

9

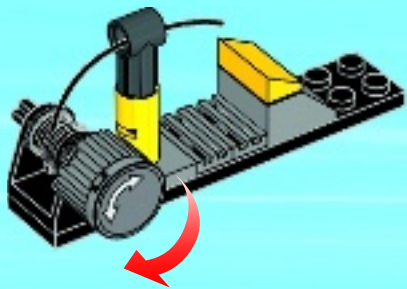

1x

10

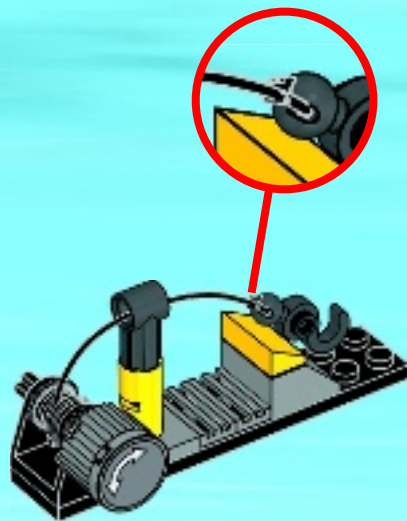

18

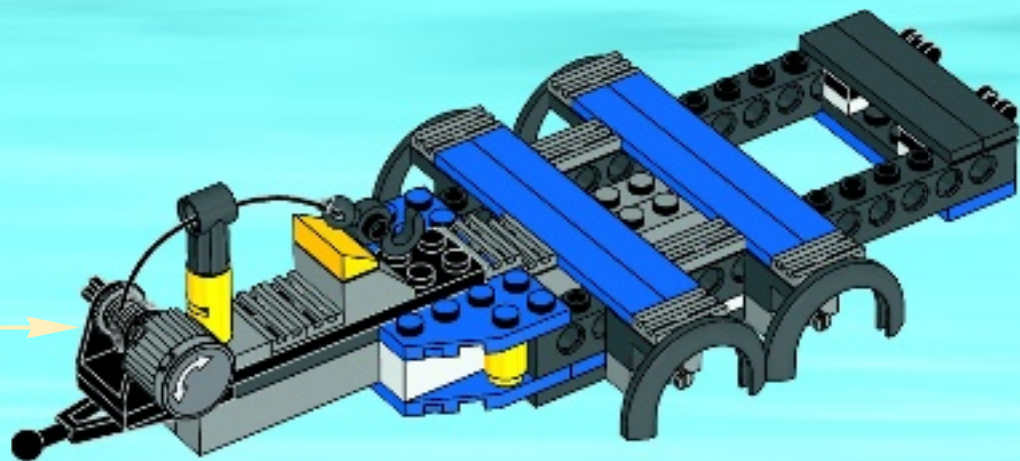



4x



2x



2x



2x

# 19

## 1



## 2

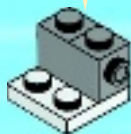
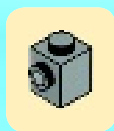

## 3

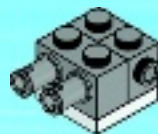



4

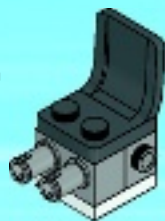

2x

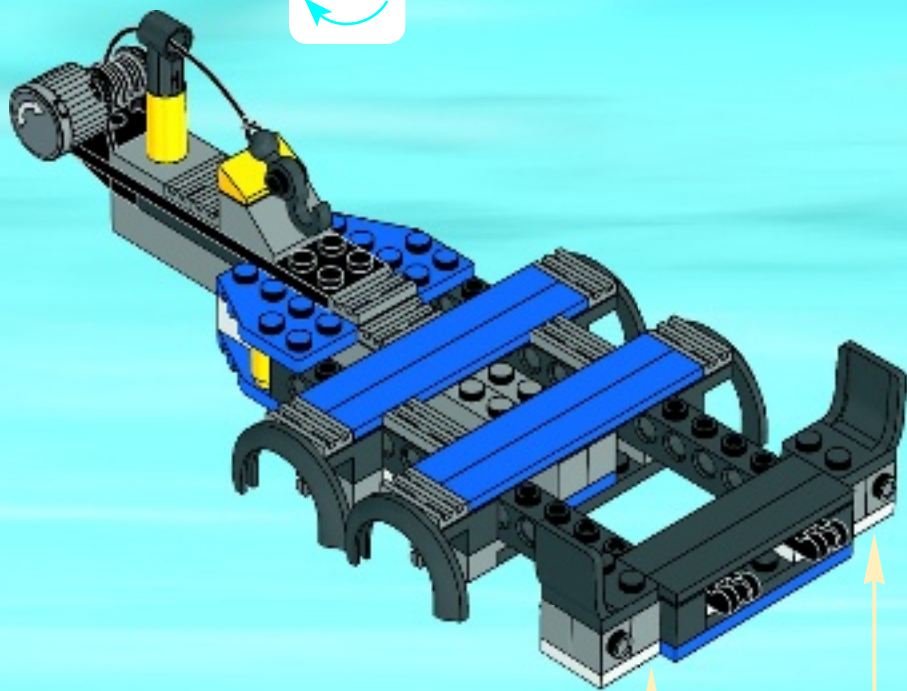



2x

20

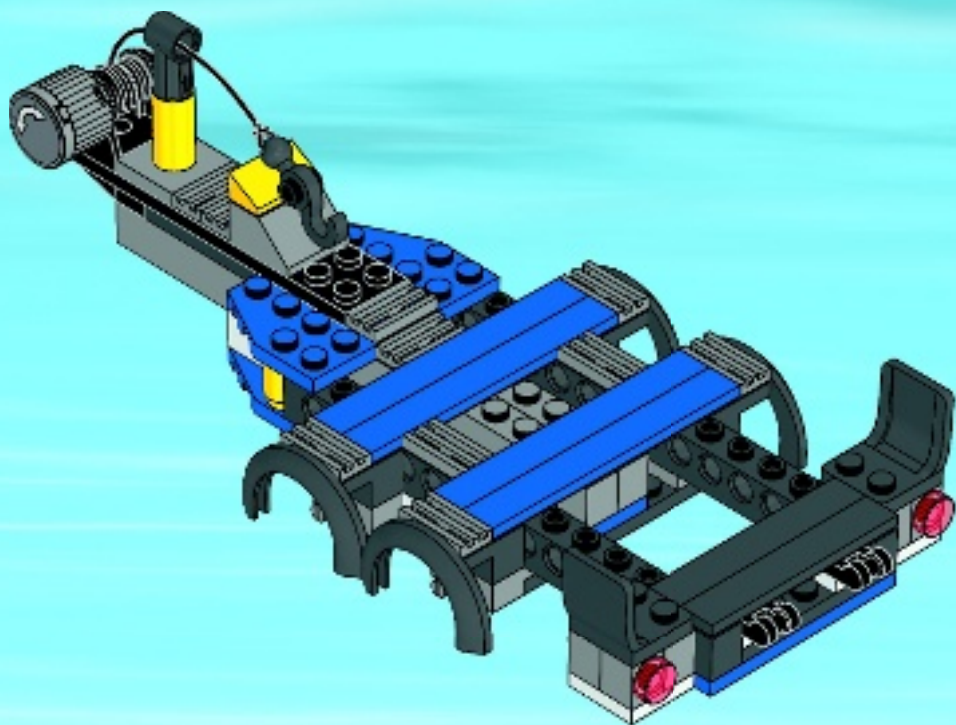

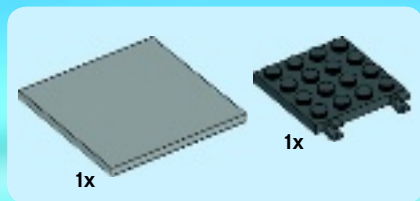

# 21

1

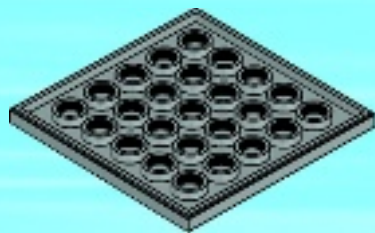

2

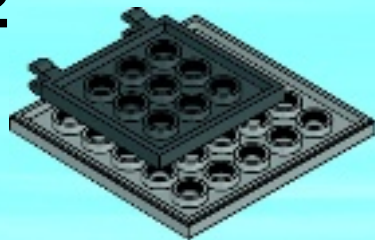



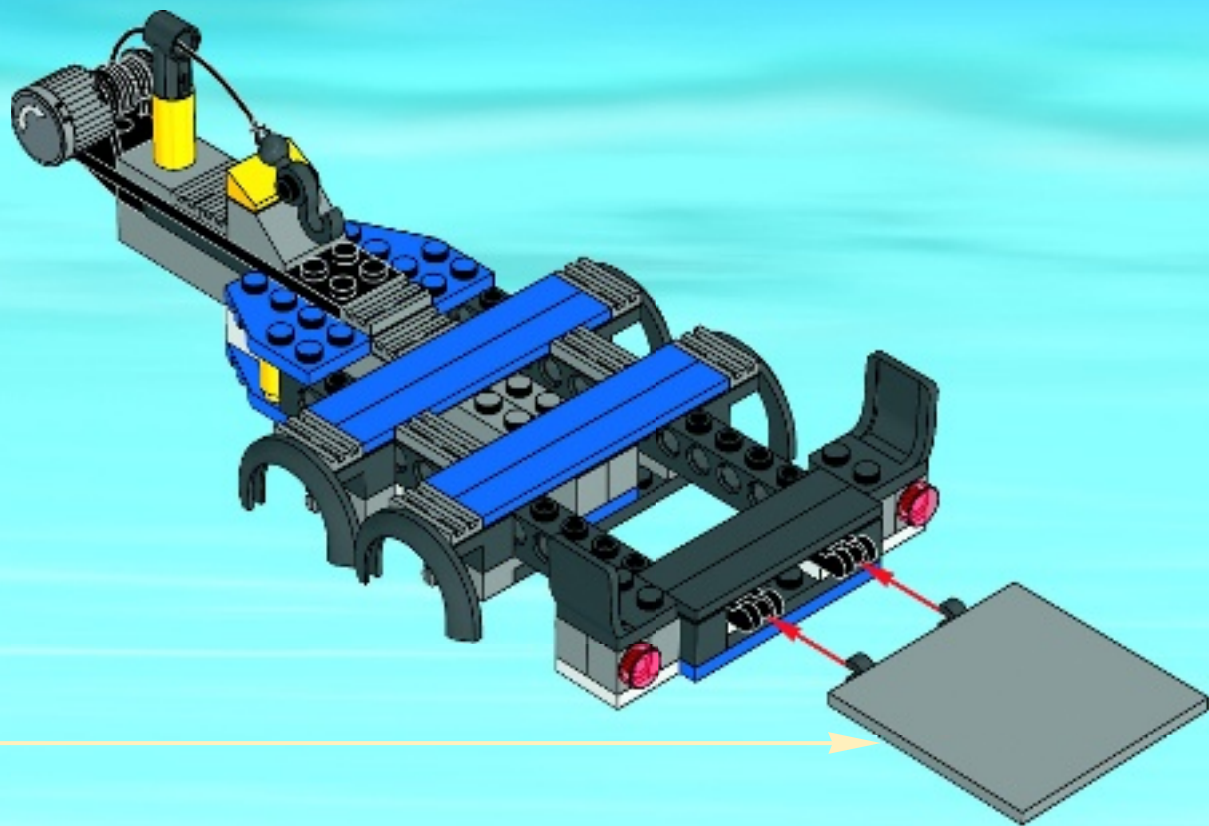





4x



4x

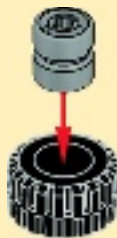

4x

# 22

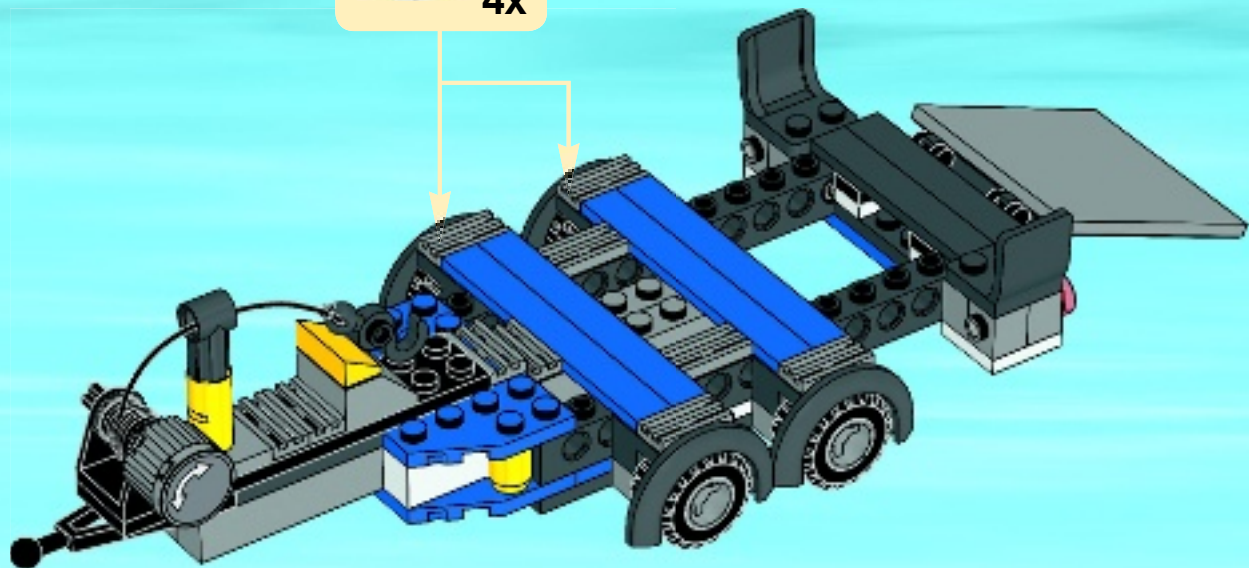

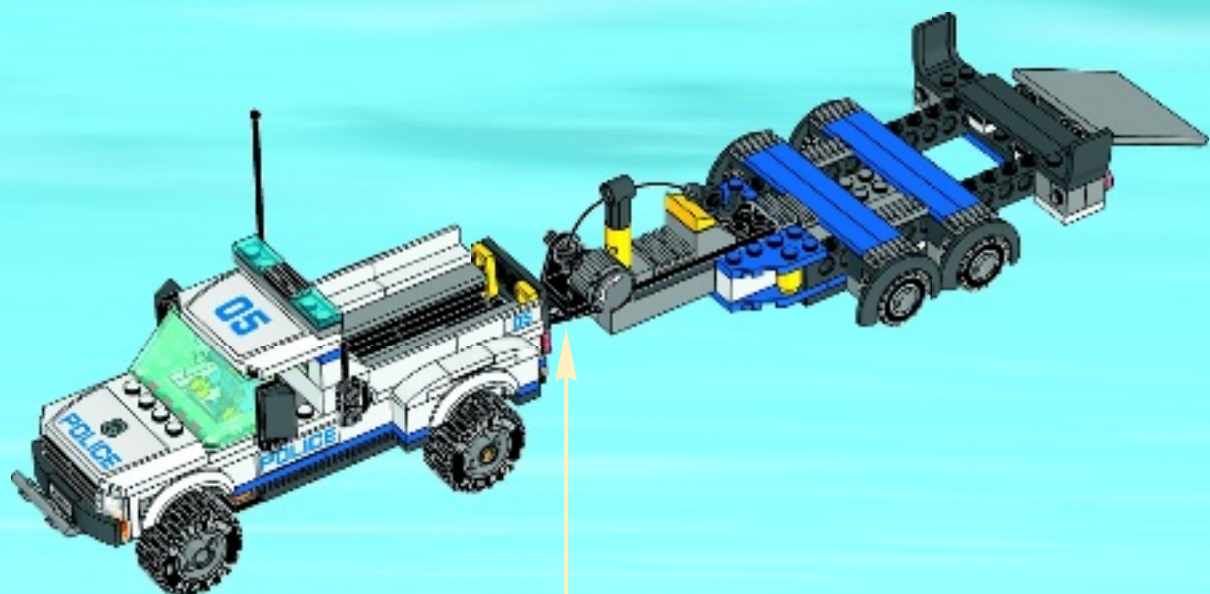





2x  
362201



3x  
300901



2x  
407001



2x  
4533763



1x  
4143254



2x  
306201



2x  
4121932



6x  
366001



7x  
302301



4x  
302201



5x  
4613256



2x  
4515364



1x  
403201



1x  
4179580



4x  
6061047



1x  
4261470

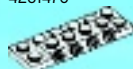

1x  
4560929



4x  
4646576



2x  
4261565



1x  
371001



6x  
302001



1x  
303401



2x  
4514842

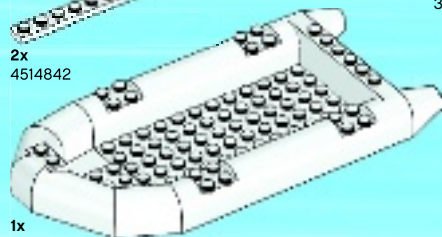

1x  
6061573



1x  
4261941



4x  
6034044



2x  
306901



2x  
4666579



2x  
4514554



2x  
4143005



1x  
4206482



4x  
302423



2x  
4504380



4x  
4620297



2x  
4121936



5x  
302323



2x  
6055887



1x  
4212411

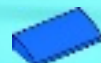

1x  
4651237



2x  
6016165



1x  
303223



4x  
447723

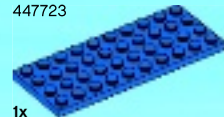

1x  
303023



1x  
243123



1x  
4118785



2x  
366623



2x  
379523





4x  
416223































































2x  
6052392

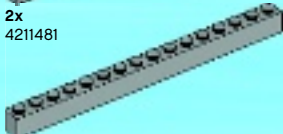

1x  
4159007

 2x 306221	 1x 300224	 2x 4540040	 2x 300326	 1x 4157108		 4x 4568644
 2x 302121	 2x 306224	 2x 243224	 1x 6022160	 4x 4278359	 4x 265326	 4x 4619323
 5x 371021	 1x 4550348	 2x 4535740	 4x 370026	 3x 241226	 1x 6056326	 2x 6021752
 2x 4556153	 1x 302224	 2x 4515367	 2x 366026	 2x 4225201	 1x 6036006	 2x 4285883
 1x 74335	 4x 362324	 2x 407924	 1x 4243819	 2x 6061032	 1x 396226	 1x 368026
 1x 389921	 1x 4560181	 1x 6022354	 3x 256926	 6x 4515368	 1x 434926	 1x 258426
 1x 4599453	 1x 379524	 1x 6021851	 1x 383226			 1x 4297719
 1x 4107066	 2x 9553	 1x 6021844	 1x 345626		 1x 400626	
 1x 4526983	 2x 6015892	 2x 4648281			 1x 412175	 1x 370526

 1x 4295260	 4x 4113854	 4x 4558953	 4x 4299119	 1x 4211429	 1x 4610112	 1x 6009014
 2x 4244362	 1x 4119483	 1x 6028324	 4x 6018081	 1x 4667166	 1x 4211628	 4x 4211568
 1x 4278412	 1x 3006844	 1x 4650645	 1x 4211370	 3x 4211438	 1x 4538098	 1x 4211365
 2x 4189801	 1x 3005744	 2x 4211660	 1x 4540203	 1x 4641048	 1x 4211520	 2x 4654577
 1x 4244363	 1x 4244573	 2x 4568637	 2x 4541978	 4x 4211764	 1x 6014617	 2x 6028813
 2x 3003941	 2x 4162916	 1x 4211410	 2x 4611702	 1x 6052200	 1x 6014617	 13x 4211350
 2x 4646864	 2x 6056241	 3x 4211517	 2x 4211658	 1x 4278273	 2x 4211481	 1x 6030711
 1x 4113954	 6x 4542673	 1x 4550325	 1x 4550170	 1x 4211512	 2x 4211366	
 1x 4598955	 1x 4211220	 3x 4211385	 1x 4539481	 2x 4211525		
	 2x 4211194					





1x  
4211105



2x  
4567887



2x  
4211135



2x  
4579354



1x  
6019987



6x  
4543086



4x  
4210660



1x  
4210658



2x  
6012451



1x  
4211106



4x  
6029948



5x  
4210631



1x  
4211052



1x  
4211094



1x  
4211053



1x  
4560184



2x  
4211065



2x  
4210651



4x  
4260124



1x  
4509884



1x  
6039699



4x  
4210998



2x  
4210967



1x  
4210794

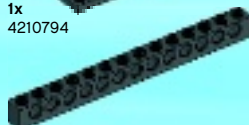

2x  
4211137



2x  
4524930



1x  
4222693



1x  
4261908



1x  
4212529



1x  
6016453



2x  
6066124



1x  
382342



1x  
4599455

**Customer Service**  
Kundenservice  
Service Consommateurs  
Servicio Al Consumidor

[LEGO.com/service](http://LEGO.com/service) or dial



: 00800 5346 5555

: 1-800-422-5346





# WIN!

Go to [LEGO.com/productfeedback](http://LEGO.com/productfeedback) to fill out a survey for a chance to win a cool LEGO® Product.

No purchase necessary.  
Open to all residents where not prohibited.



## LEGO.com/productfeedback

### GEWINNE!

Nimm an der Umfrage auf [LEGO.com/productfeedback](http://LEGO.com/productfeedback) teil und hab die Chance ein cooles LEGO® Produkt zu gewinnen!

Die Teilnahme am Gewinnspiel führt zu keinerlei Kaufverpflichtungen. Teilnahme in allen nicht ausgeschlossenen Ländern möglich.



6079417

### WIN!

Ga naar [LEGO.com/productfeedback](http://LEGO.com/productfeedback), vul een enquêteformulier in en maak kans op een cool LEGO® product.

Geen aankoopverplichting.  
Iedereen mag deelnemen, uitgezonderd ingezetenden van landen waar een enquêteverbod geldt.

### GAGNE!

Visite [LEGO.com/productfeedback](http://LEGO.com/productfeedback) pour répondre à un questionnaire et avoir une chance de gagner un produit LEGO® très cool!

Aucune obligation d'achat.  
Ouvert à tous les résidents des pays autorisés.

### 当てよう!

[LEGO.com/productfeedback](http://LEGO.com/productfeedback) にアクセスして、アンケートにご記入ください。当選者にはレゴ®製品を差し上げます。

お買い上げの必要はありません。  
禁止されていない限り、すべての皆様にご利用いただけます。