

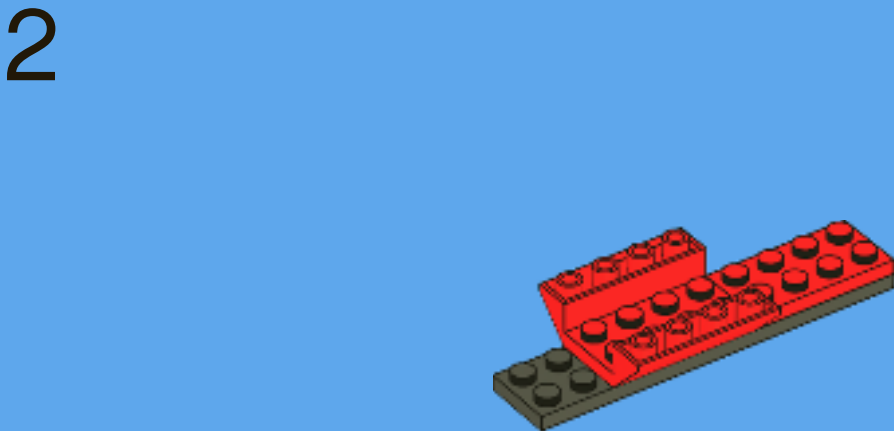

# CREATOR

5892

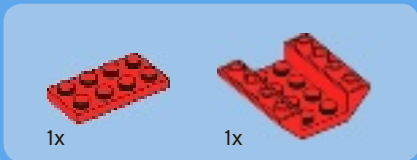

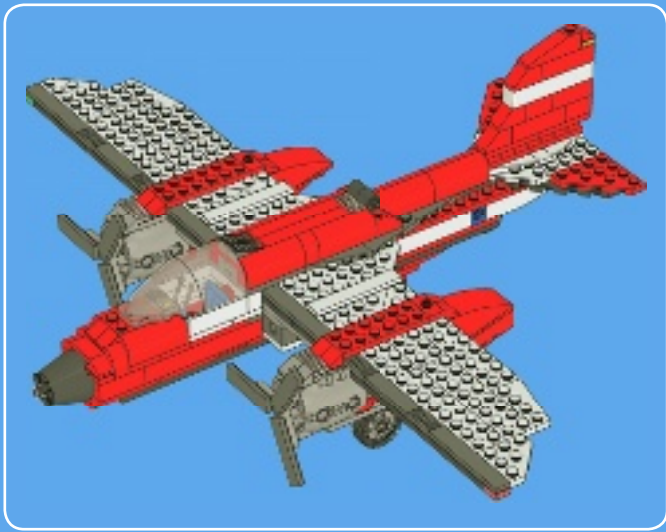



1x

3

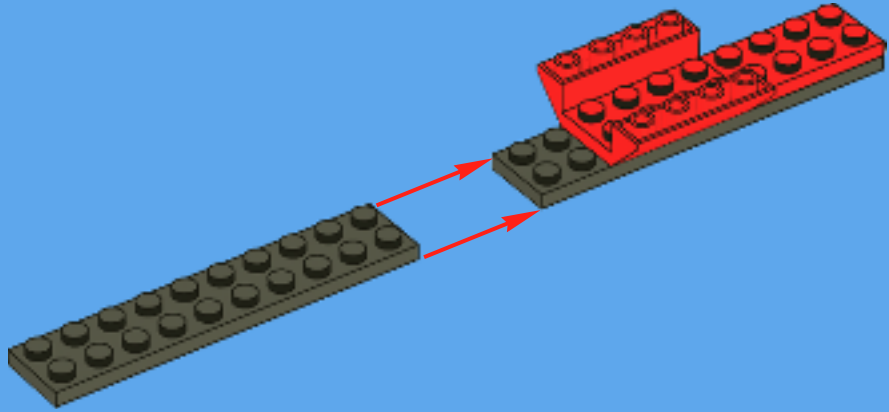

1x

4

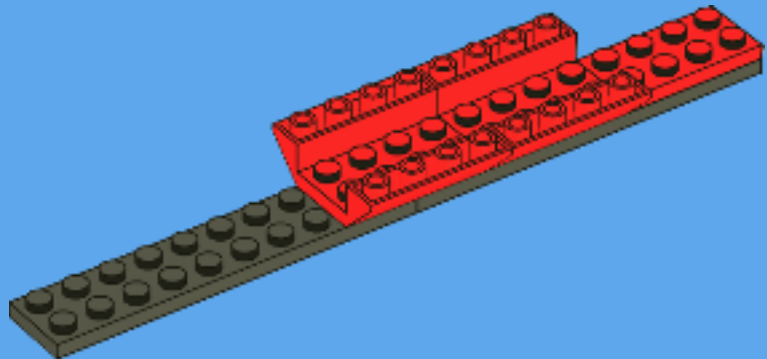



2x



1x

# 5

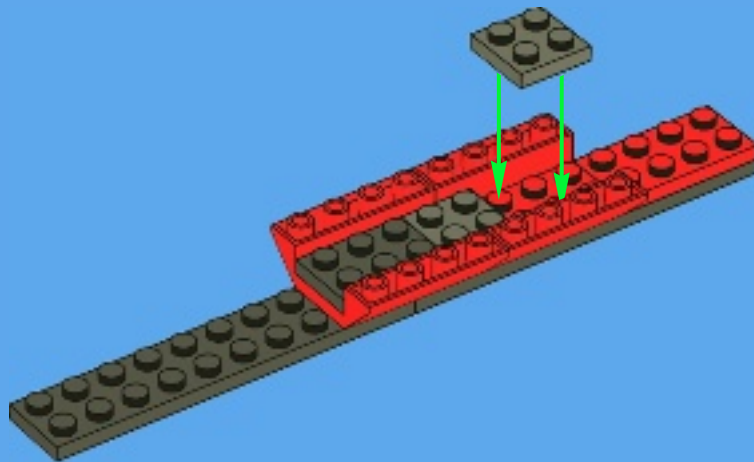

2x



1x

# 6

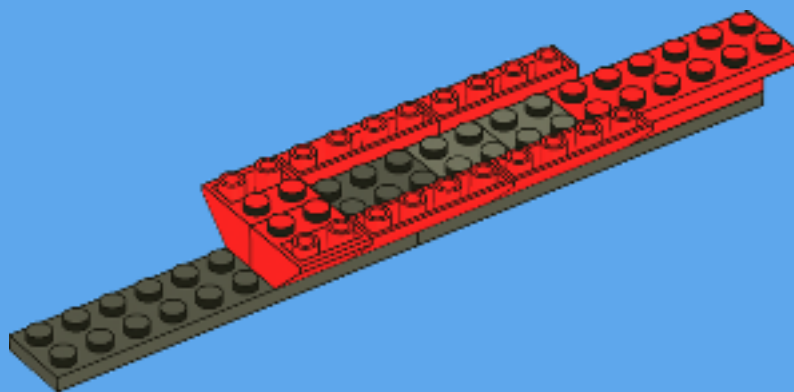

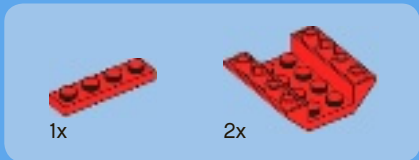

7

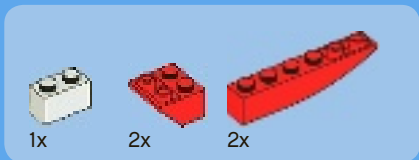
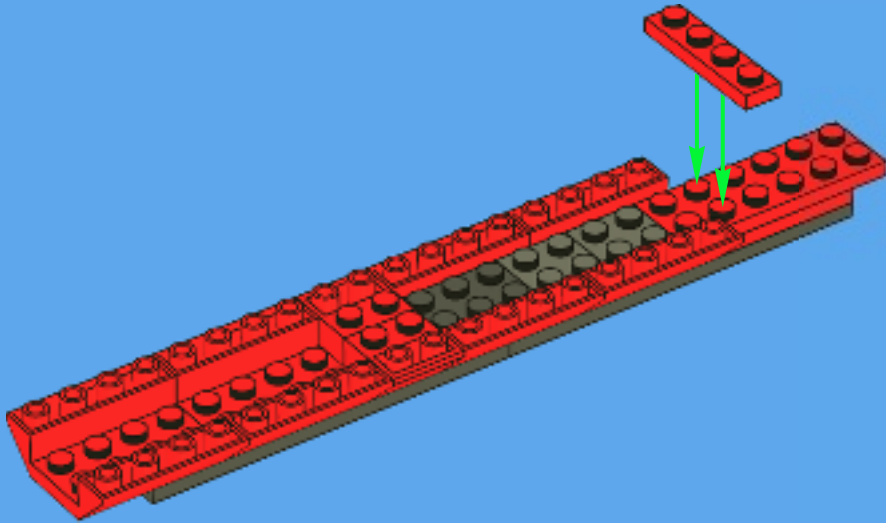

8

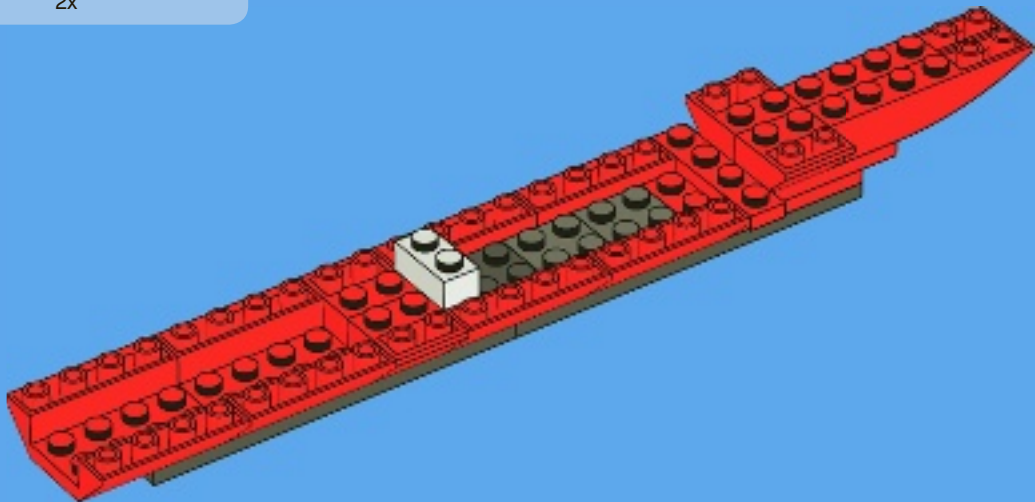

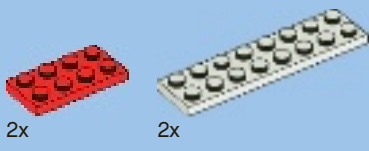

9

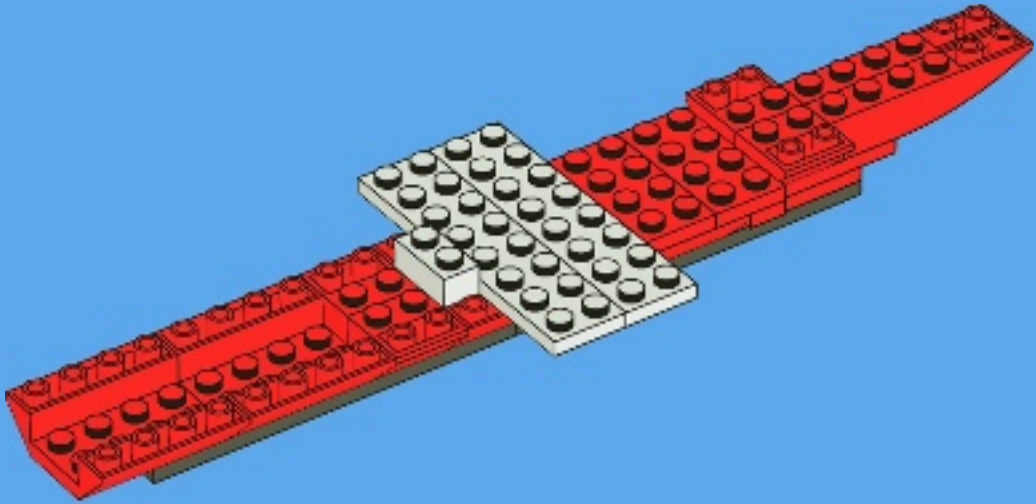

10

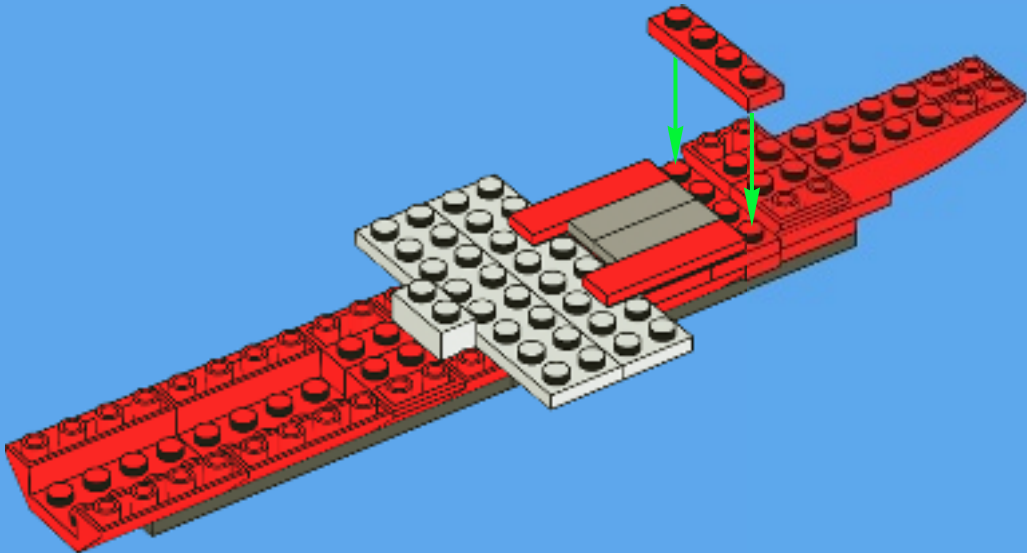



11

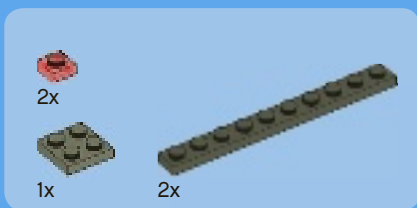
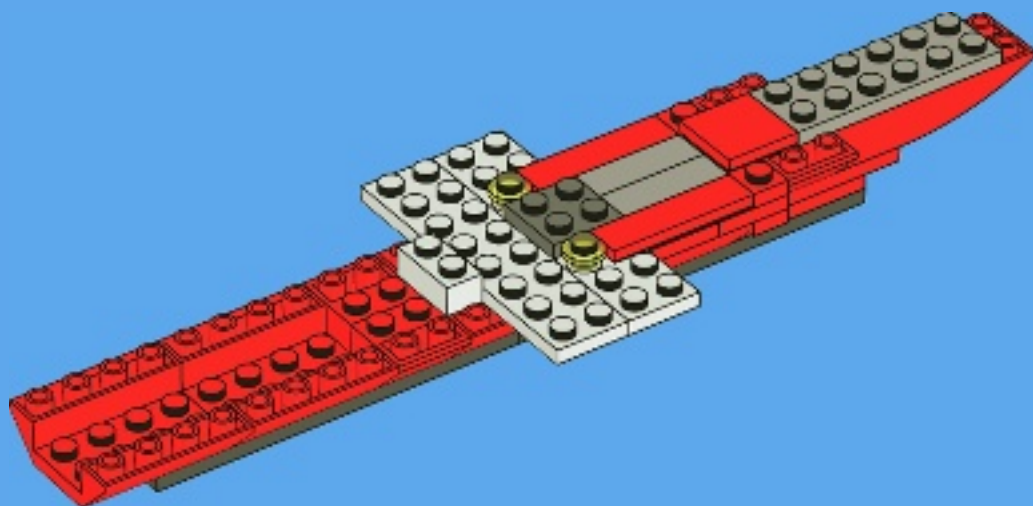

12

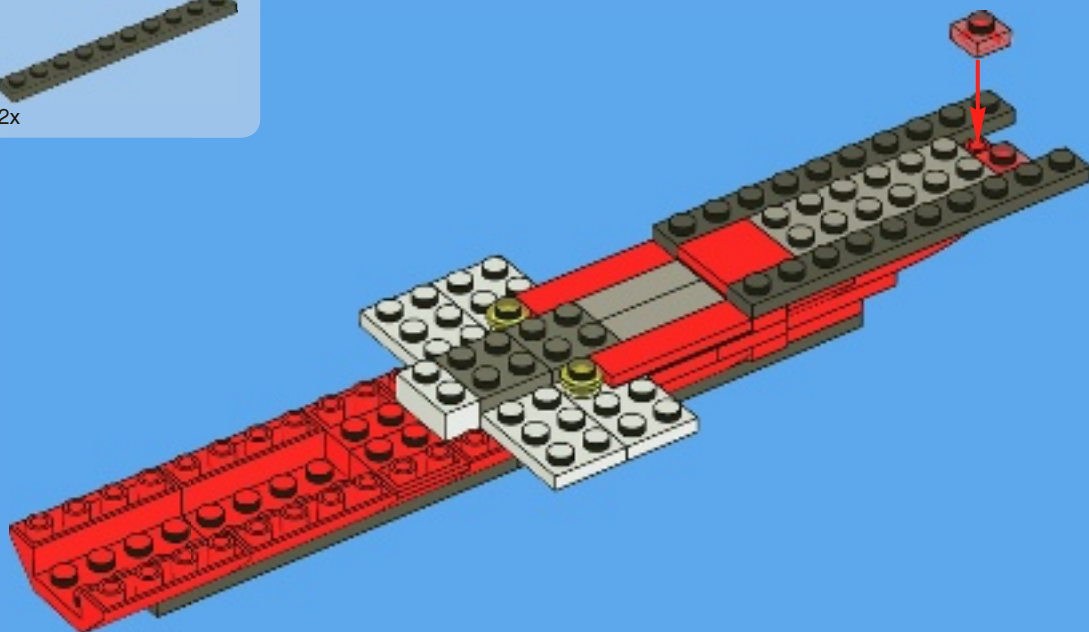

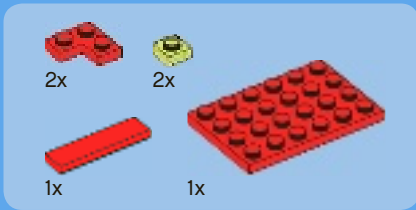

13

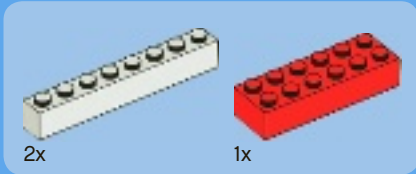
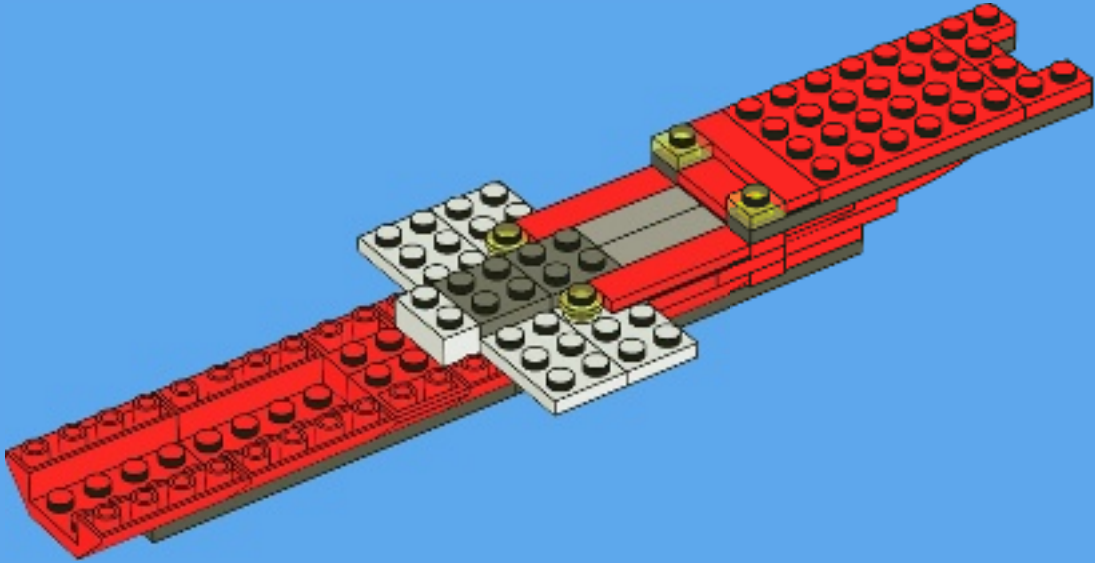

14

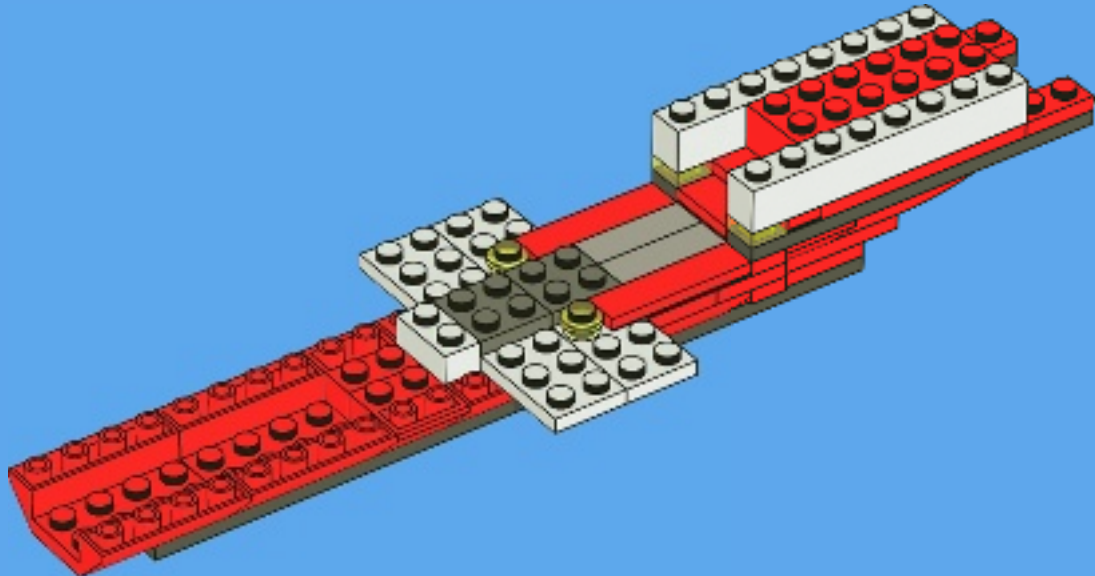





# 15

1

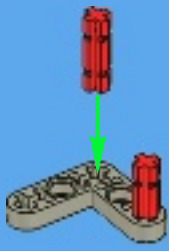

2



3

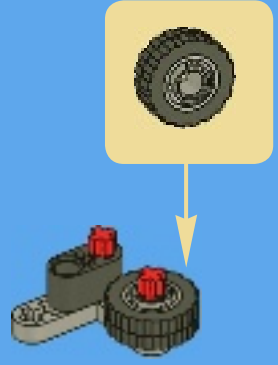

4



5



6

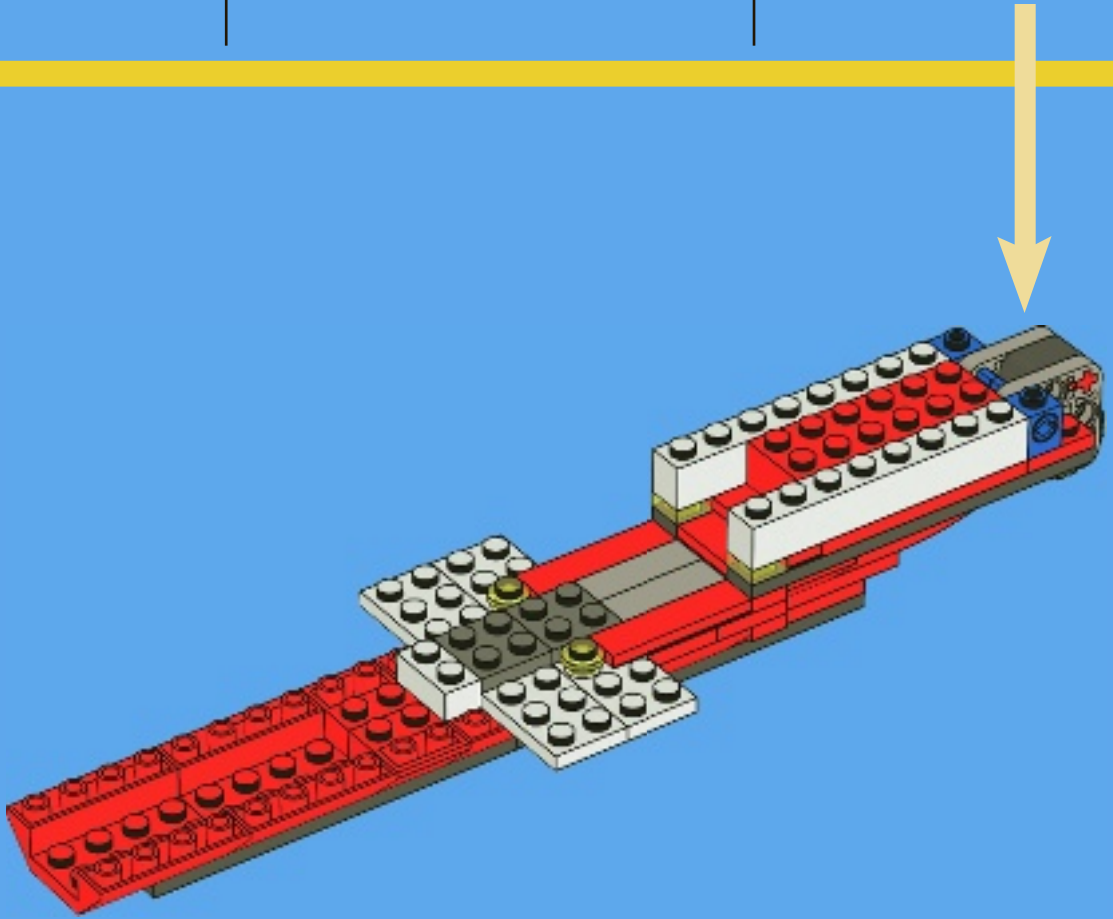

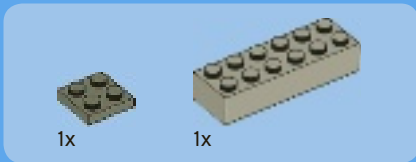

16

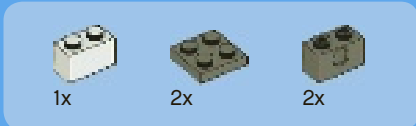
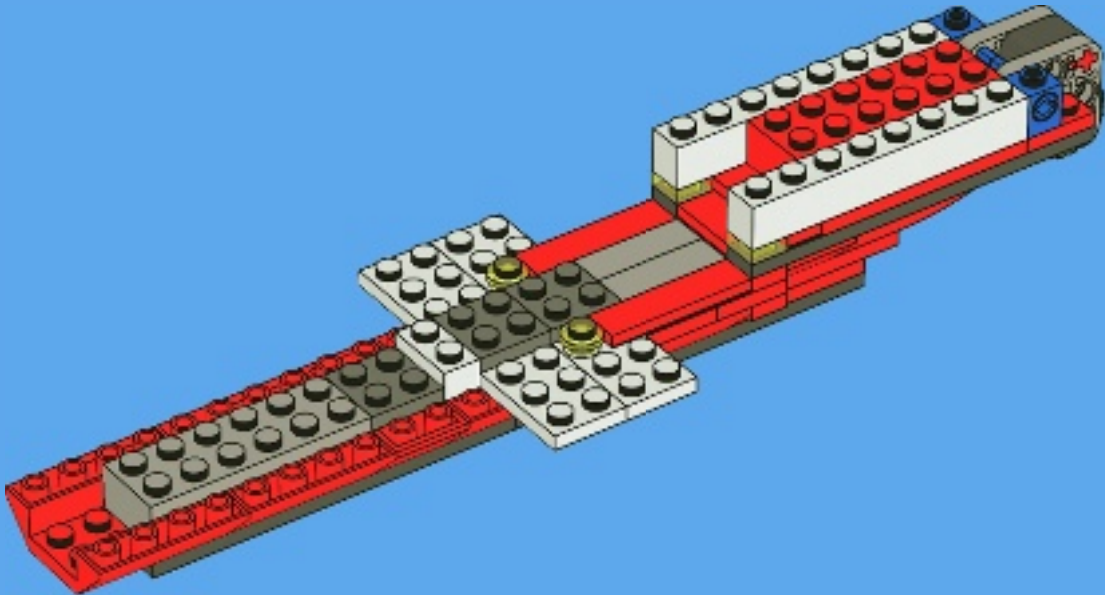

17

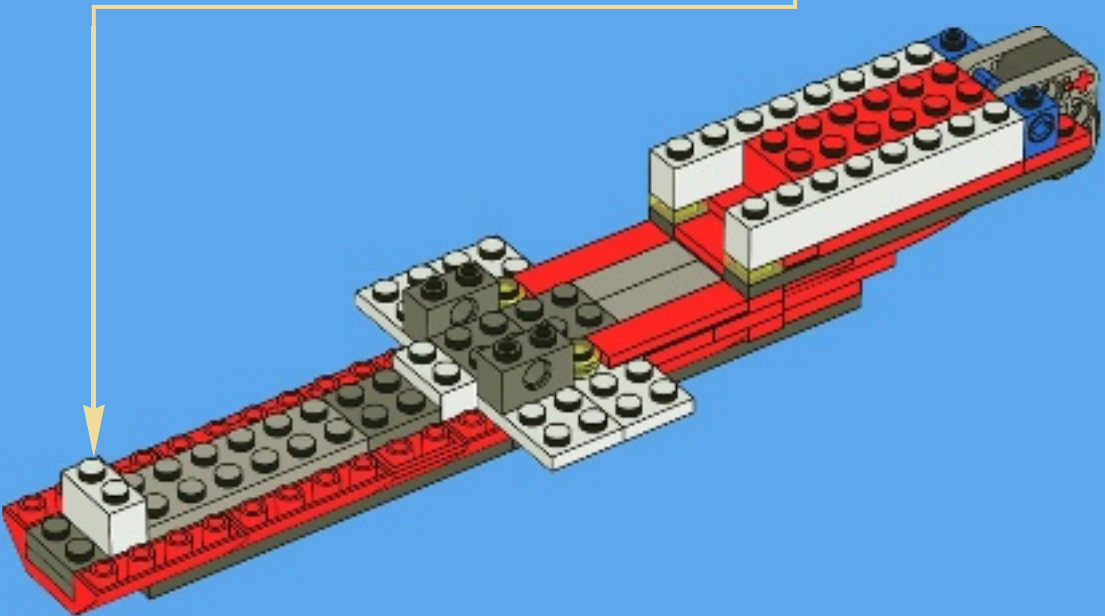
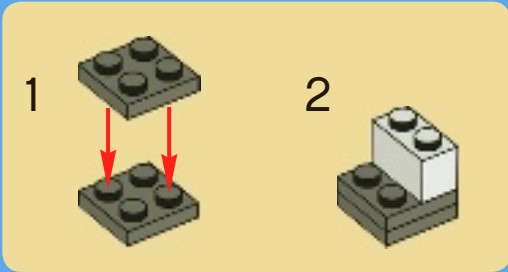

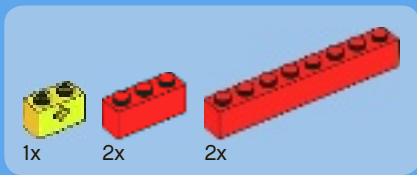

18

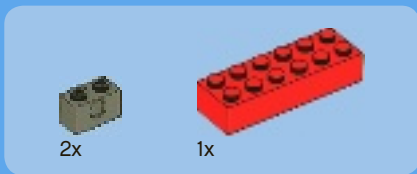
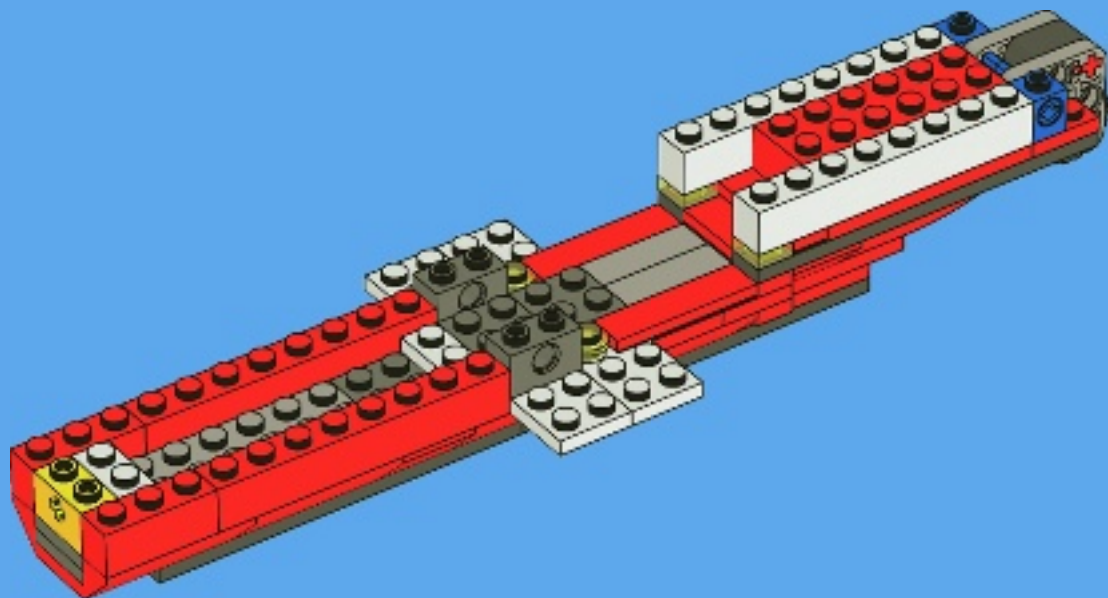

19

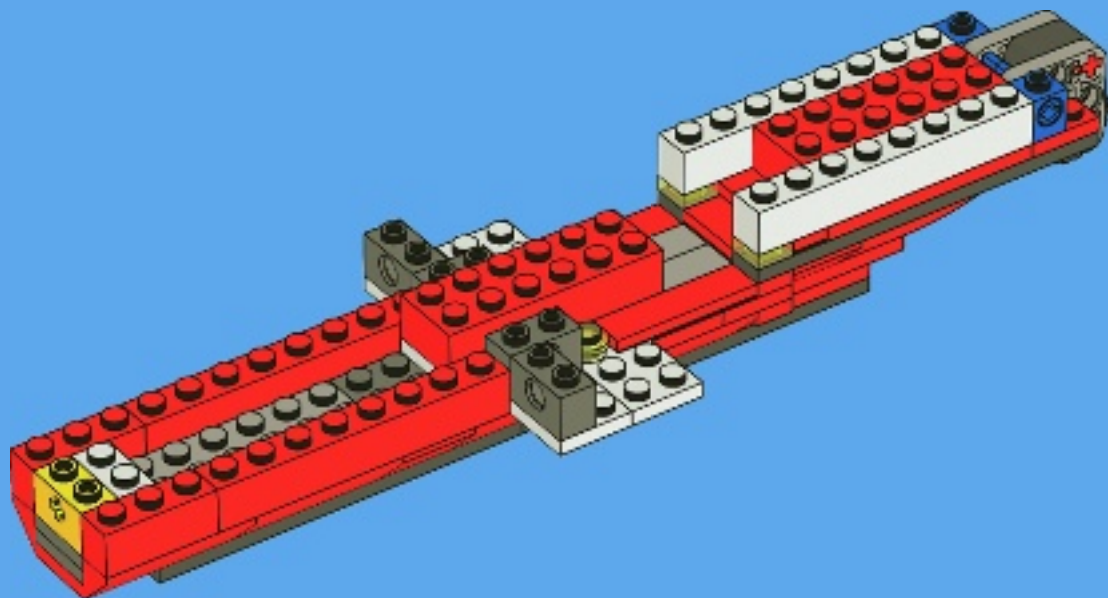



2x



2x



2x



2x

# 20

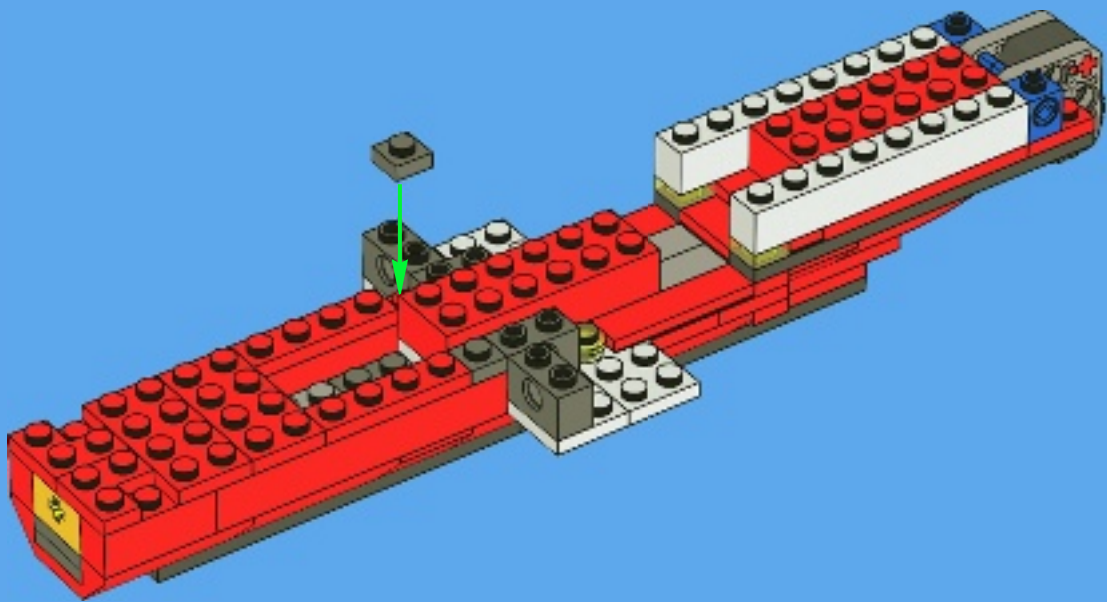



1x



1x

# 21

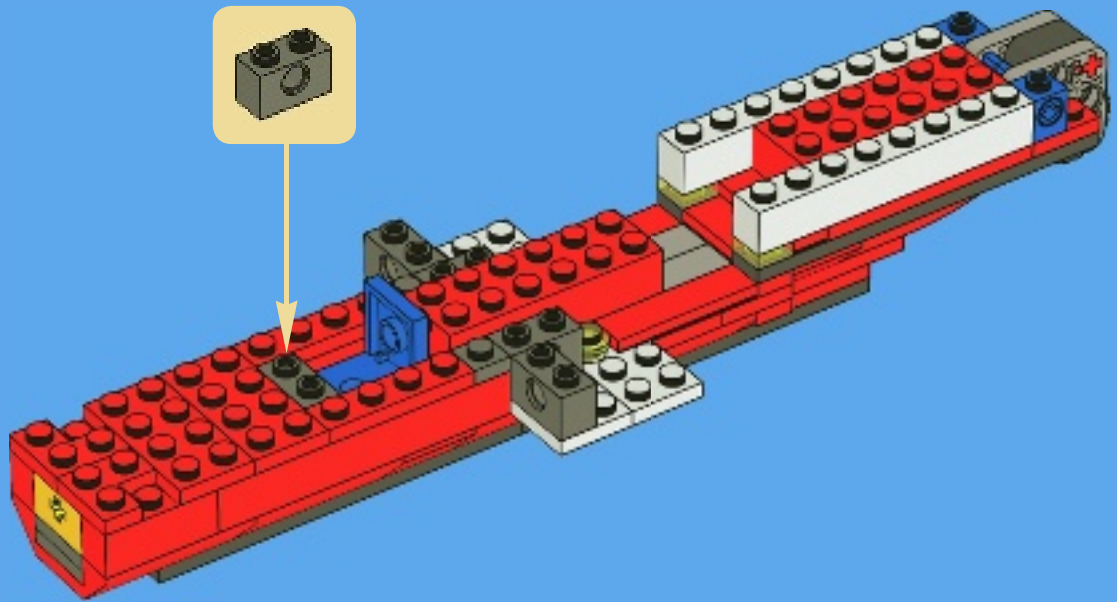

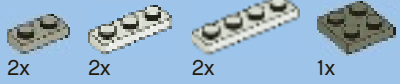

22

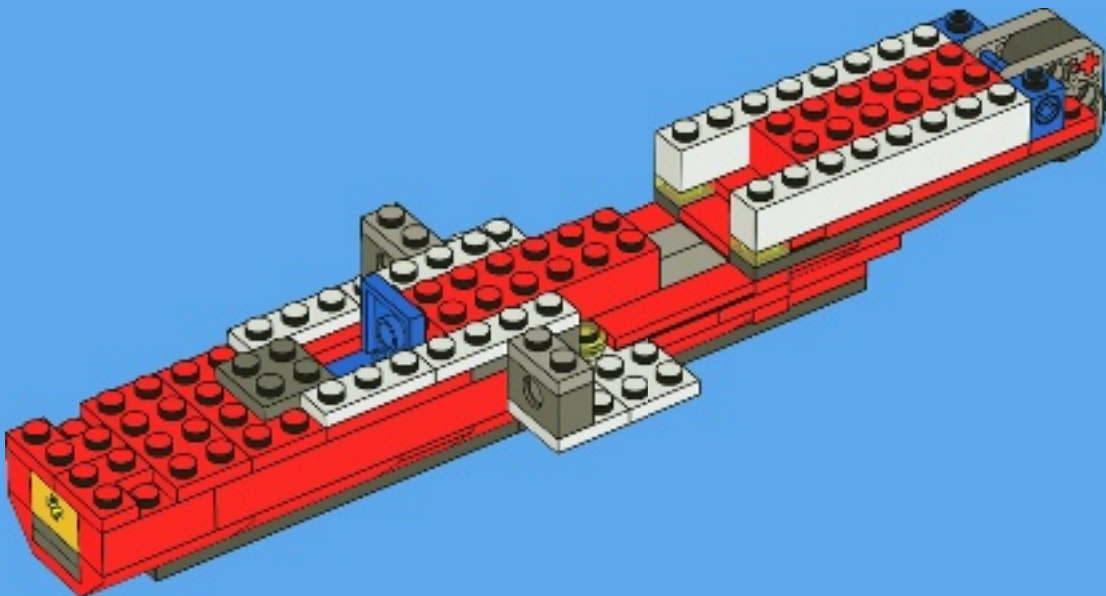



1x



1x



1x



2x

# 23

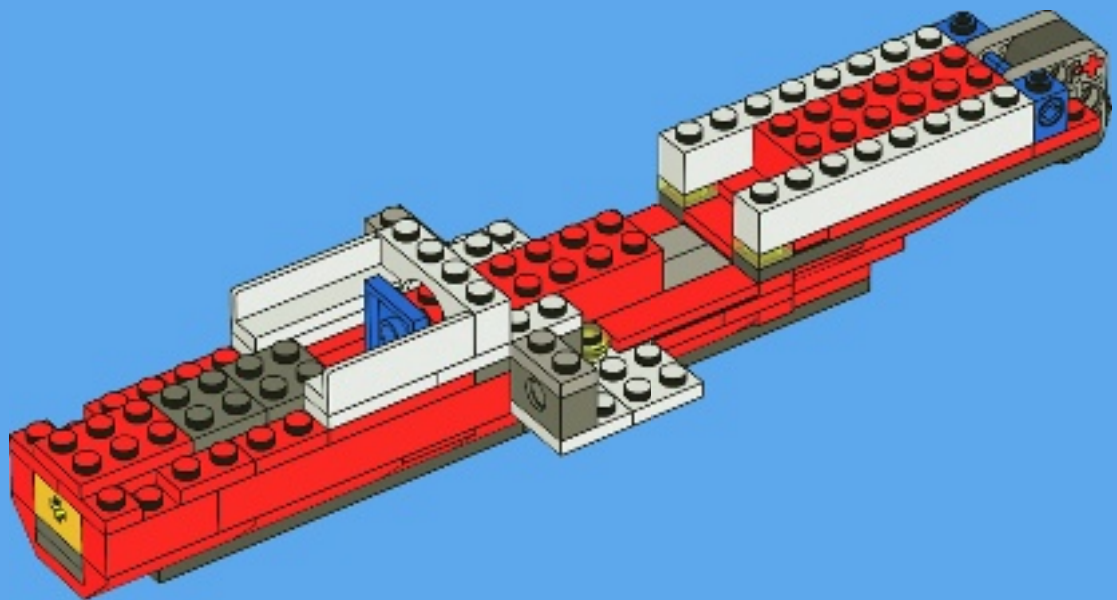

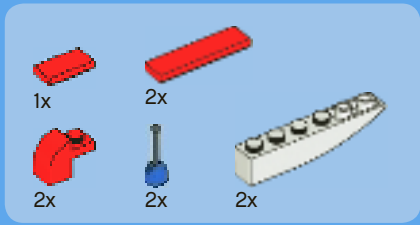

24

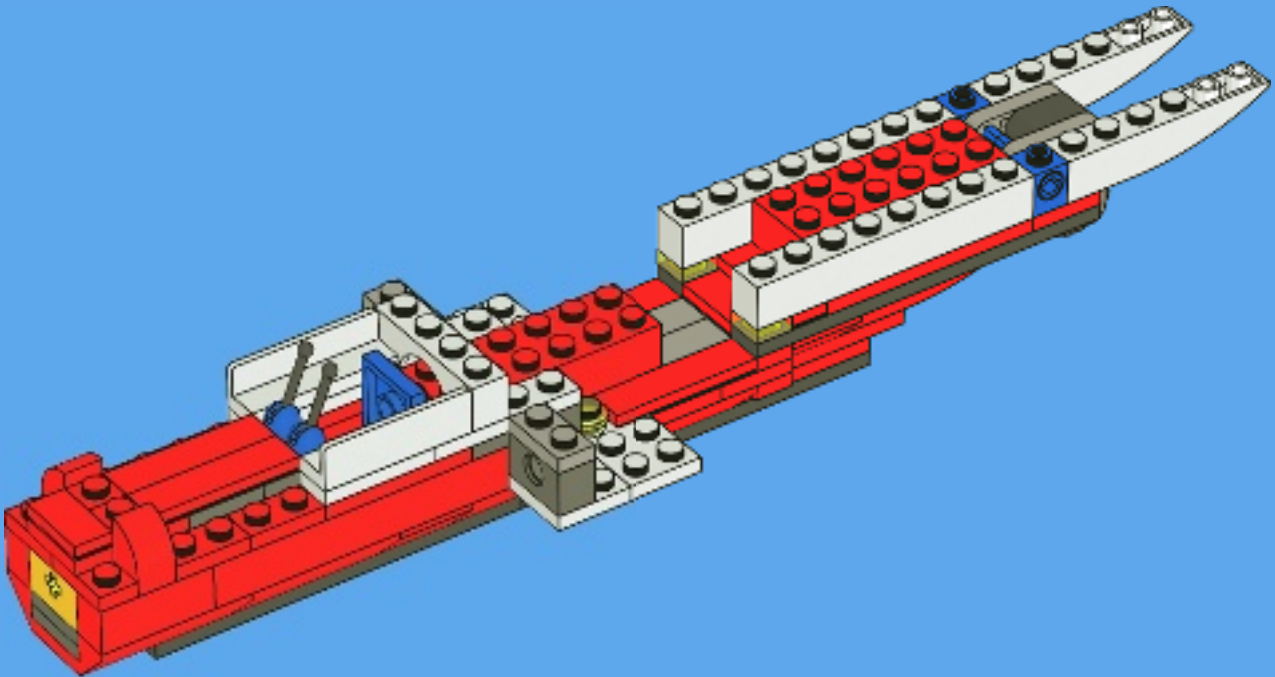





25

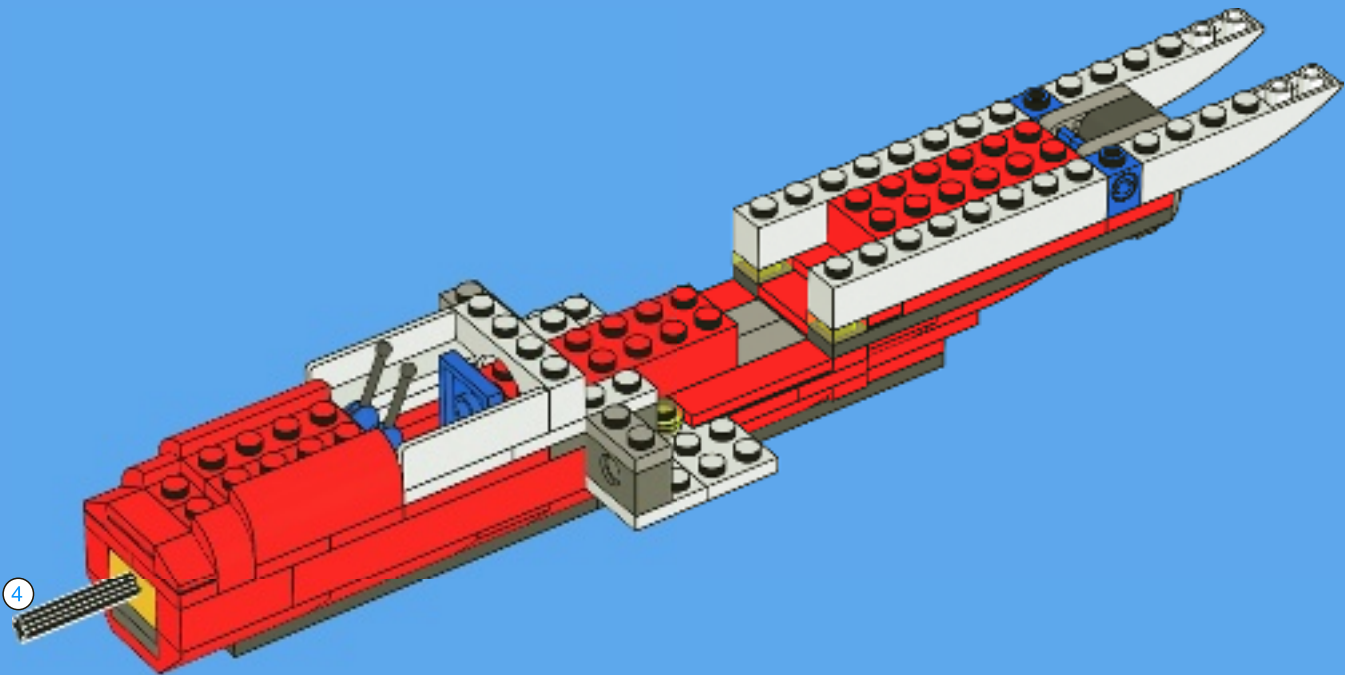

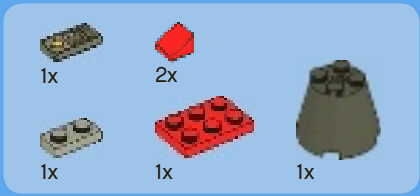

# 26

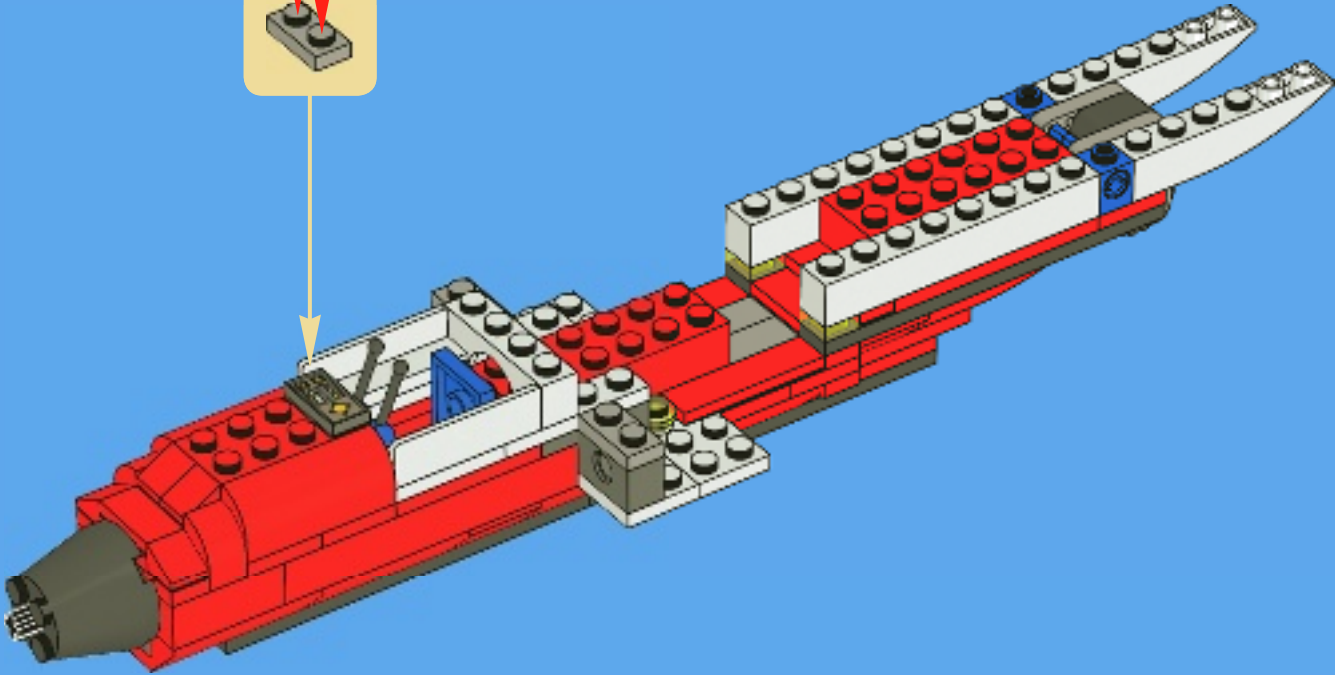
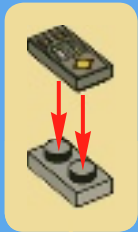

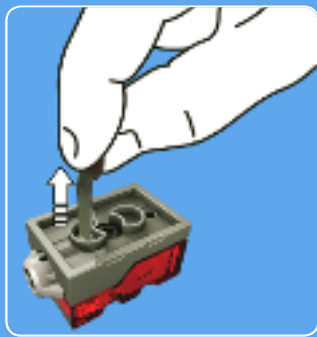
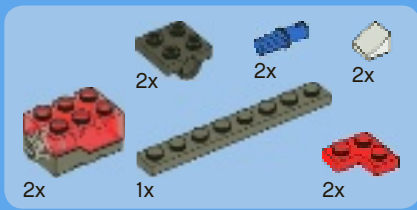

27

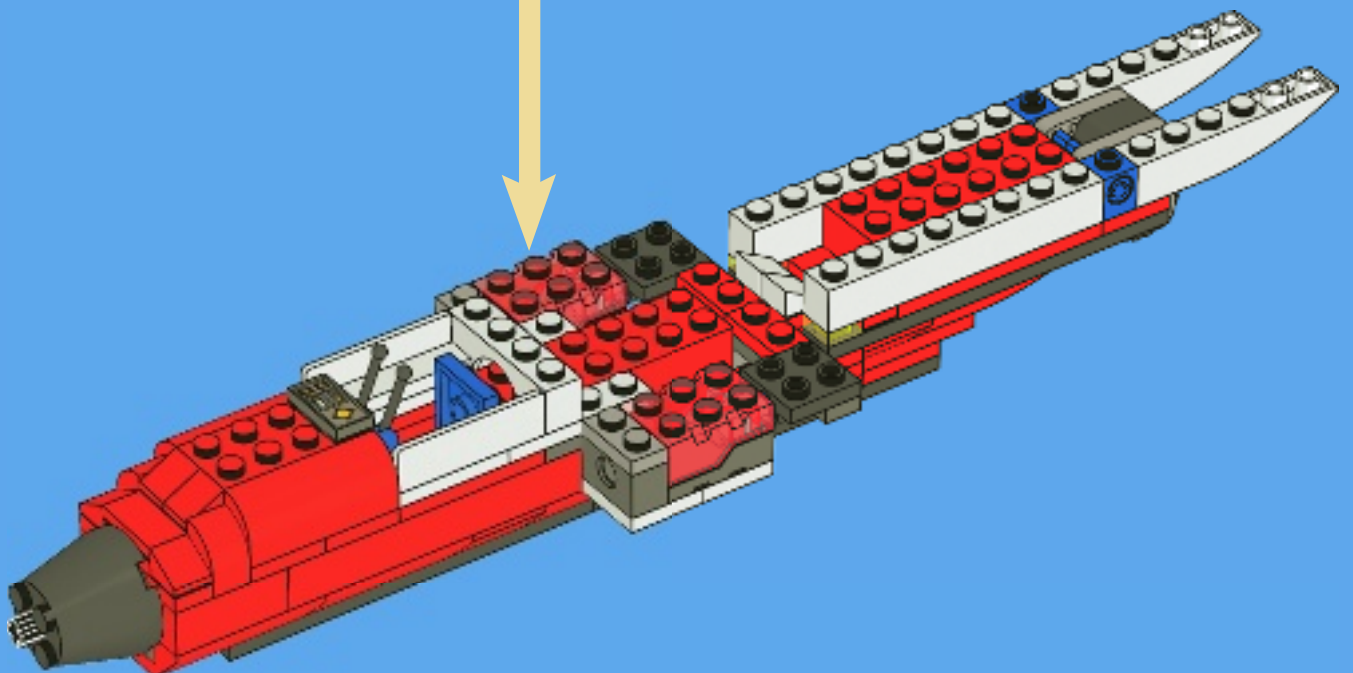
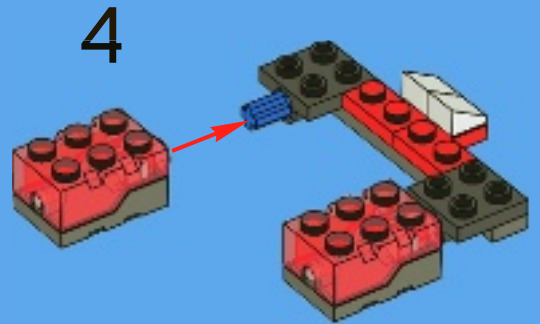
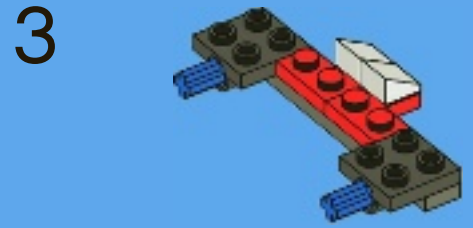
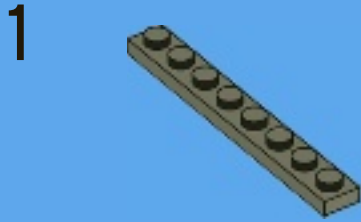

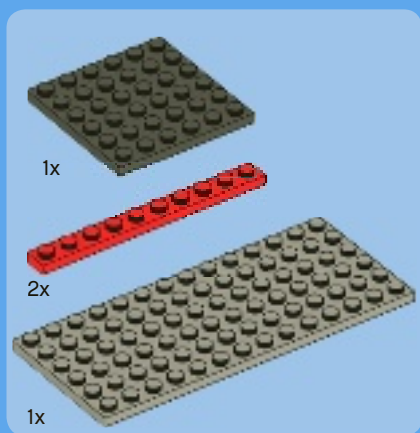

28

1

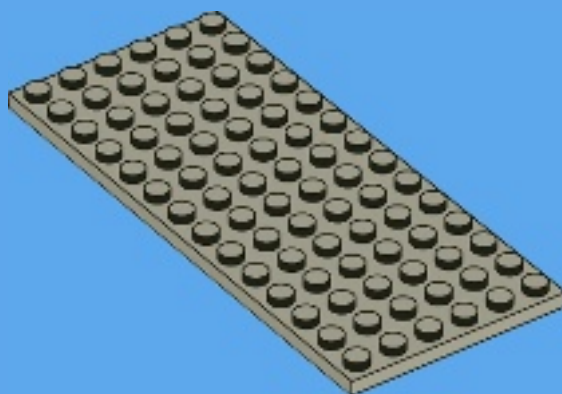

2

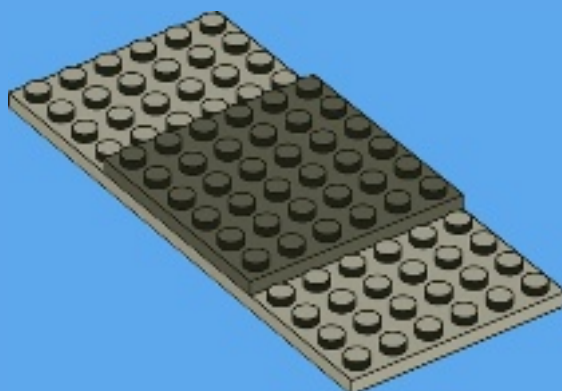

3

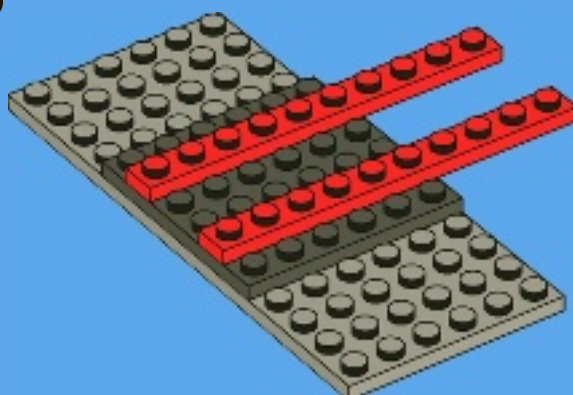

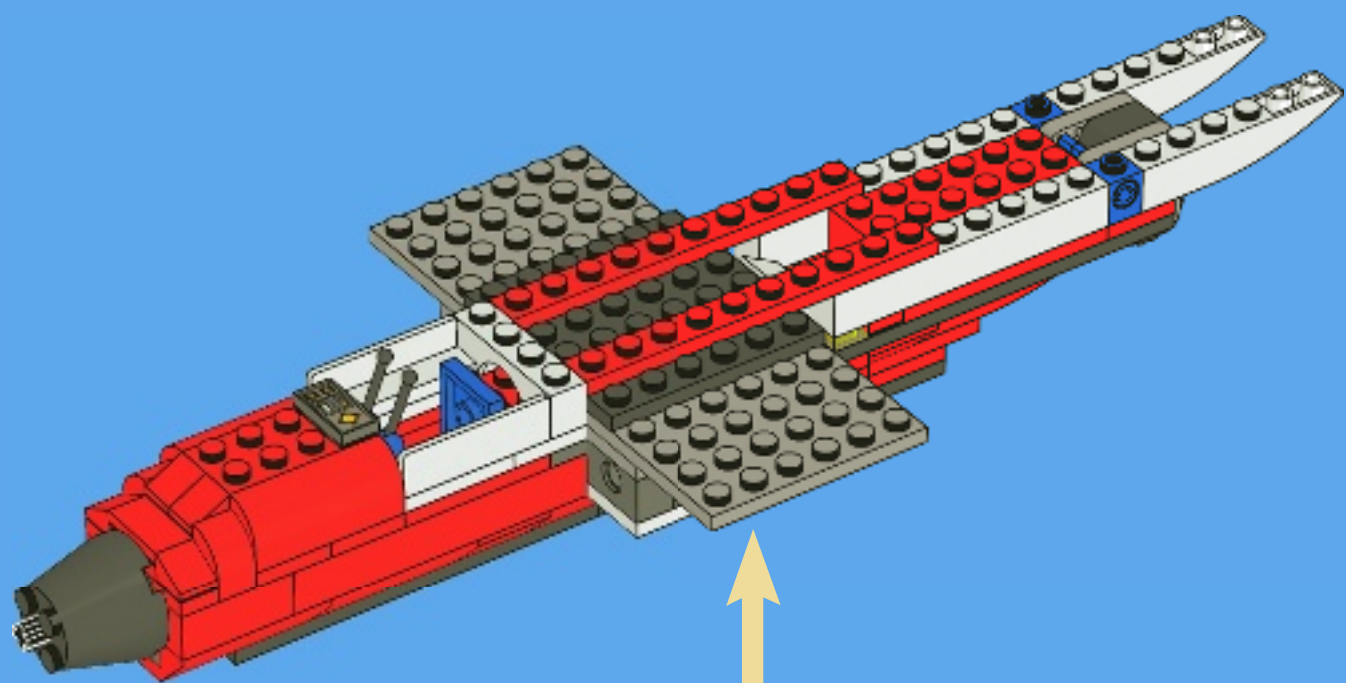

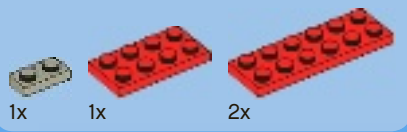

29

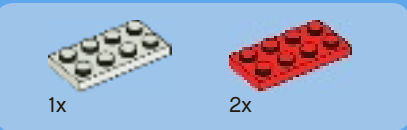
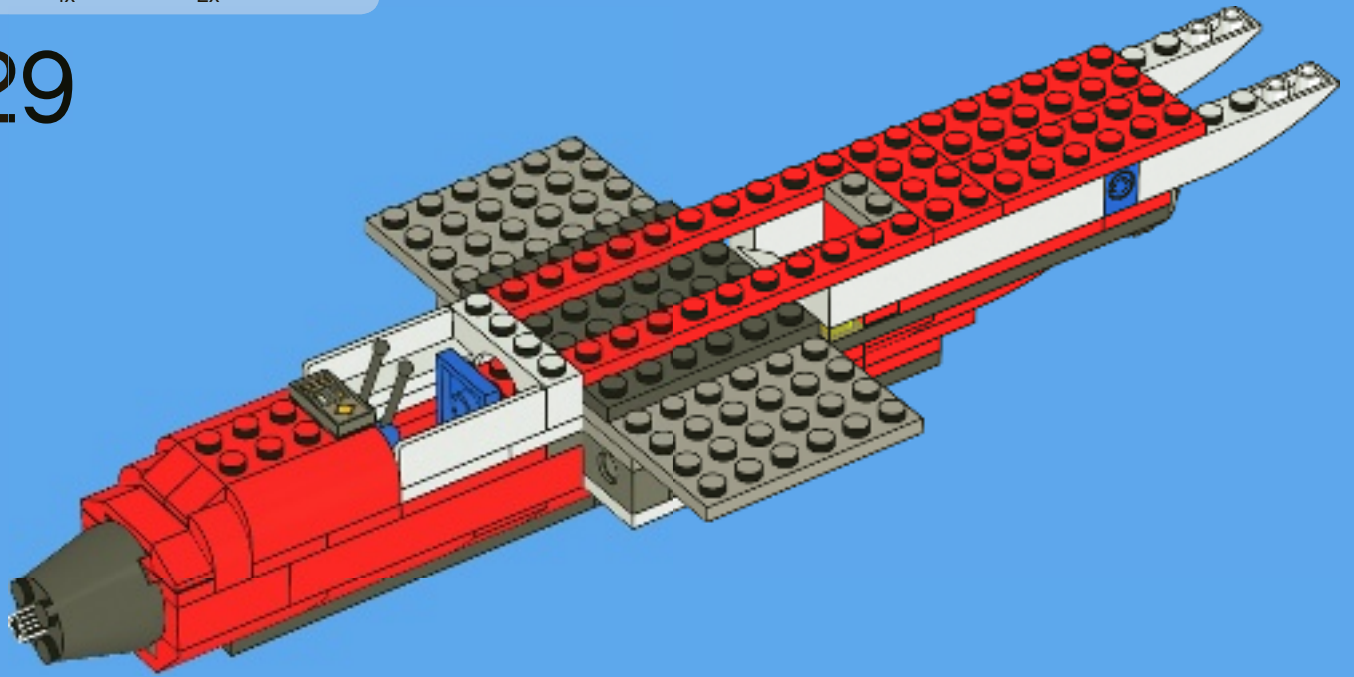

30

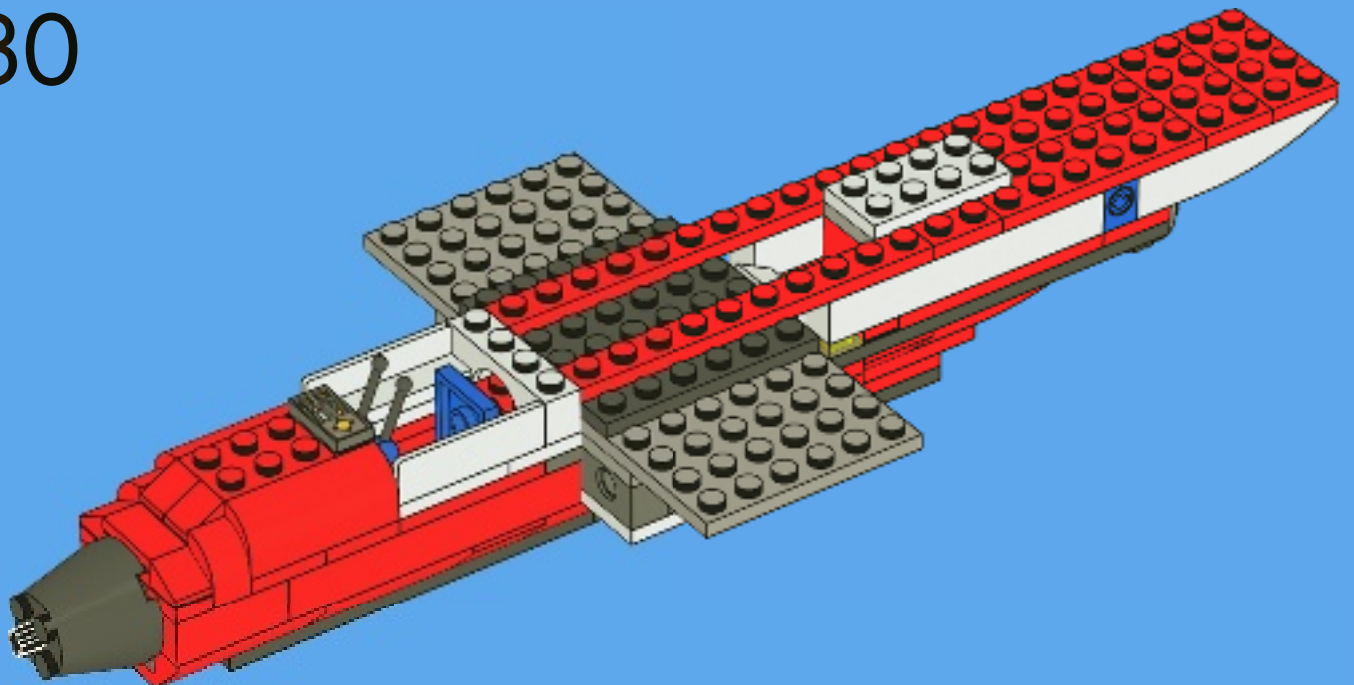



2x



2x

# 31

1

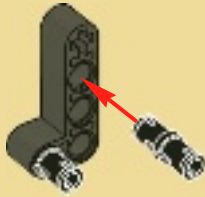

2

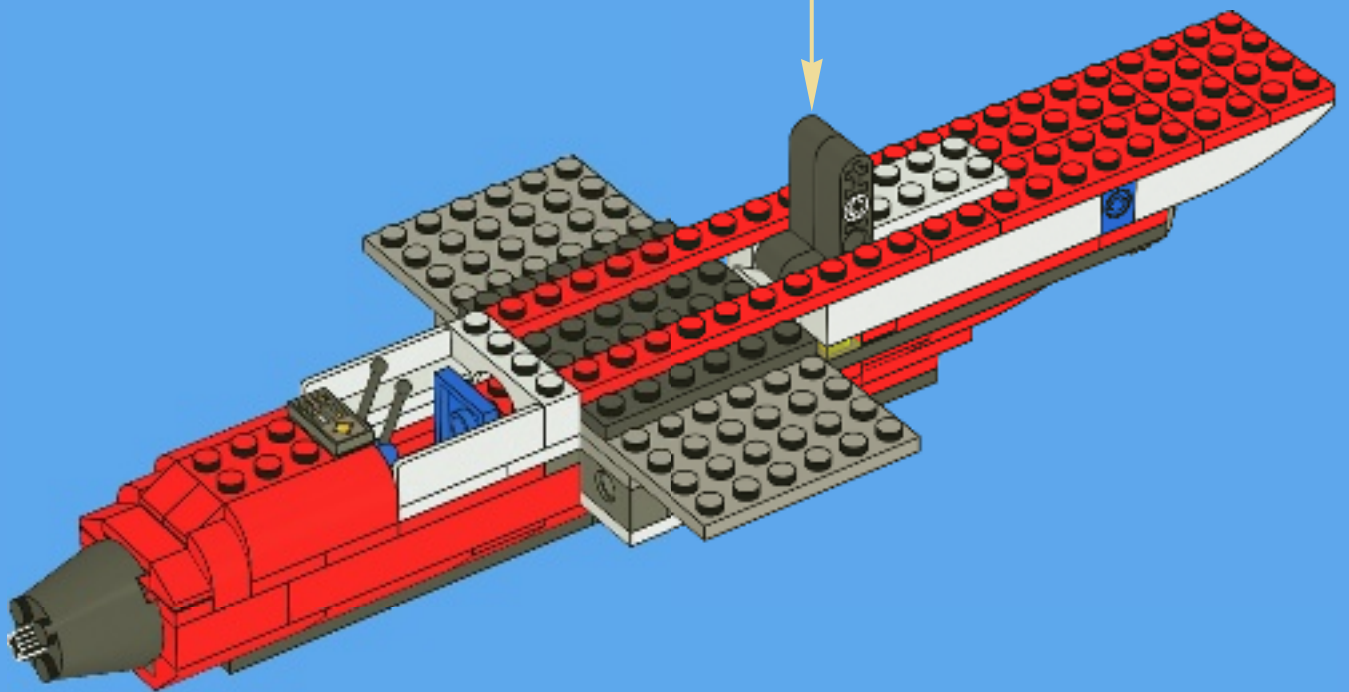

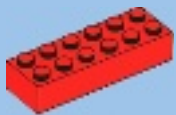

1x



1x

# 32

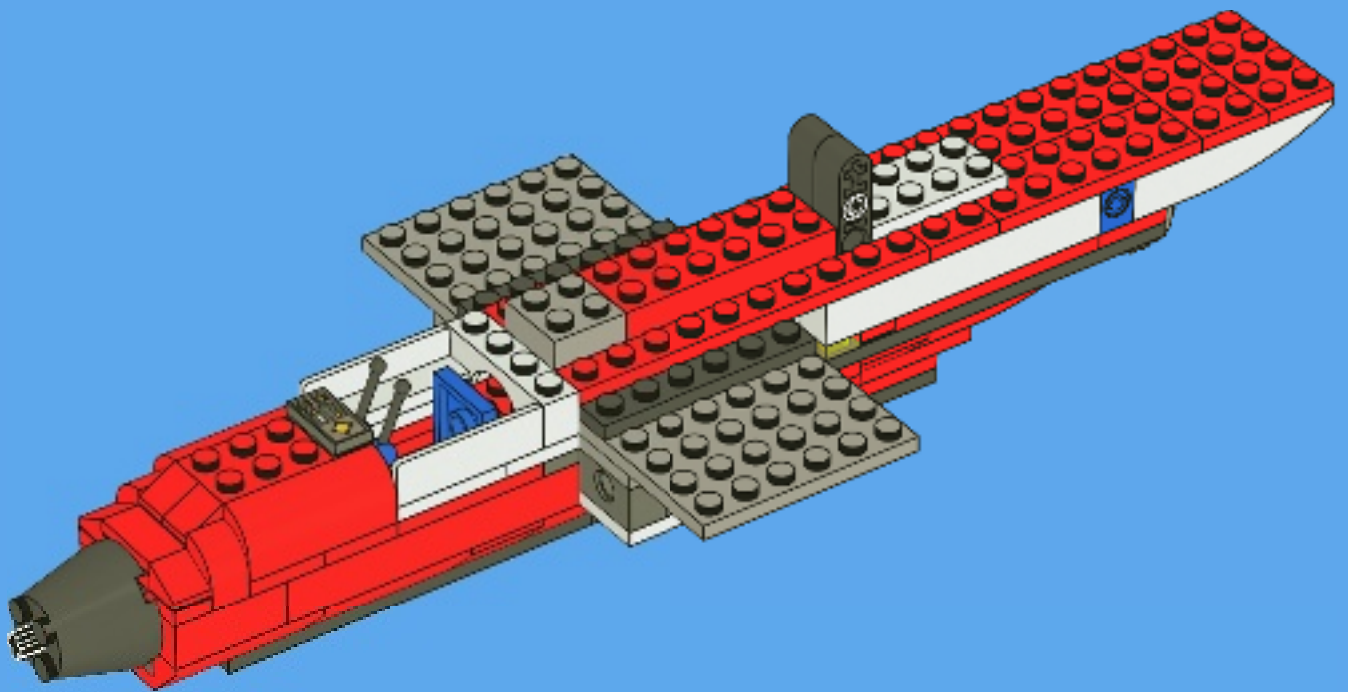



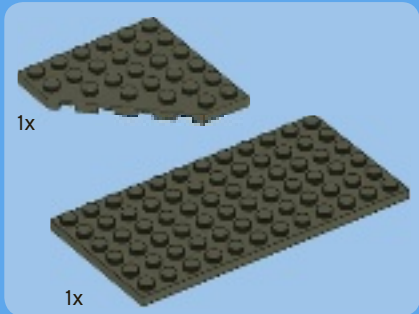
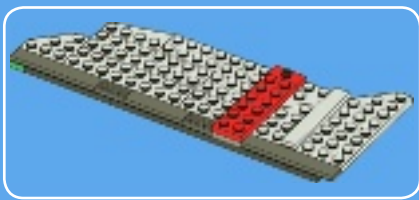

1

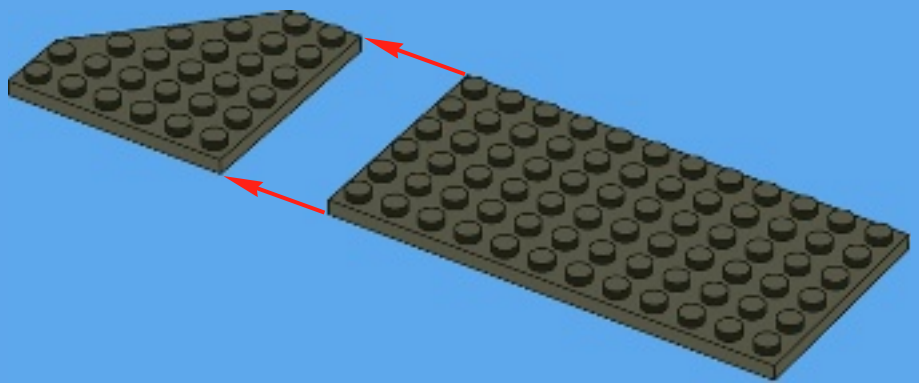

2

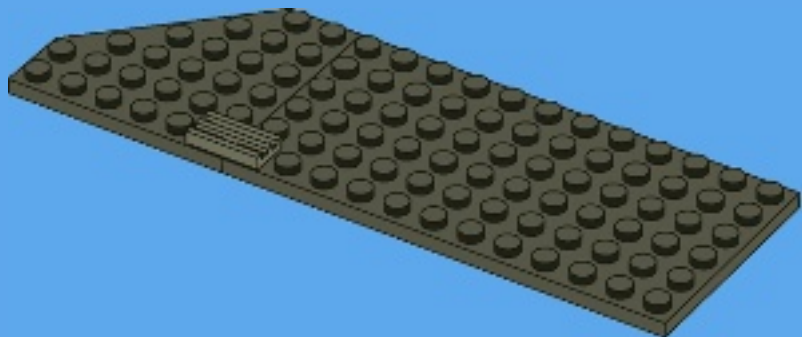

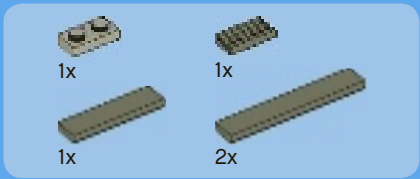

3

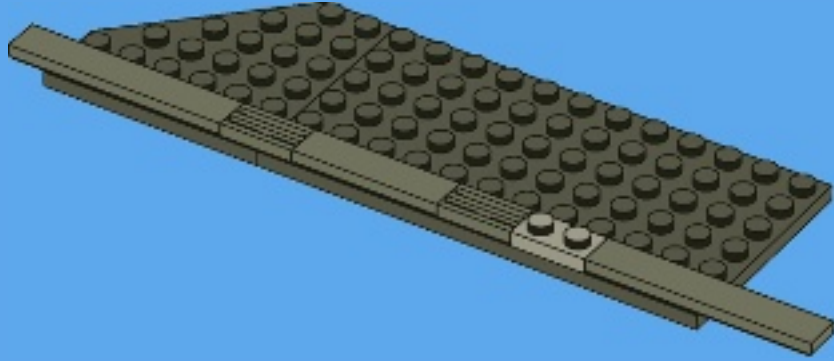

4

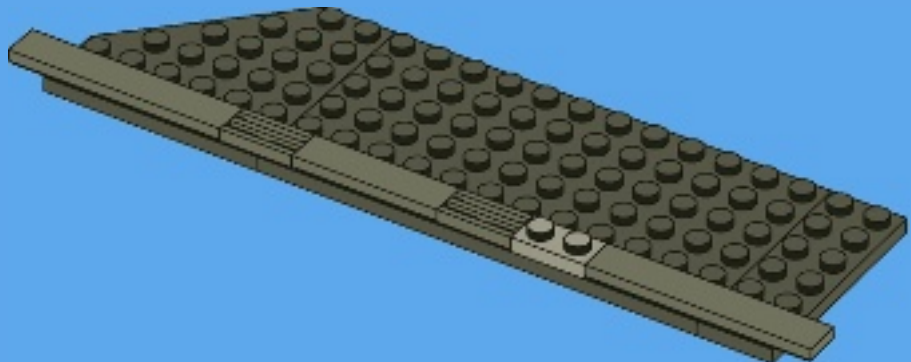

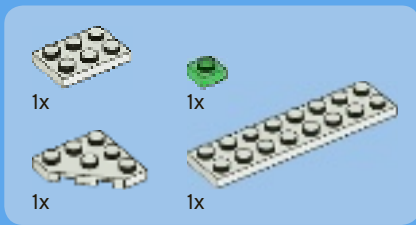

5

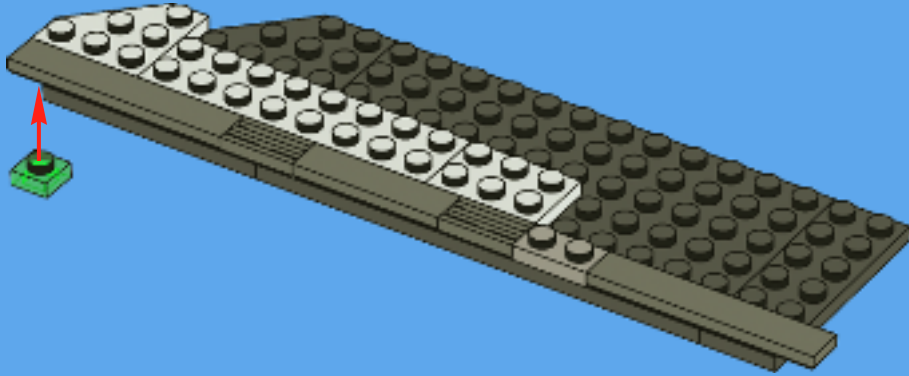

6

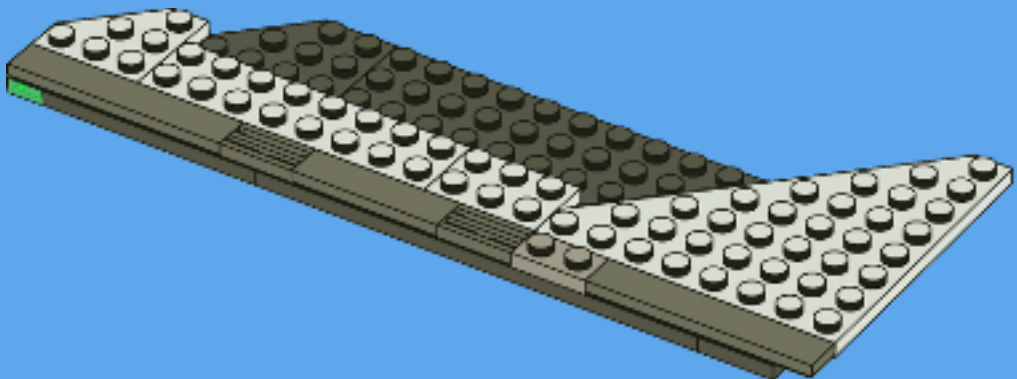

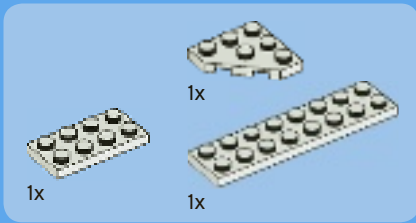

7

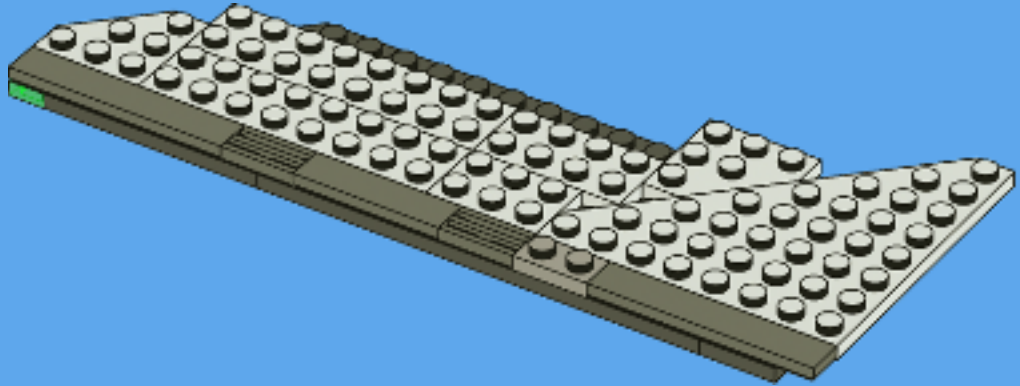

8

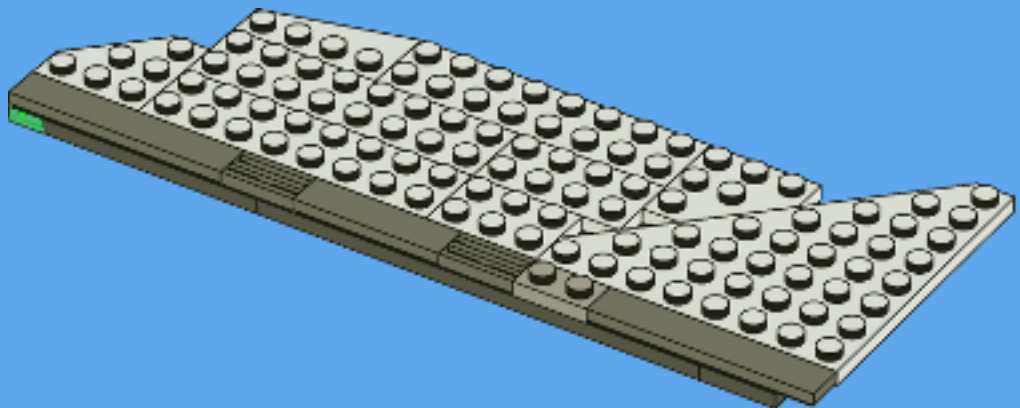

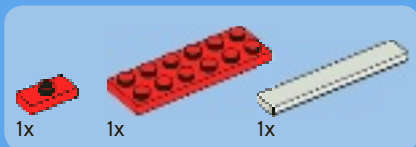

9

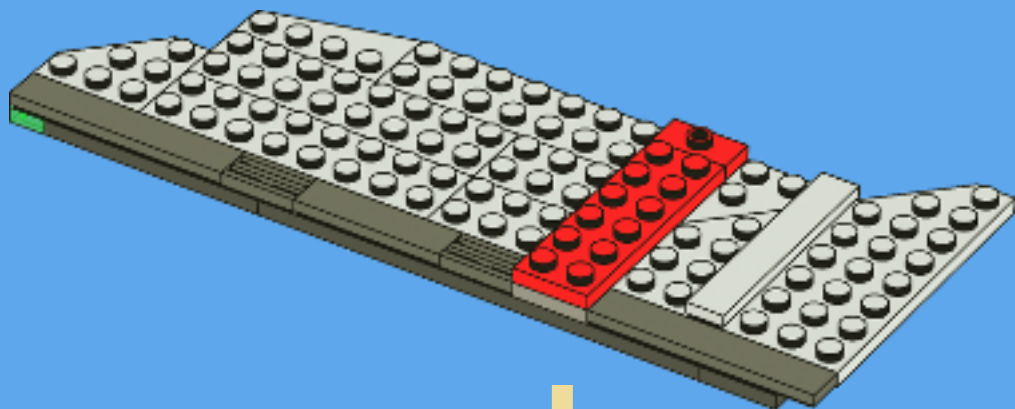

33

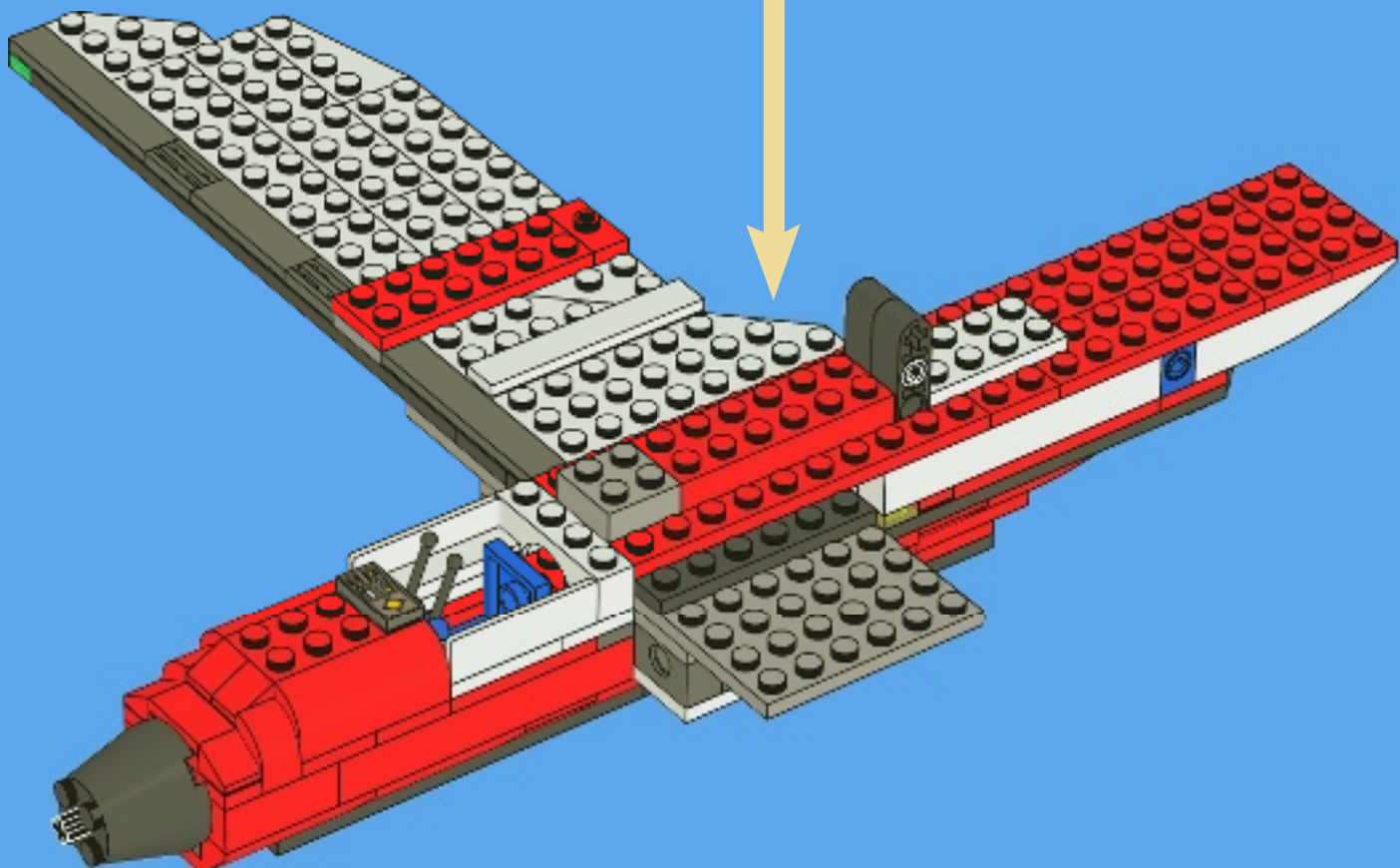

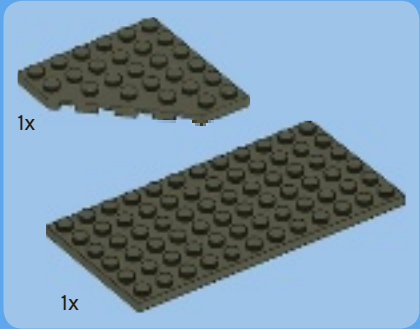
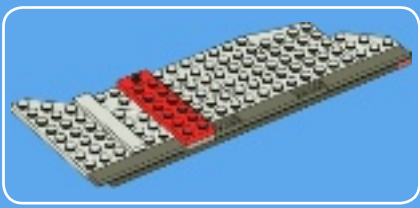

1

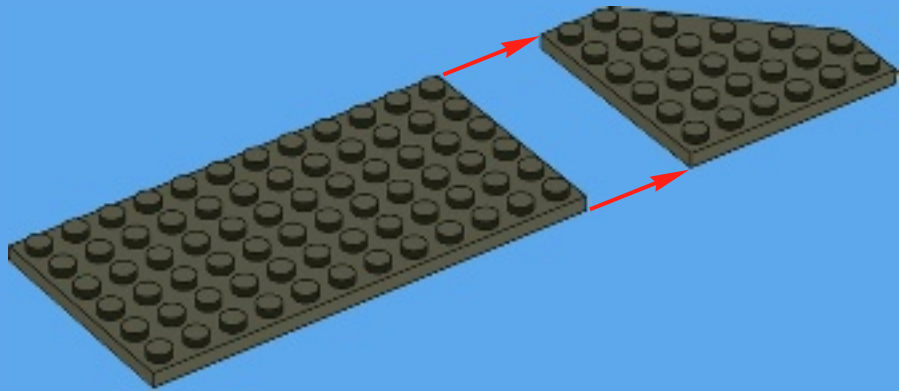

2

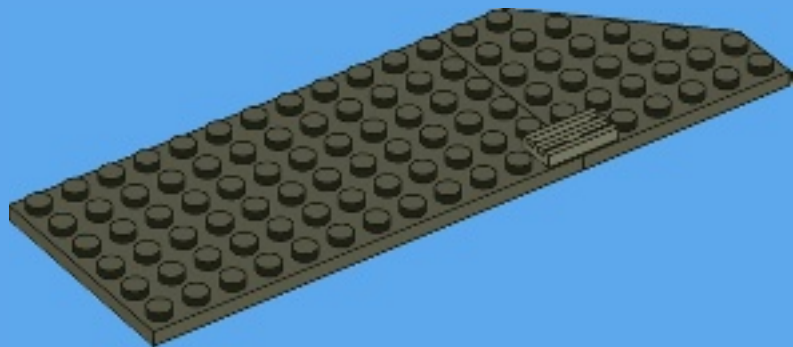

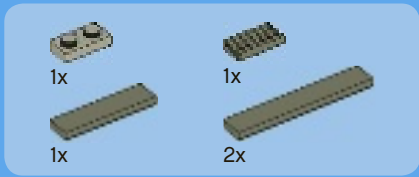

3

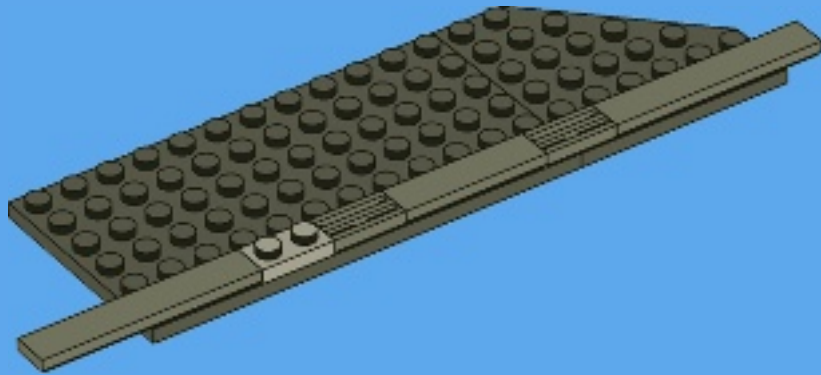

4

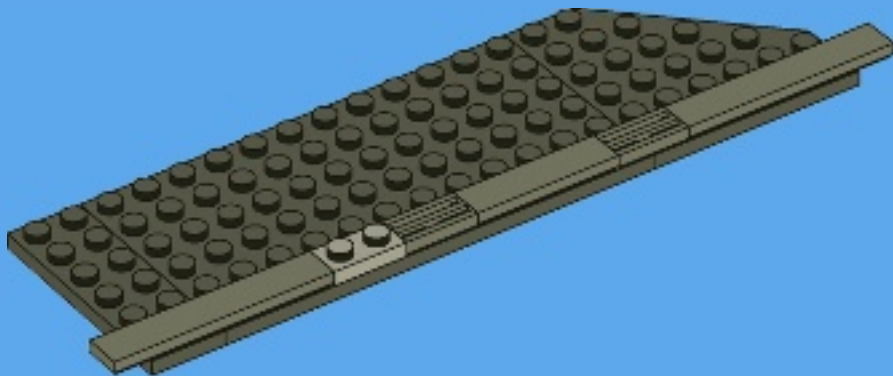

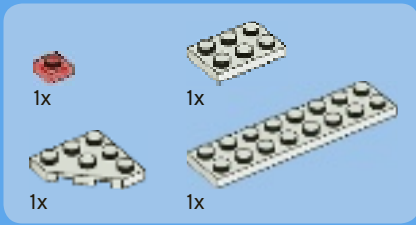

5

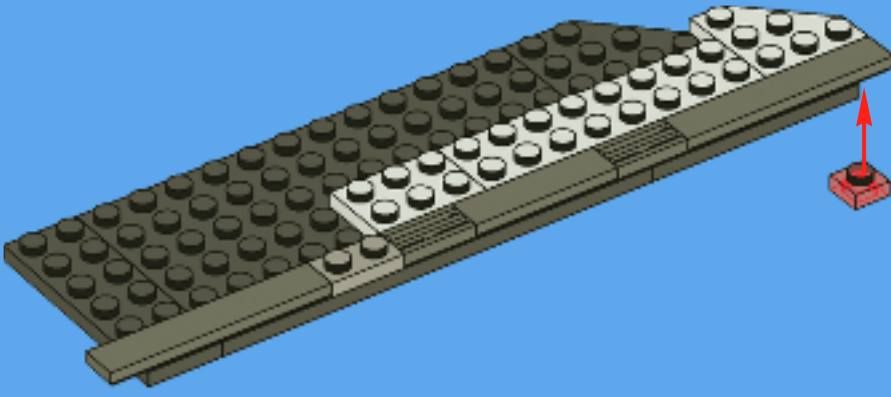

6

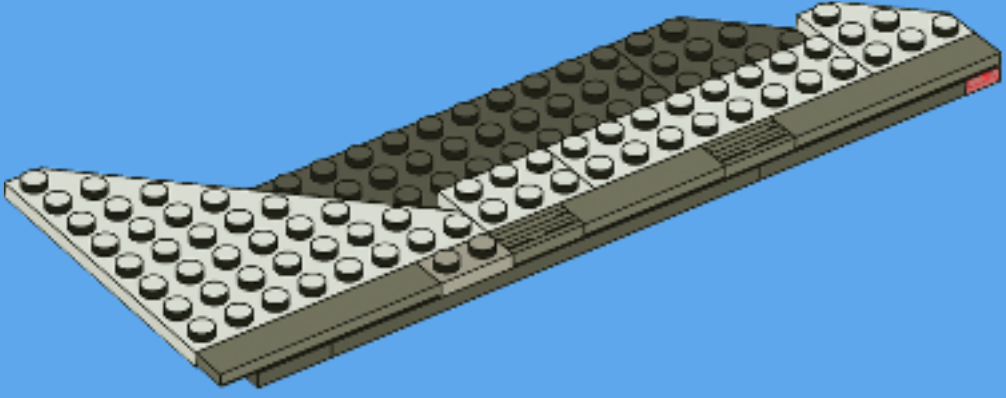



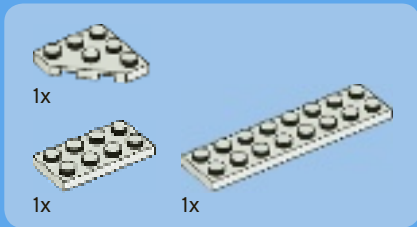

7

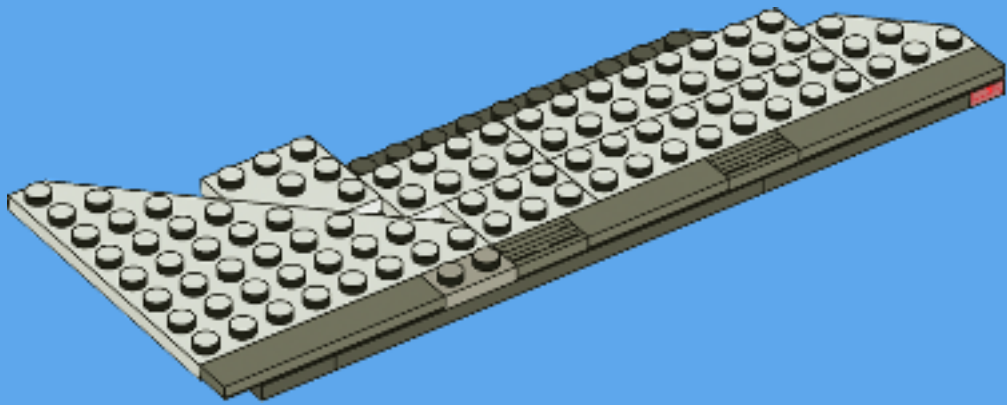

8

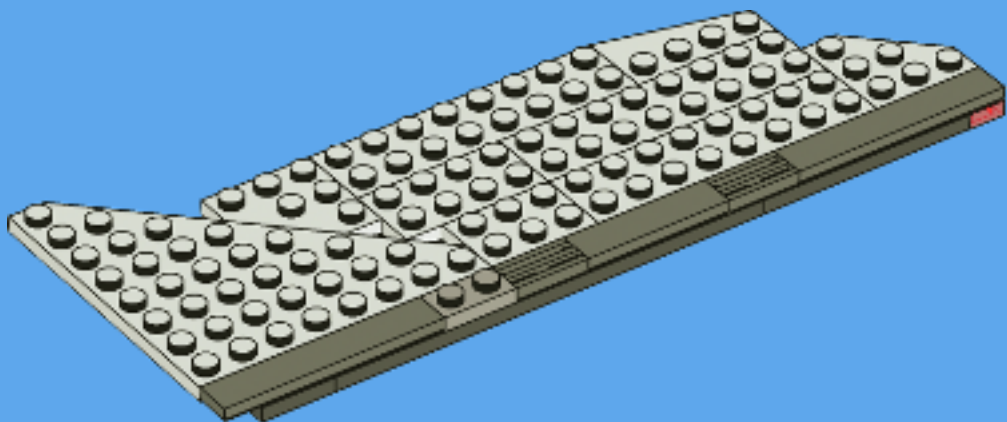

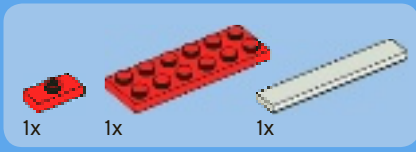

9

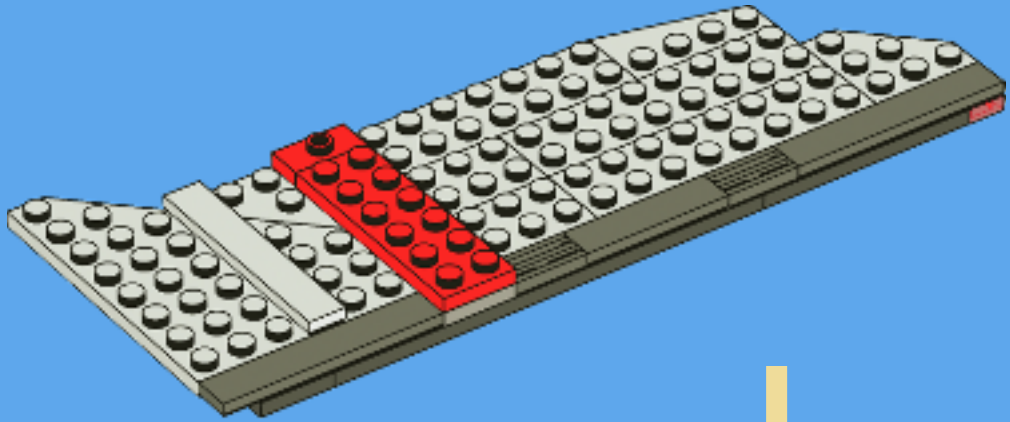

34

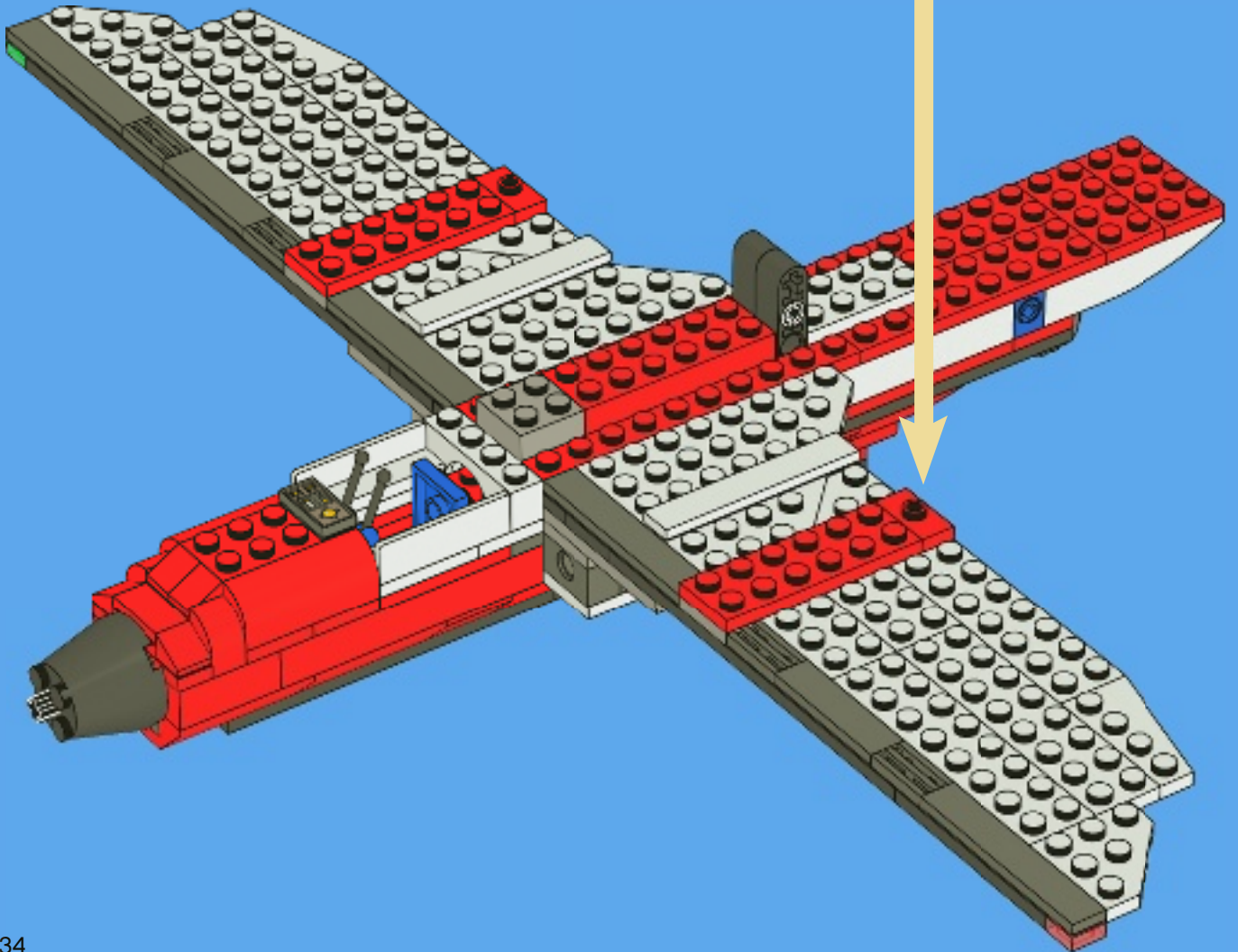

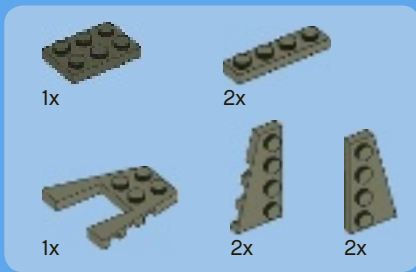

35

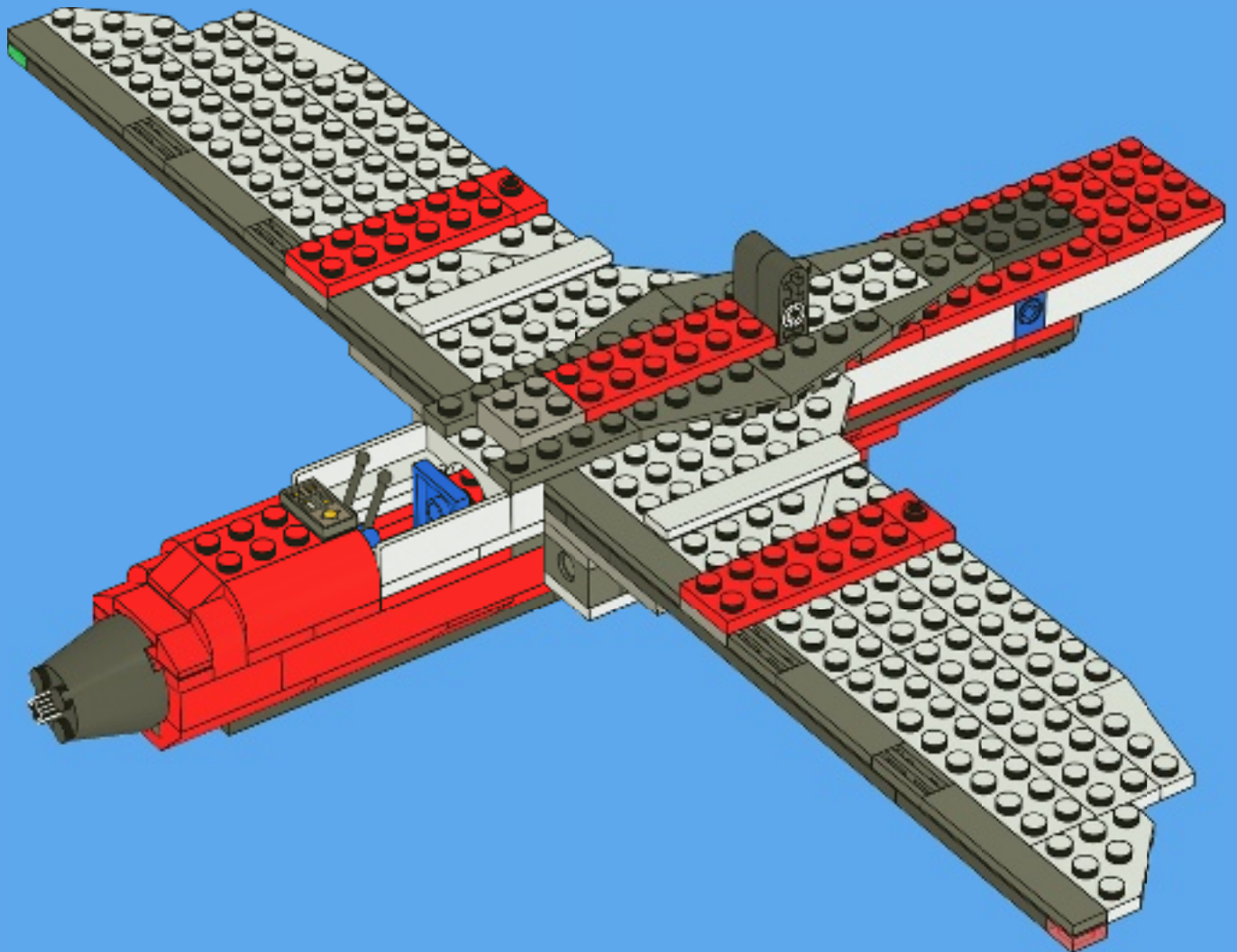

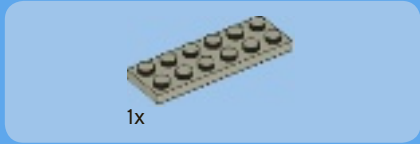
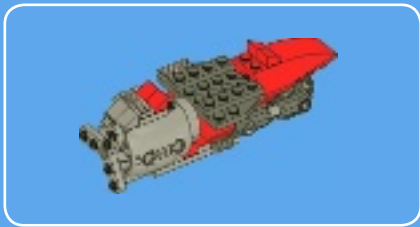

1

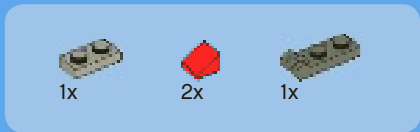

2

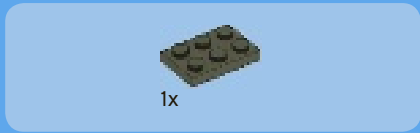
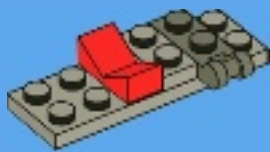

3

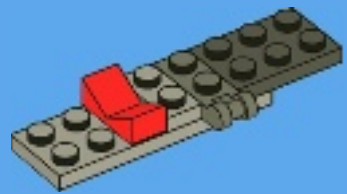

4

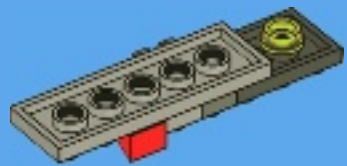



5

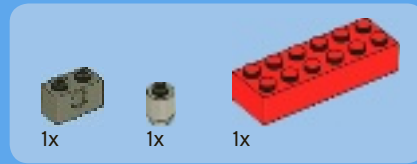
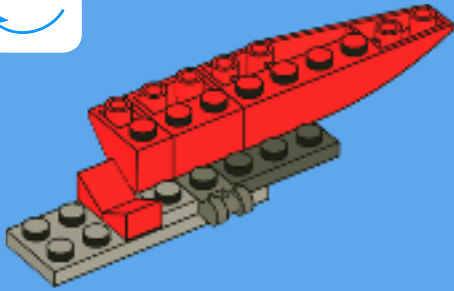

7

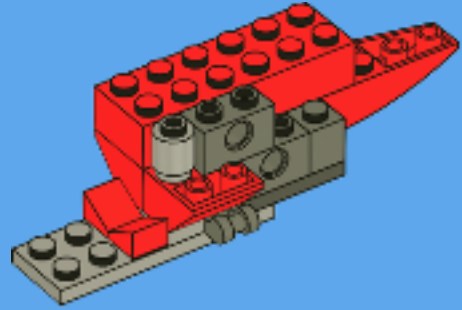

6

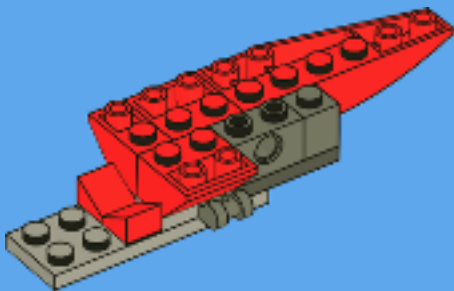

8

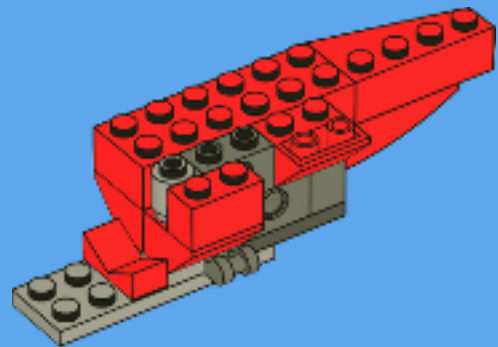

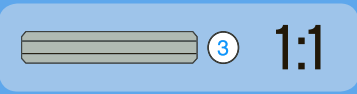

# 9

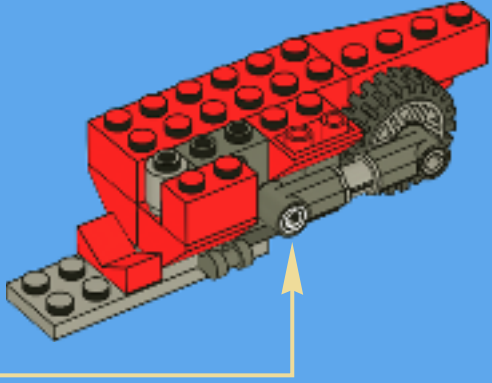
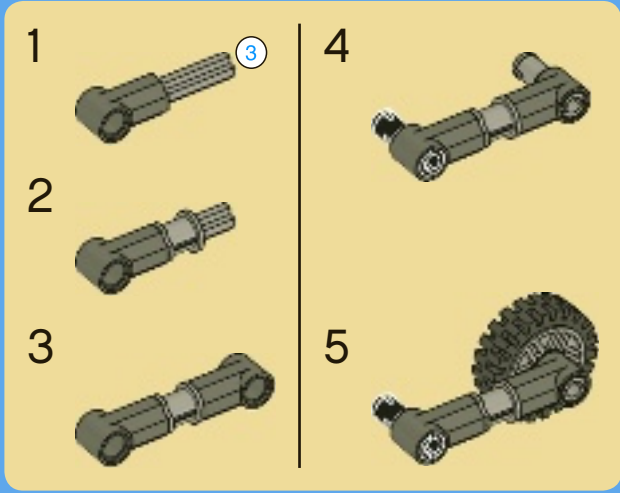

# 10

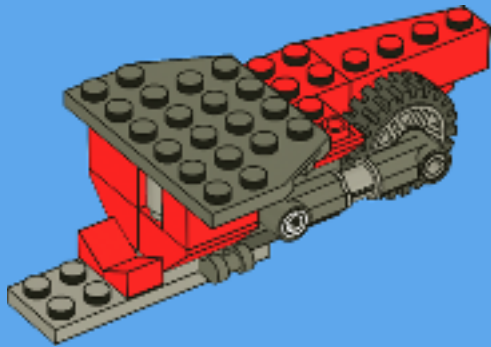



1x

11

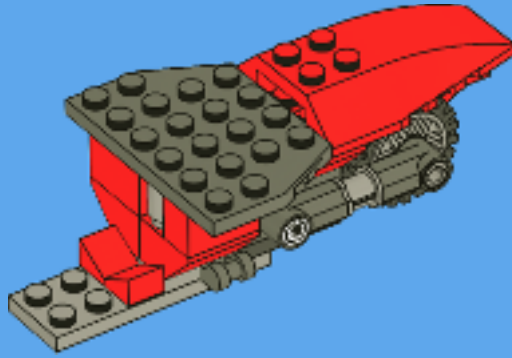

2x



1x



2x

12

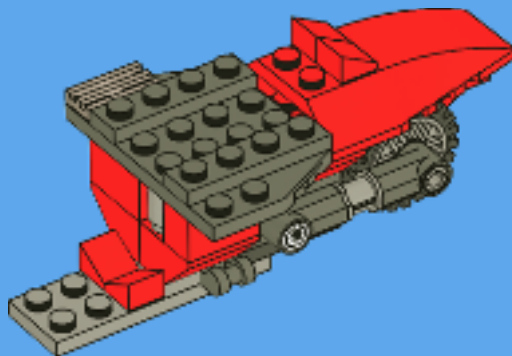

1x [Grey Technic 1x5 Round Technic Brick with 5 Holes]  
1x [Red Technic 1x2 Plate with 2 Holes]  
1x [Grey Technic 1x3 Round Technic Brick with 3 Holes]  
2x [Red Technic 1x2 Plate with 2 Holes]  
2x [Grey Technic 1x2 Plate with 2 Holes]  
1x [Grey Technic 1x2 Round Technic Brick with 2 Holes]  
1x [Grey Technic 1x2 Round Technic Brick with 2 Holes]  
1x [Grey Technic 1x2 Round Technic Brick with 2 Holes]  
1x [Grey Technic 1x2 Round Technic Brick with 2 Holes]

13

1



2



3



1 [Grey Technic 1x2 Round Technic Brick with 2 Holes] → [Red Technic 1x2 Plate with 2 Holes]  
2 [Grey Technic 1x2 Round Technic Brick with 2 Holes] → [Grey Technic 1x2 Round Technic Brick with 2 Holes] → [Grey Technic 1x2 Round Technic Brick with 2 Holes]

4

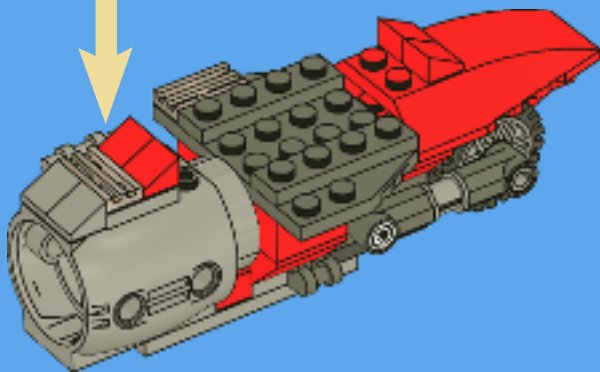
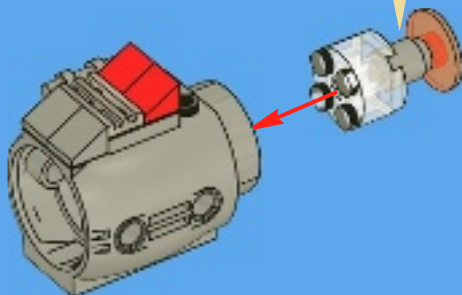





1x



1x

14

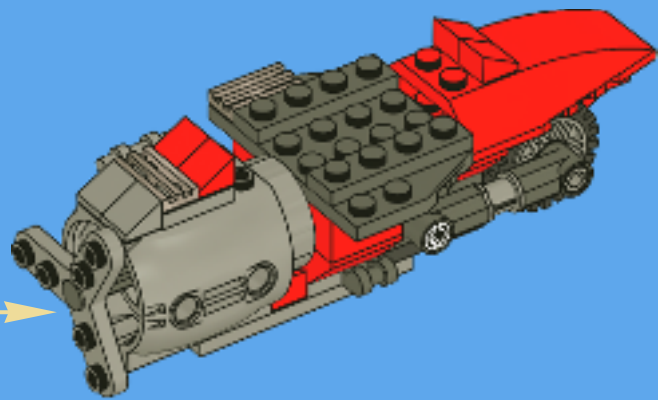
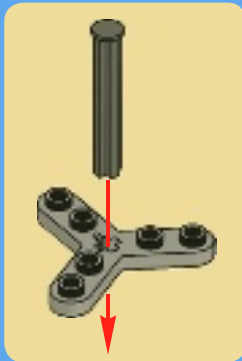

36

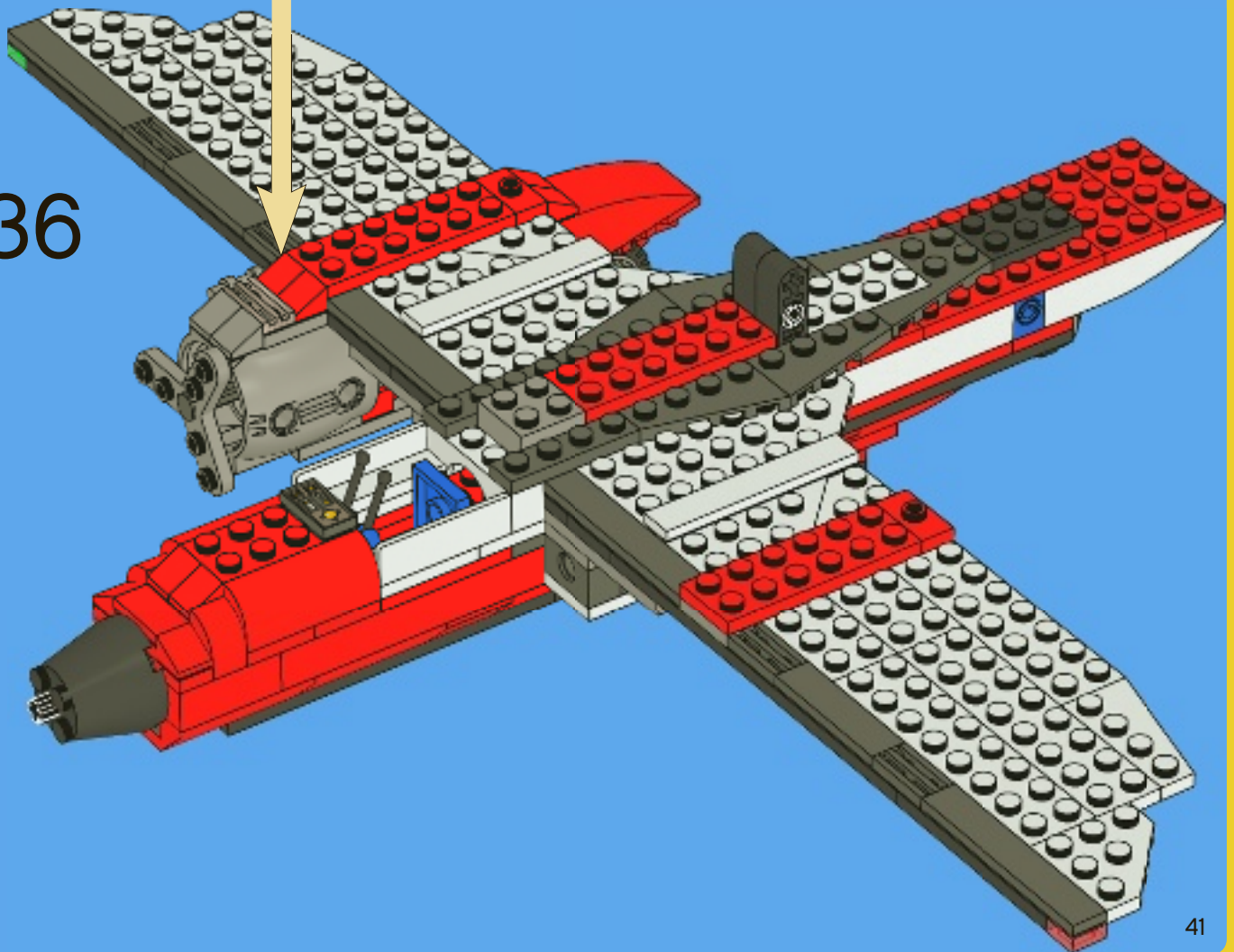

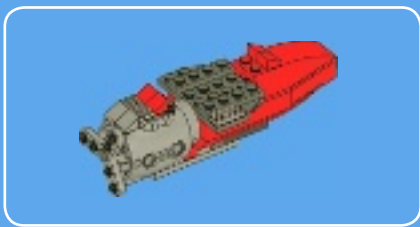

1x

1

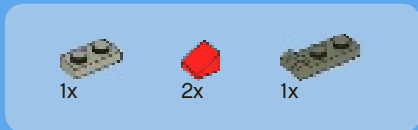

1x

2x

1x

2

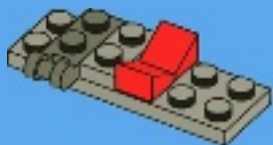

1x

3

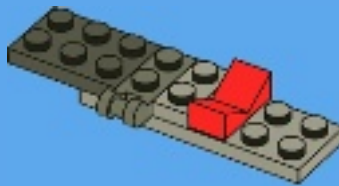

1x

4

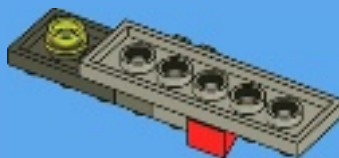

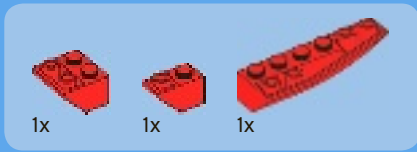

5

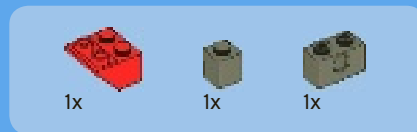
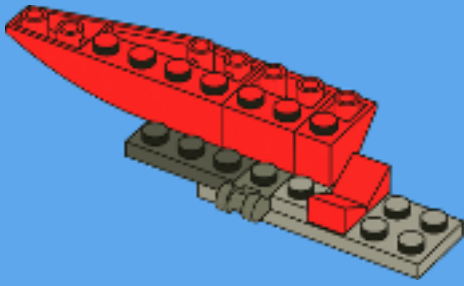

6

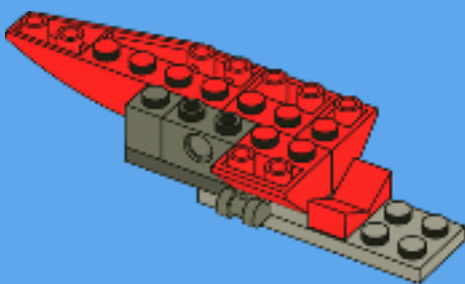

7

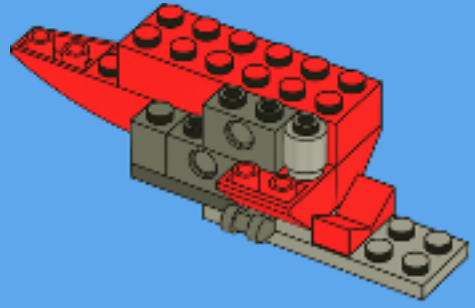

8

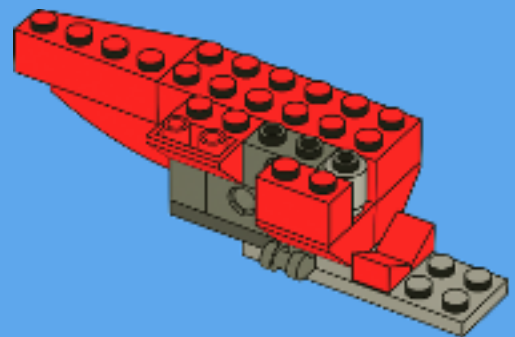

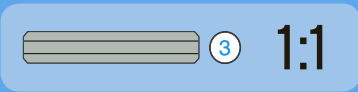
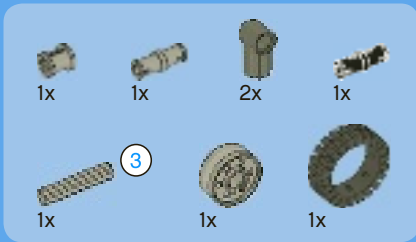

# 9

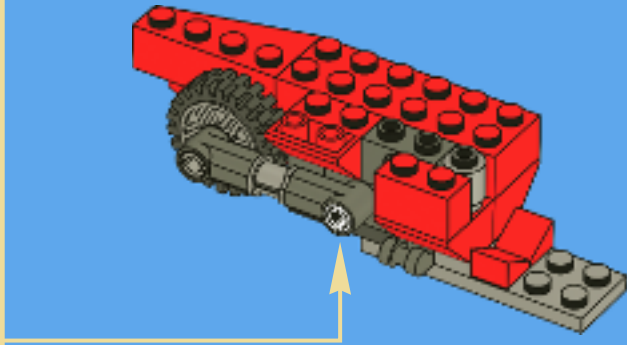
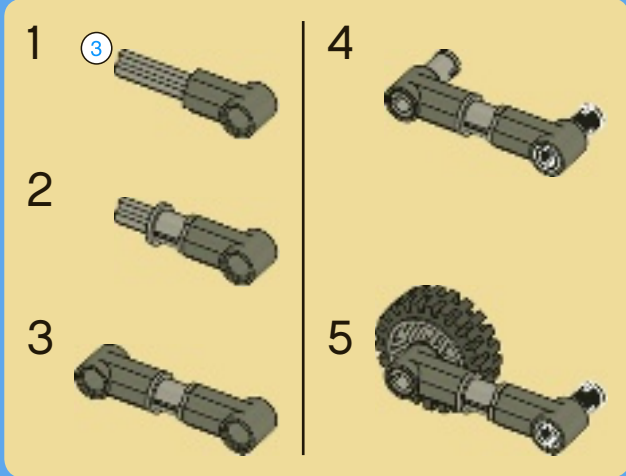

# 10

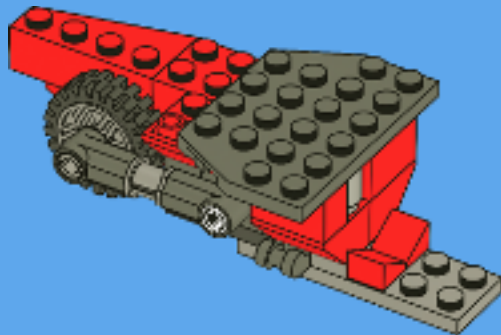



1x

11

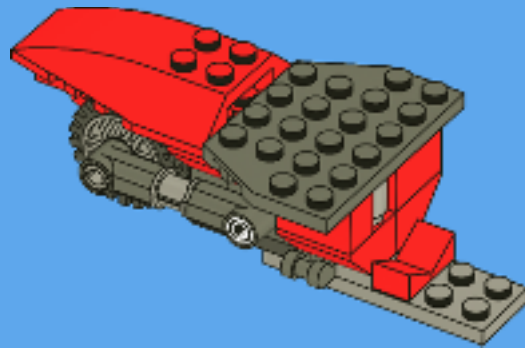

2x



1x



2x

12

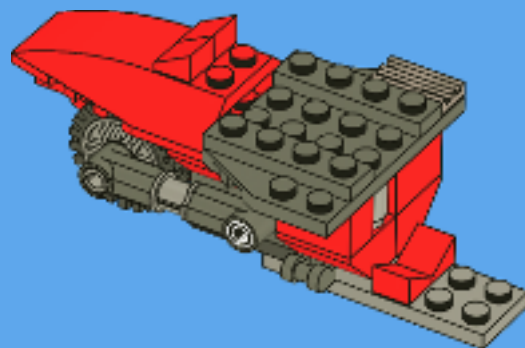



13

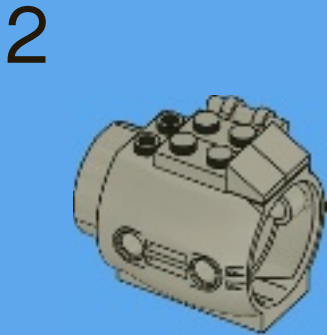

3

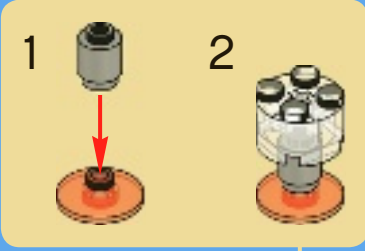
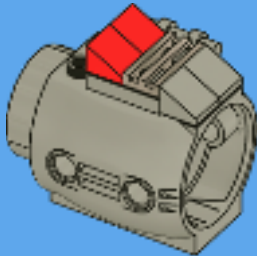

4

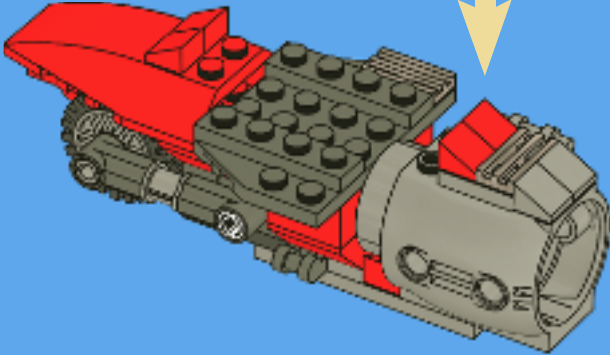
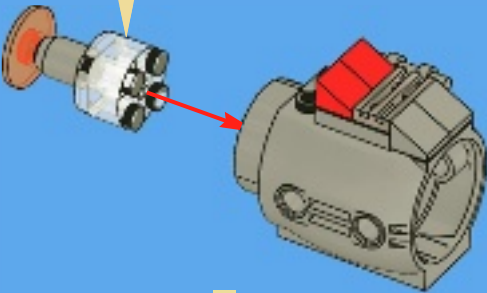



1x



1x

14

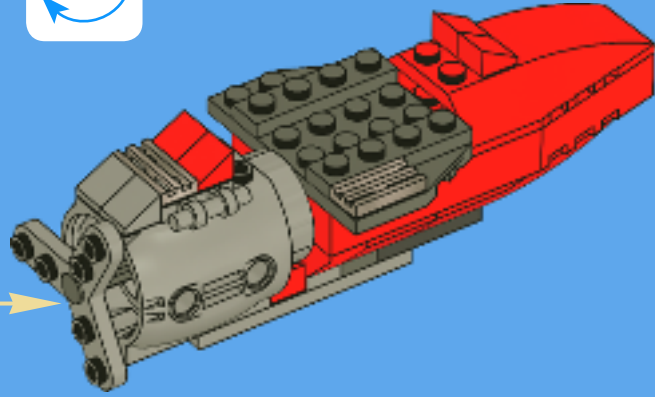
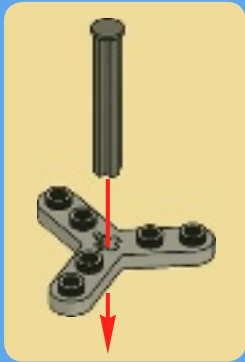

37

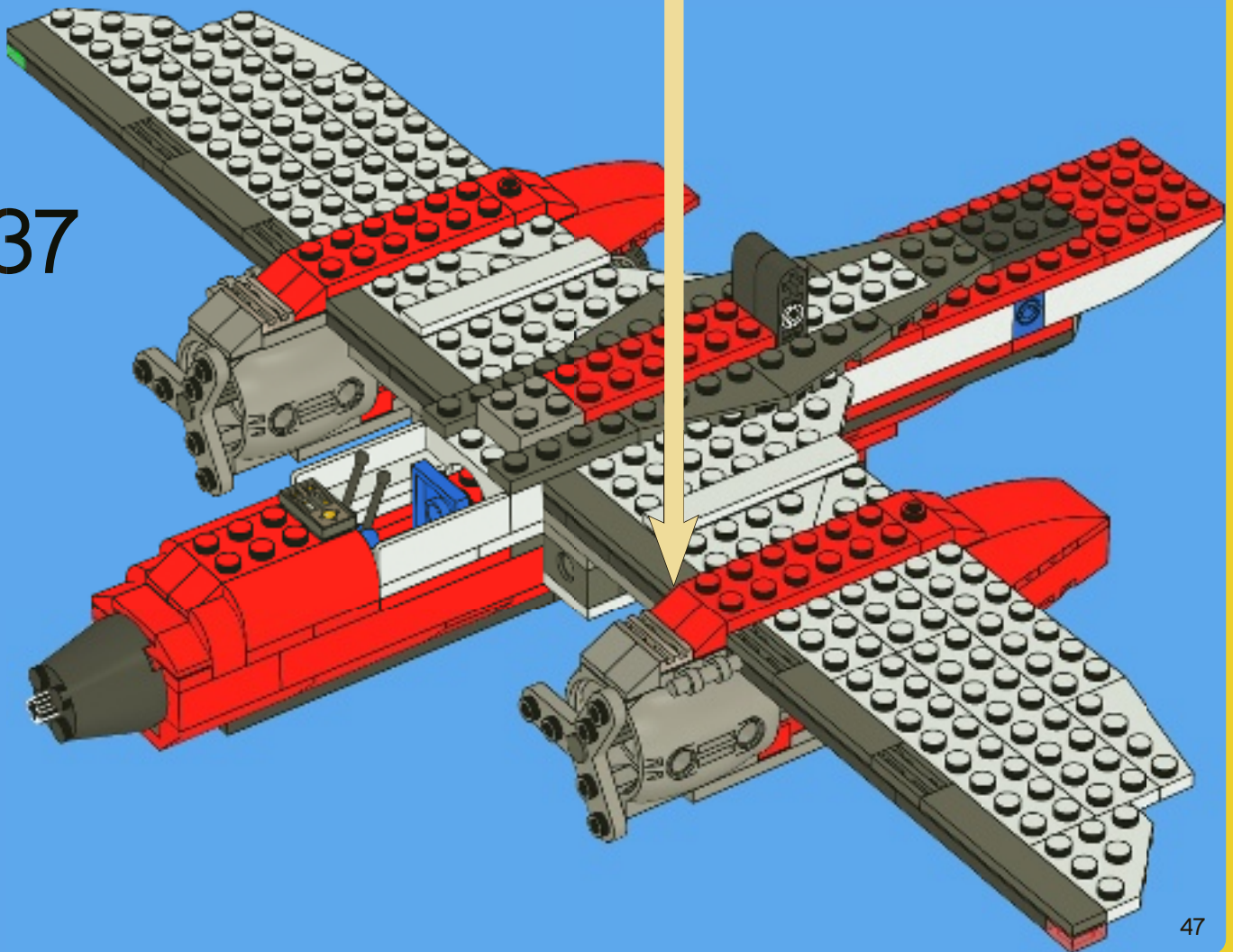

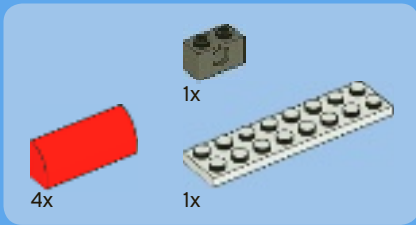

# 38

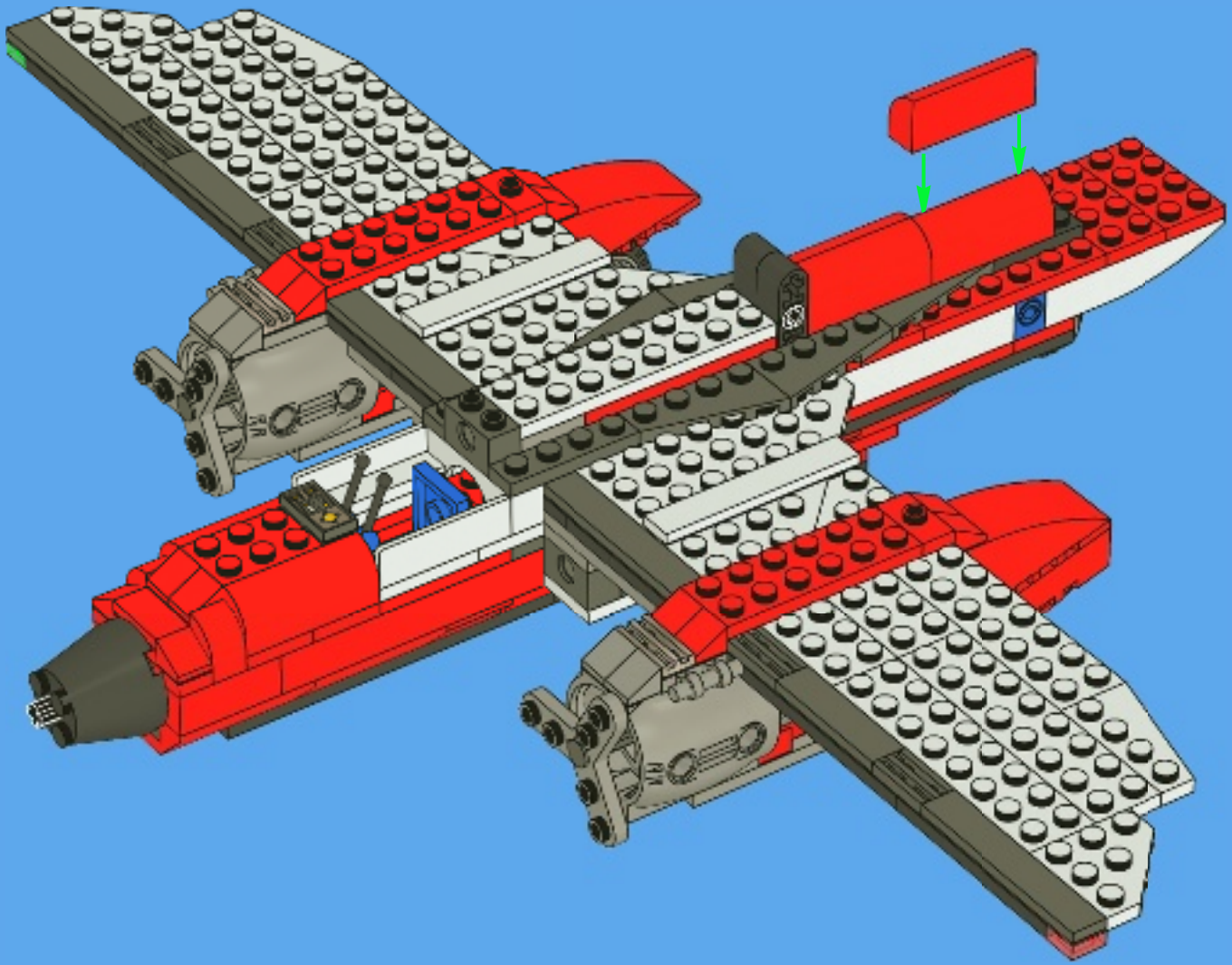





2x



4x



2x

# 39

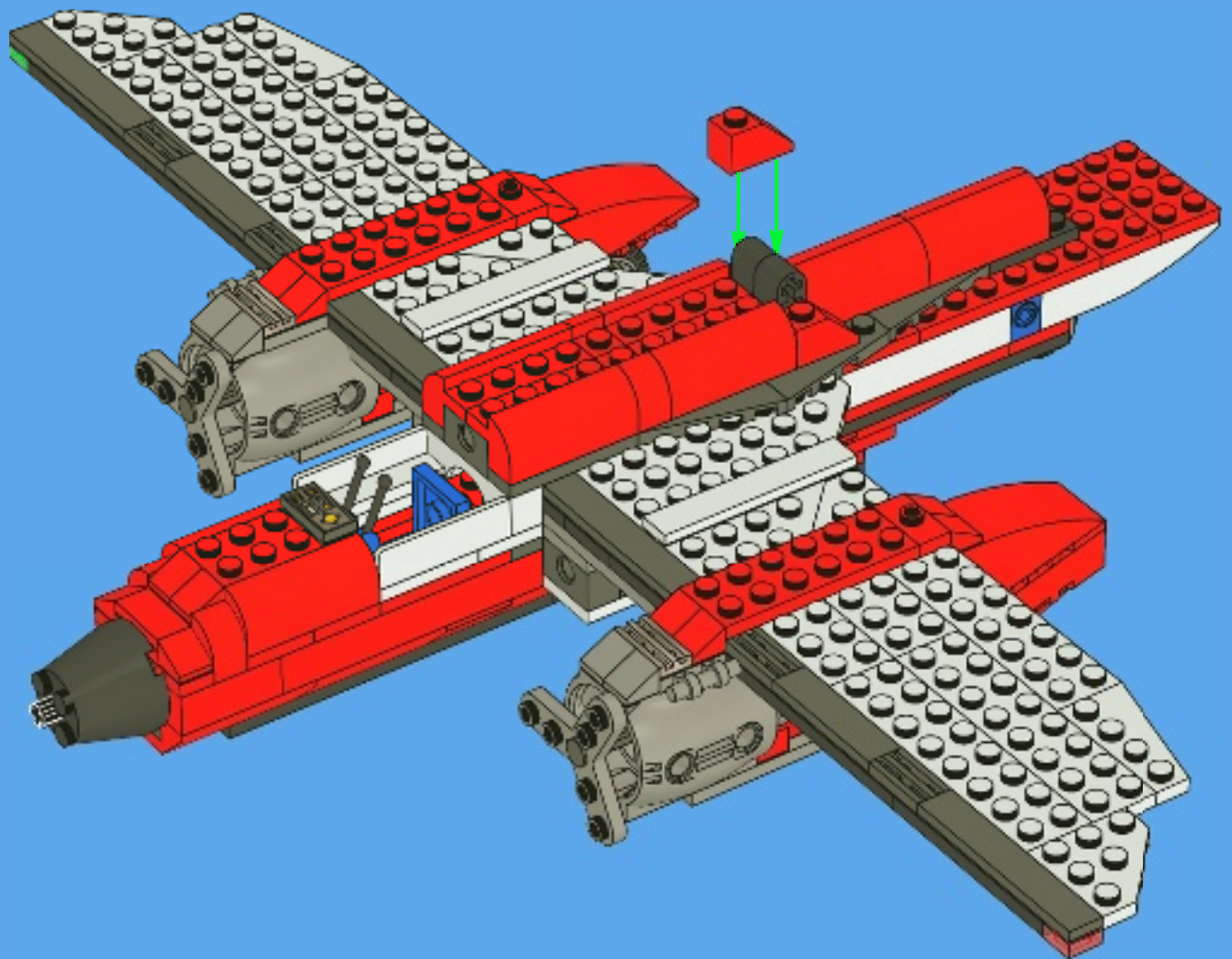

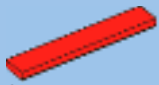

2x



1x



2x

# 40

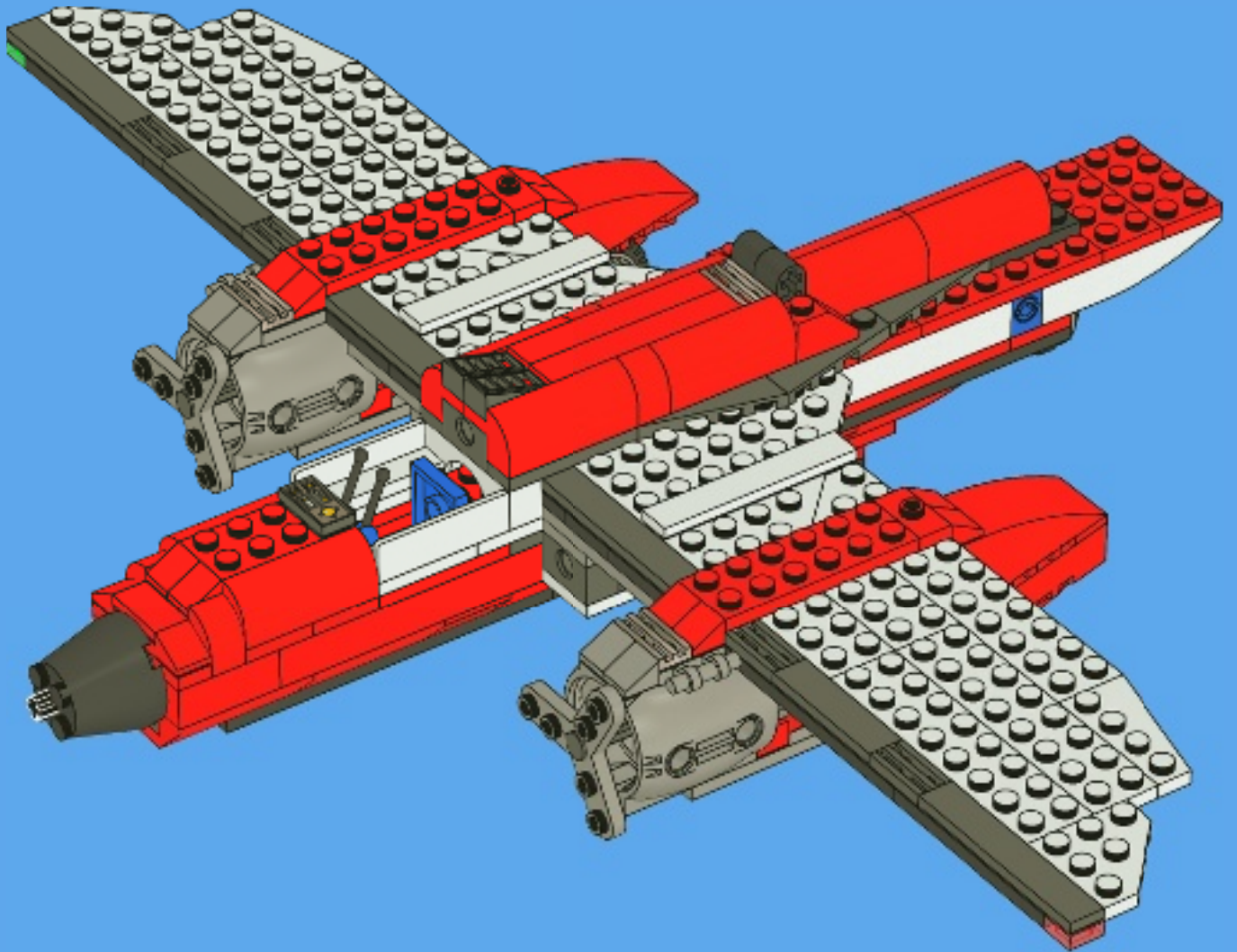



1x

41

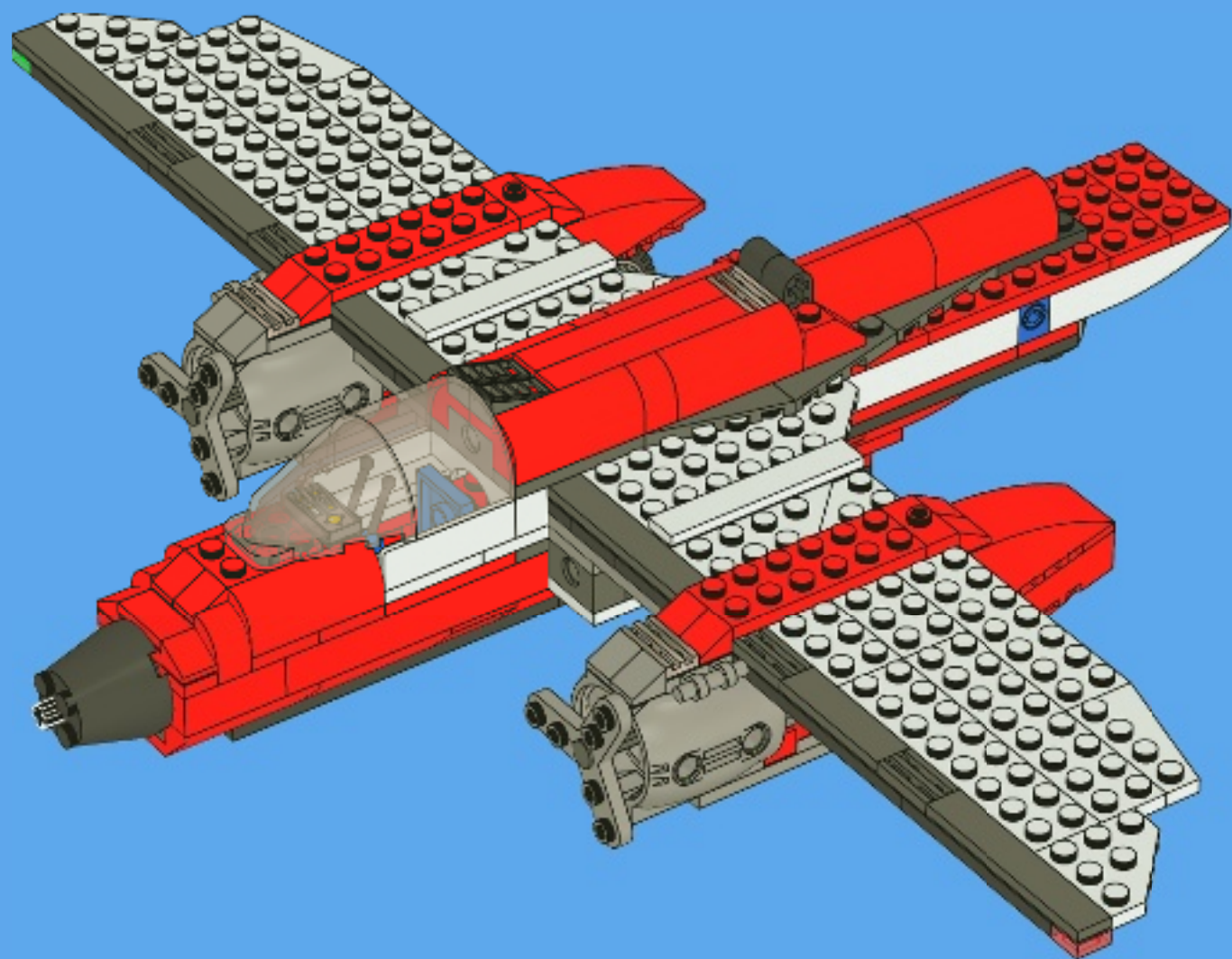



1

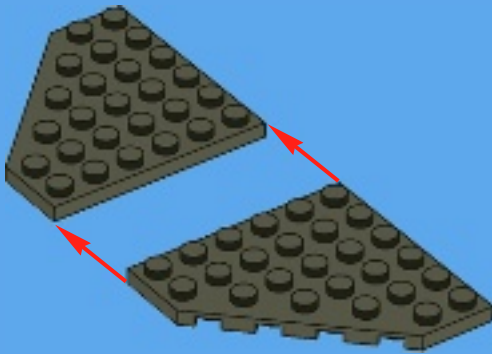

2



3



4

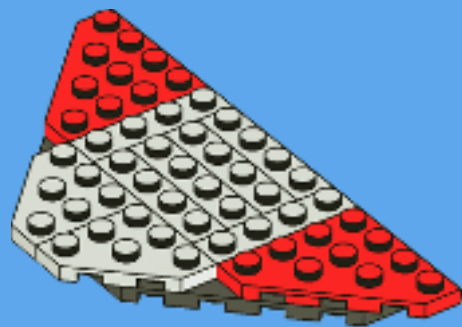



1x



2x



2x



7x

5

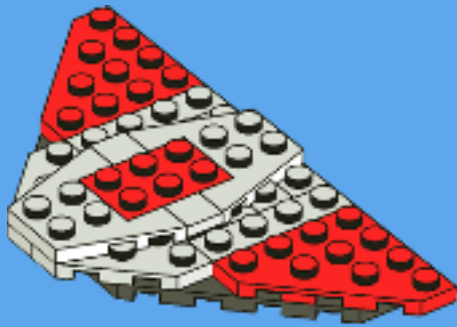

6

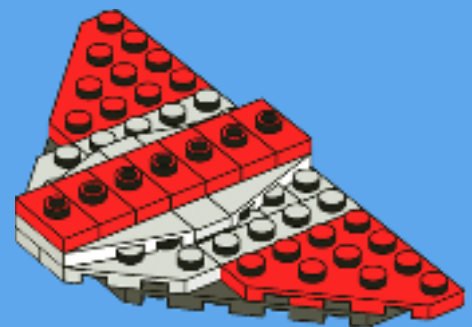

42

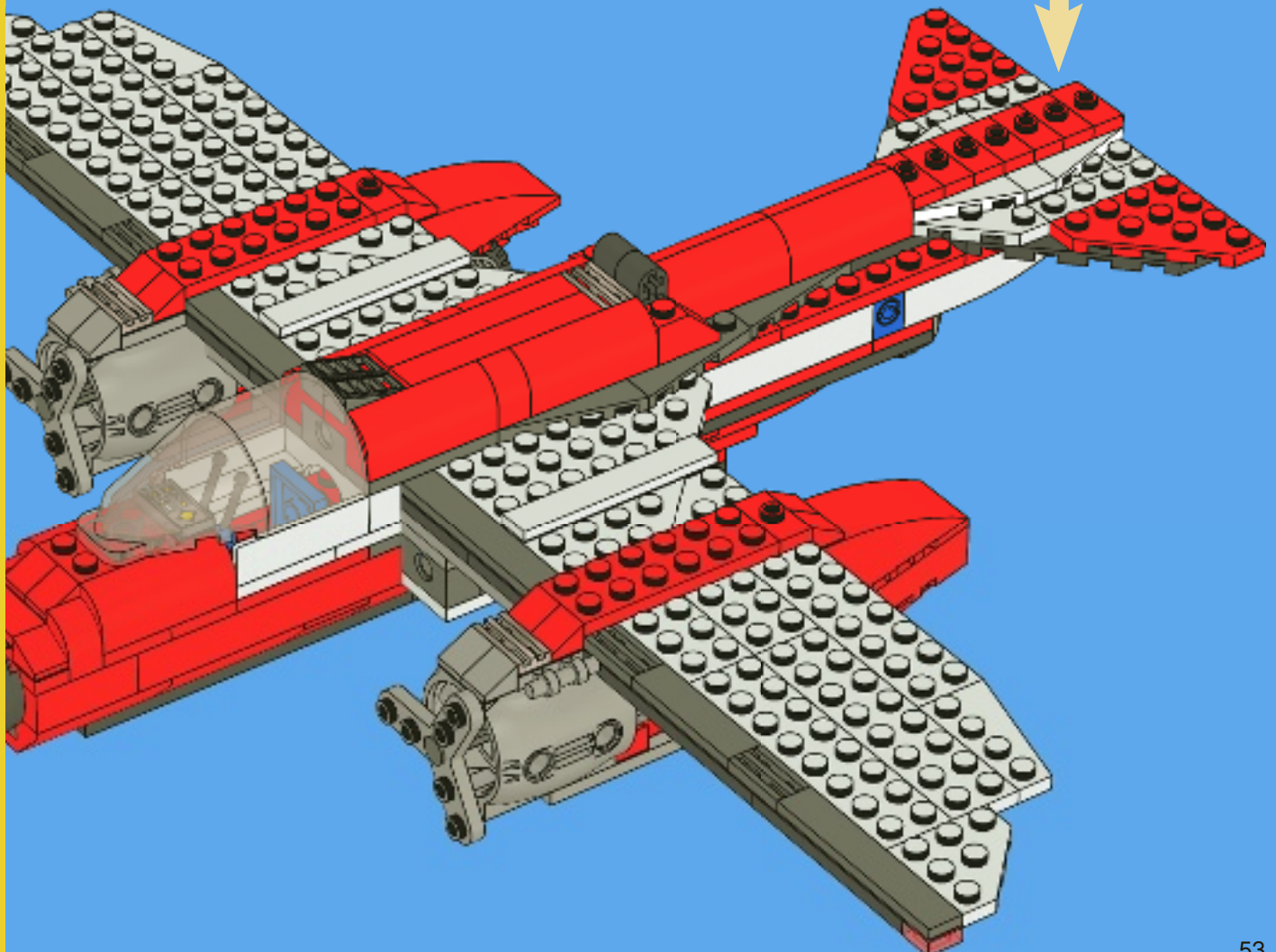



1

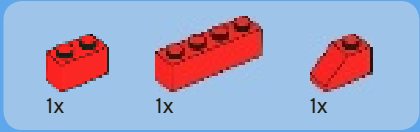
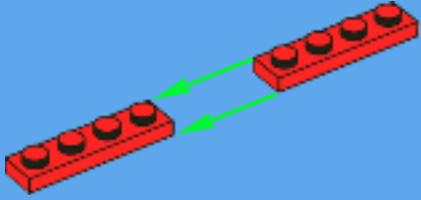

2

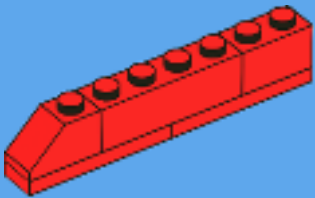

3

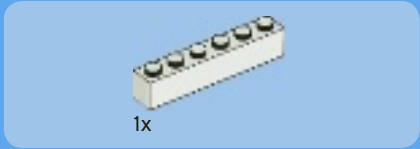
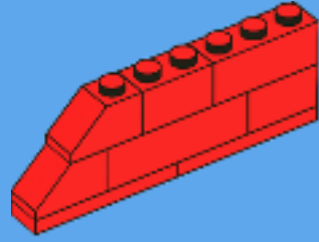

4

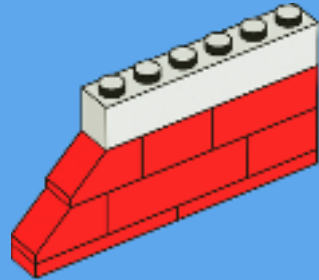



1x



1x

5

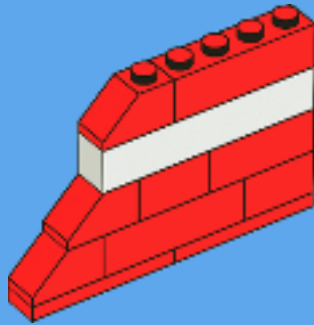

1x



1x



1x

6

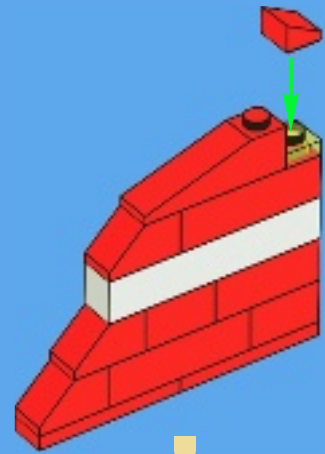

43

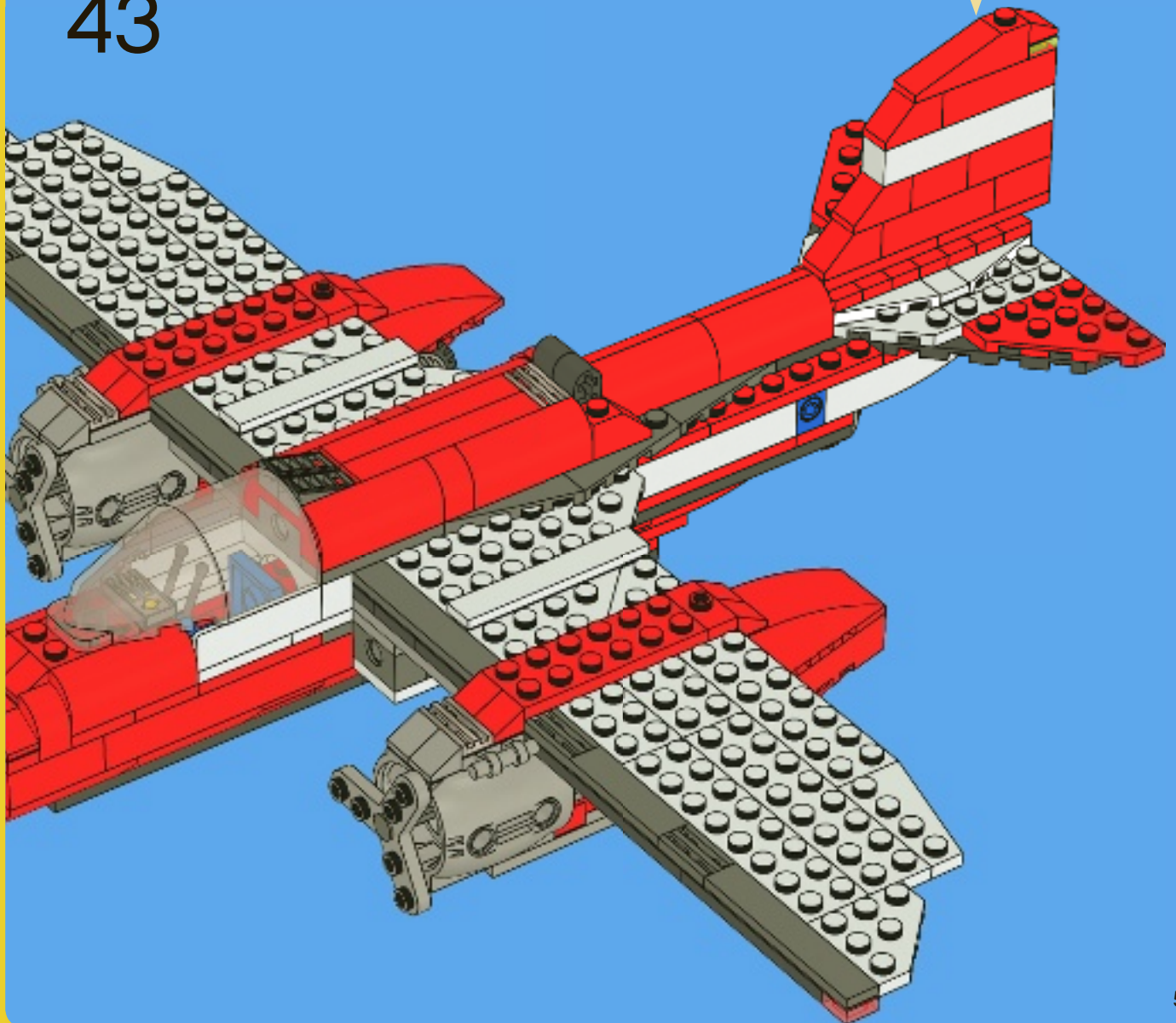

44

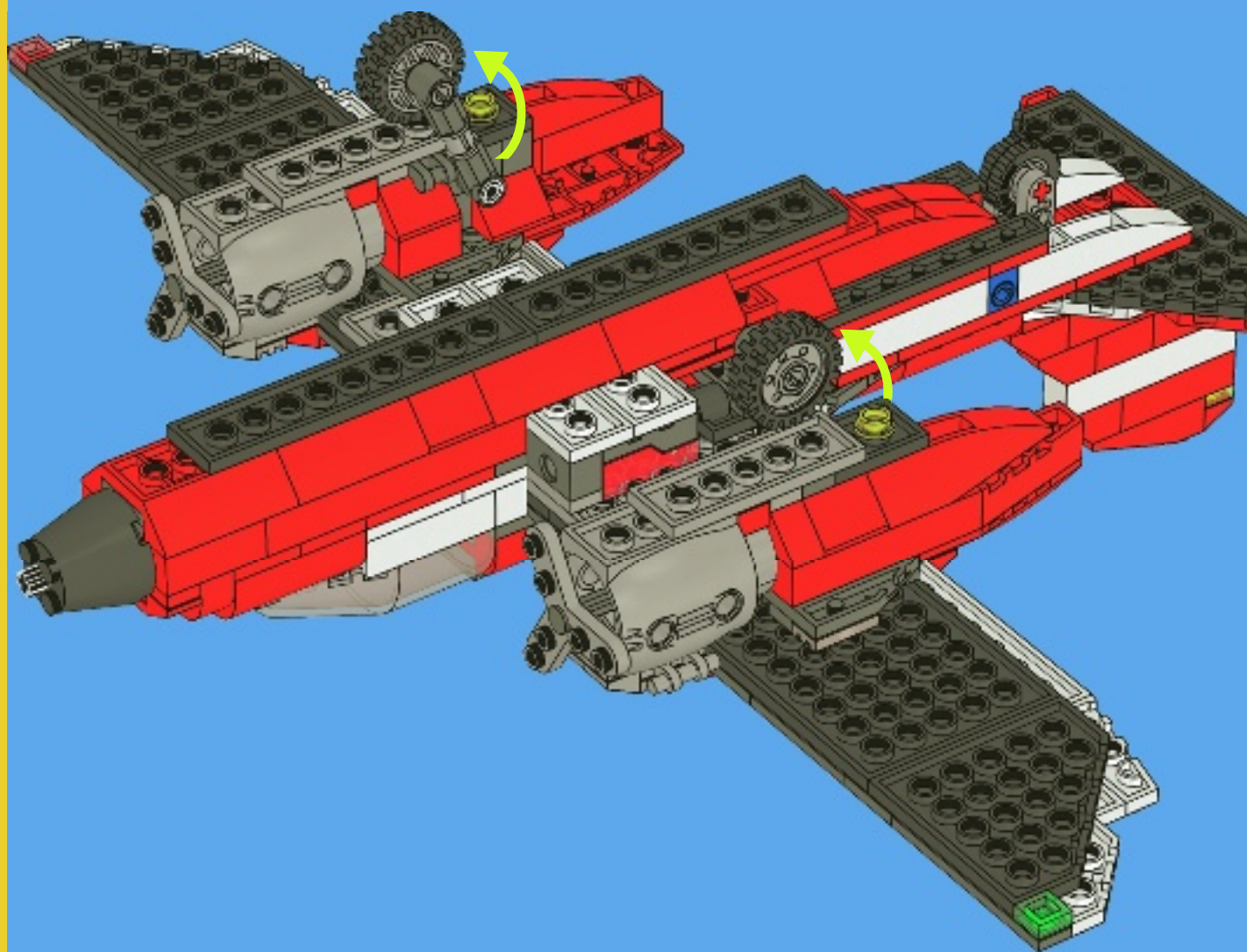





6x

# 45

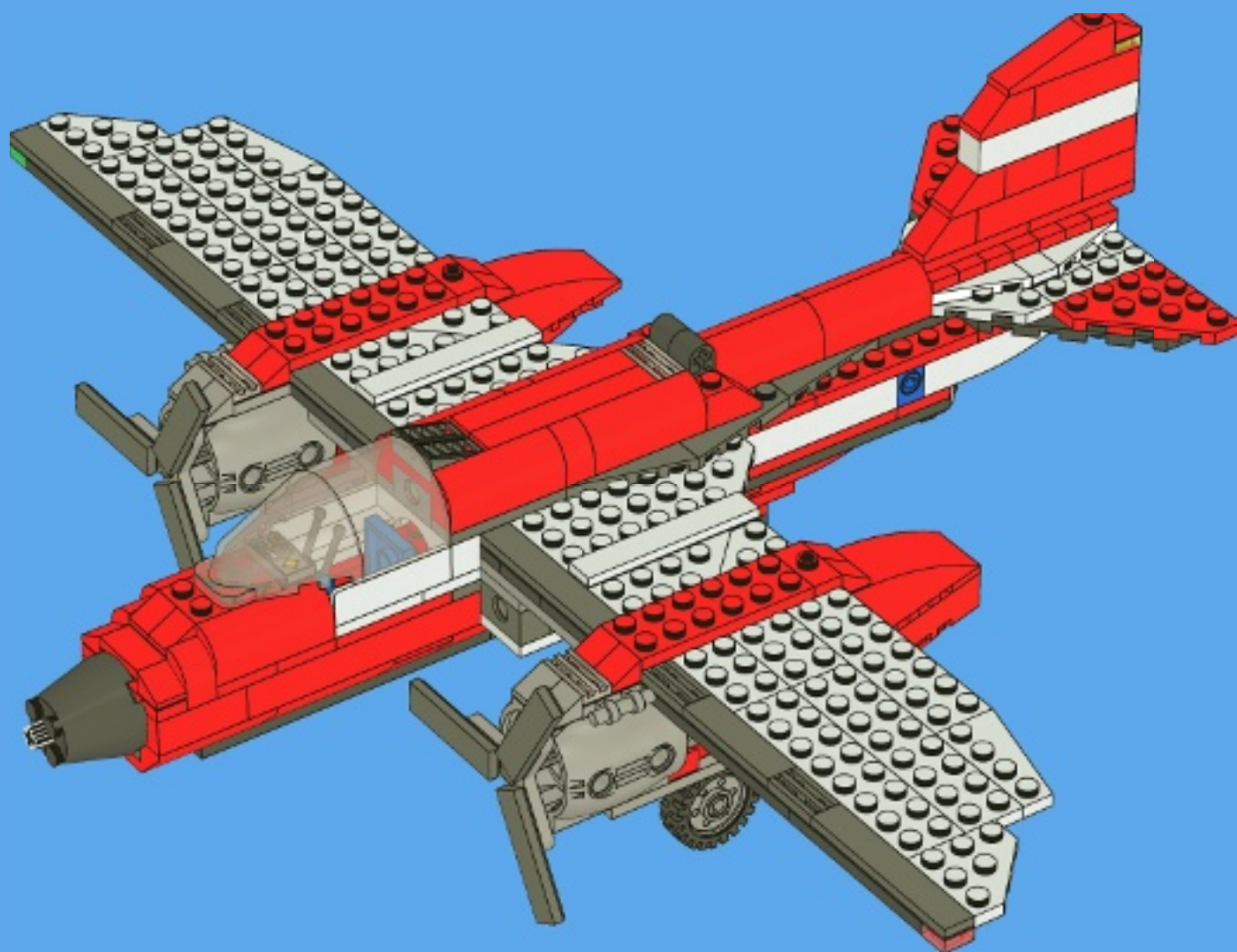

3x  
300401



5x  
300901



2x  
300801



2x  
4143254



2x  
4504369



2x  
365901



3x  
4518992



2x  
4160403



1x  
4179869



5x  
307001



4x  
362301



4x  
302101



8x  
371001



3x  
302001



2x  
663601



9x  
303401



4x  
4515364



2x  
4501853



4x  
4585737



1x  
4161326



1x  
4160857



2x  
4238793



6x  
245001



2x  
623101



2x  
486501



2x  
4173477



2x  
4259940



2x  
300521



4x  
300421



3x  
362221



3x  
301021



6x  
4181138



2x  
300821



1x  
4160328



1x  
4160346



30x  
4504379



2x  
366521



8x  
4121934



2x  
303921



11x  
366021



1x  
4515360



4x  
485421



4x  
4550322



4x  
609121



6x  
4585963



6x  
4116617



2x  
4160406



1x  
4544431



1x  
4544432



2x  
4568967



4x  
306921



2x  
306821



8x  
242021



4x  
302121



6x  
243121



6x  
371021



8x  
302021



4x  
4113858



5x  
379521



3x  
303221



2x  
447721



10x  
379421



2x  
4565431



2x  
4178728



3x  
4142865



12x  
4121715



1x  
370526



1x  
394226



1x  
4500978



4x  
4495935



2x  
411998



1x  
4295400



6x  
244426



1x  
4515290



2x  
4541455



4x  
4515185



3x  
4120017



5x  
302126



4x  
366626



1x  
4243819



2x  
379526



8x  
4106977



2x  
395826



4x  
447726



2x  
383226



2x  
302826

4

12x  
4211094

8x  
4211001

9x  
4211053

4x  
4210651

2x  
4210998

2x  
4211119

4x  
4210631

2x  
4521187

4x  
4579354

3x  
4278274

2x  
4210782

2x  
4210788

2x  
4210788

1x  
4290149

1x  
4290150

3x  
4211098

10x  
4211111

2x  
4540386

2x  
4500975

4x  
4210719

1x  
4221879

2x  
4210980

2x  
4210749

4x  
4210658

2x  
4560177

4x  
4561036

2x  
4521572

2x  
4581452

1x  
4233484

2x  
4173666

2x  
4211815

1x  
4211639

4x  
4211452

2x  
4514846

1x  
4293831

4x  
4211660

4x  
4211412

4x  
4521921

10x  
4211398

2x  
4558169

2x  
4211632

2x  
4499259

2x  
4211767

4x  
4211574

1x  
4512360

2x  
4262978

2x  
4560175

2x  
4211622

1x  
4211758

2x  
4211807

3x  
4211387

1x  
4211795

2x  
4186017

4x  
4234365

2x  
4119014

2x  
4500613

2x  
395623

2x  
4296152

2x  
4143005

8x  
4206482

4x  
4514553

6x  
4249040

2x  
3006840

2x  
4143346

3x  
3000841

2x  
4294909

4x  
3000844

4x  
3005744

2x  
3006347

1x  
4217436

Customer Service

Kundenservice

Service Consommateurs

Servicio Al Consumidor

www.lego.com/service or dial

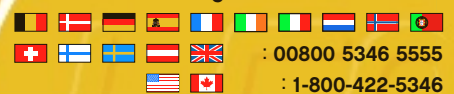

: 00800 5346 5555

: 1-800-422-5346





# CREATOR



5893





# CREATOR



# 3 IN 1

## Upload your own model

LEGO® Creator gives you instructions for 3 great models in every box!

What can you create? Make your own model and upload it to the online Creator gallery.

Check out all of the Creator models and downloads on our cool site.

You can also ask a designer a question and find out what's going on in the Creator blog.

Check it out at [www.creator.LEGO.com](http://www.creator.LEGO.com).

### Lade dein eigenes Modell hoch

Bei LEGO® Creator findest du in jedem Set Anleitungen für drei tolle Modelle!

Probiere doch einfach alle aus oder baue dein eigenes Modell und zeige es deinen Freunden in der Online Creator Galerie.

Auf der LEGO® Creator Seite findest du alle Modelle und viele tolle Downloads.

Du kannst sogar einem Designer Fragen stellen und lesen, was unsere Designer schon alles im Creator Blog geschrieben haben. Gehe online unter [www.creator.LEGO.com](http://www.creator.LEGO.com).

### Télécharge ton propre modèle

Chaque boîte LEGO® Creator contient des instructions de montage pour construire 3 modèles passionnants!

Tu as construit un super modèle que tu souhaites montrer ? Télécharge et expose ta propre construction dans la galerie en ligne du site Creator.

Va vite découvrir tous les modèles Creator et les super fonds d'écran à télécharger sur le site [www.creator.LEGO.com](http://www.creator.LEGO.com). Tu peux même poser des questions aux concepteurs et surfer sur le blog Creator.

### Envía tu propio modelo

¡LEGO® Creator contiene instrucciones para 3 fantásticos modelos en cada caja!

¿Qué quieres crear? Crea tus propios modelos y envíalos a la galería en línea de Creator.

Ven a ver todos los modelos y descargas Creator en nuestro sitio web. También podrás hacer preguntas a un diseñador e investigar las últimas novedades en el blog de Creator. Compruébalo en [www.creator.LEGO.com](http://www.creator.LEGO.com).

### Faz o upload do teu modelo

LEGO® Creator dá-te instruções para 3 fabulosos modelos em cada caixa!

O que podes criar? Constrói o teu próprio modelo e faz o upload do mesmo para a galeria online Creator.

Consulta todos os modelos Creator e possibilidades de download no nosso super-fantástico site. Também podes colocar uma questão a um designer e descobrir o que se passa no blog Creator. Vai já a [www.creator.LEGO.com](http://www.creator.LEGO.com).

### Tedd fel a netre saját modelledet

Minden doboz LEGO® Creator-ban 3 remek modell összerakási útmutatóját találod!

Mit fogsz építeni? Készítsd el saját ötleteidet és töltsd fel a Creator galériába. Itt megnézheted mások alkotásait és érdekes, izgalmas dolgokat is letölthetsz magadnak.

Kérdéseket tehetsz fel és olvashatsz a Creator blogban a legújabb híreket. Kiklikelj és nézz körül itt: [www.creator.LEGO.com](http://www.creator.LEGO.com).

# [www.Creator.LEGO.com](http://www.Creator.LEGO.com)





# TECHNIC



8052

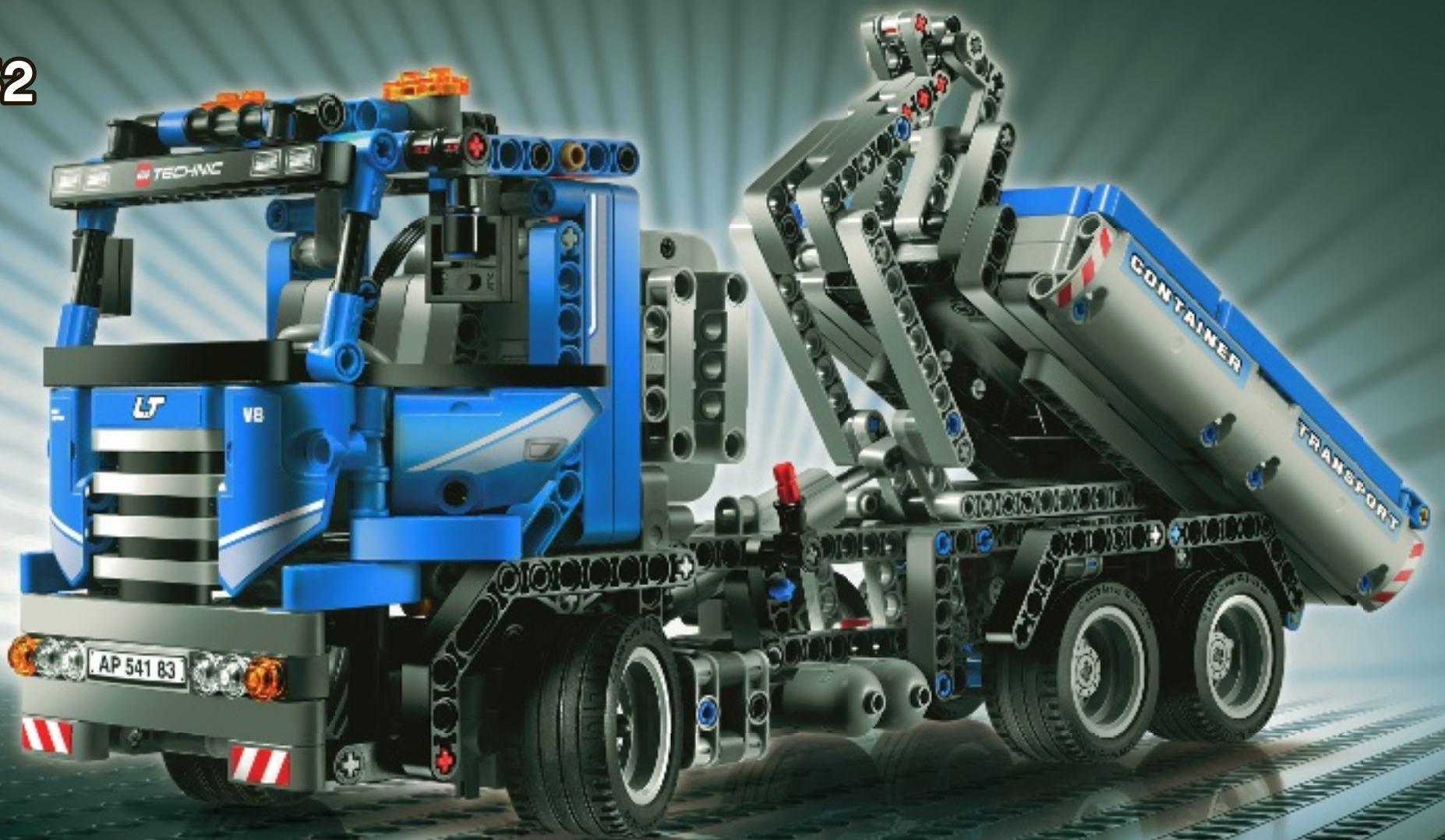



# WIN!

Go to [www.nielsen.com/LEGO](http://www.nielsen.com/LEGO) to fill out a survey for a chance to win a cool LEGO® Product. No purchase necessary. Open to all residents where not prohibited.

 [www.LEGO.com](http://www.LEGO.com)



## [www.nielsen.com/LEGO](http://www.nielsen.com/LEGO)

### GEWINNE!

Nimm an der Umfrage auf [www.nielsen.com/LEGO](http://www.nielsen.com/LEGO) teil und hab die Chance ein cooles LEGO® Produkt zu gewinnen!

Die Teilnahme am Gewinnspiel führt zu keinerlei Kaufverpflichtungen. Teilnahme in allen nicht ausgeschlossenen Ländern möglich.

4629896

### WIN!

Ga naar [www.nielsen.com/LEGO](http://www.nielsen.com/LEGO), vul een enquêteformulier in en maak kans op een cool LEGO® product.

Geen aankoopverplichting. Iedereen mag deelnemen, uitgezonderd ingezetenden van landen waar een enquêteverbod geldt.

### GAGNE !

Visite [www.nielsen.com/LEGO](http://www.nielsen.com/LEGO) pour répondre à un questionnaire et avoir une chance de gagner un produit LEGO® très cool !

Aucune obligation d'achat. Ouvert à tous les résidents des pays autorisés.

### 当てよう!

[www.nielsen.com/LEGO](http://www.nielsen.com/LEGO)にアクセスして、アンケートにご記入ください。当選者にはレゴ®製品を差し上げます。

お買い上げの必要はありません。禁止されていない限り、すべての皆様にご利用いただけます。