

LEGO

DINO 

5887

 1



1

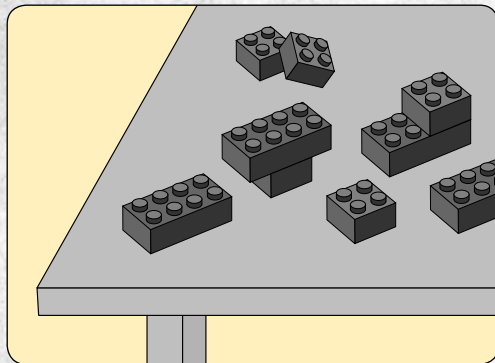
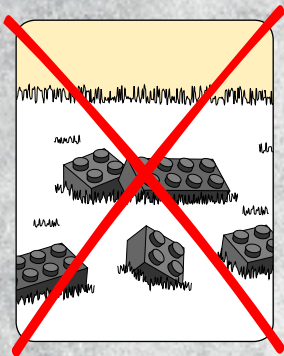

2

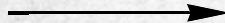

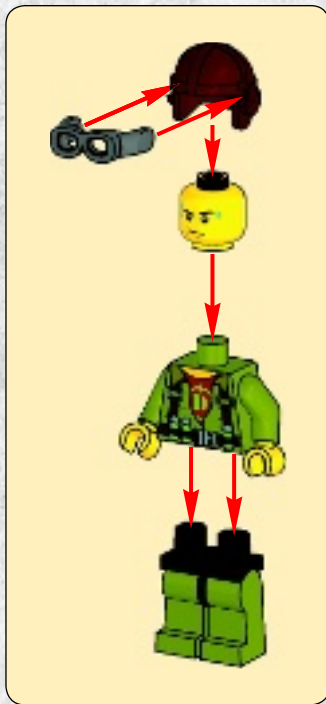

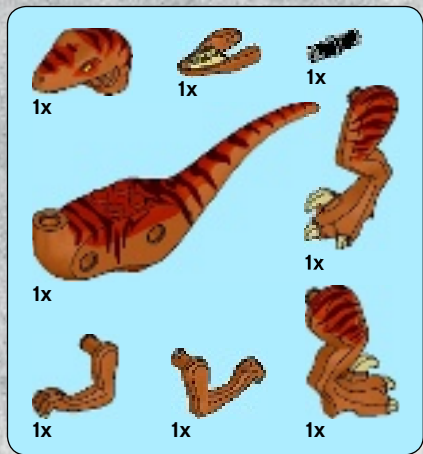

2



3



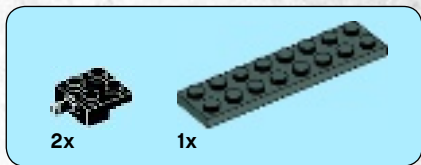

1

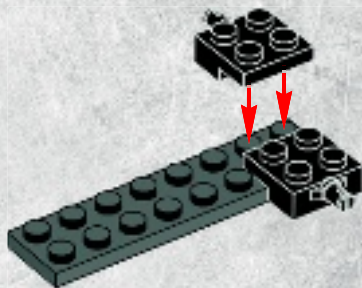



2x

2

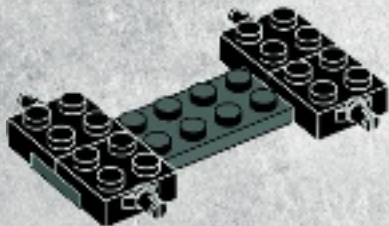

2x

3

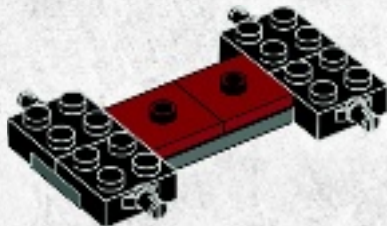

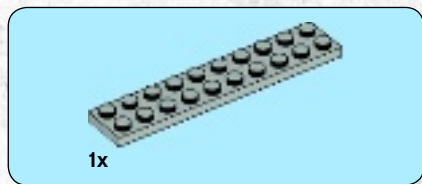

4

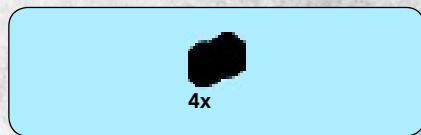
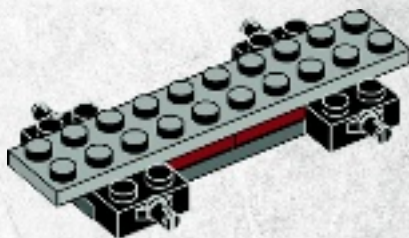

5

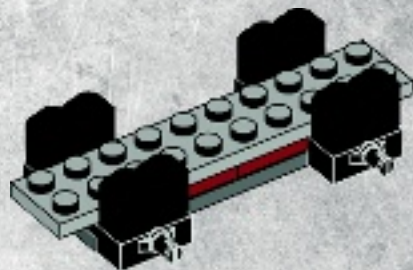



6

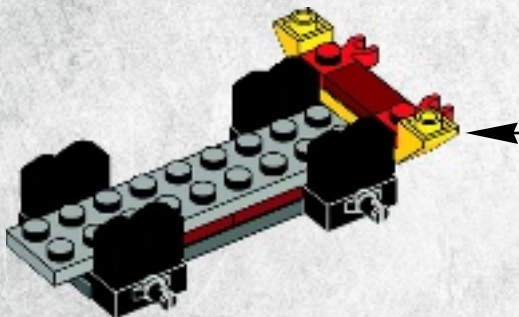
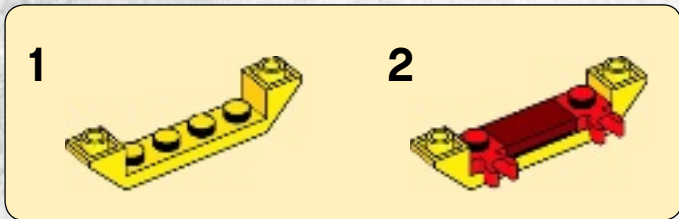

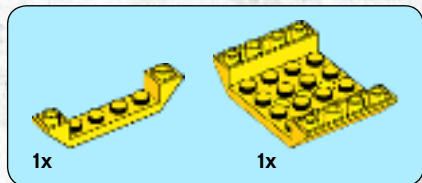

7

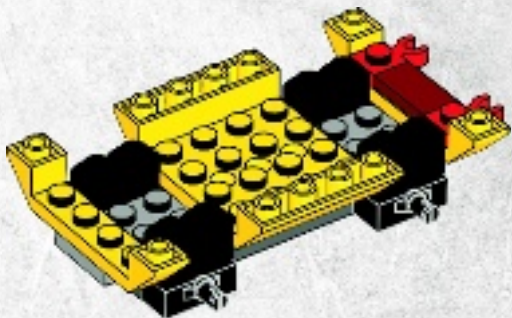

8

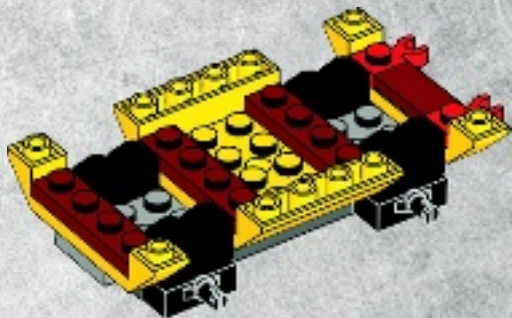



2x

9

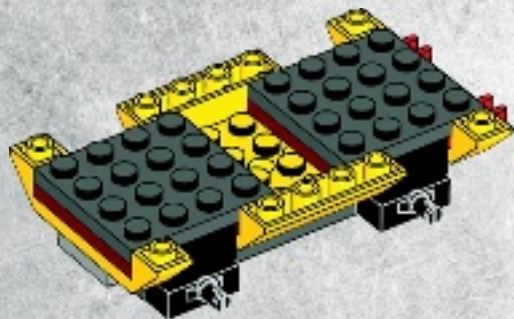

10



2x

10

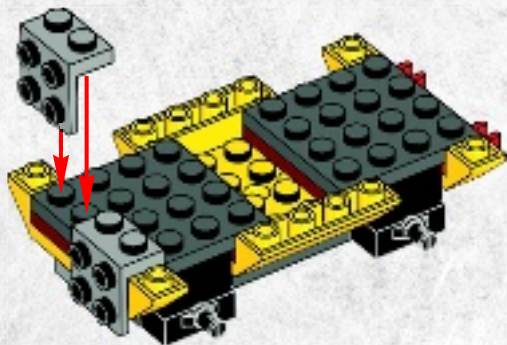



1x



1x

11

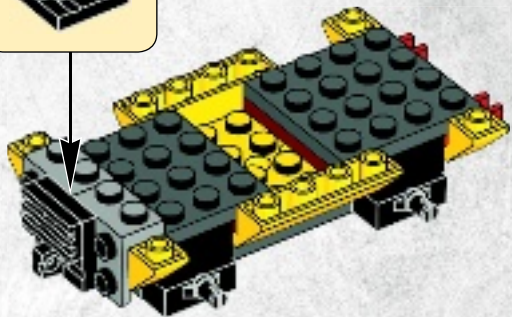
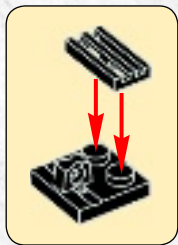

1x



4x

12

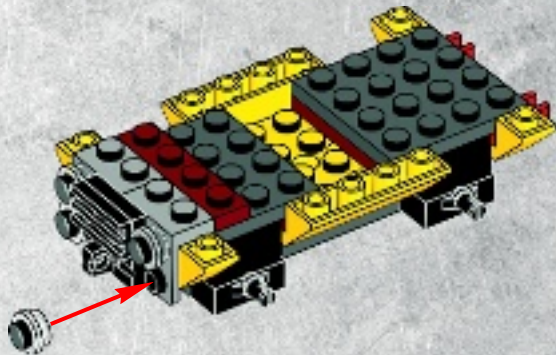



2x



2x

13

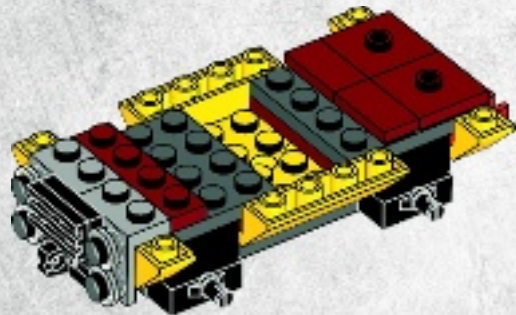



14

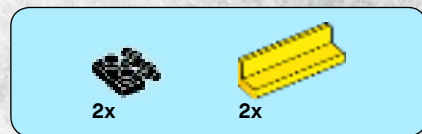
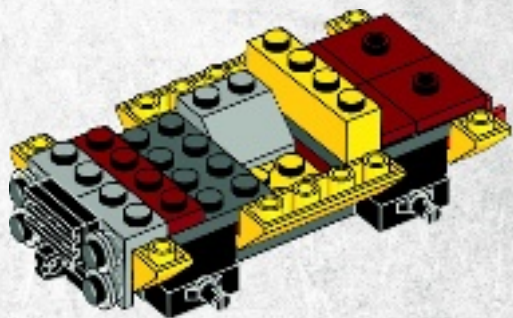

15

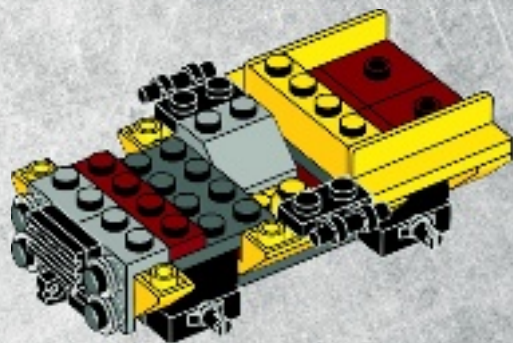



1x



2x

16

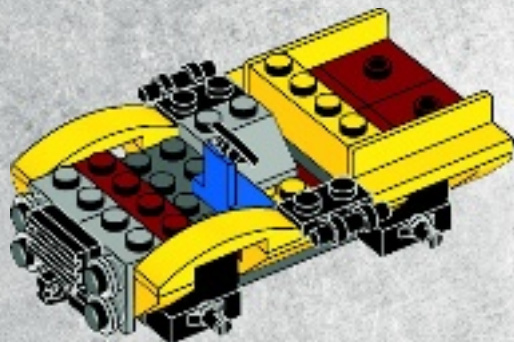

1x



1x

17

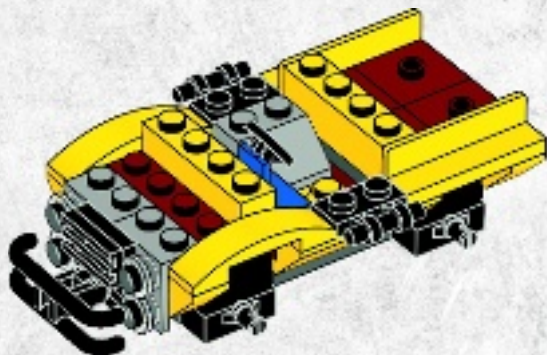



1x

18

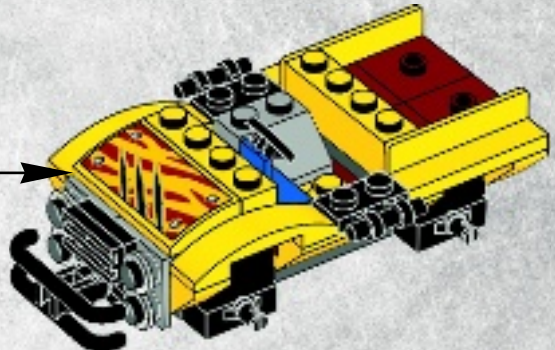
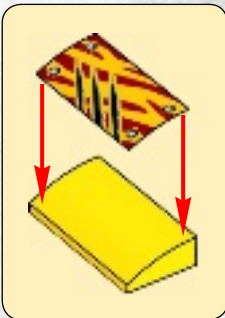



1x



2x

19

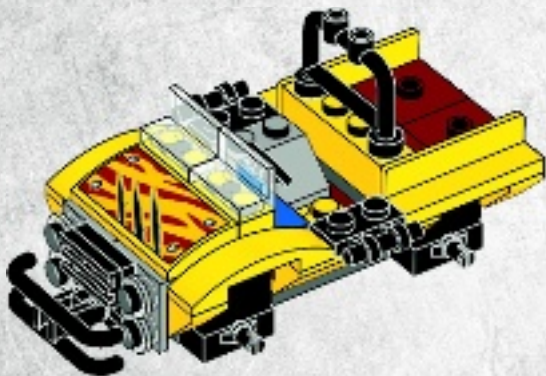



1x



1x



1x

20

1



2

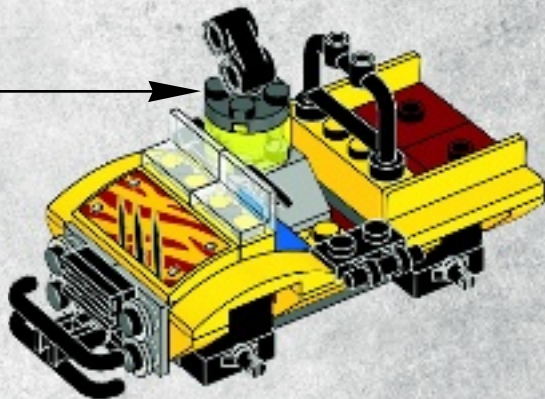

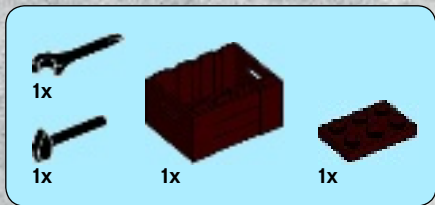

21

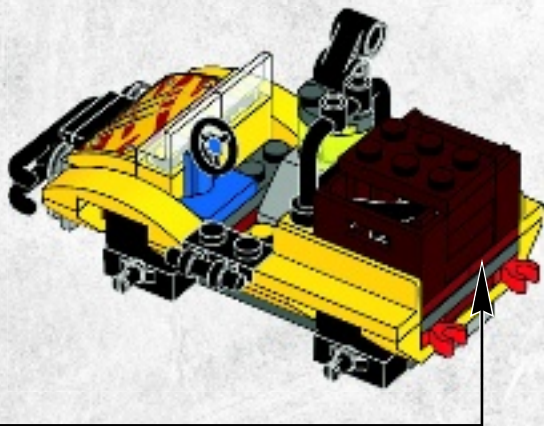
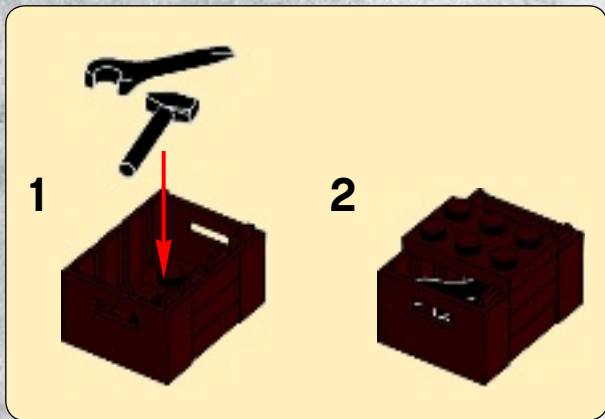



1x



4x



4x

22

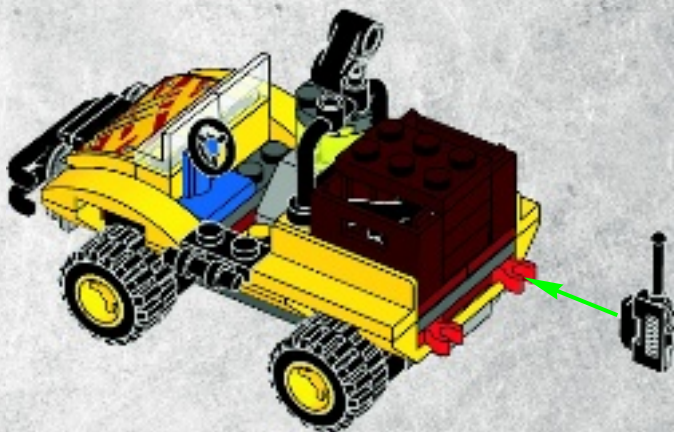



23

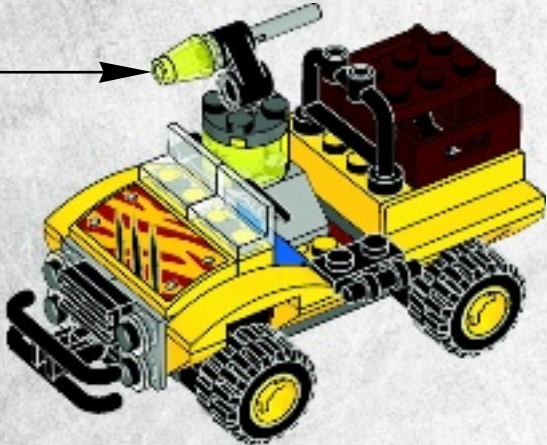
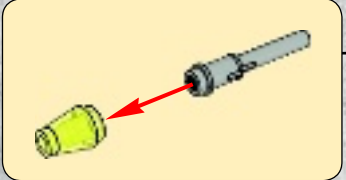
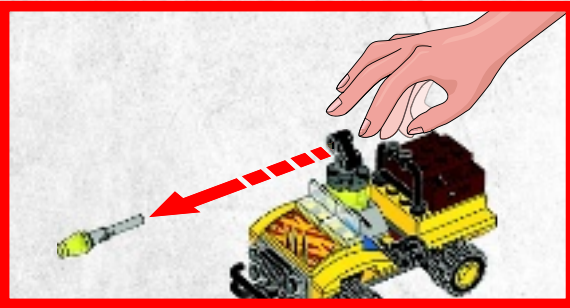

2





1x

1

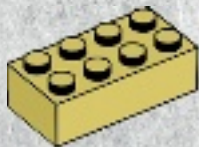

1x



2x

2

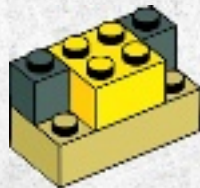



2x

3

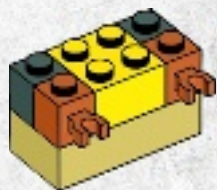

2x



2x

4

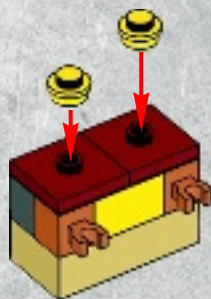



2x

5



2x



2x

6

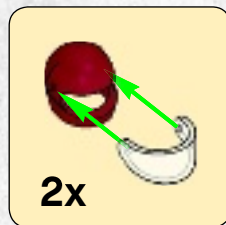

2x



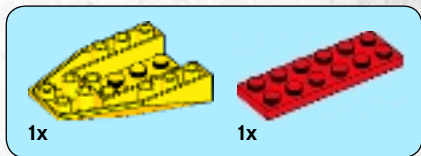

1

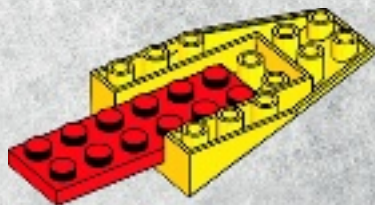



2

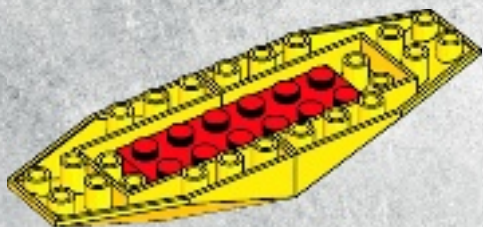

3

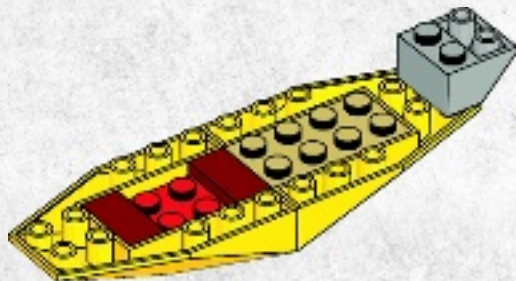

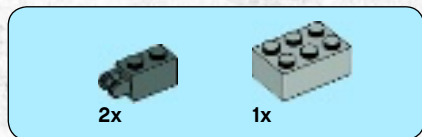

4

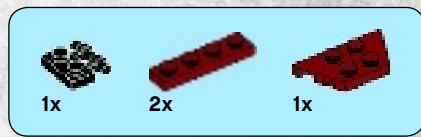
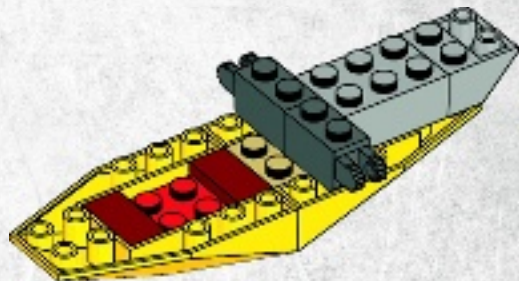

5

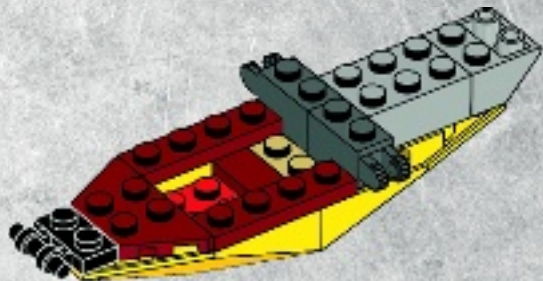

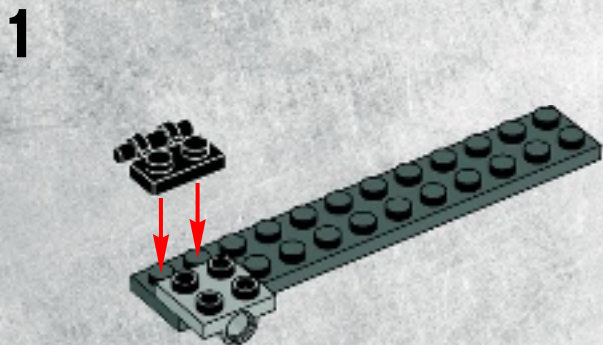
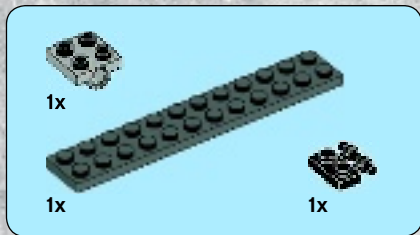

2

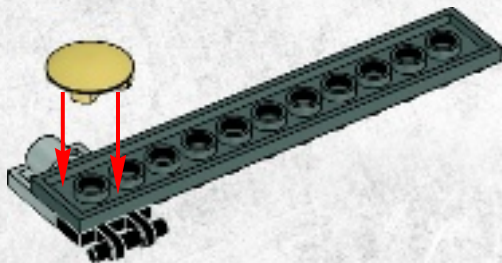
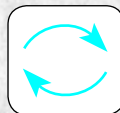

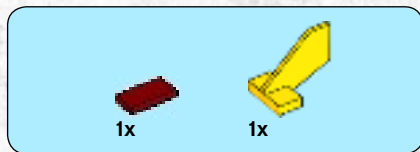

3

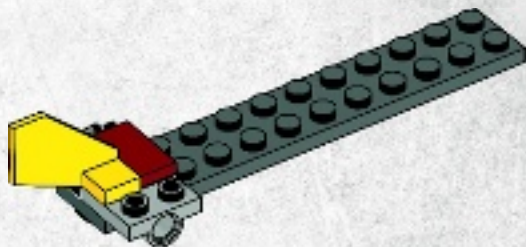
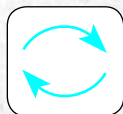

4

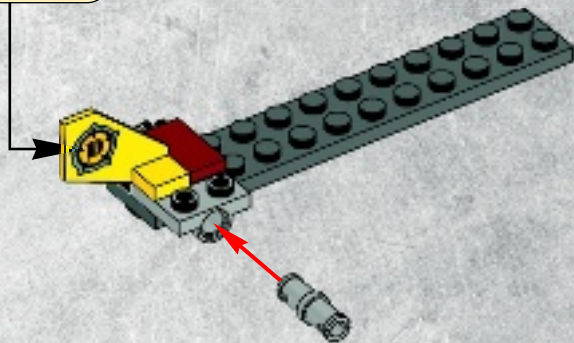

5

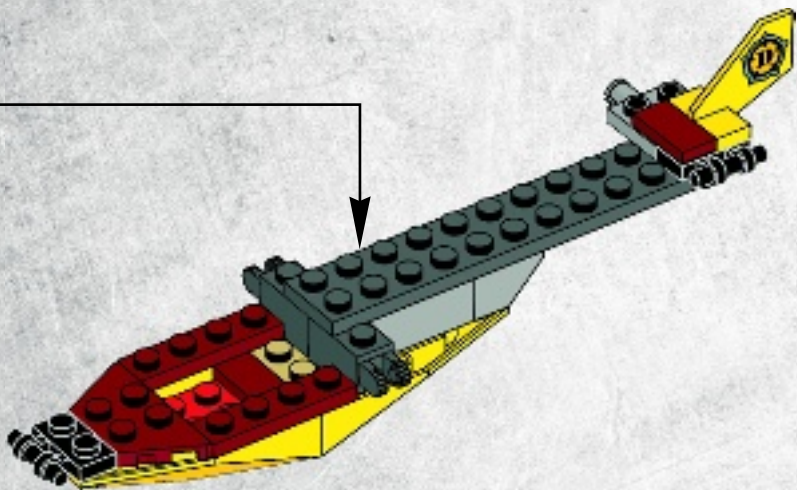



2x



1x

6

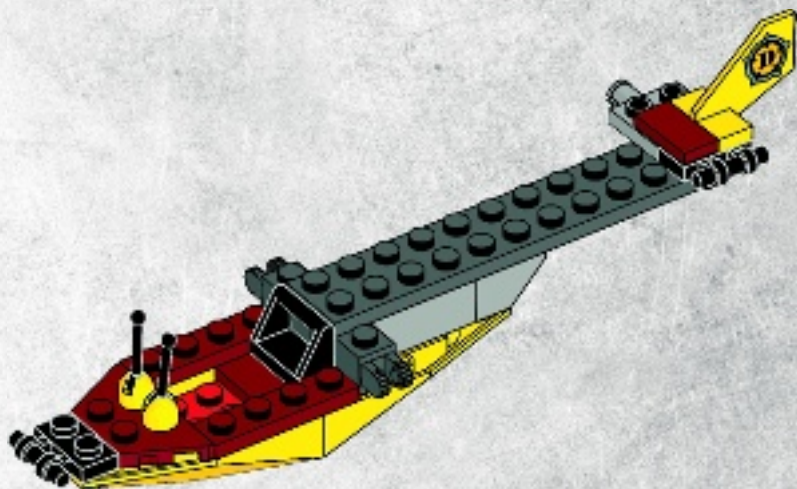



1x

7

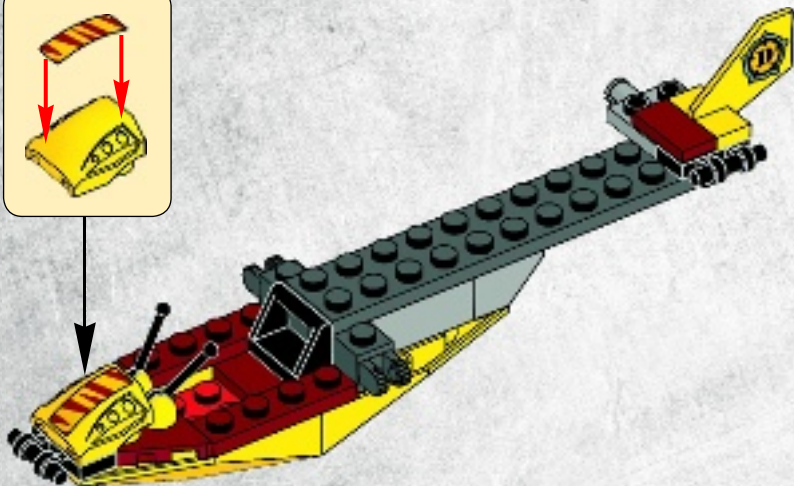



1x



1x

8

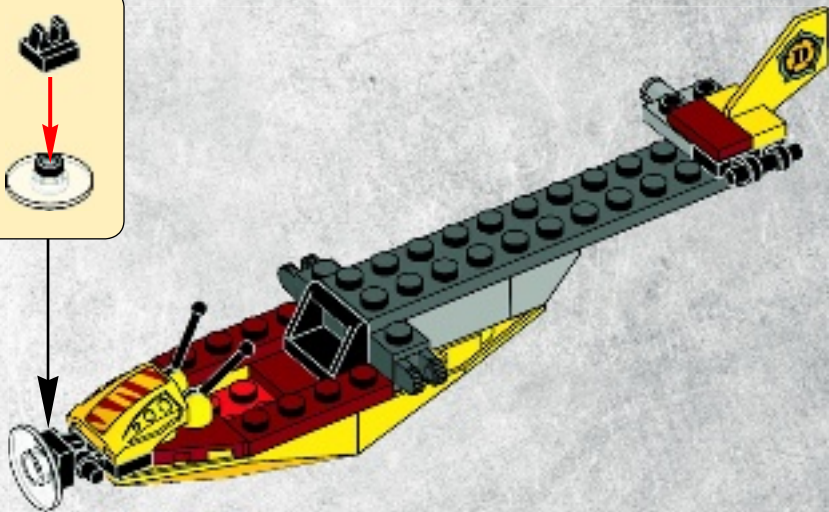
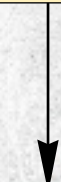
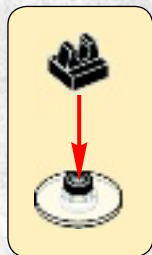



1x



1x



1x



1x



1x



1x

9

1



2



3

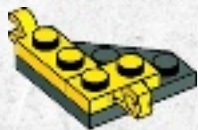

4



5



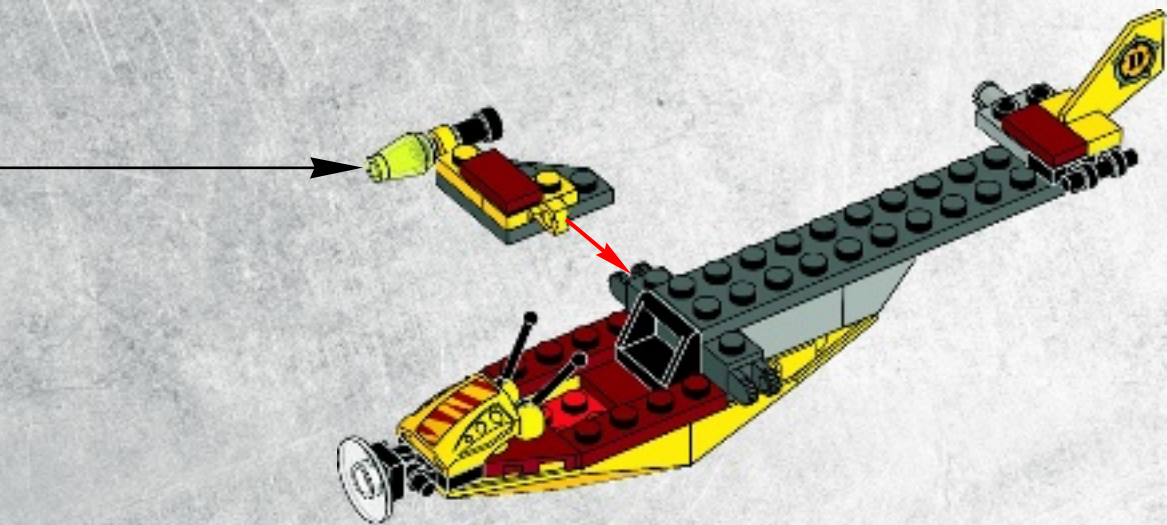



1x



1x



1x



1x



1x



1x

10

1



2



3



4



5

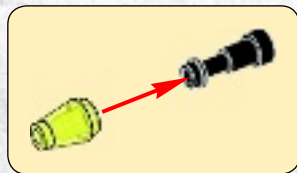

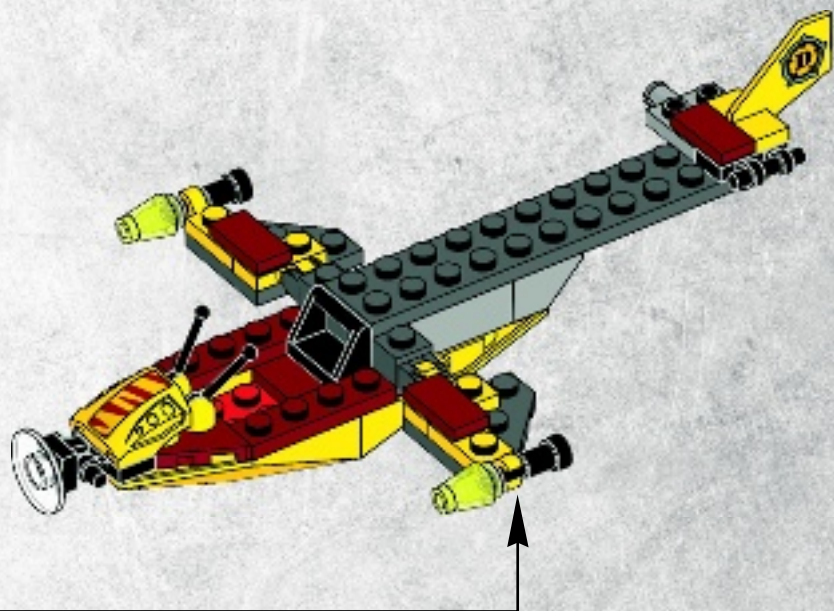



2x

11

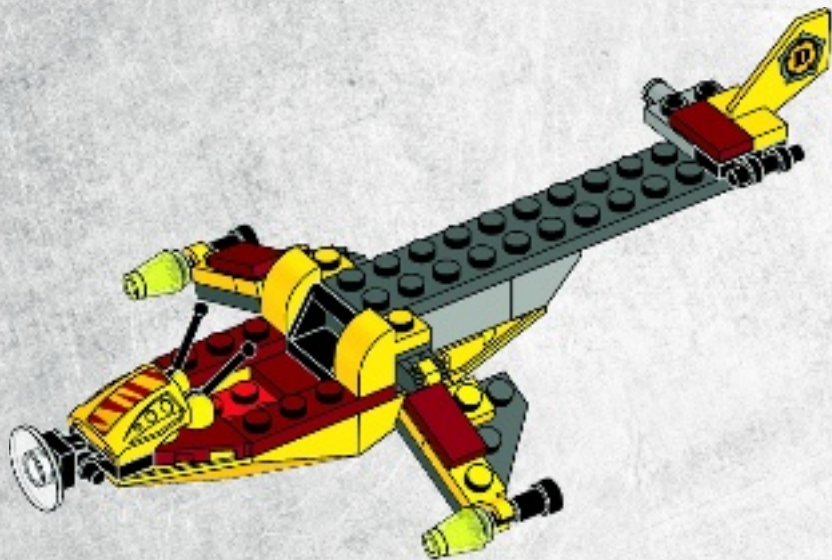



1x



1x

12

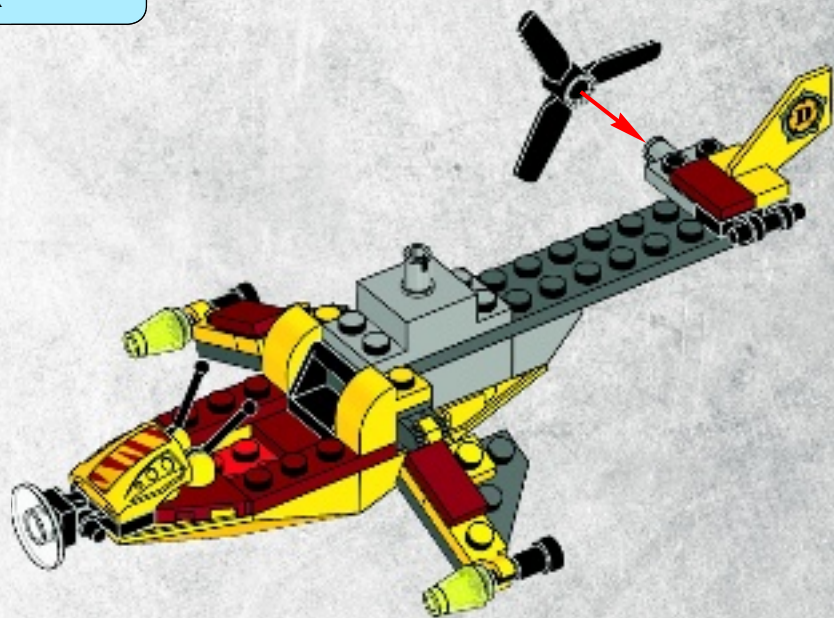



1x



1x



1x

13

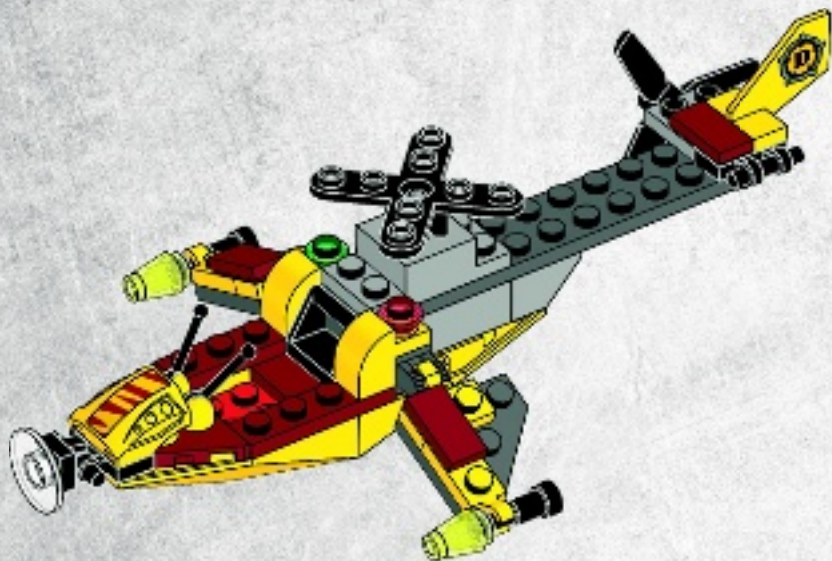



14

