

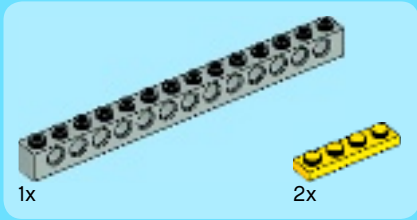

CREATOR

5767





1

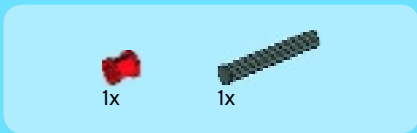
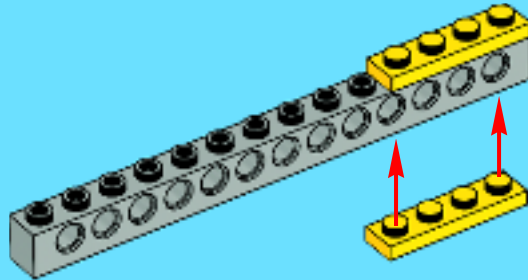

2

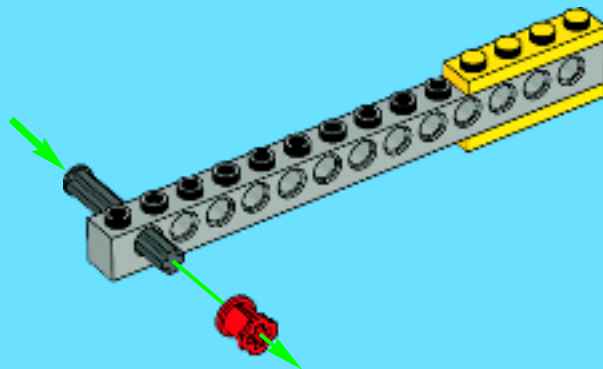

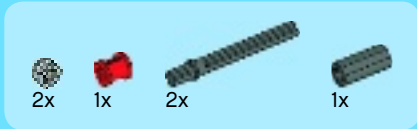

3

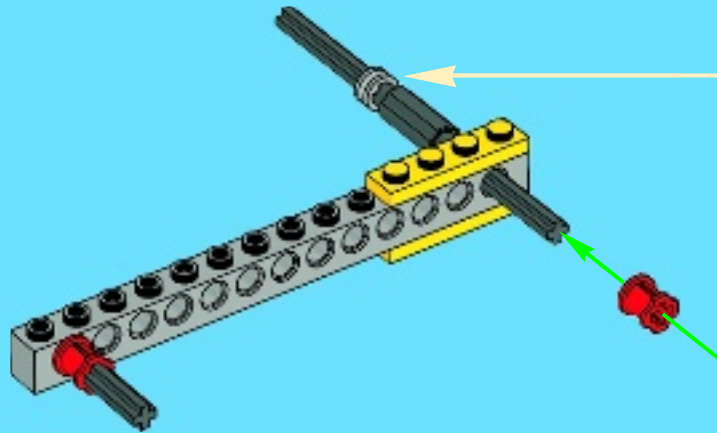

4

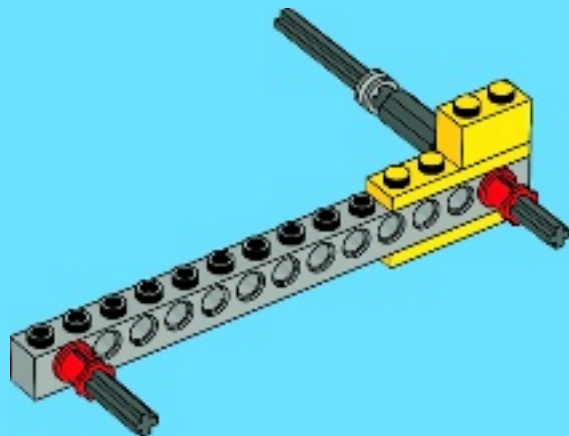



1

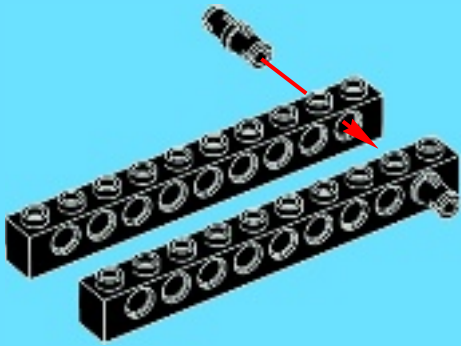

2



3

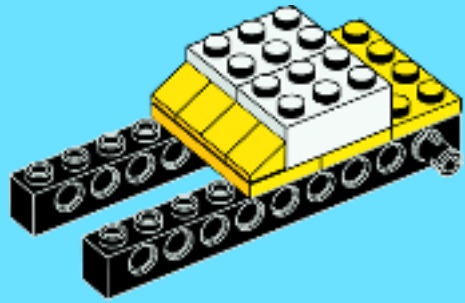

4

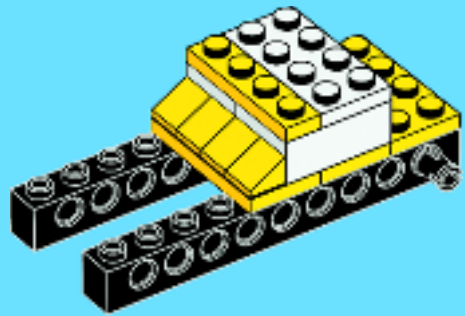



1x



1x

5

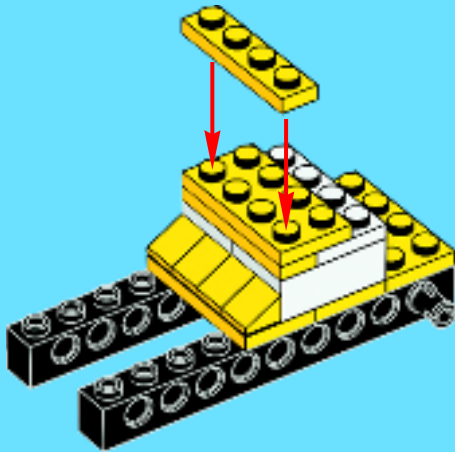

4x

6

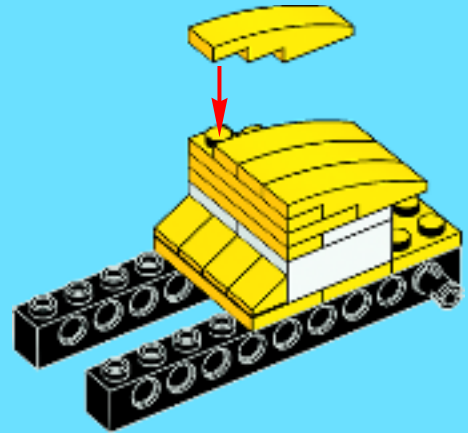

7

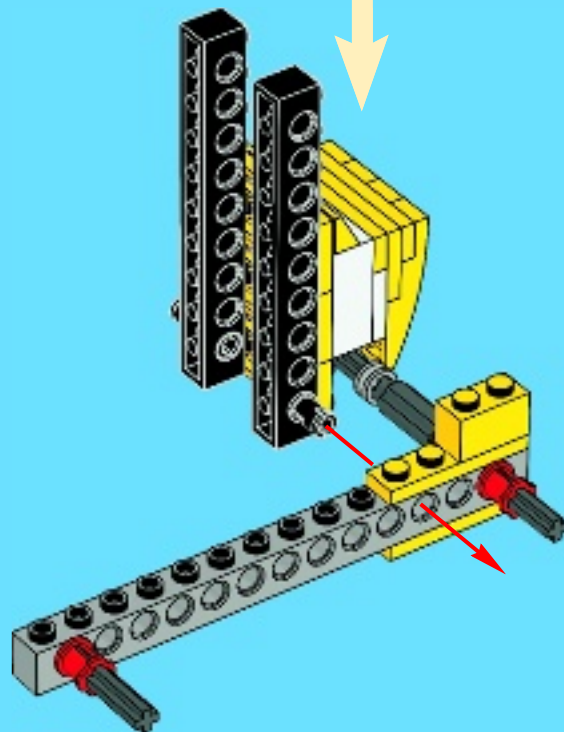

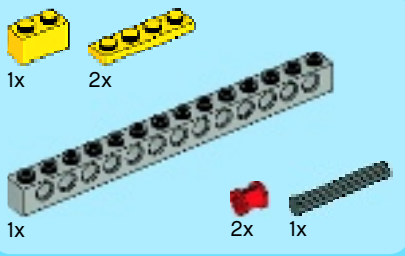

8

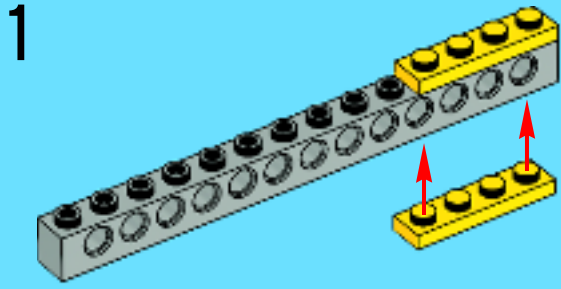

2

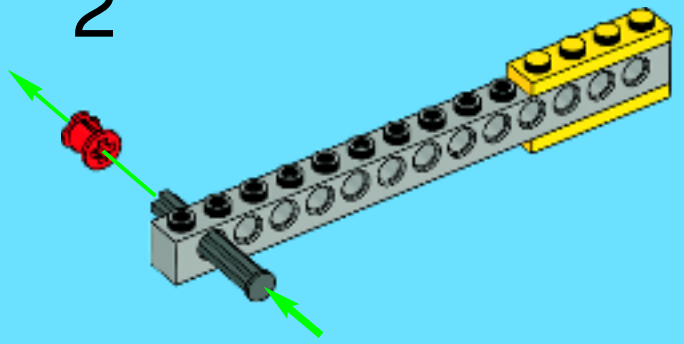

3

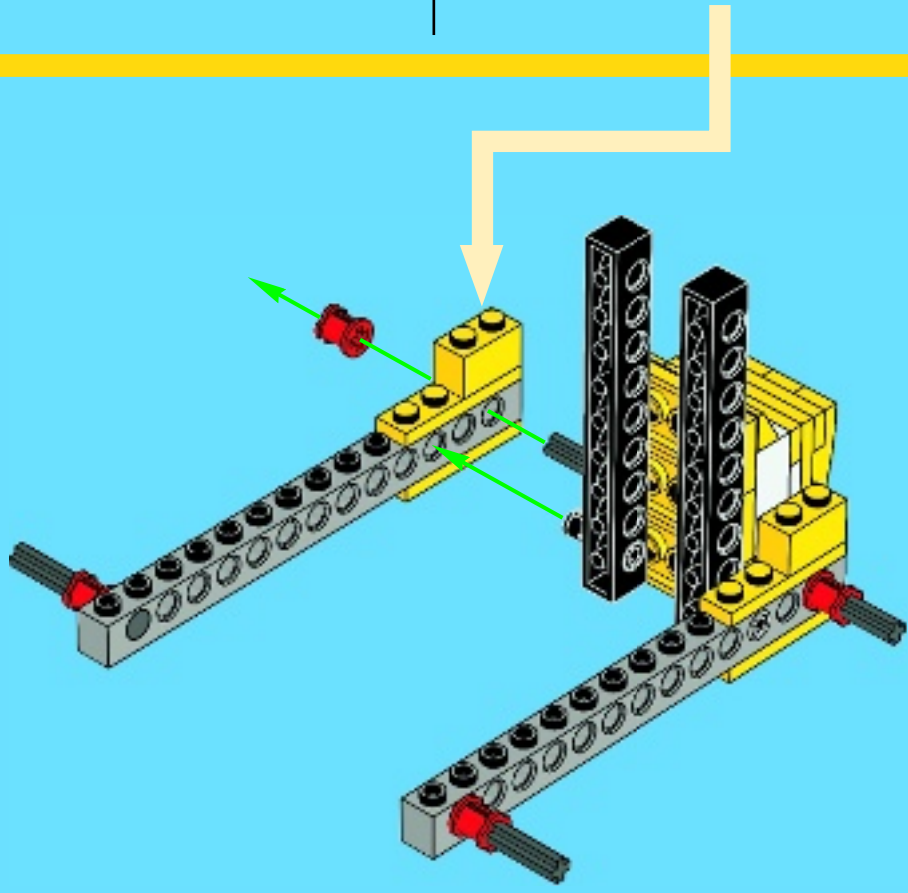
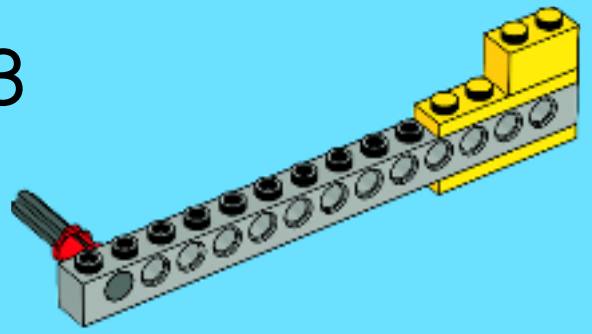



2x

9



2x

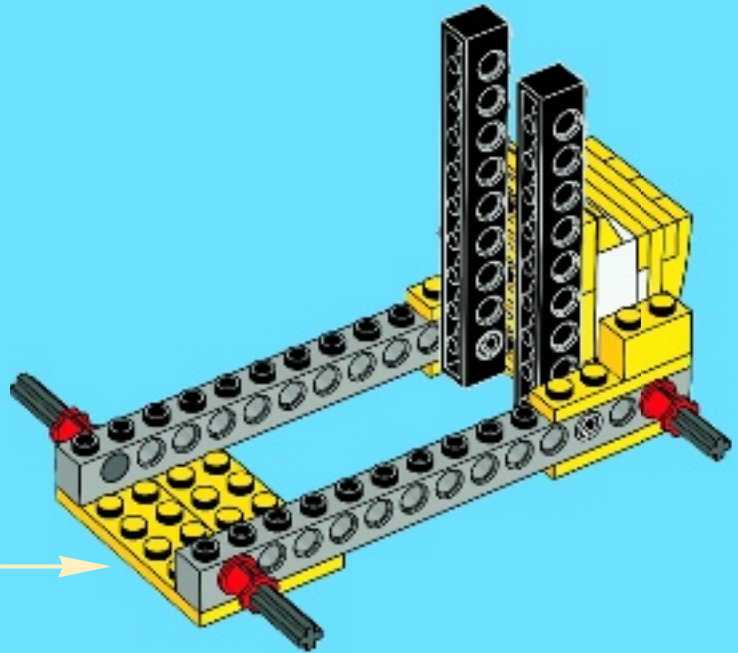

1x

10

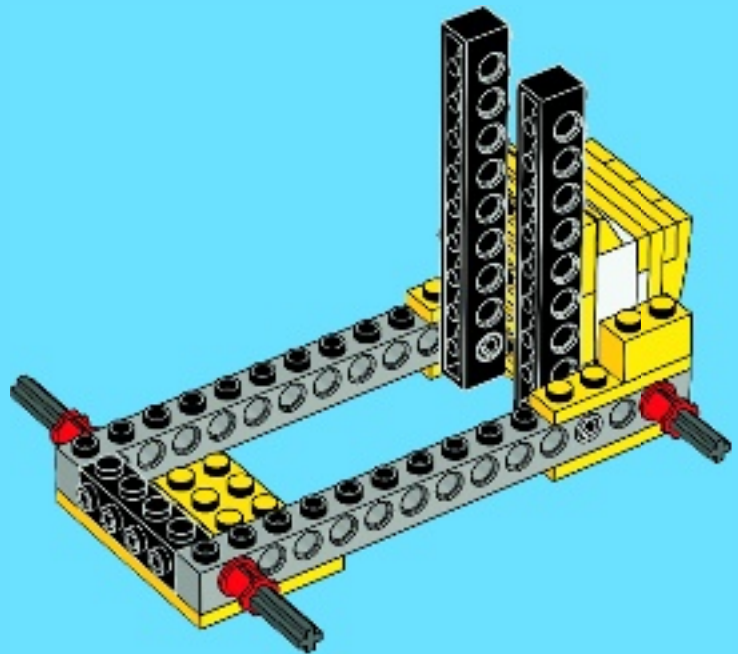



2x

6x



1x

11

1



2

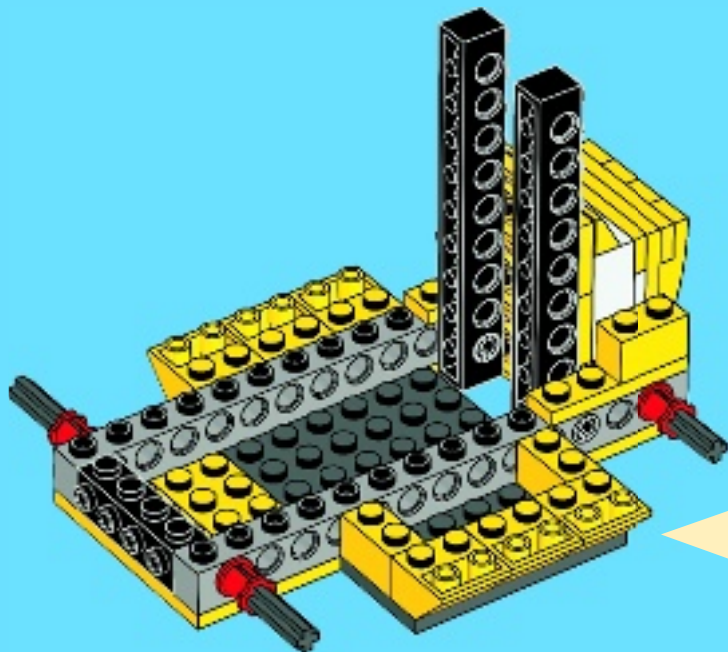
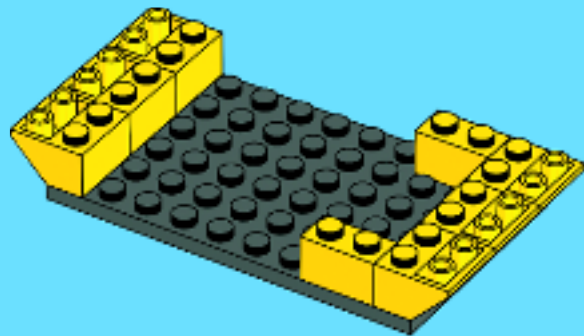

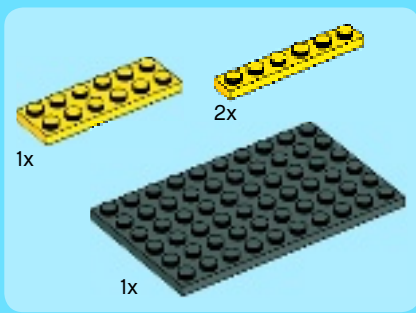

12

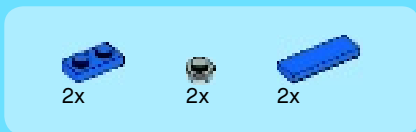
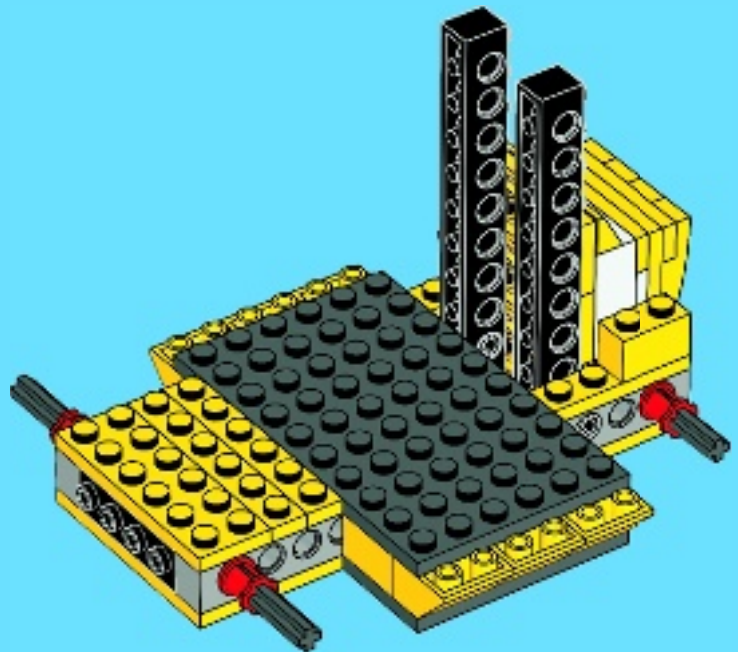

13

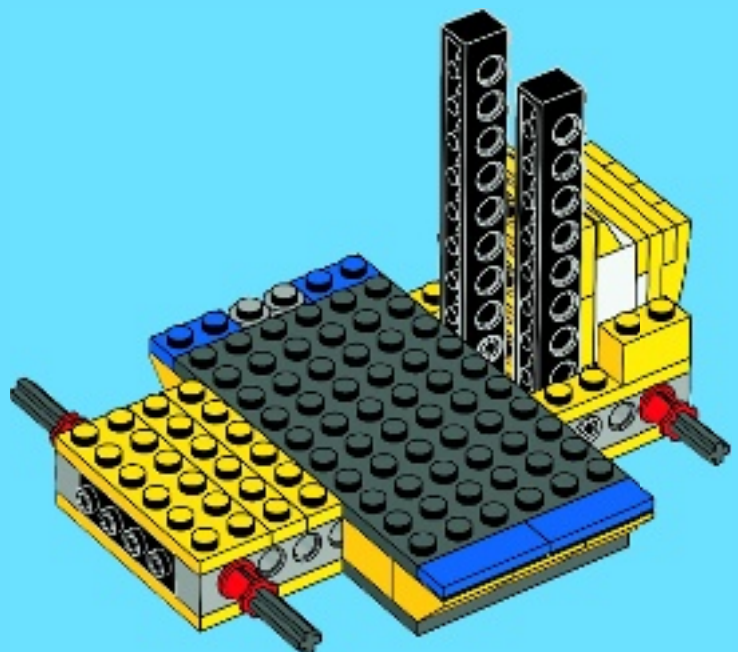



1x



1x



1x



2x



1x

14

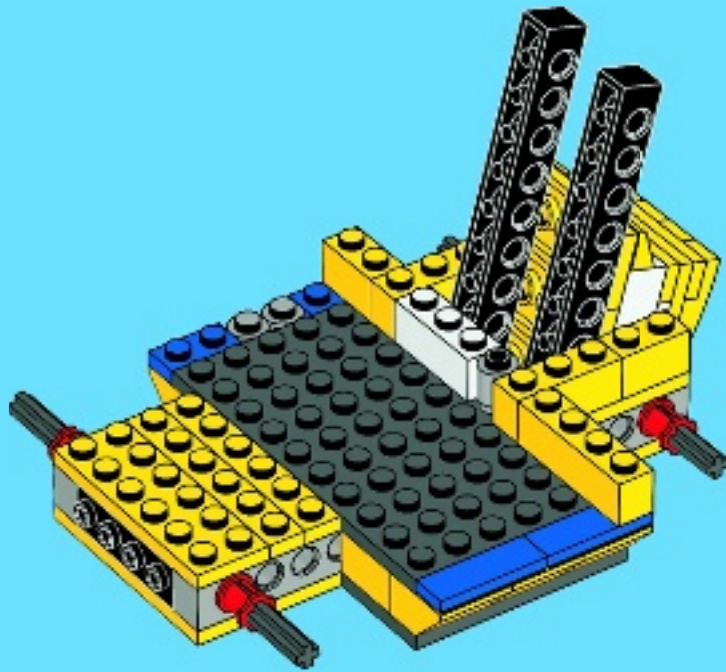

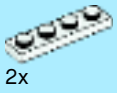

2x



2x



2x

15

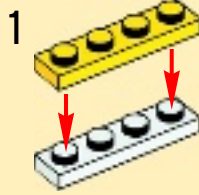

1

2

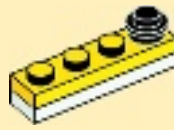

2x

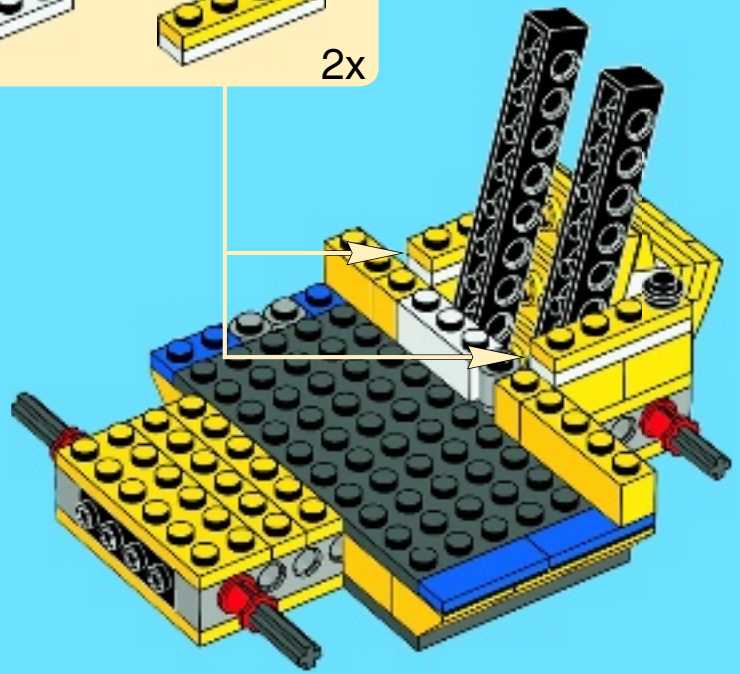

1x



1x



1x



4x

16

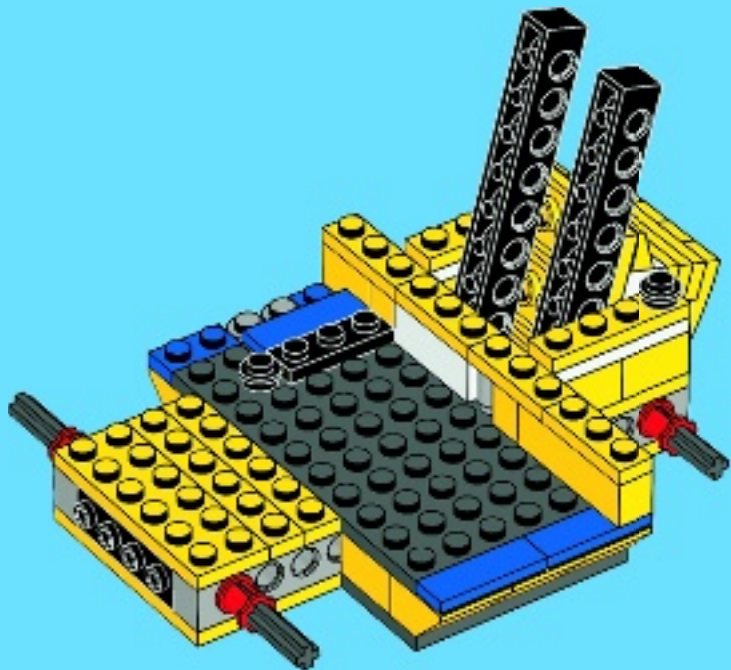

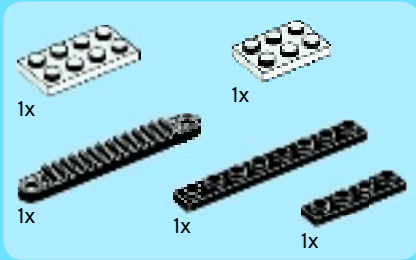

17

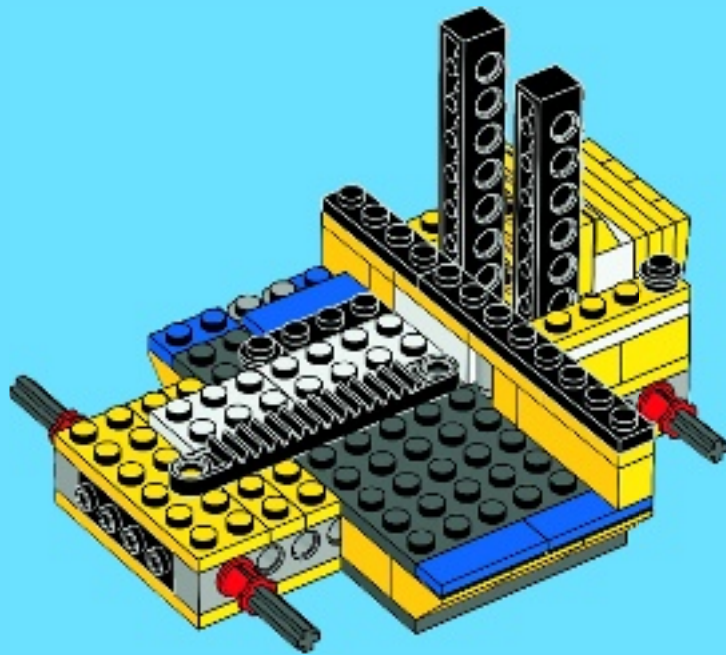



2x



1x



1x



1x

18

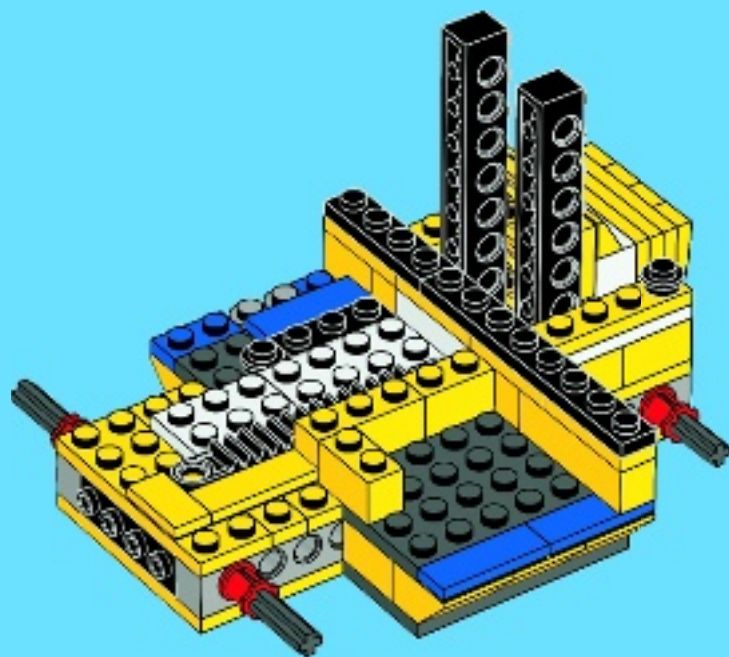

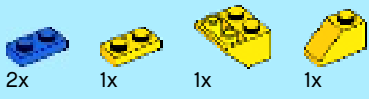

19

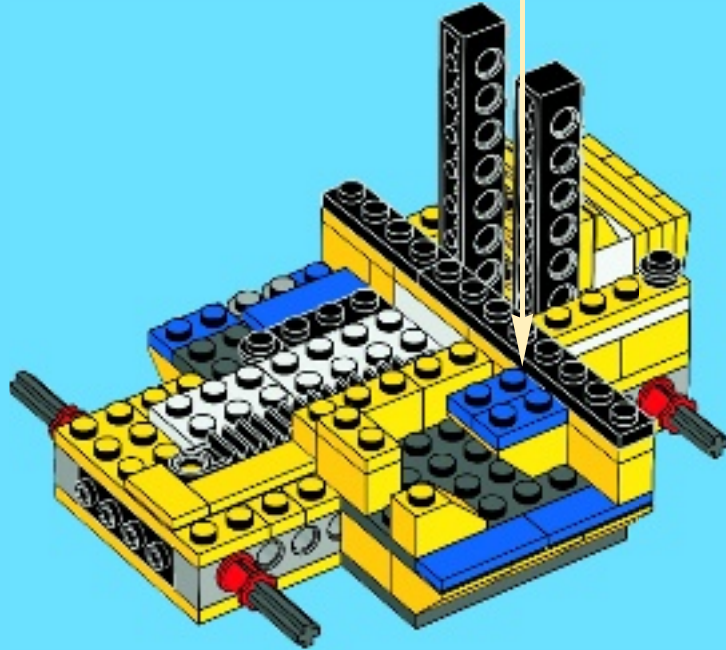
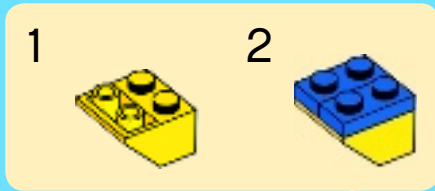



4x



1x



4x

20

1

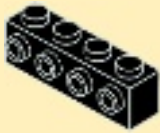

2

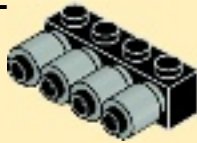

3

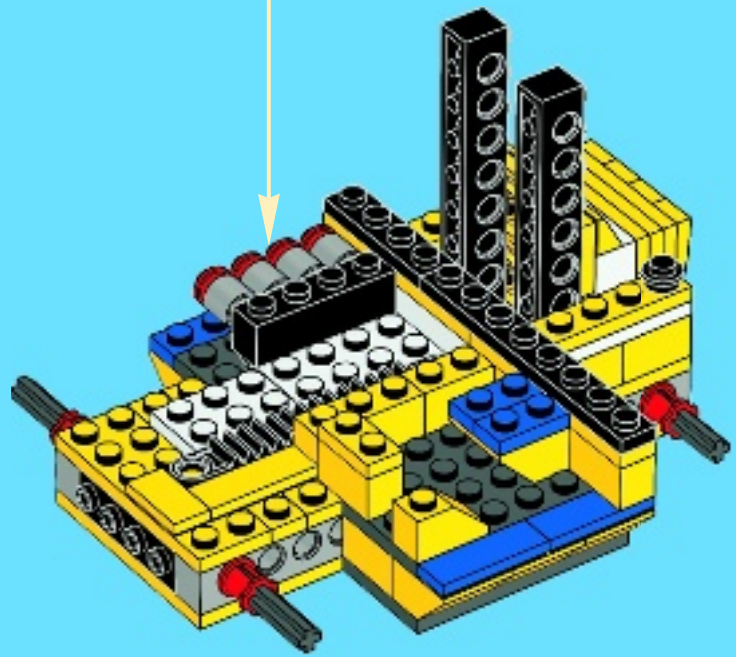
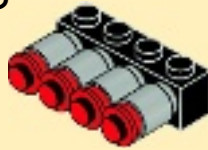



1x



2x

21

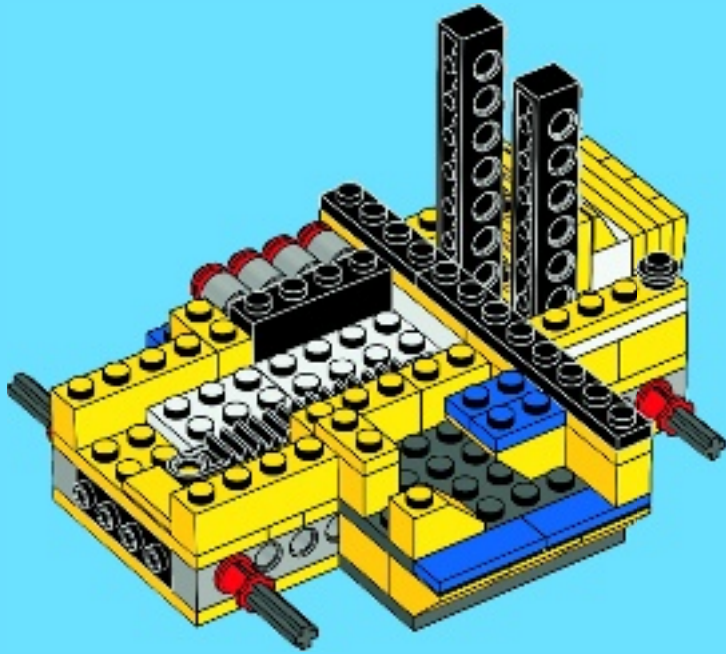

1x



2x

22

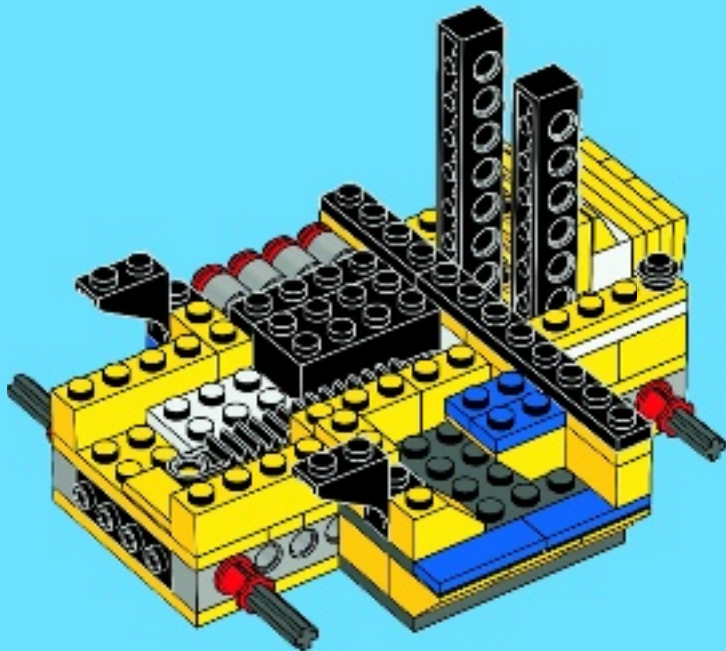

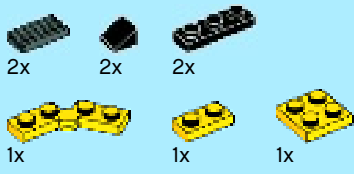

23

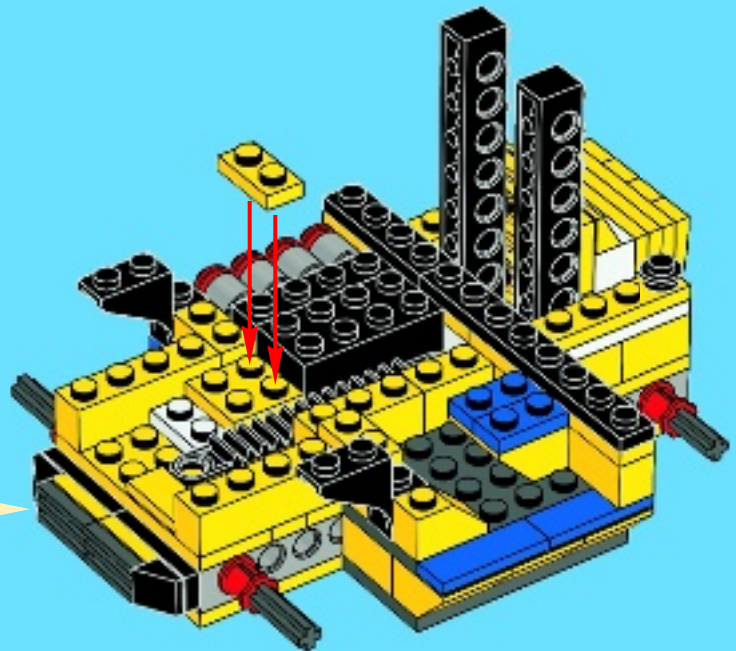
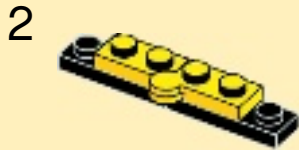
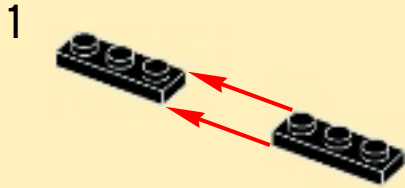



1x



1x



1x



2x

24

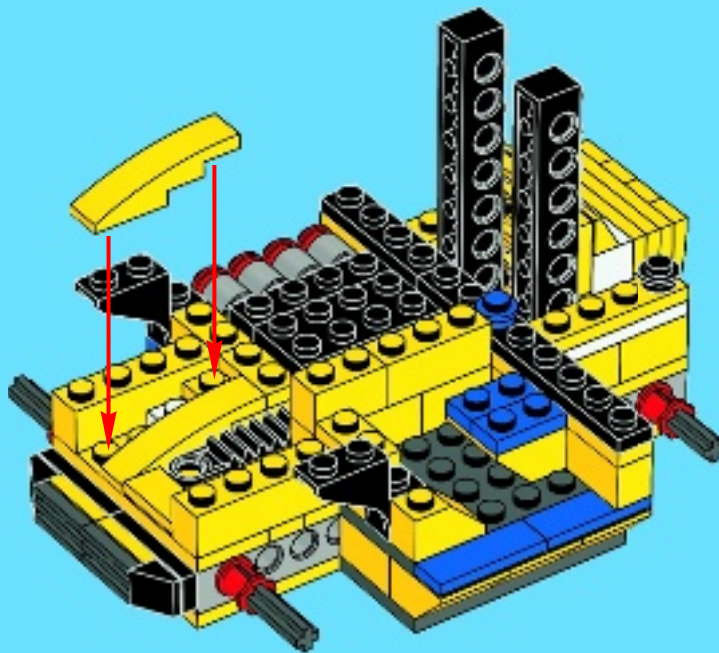



1x



1x



1x



1x

25

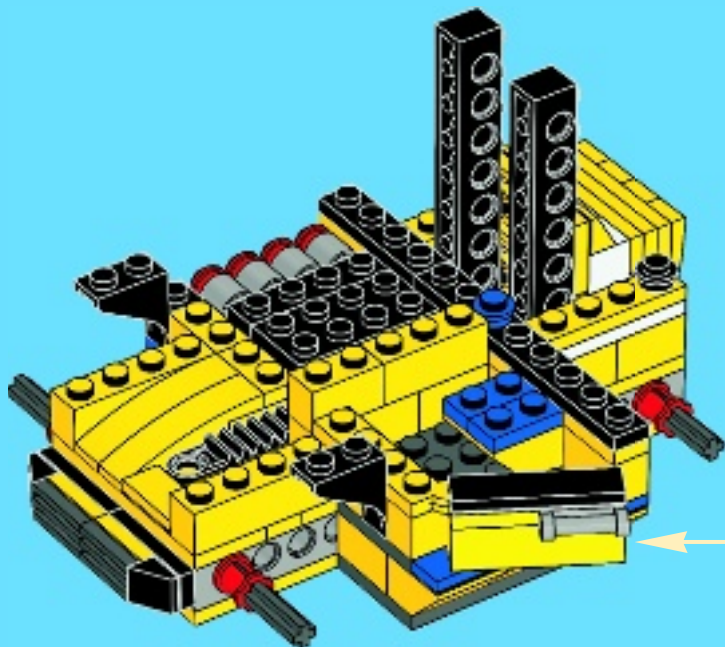

1

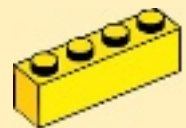

2

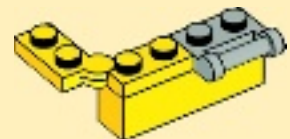

3

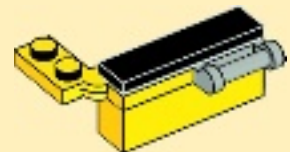



2x

26

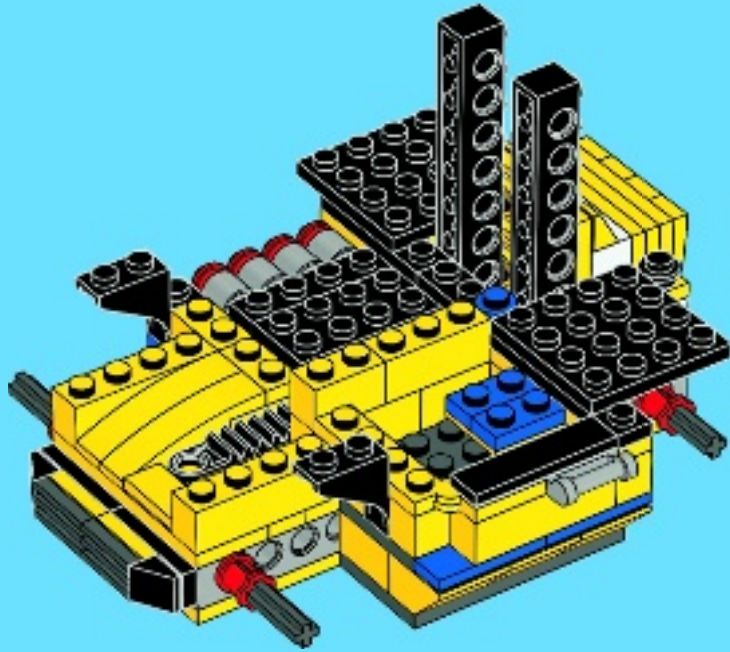

1x



1x



1x

27

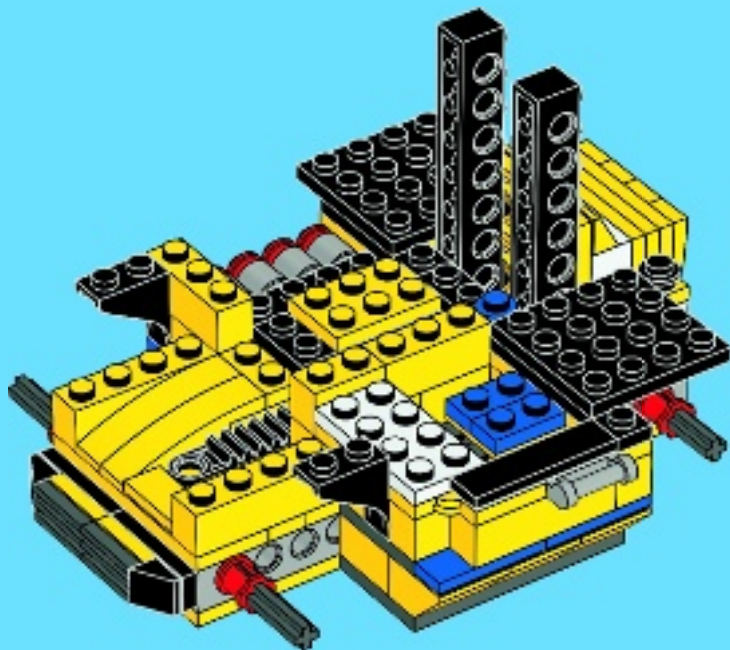



2x



2x



1x

28

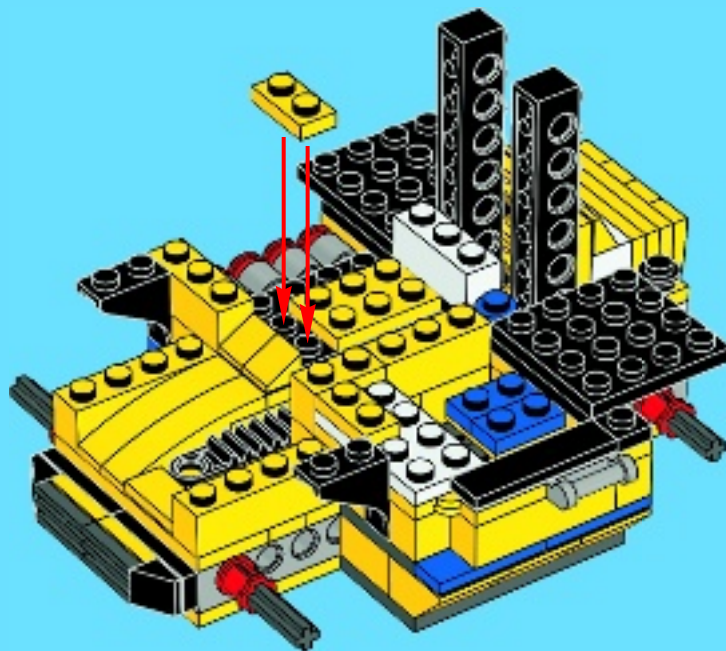



1x



4x



1x

29

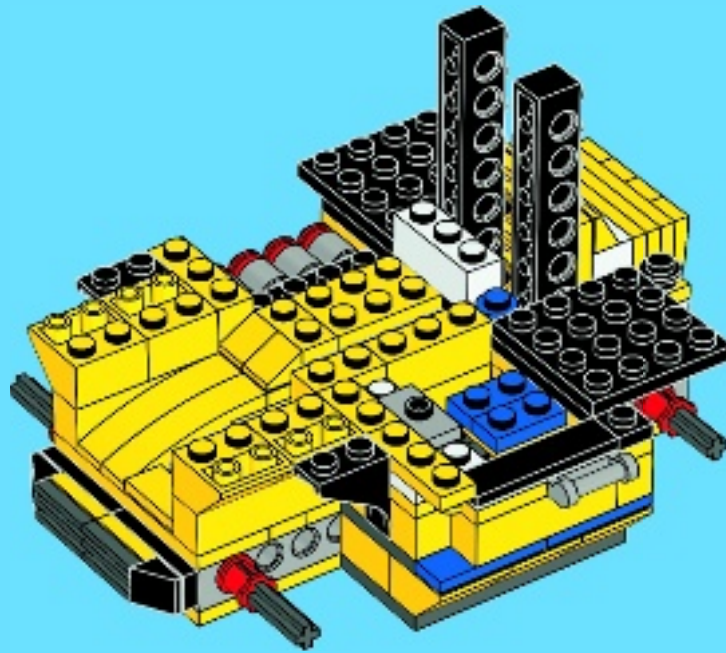



2x



2x

30

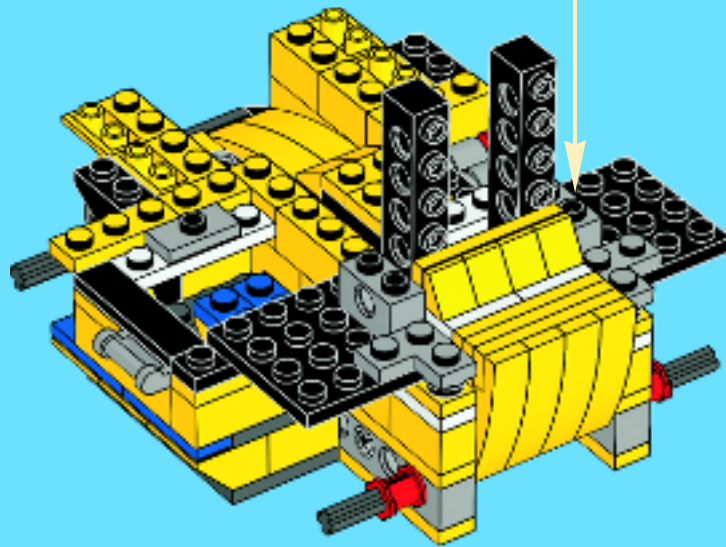



2x

31

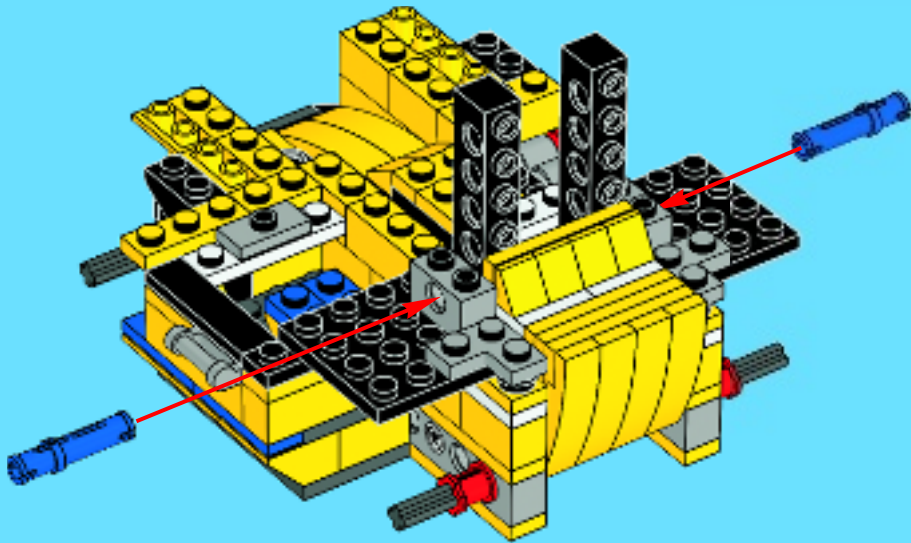



4x

32

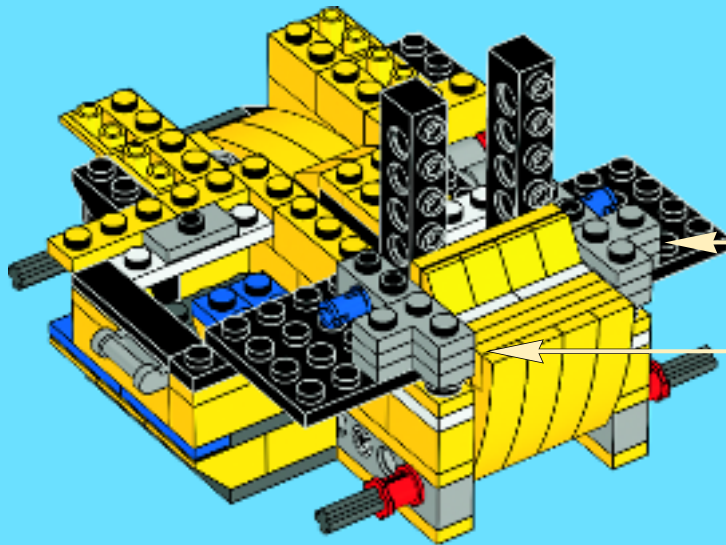
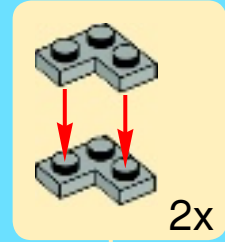



2x



2x

33

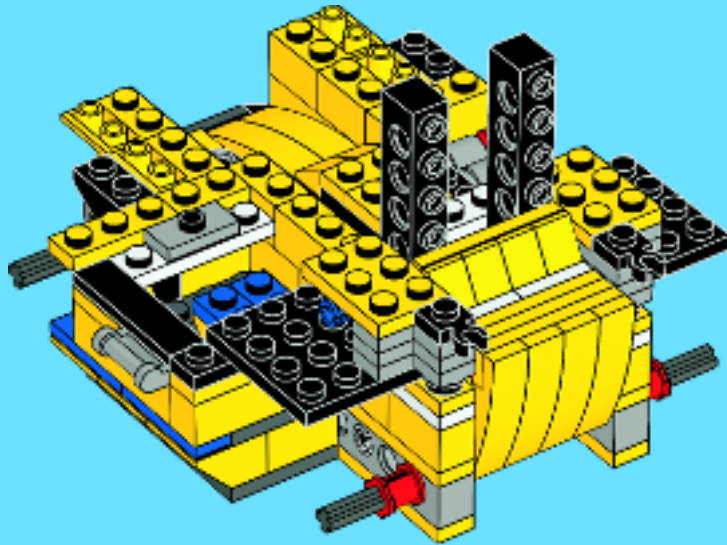



2x



2x



2x

34

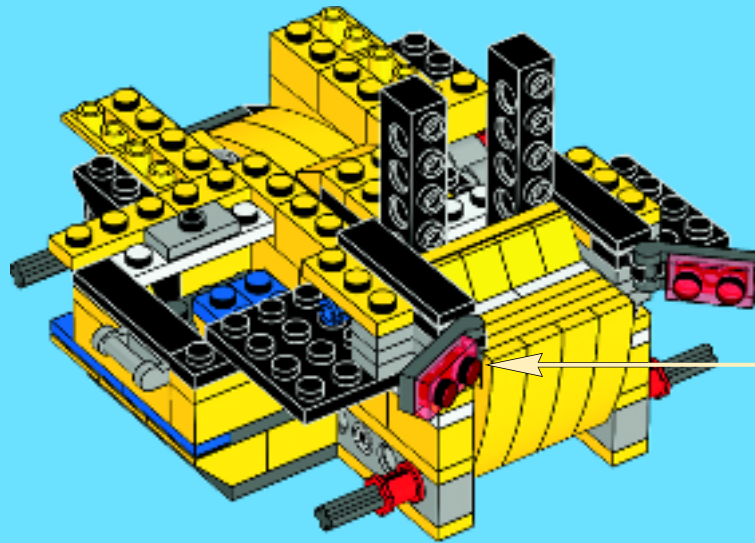
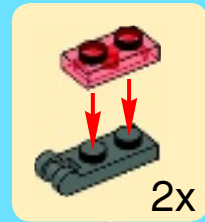



1x



1x



2x

35

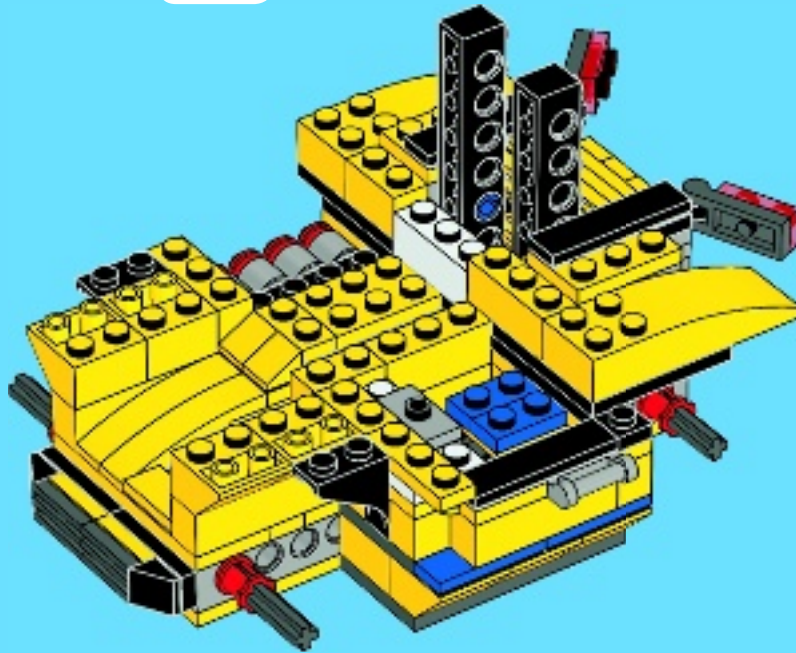



1x



1x



1x

36

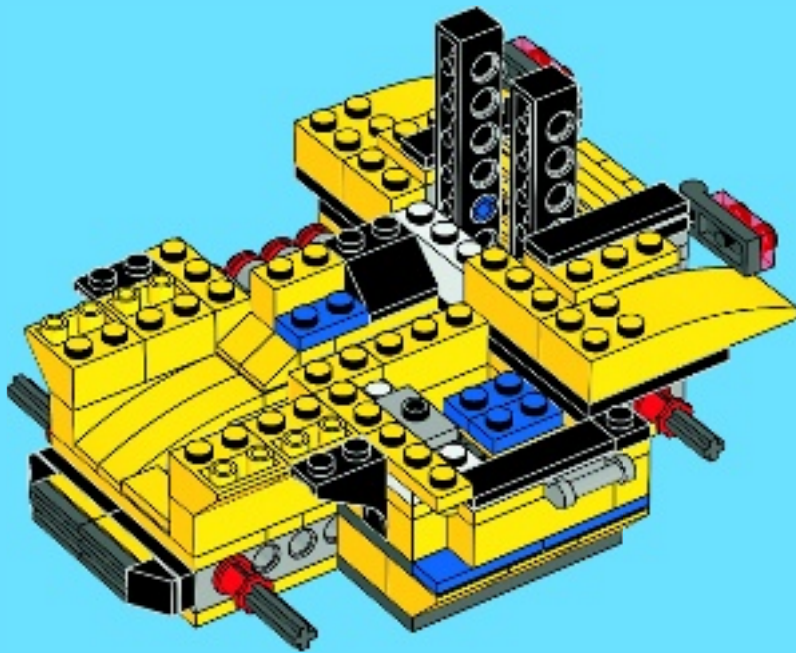

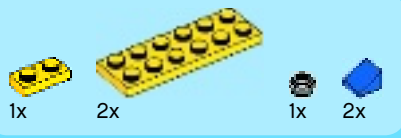

37

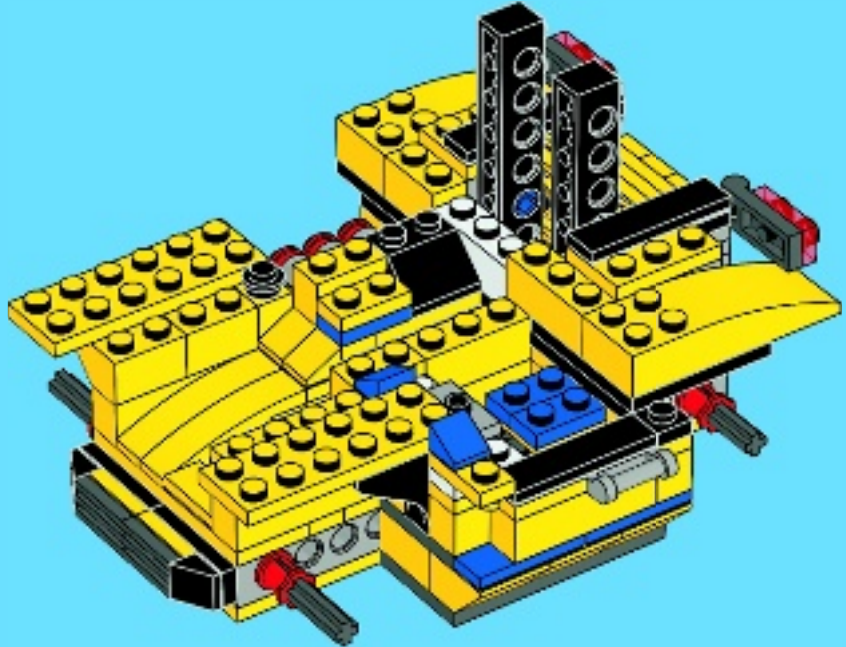



1x



1x



2x



4x

38

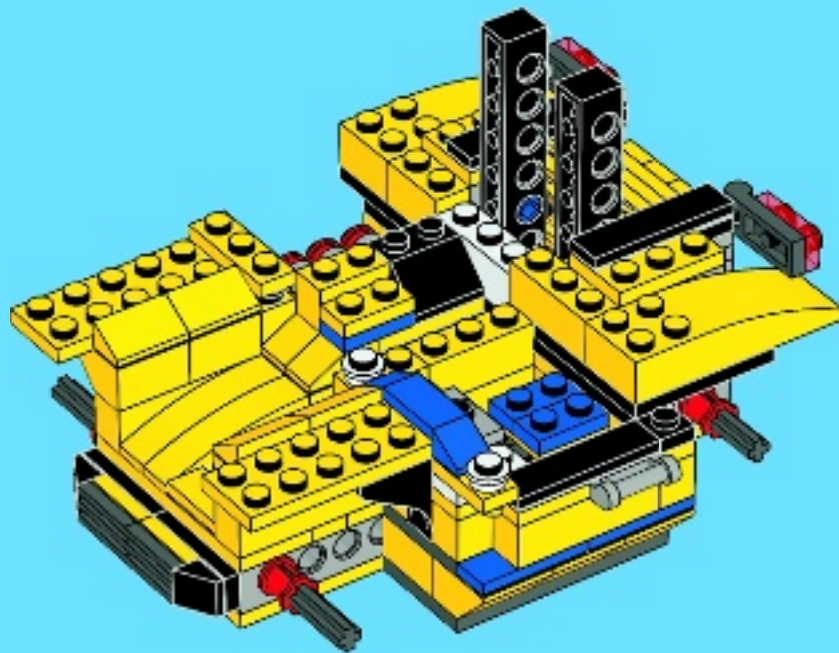



2x



1x



1x



1x

39

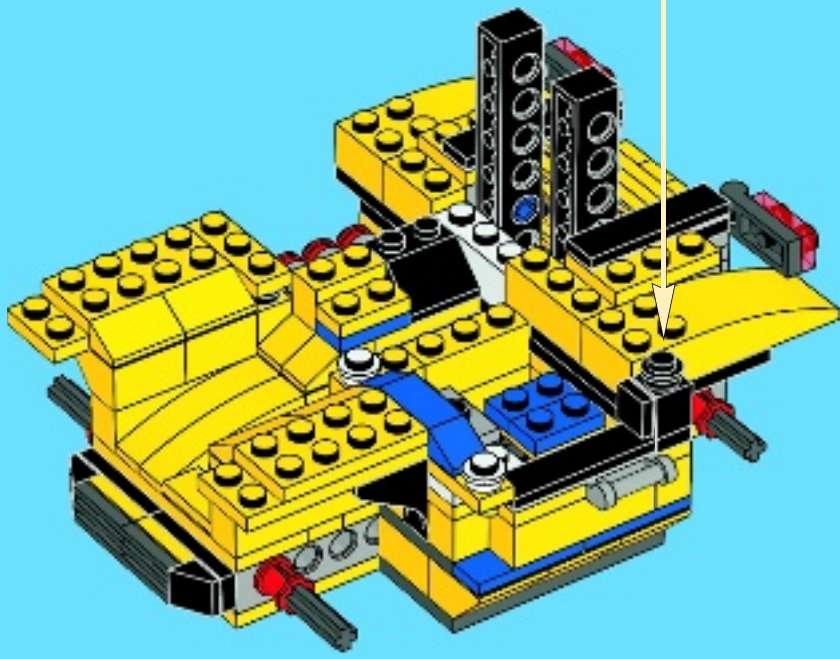
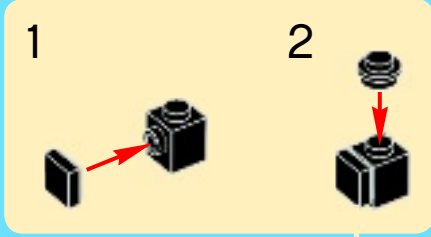



1x



2x



1x

40

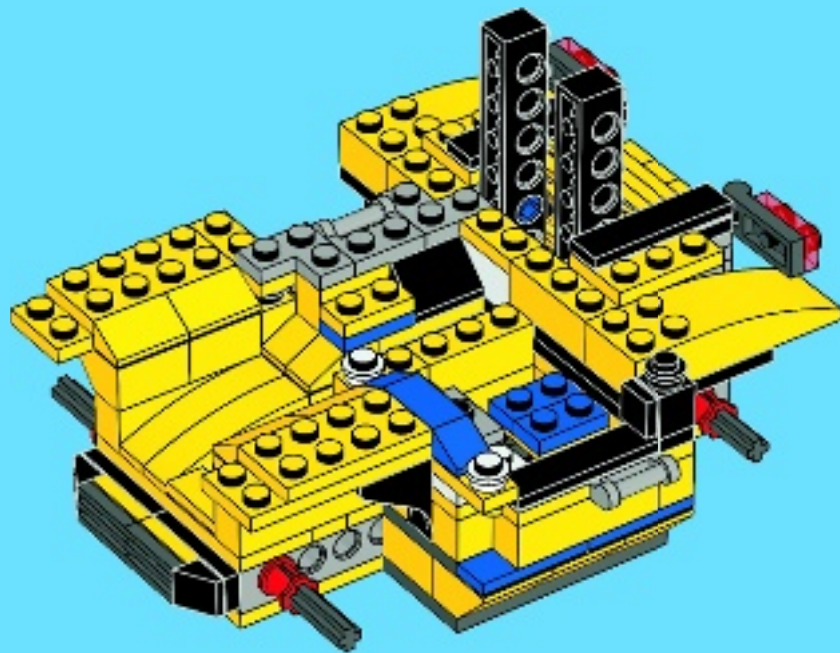



41

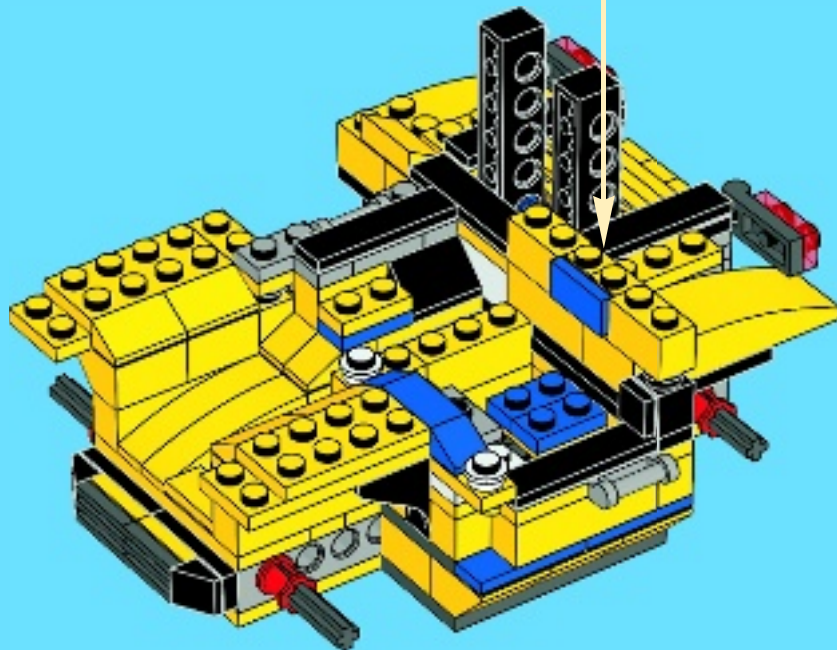
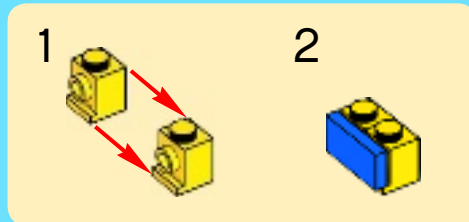



2x

1

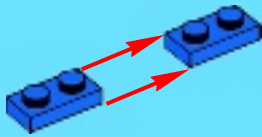

1x

2

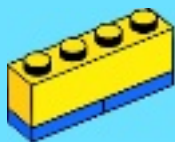

2x

3

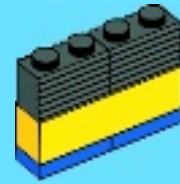

4x

4

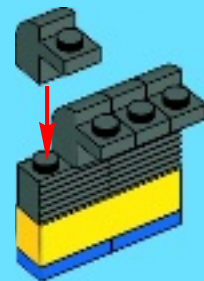

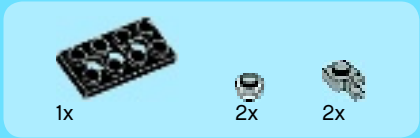

5

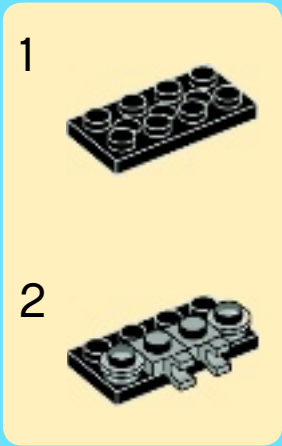

6

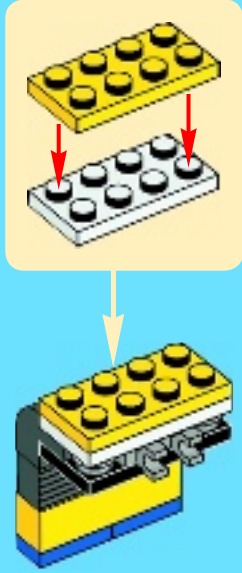

42

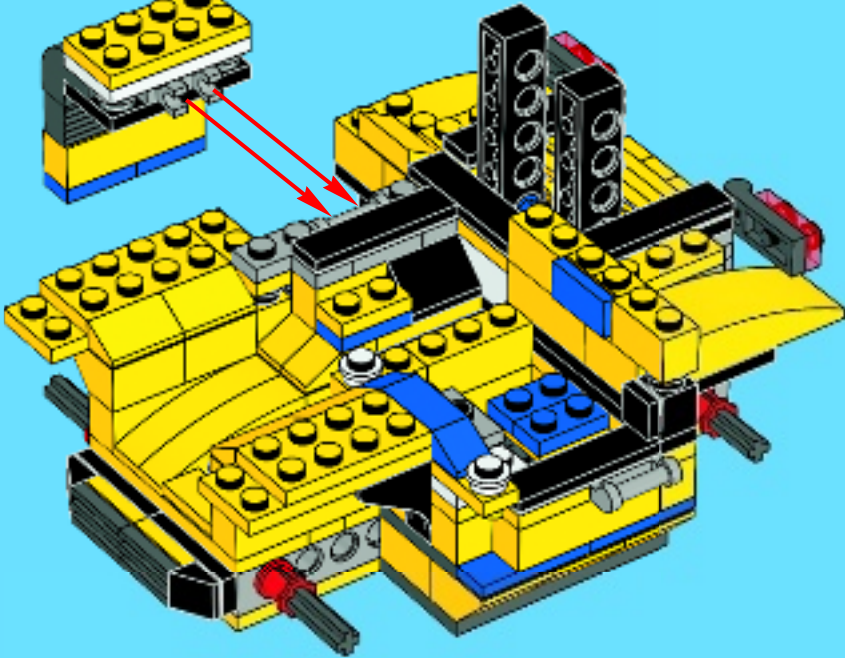



43

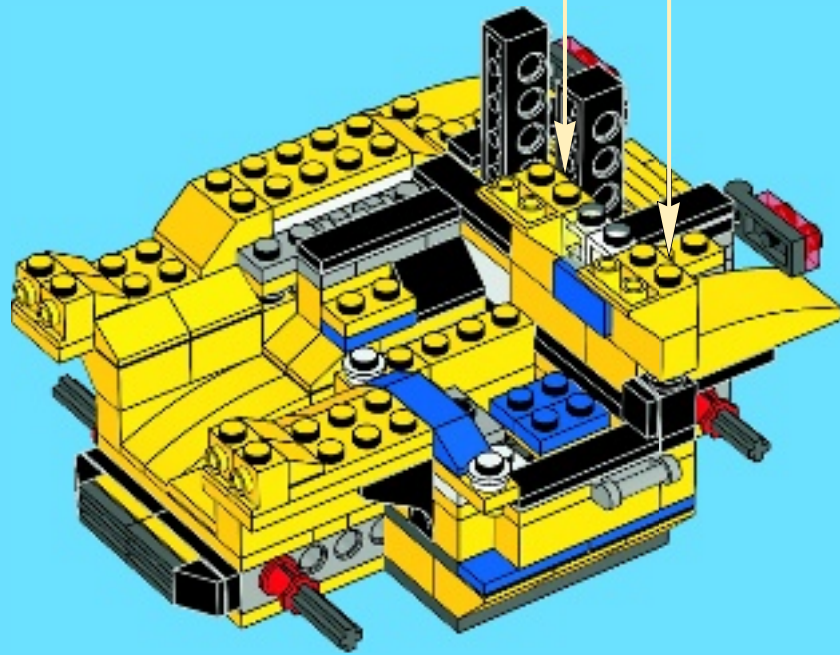
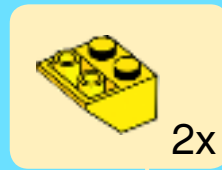



1x



2x



2x



1x

44

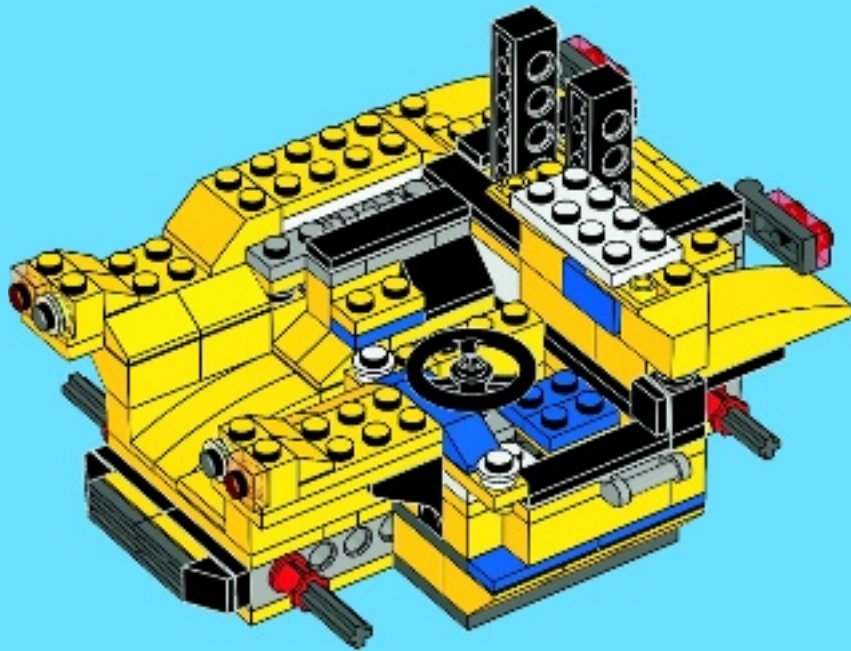

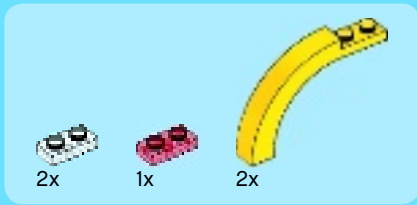

45

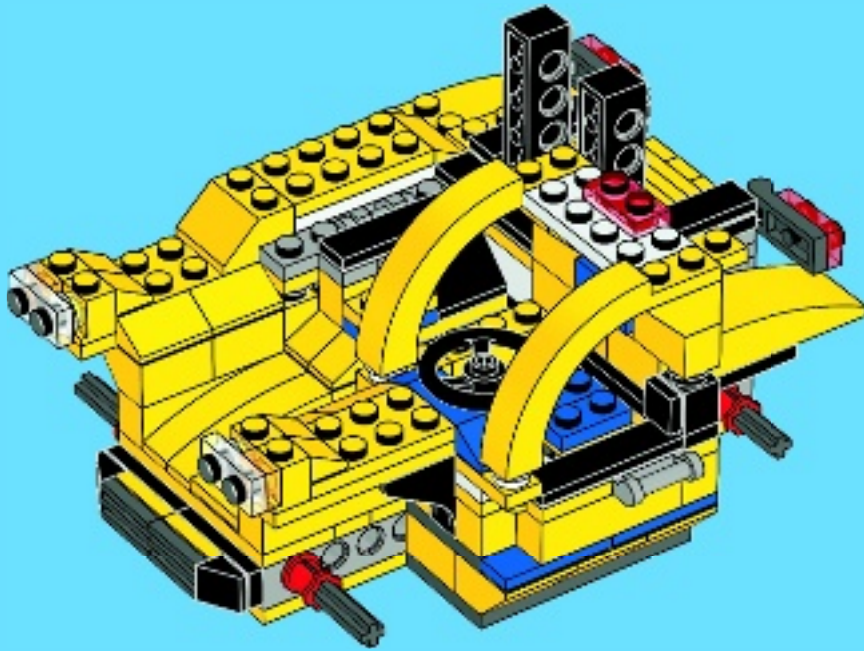



1x



4x

46

1



2

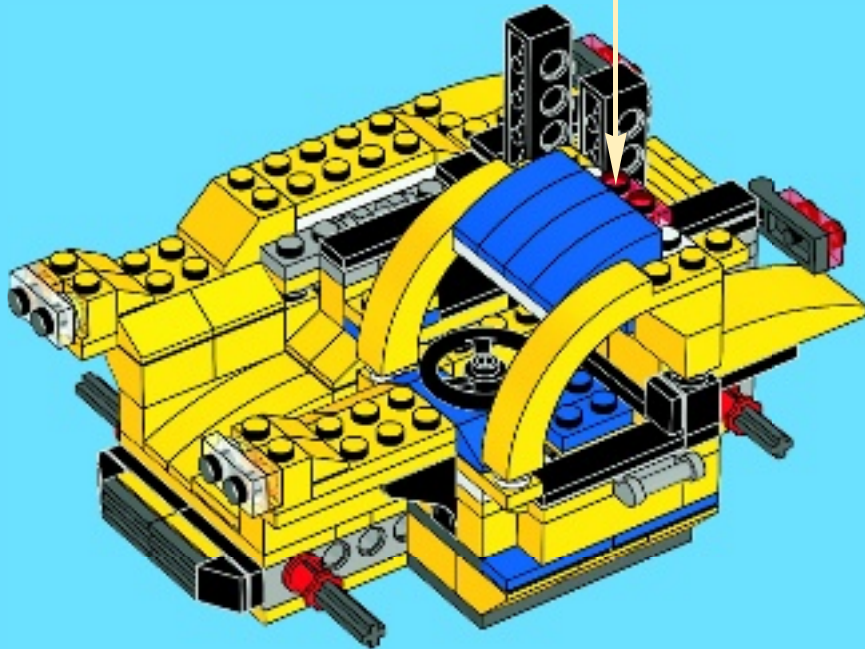
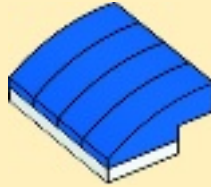



2x



2x



2x



2x

47

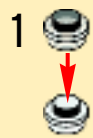

1

2



2x

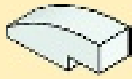

2x

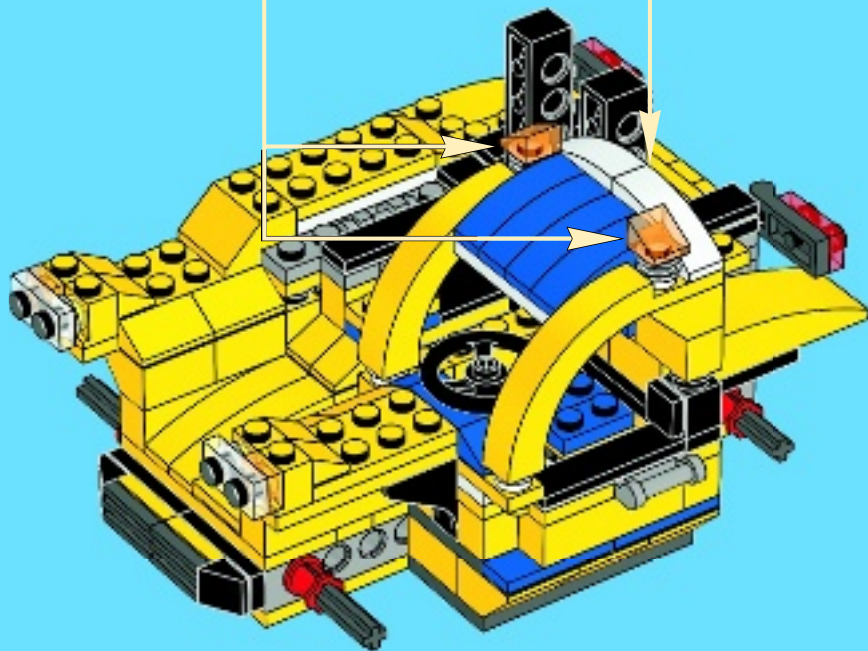

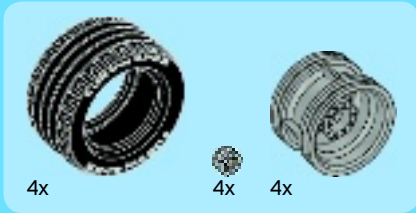

48

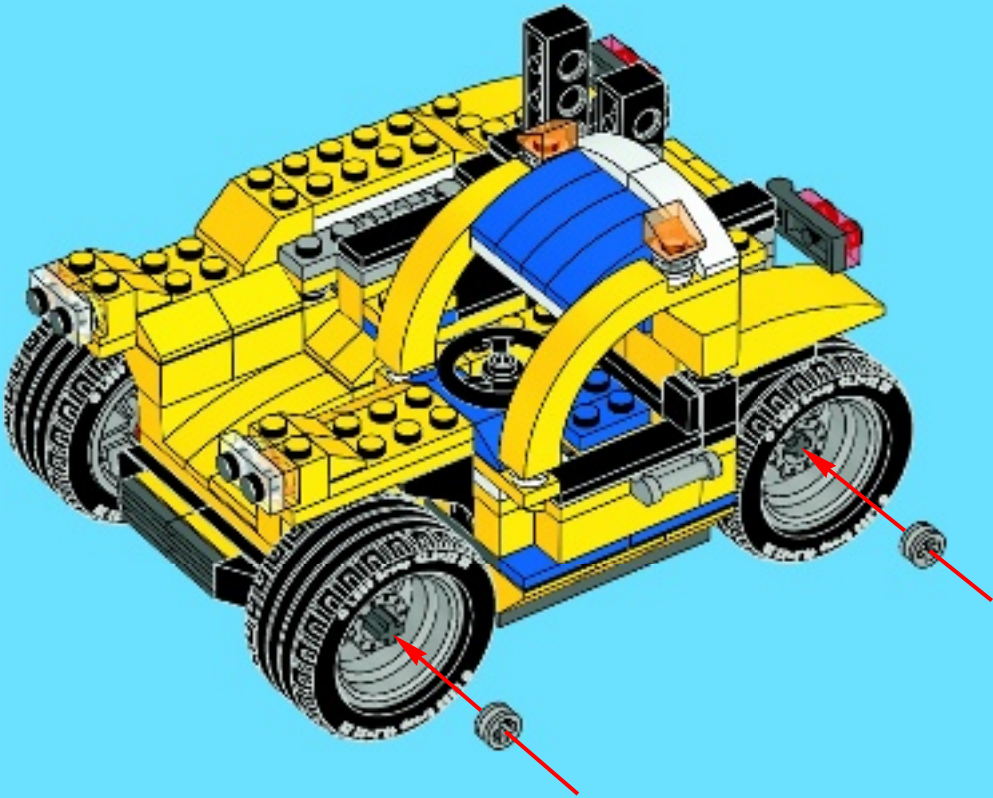

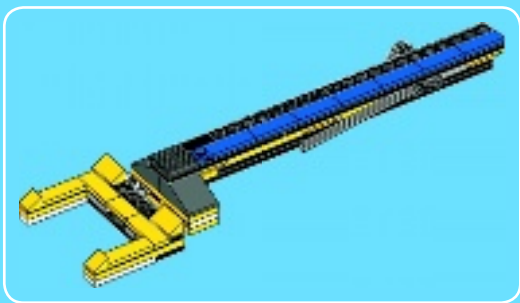

1

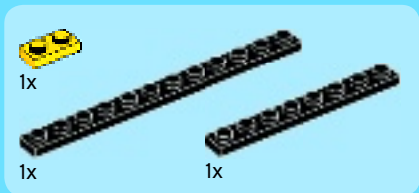
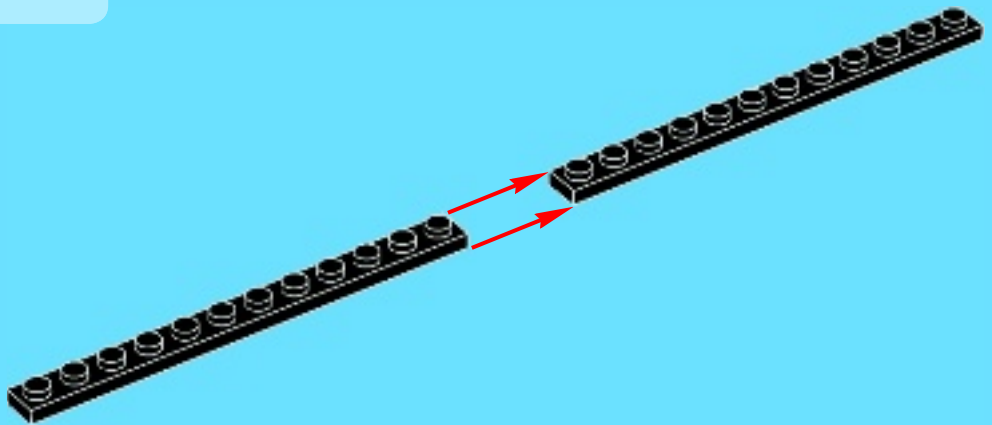

2

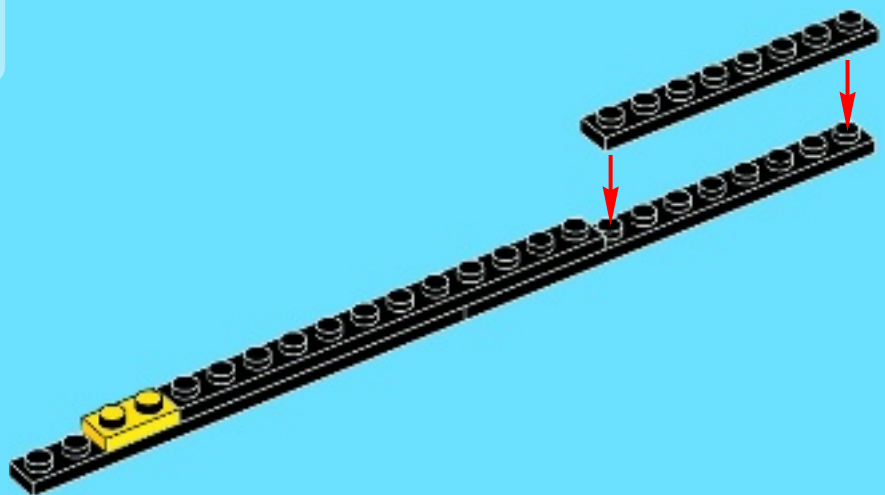



3

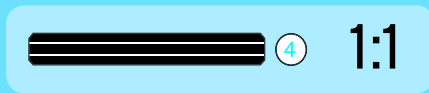
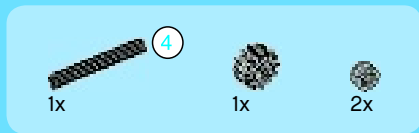
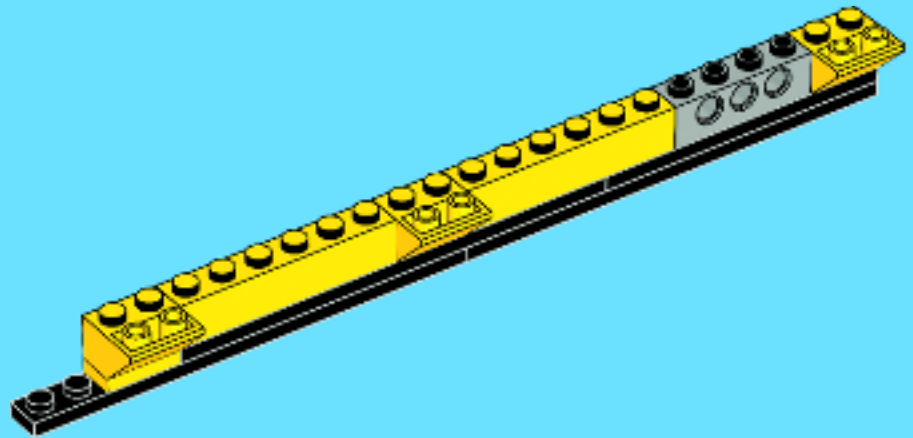

4

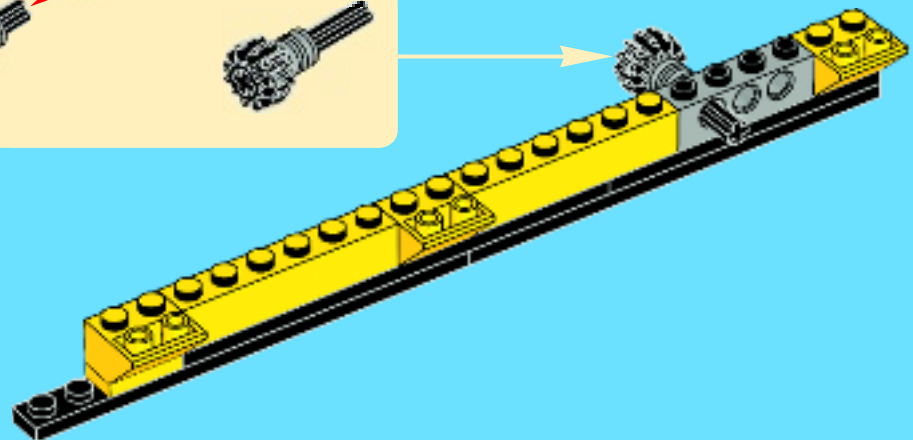
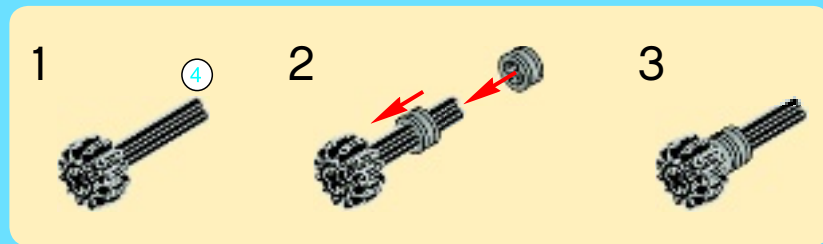

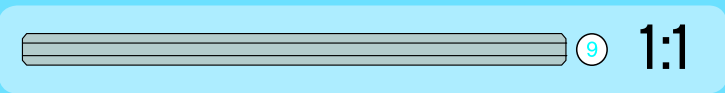
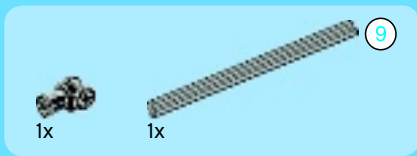

5

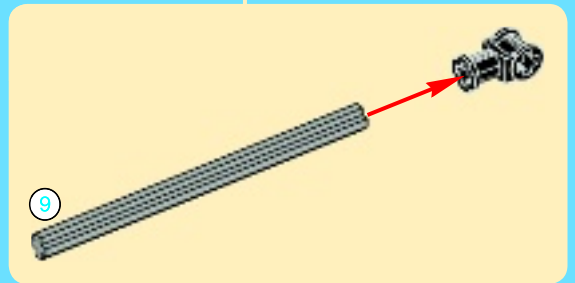
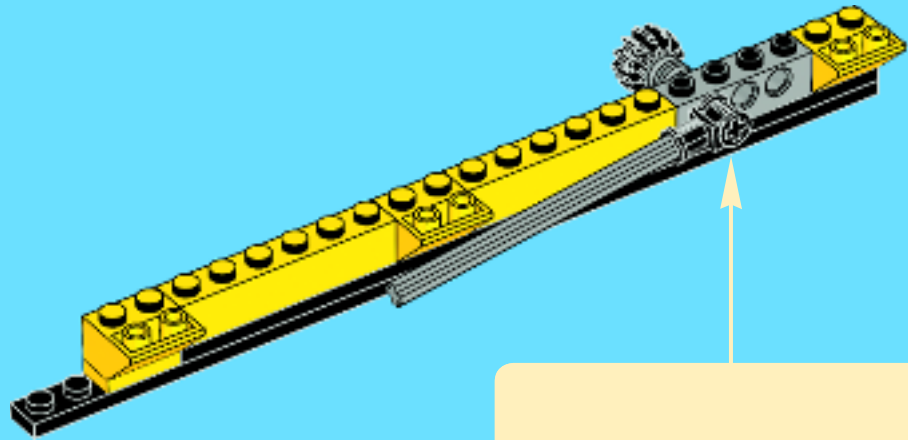

6

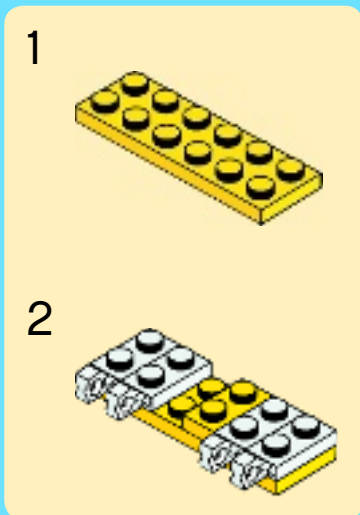
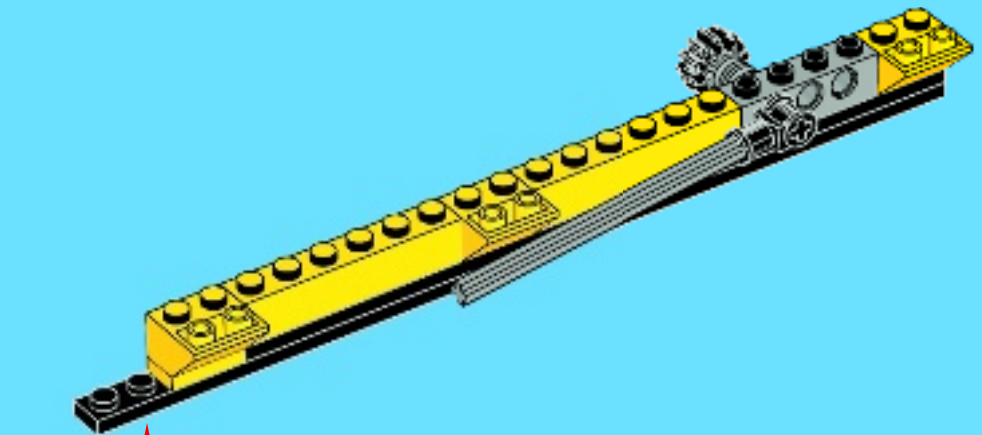



1x



2x

7

1

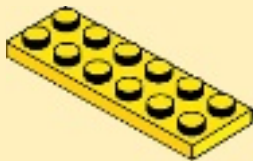

2

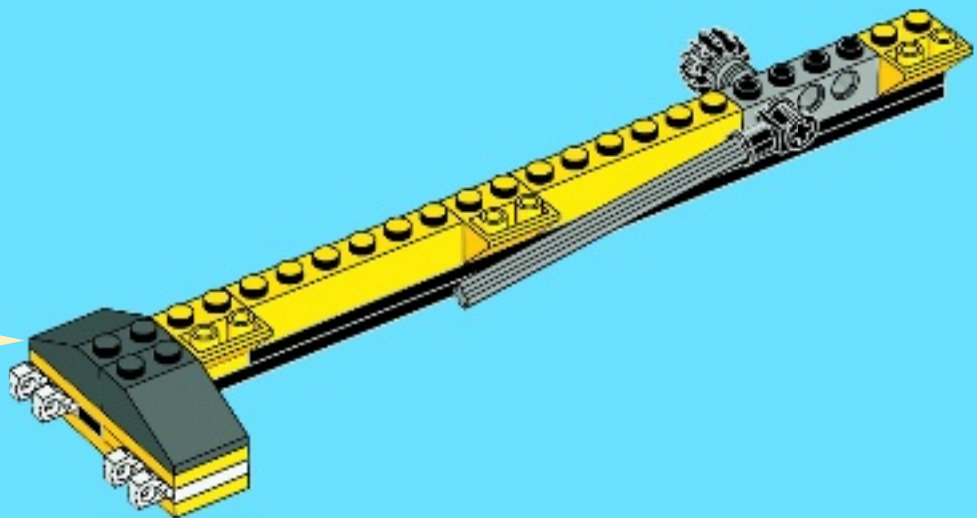
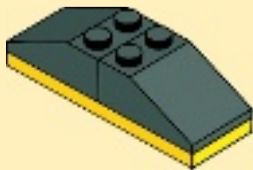

3x

8

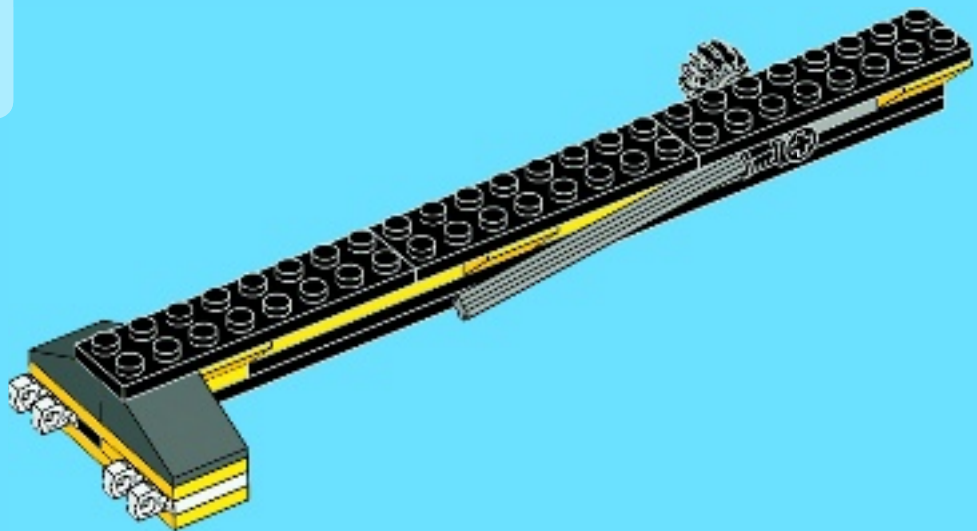

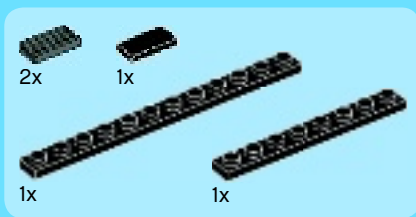

9

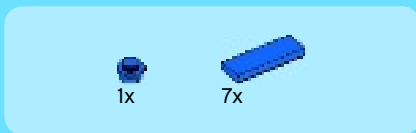
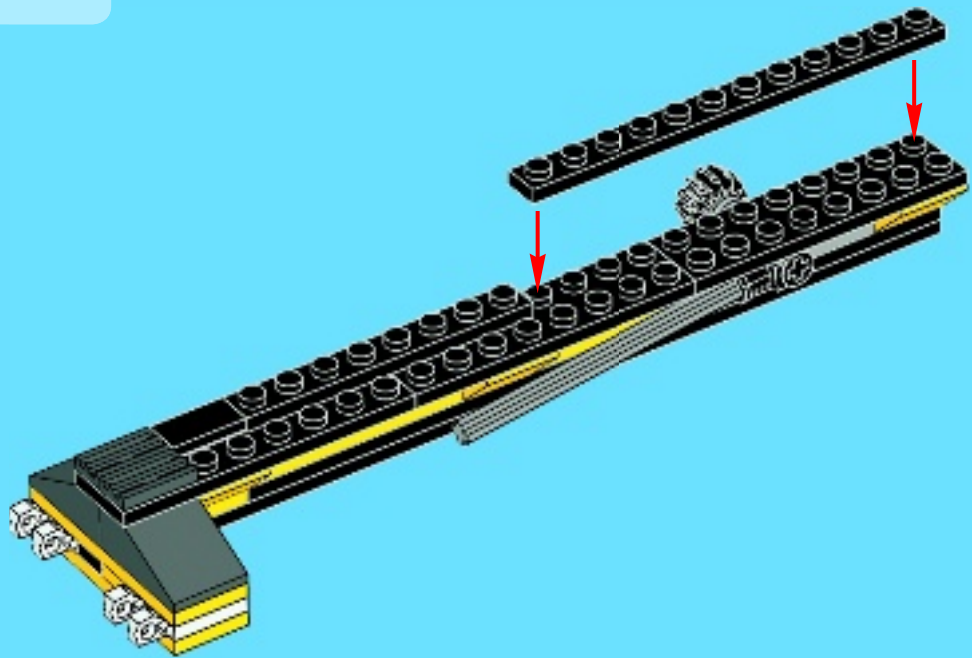

10

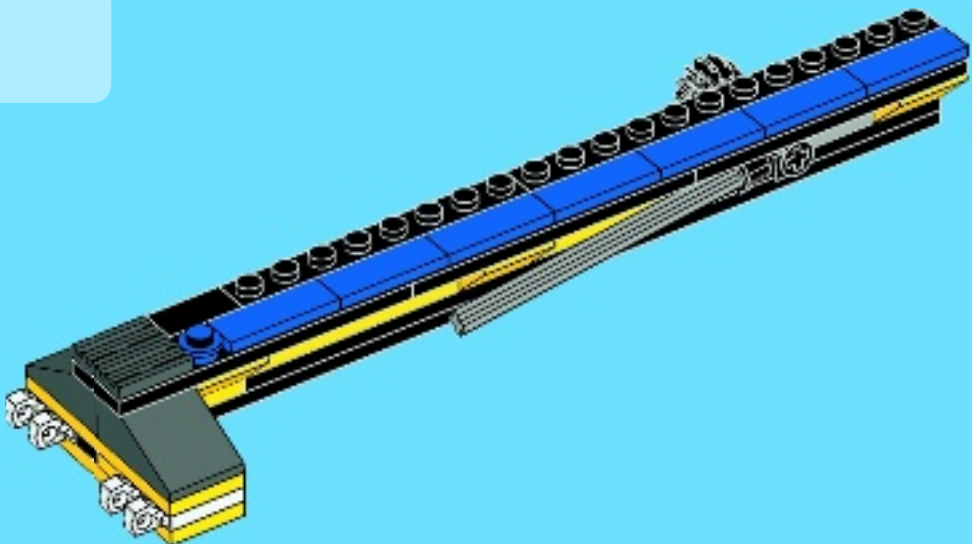

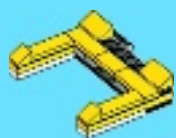

1x

1



1x



4x

2



2x

3

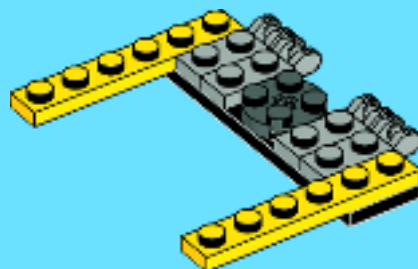



1x

4

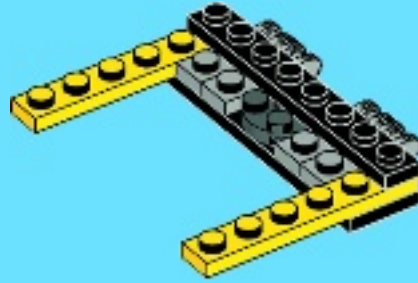

2x

5

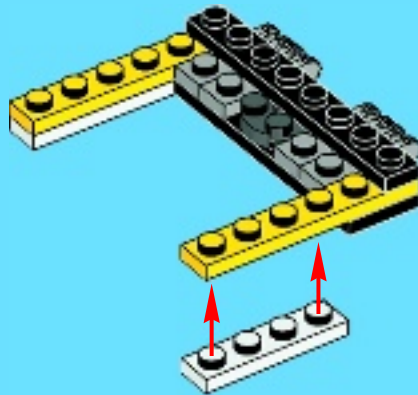



1x

4x

6

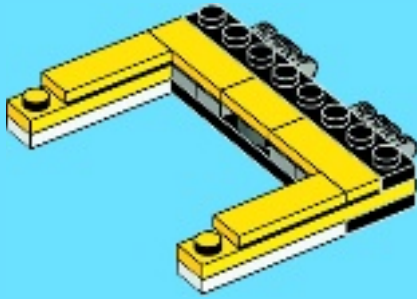

2x

2x

7

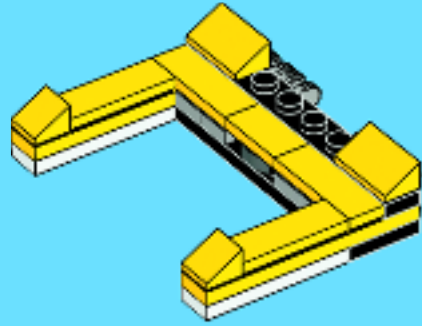

8

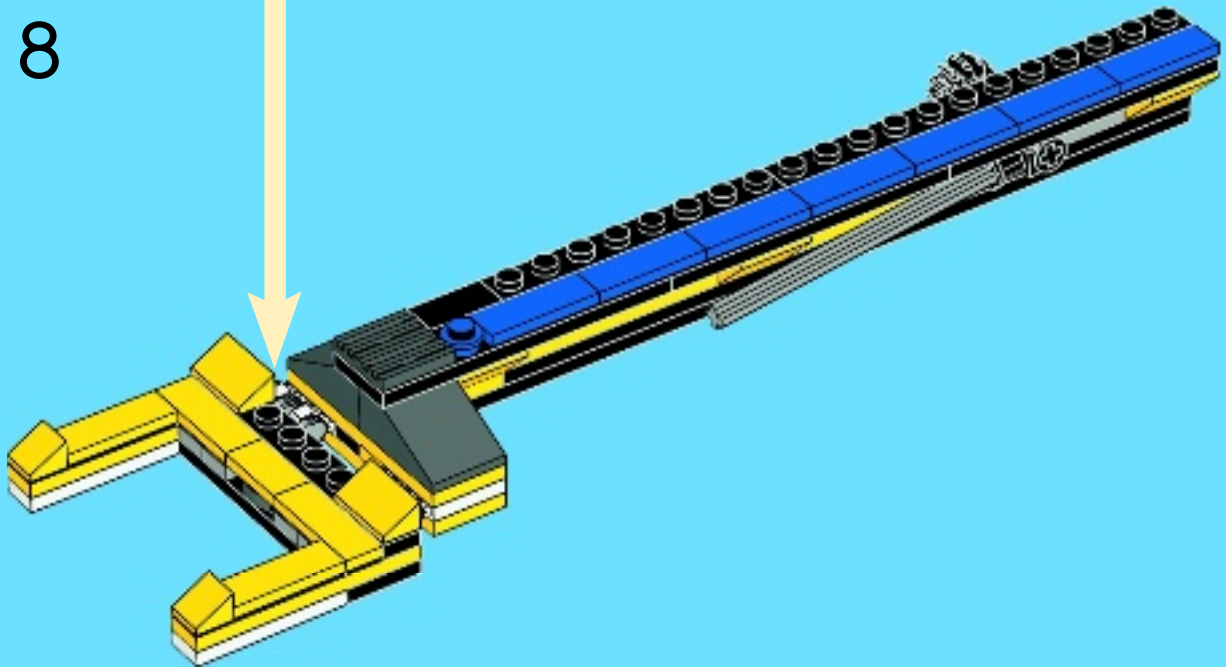

2x

1x

5

5

1:1

49

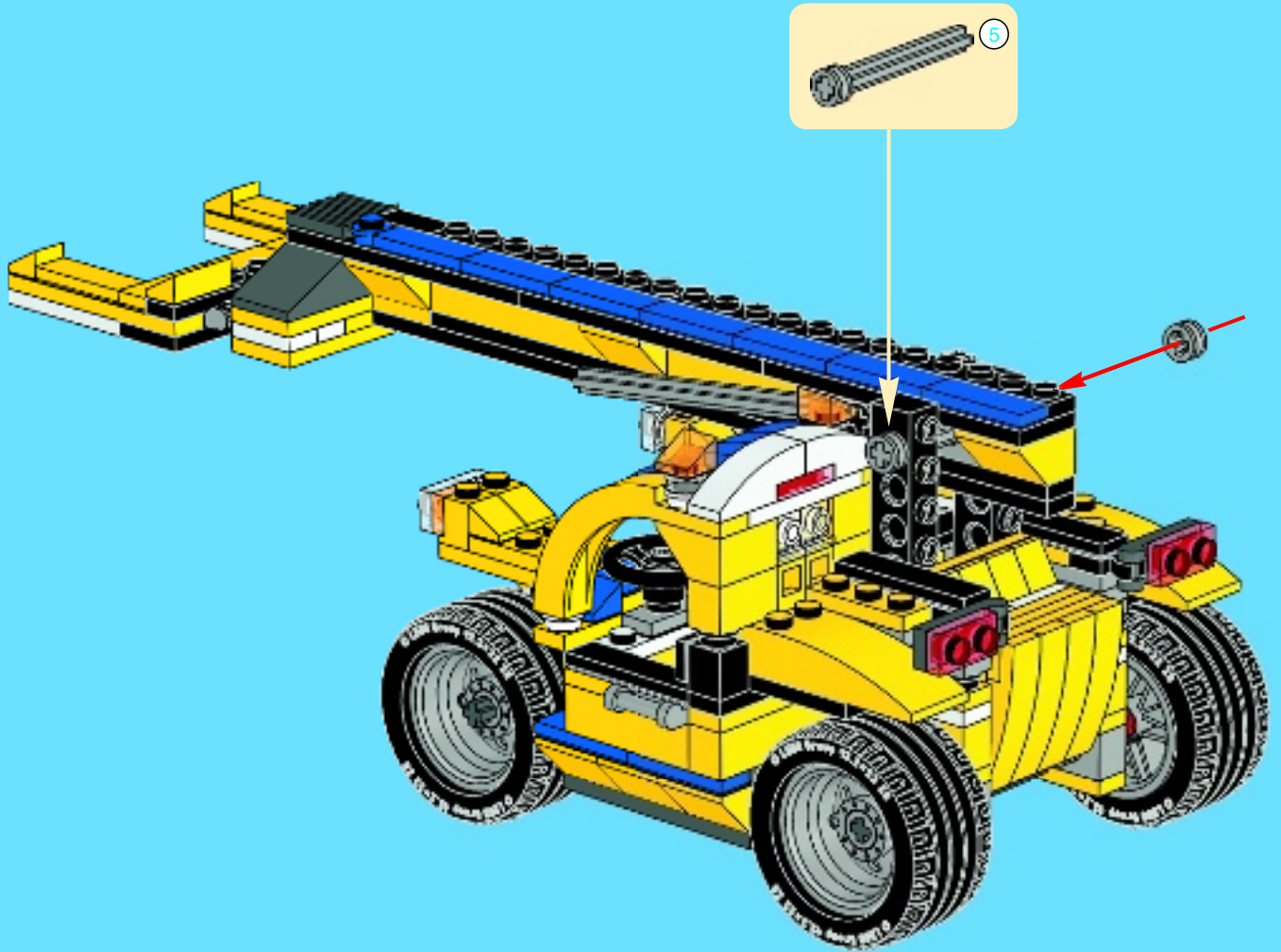

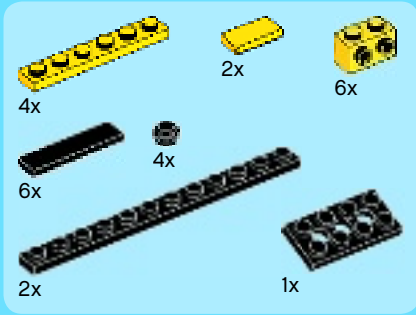

50

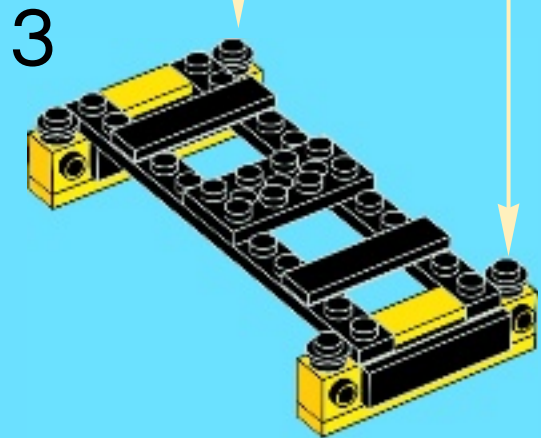
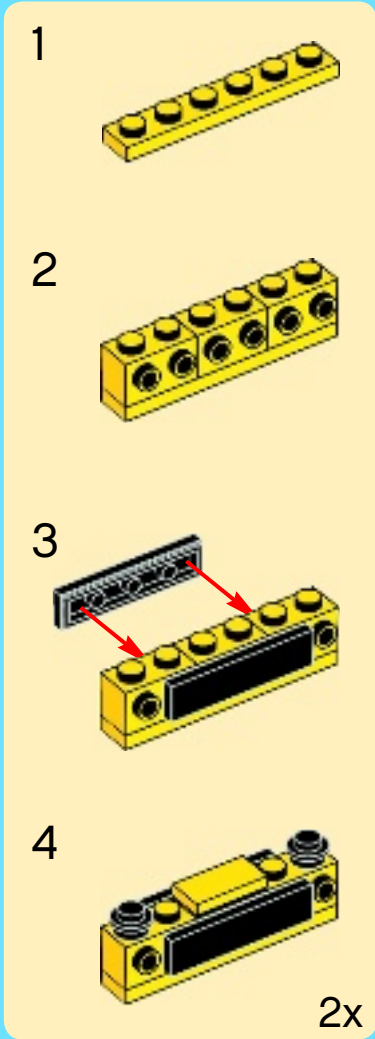
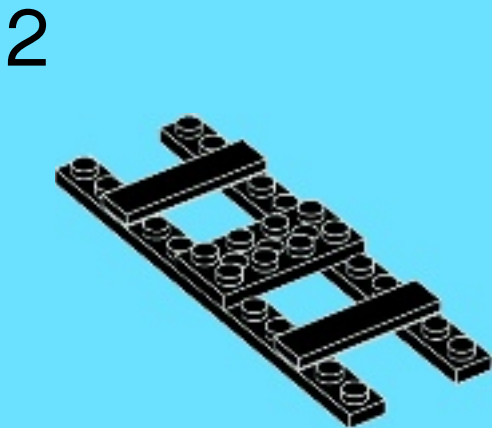

4

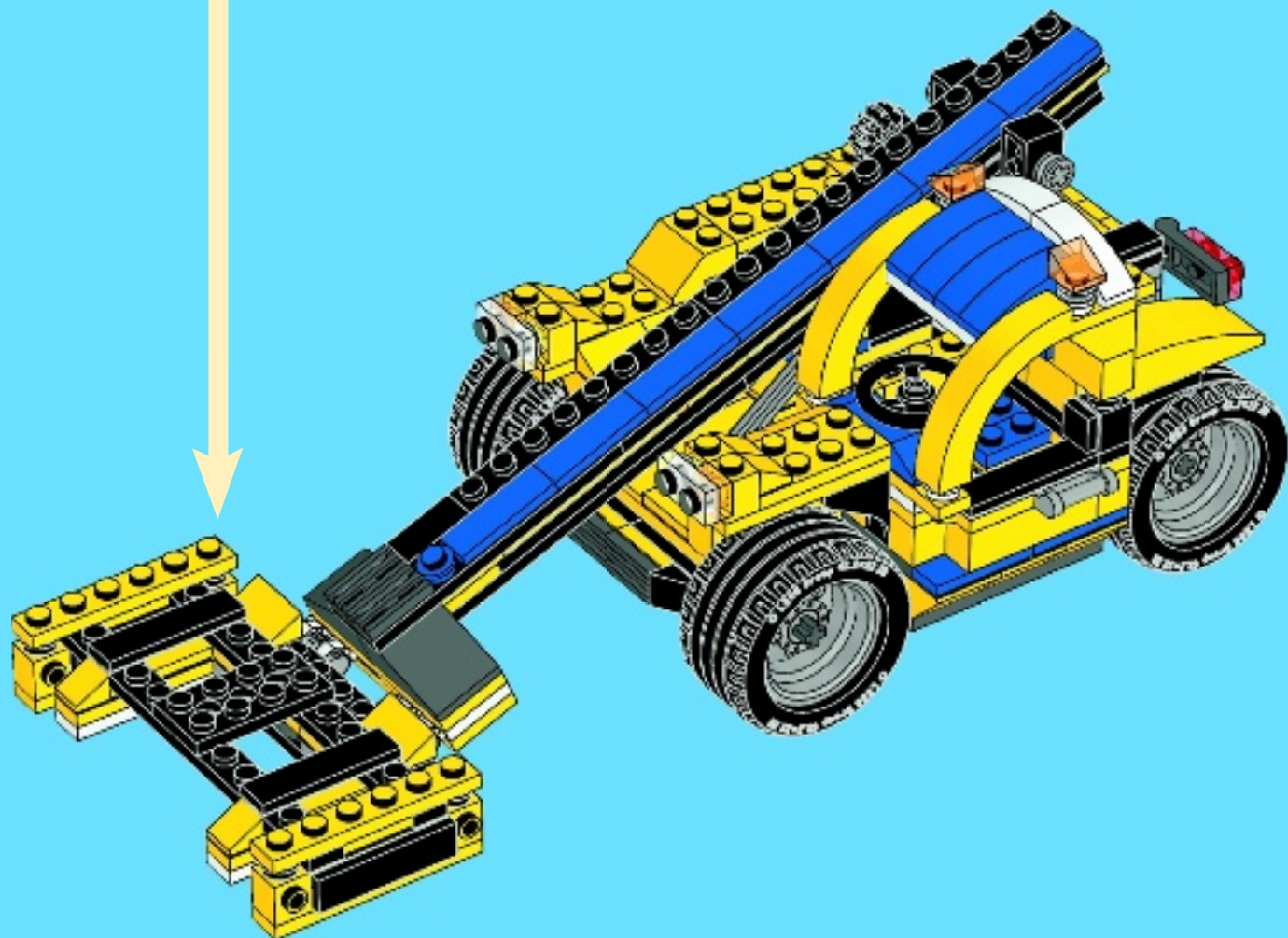
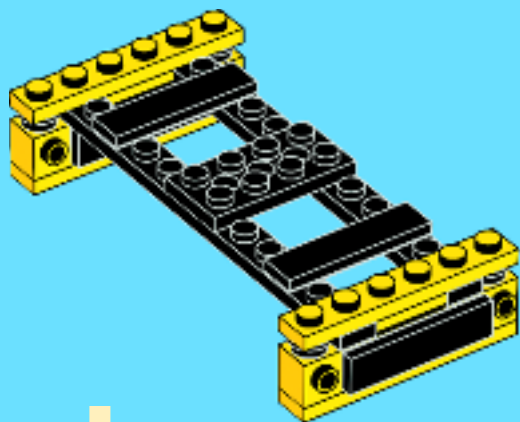



2x



2x

51

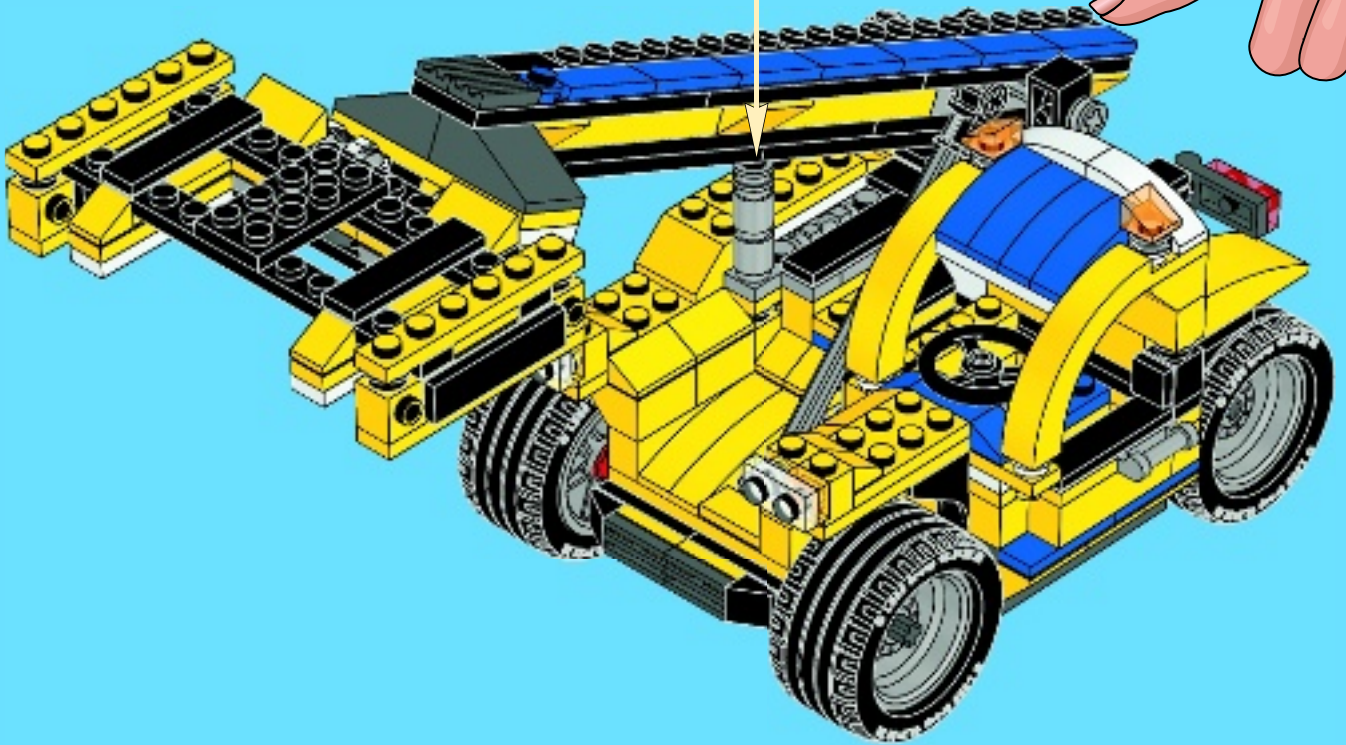
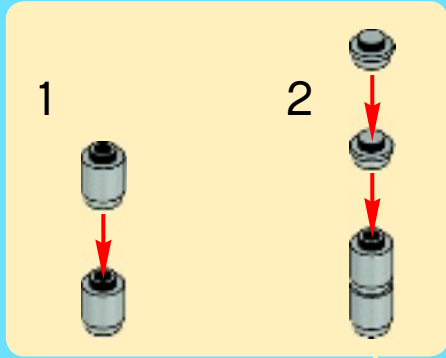

4x 4504380
 4x 4543998
 2x 306923
 8x 302323
 14x 4587840
 2x 614123
 2x 4143005
 4x 4514553
 3x 4210636
 2x 4211106
 4x 4210797
 4x 4210631
 1x 4210660
 6x 4521187
 1x 4225733
 2x 4271344
 1x 4211042
 1x 4210694
 4x 4516546
 2x 4560177
 2x 4508553
 2x 4514559
 4x 4211050

2x 362201
 2x 300201
 2x 4249112
 8x 302101
 5x 371001
 2x 243101
 7x 302001
 4x 4183035
 4x 614101
 10x 407024
 10x 4557157
 18x 4504381
 10x 366524
 7x 4550348
 8x 4121965
 2x 4264338
 2x 303924
 18x 366024
 14x 4522035

14x 300424
 6x 362224
 5x 301024
 2x 300924
 5x 302224
 4x 302124
 9x 371024
 7x 302024
 10x 366624
 7x 379524
 2x 4282745
 4x 4160392
 2x 4625813
 2x 4180546
 2x 4501536
 2x 4271084
 2x 4271087
 1x 4625815
 1x 4625820

7x 306924
 4x 306924
 2x 242024
 12x 302324
 12x 362324
 6x 4558172
 4x 4205196
 2x 4179095
 2x 4179094
 2x 307026
 4x 306926
 12x 243126
 2x 4558954
 4x 4162443
 2x 4584274
 4x 4598528
 6x 4504382
 4x 303926
 2x 4581280
 2x 4243819
 2x 300126
 1x 4181144

10x 614126
 4x 4550017
 1x 4180508
 1x 4180536
 1x 4580509
 1x 4107081
 6x 4121715
 1x 4526982
 1x 370526
 2x 4114671
 2x 4114670
 1x 4177431
 6x 362326
 5x 371026
 8x 346026
 1x 379526
 4x 303426
 1x 303526
 4x 273026
 1x 4275503
 9x 4514845

4x 302226
 2x 306826
 2x 4278359
 3x 4548180
 6x 370926
 4x 4184286
 3x 4666579
 2x 4565452
 2x 4179355
 8x 614121
 5x 4227155
 2x 4215618
 2x 4167842
 8x 3005740
 4x 4201019
 2x 4244369
 2x 4542673
 2x 4211359
 2x 4503416
 1x 4211837

20x 4211412
 5x 4211440
 4x 4297210
 1x 4227776
 8x 4211353
 5x 4541978
 1x 4211451
 2x 4244627
 5x 4211804
 6x 4211525
 2x 4211628
 14x 4211573
 1x 4211375
 3x 4211639
 1x 4535768
 1x 4251149
 1x 4211462
 2x 4211441
 2x 4211705

Customer Service
 Kundenservice
 Service Consommateurs
 Servicio Al Consumidor

www.lego.com/service or dial

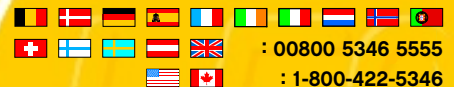

: 00800 5346 5555

: 1-800-422-5346



WIN!

Go to www.LEGOsurvey.com/product to fill out a survey for a chance to win a cool LEGO® Product.

No purchase necessary.

Open to all residents where not prohibited.

 www.LEGO.com



www.LEGOsurvey.com/product

GEWINNE!

Nimm an der Umfrage auf www.LEGOsurvey.com/product teil und hab die Chance ein cooles LEGO® Produkt zu gewinnen!

Die Teilnahme am Gewinnspiel führt zu keinerlei Kaufverpflichtungen. Teilnahme in allen nicht ausgeschlossenen Ländern möglich.

WIN!

Ga naar www.LEGOsurvey.com/product, vul een enquêteformulier in en maak kans op een cool LEGO® product.

Geen aankoopverplichting. Iedereen mag deelnemen, uitgezonderd ingezetenden van landen waar een enquêteverbod geldt.

GAGNE!

Visite www.LEGOsurvey.com/product pour répondre à un questionnaire et avoir une chance de gagner un produit LEGO® très cool!

Aucune obligation d'achat. Ouvert à tous les résidents des pays autorisés.

当てよう!

www.LEGOsurvey.com/product にアクセスして、アンケートにご記入ください。当選者にはレゴ®製品を差し上げます。

お買い上げの必要はありません。禁止されていない限り、すべての皆様にご利用いただけます。