



education



FIRST
LEGO
LEAGUE JR.

45810



 **BOOMTOWN
BUILD**

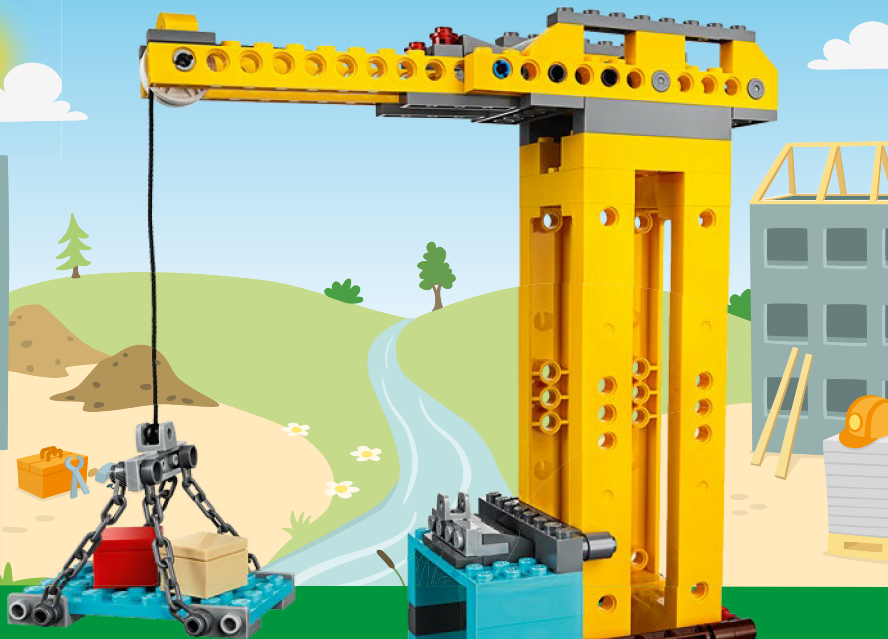

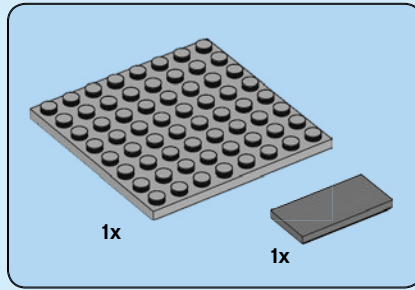
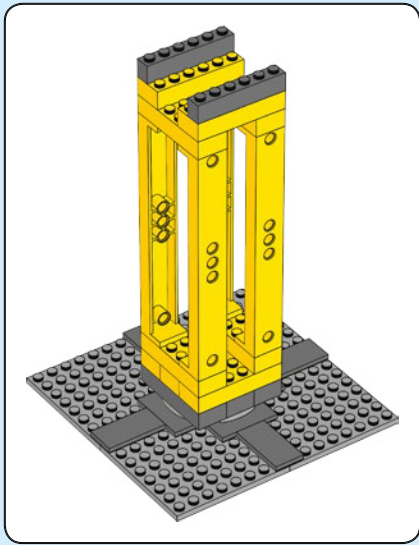

1

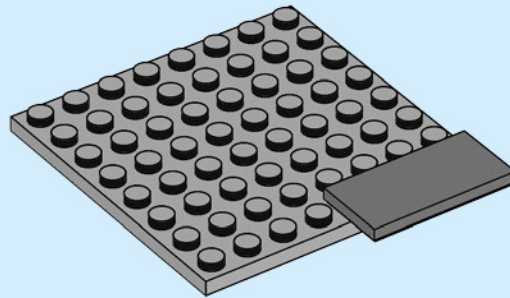

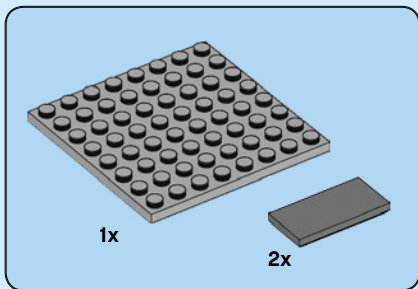

2

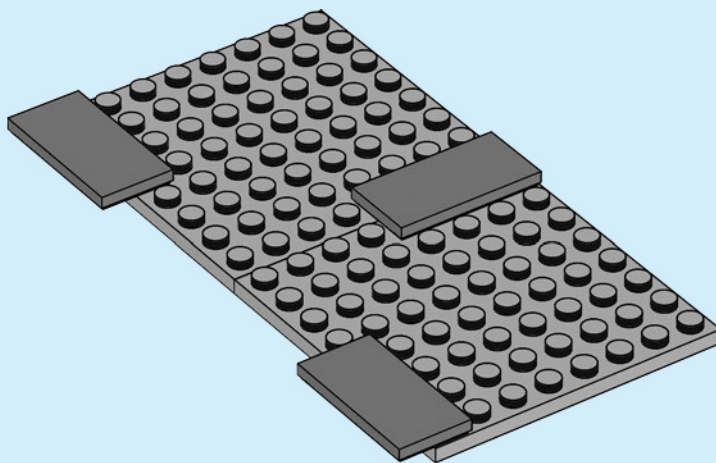

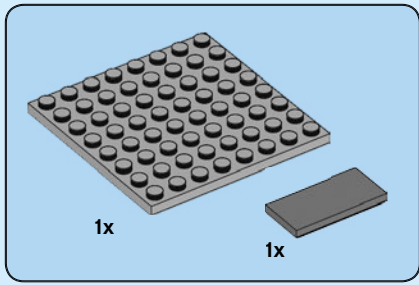

3

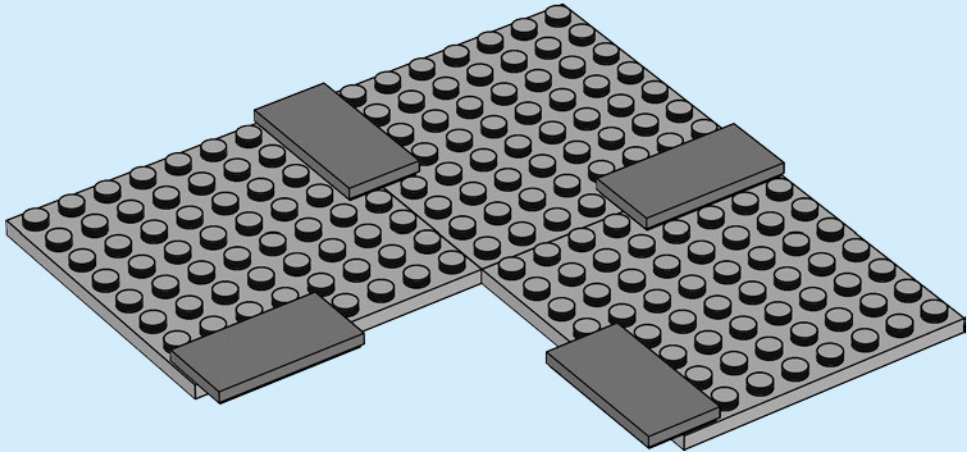

4

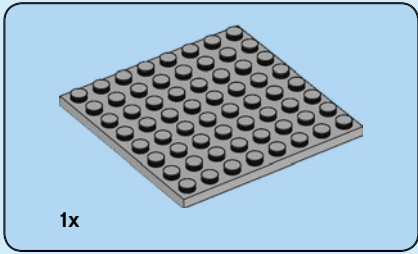

4

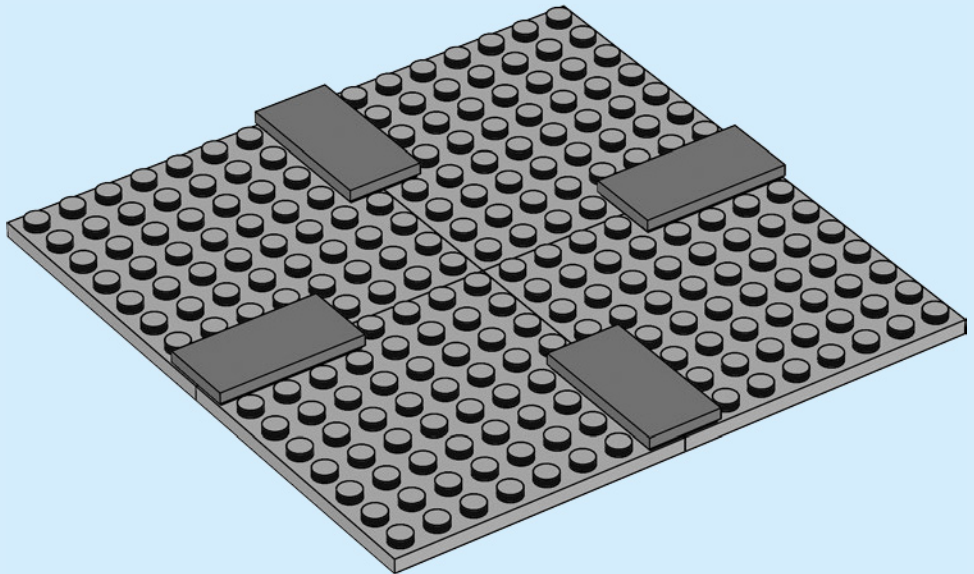

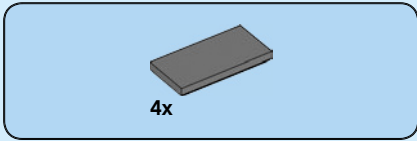

5

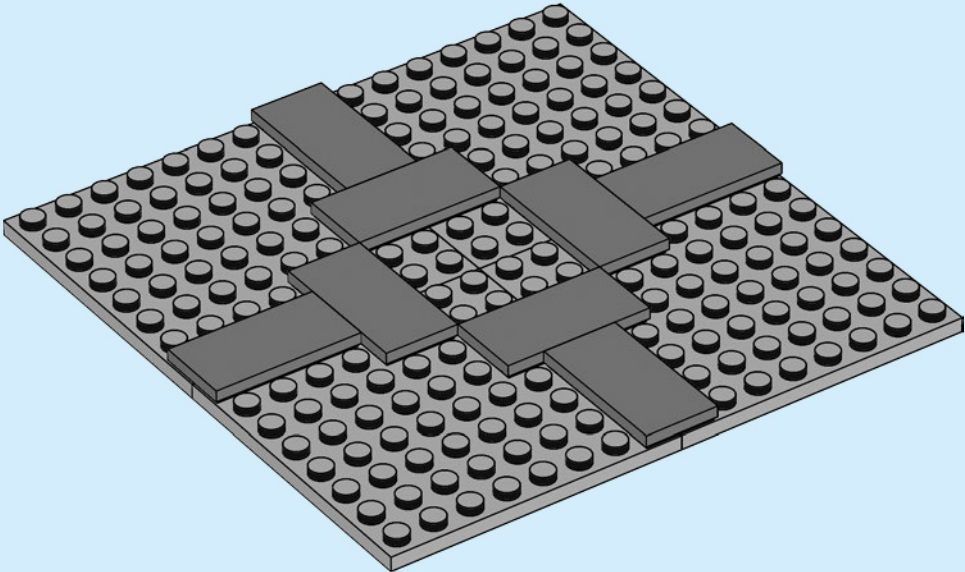

6

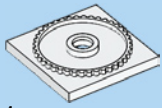

1x

6

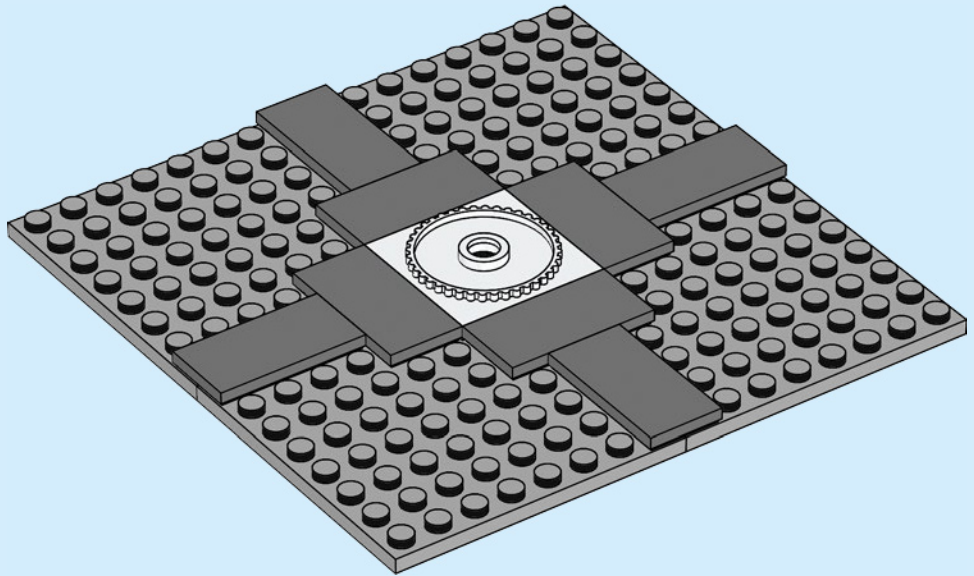

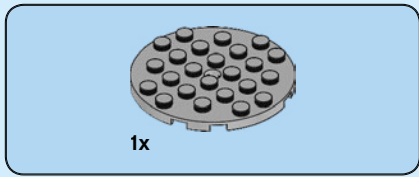

7

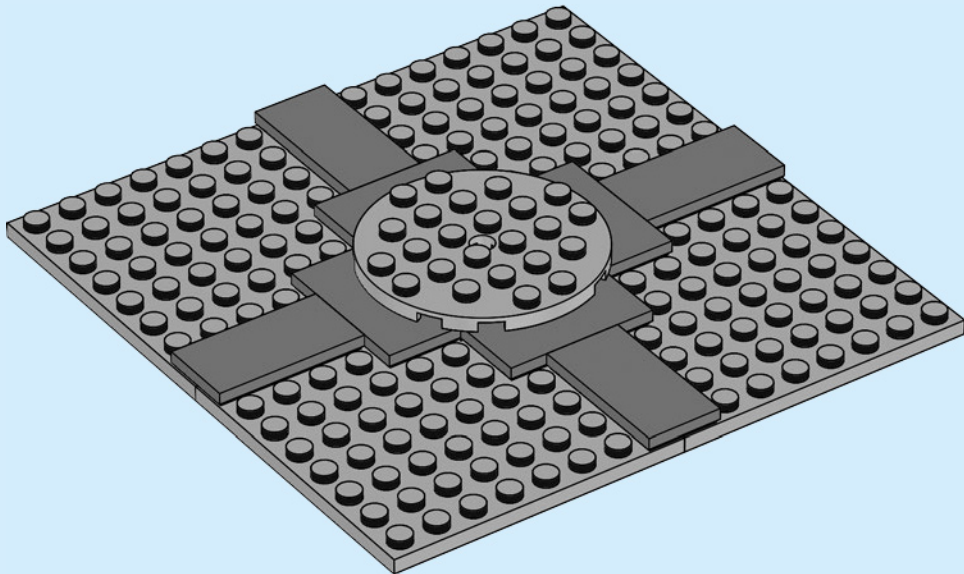

8



1x



1x

8

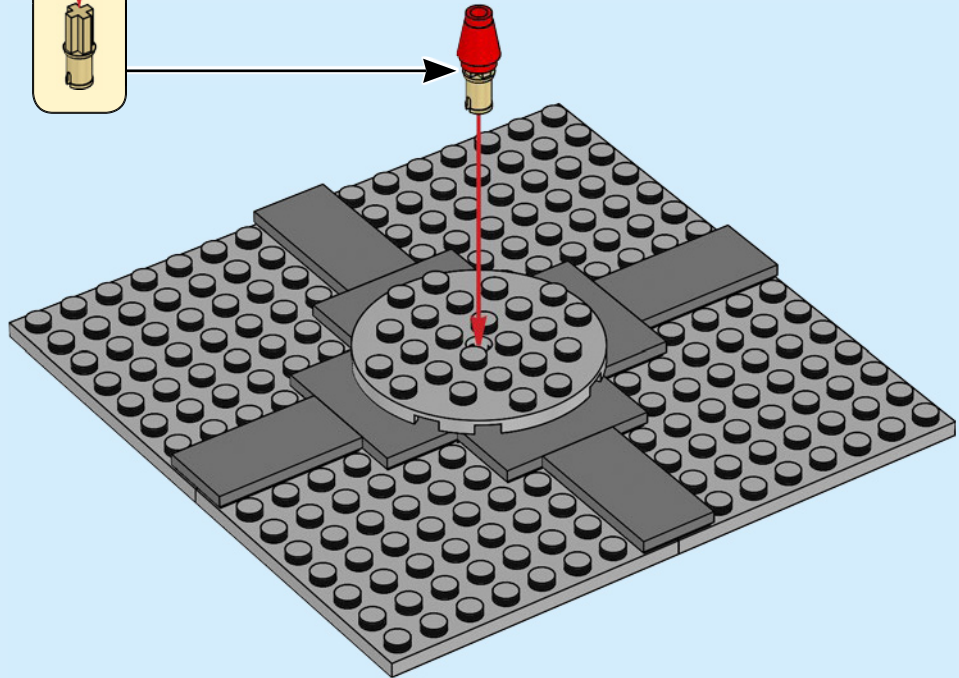
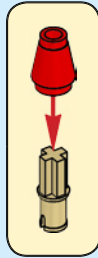

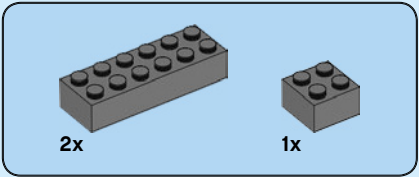

9

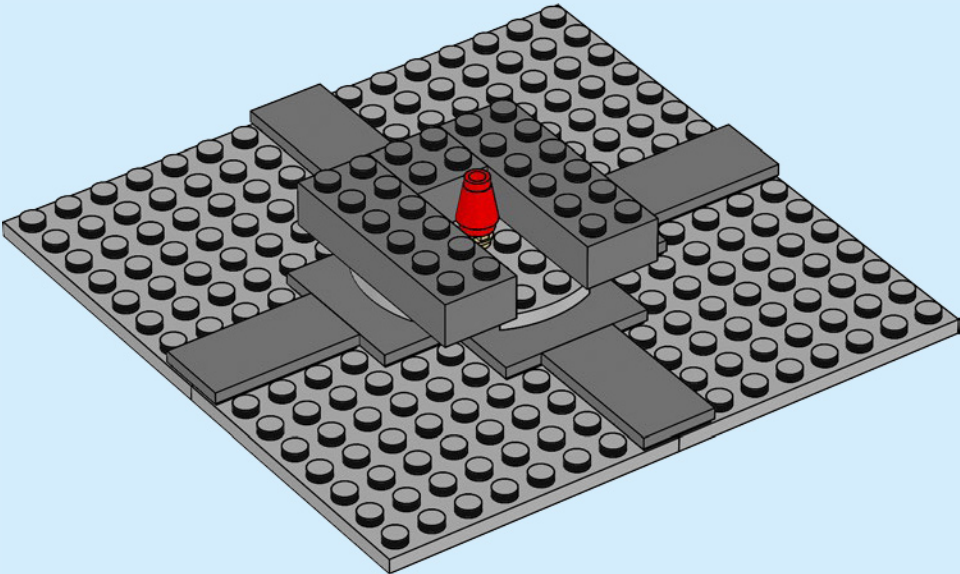

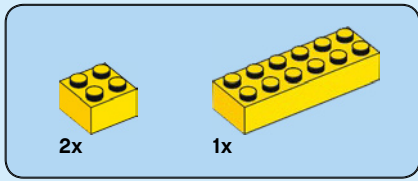

10

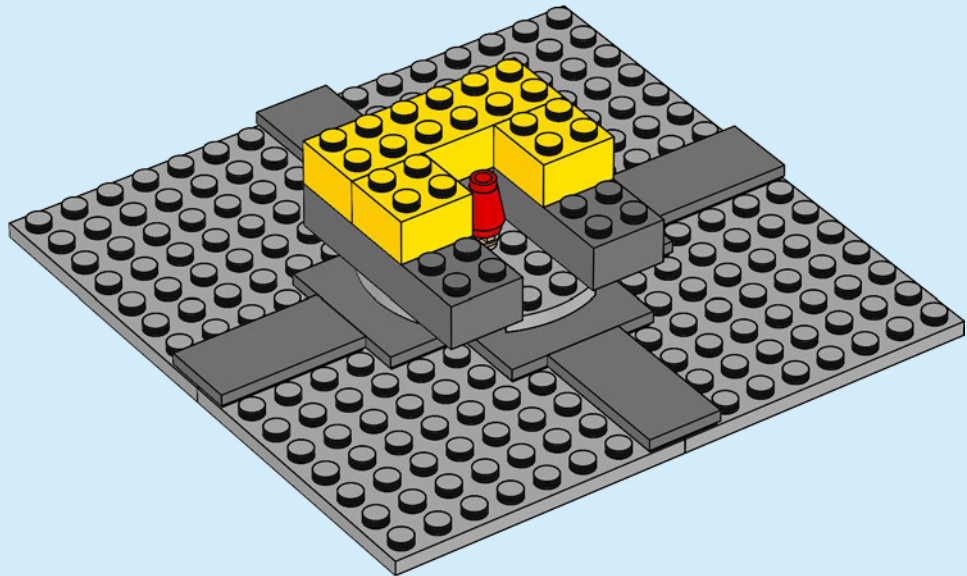



1x

11

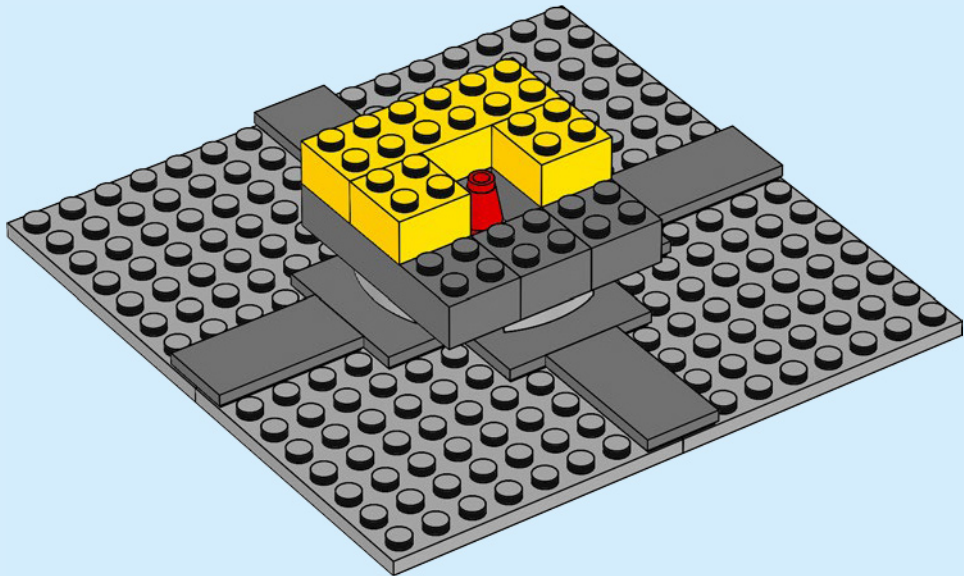

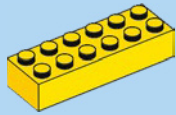

1x

12

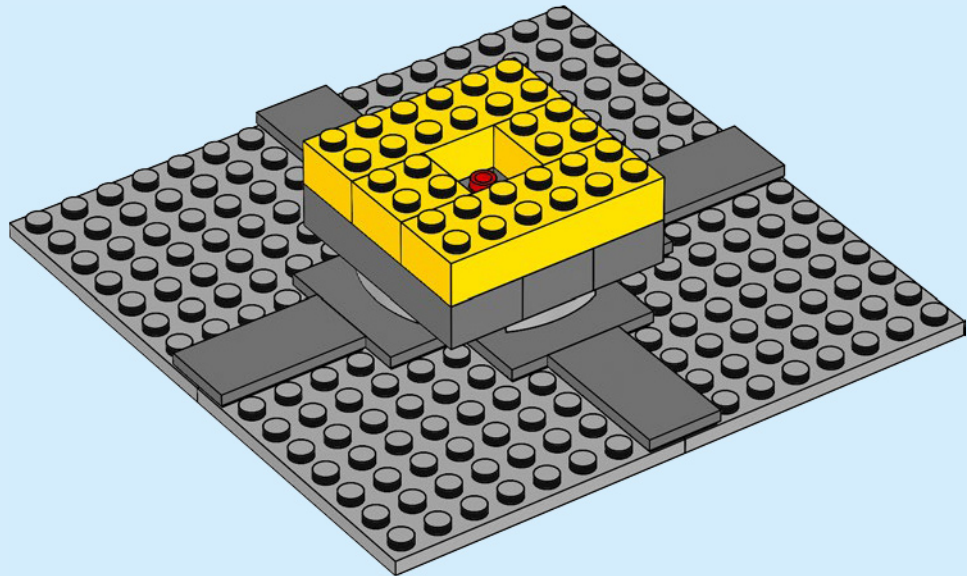

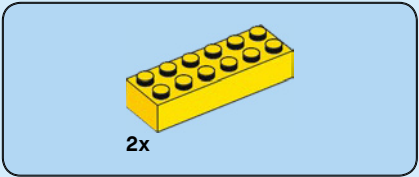

13

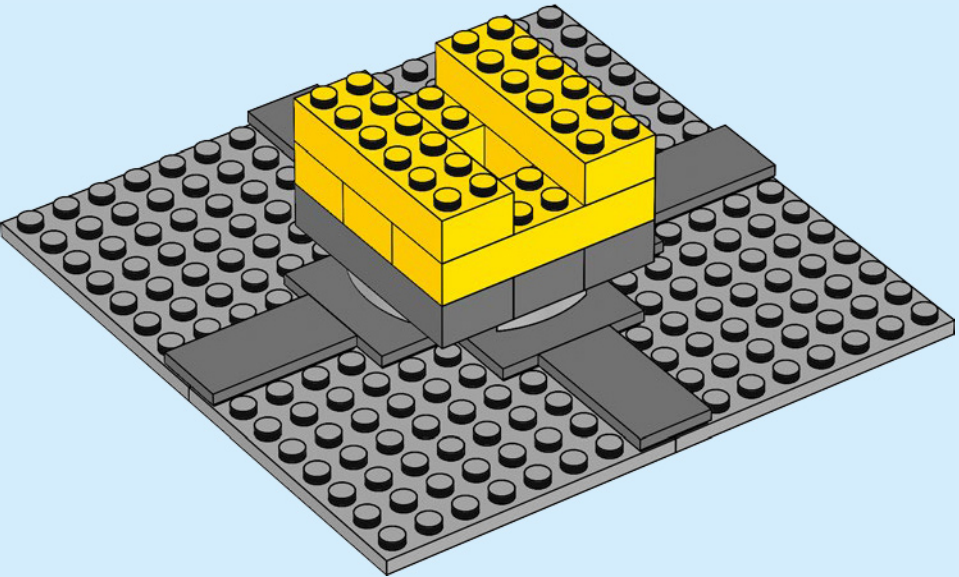

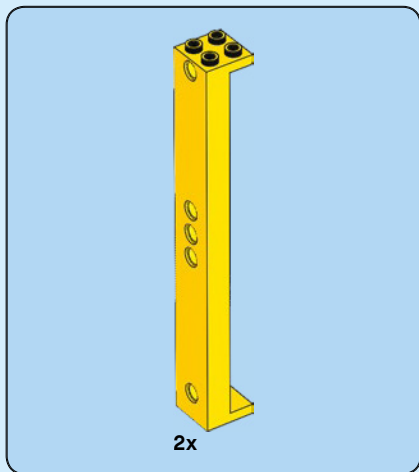

14

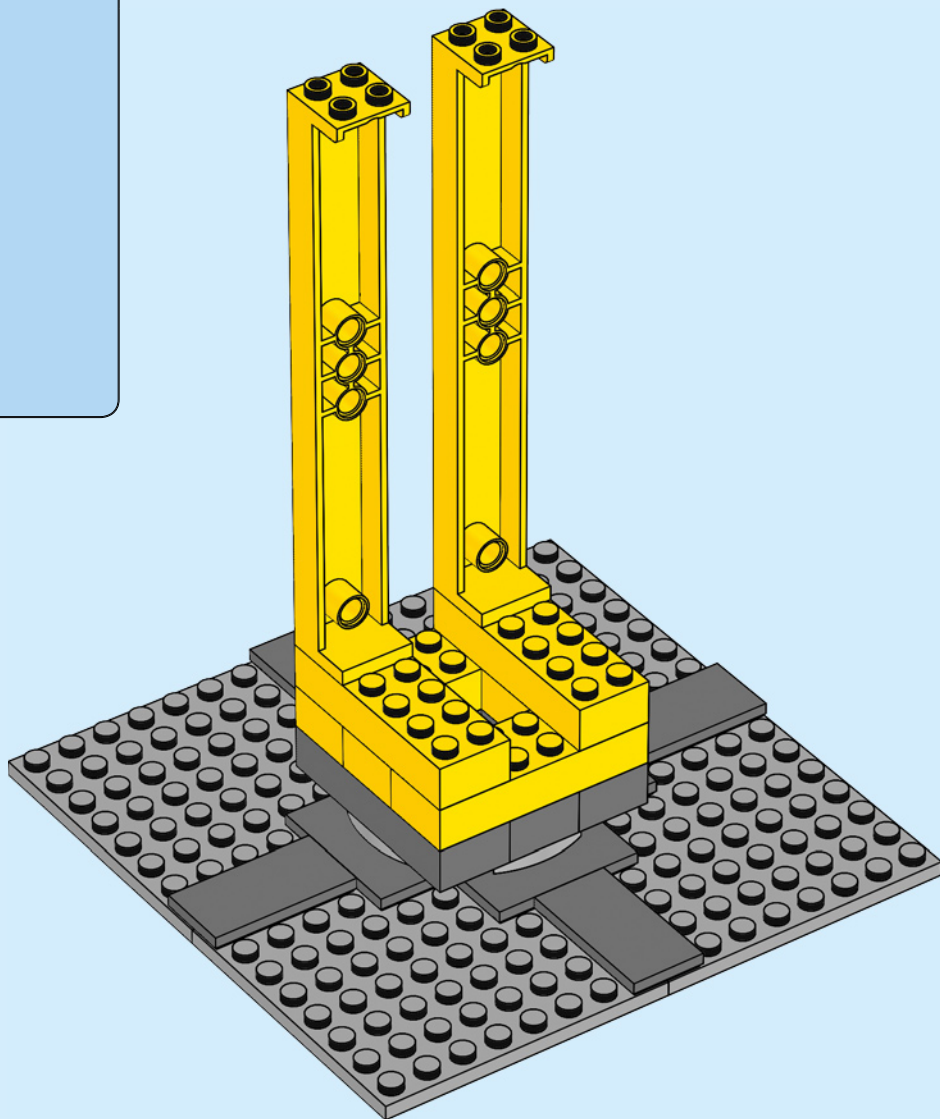

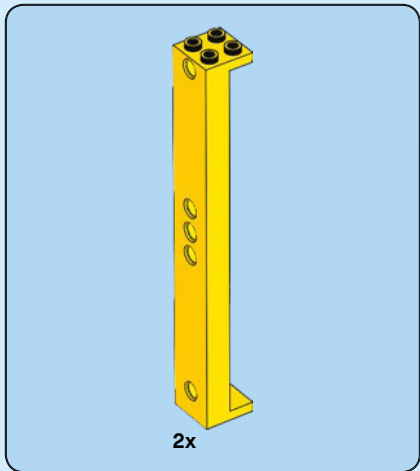

15

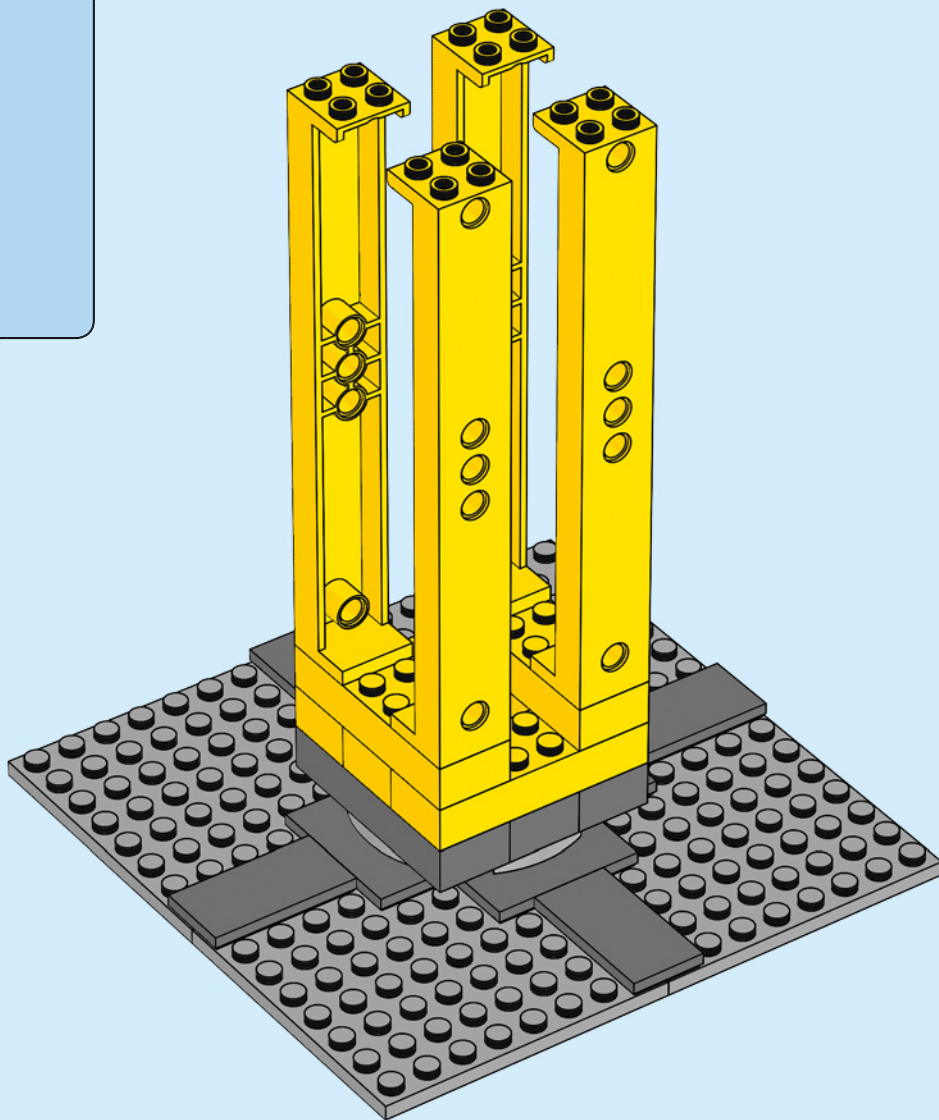

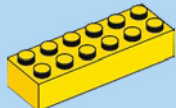

2x

16

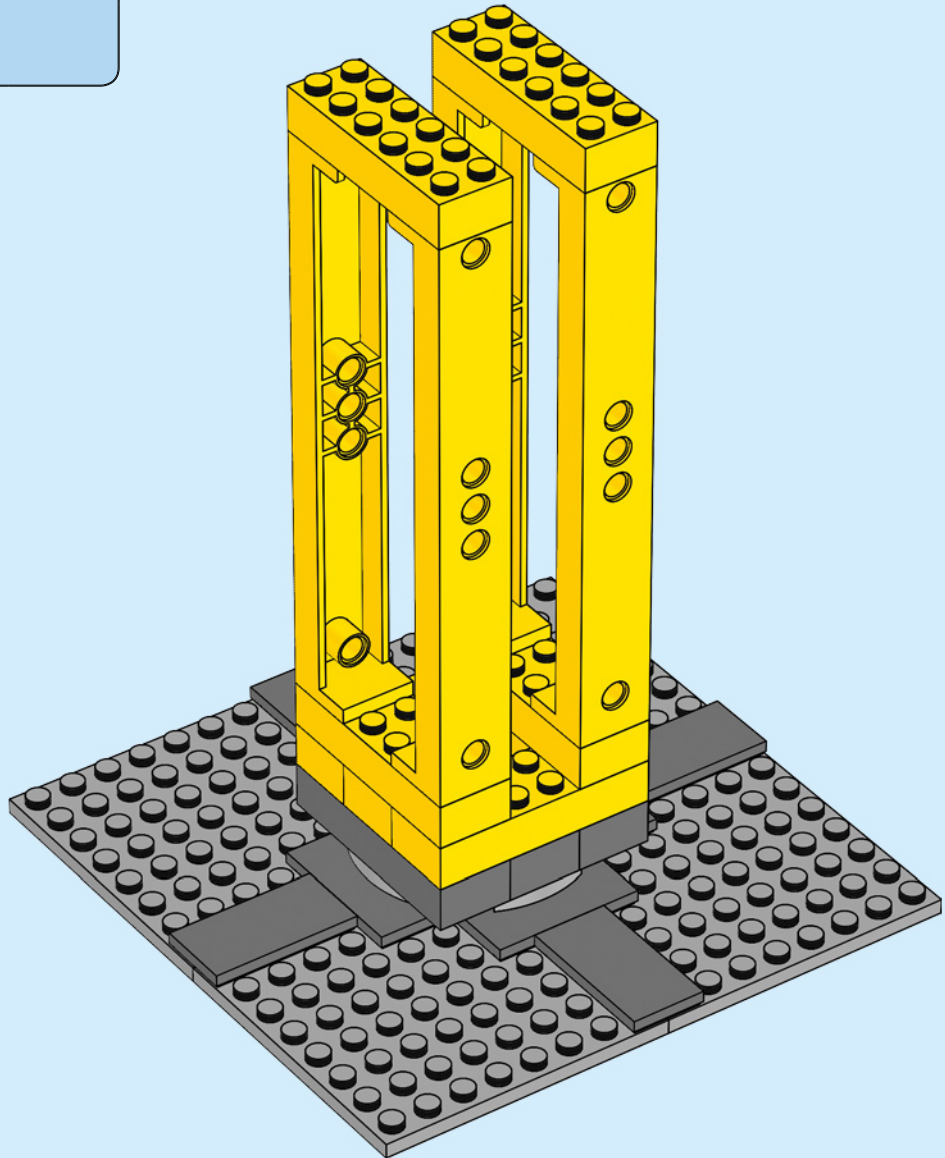

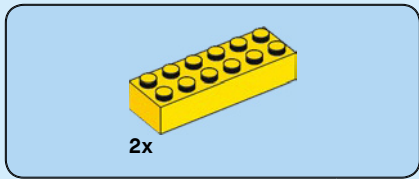

17

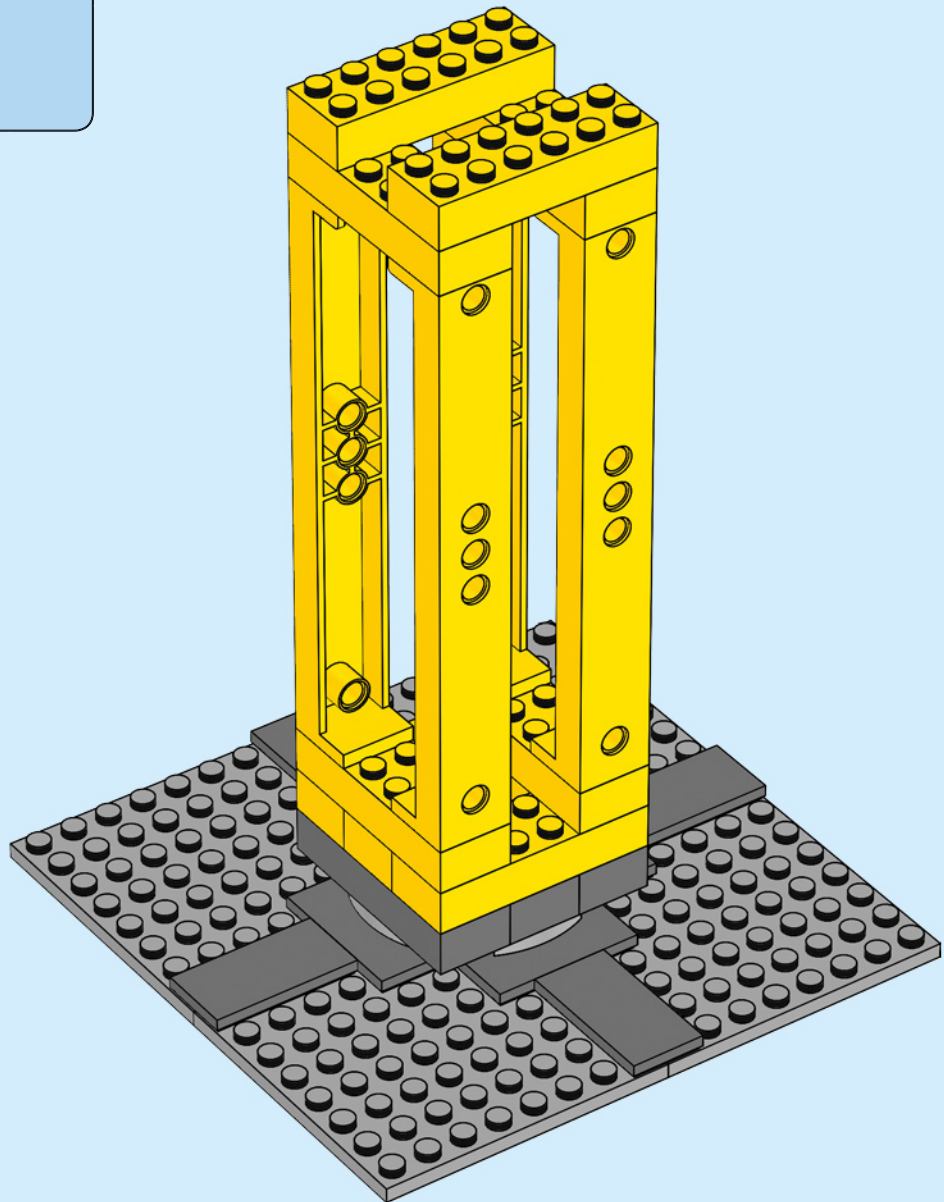

18

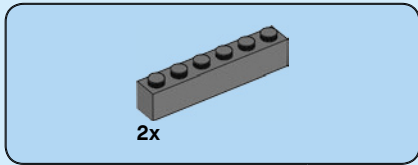

18

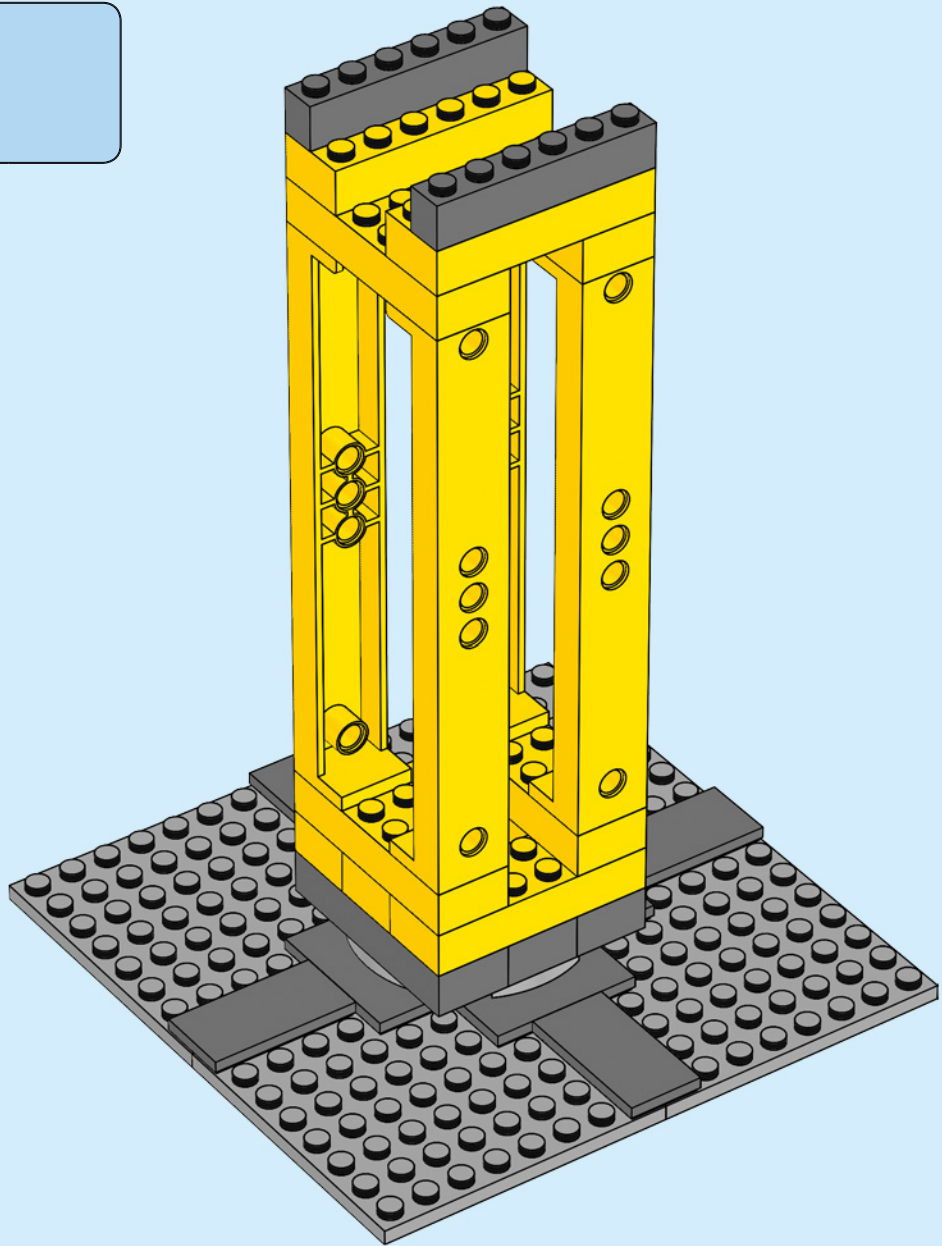

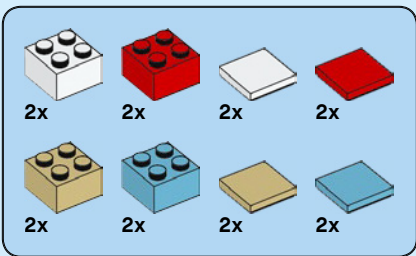

19

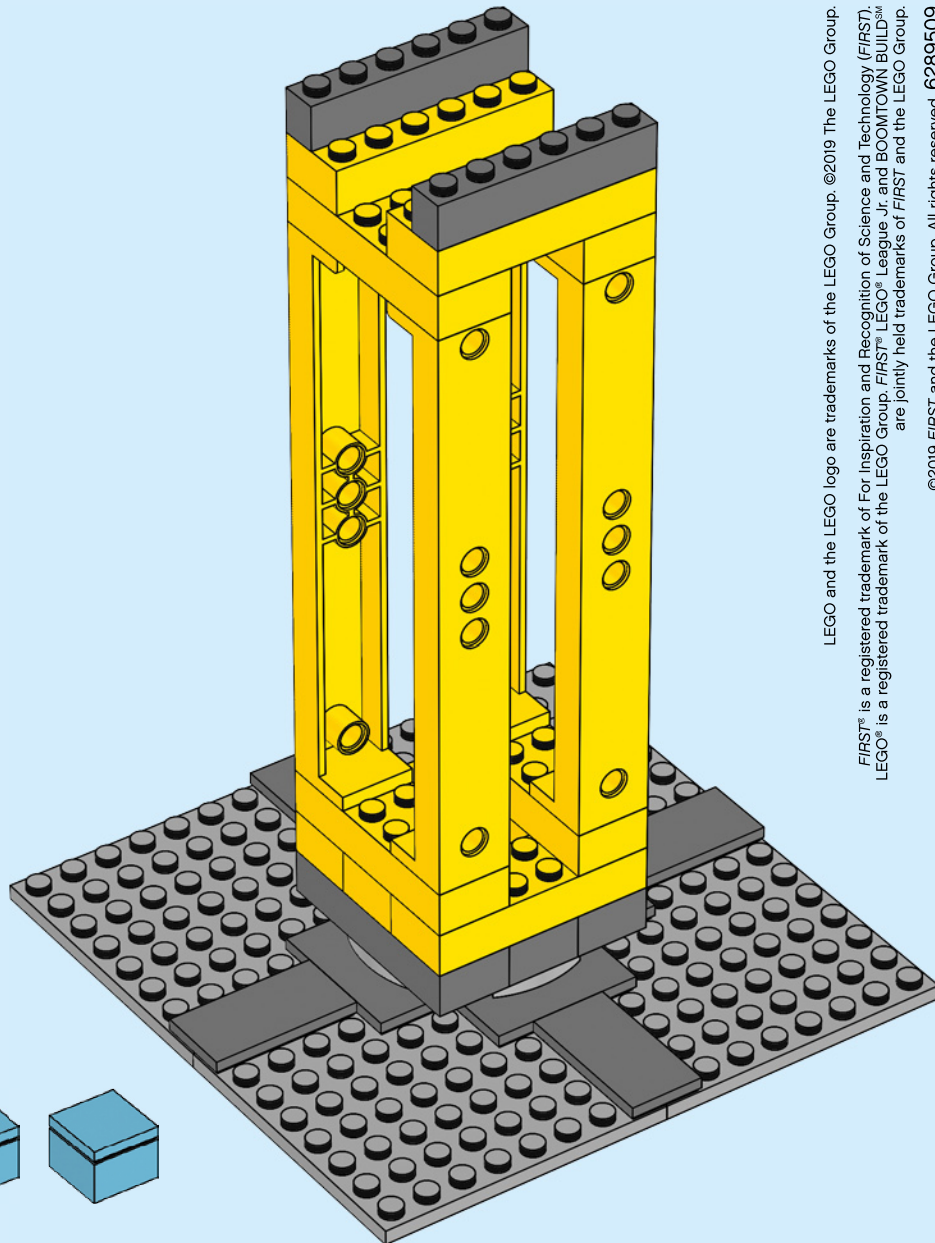
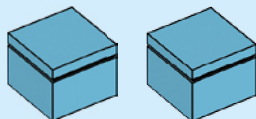
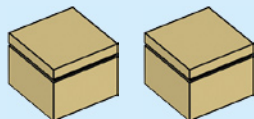
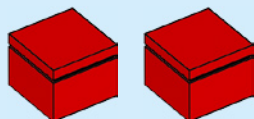
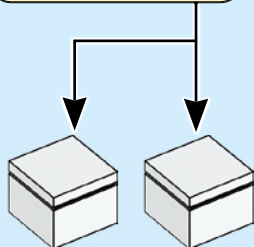
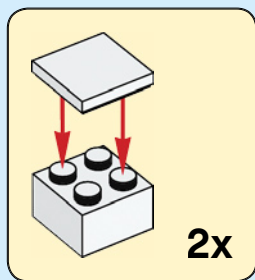

LEGO and the LEGO logo are trademarks of the LEGO Group. ©2019 The LEGO Group.
 FIRST® is a registered trademark of For Inspiration and Recognition of Science and Technology (FIRST).
 LEGO® is a registered trademark of the LEGO Group. FIRST™, LEGO® League Jr. and BOOMTOWN BUILD™ are jointly held trademarks of FIRST and the LEGO Group.
 ©2019 FIRST and the LEGO Group. All rights reserved. 6289509

20