

4597-4529

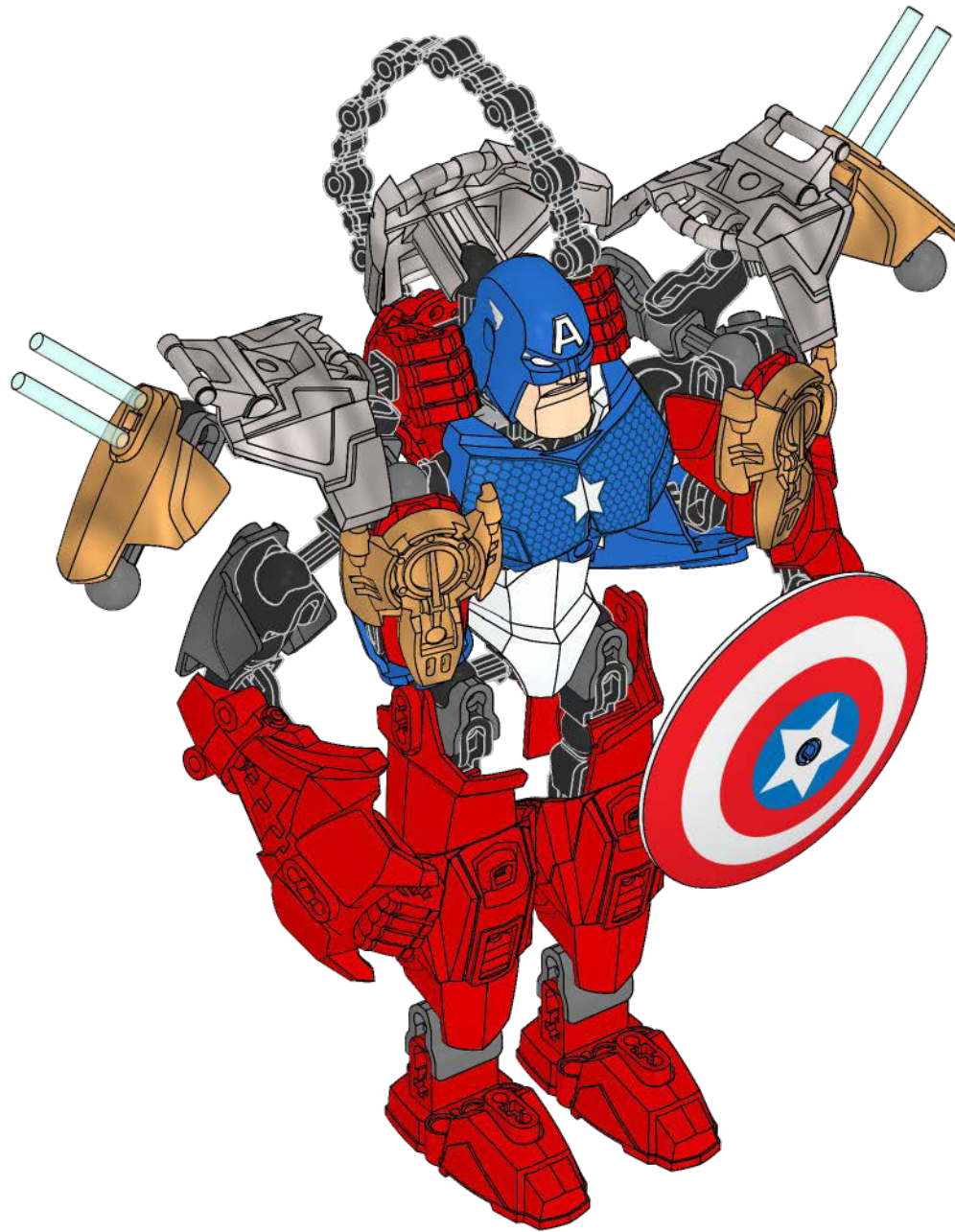

1

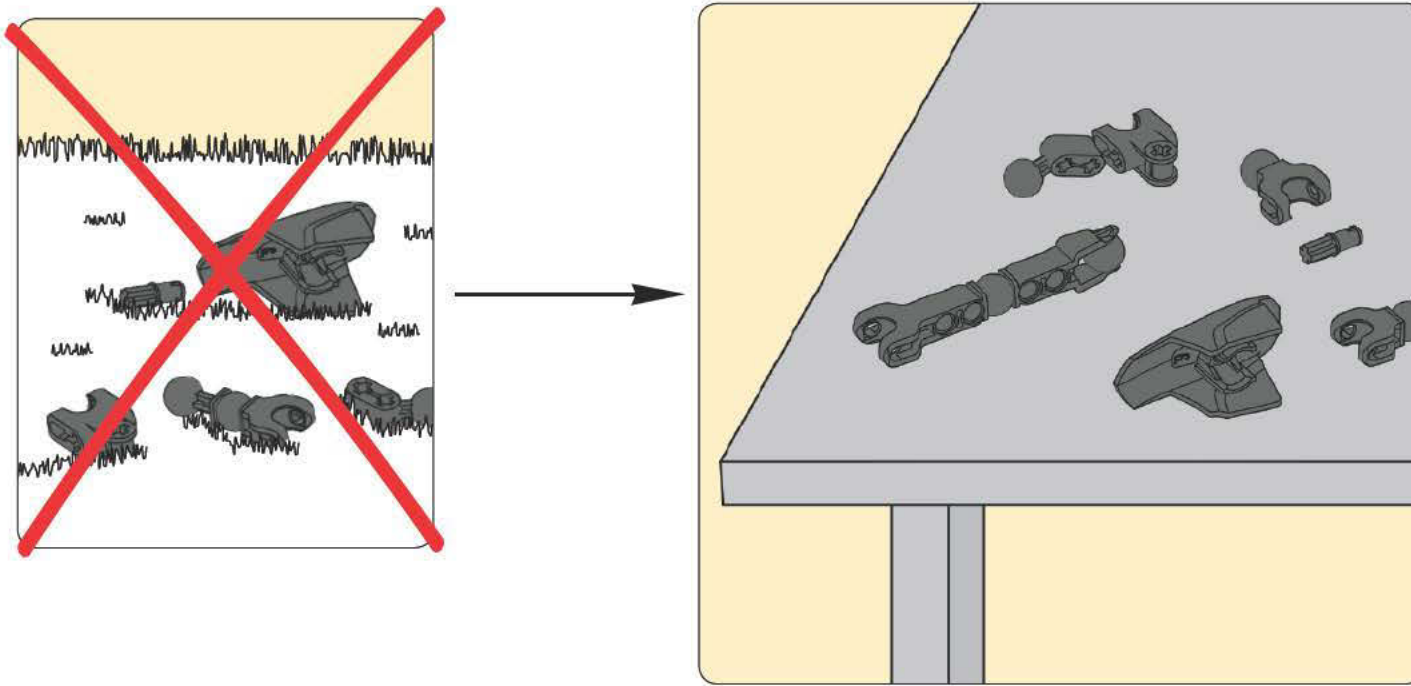

2

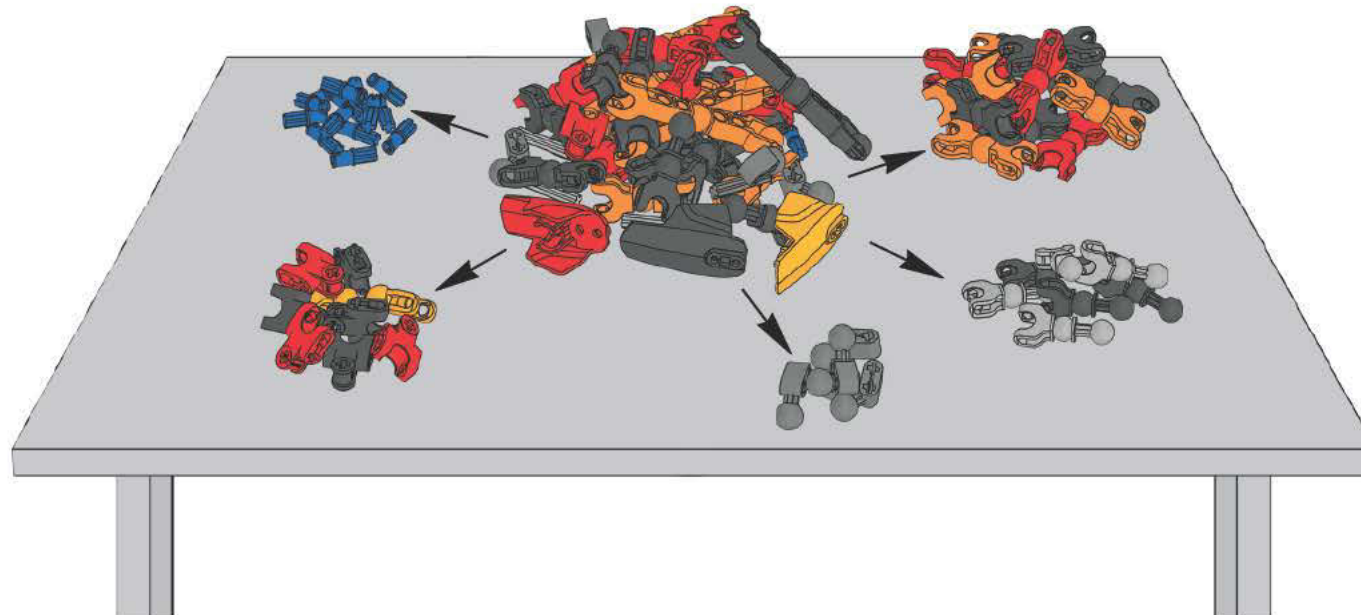

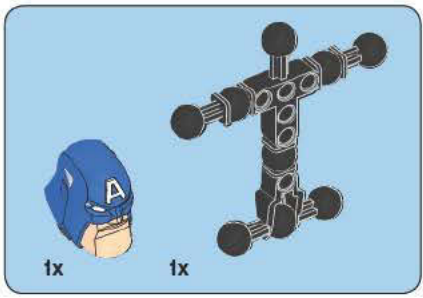

1

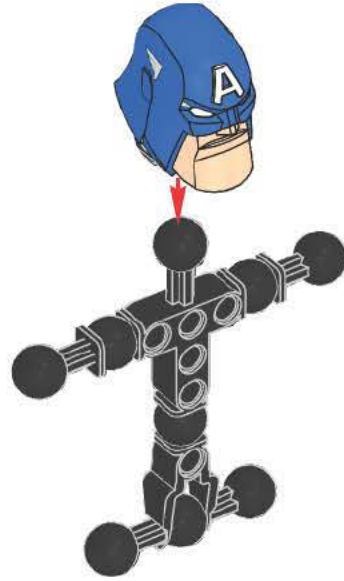

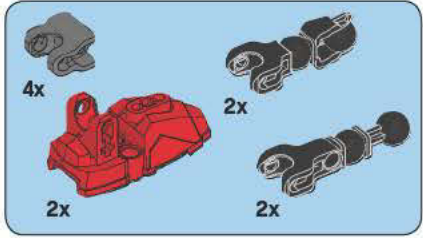
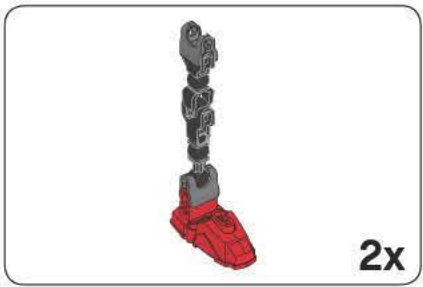

2

1



2

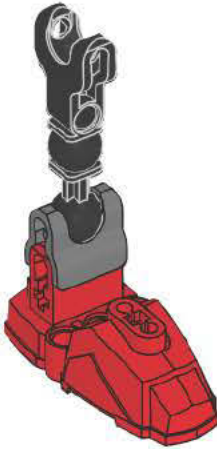

3

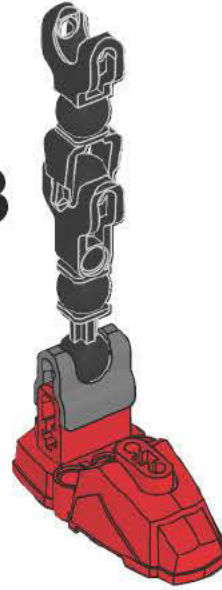

4

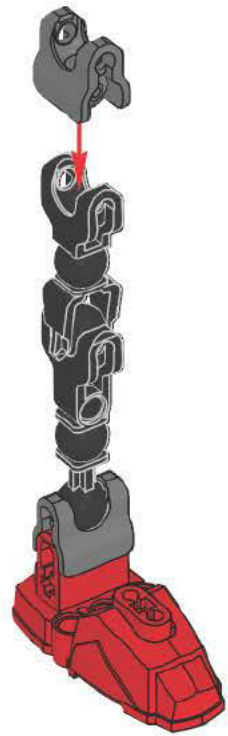

2x

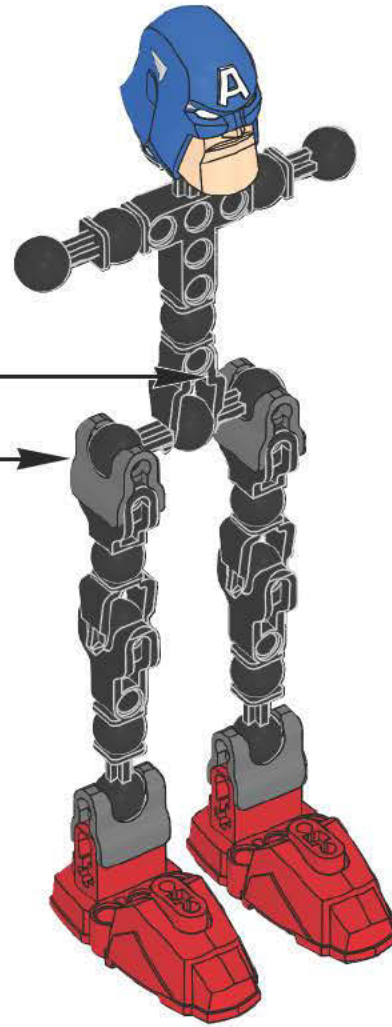

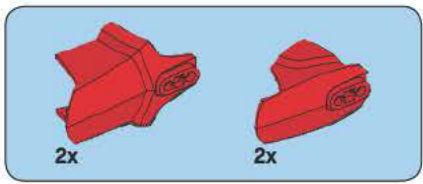

3

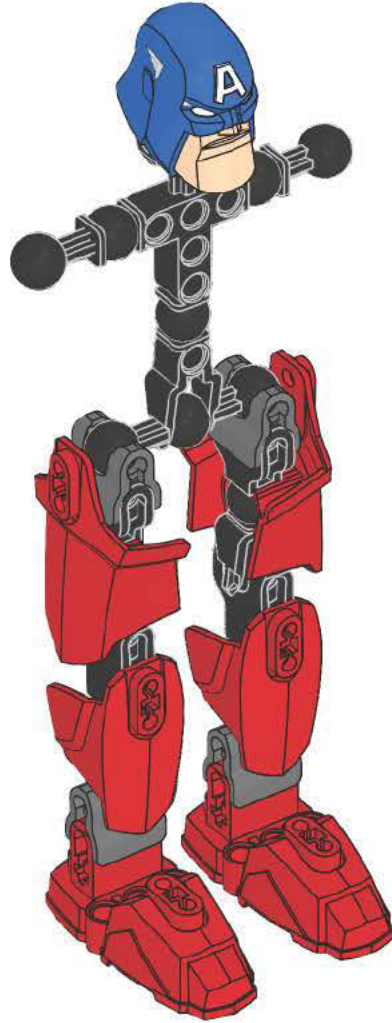

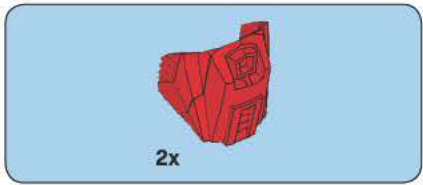

4

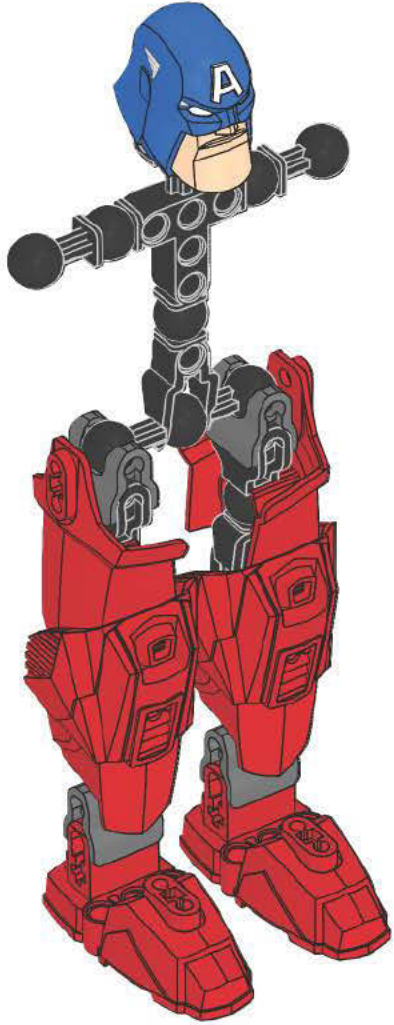

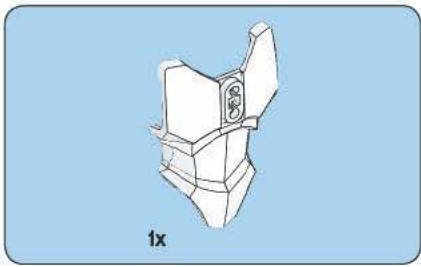

5

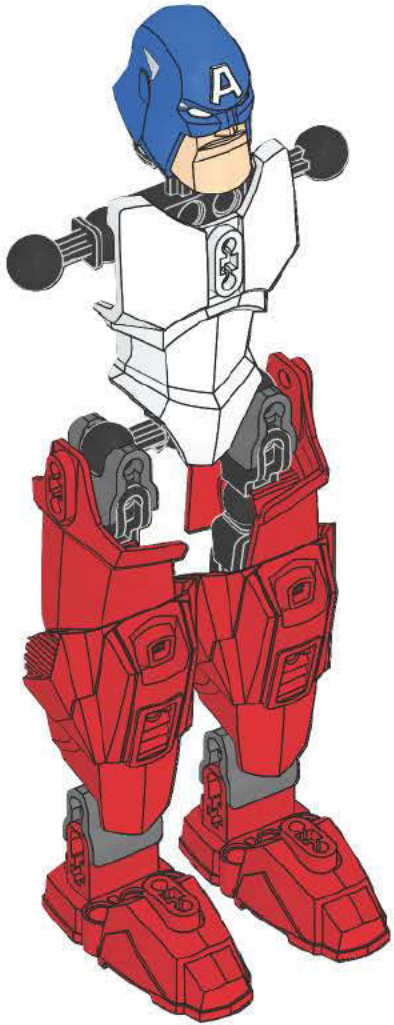



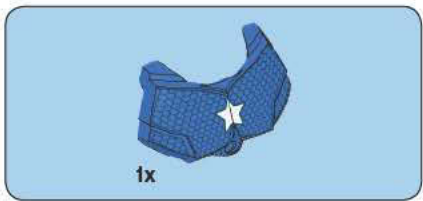

6

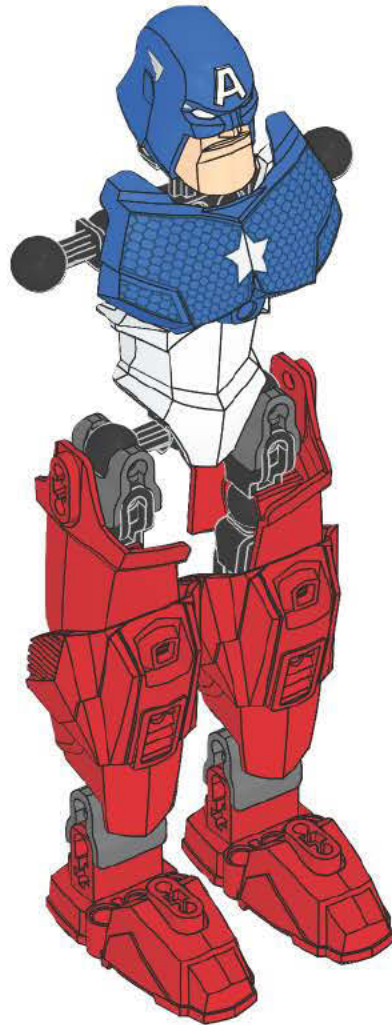

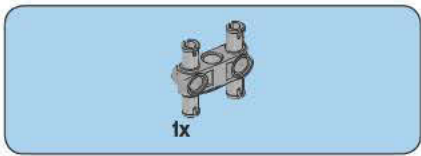

7

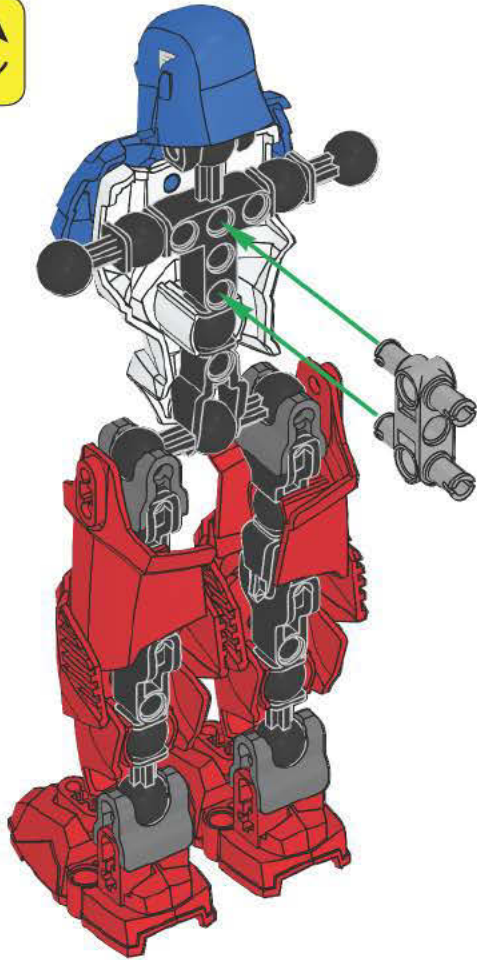

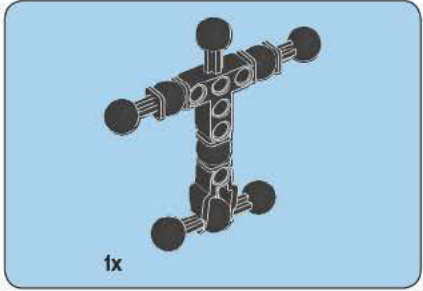
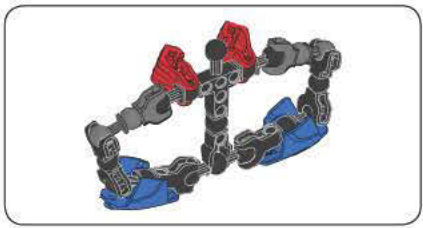

1

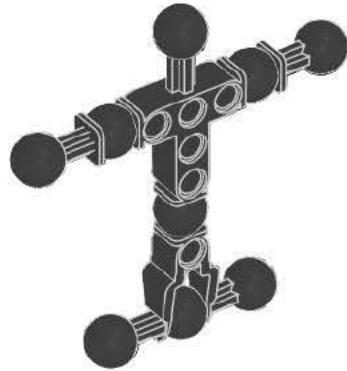

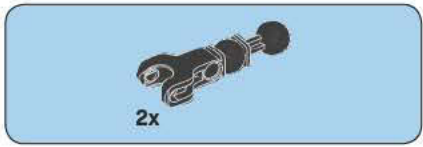

2

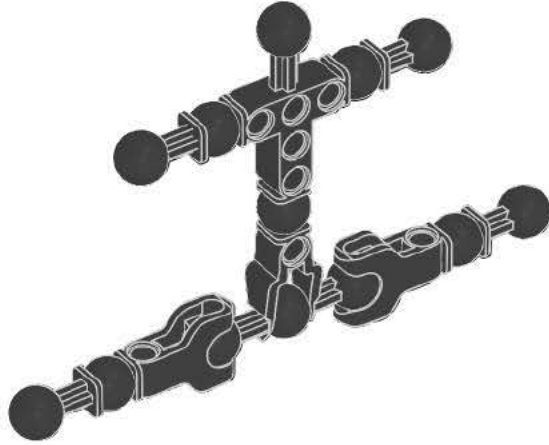

3

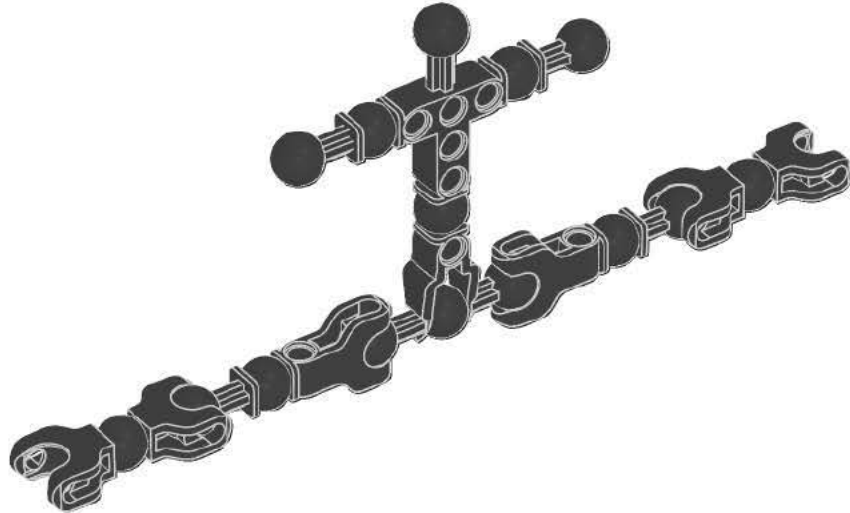



4

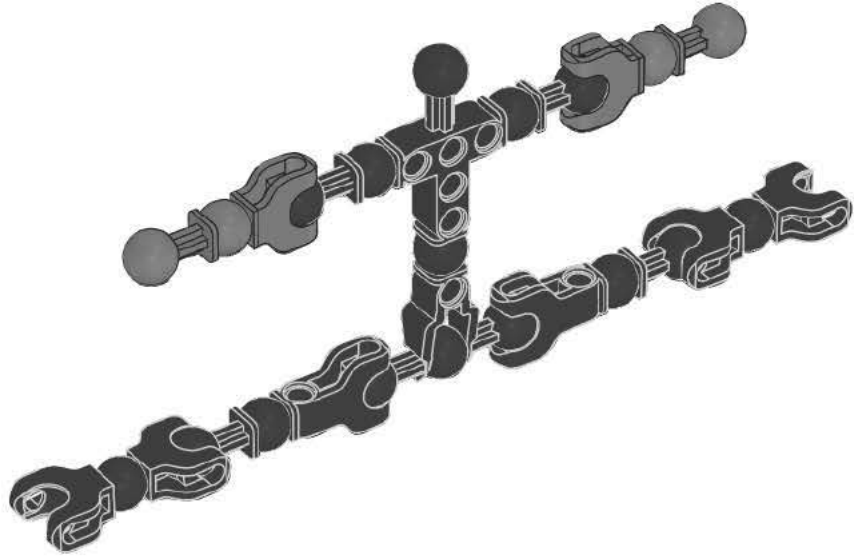

5

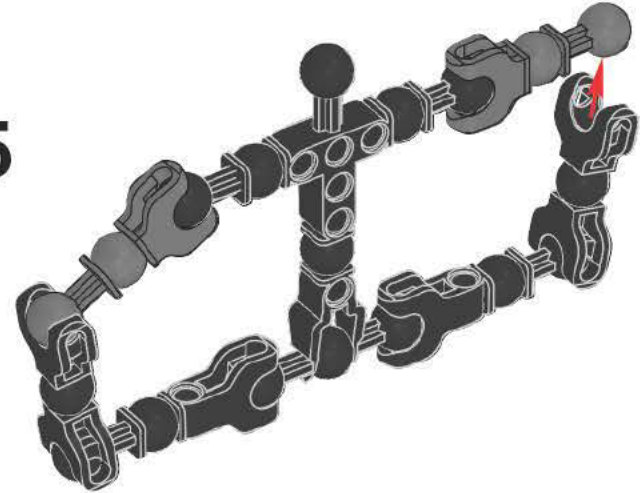

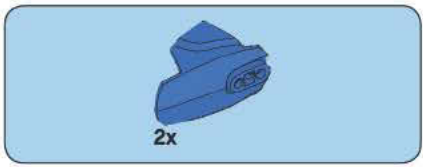

6

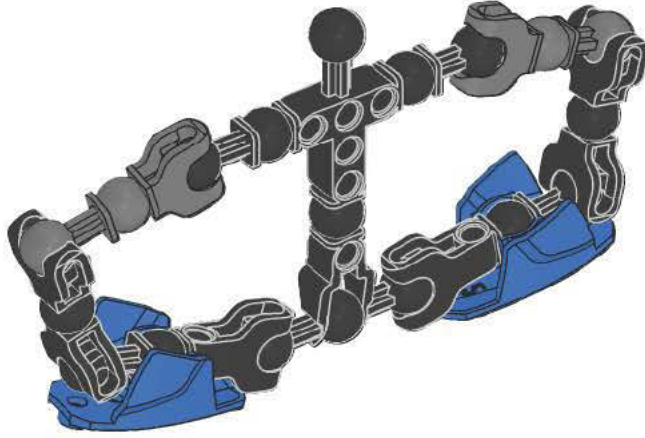

7

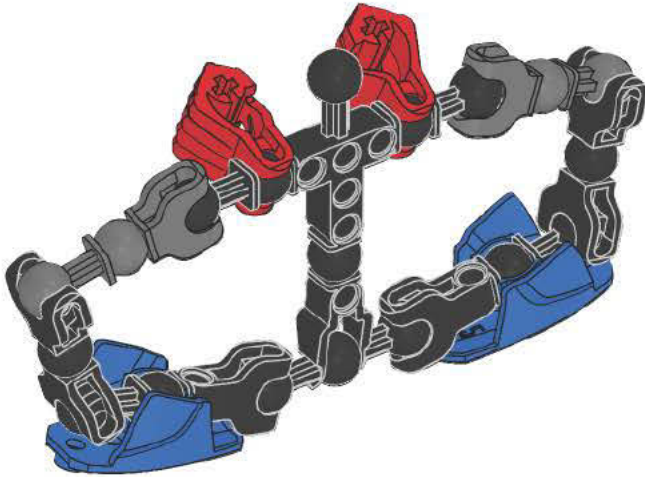

8

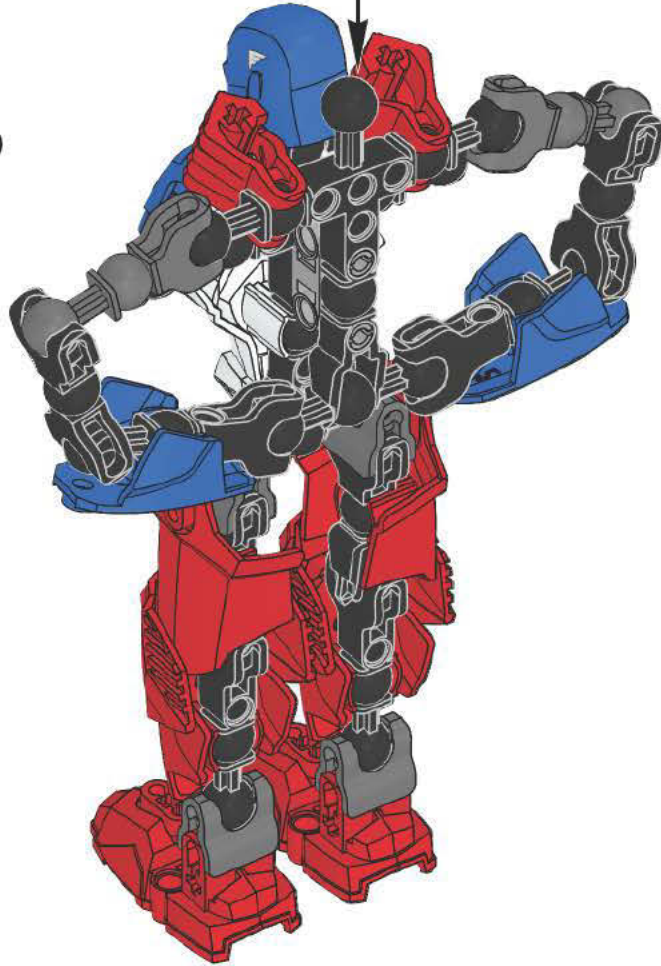

9

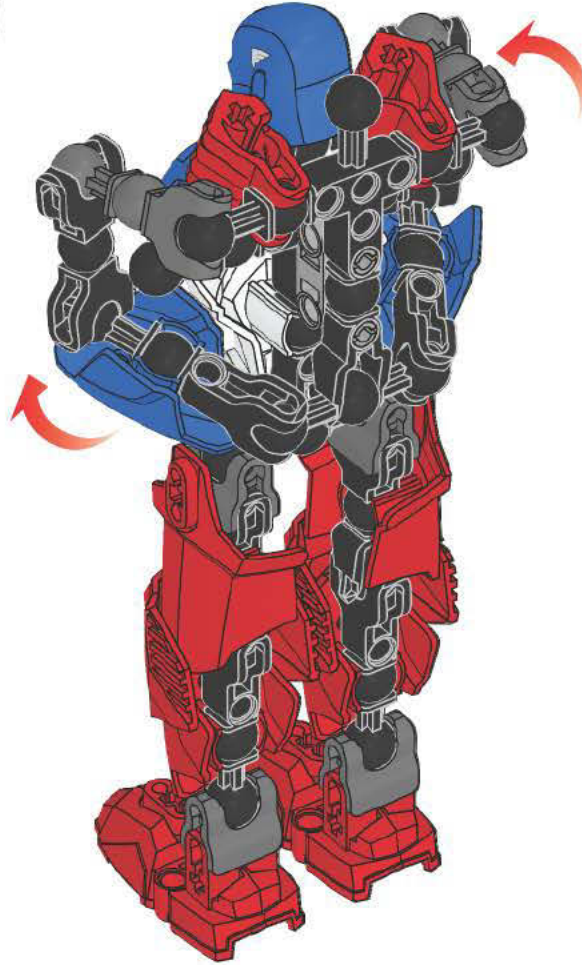



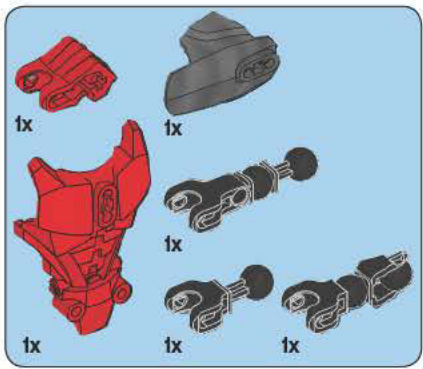

10

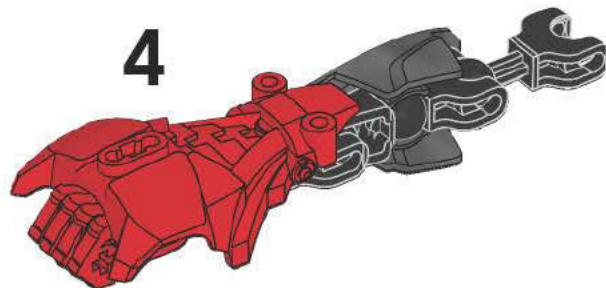
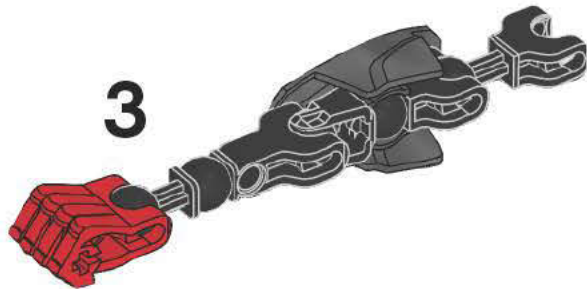
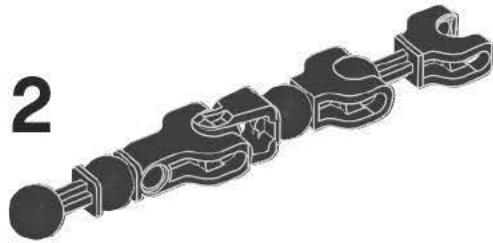
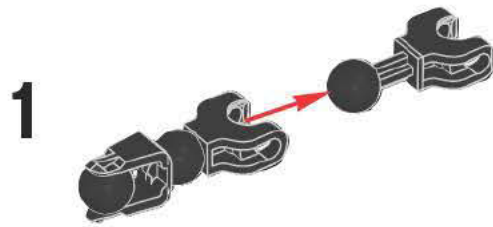

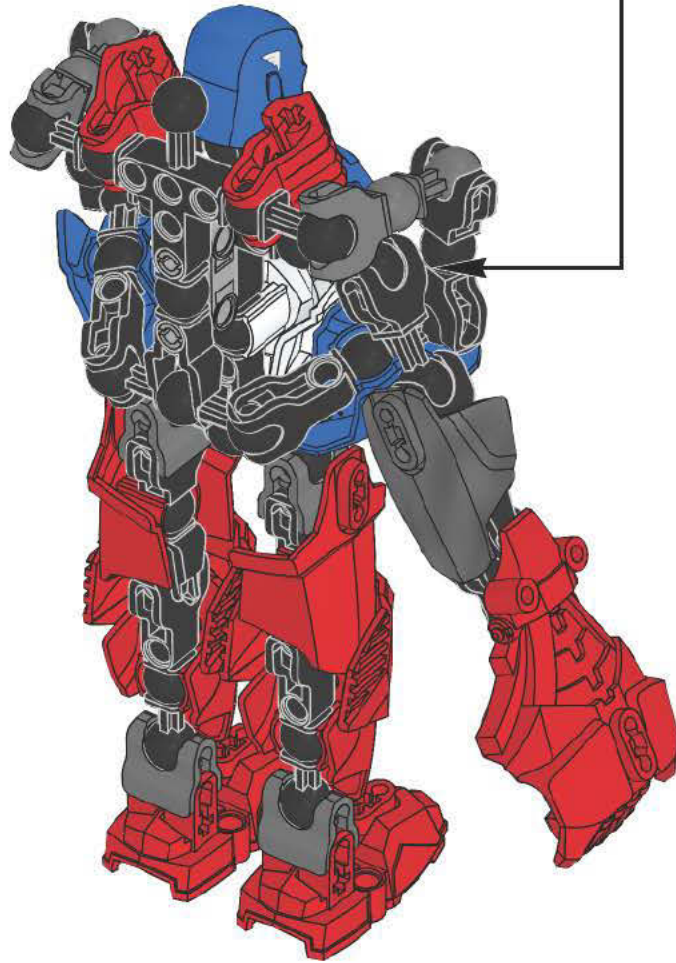

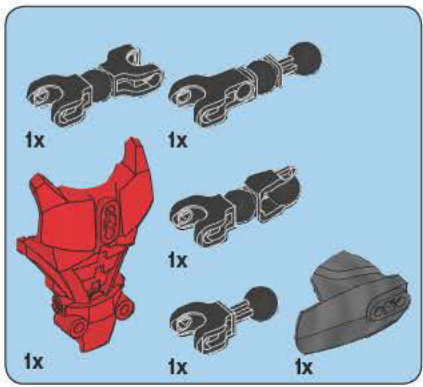

**11**

**1**

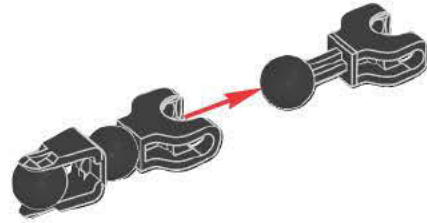

**2**

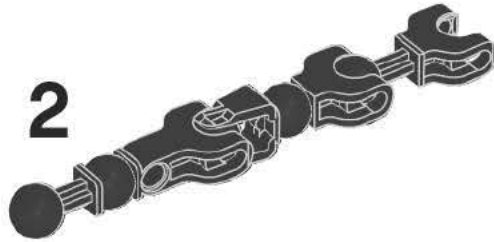

**3**

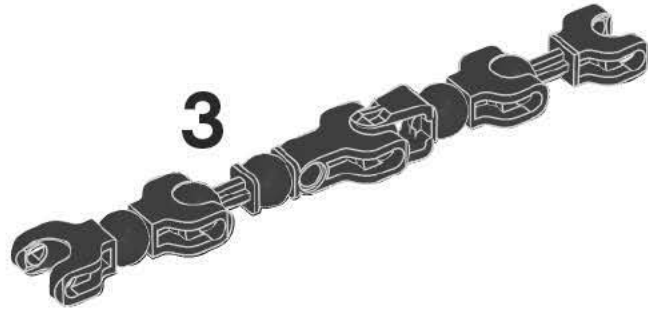

**4**

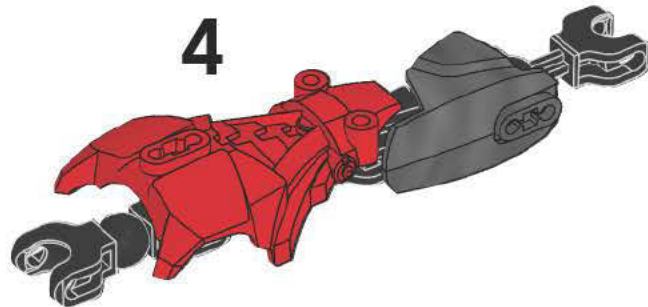

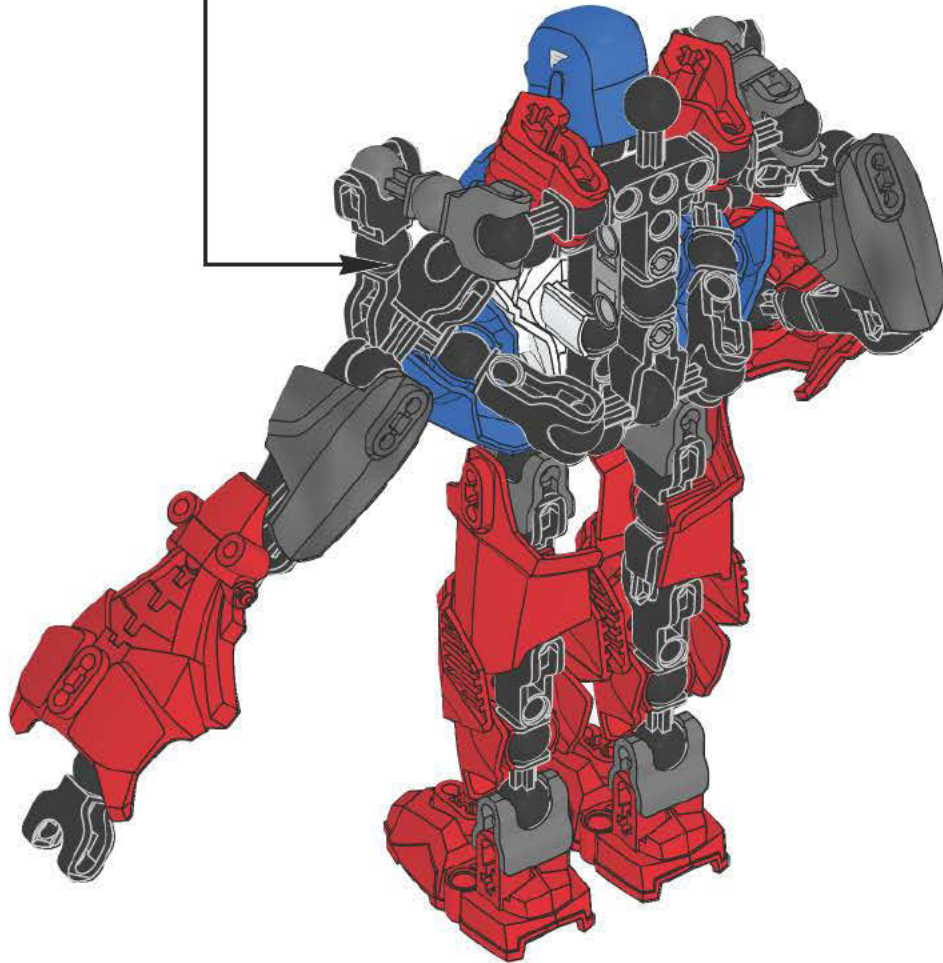

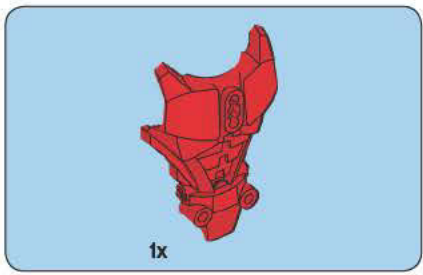

12

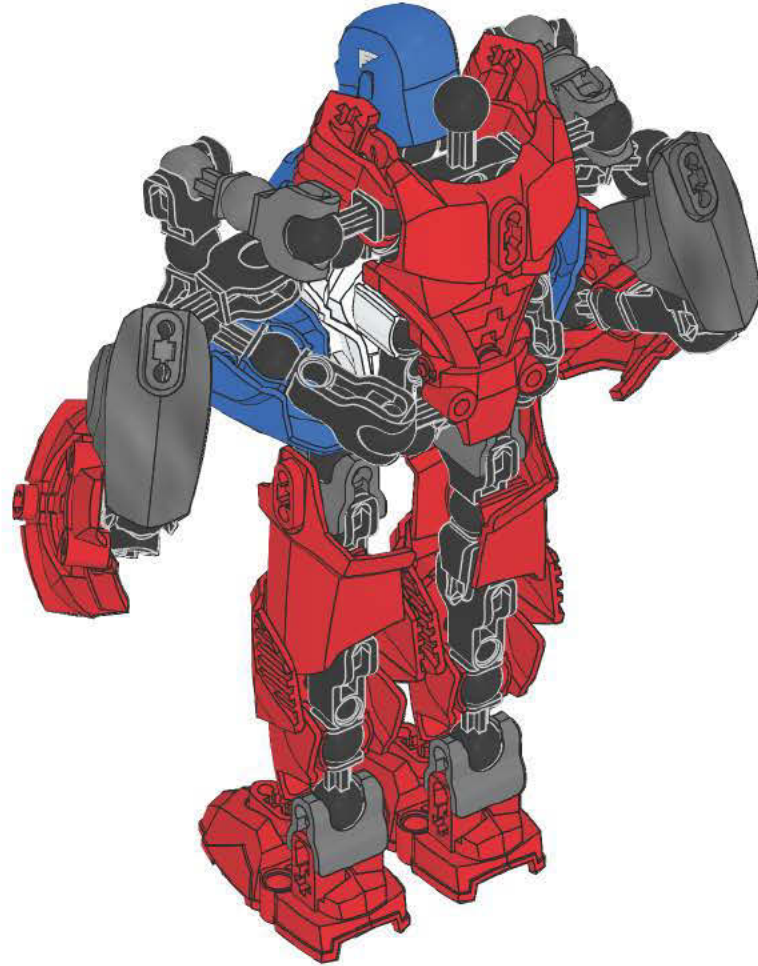

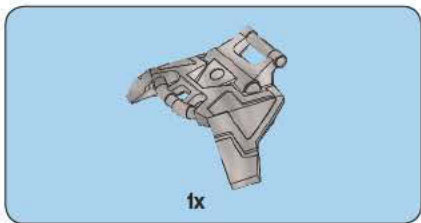

13

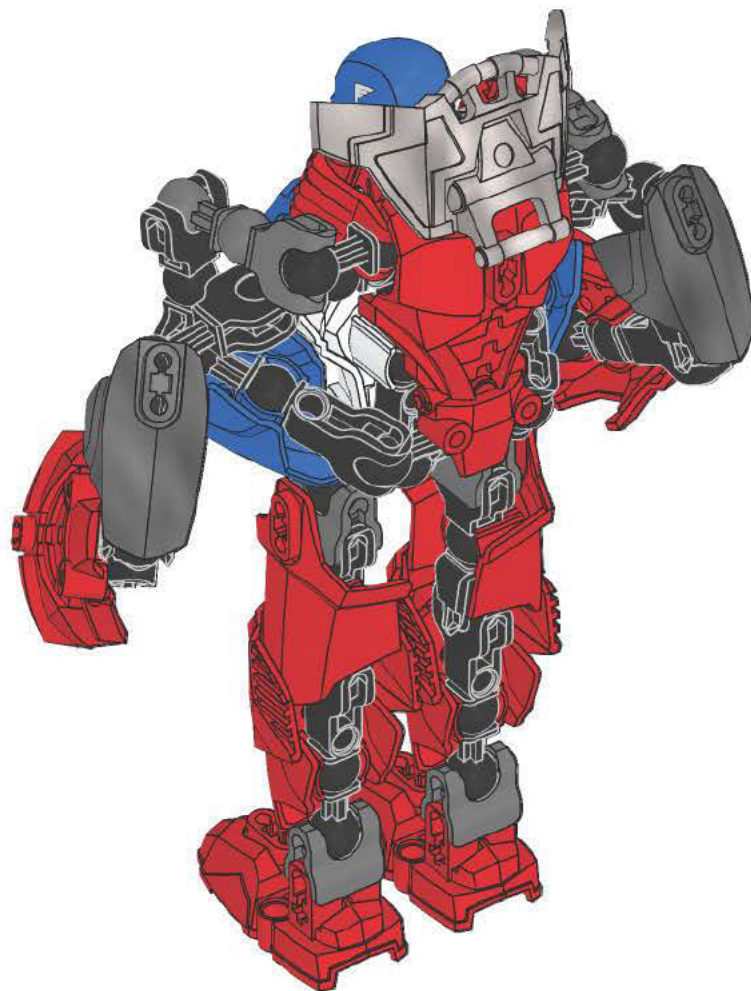

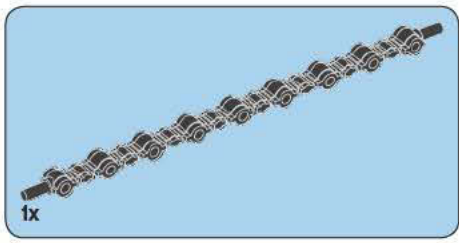

14

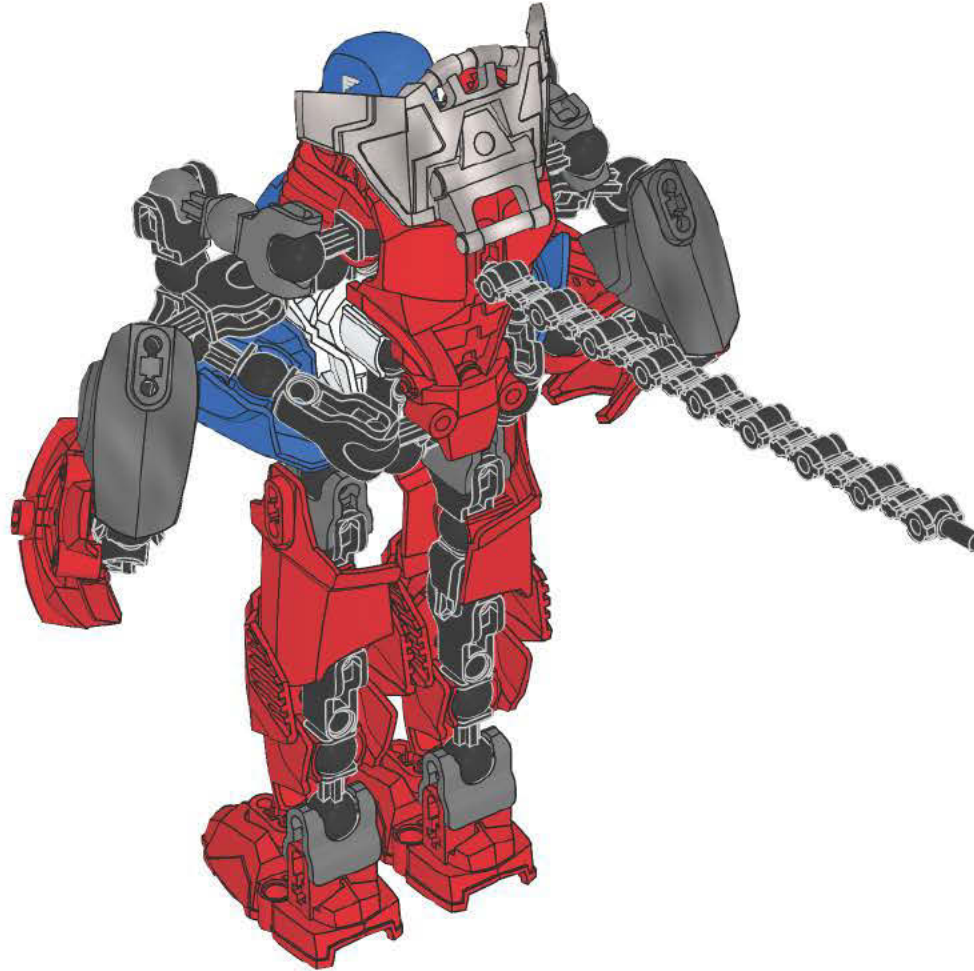

15

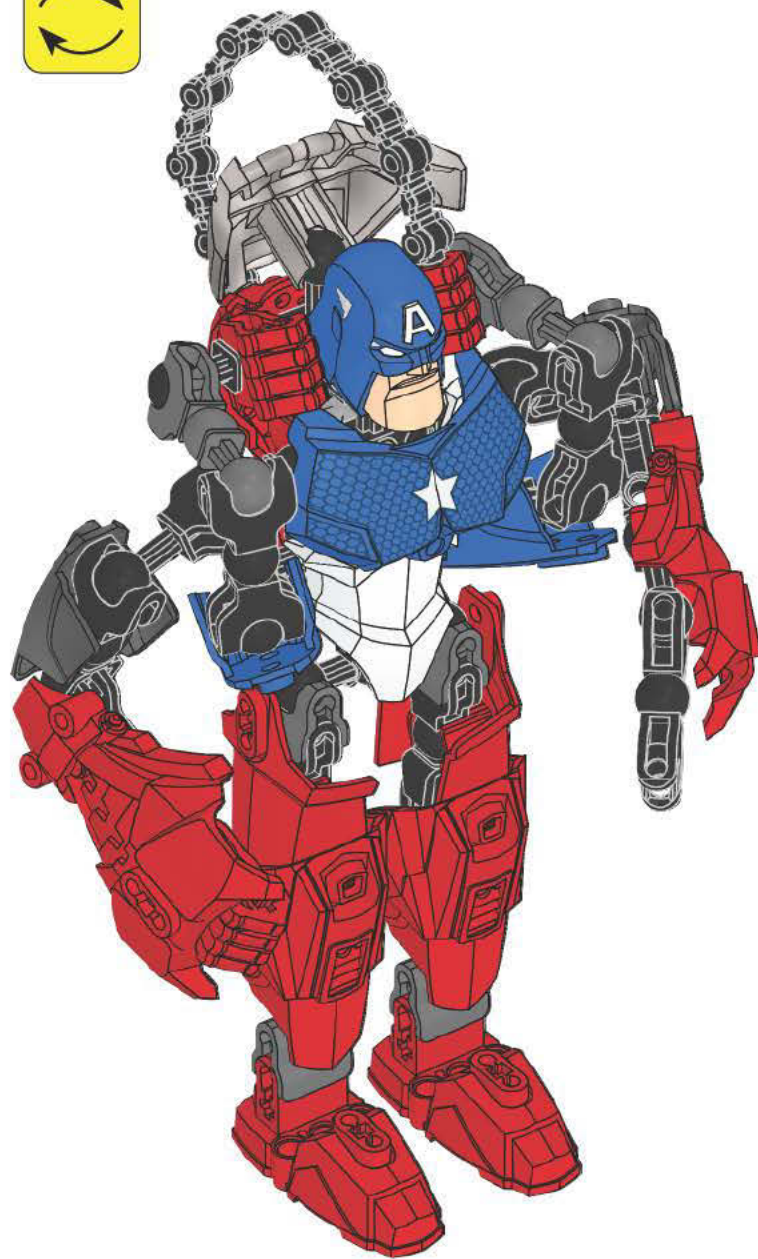



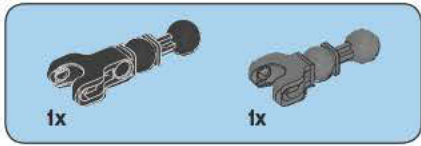

1

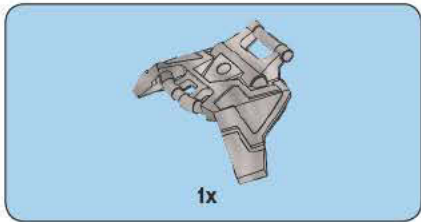
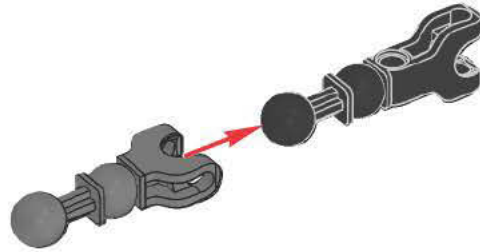

2

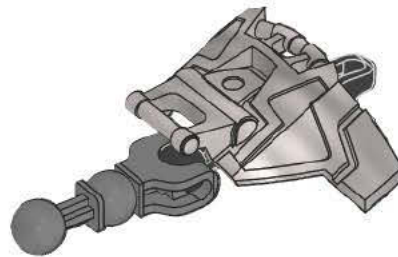

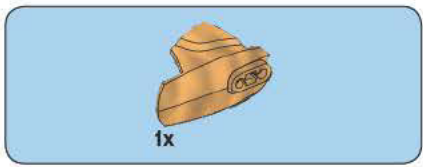

**3**

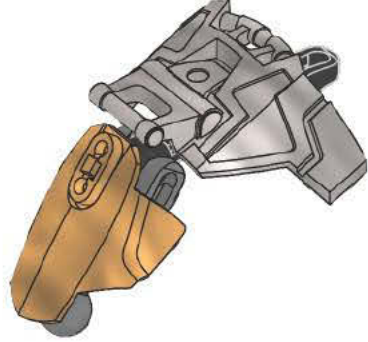

**4**

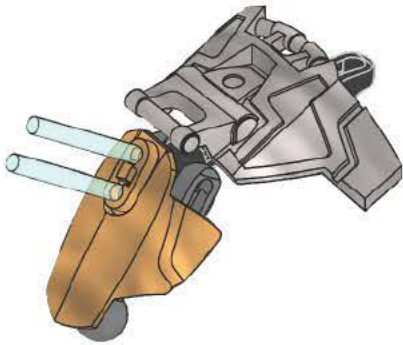

**2x**

16

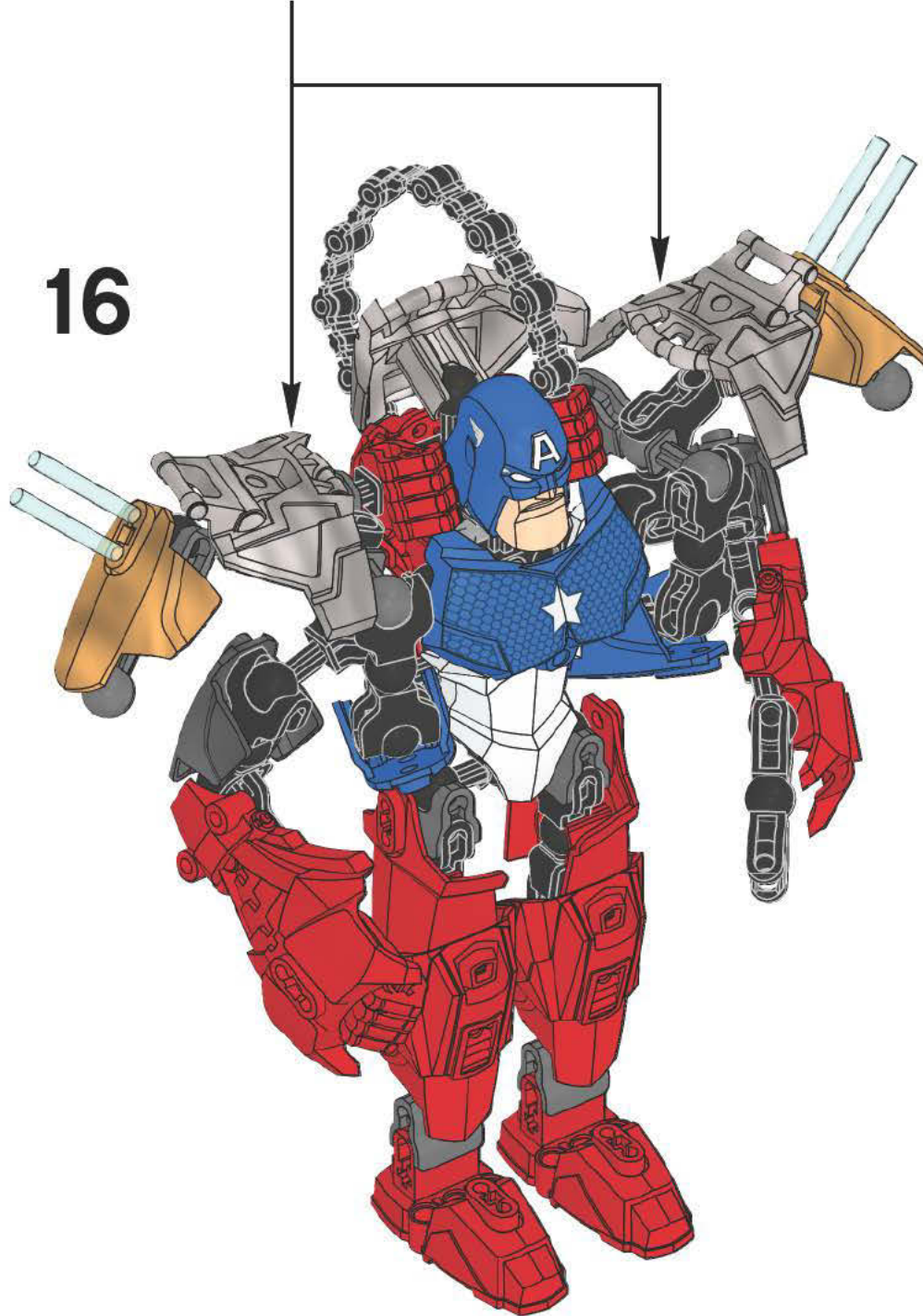

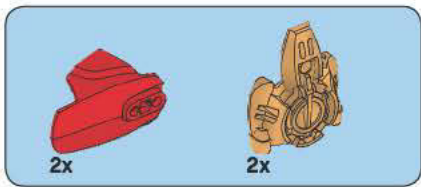

17

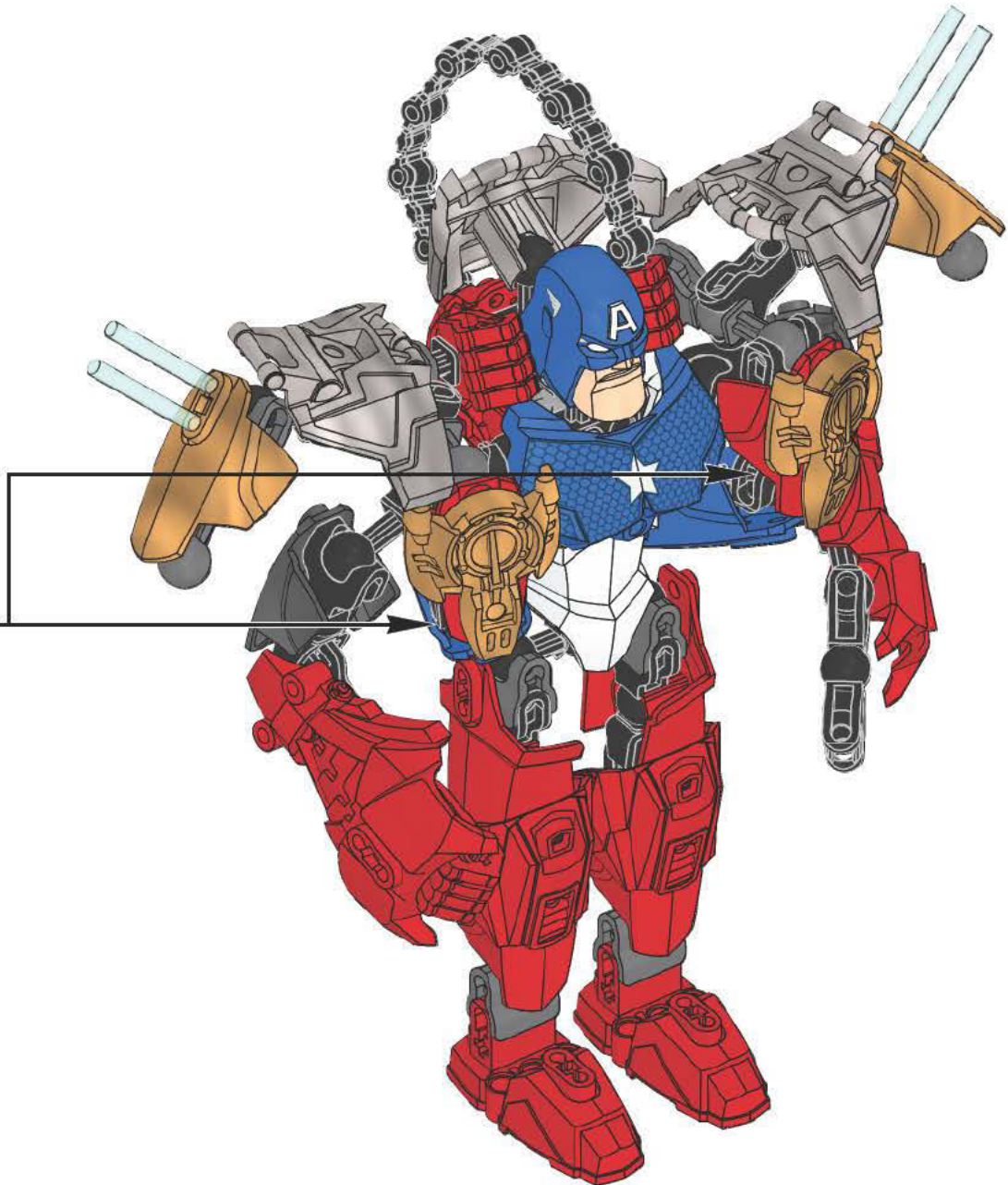
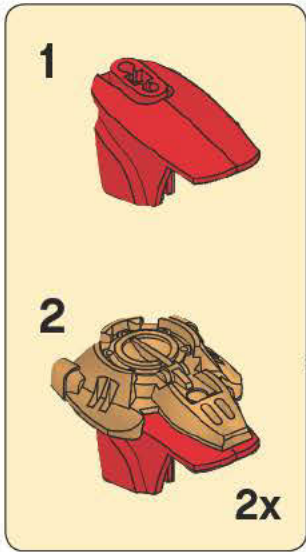

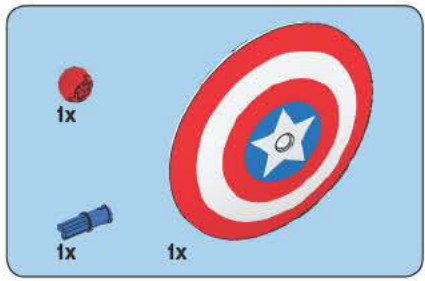

18

1



2

