



DC UNIVERSE™  
**SUPER  
HEROES**

4528



**GREEN  
LANTERN**



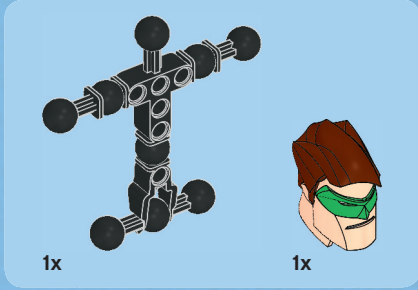

1

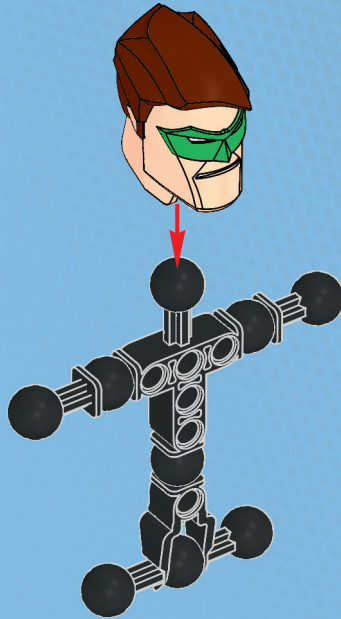

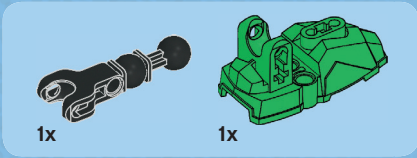
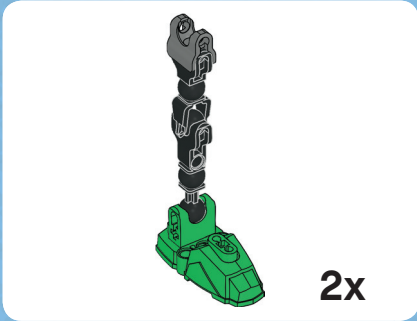

1

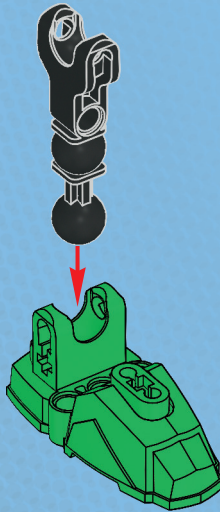

4

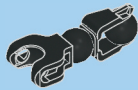

1x

2

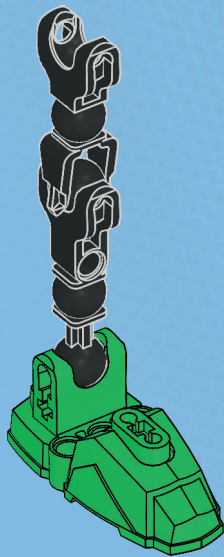



**3**

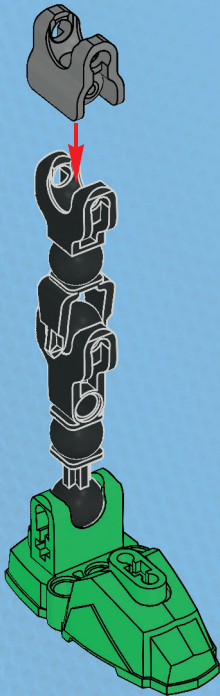

**2x**

**6**

4

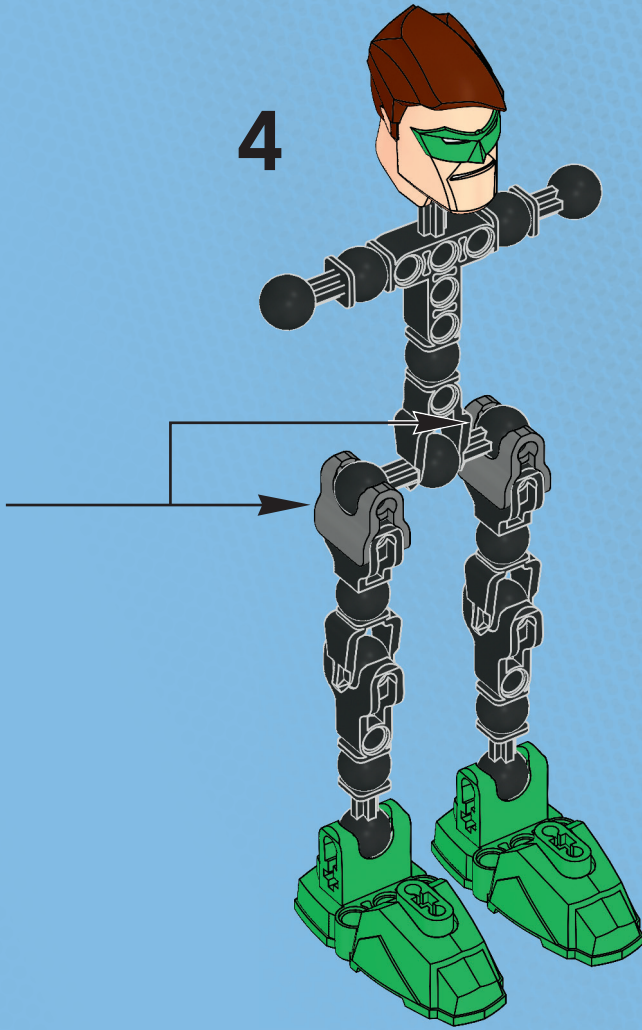

7

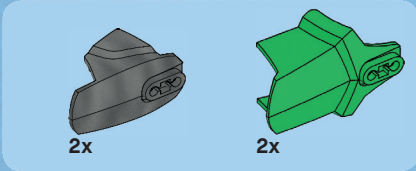

5

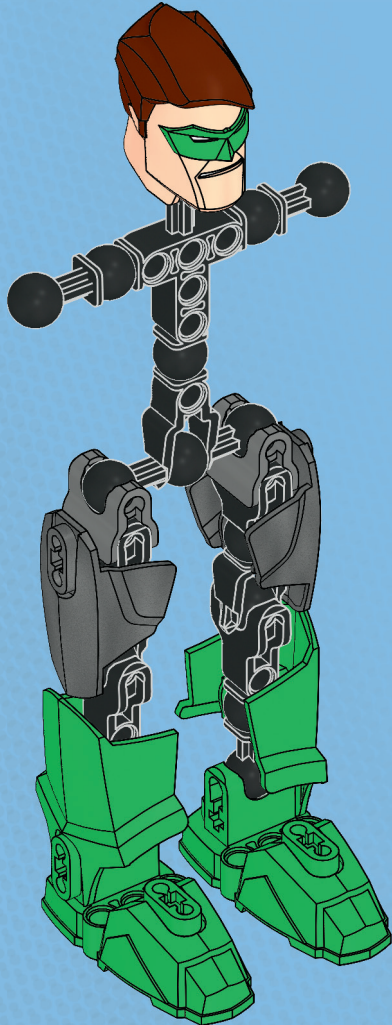

8





6

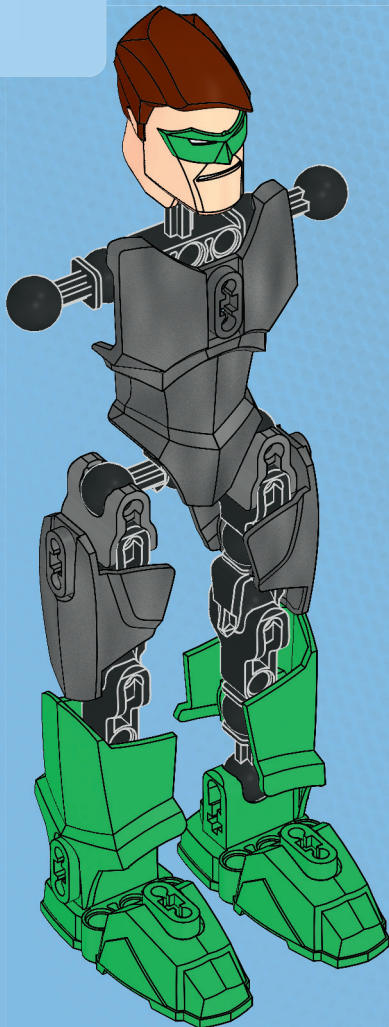

9



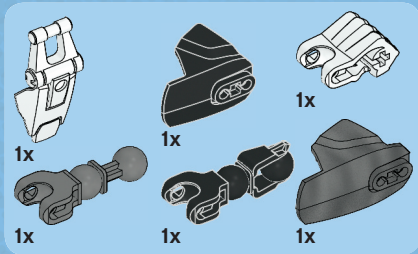

7

1

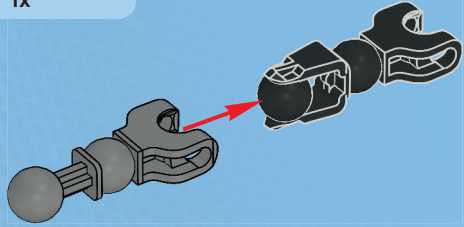

2

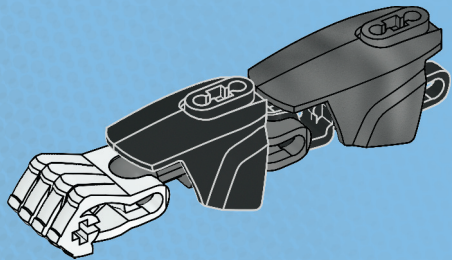

3

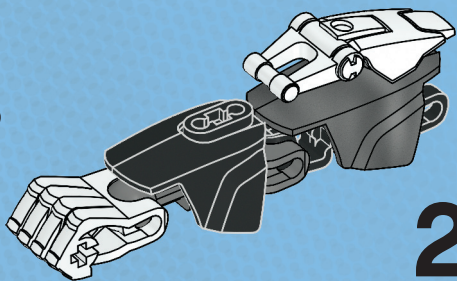

2x

10

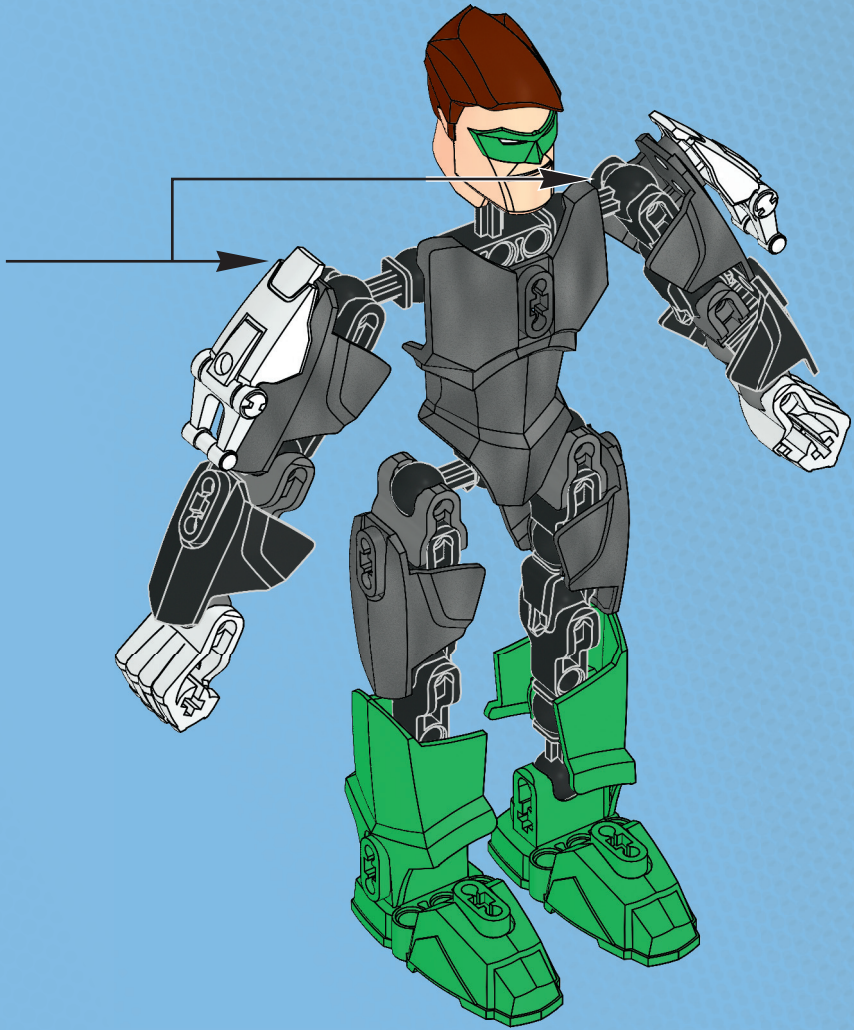

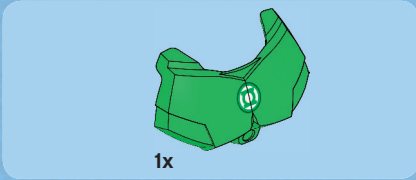

8

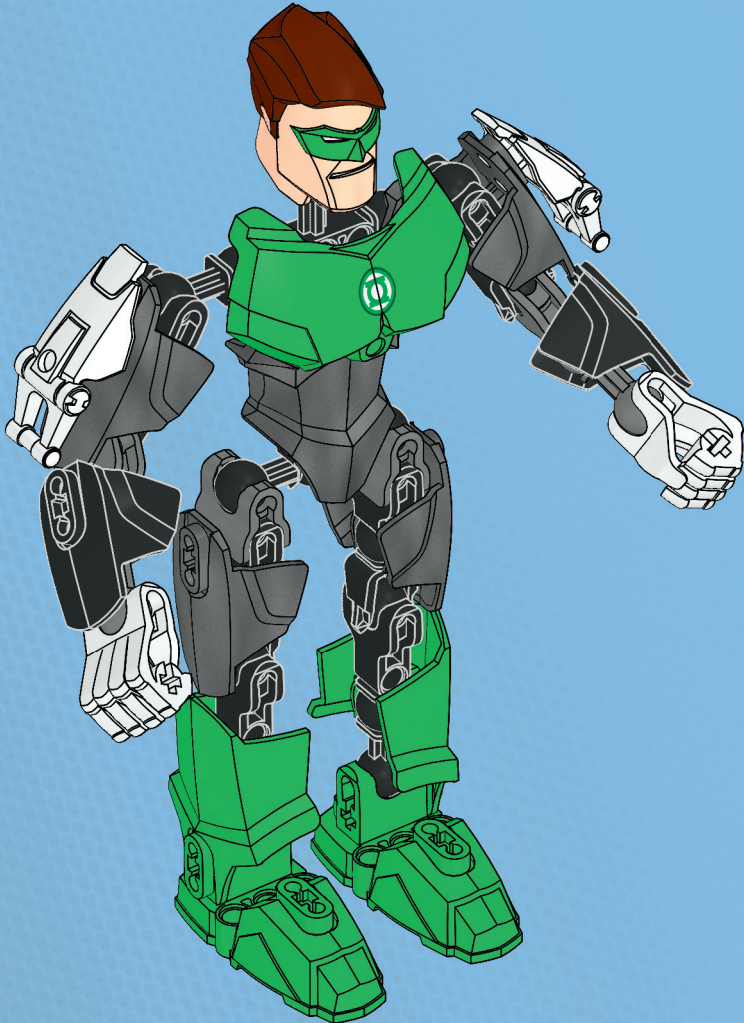

12

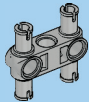

1x

9

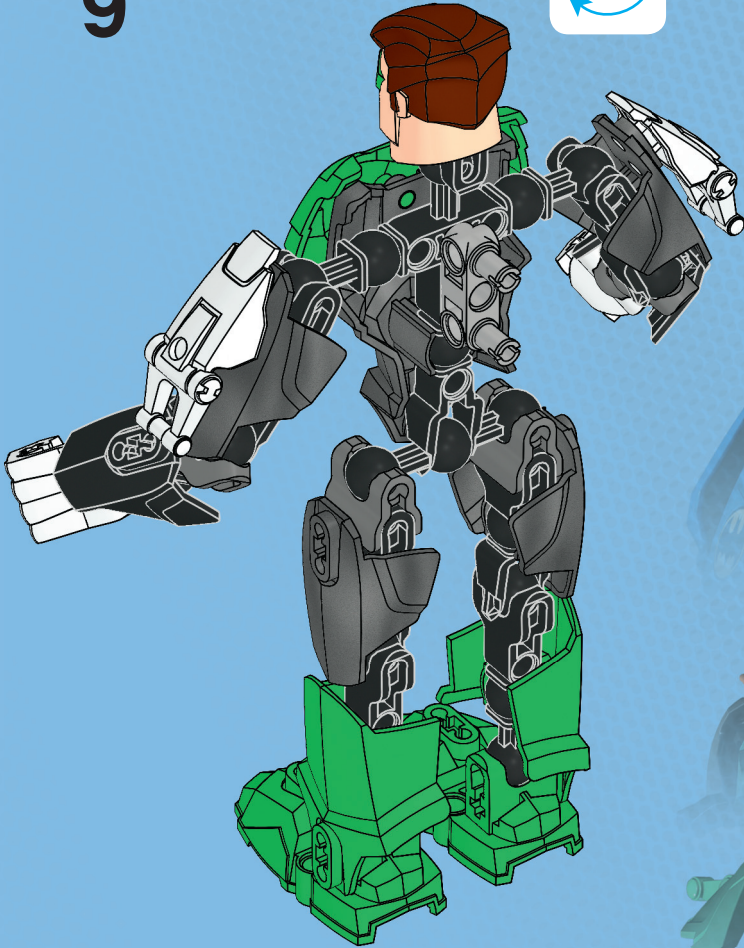

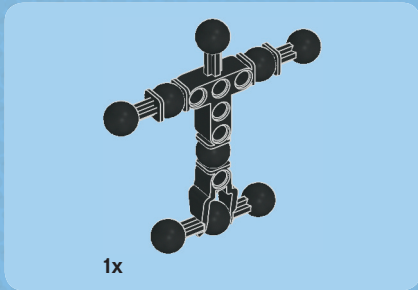

10

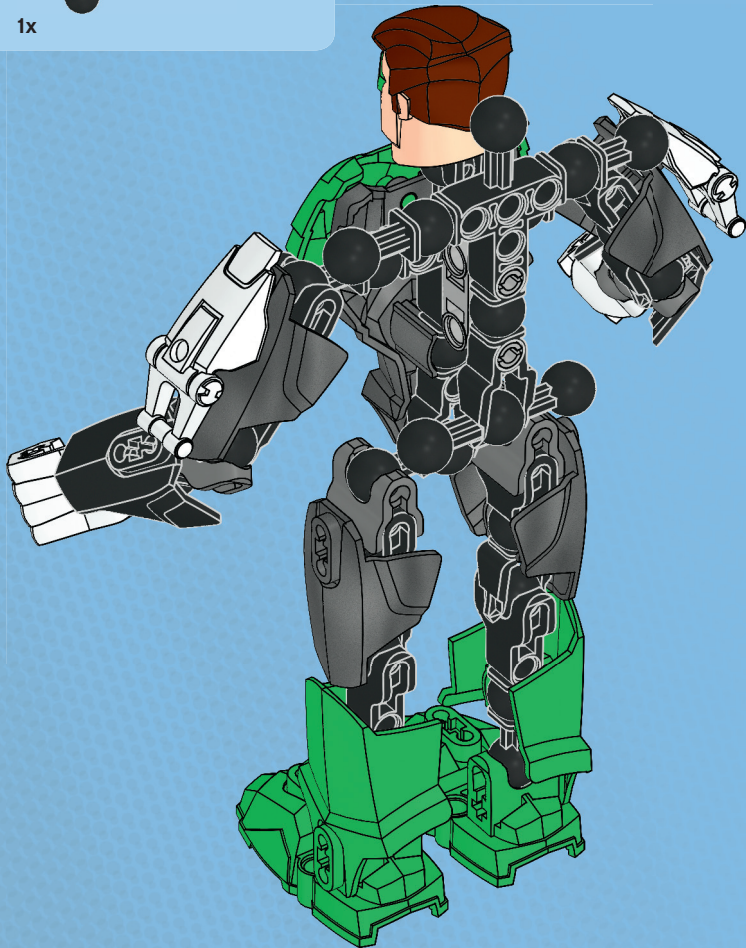

14

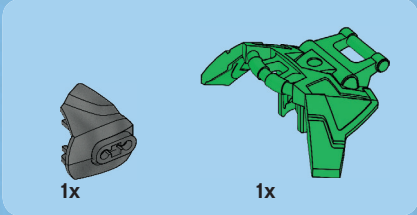

11

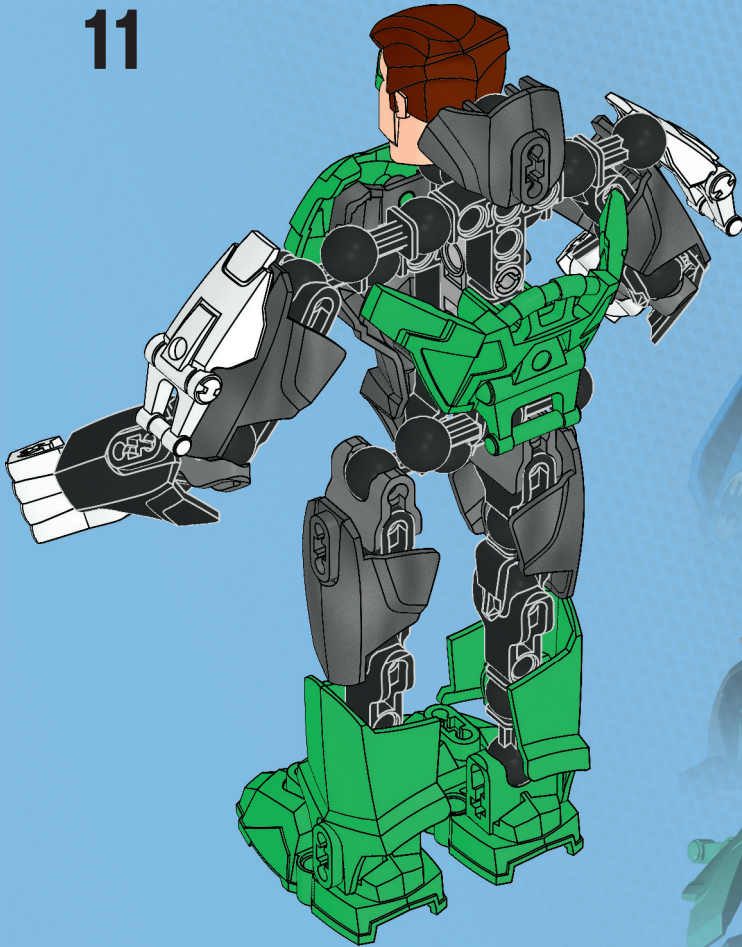

15

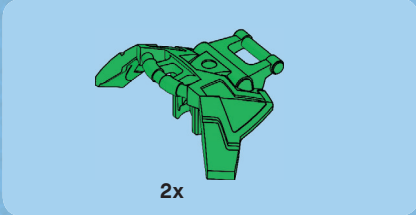

12

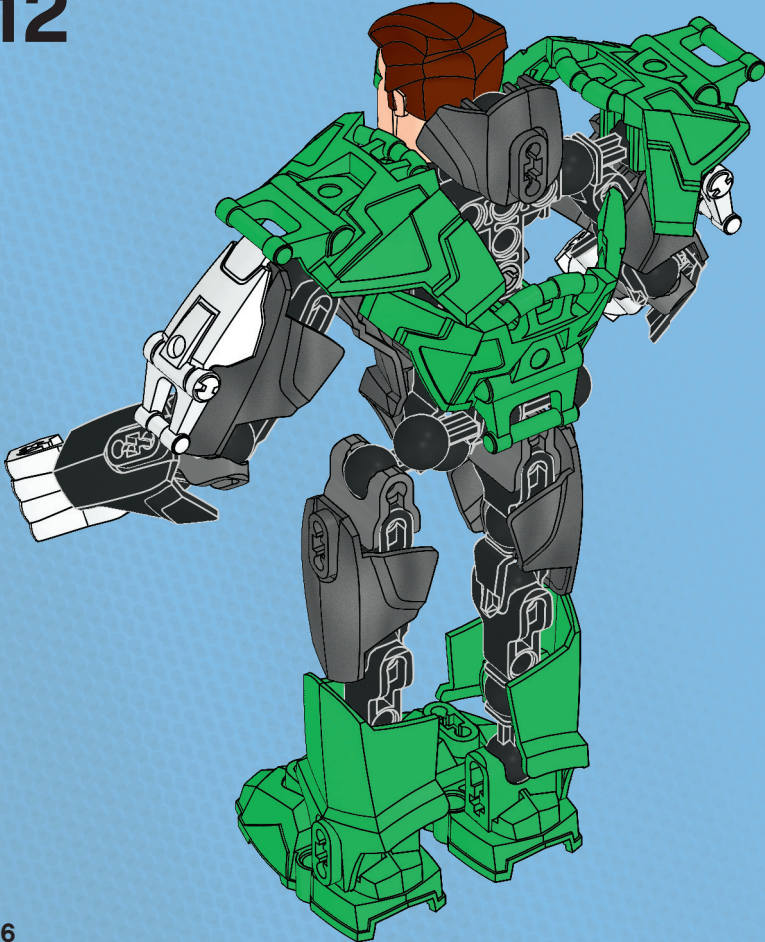

16



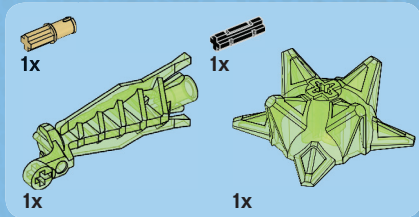

# 13

## 1

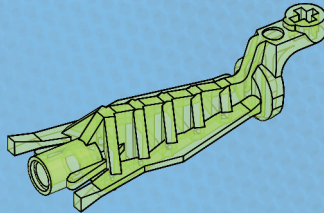

## 2

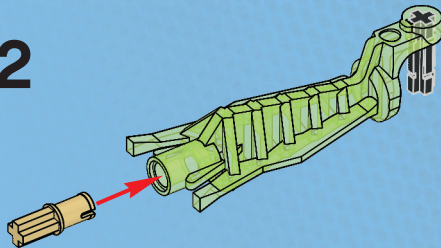

## 3

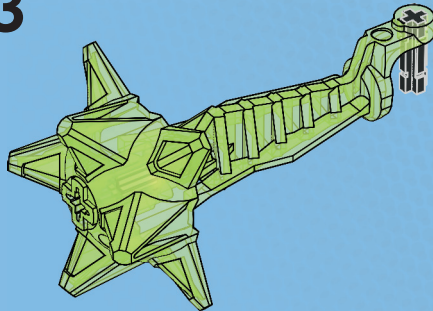

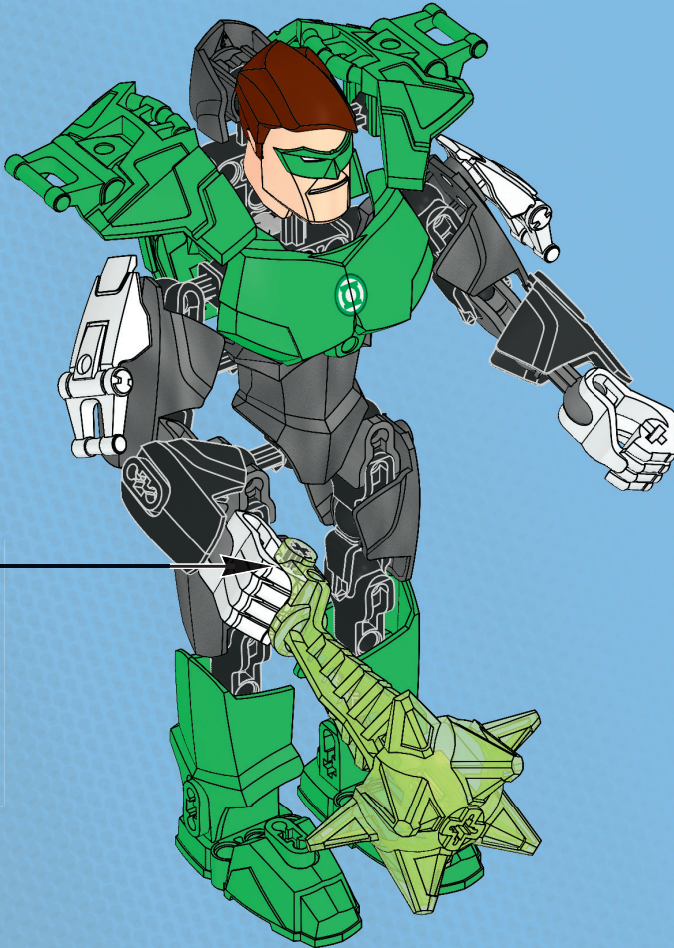



2x  
4610918



2x  
4648852

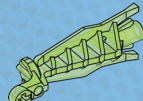

1x  
4651749



2x  
4632194

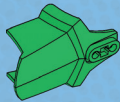

2x  
4648851

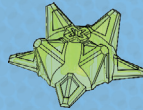

1x  
4653552



1x  
4666579



1x  
4654579



1x  
4632613

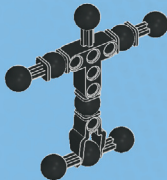

2x  
4593571



3x  
4648857



4x  
4632641



4x  
4589952



1x  
4225033

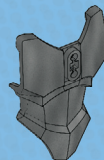

1x  
4632593



2x  
4593554



2x  
4666471



1x  
4655098



2x  
4632618

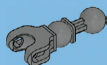

2x  
4618992



1x  
4109810



**Customer Service**

**Kundenservice**

**Service Consommateurs**

**Servicio Al Consumidor**

**www.lego.com/service or dial**



**: 00800 5346 5555**

**: 1-800-422-5346**



DC UNIVERSE™

**SUPER HEROES**



[DCUNIVERSESUPERHEROES.LEGO.COM](http://DCUNIVERSESUPERHEROES.LEGO.COM)





6203



# HERO FACTORY



6217

6200

6202

6227

6298





DC UNIVERSE™  
**SUPER  
HEROES**



6860



6858



6862



6863



6864





[www.LEGOclub.com](http://www.LEGOclub.com)



**club**<sup>TM</sup>

**FREE! GRATIS! GRATUIT!**



**LEGO® Club Magazine**



**LEGO® Club Email**

**SIGN UP ONLINE!**

[www.LEGOclub.com](http://www.LEGOclub.com)

**VISIT THE WORLD'S  
BIGGEST LEGO® SHOP!  
[www.LEGOshop.com](http://www.LEGOshop.com)**

**00800 5346 5555**

**1-866-534-6258 • 1-877-518-5346**

US & Canada only Canada seulement



\* Freephone. Mobile charges may apply. \* Numéro sans frais. Des frais peuvent s'appliquer avec les téléphones cellulaires. \* Gebührenfrei, Kosten für Anrufe aus Mobilfunknetzen können abweichen. \* Gratis telefoonnummer vanaf vaste lijn. \* Det er et gratis nummer, når du ringer fra fasttelefon. \* Det är gratis, när du ringer från en fast telefon. \* Numéro sans frais. Des frais peuvent s'appliquer avec les téléphones portables.

BI112





# WIN!

Go to [www.LEGOsurvey.com/product](http://www.LEGOsurvey.com/product)  
to fill out a survey for a chance  
to win a cool LEGO® Product.  
No purchase necessary.  
Open to all residents where not prohibited.

 [www.LEGO.com](http://www.LEGO.com)



## [www.LEGOsurvey.com/product](http://www.LEGOsurvey.com/product)

### GEWINNE!

Nimm an der Umfrage auf [www.LEGOsurvey.com/product](http://www.LEGOsurvey.com/product) teil und hab die Chance ein cooles LEGO® Produkt zu gewinnen!  
Die Teilnahme am Gewinnspiel führt zu keinerlei Kaufverpflichtungen. Teilnahme in allen nicht ausgeschlossenen Ländern möglich.

LEGO and the LEGO logo are trademarks of the/sont des marques de commerce de/son marcas registradas de LEGO Group. ©2012 The LEGO Group.

### WIN!

Ga naar [www.LEGOsurvey.com/product](http://www.LEGOsurvey.com/product), vul een enquêteformulier in en maak kans op een cool LEGO® product.  
Geen aankoopverplichting.  
Iedereen mag deelnemen, uitgezonderd ingezetenden van landen waar een enquêteverbod geldt.

### GAGNE!

Visite [www.LEGOsurvey.com/product](http://www.LEGOsurvey.com/product) pour répondre à un questionnaire et avoir une chance de gagner un produit LEGO® très cool!  
Aucune obligation d'achat.  
Ouvert à tous les résidents des pays autorisés.

### 当てよう!

[www.LEGOsurvey.com/product](http://www.LEGOsurvey.com/product) にアクセスして、アンケートにご記入ください。  
当選者にはレゴ®製品を差し上げます。  
お買い上げの必要はありません。  
禁止されていない限り、すべての皆様にご利用いただけます。

 TM & © DC Comics.



WB SHIELD: TM & © Warner Bros. Entertainment Inc. (s12)

6002125 / 6002126