



4480

Jabba's Palace

STAR WARS



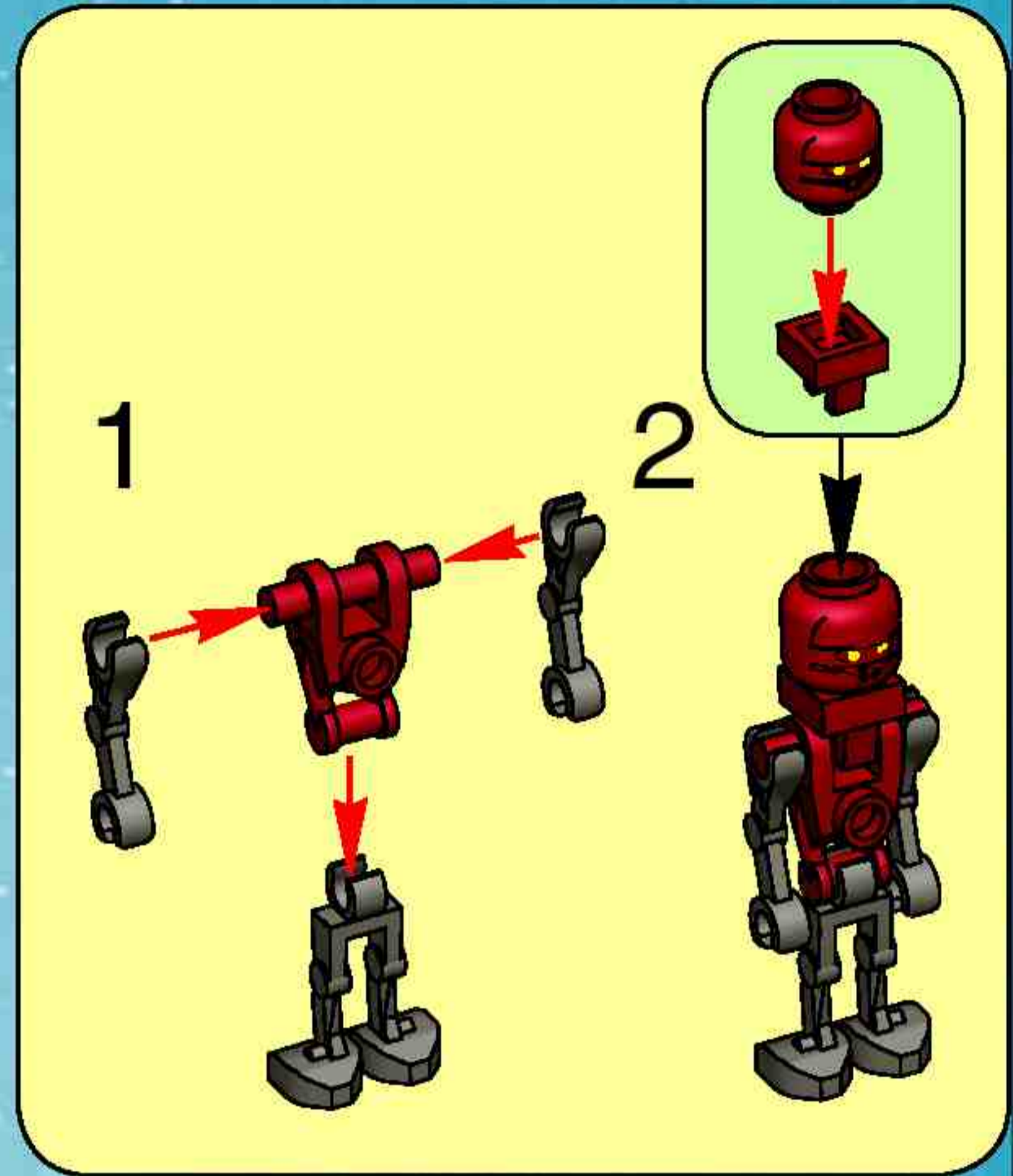
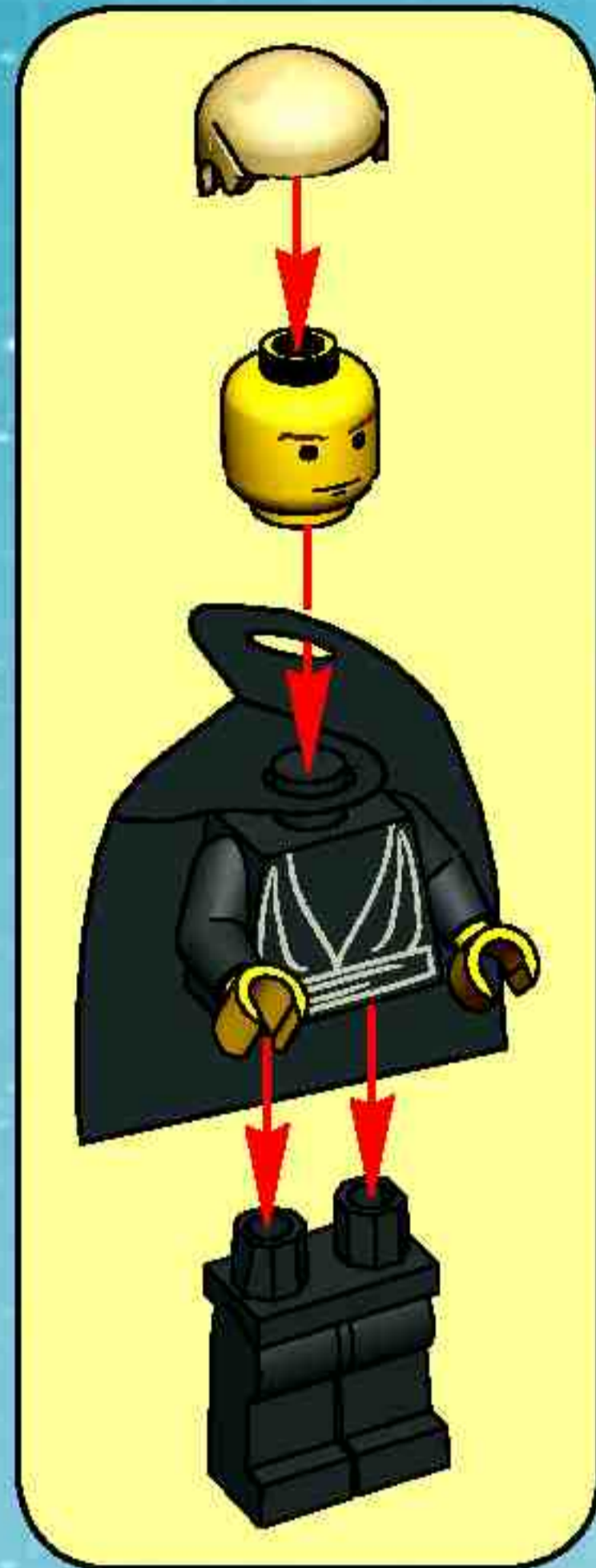
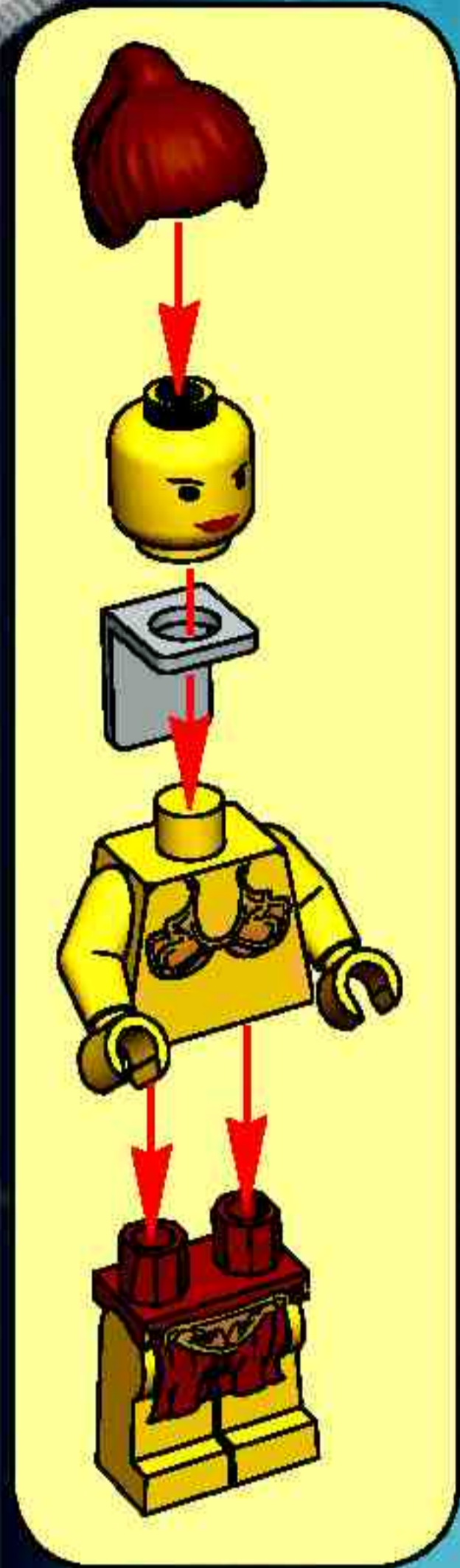

1

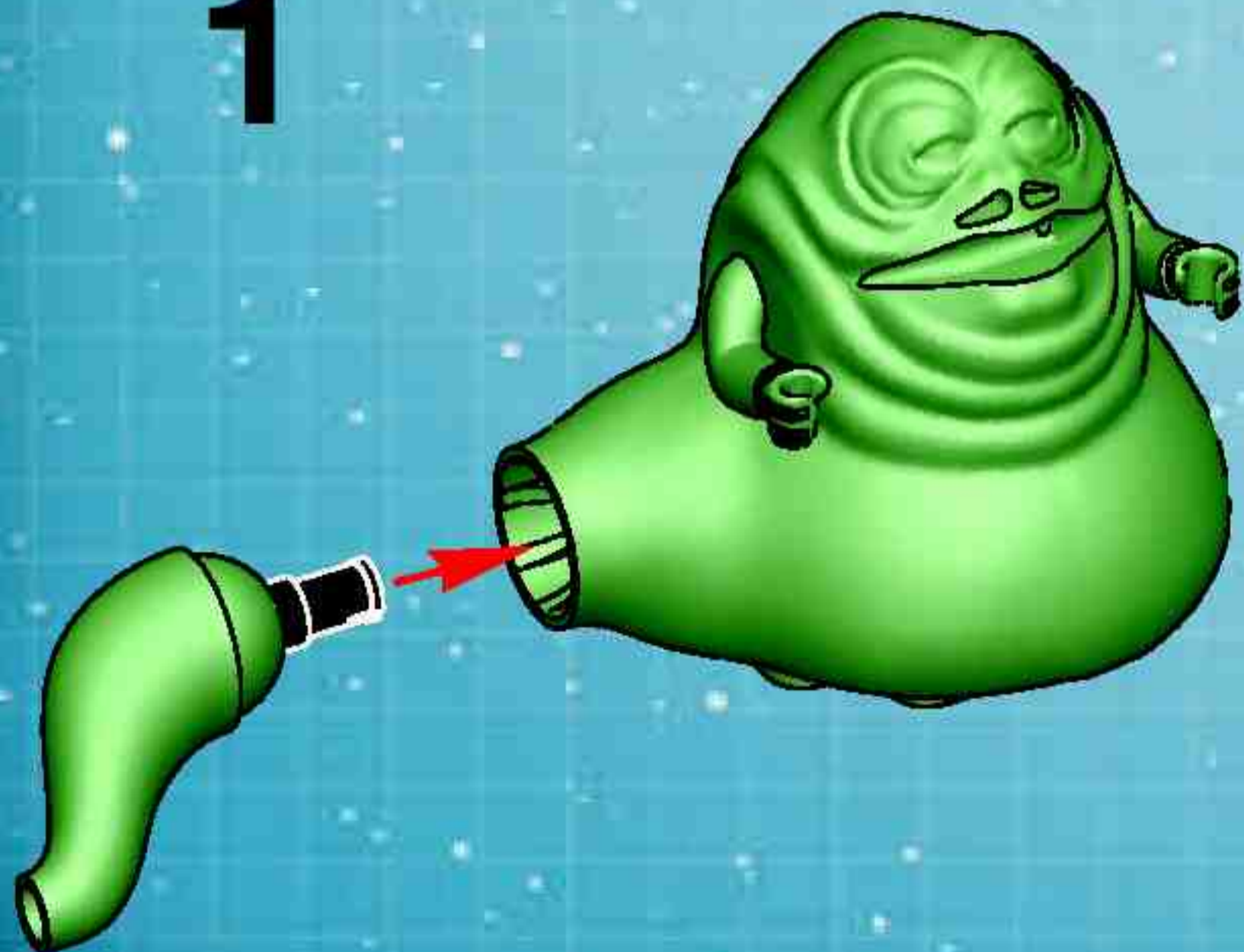

2





1



2



3

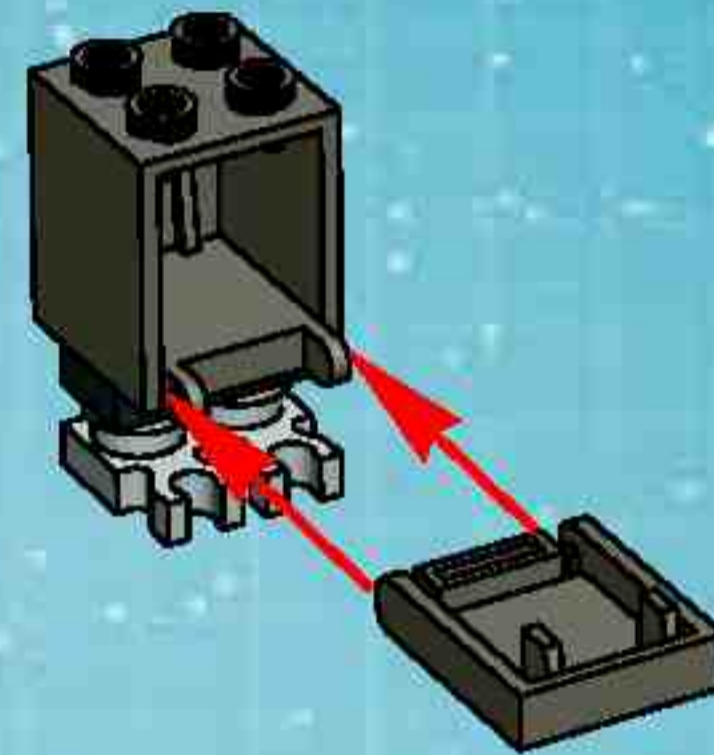

4



1



2



3



4



5



6



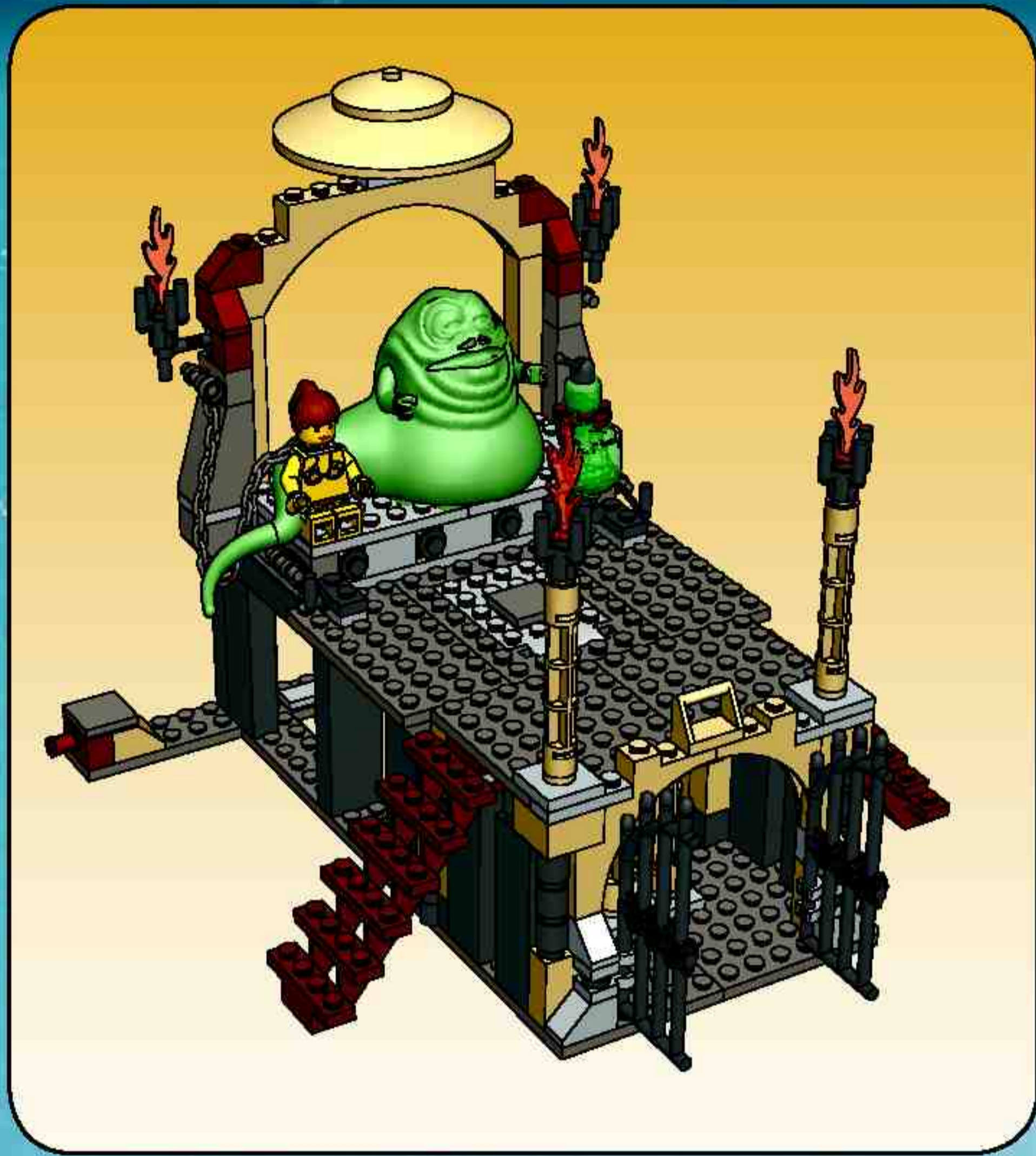

1

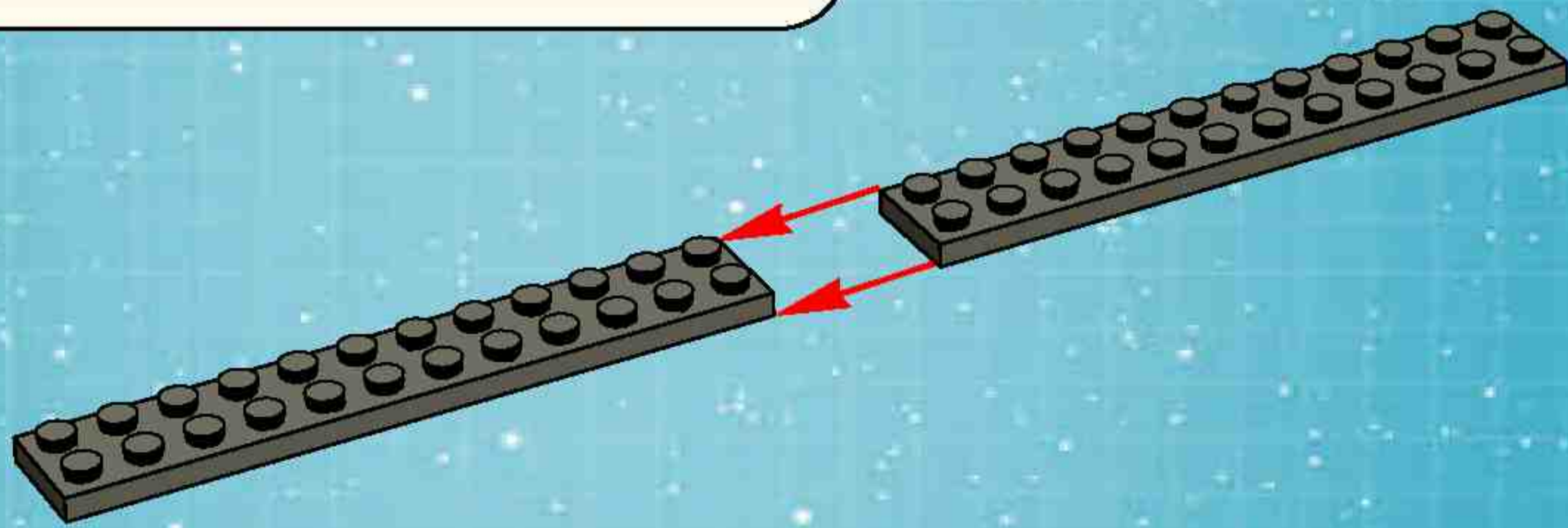

2

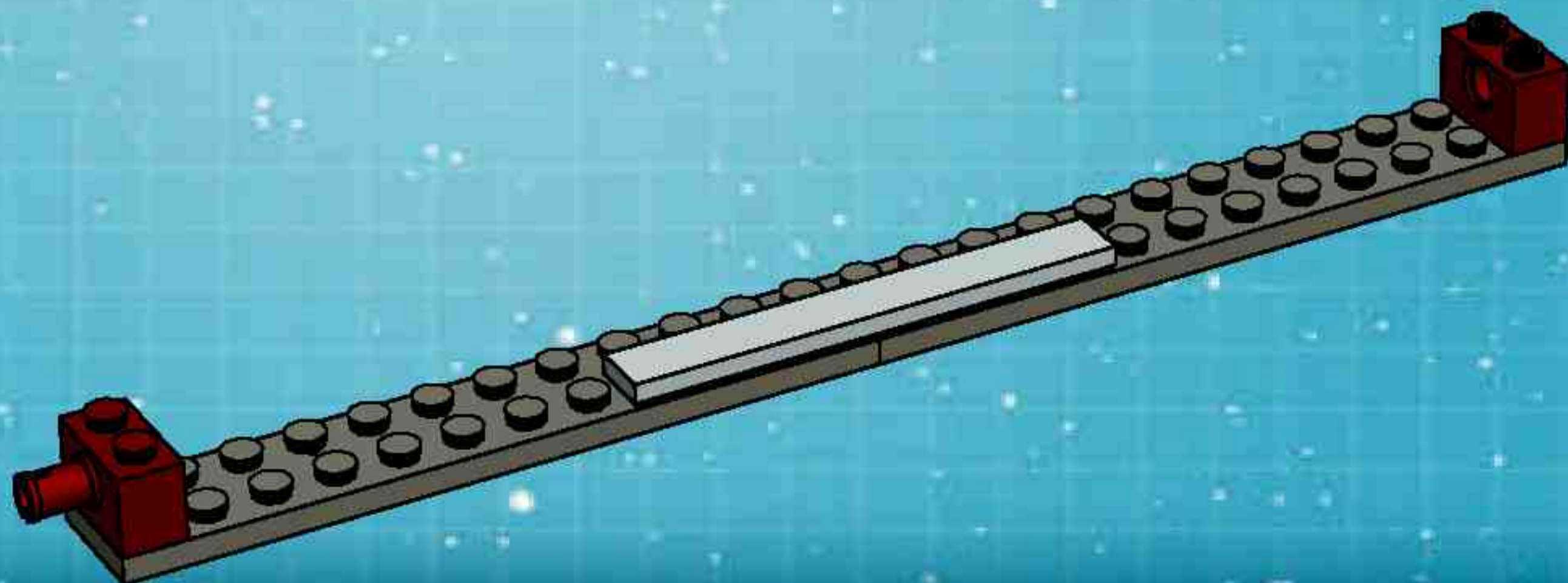

B

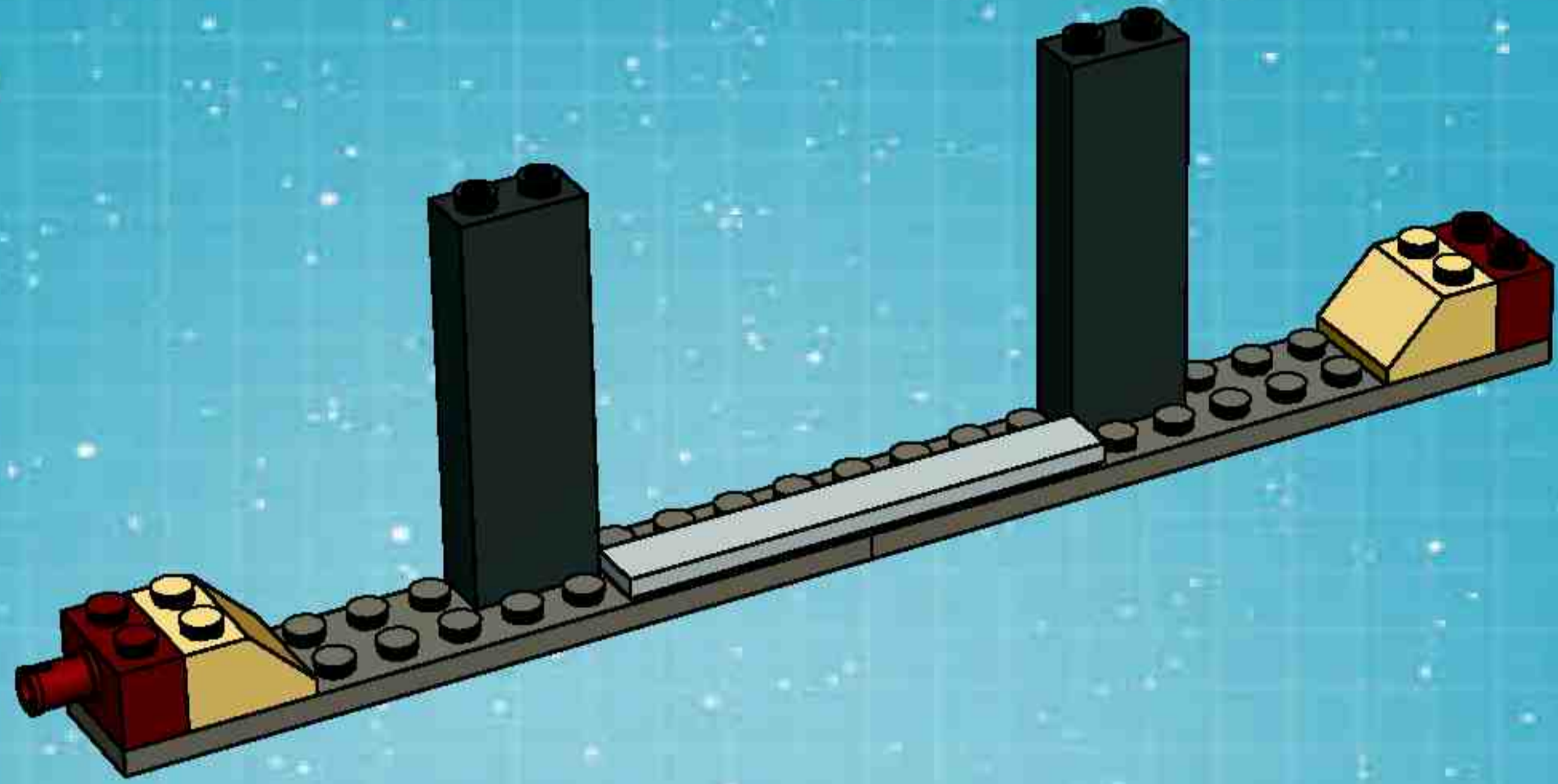

4

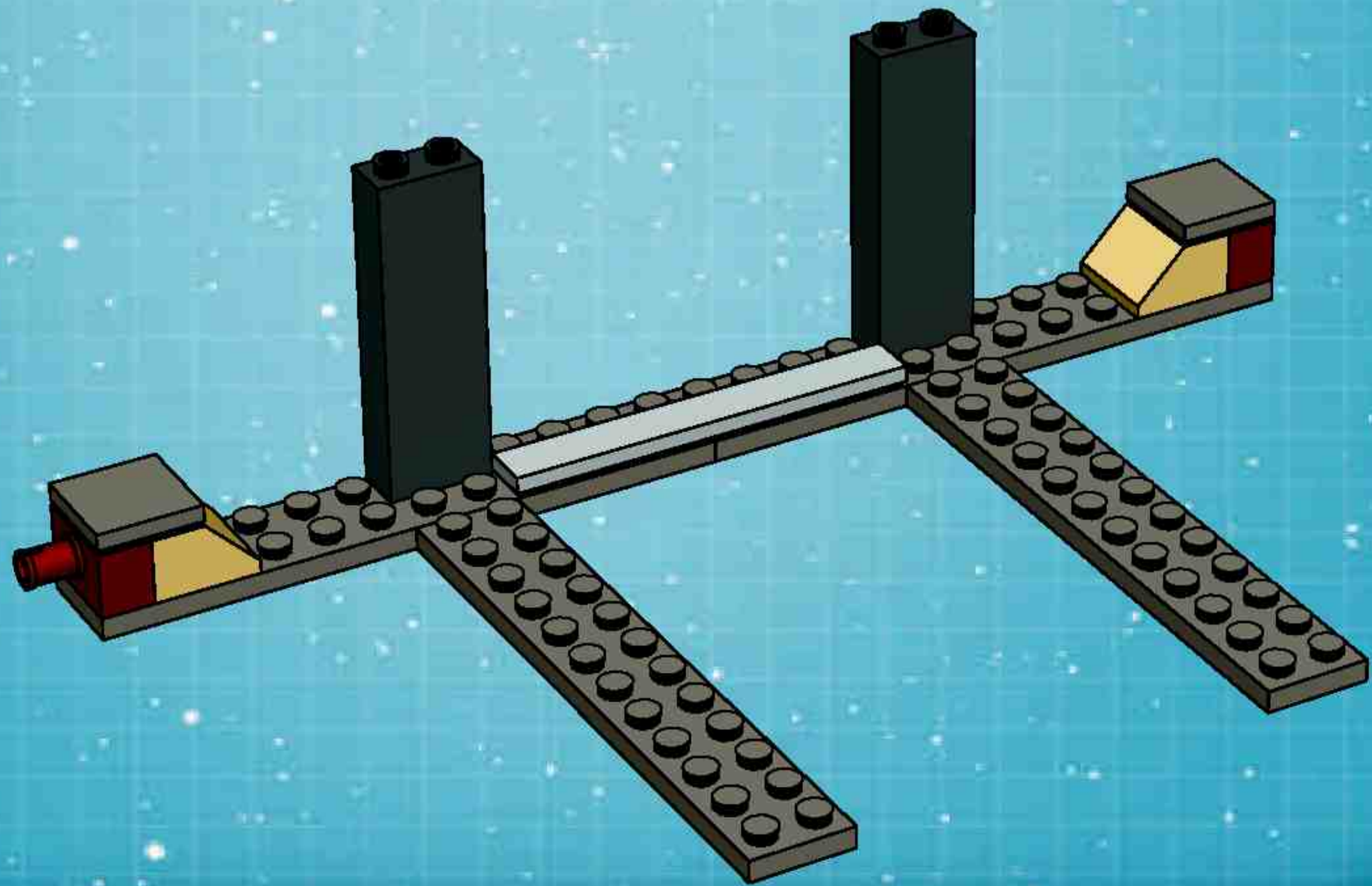

5

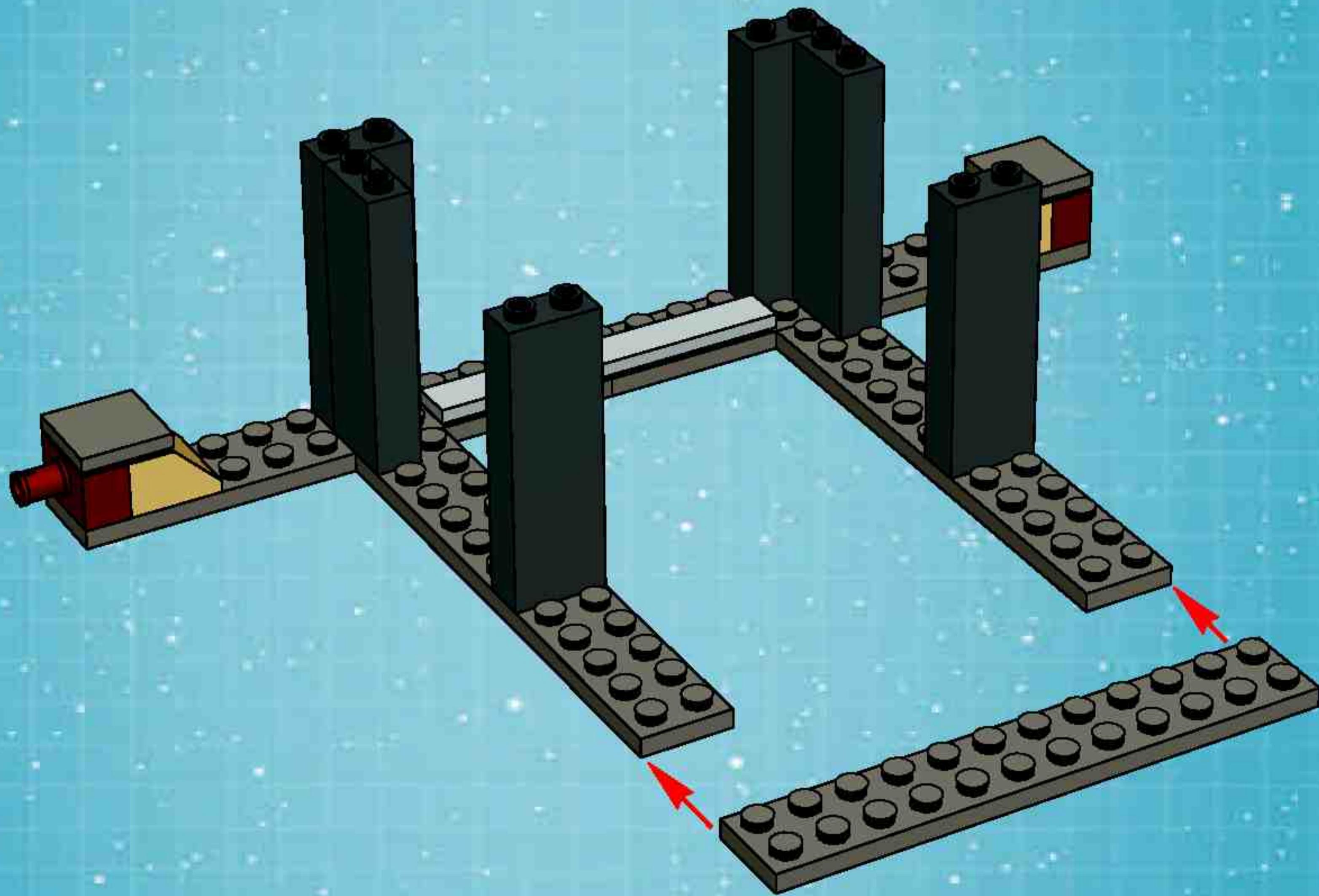

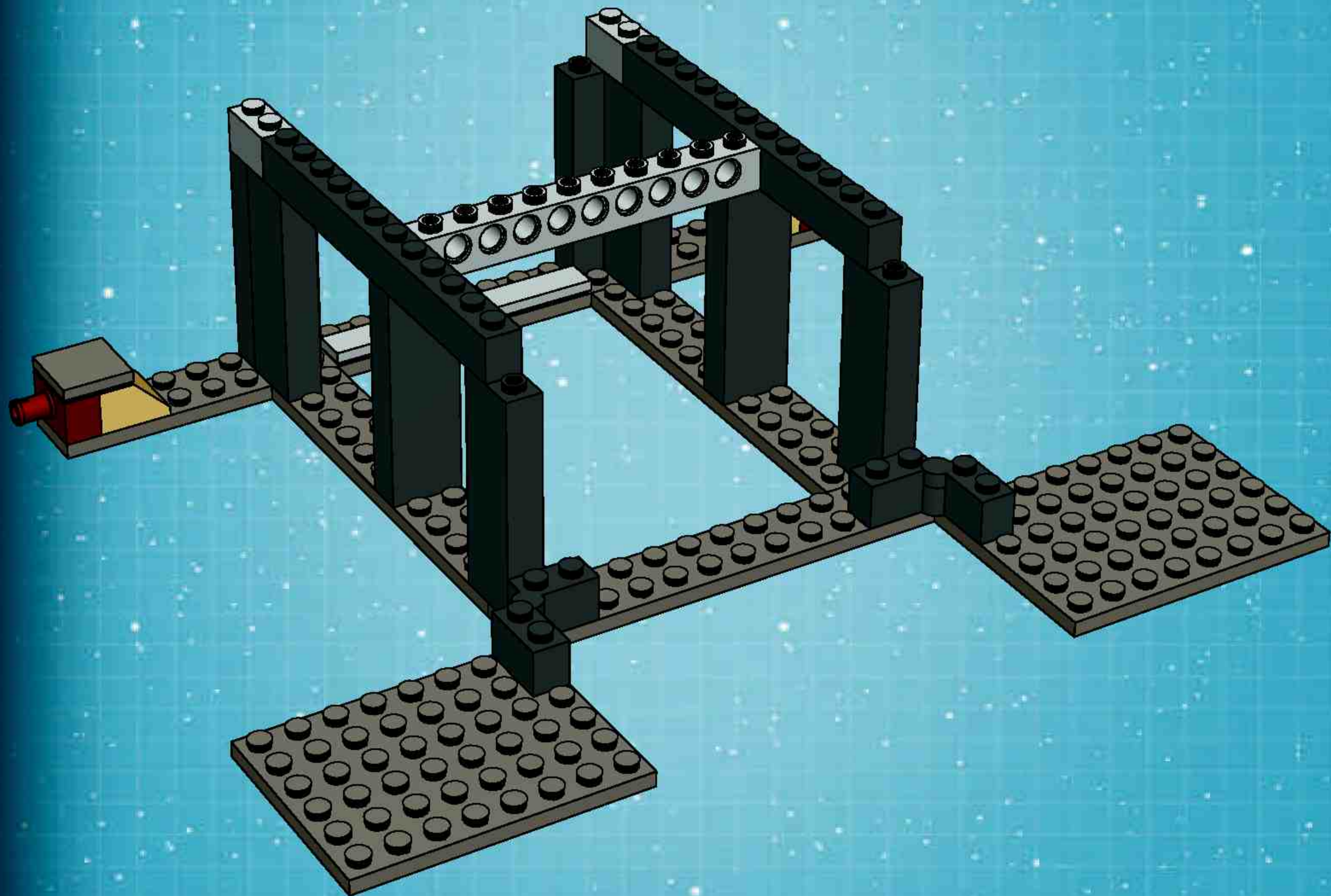

2

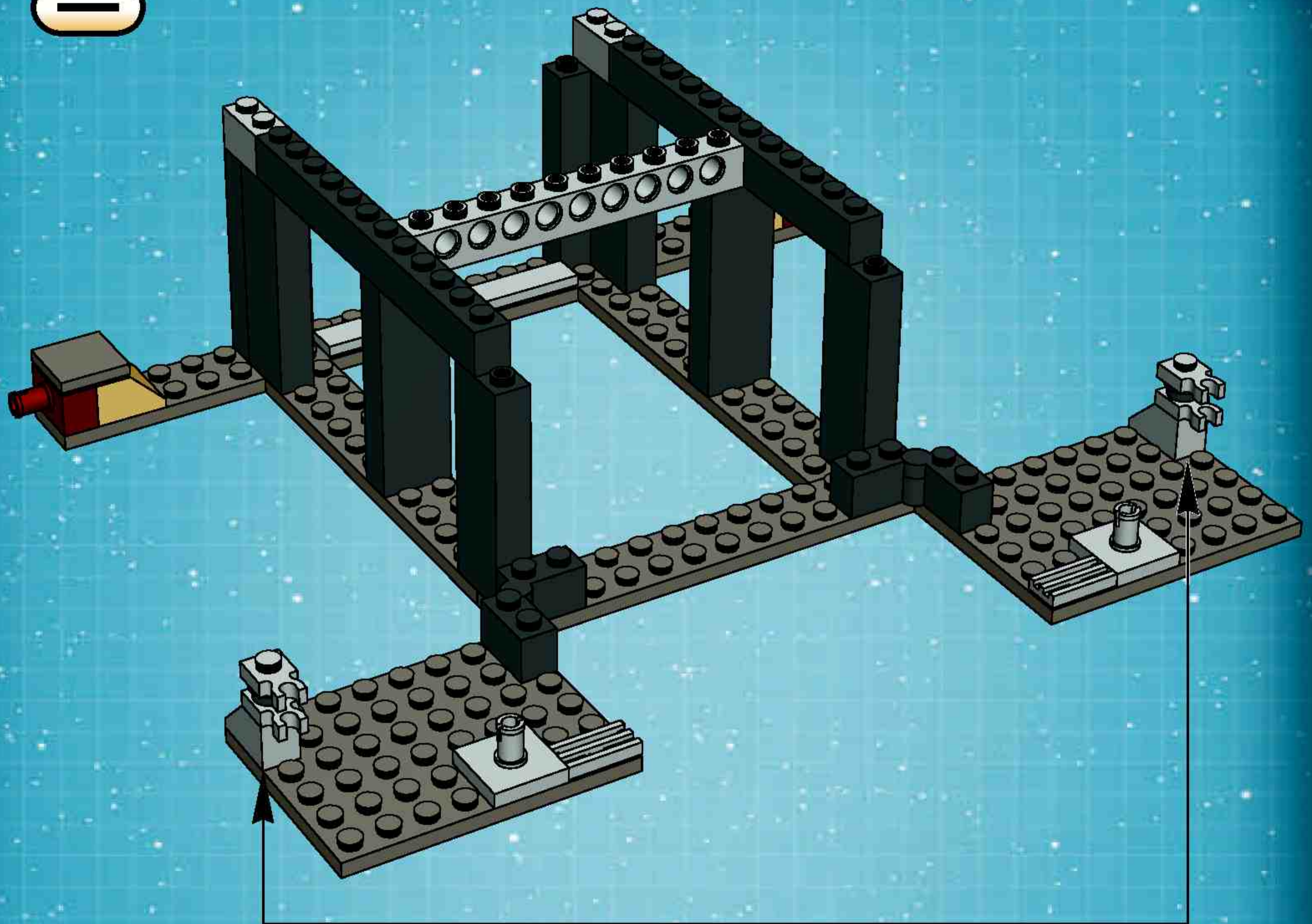

1 2 3

2x

The callout box contains three numbered steps (1, 2, 3) illustrating the assembly of a grey Technic connector. Step 1 shows a grey Technic connector being placed onto a grey Technic brick. Step 2 shows a grey Technic axle being inserted into the connector. Step 3 shows the final assembled connector. The text '2x' is located at the bottom right of the callout box.

9

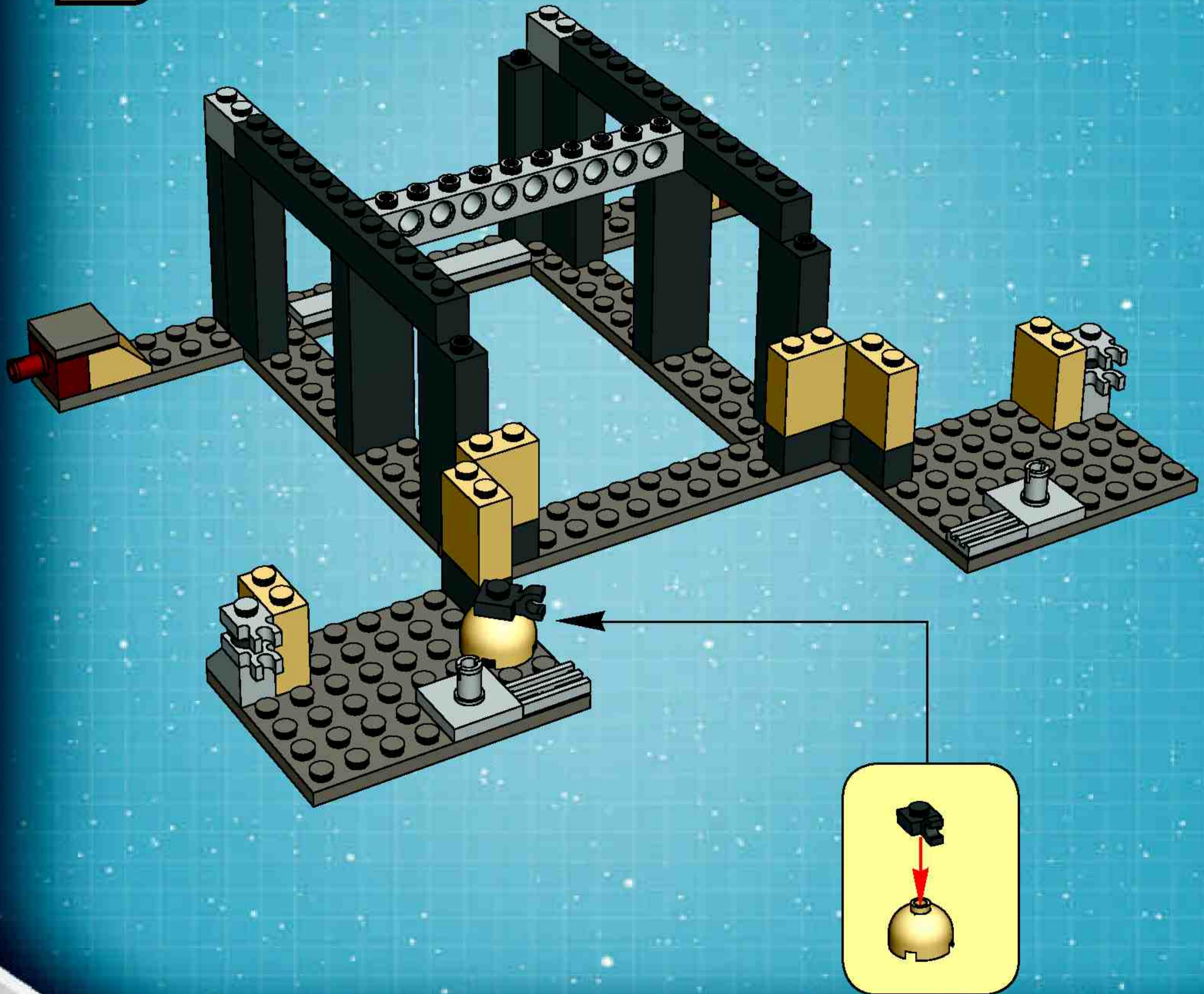

10

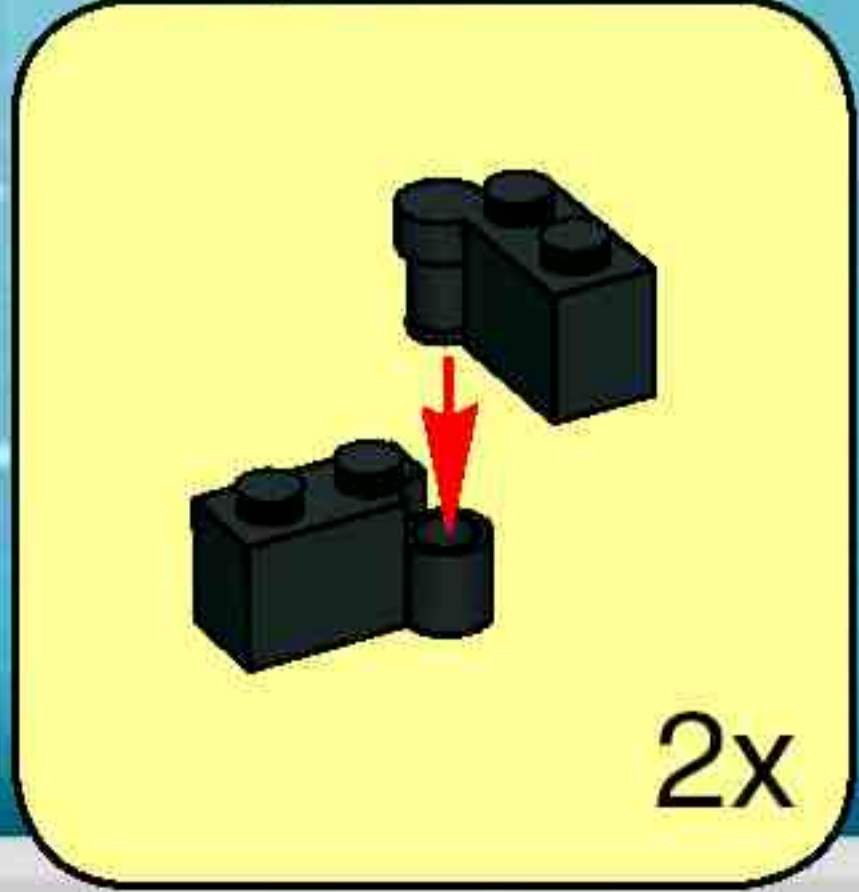
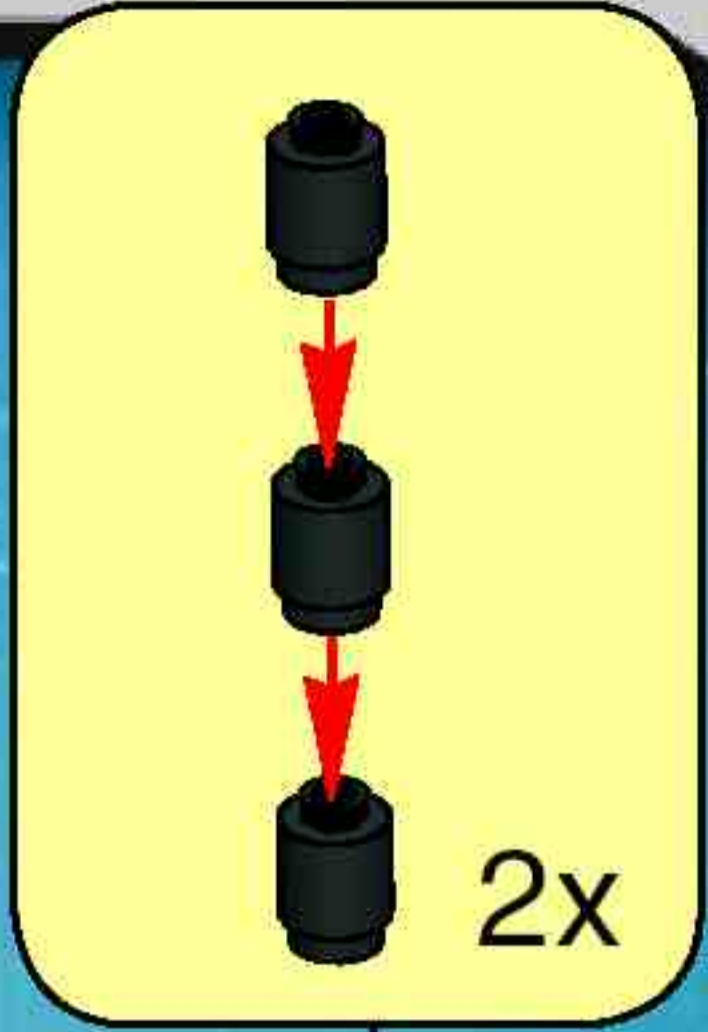
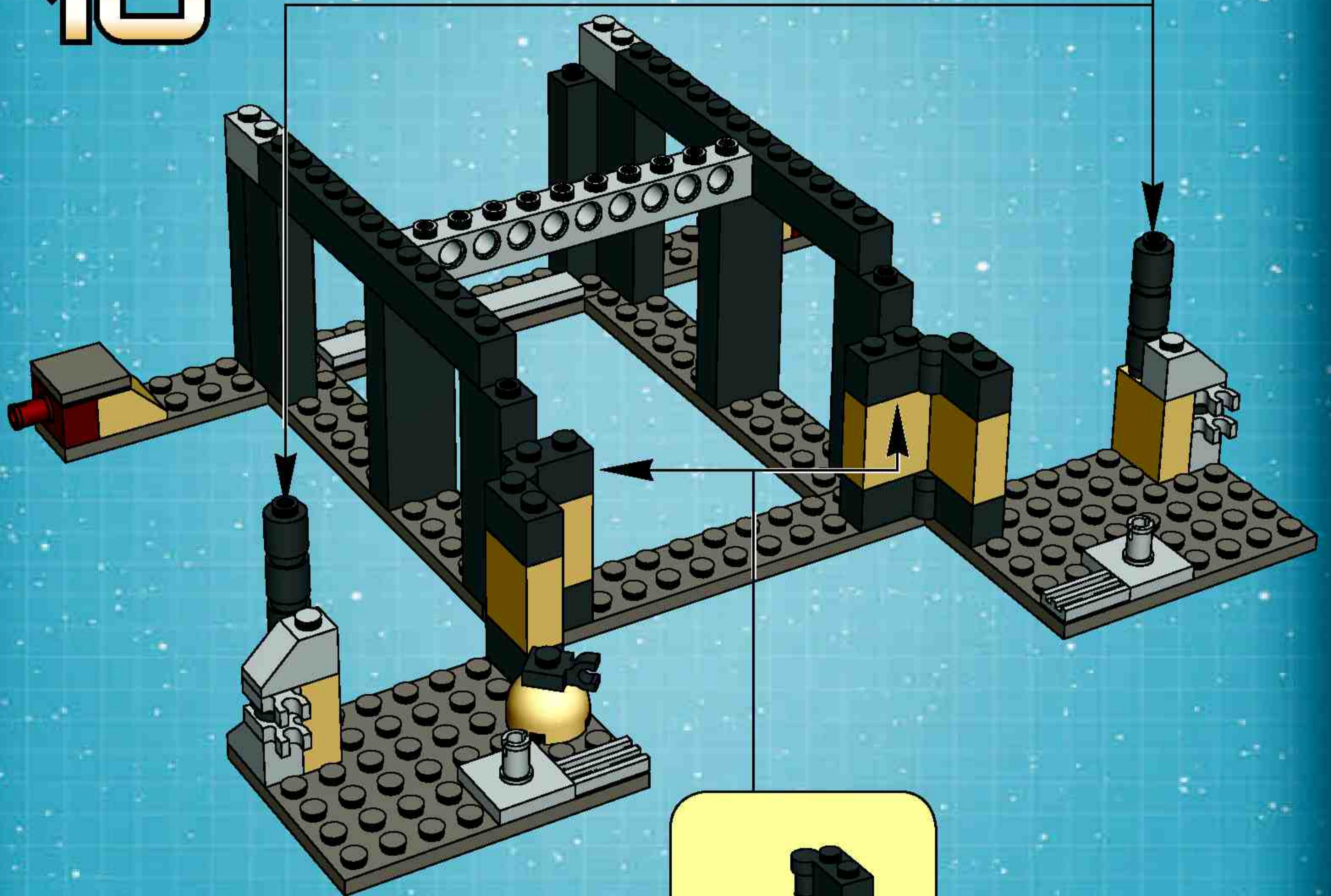

11

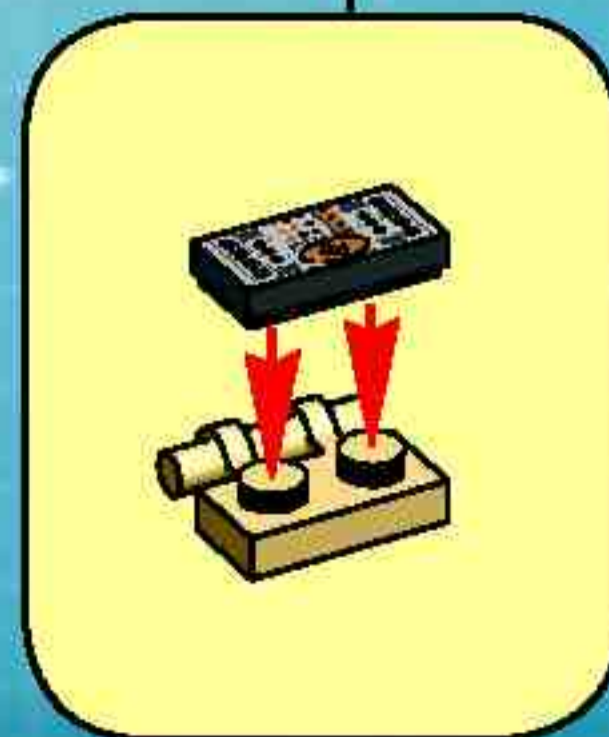
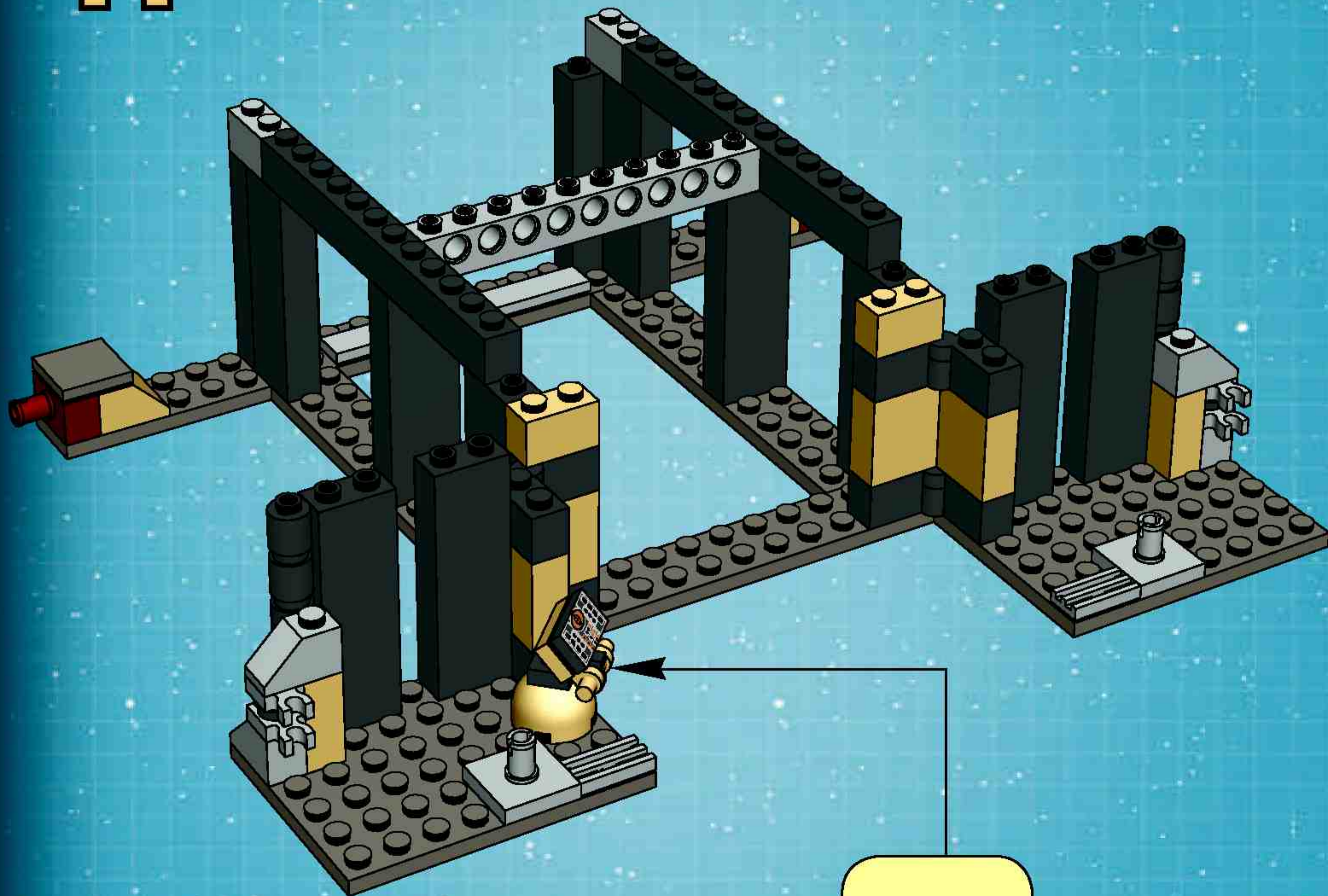

12

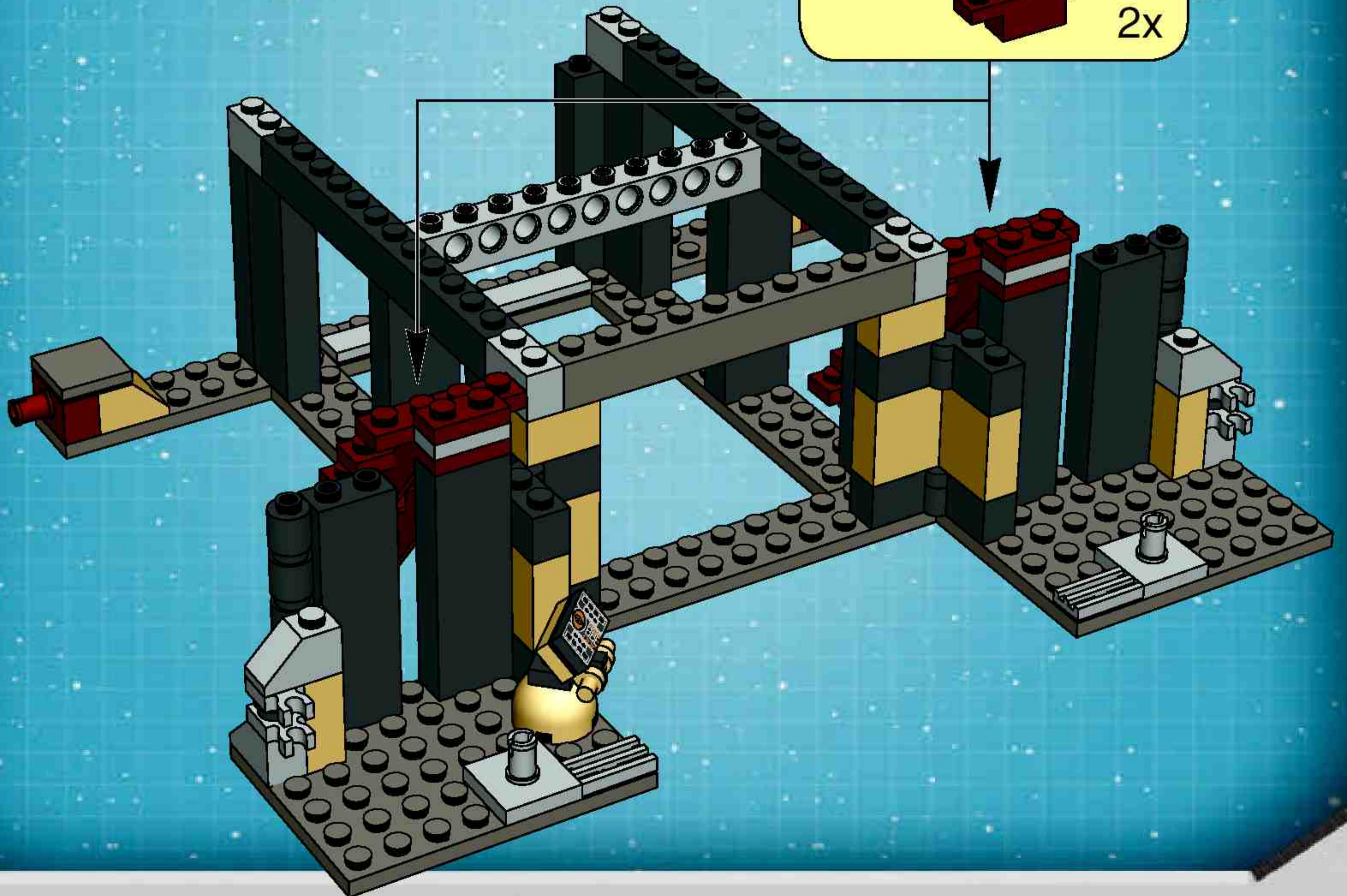
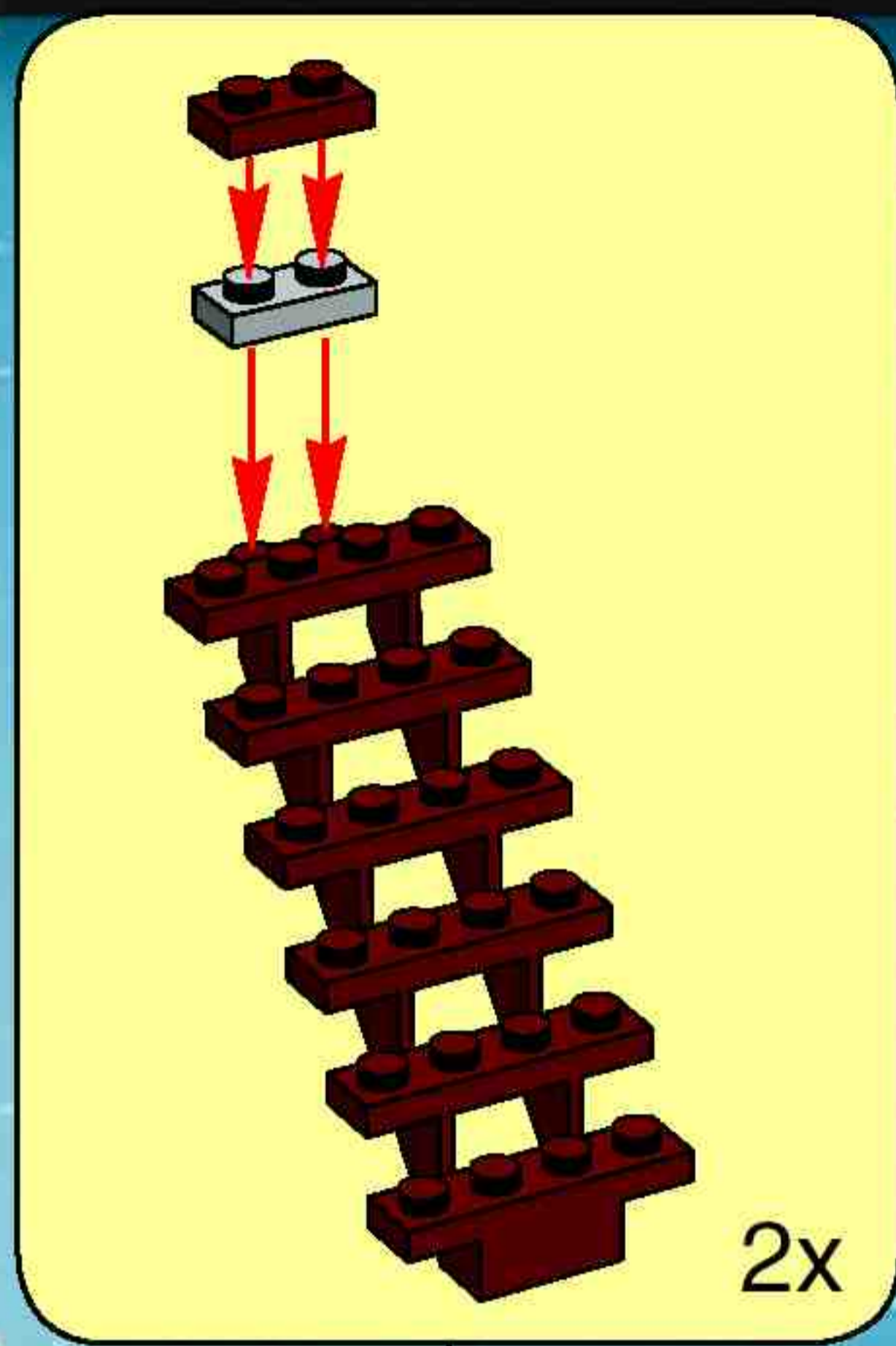

13

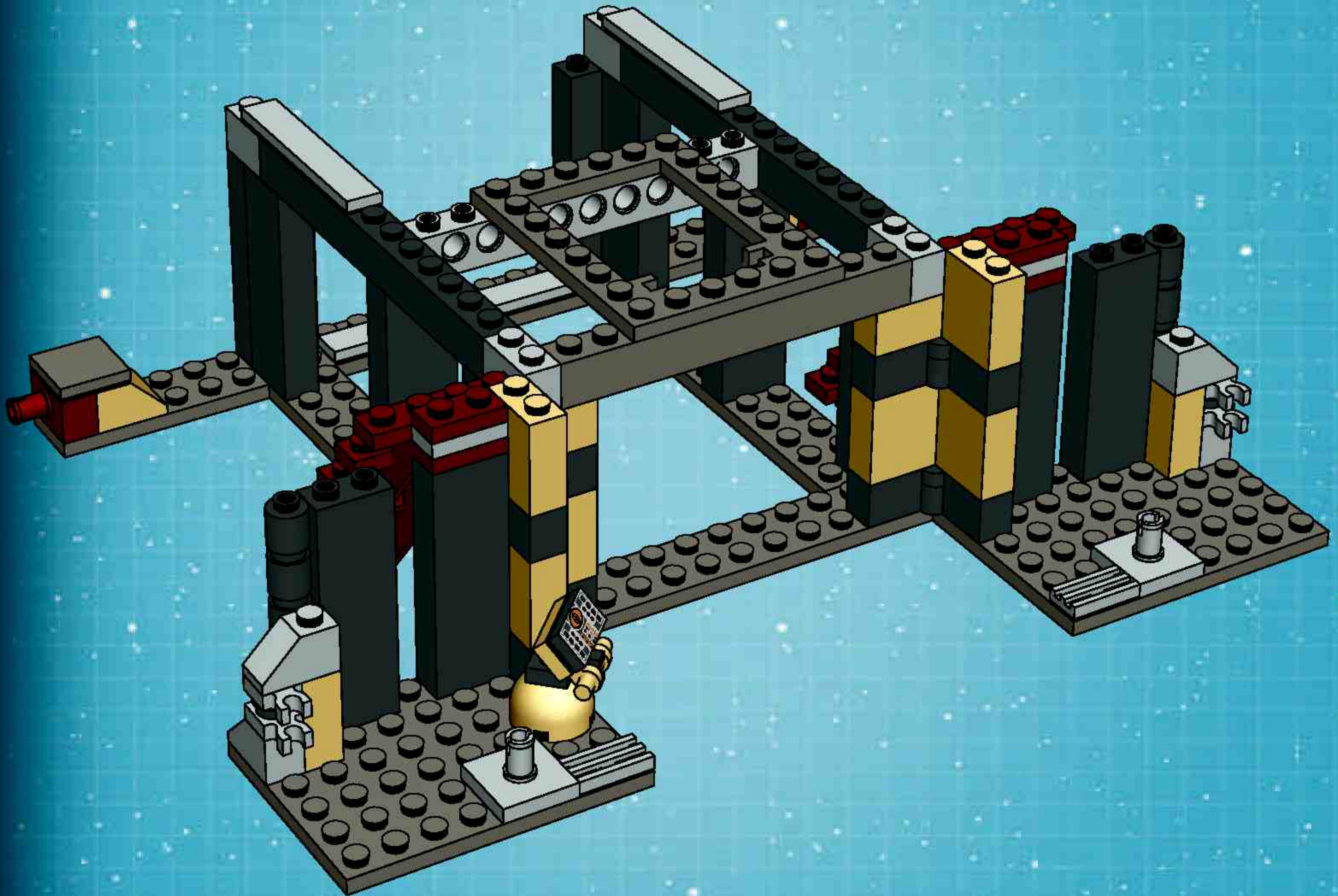

14

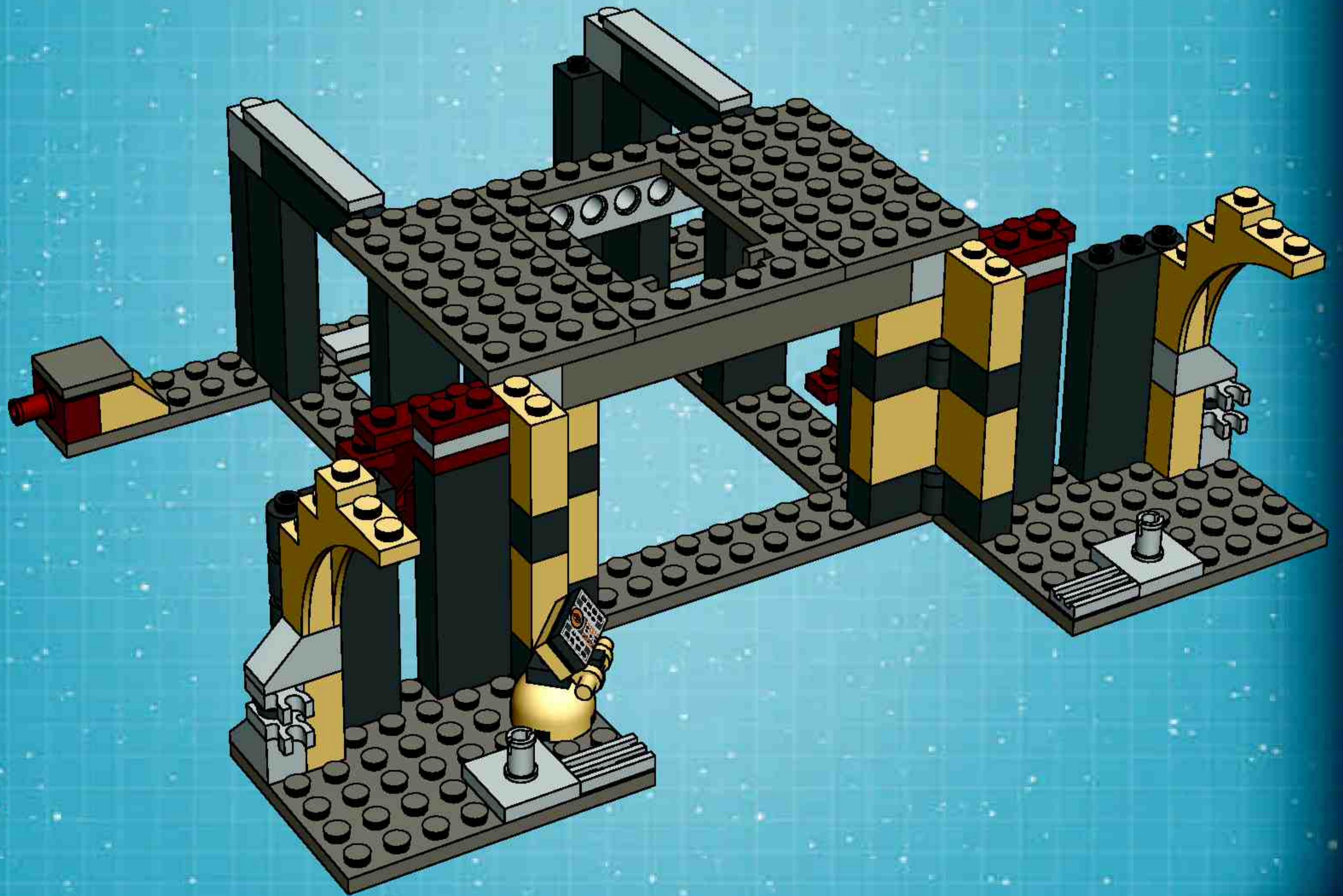

15

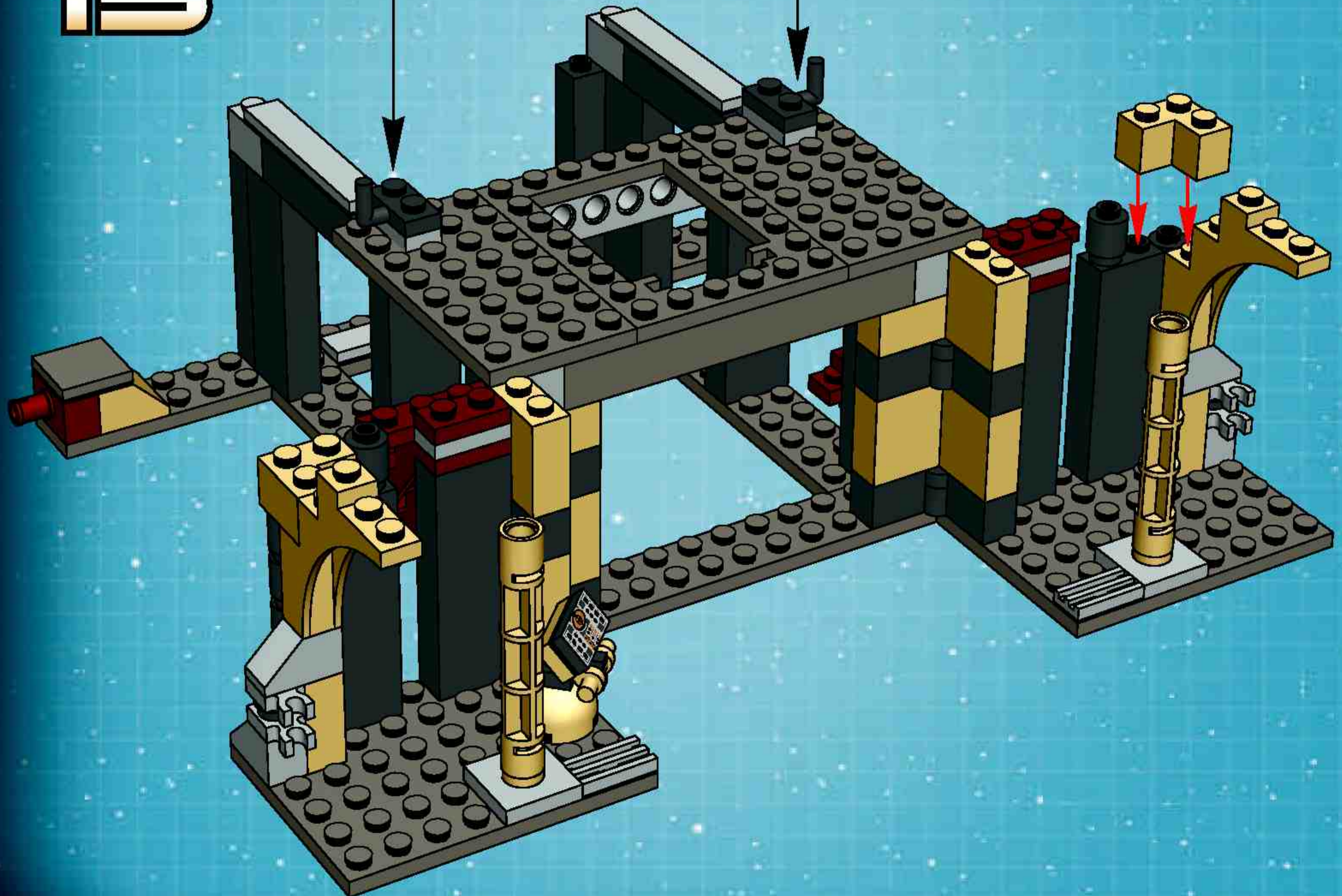
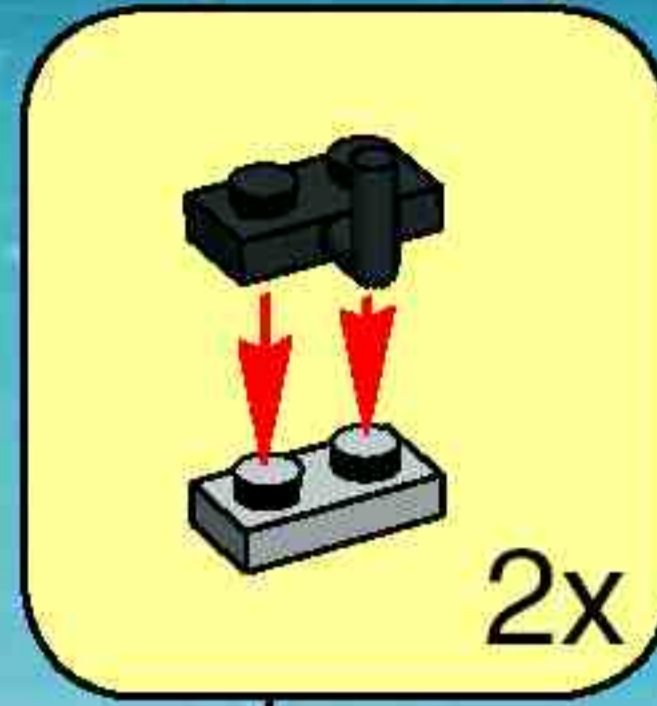

1

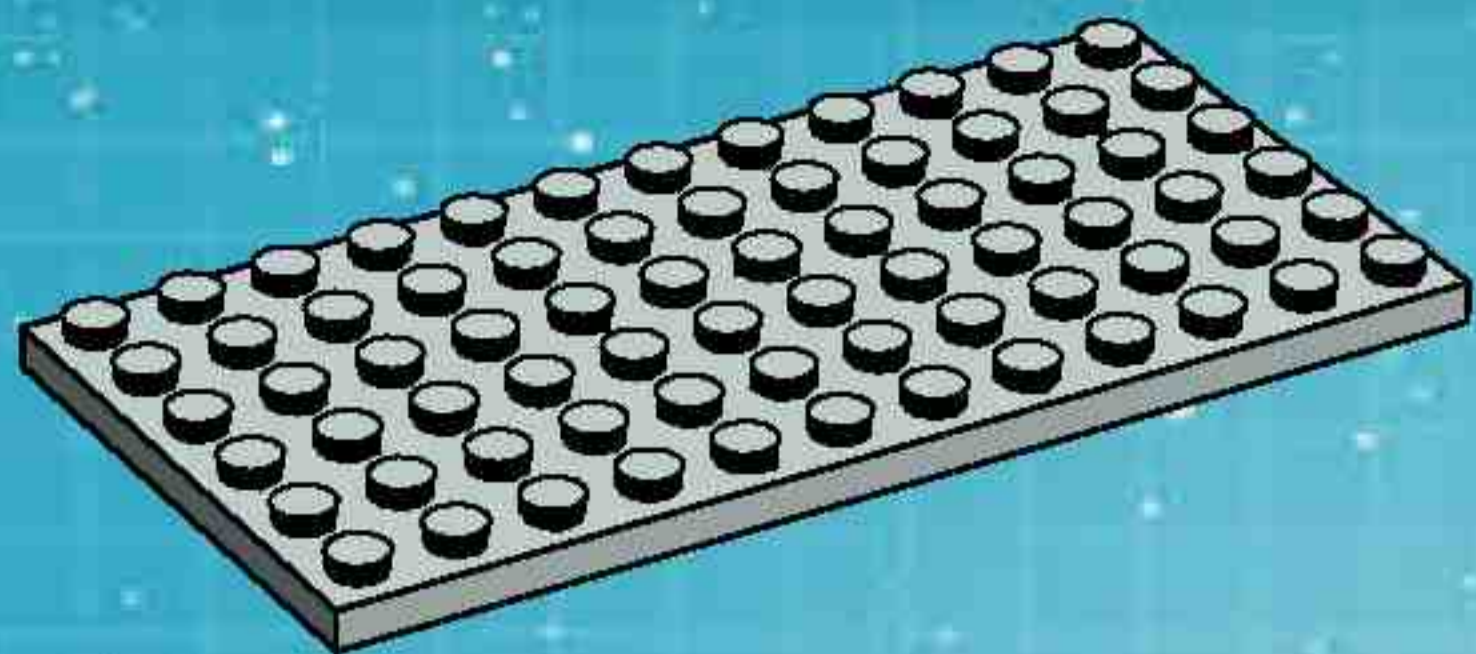

2

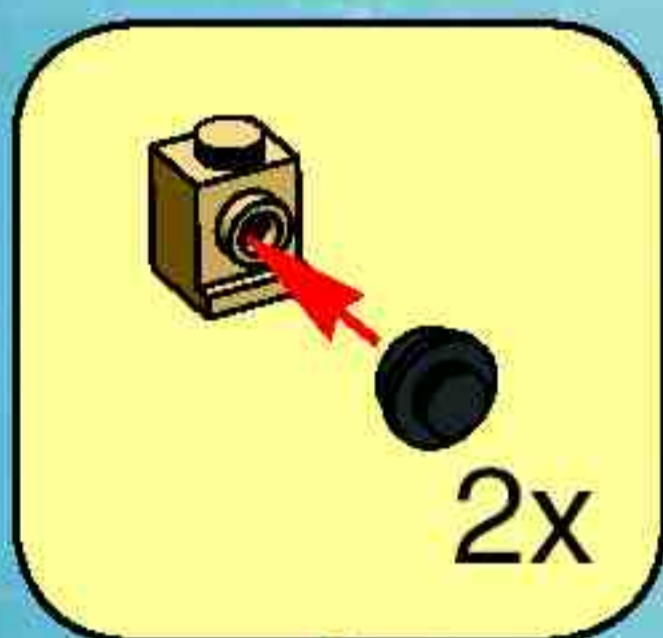
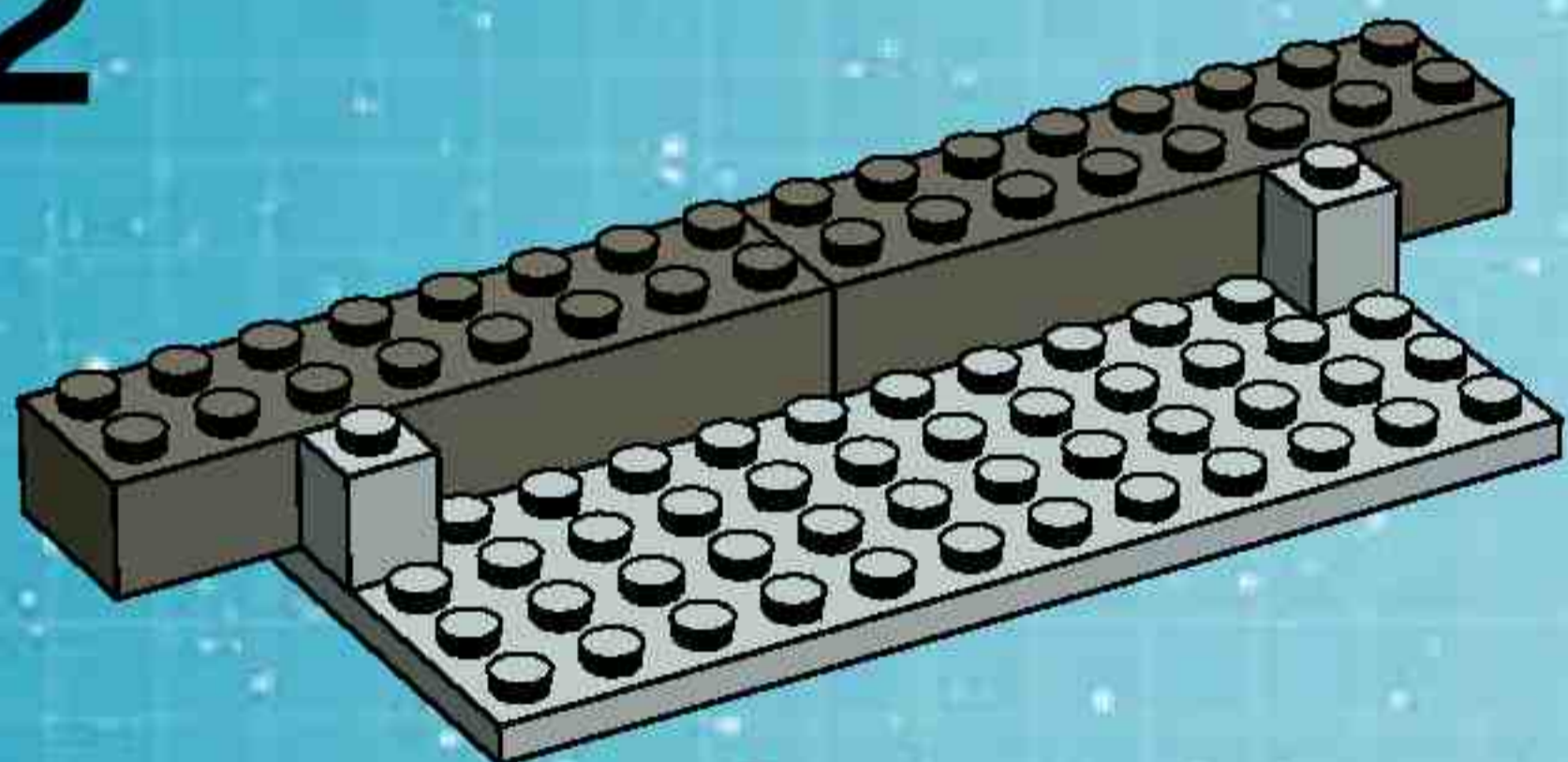

3

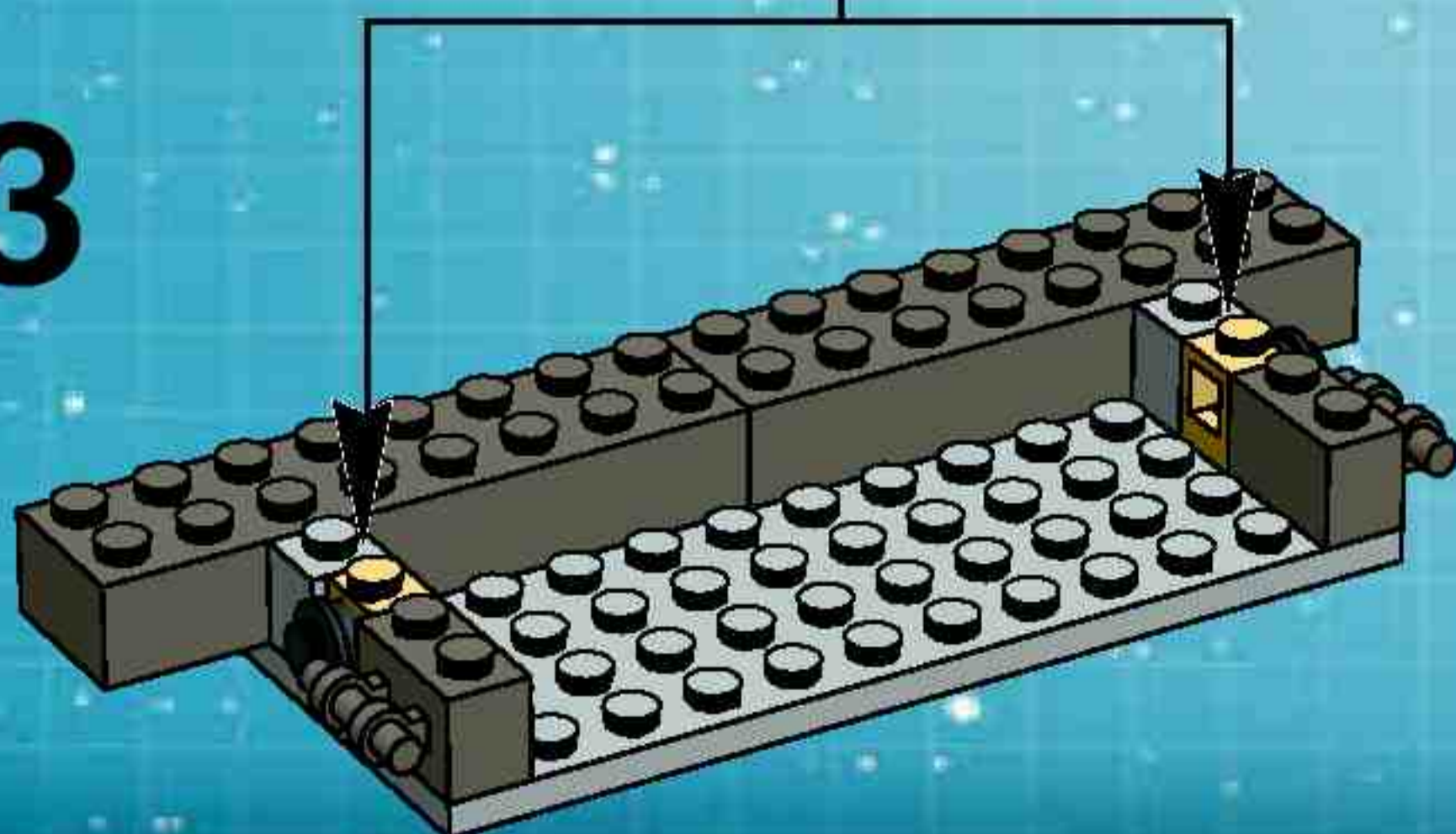

4

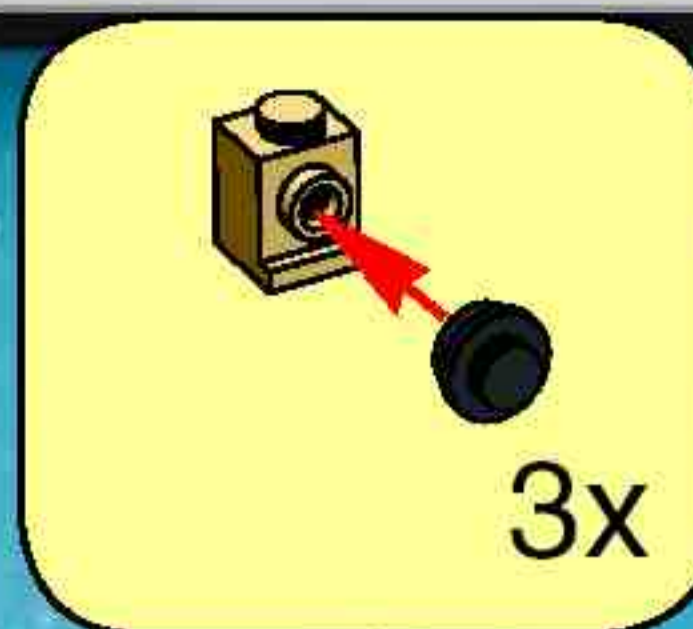
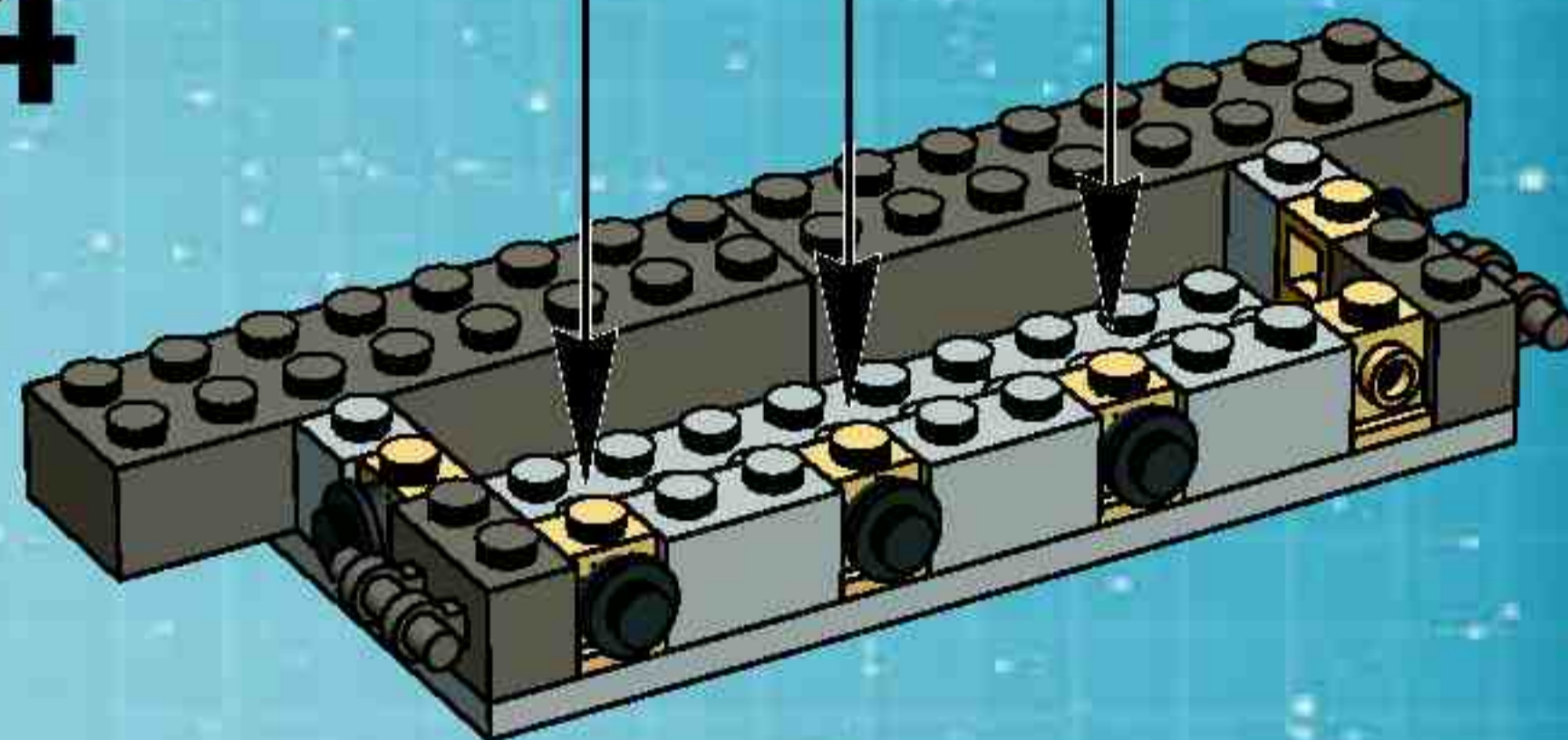

5

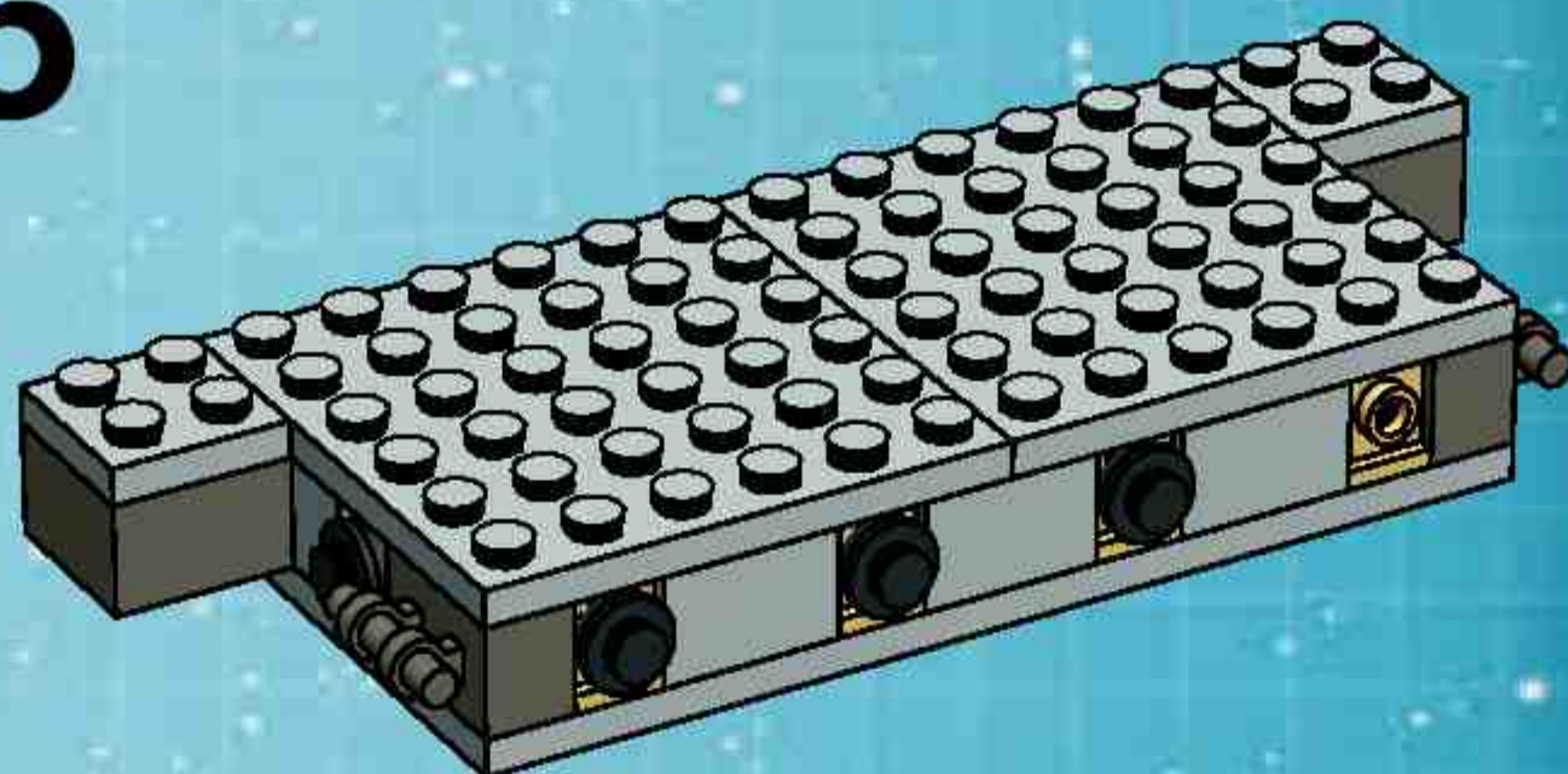

6

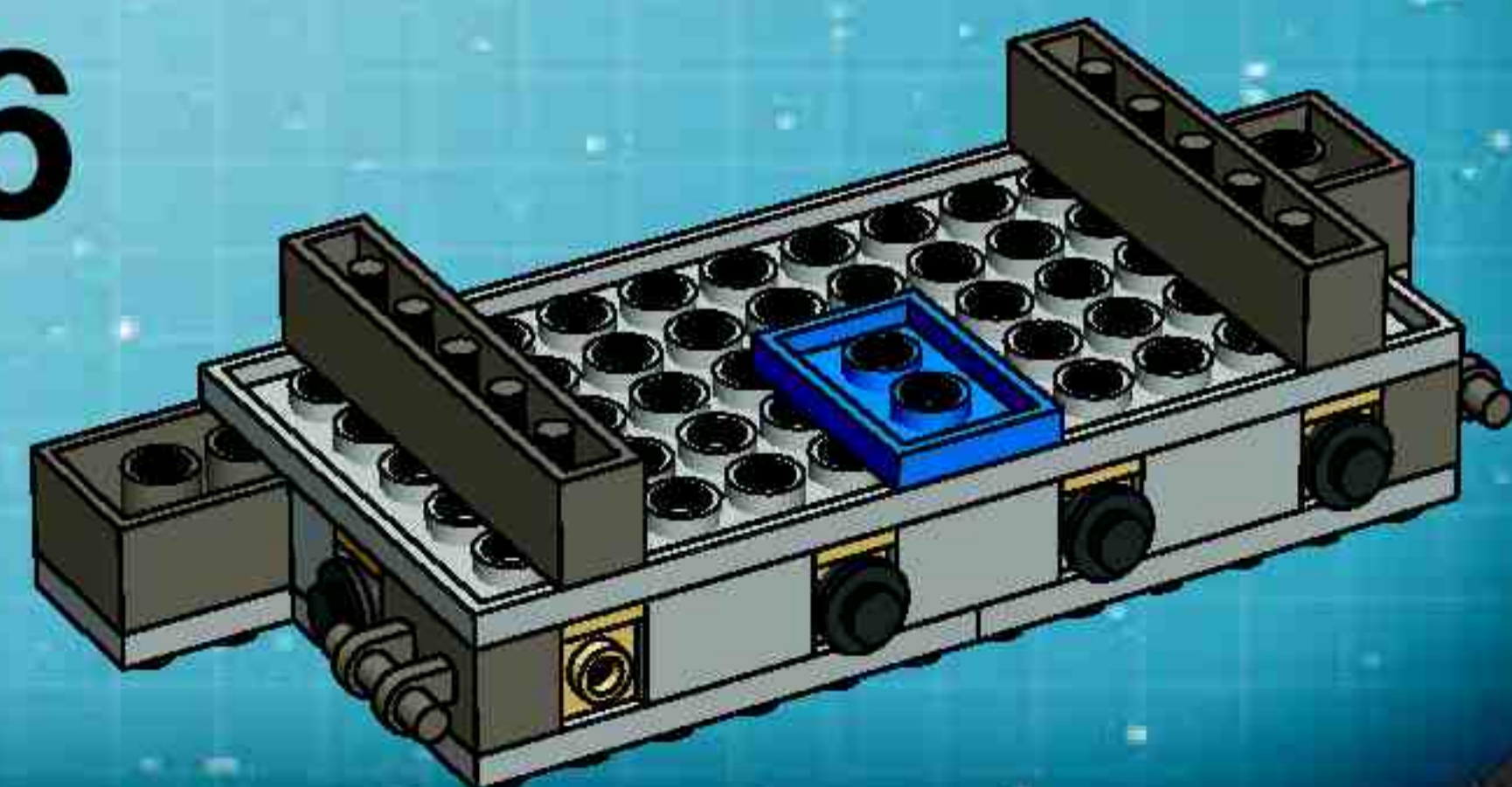

7

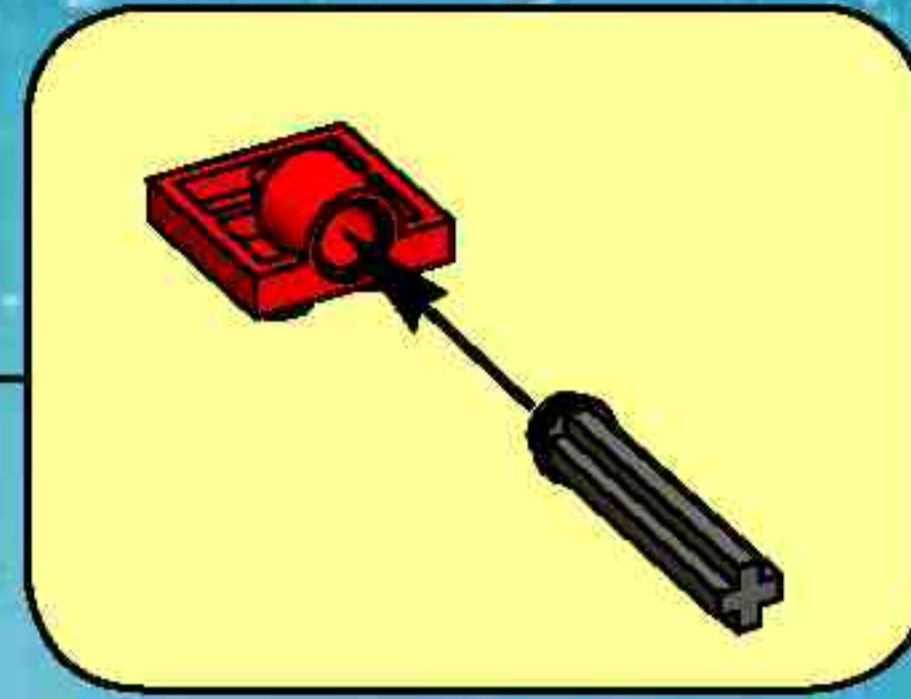
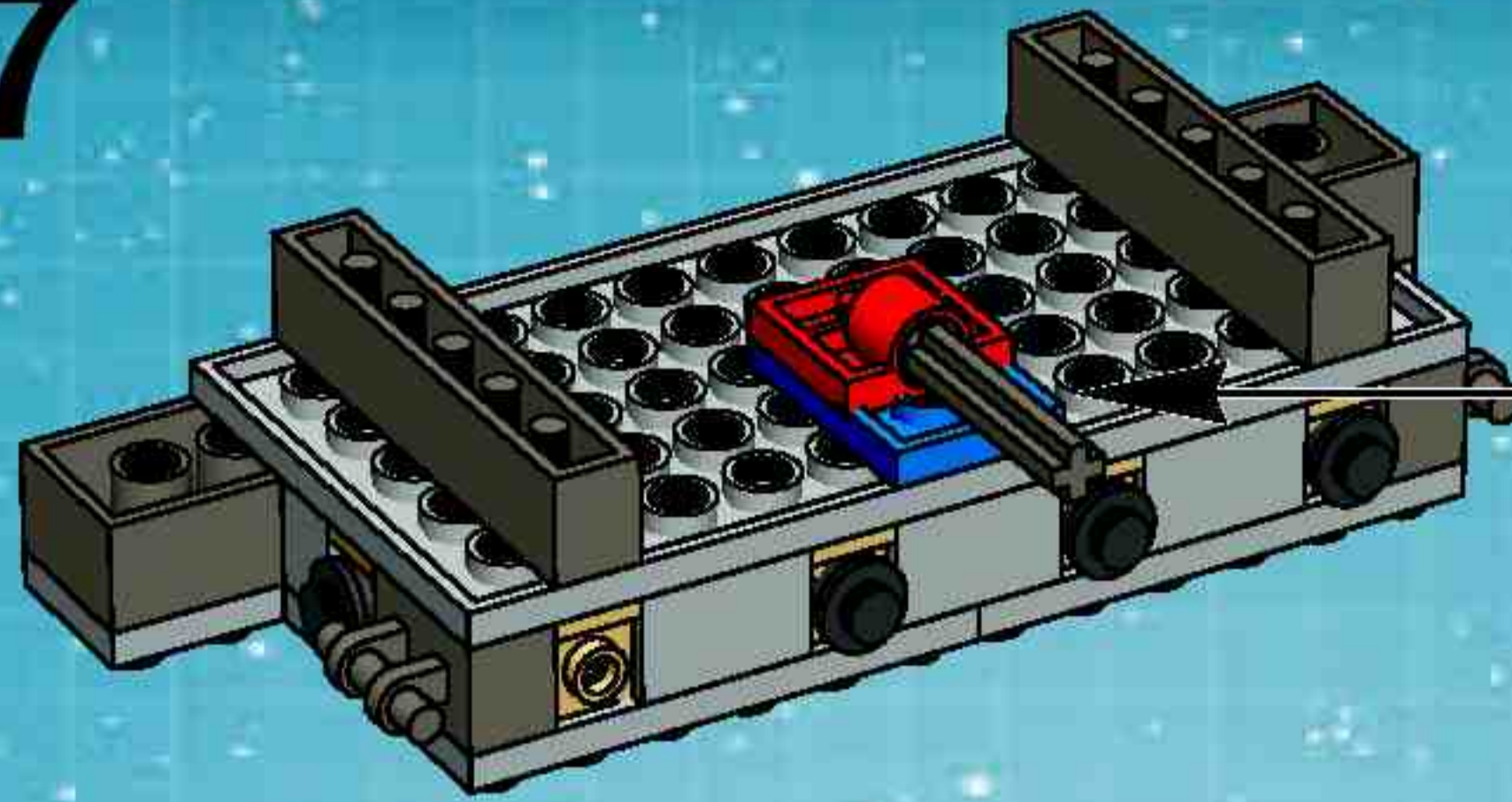

16

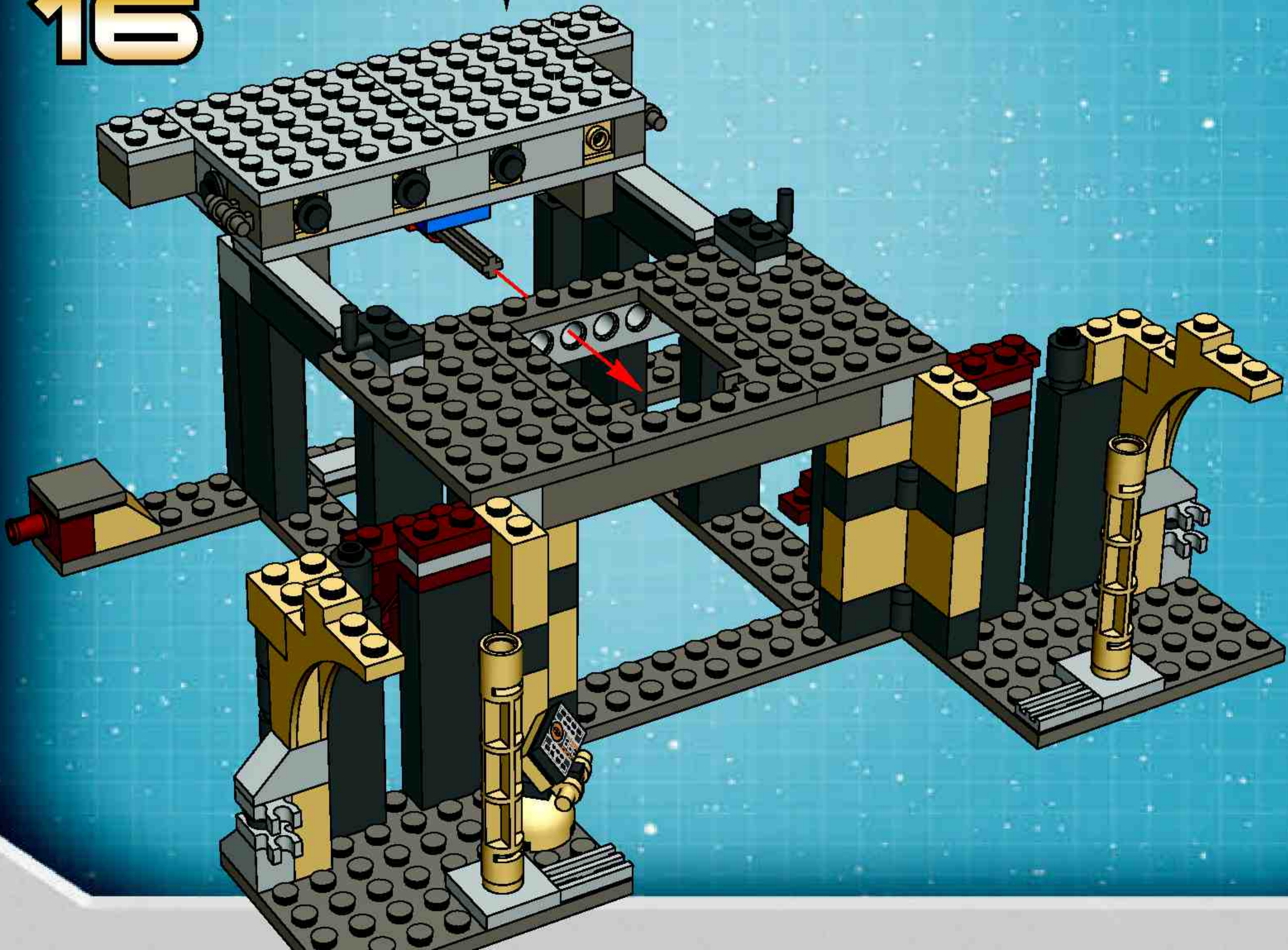

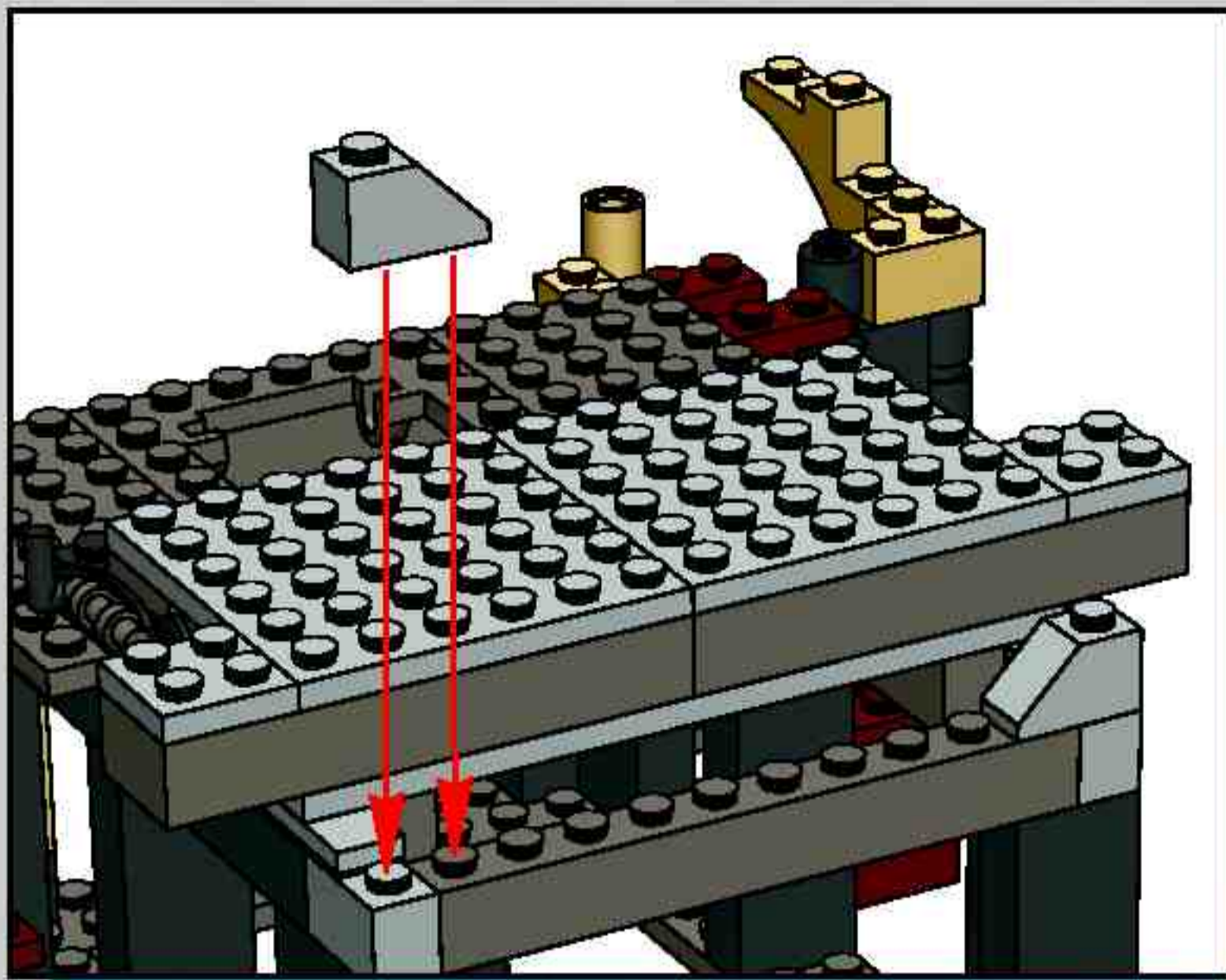

17

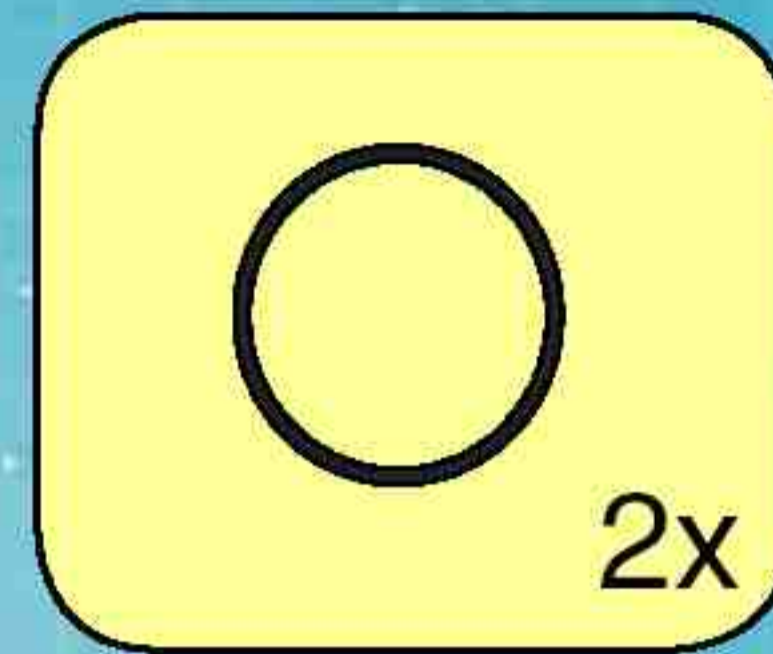

19

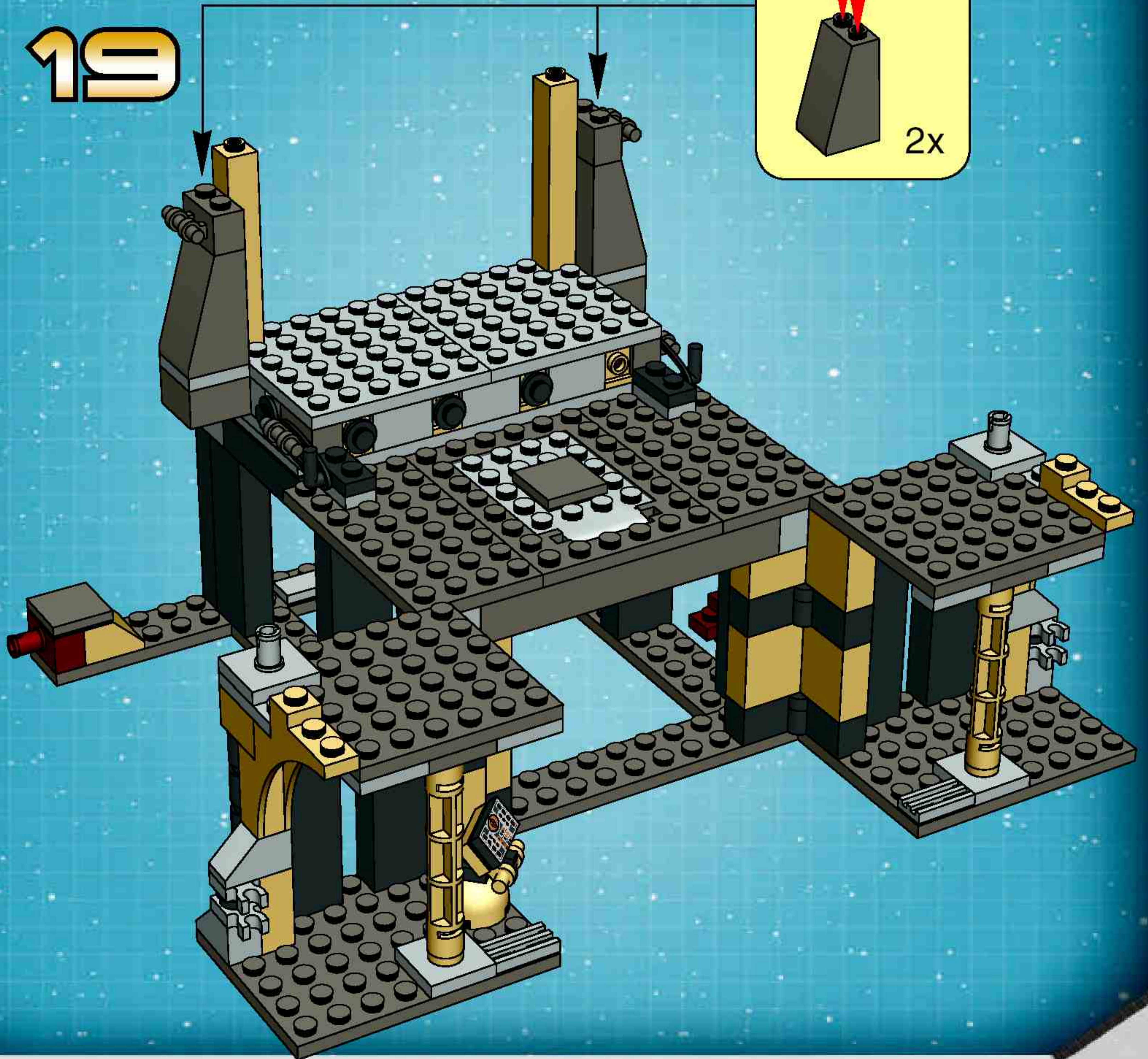

20

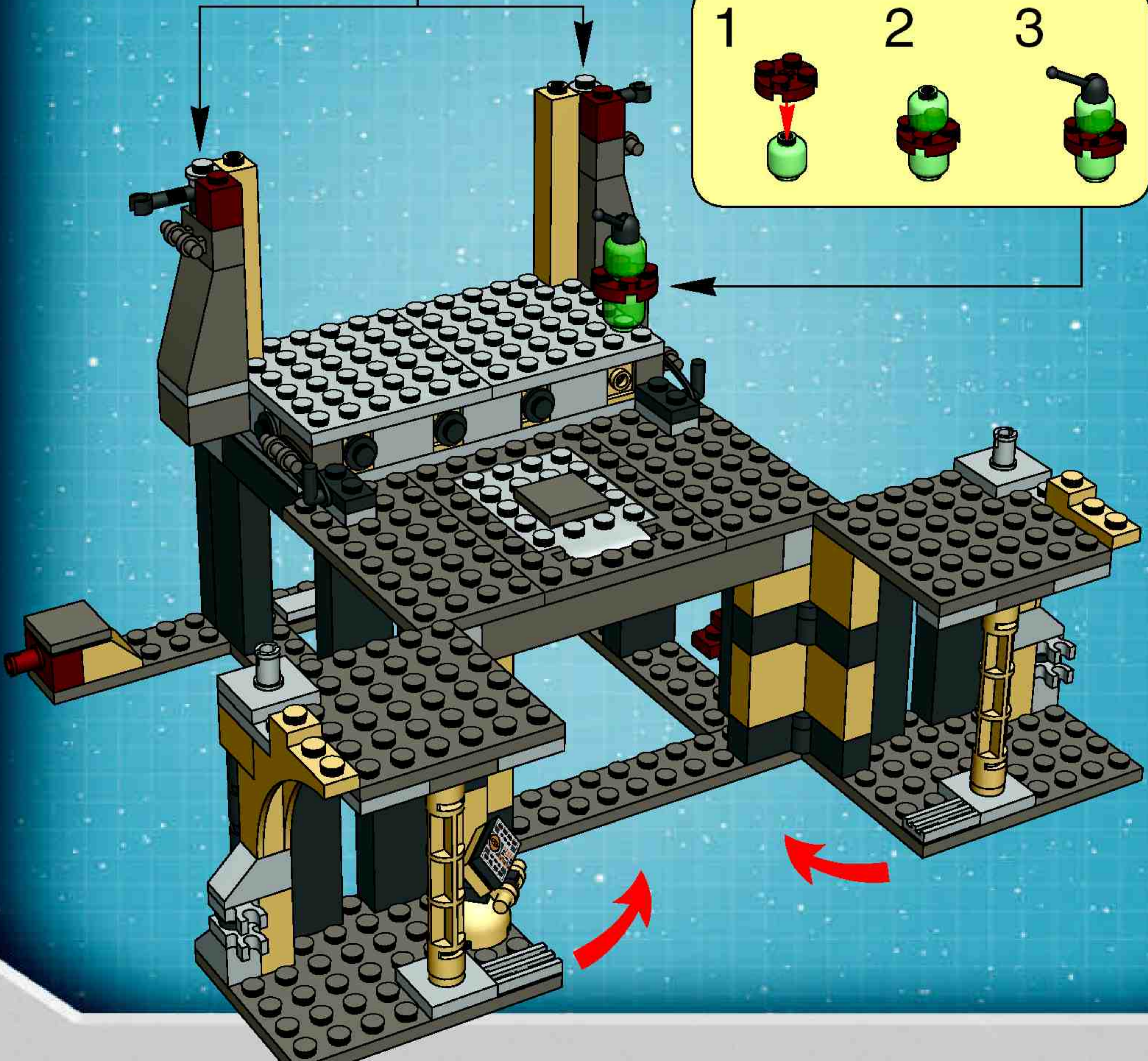
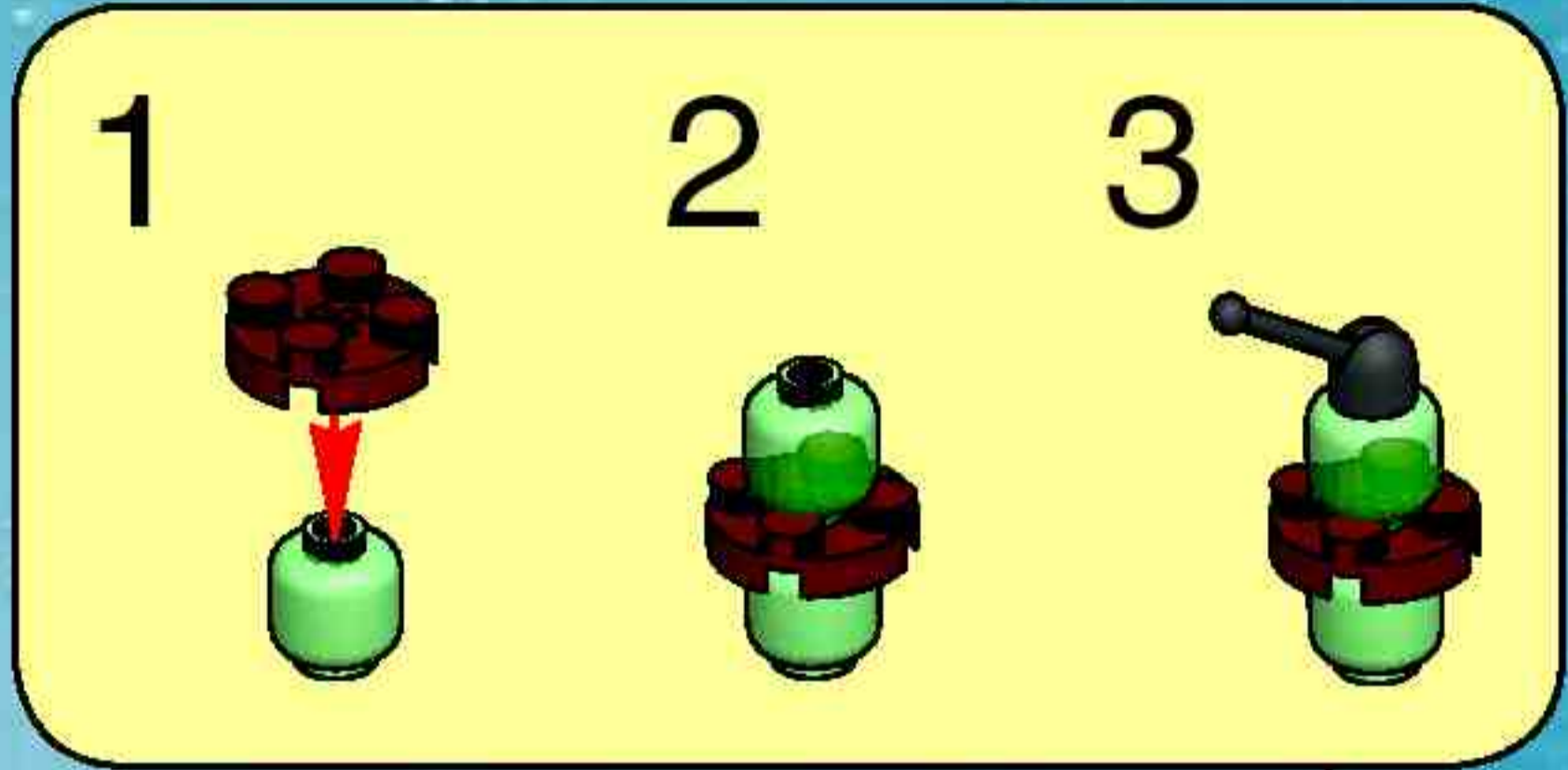
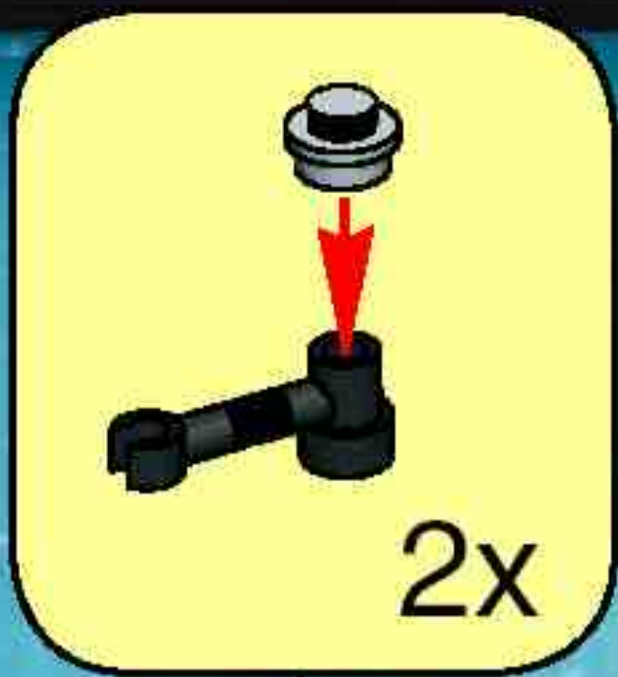

21

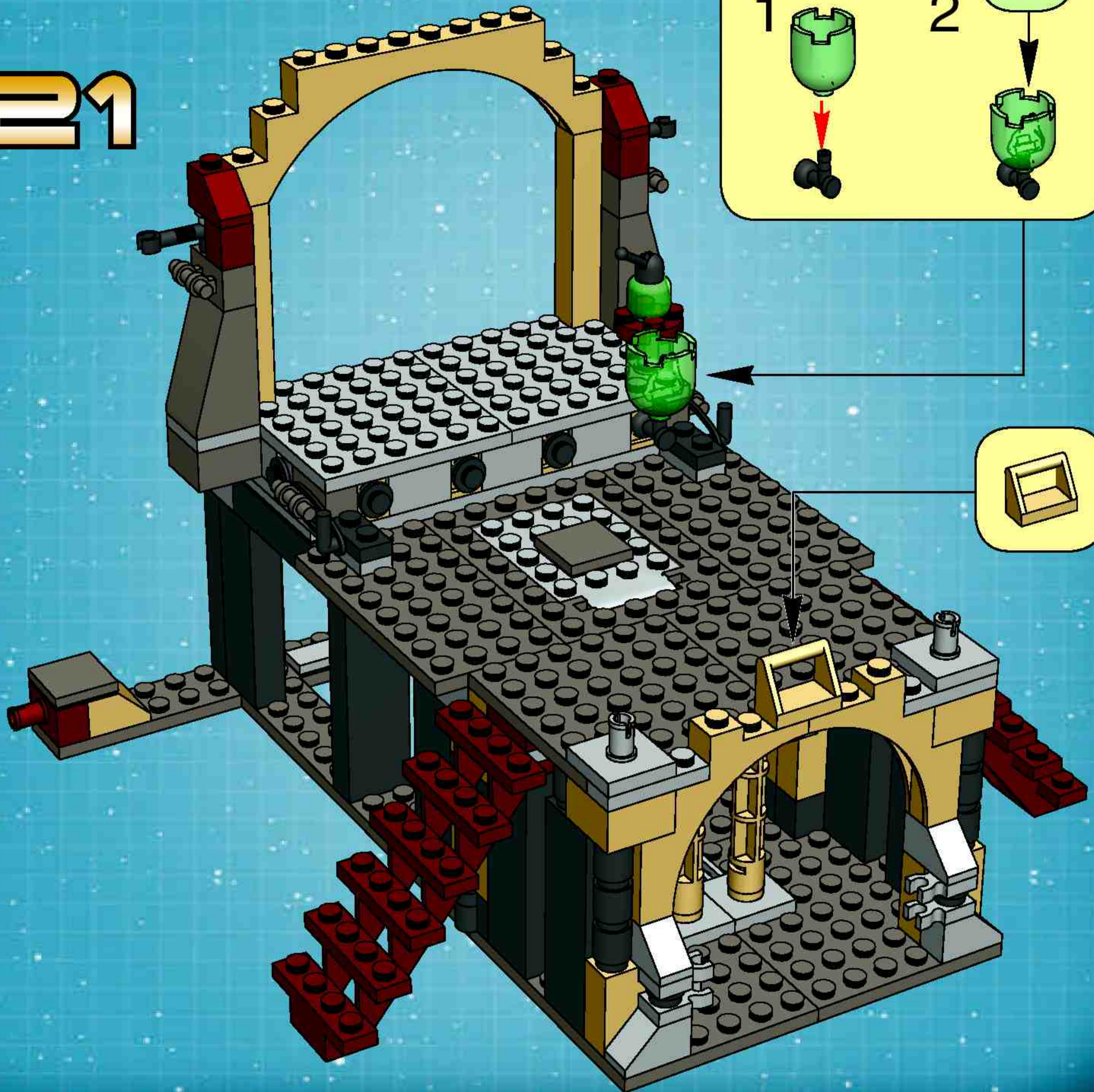

22

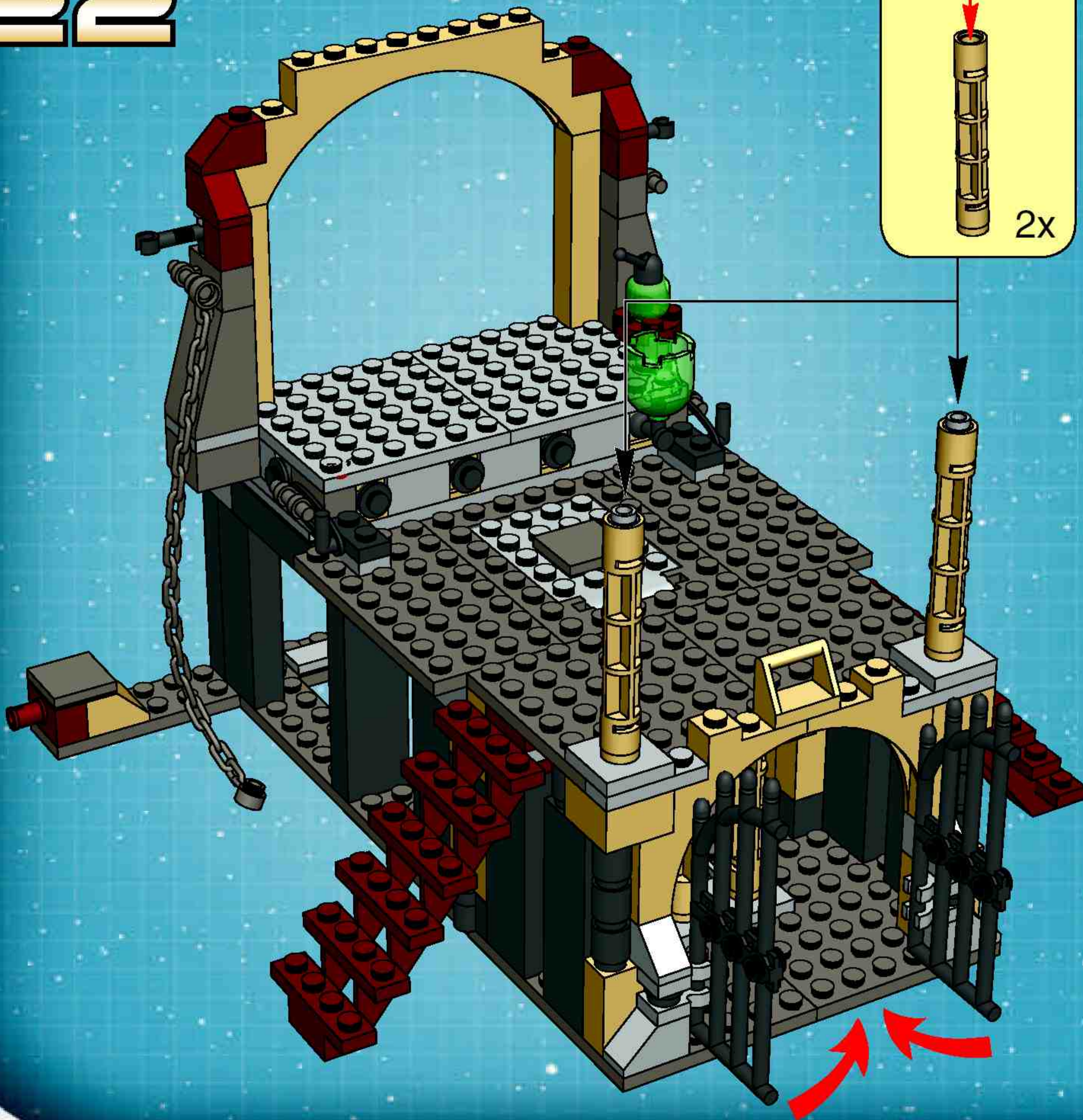

23

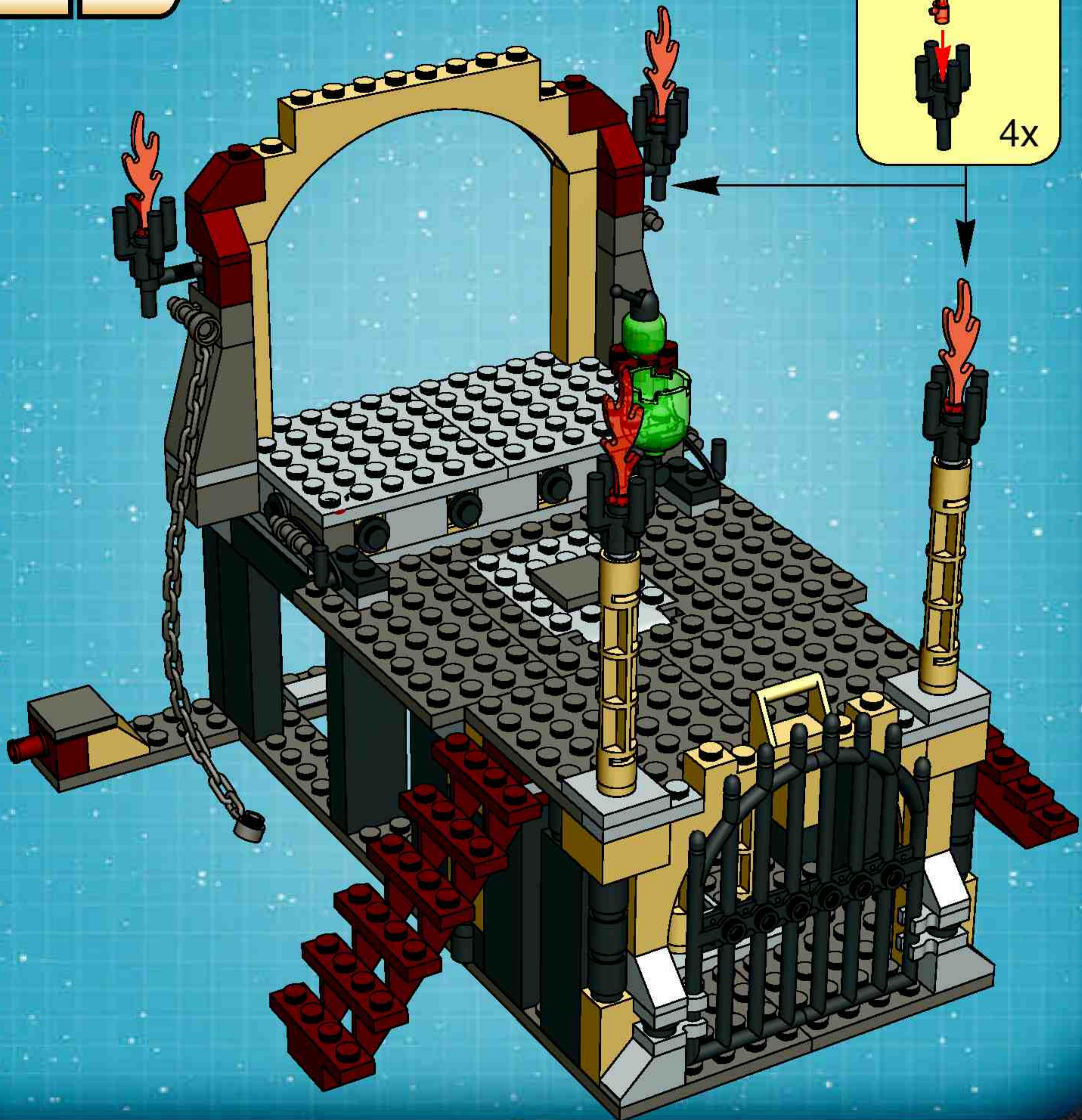

24

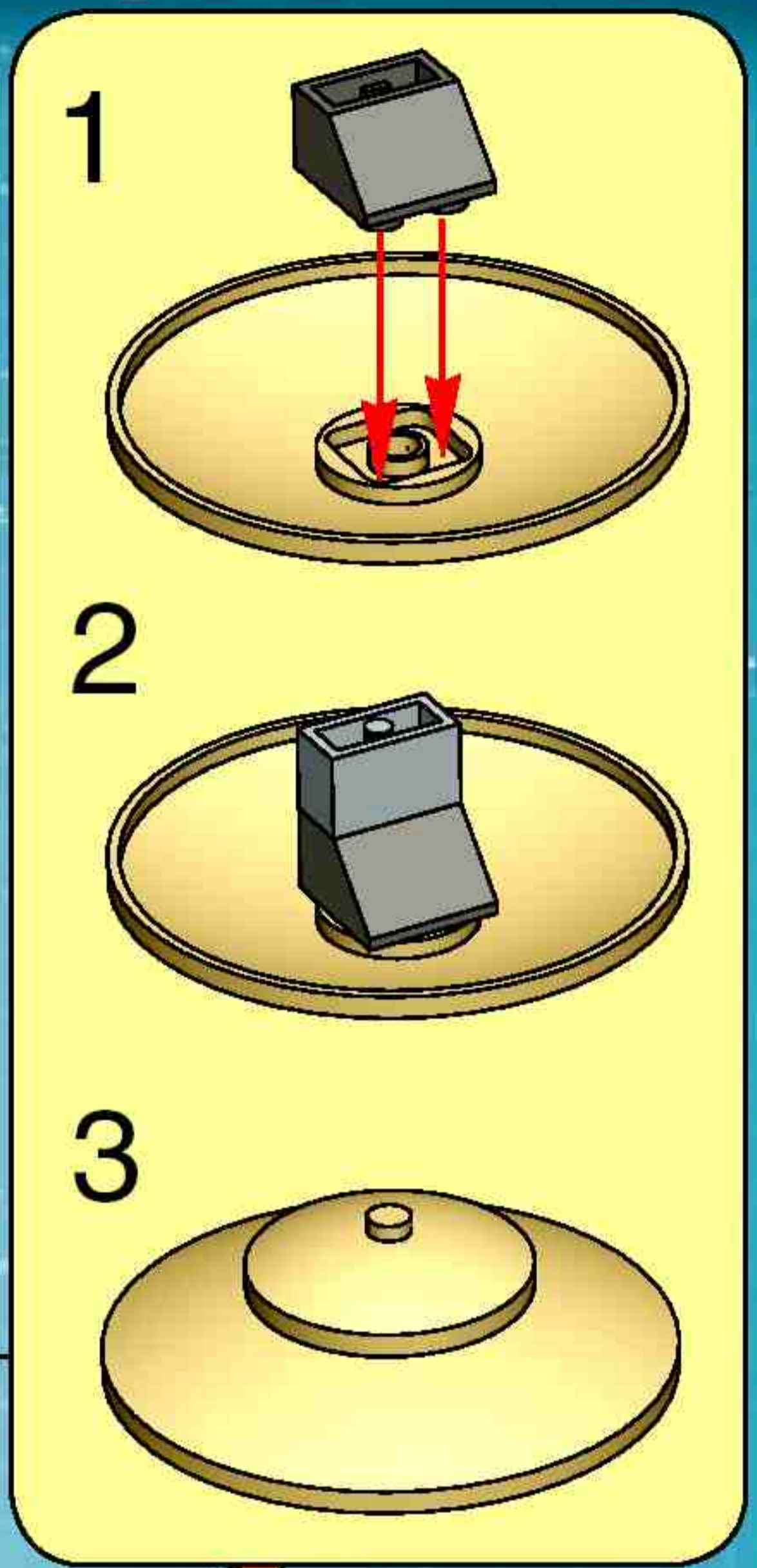
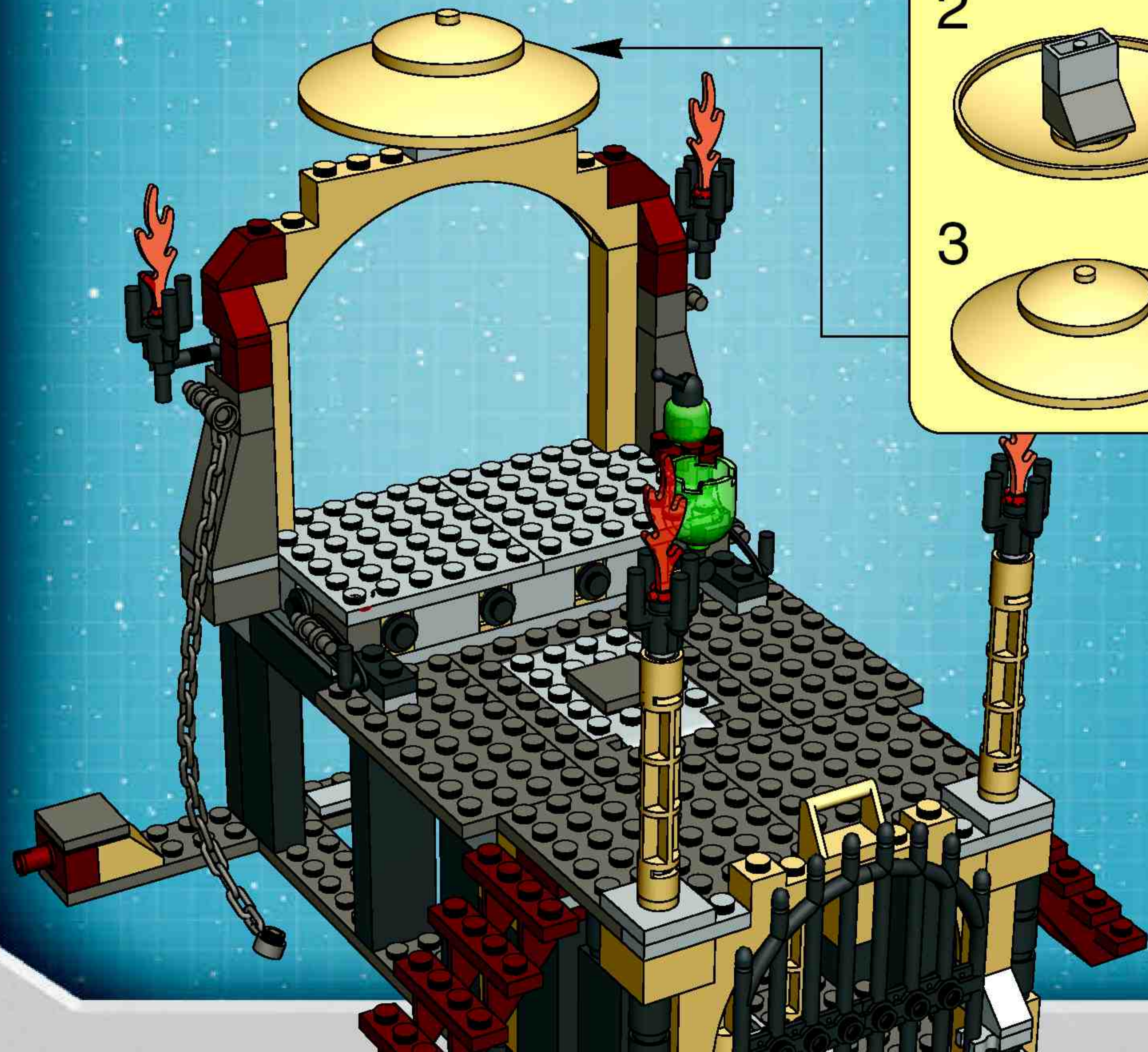

25

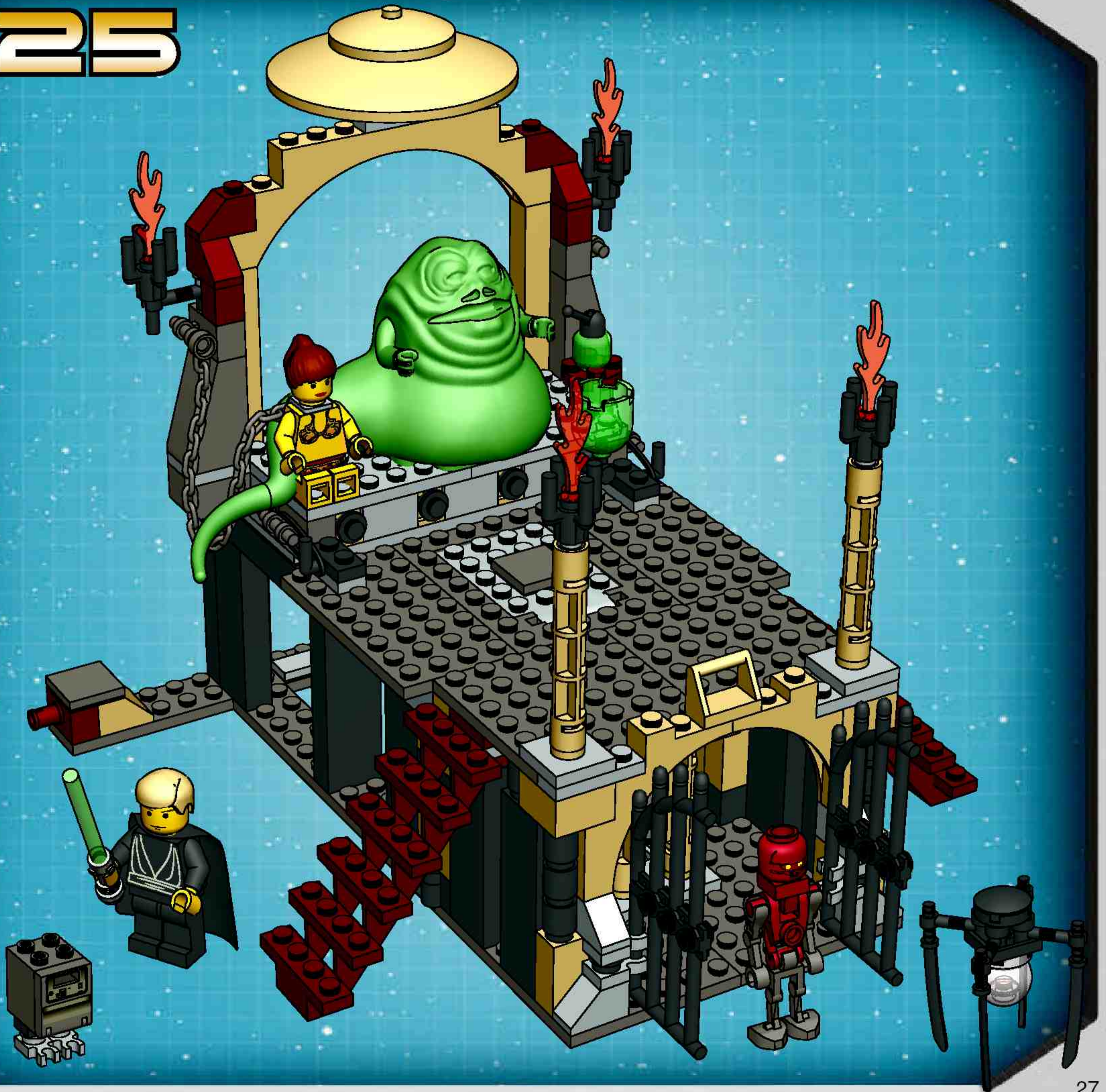

7163

4482



7163



4482



4476



4480

4475





LEGO, the LEGO logo and the minifigure are trademarks of the LEGO Group.
© 2003 The LEGO Group.

© 2003 Lucasfilm Ltd. & TM. All rights reserved. Used under authorization.