

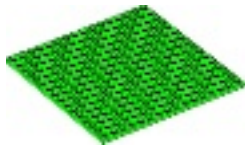

CITY

4440





+



2x

1

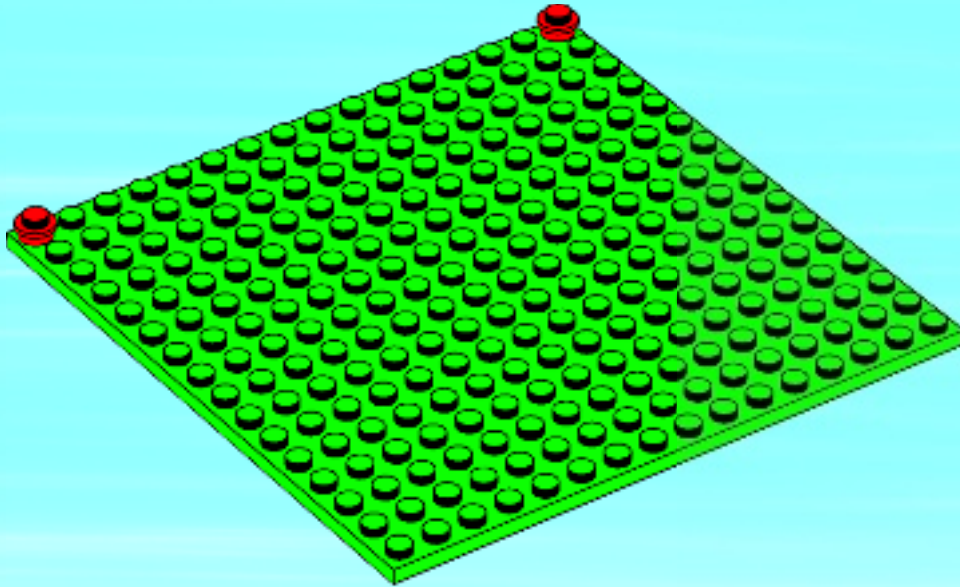

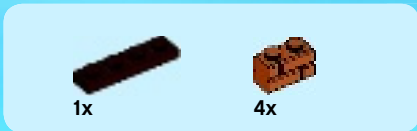

2

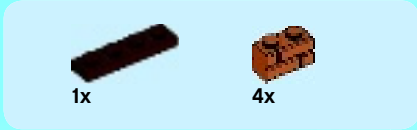
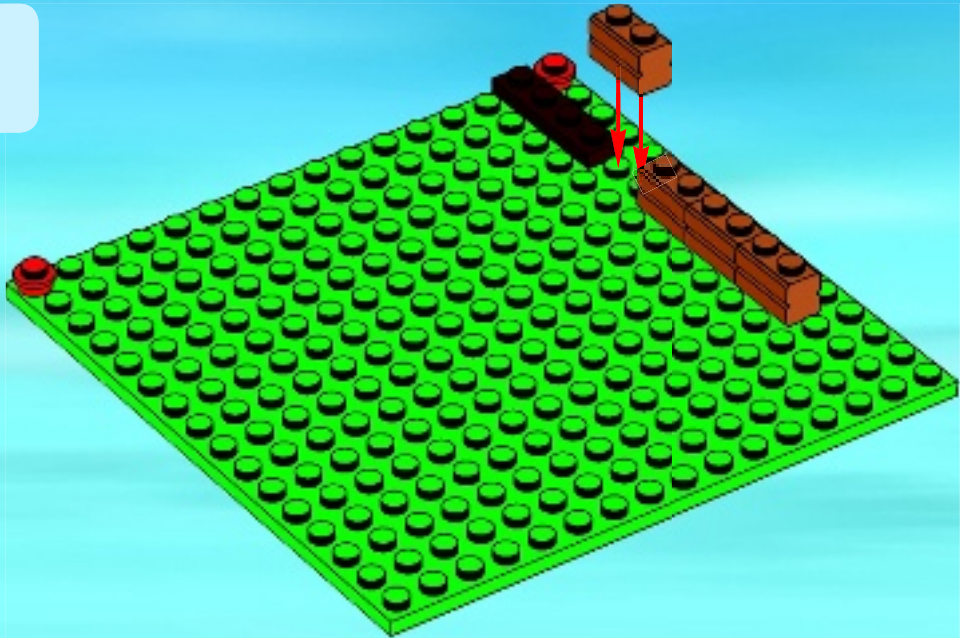

3

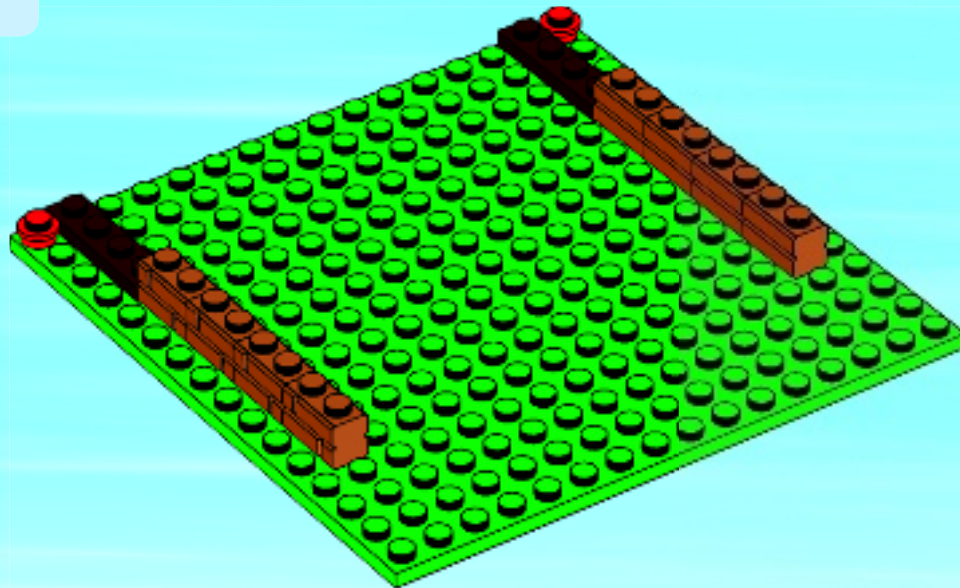



2x



2x

4

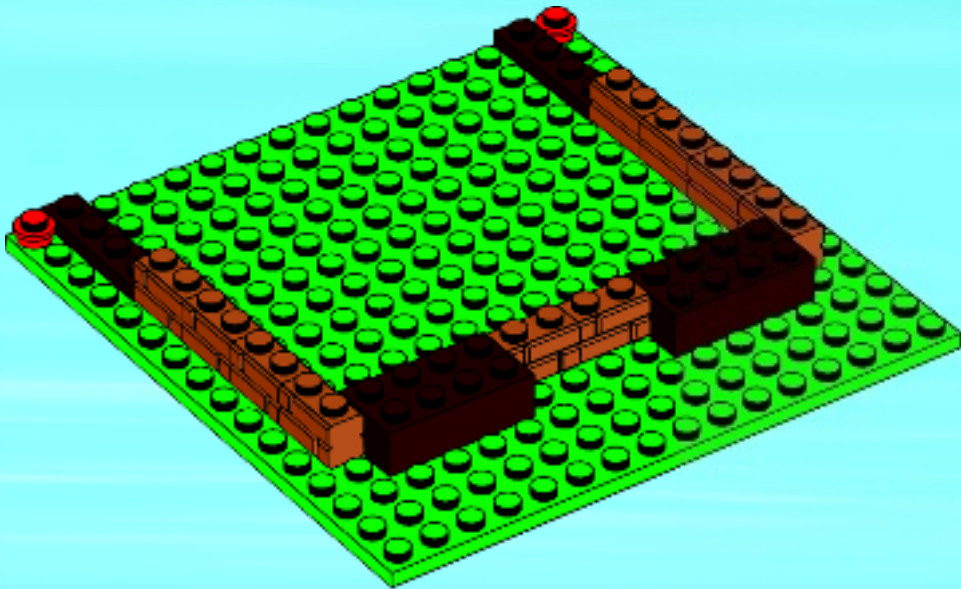



1x



1x

5

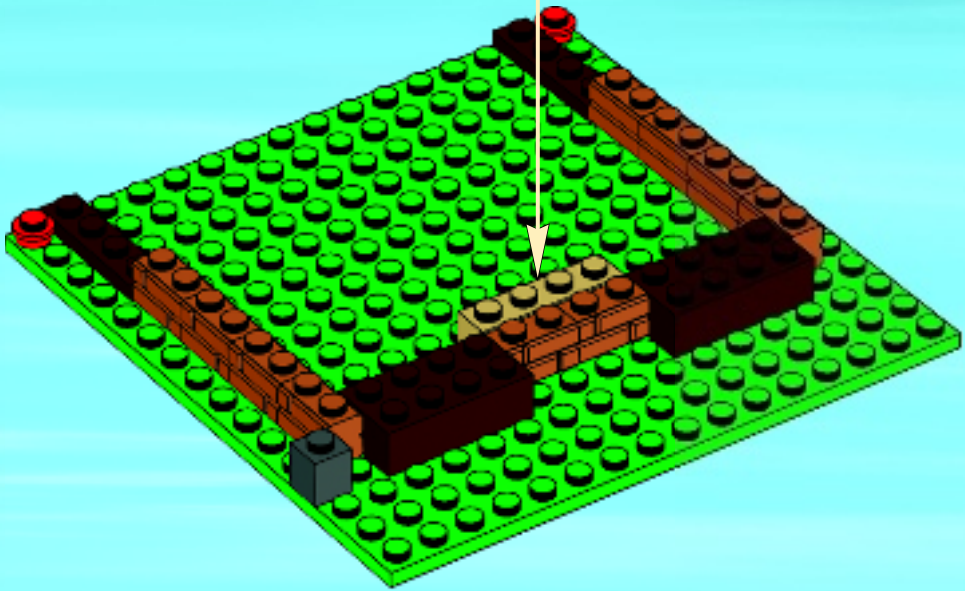
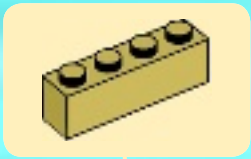



3x

2x



3x



2x

6

1

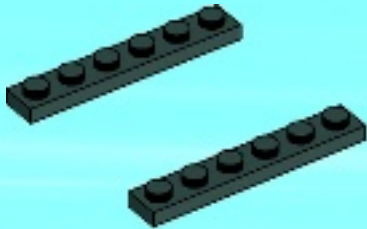

2

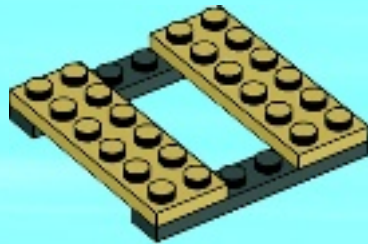

3

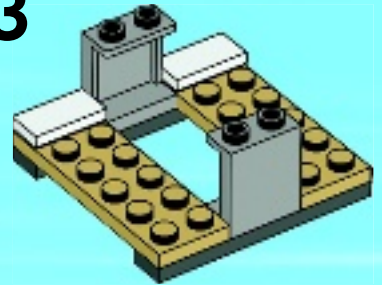

4

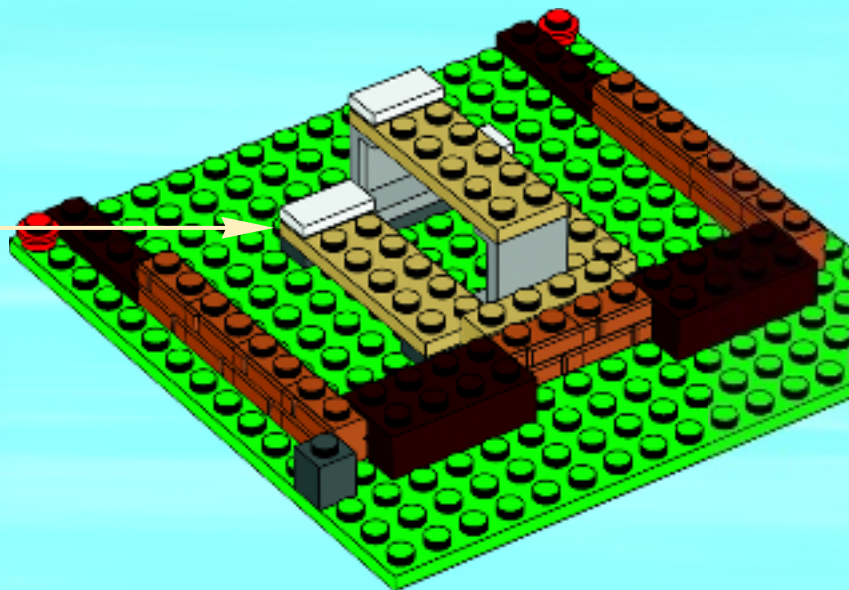
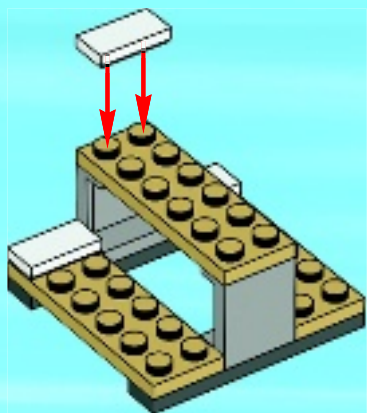



2x



2x

7

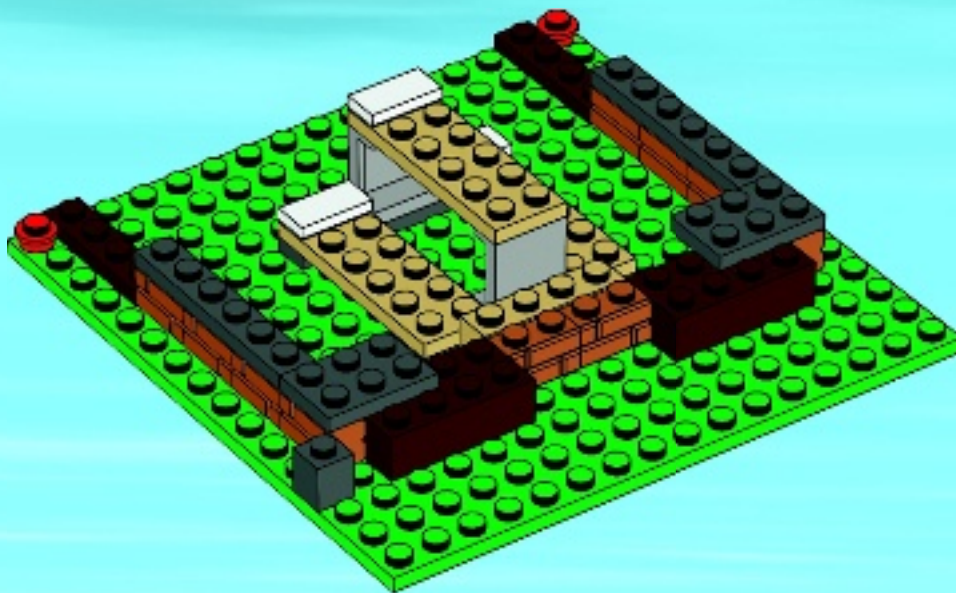



1x

8

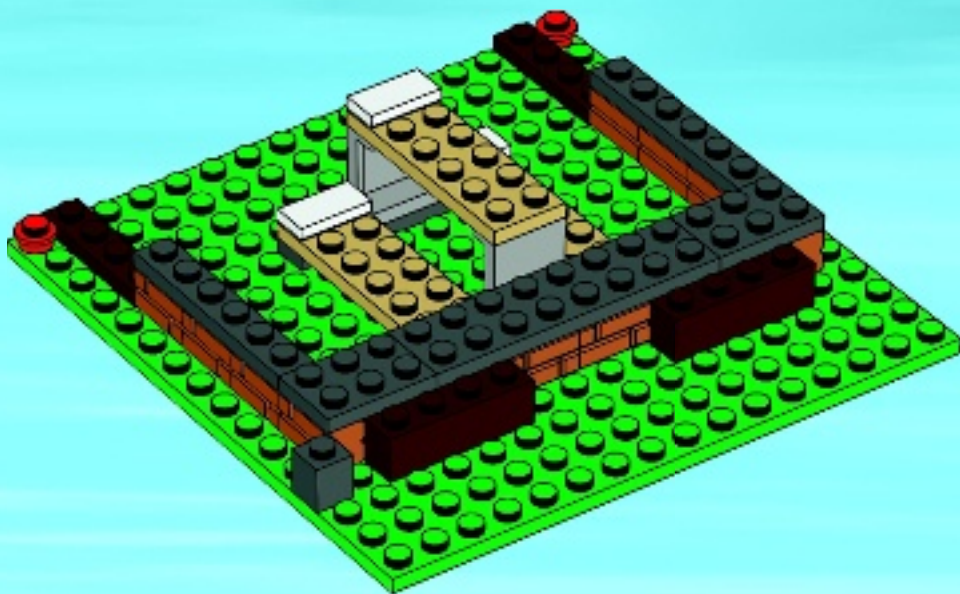

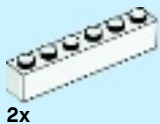

2x



2x

9

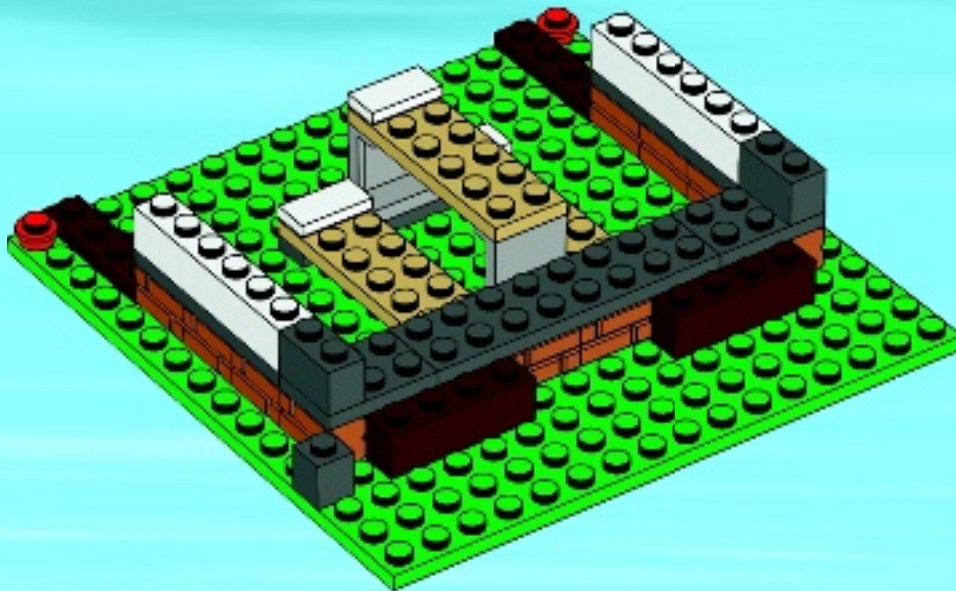

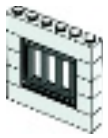

2x



2x



2x



12x



4x

10

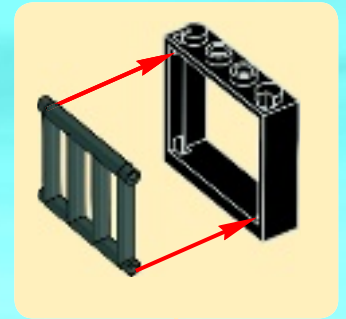
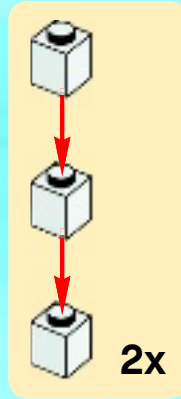

1

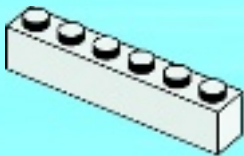

2

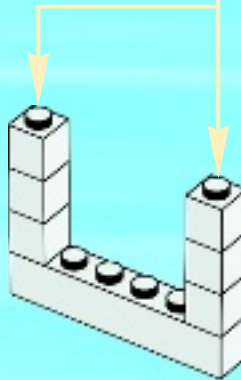

3

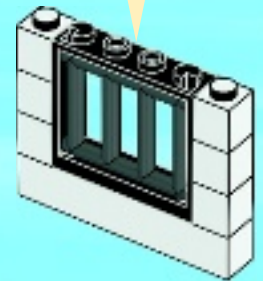

4

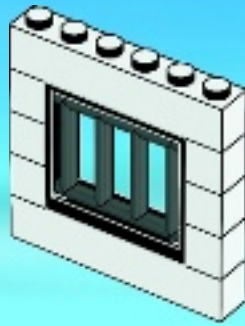

2x

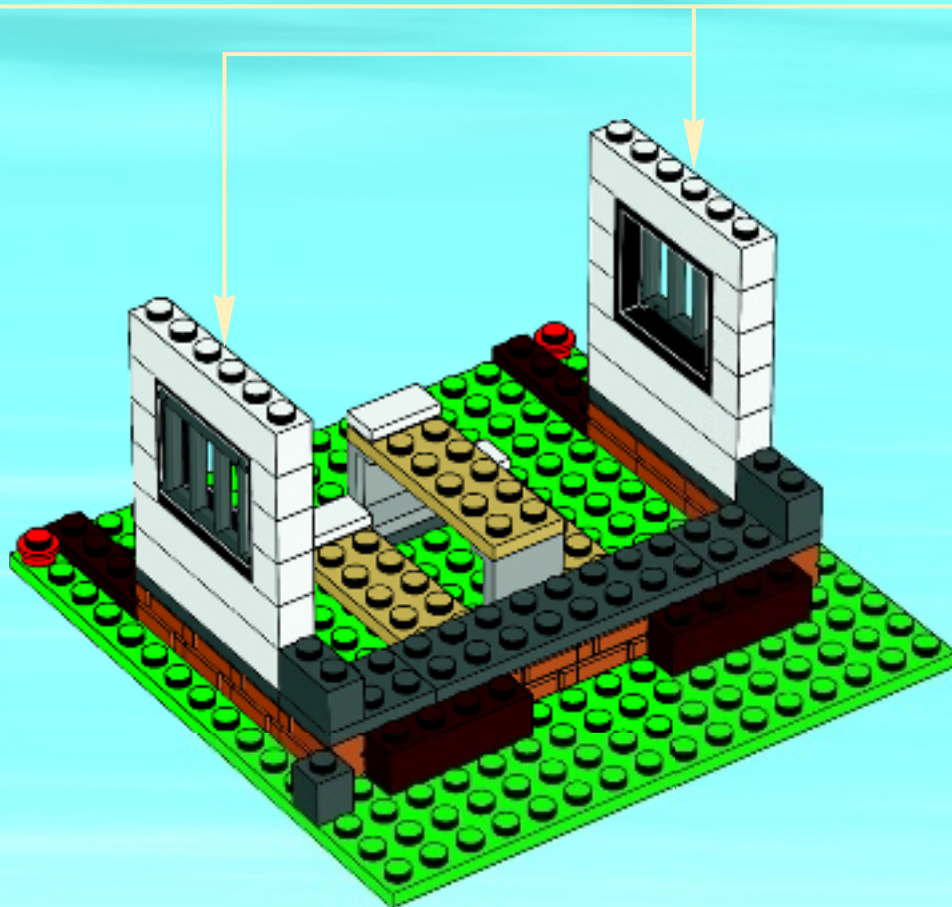



2x

11

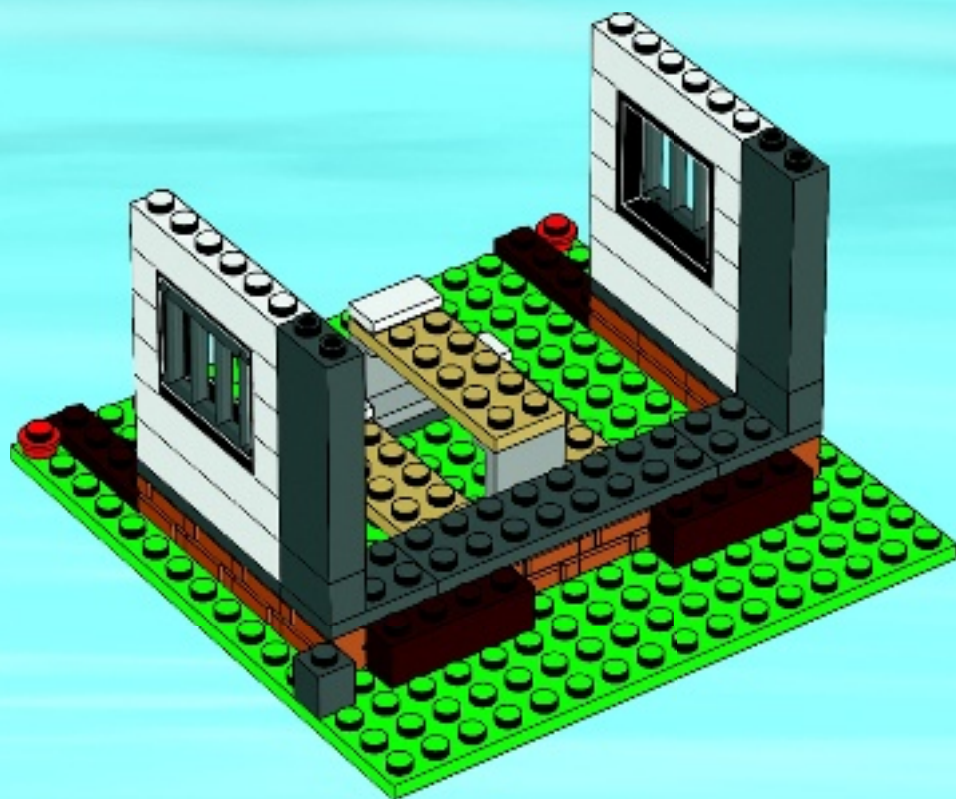

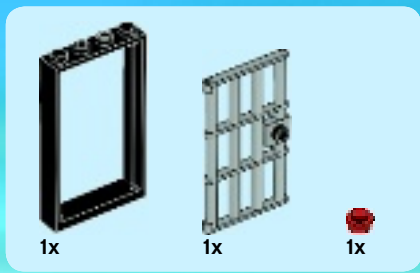

12

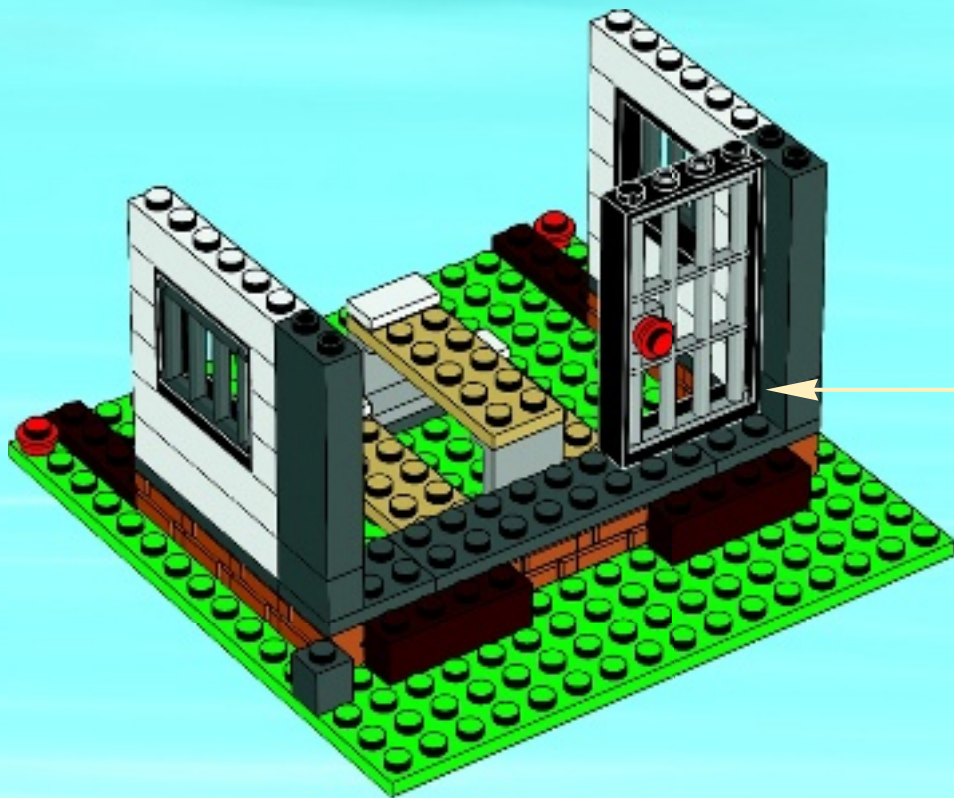
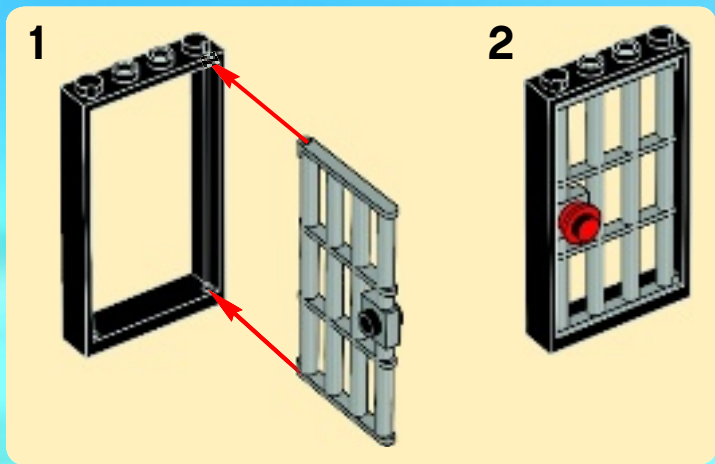

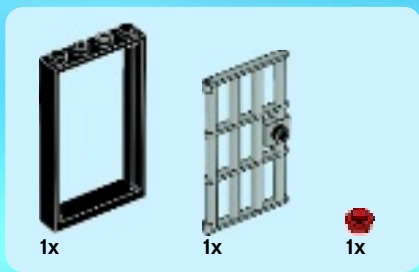

13

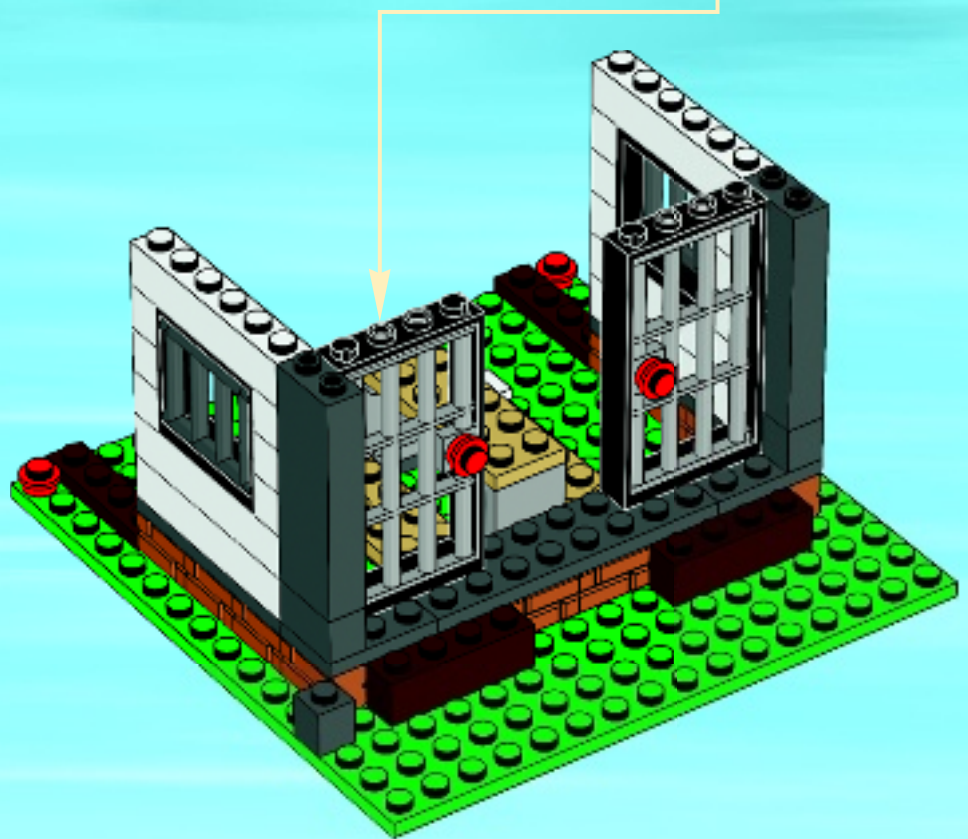
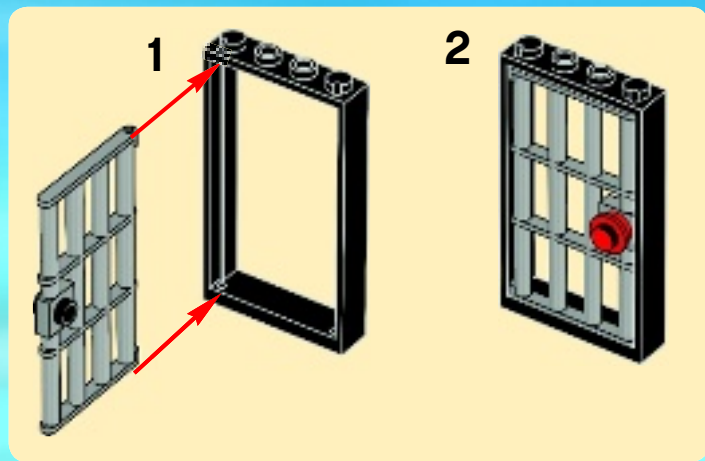

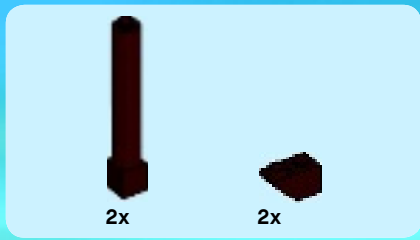

14

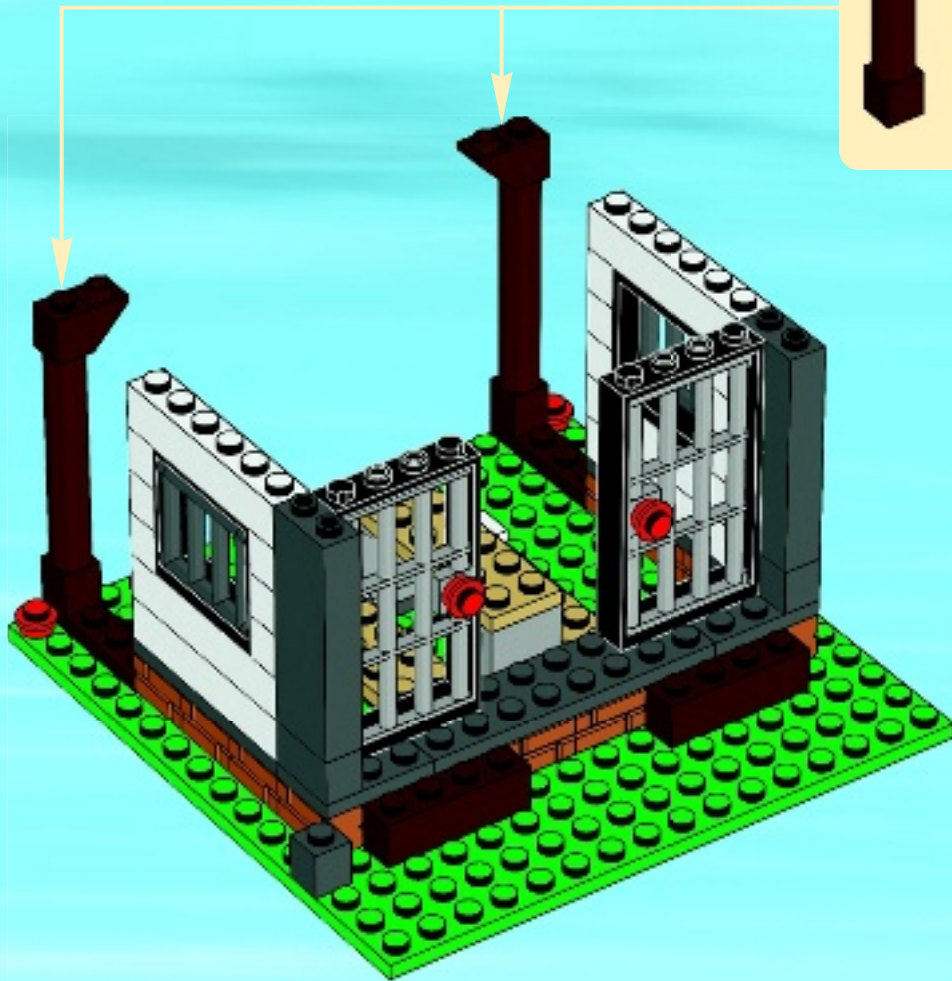
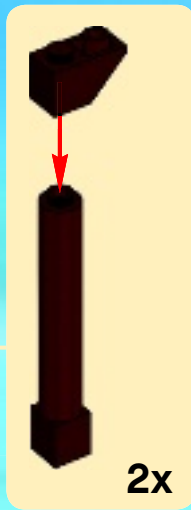

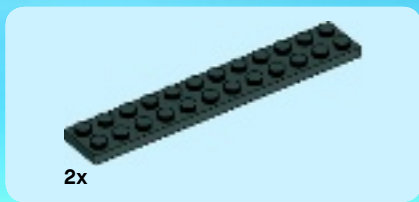

15

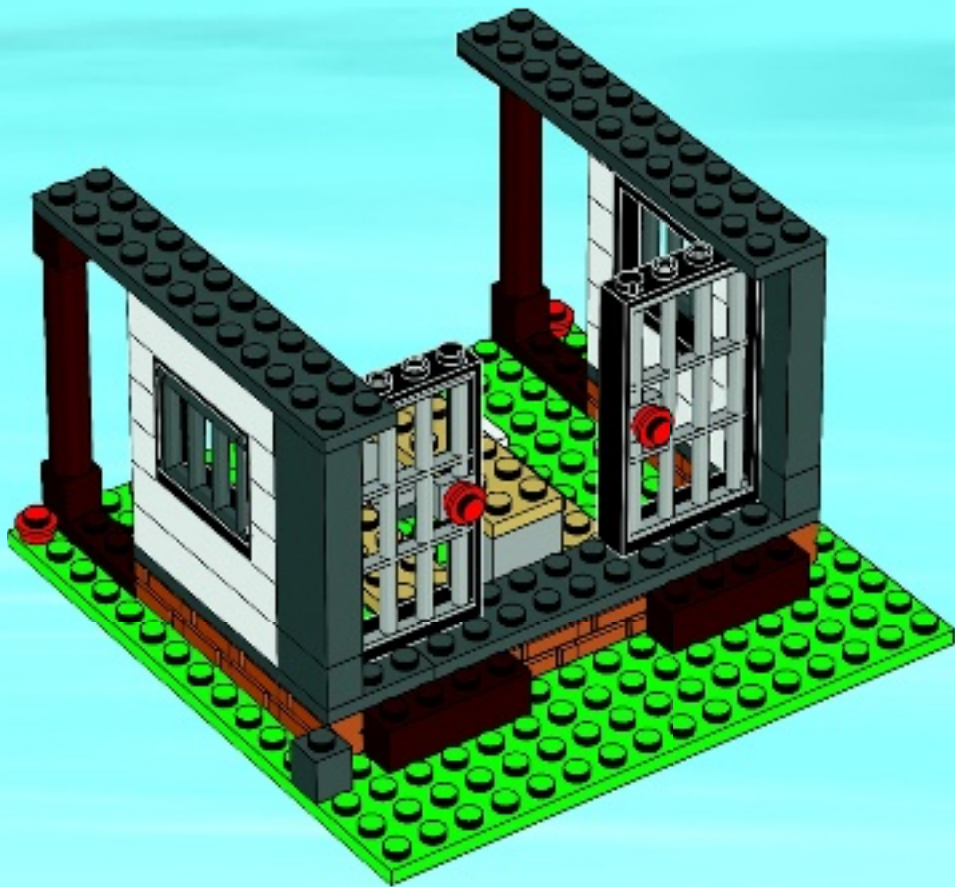

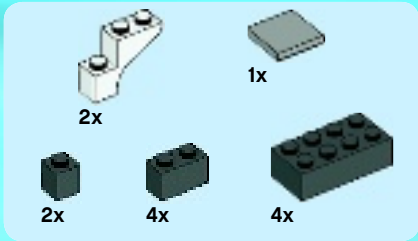

16

1

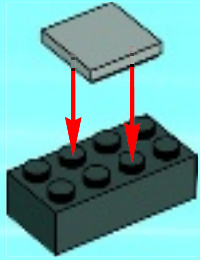

2

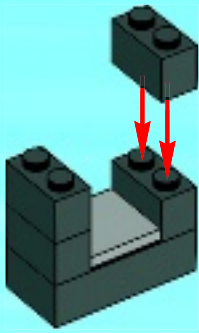

3

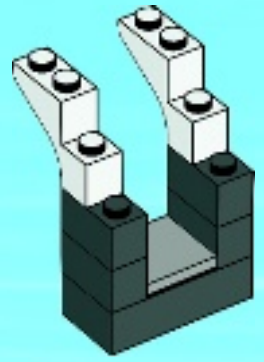

4

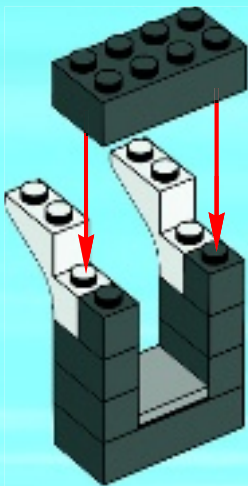

5

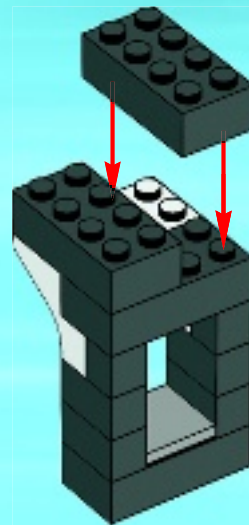

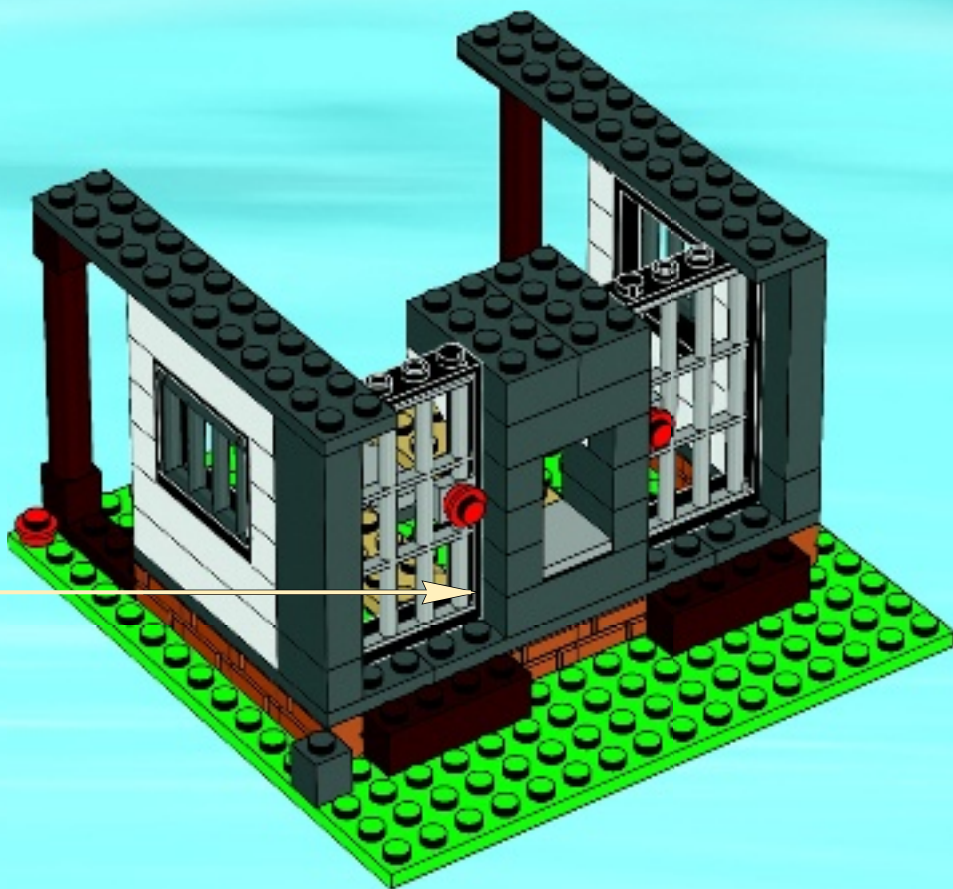



1x

17

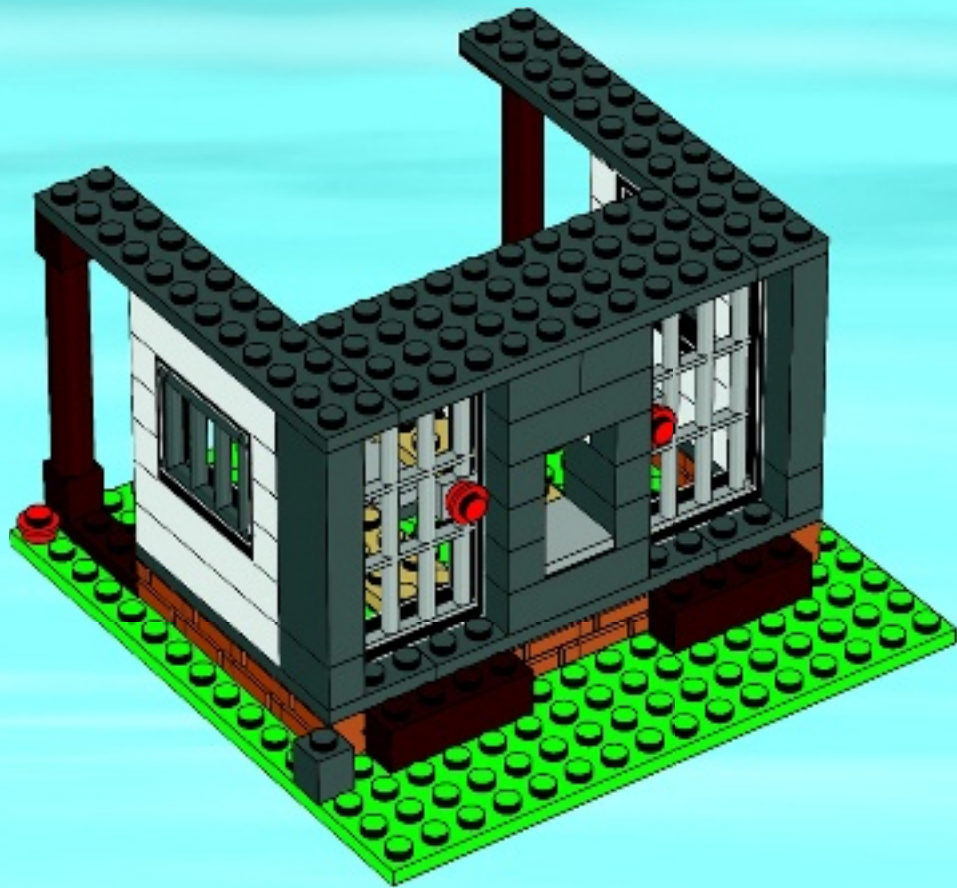

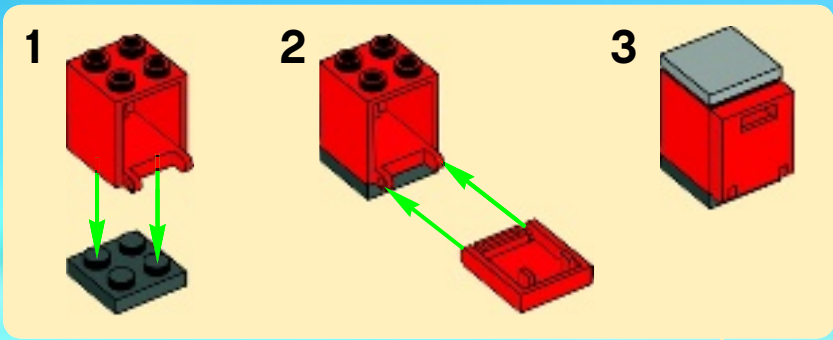
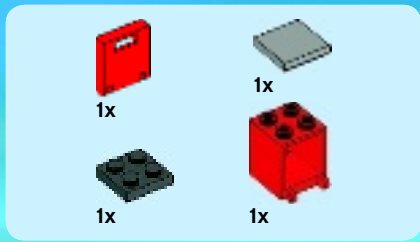

18

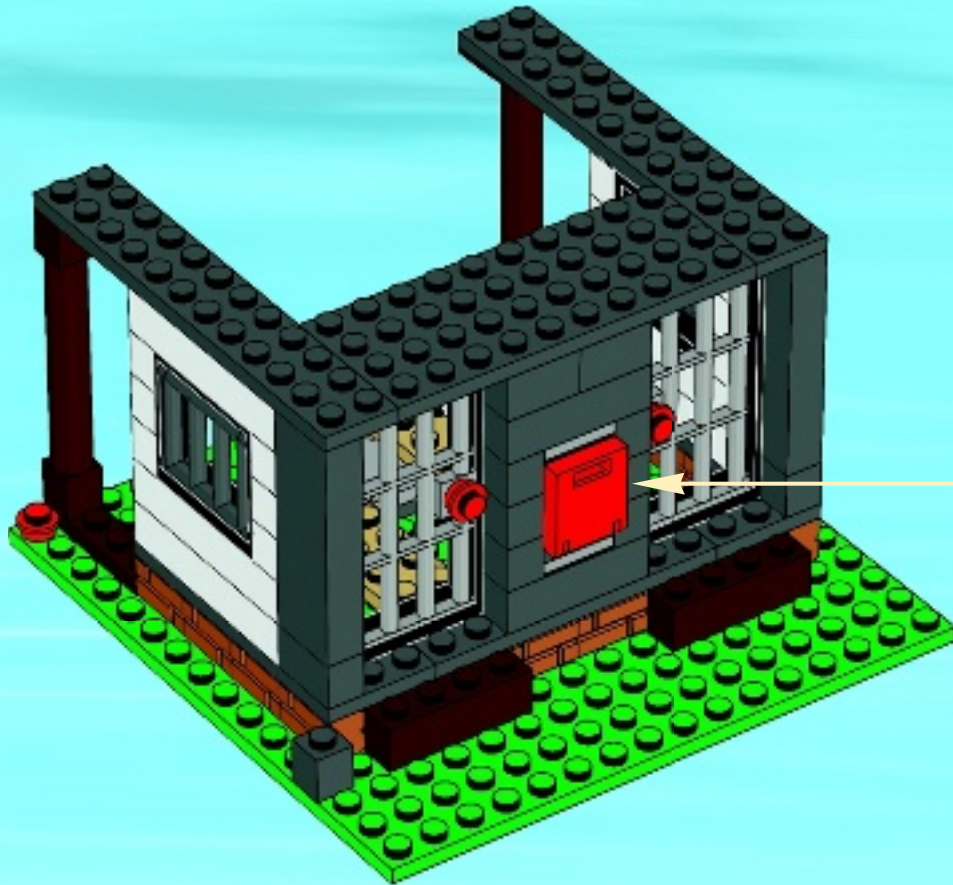

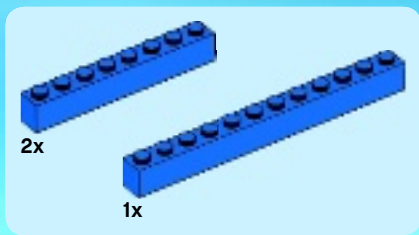

19

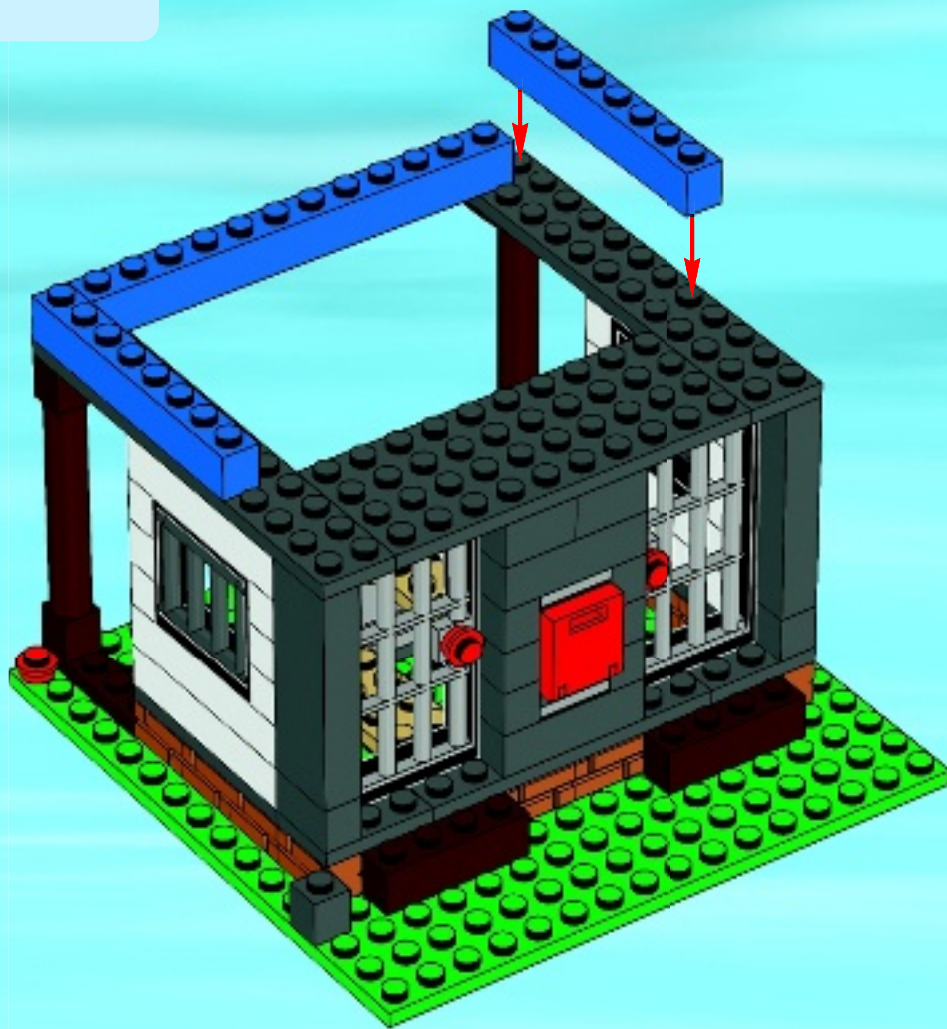



1x



2x

20

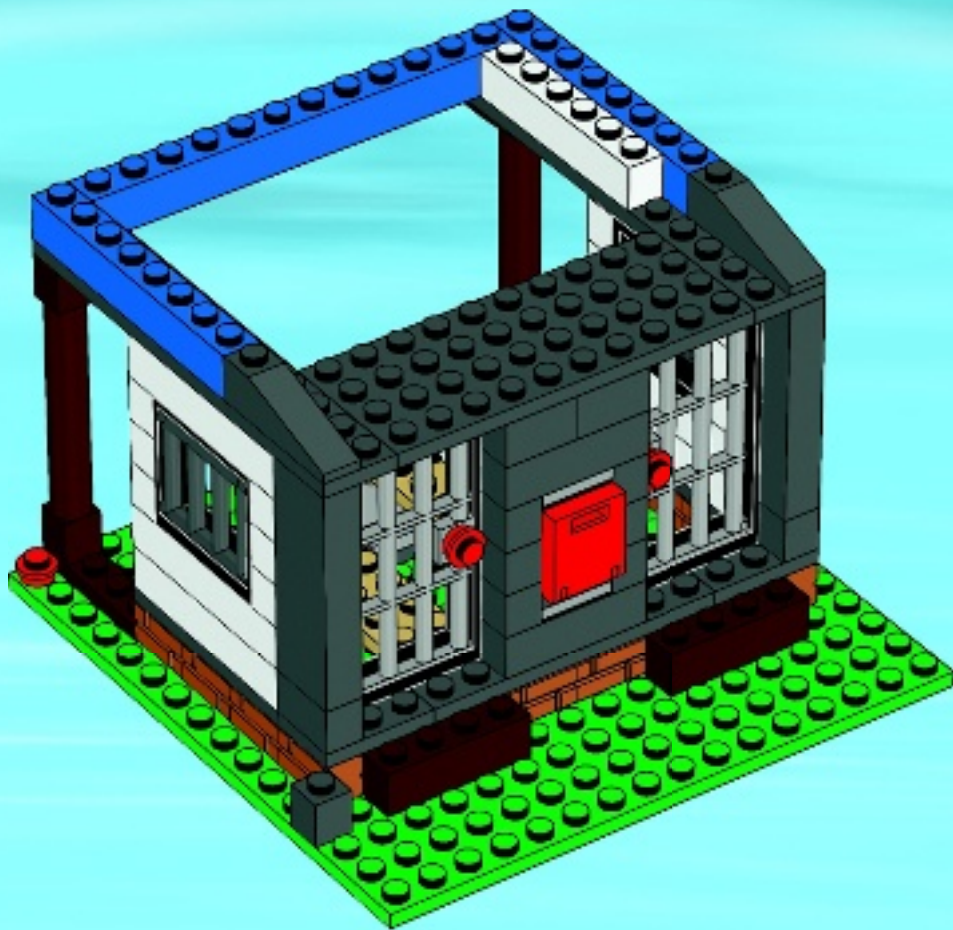

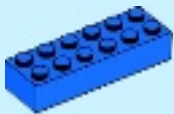

1x



1x

21

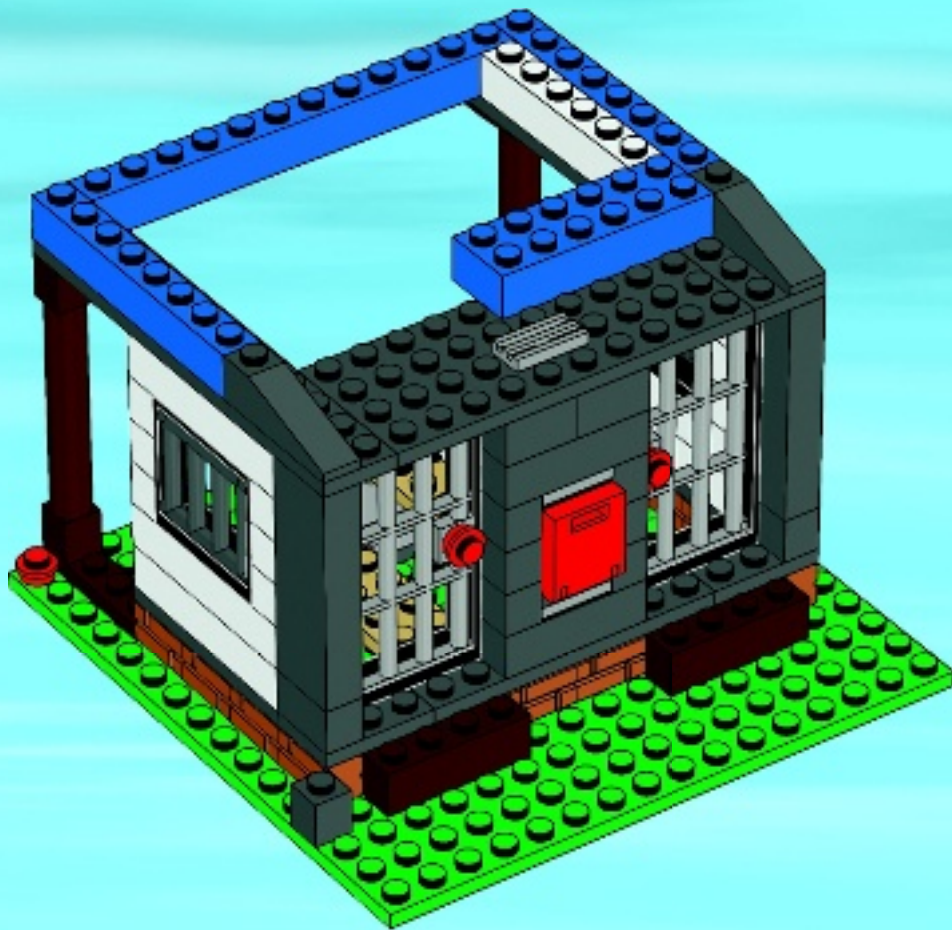

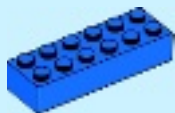

1x

22

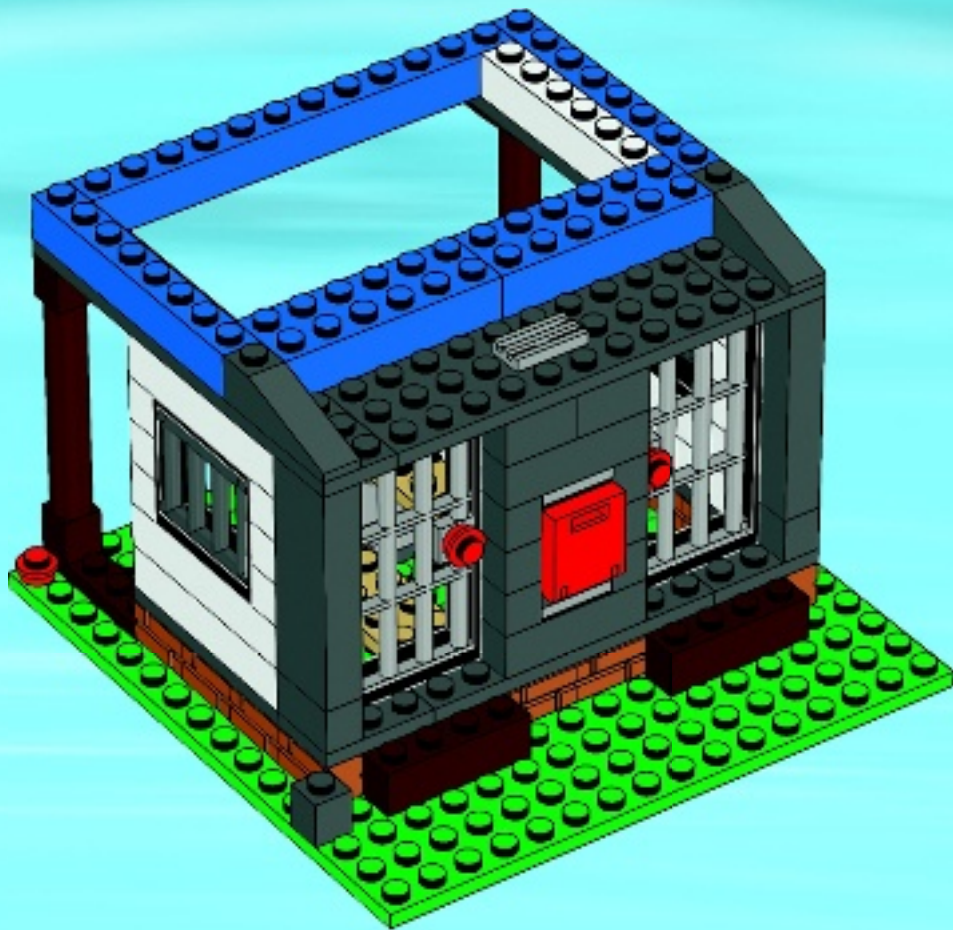



1x



1x

23

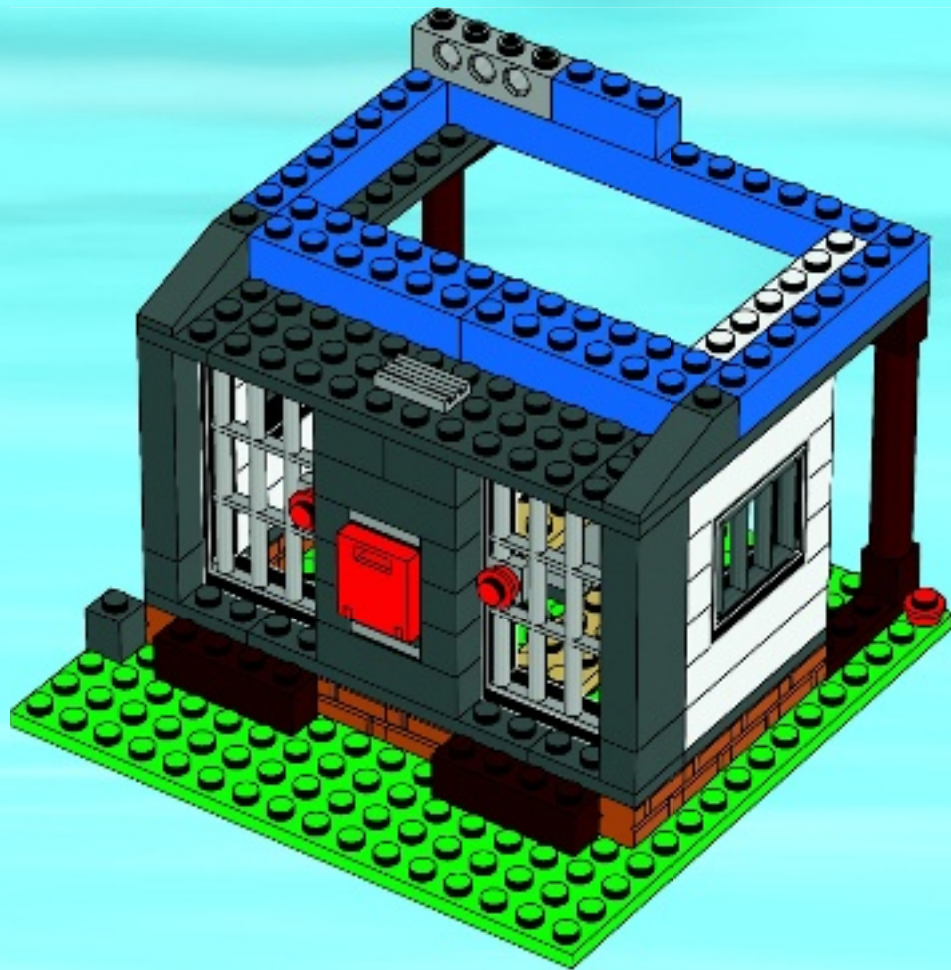



1x



1x

24

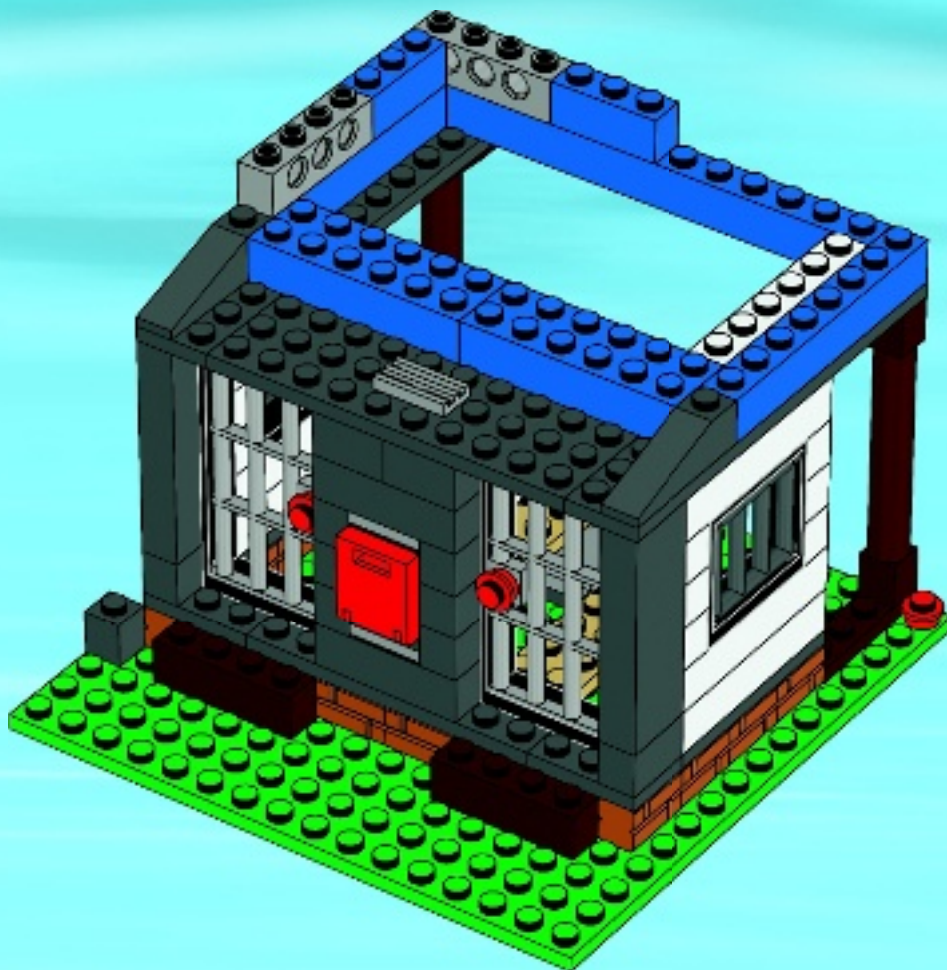



2x

25

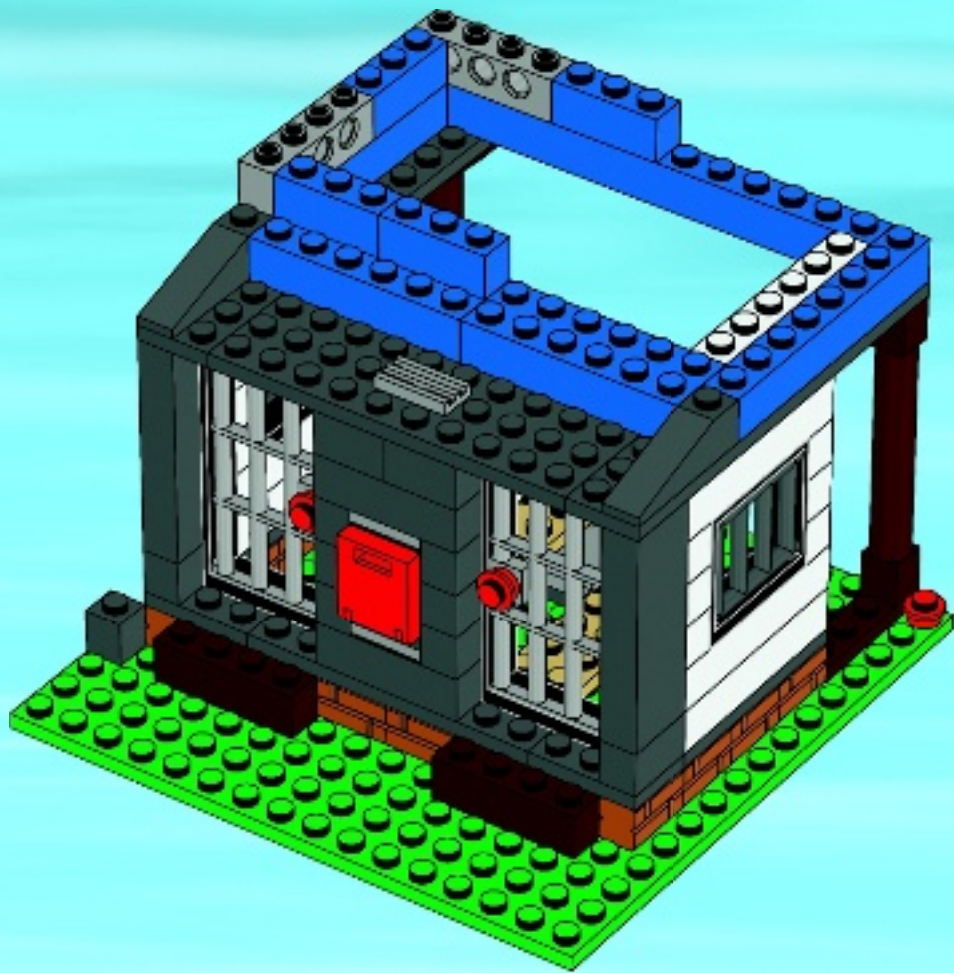

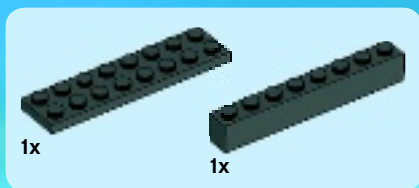

26

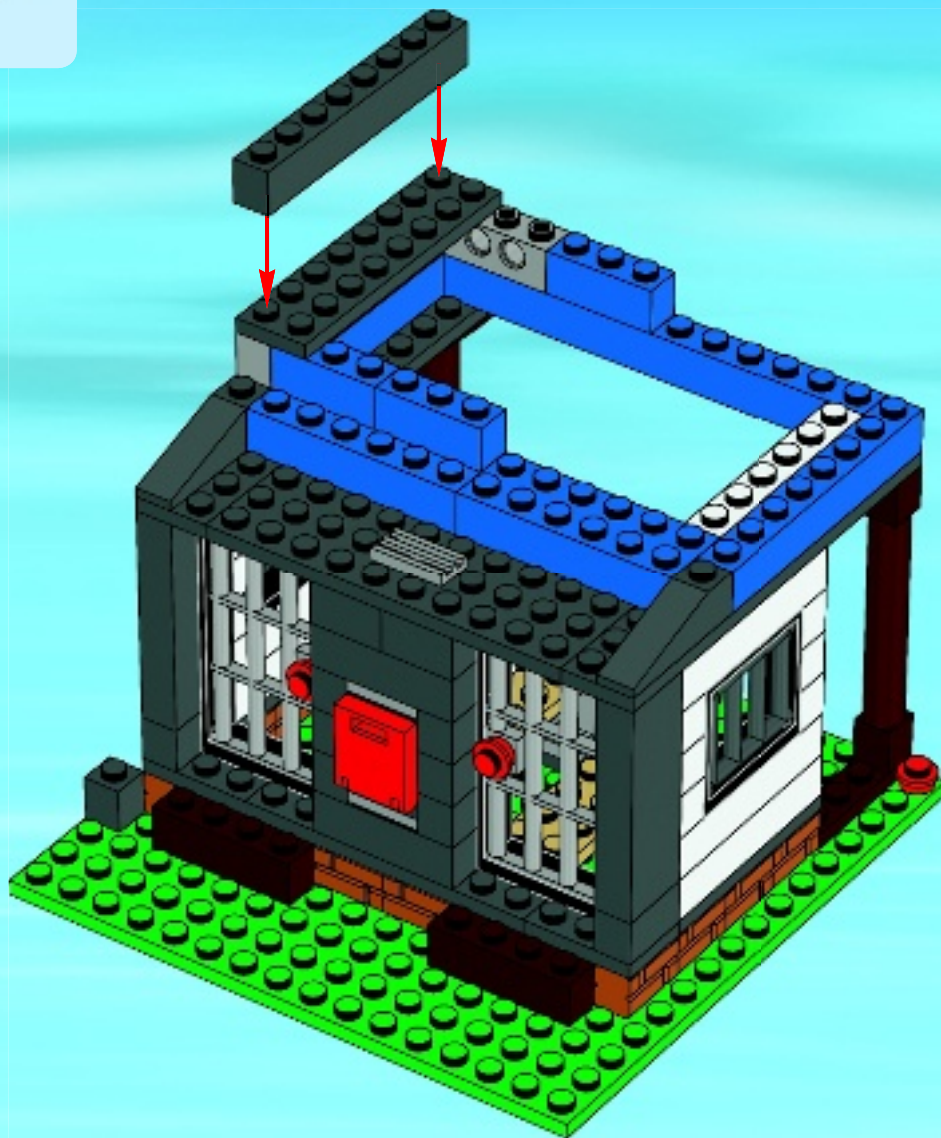



4x

27

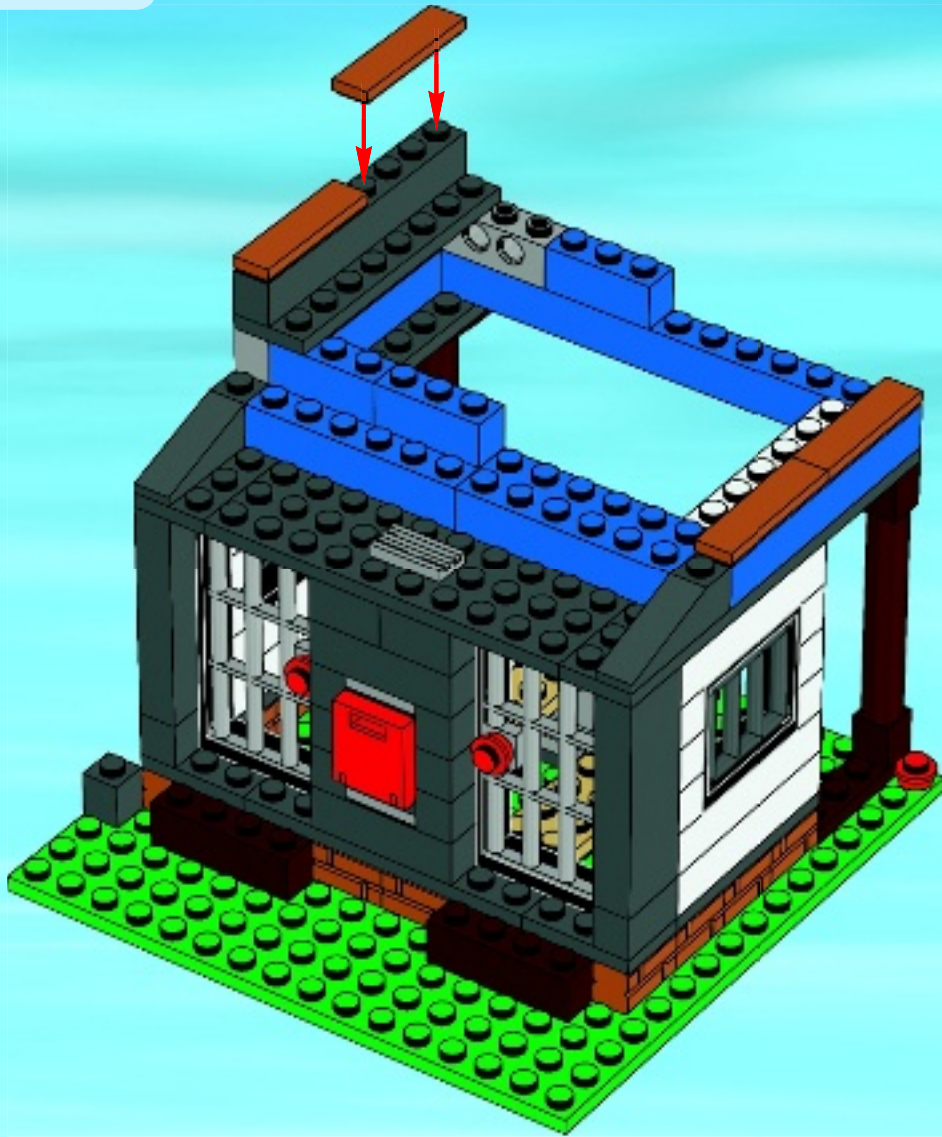

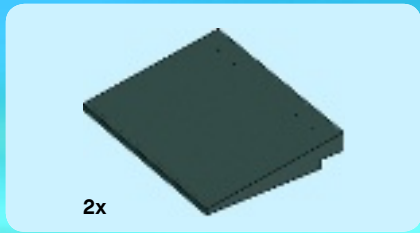

28

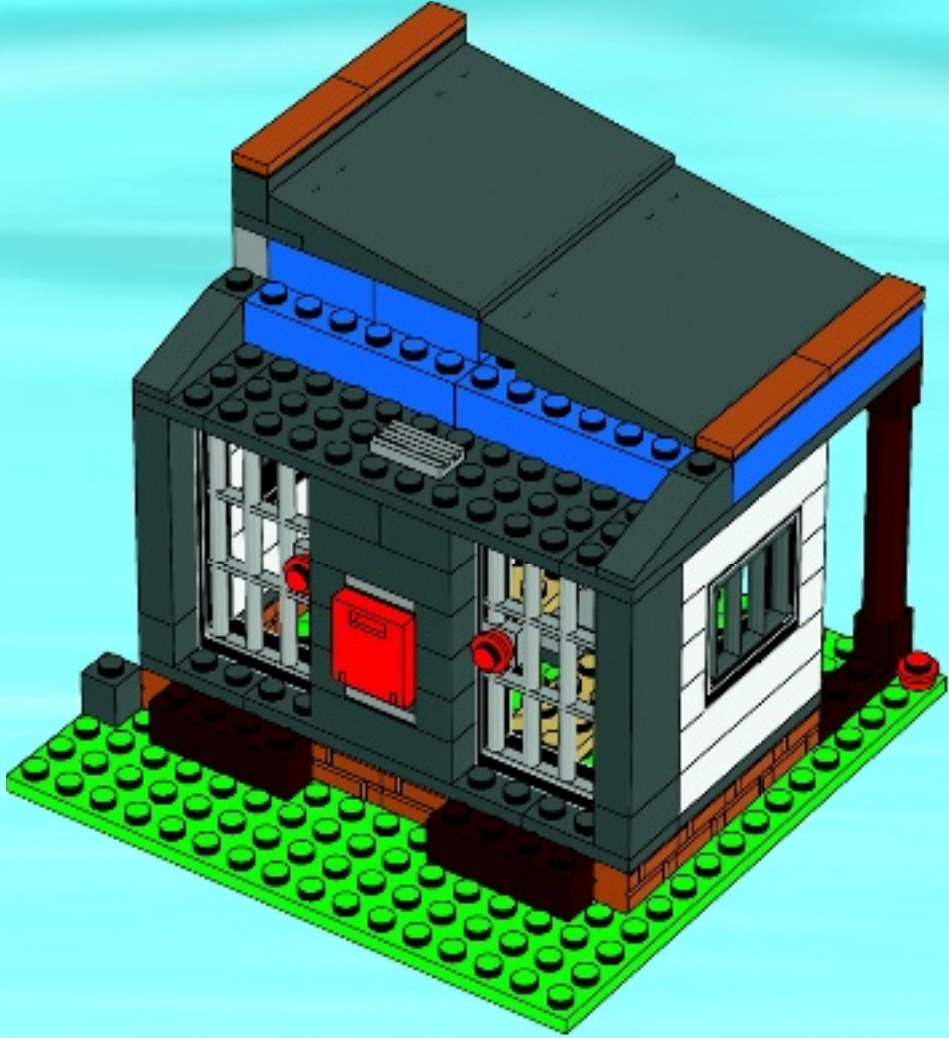



2x



3x

29





3x



3x

30

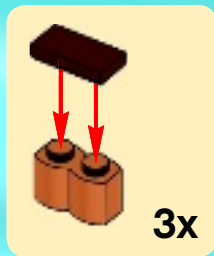



31

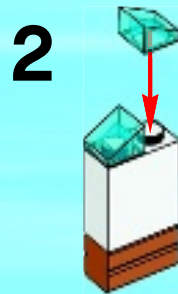
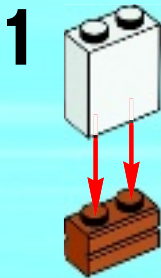

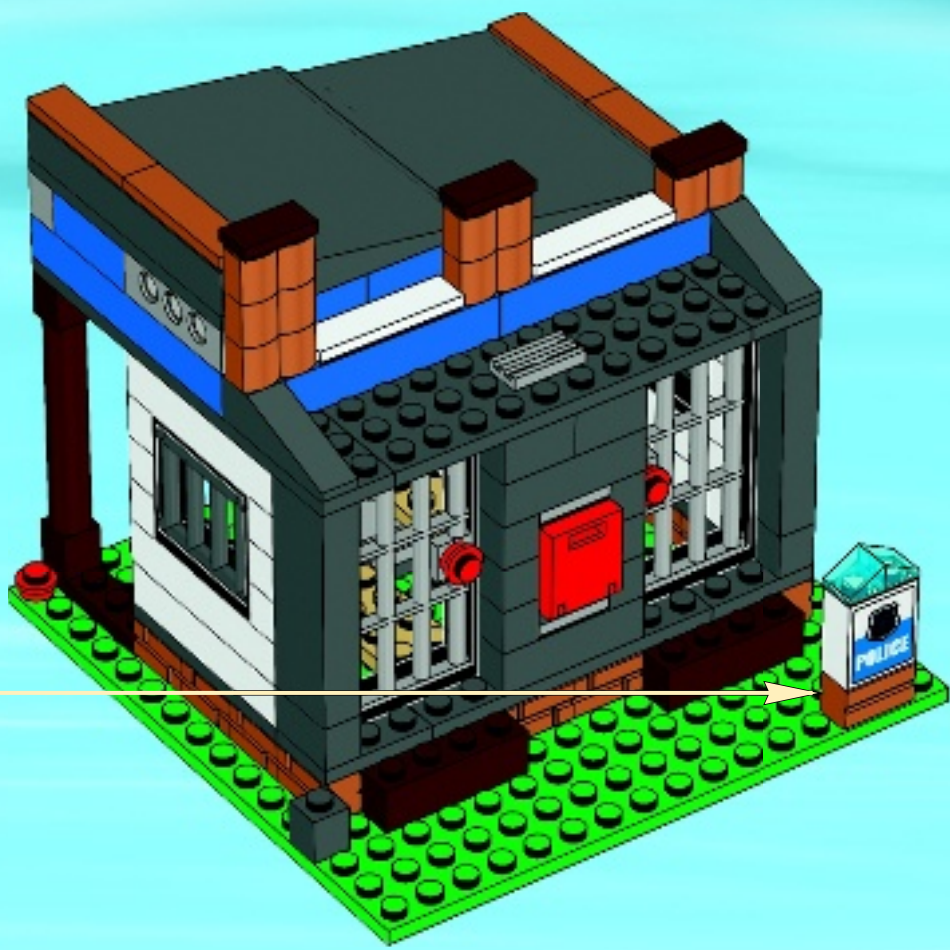



1x



1x



1x

32

1



2

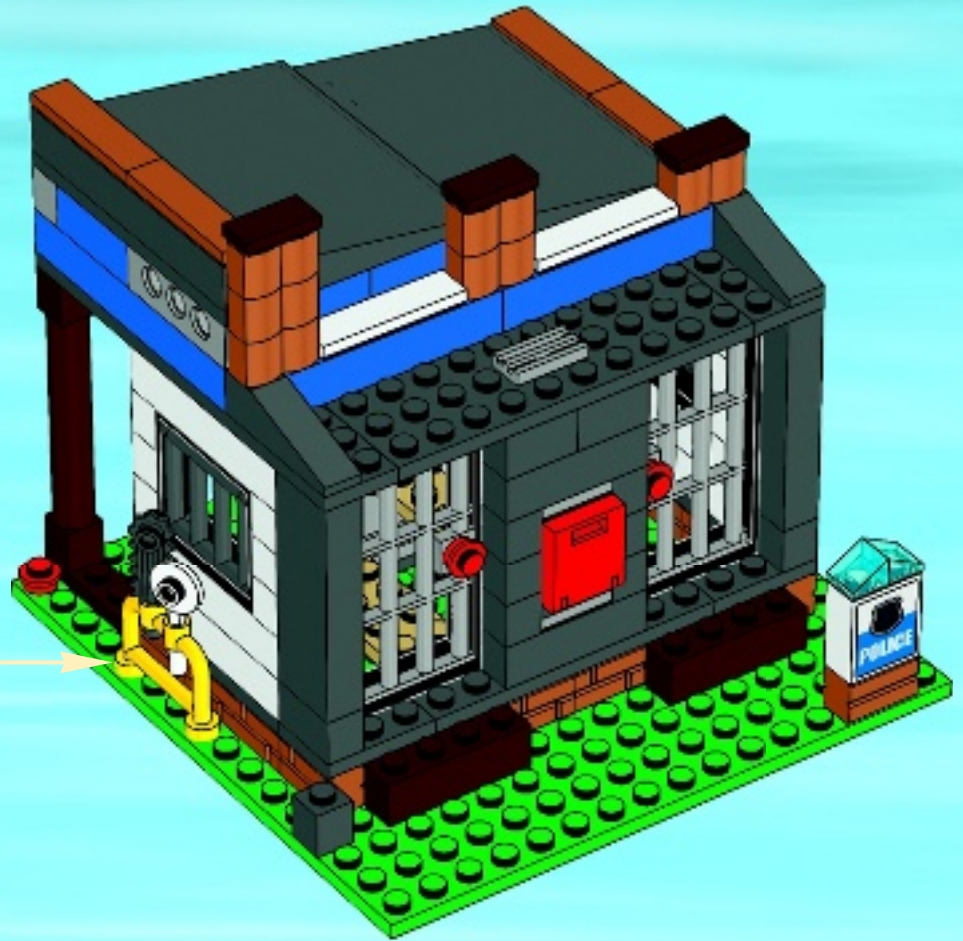

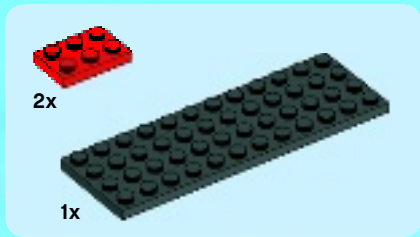
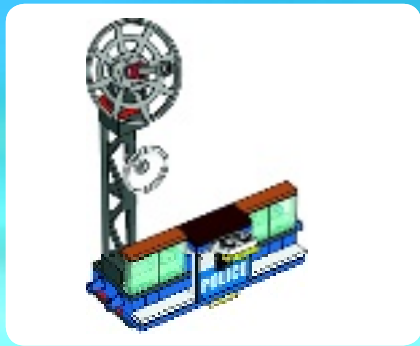

1

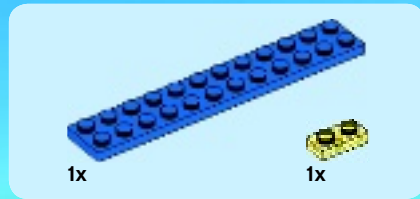
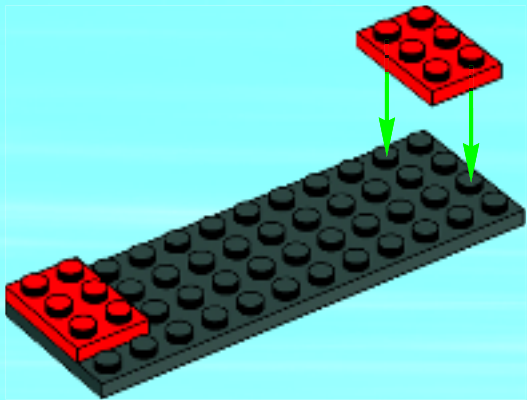

2

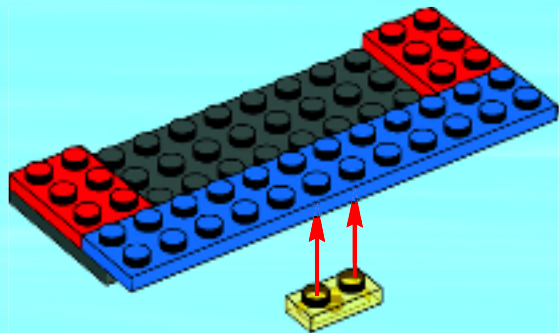



4x

3

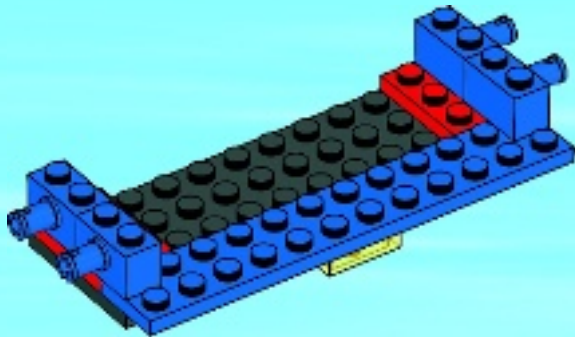

2x

4

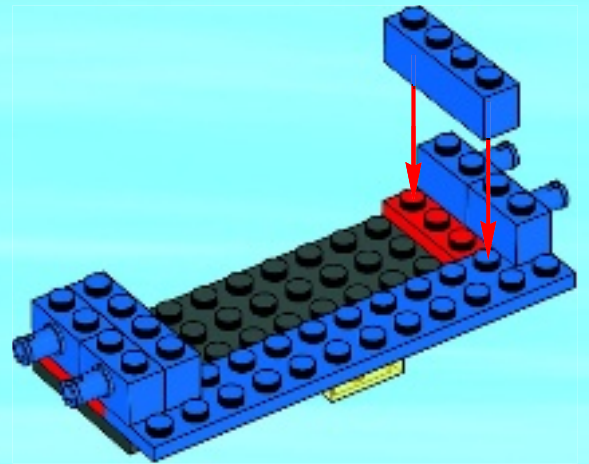



2x

5

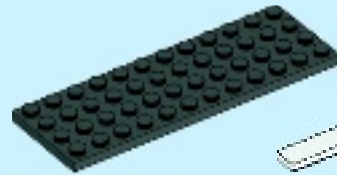
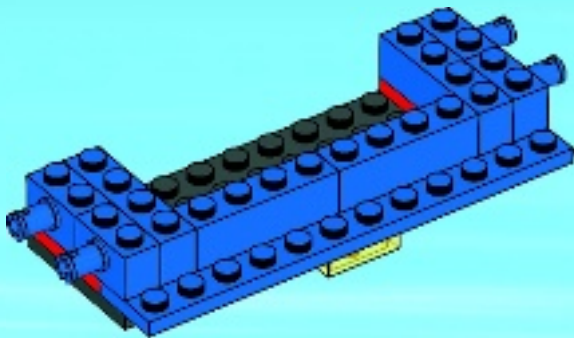

1x

2x

6

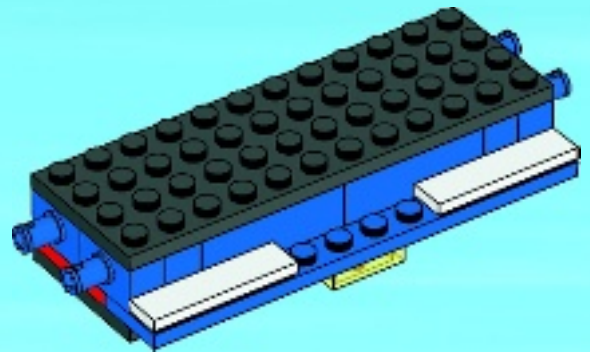



4x



1x

7

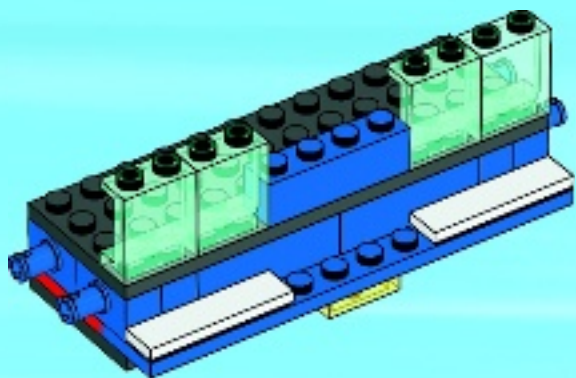

2x



1x

8

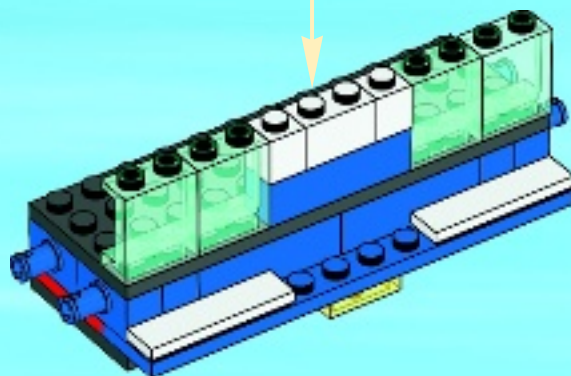

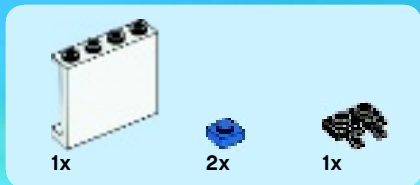

9

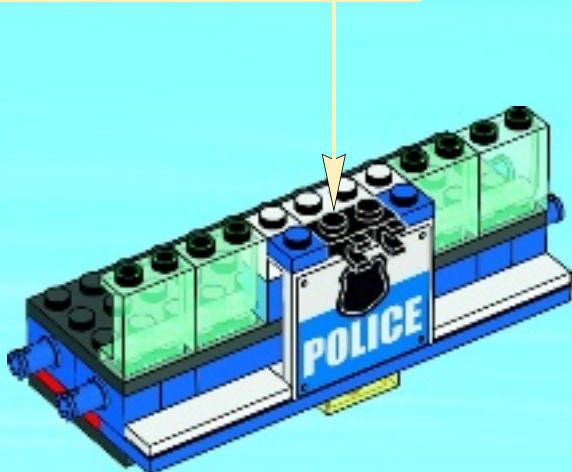
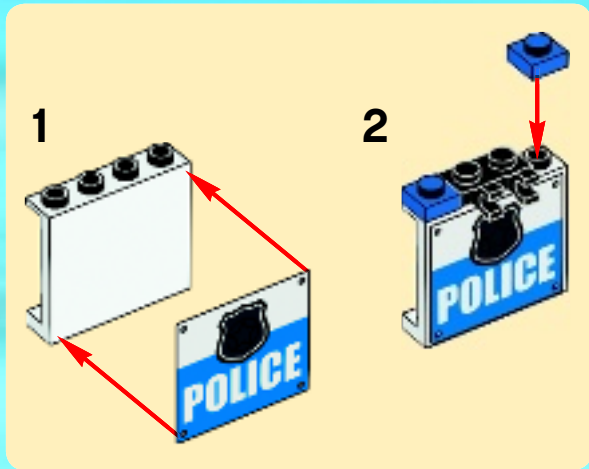



1x



2x

10



1x



1x

11

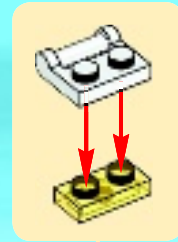

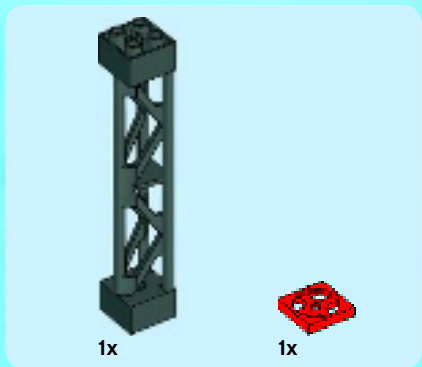

1





1x

2



1x

3

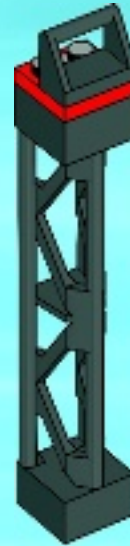

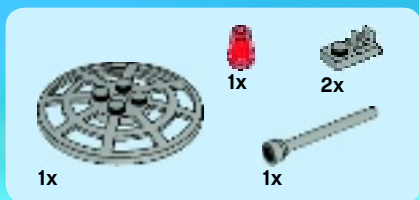

4

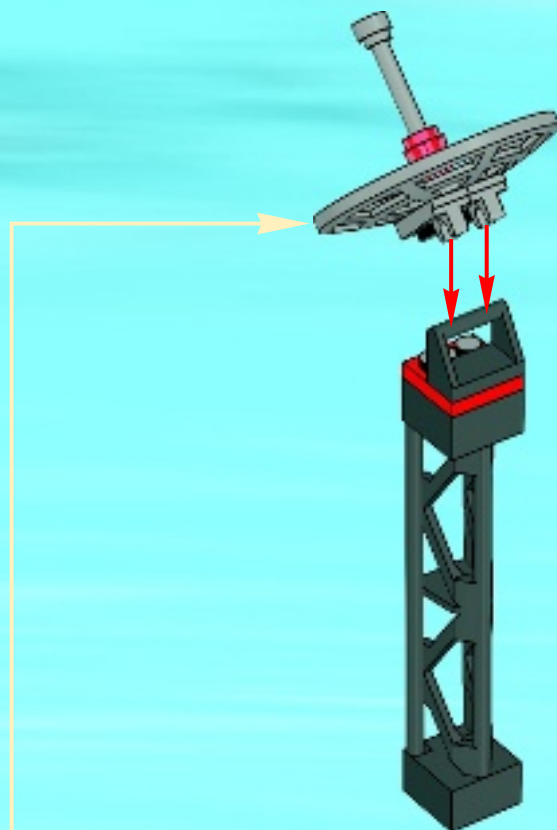
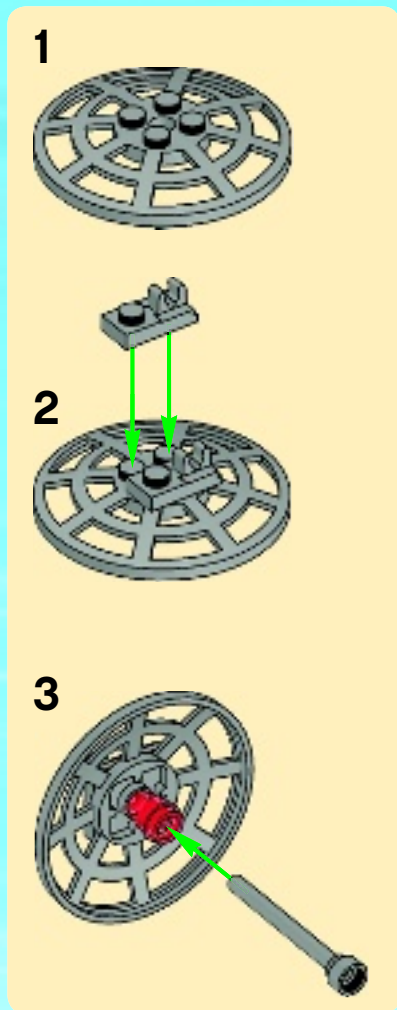



1x



1x

5

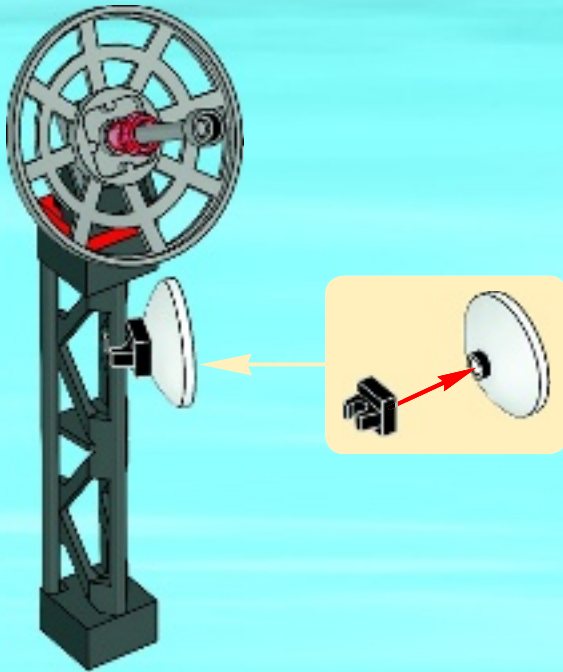

12

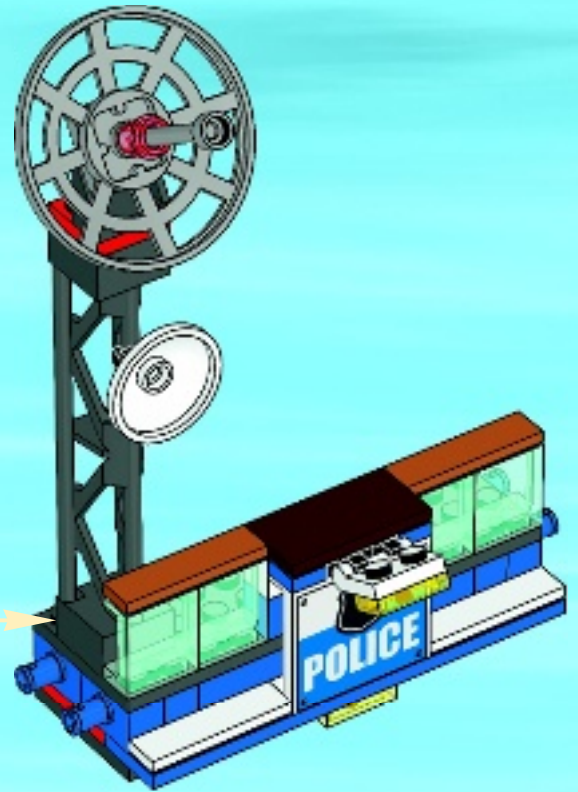

13

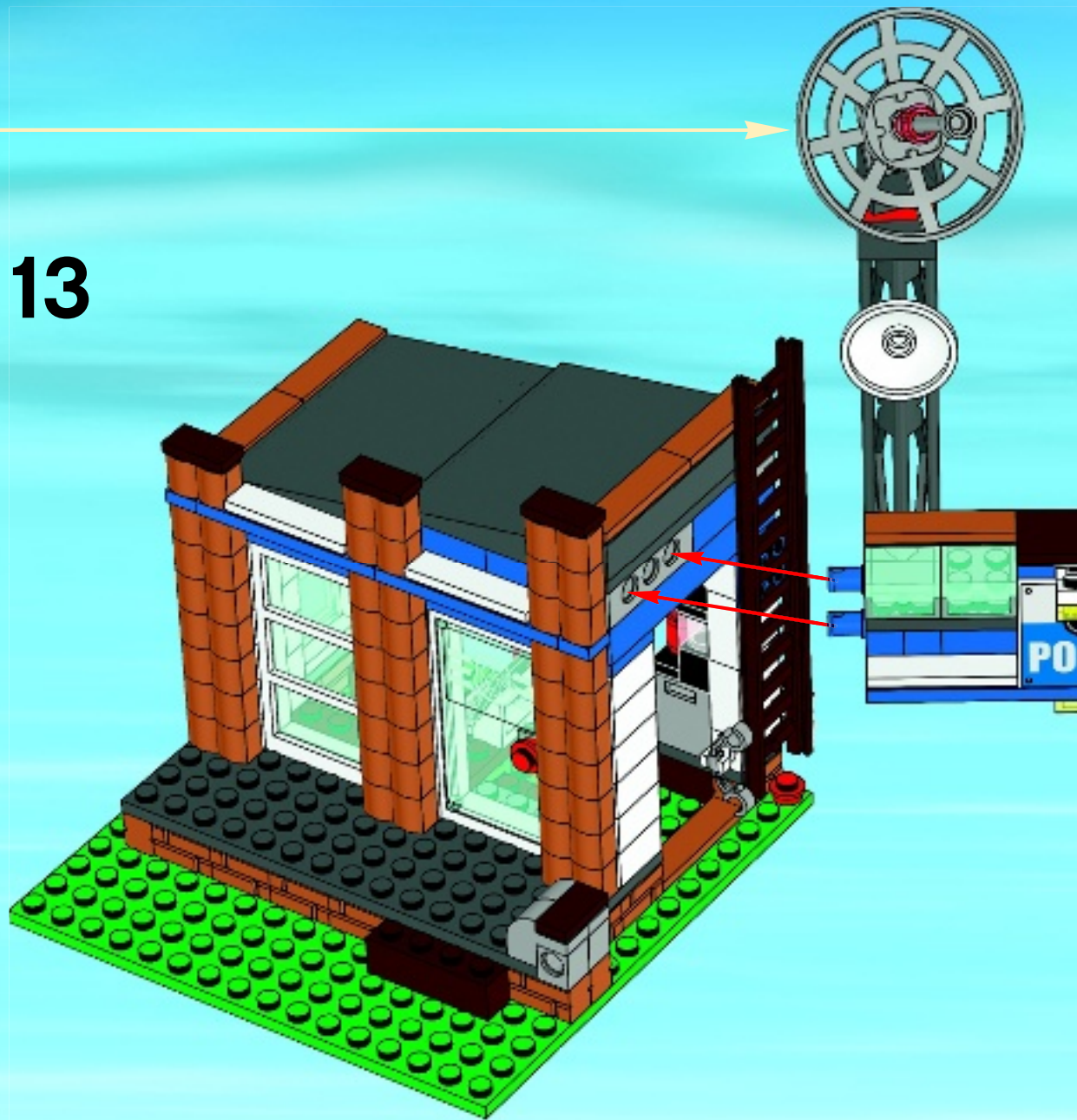

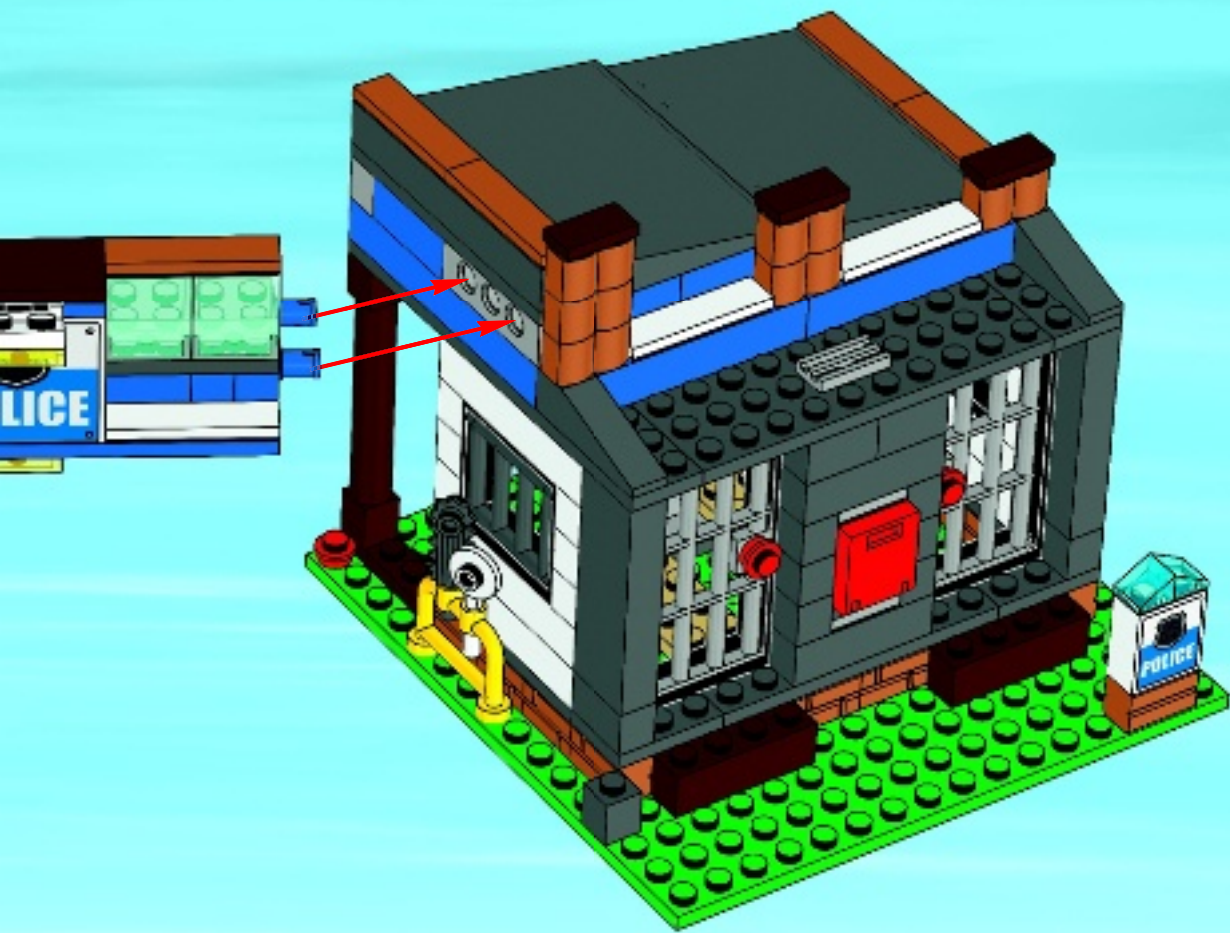

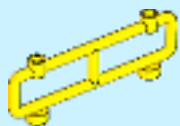

1x

14



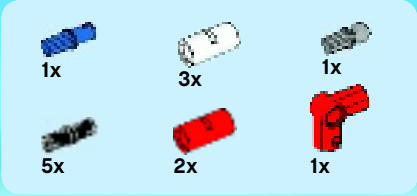
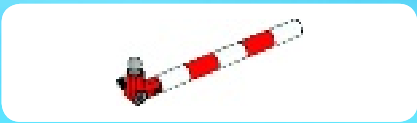

15

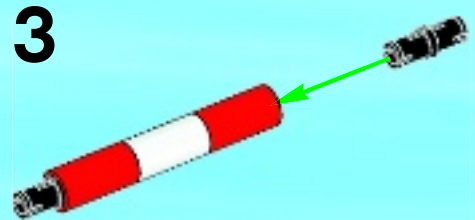
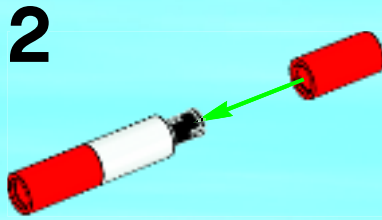
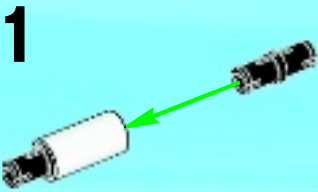

4

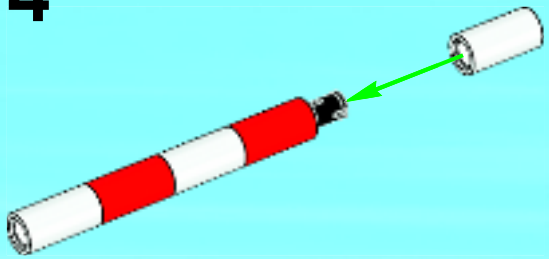

5

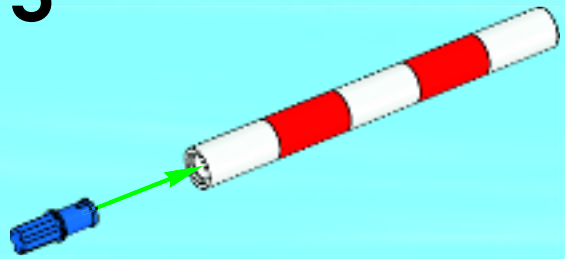

6

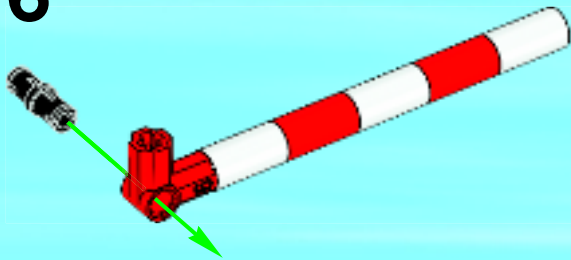

7

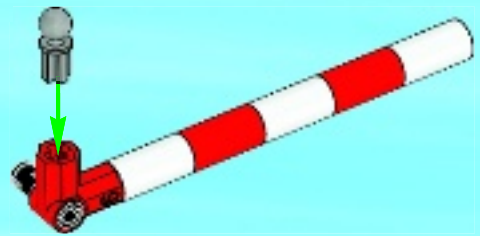

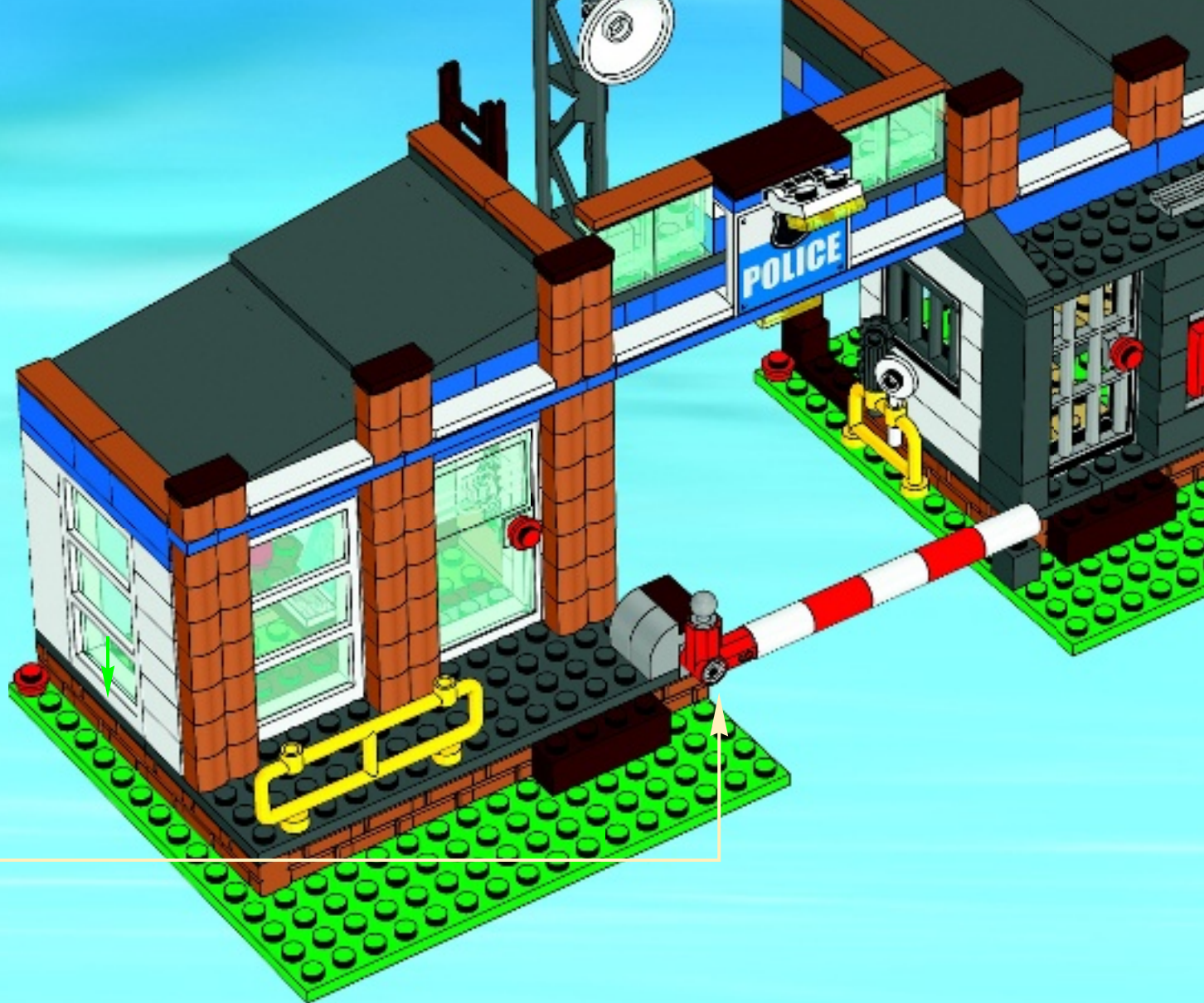

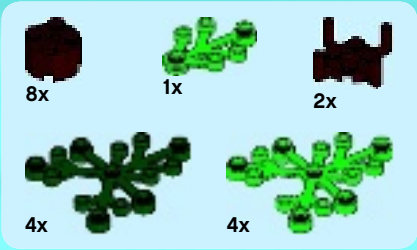

16

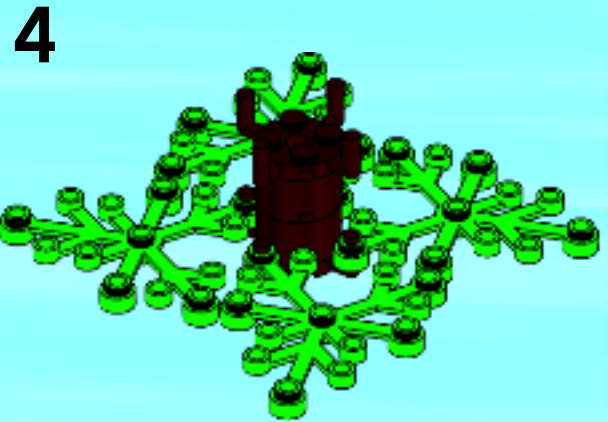
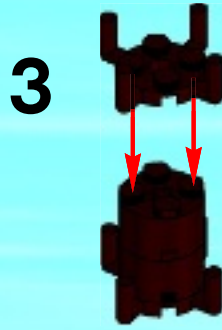
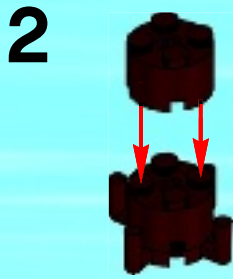

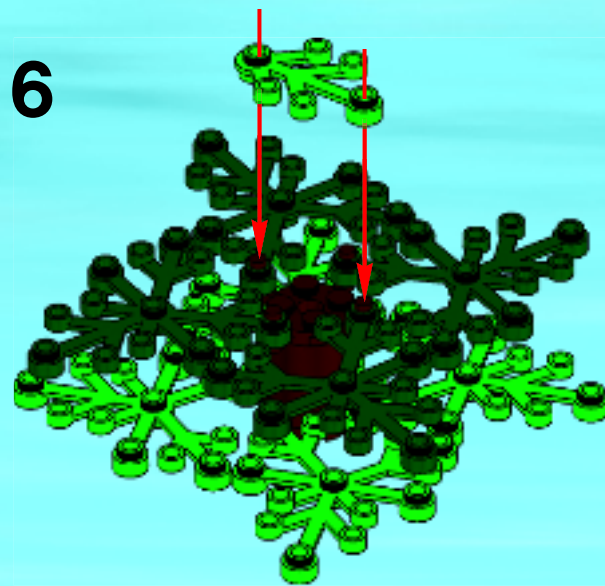
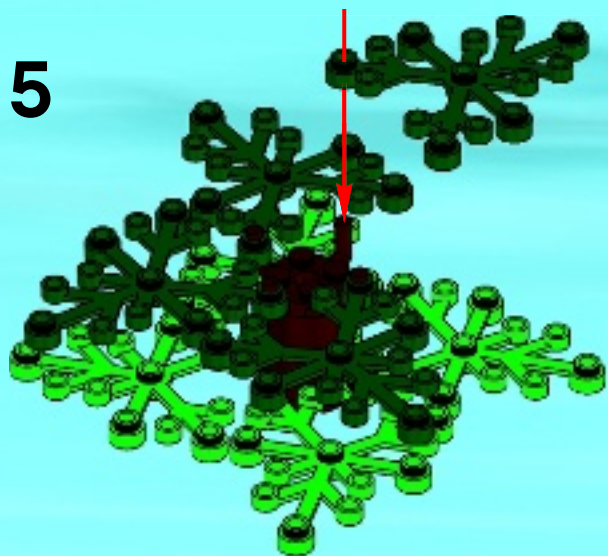

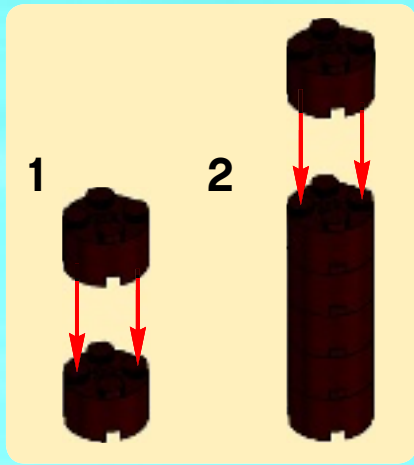

7







BATMAN 2

DC SUPER HEROES





WIN!

Go to www.LEGOsurvey.com/product
to fill out a survey for a chance
to win a cool LEGO® Product.

No purchase necessary.

Open to all residents where not prohibited.



www.LEGOsurvey.com/product

GEWINNE! WIN!

Nimm an der Umfrage auf
www.LEGOsurvey.com/product
teil und hab die Chance ein cooles
LEGO® Produkt zu gewinnen!

Die Teilnahme am Gewinnspiel führt zu keinerlei
Kaufverpflichtungen. Teilnahme in allen nicht
ausgeschlossenen Ländern möglich.

Ga naar www.LEGOsurvey.com/product,
vul een enquêteformulier
in en maak kans op een
cool LEGO® product.

Geen aankoopverplichting.
Iedereen mag deelnemen, uitgezonderd
ingezetenden van landen waar een
enquêteverbod geldt.

GAGNE! 当てよう!

Visite www.LEGOsurvey.com/product
pour répondre à un
questionnaire et avoir une chance de
gagner un produit LEGO® très cool!

Aucune obligation d'achat.
Ouvert à tous les résidents des pays
autorisés.

www.LEGOsurvey.com/product にアクセスして、
アンケートにご記入ください。当選者にはレゴ®
製品を差し上げます。

お買い上げの必要はありません。

禁止されていない限り、すべての皆様にご利用いただけます。