

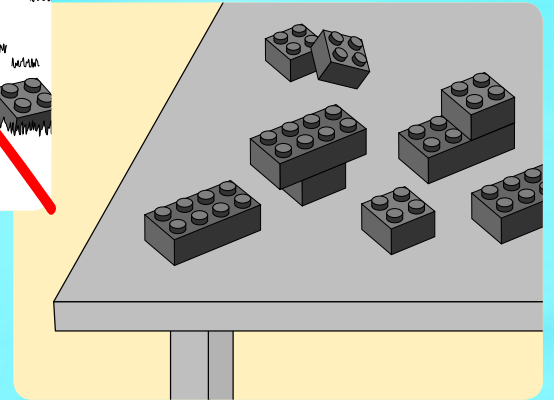

4439

# CITY

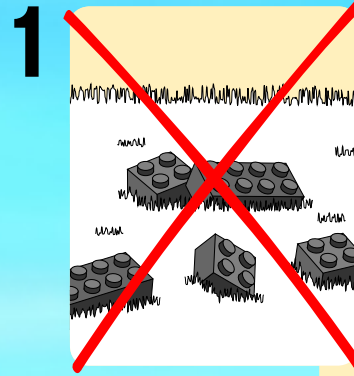

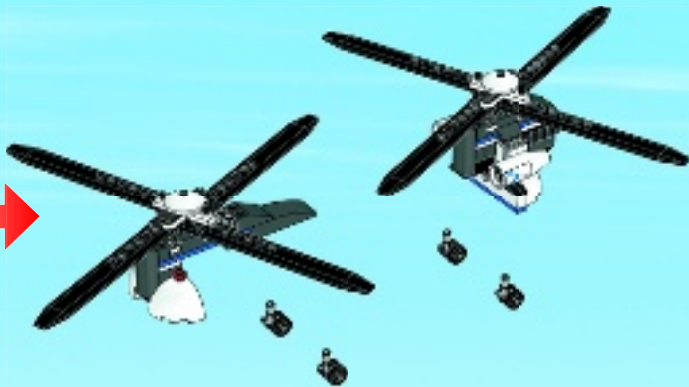
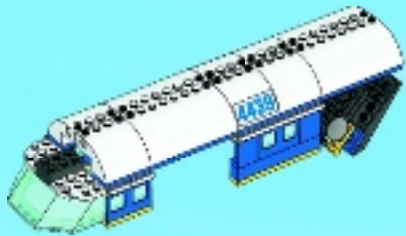
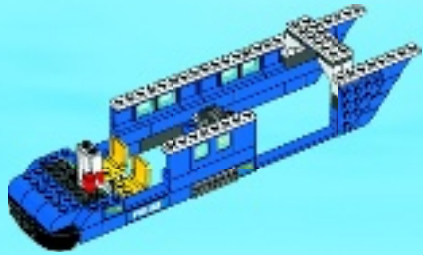
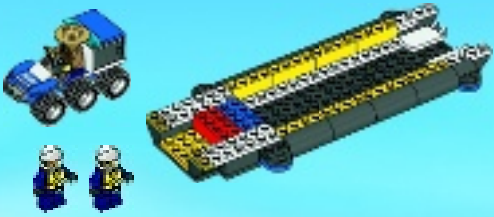

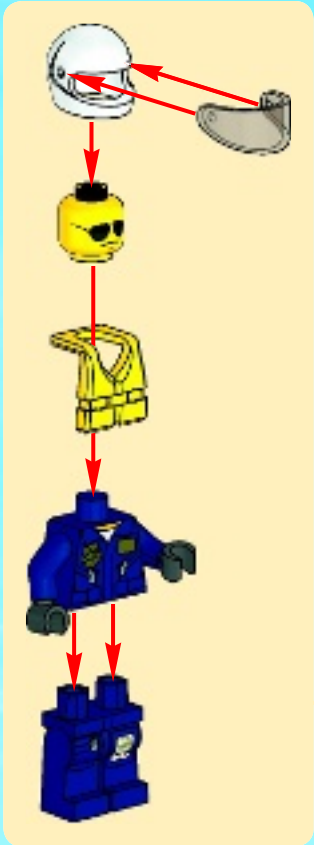
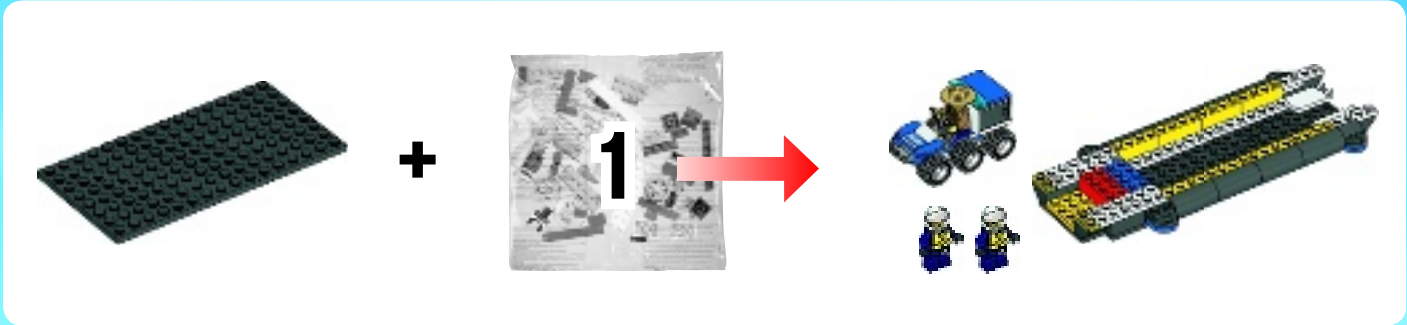

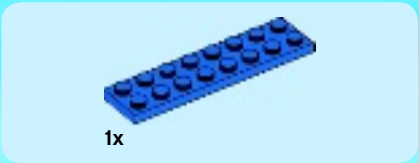

1x

1

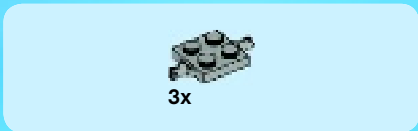
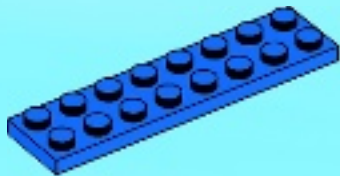

3x

2

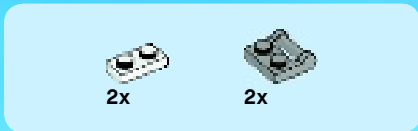
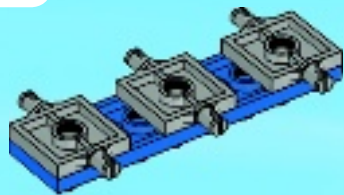

2x

2x

3

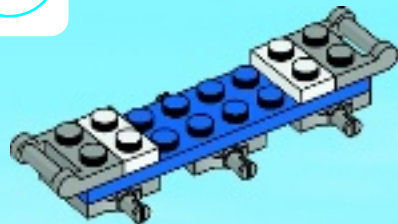



1x



1x

# 4

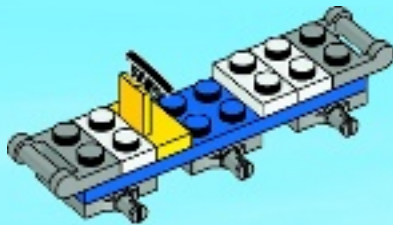

1x



1x

# 5

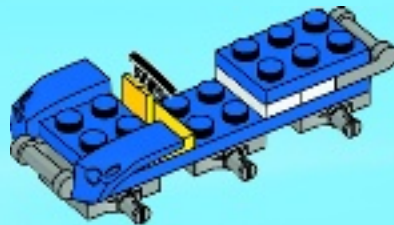

1x



1x

# 6

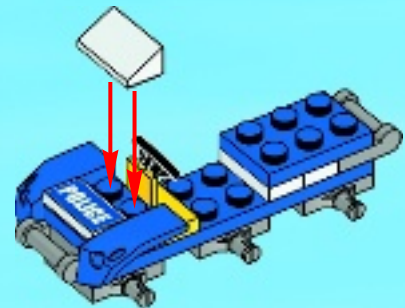



# 7

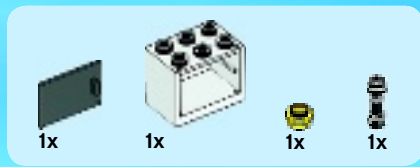
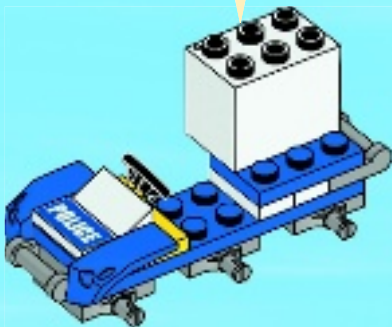
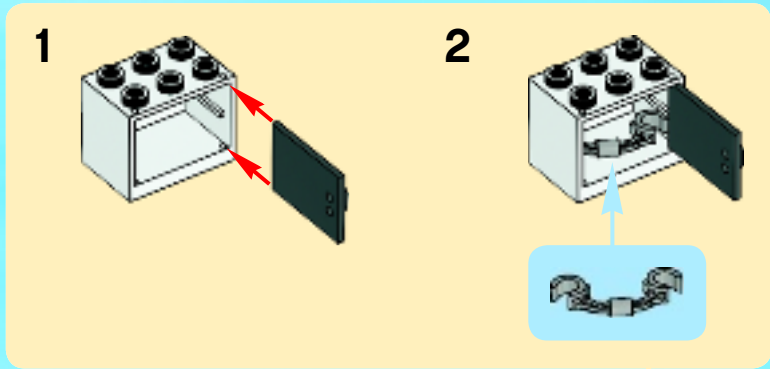

# 8

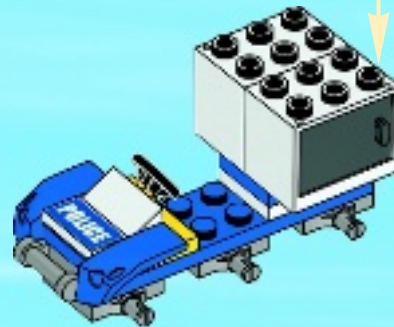
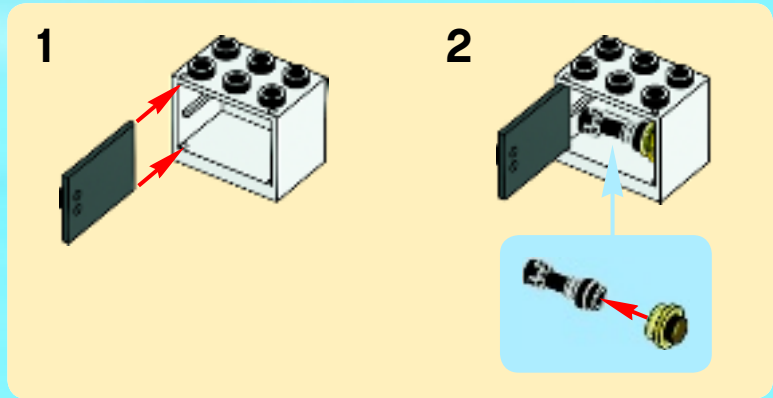



1x



1x

# 9

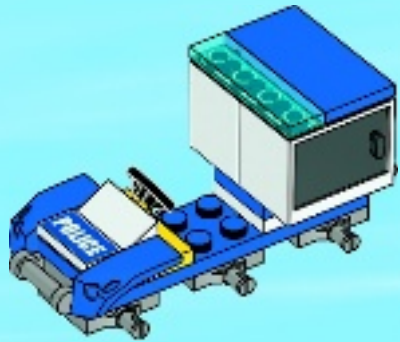

6x



6x

# 10





1x

1



2

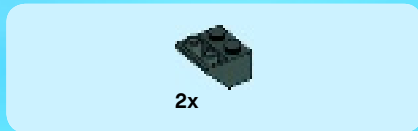

2x

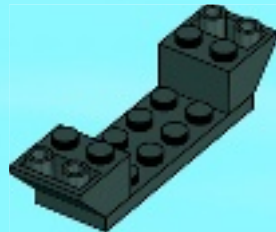

3



1x





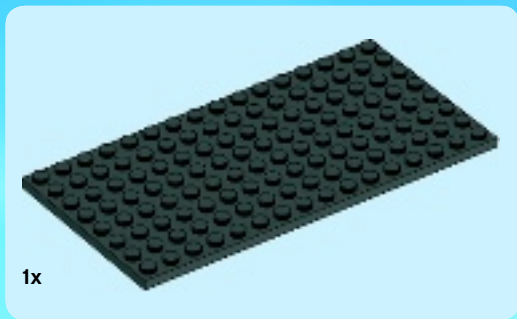

4

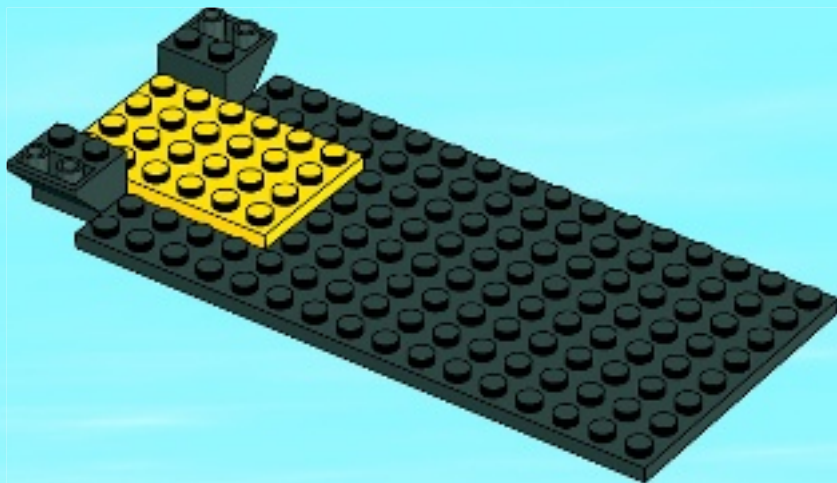

5

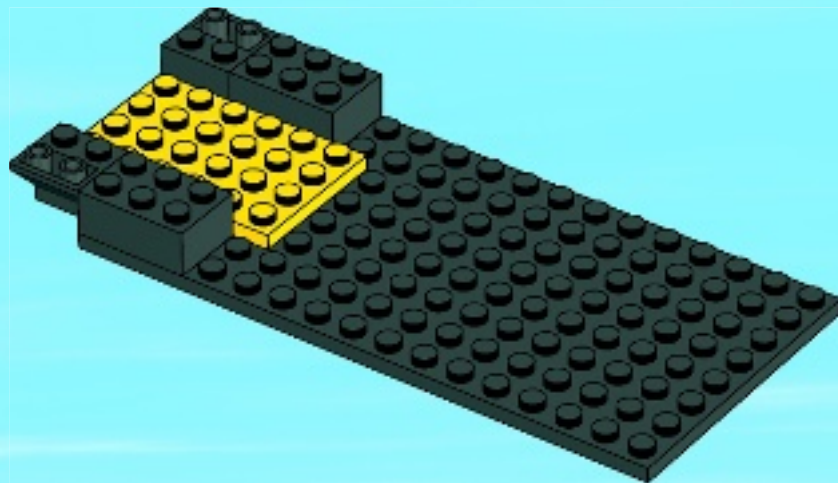



1x



2x

# 6

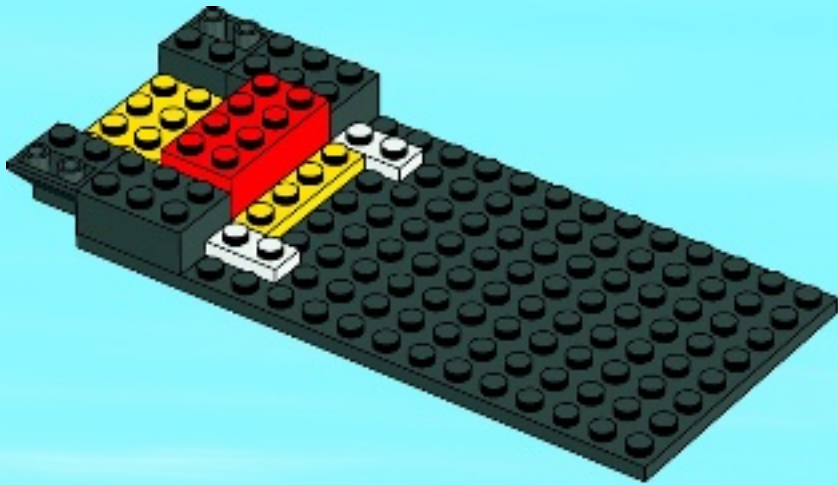

1x

# 7

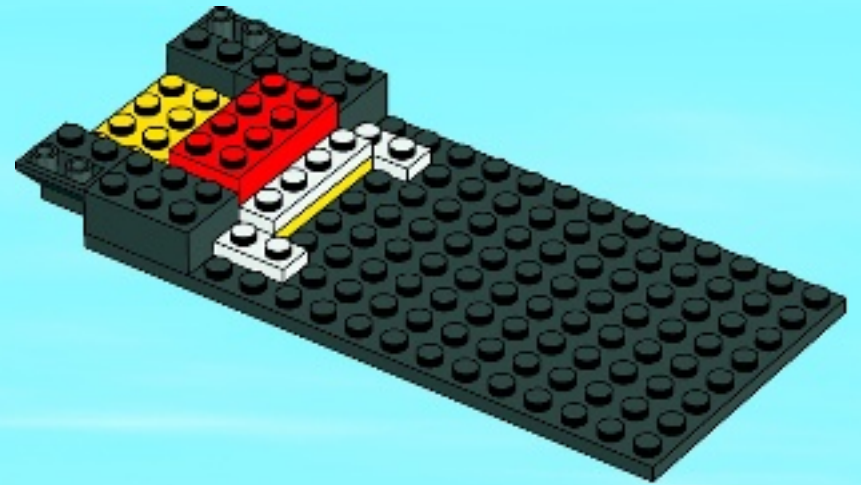



2x

8

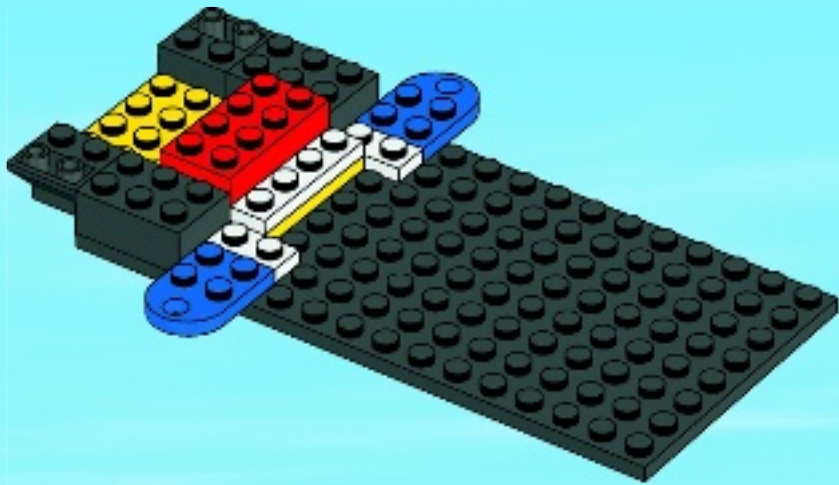

2x

9

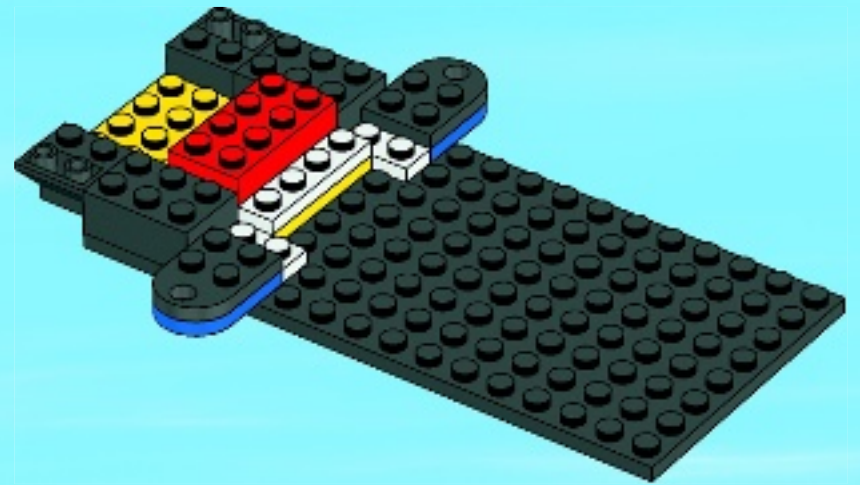

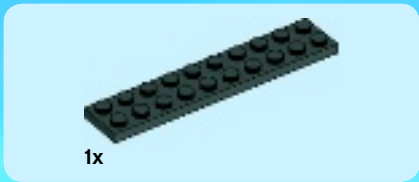

10

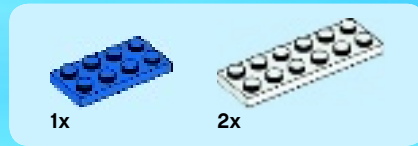
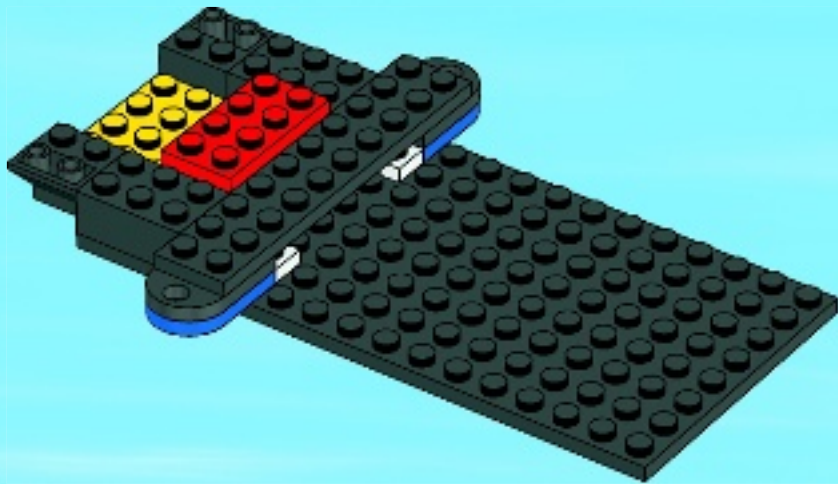

11





2x

# 12

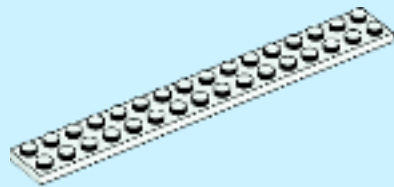
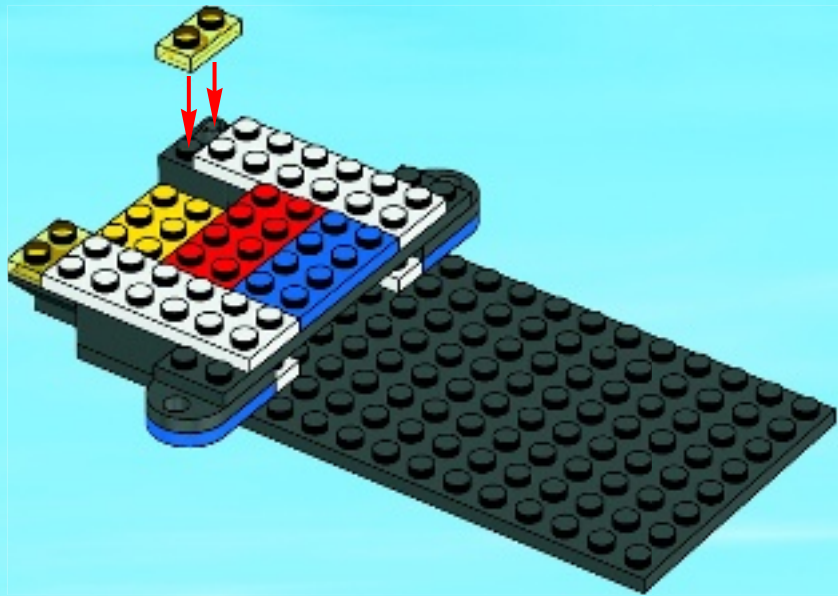

2x

# 13

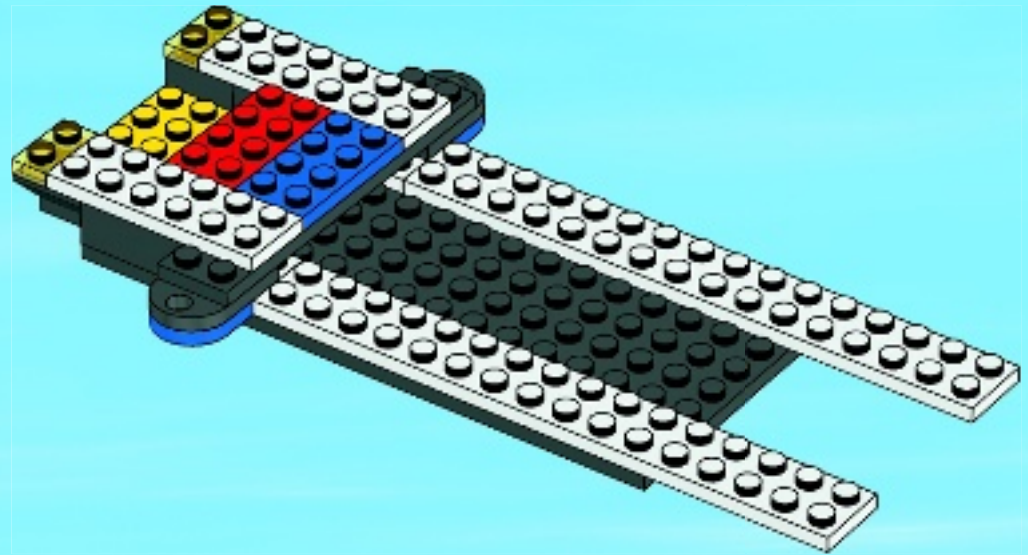



14

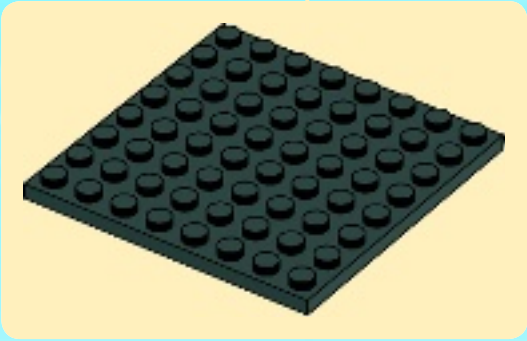
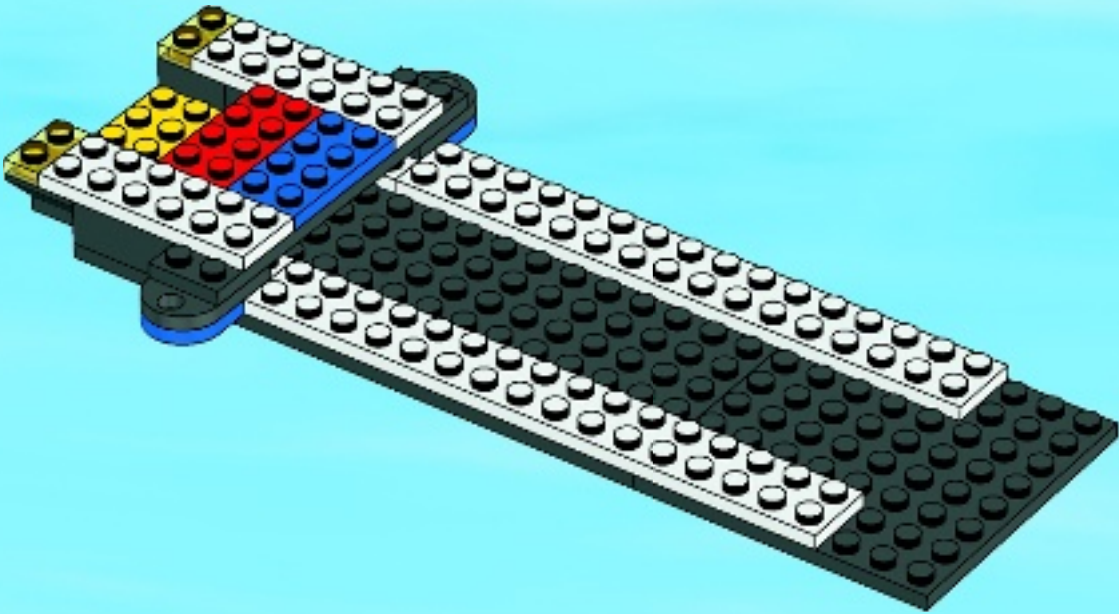



8x

15

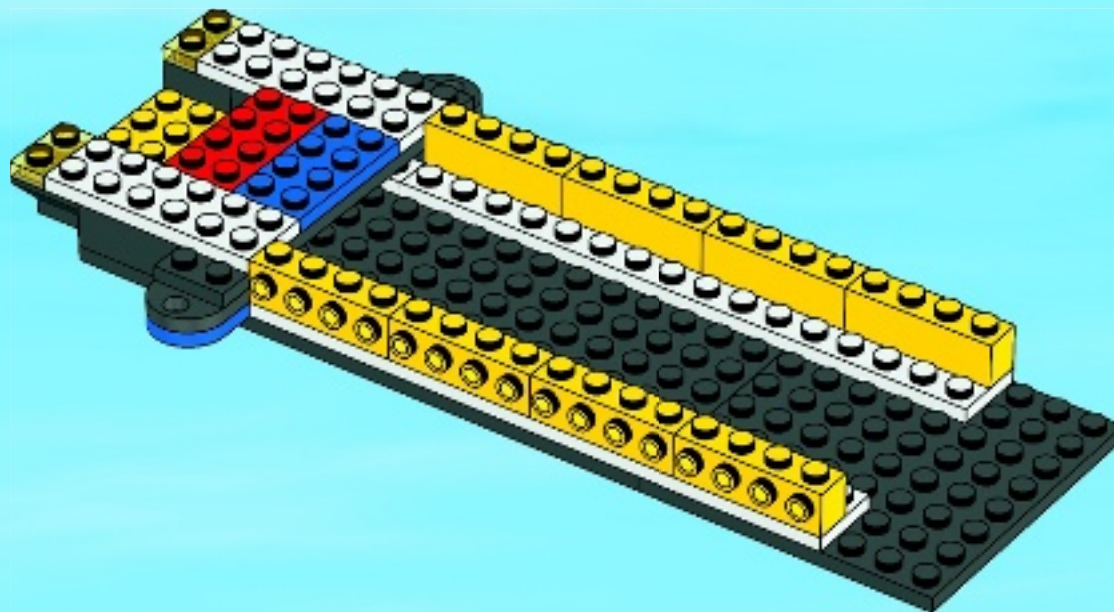







2x

17

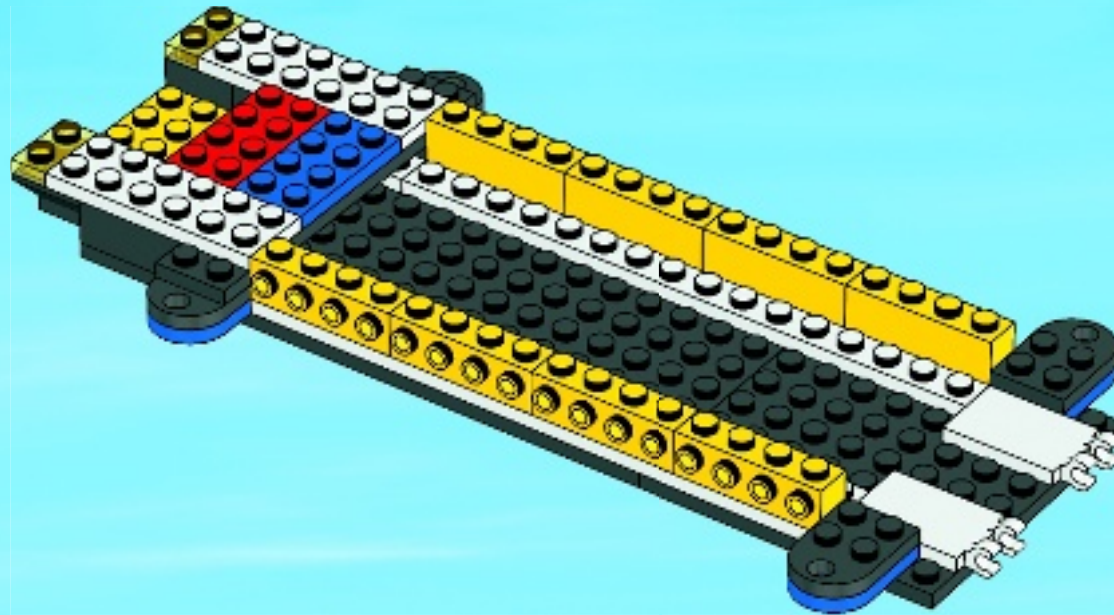





2x

# 19

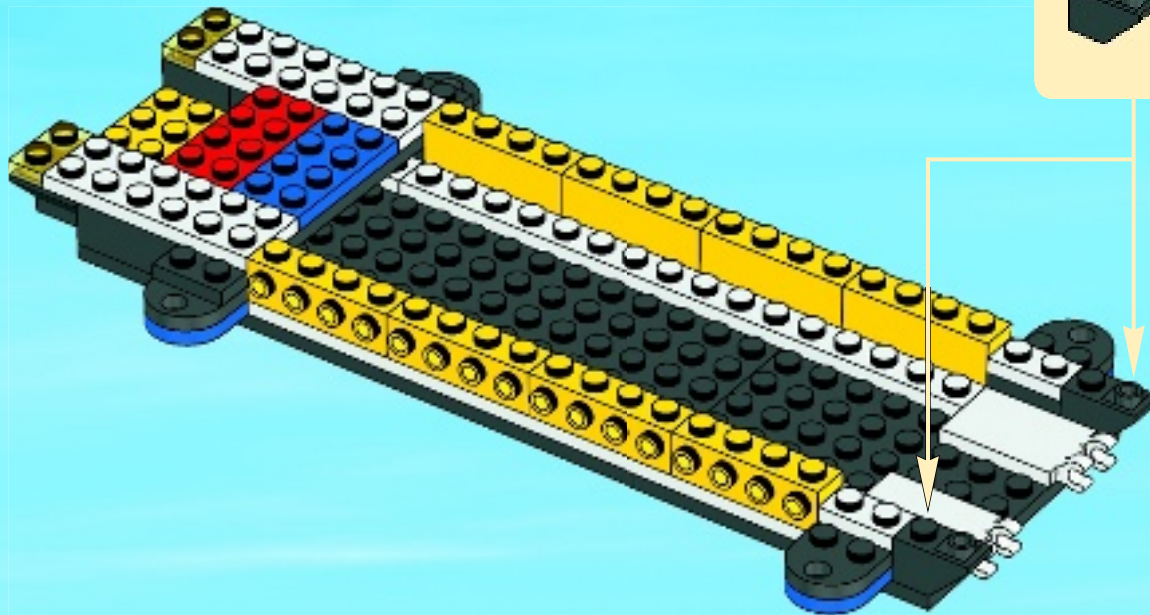

2x



2x

20

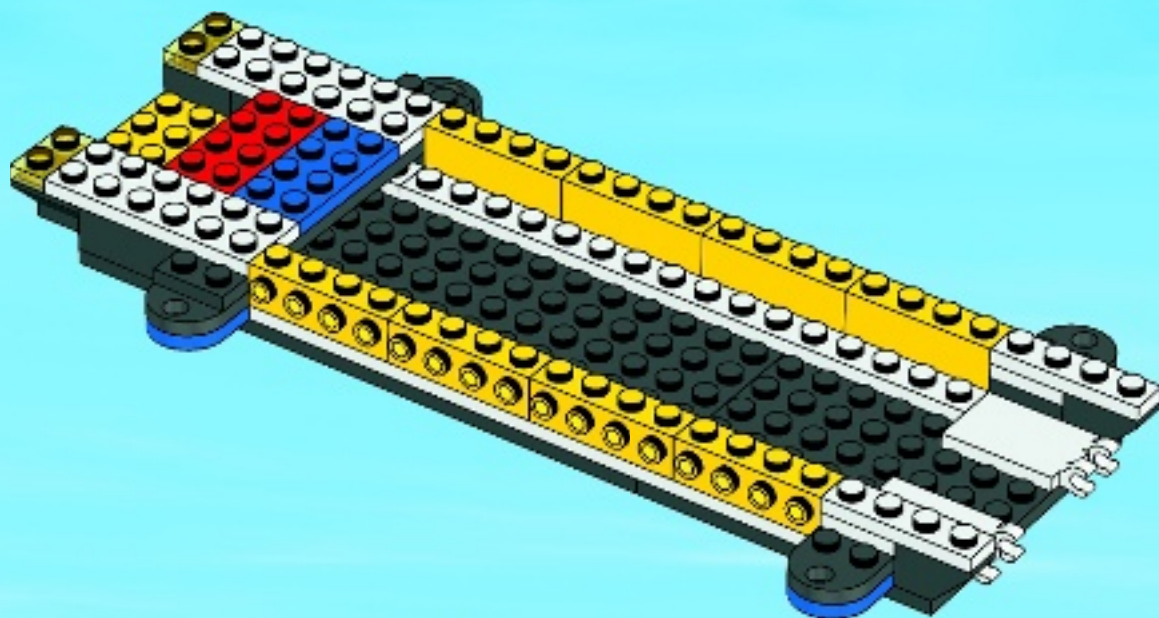



2x

# 21

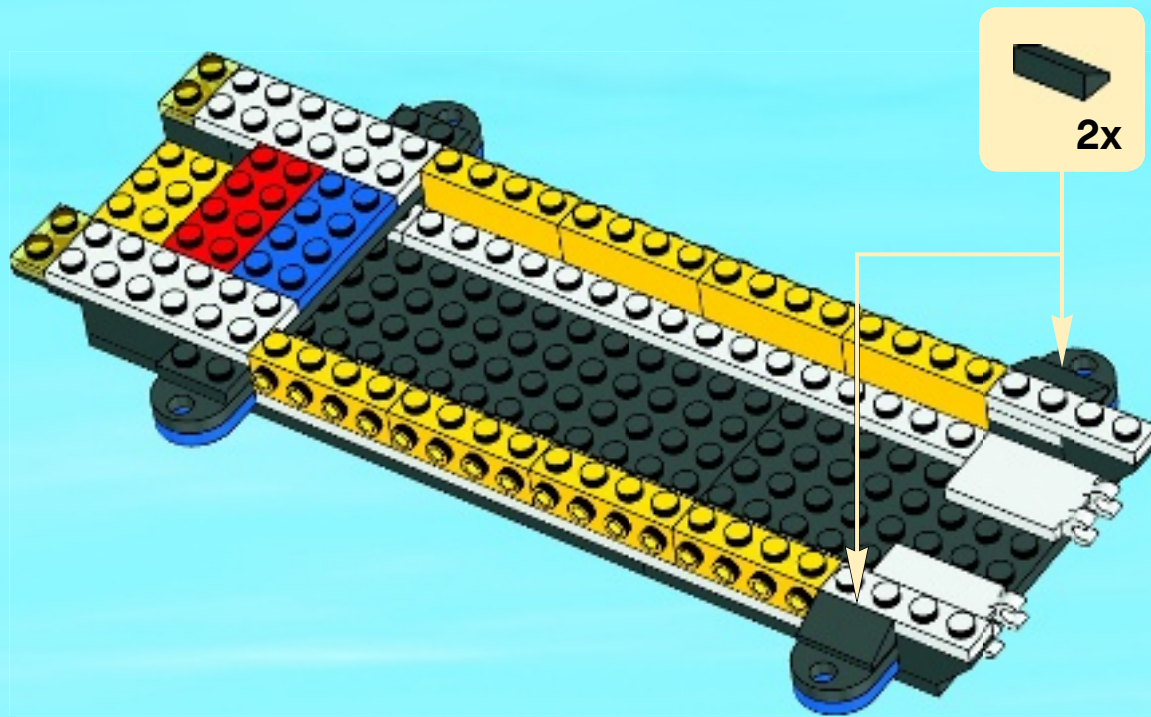



8x

22



8x

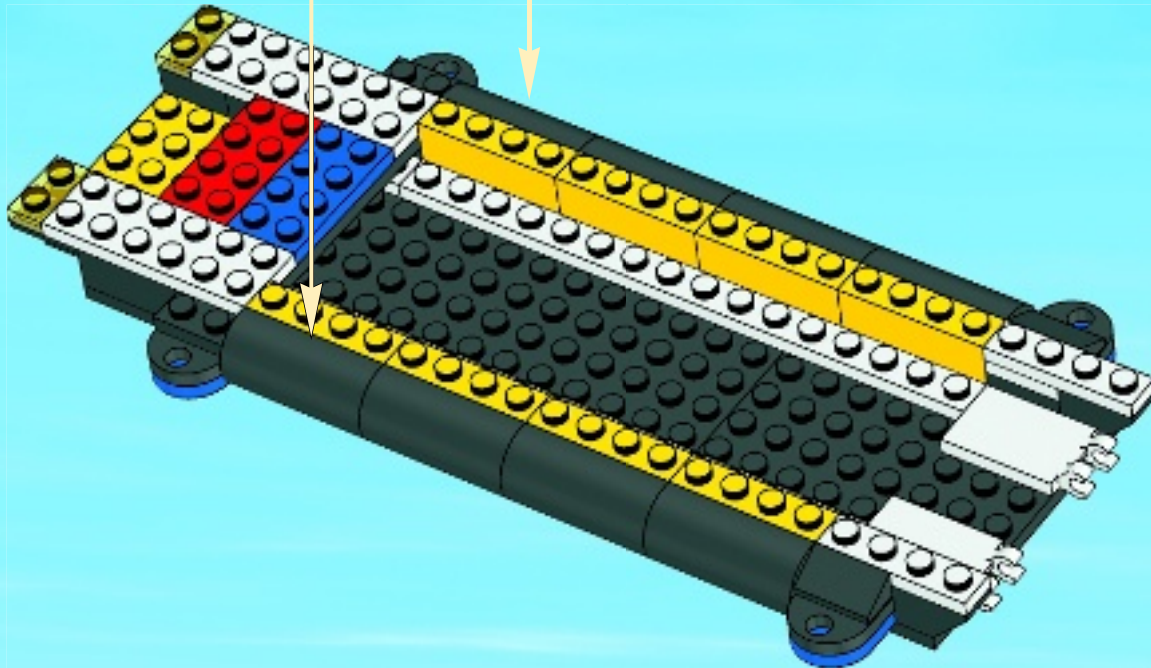

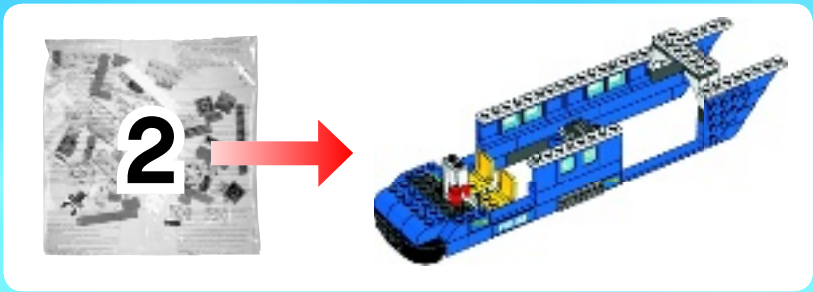

23

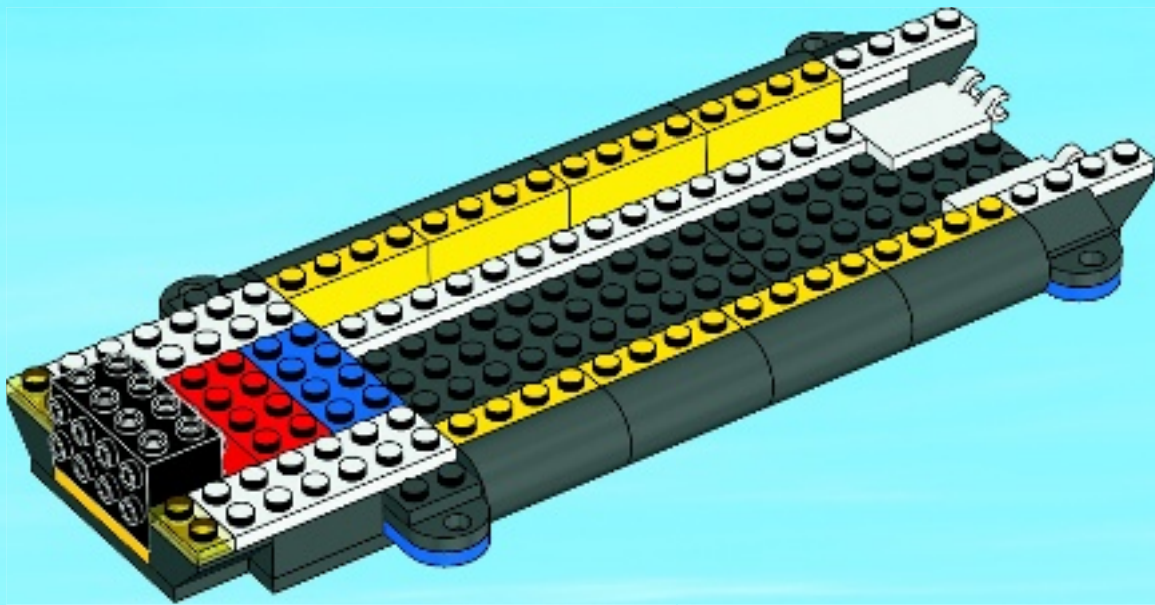



2x



2x

# 24

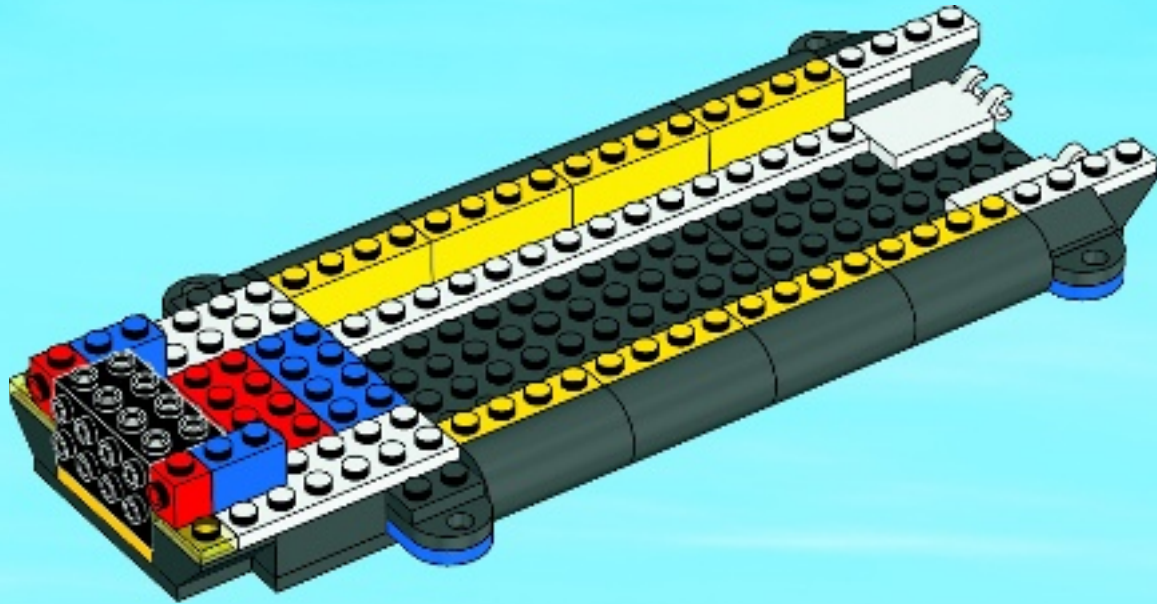



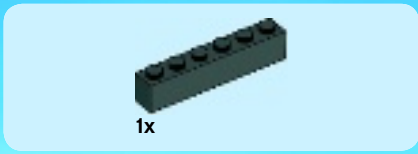

25

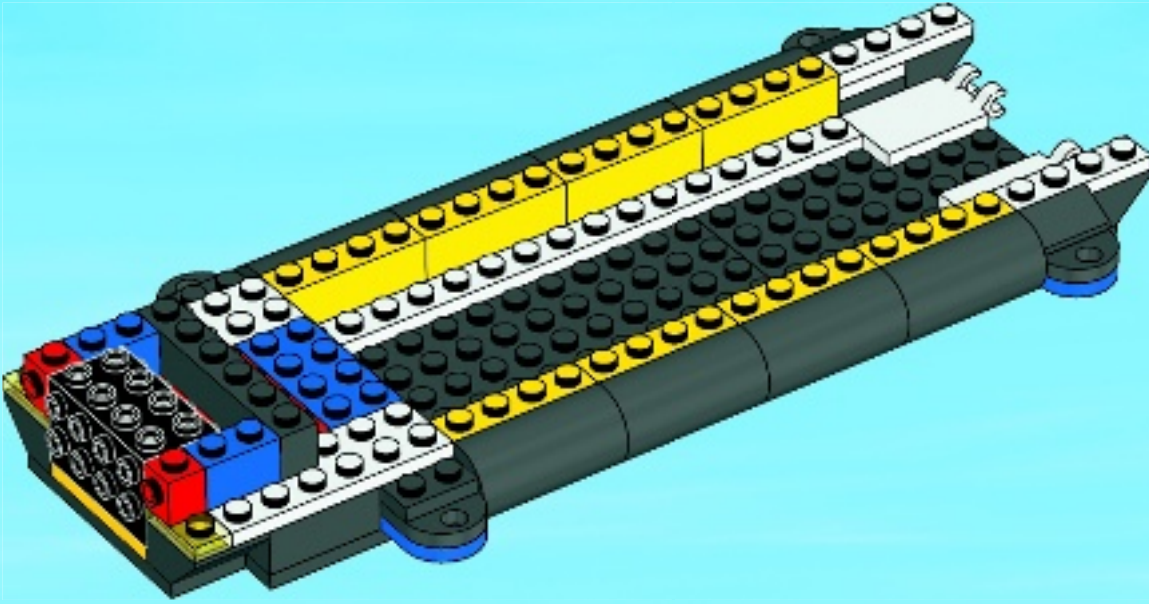



2x

# 26

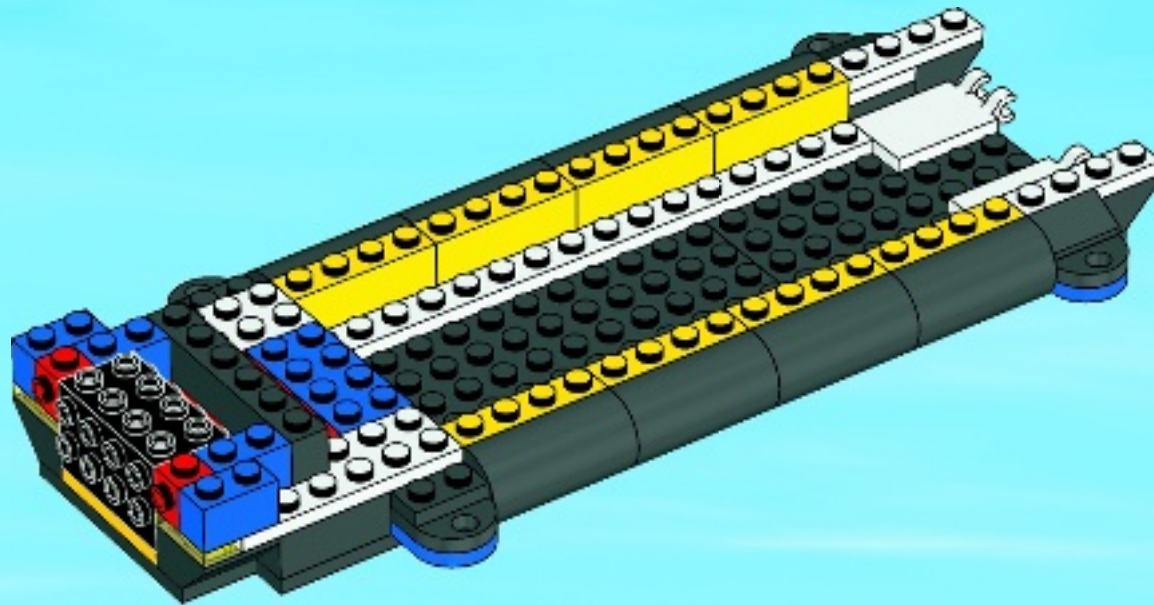

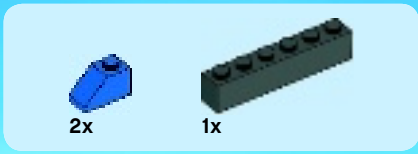

27

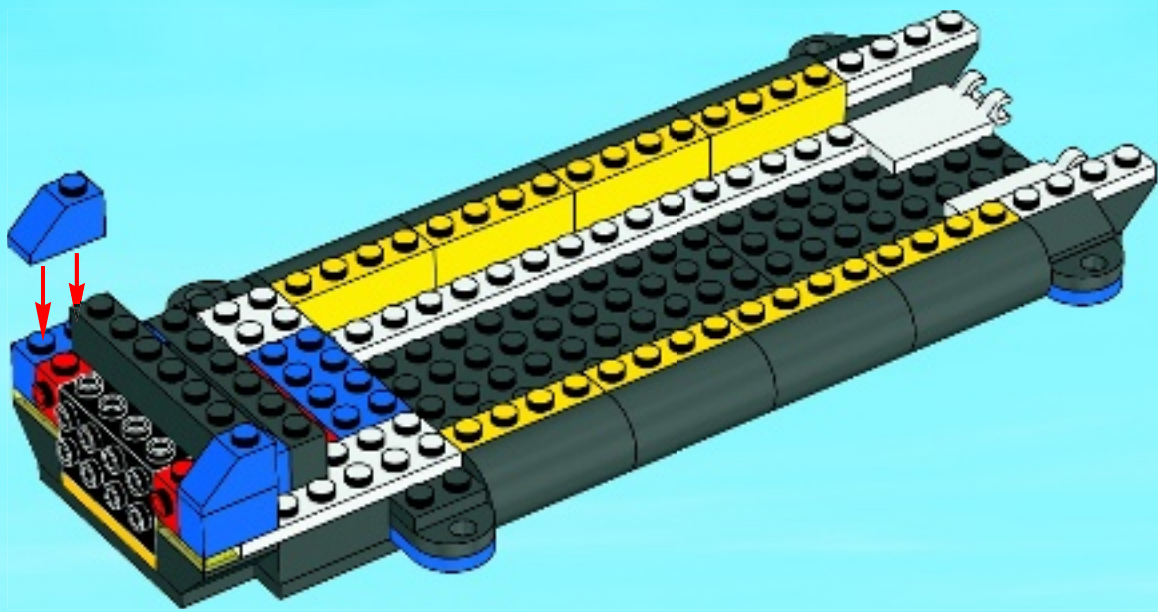



1x

28

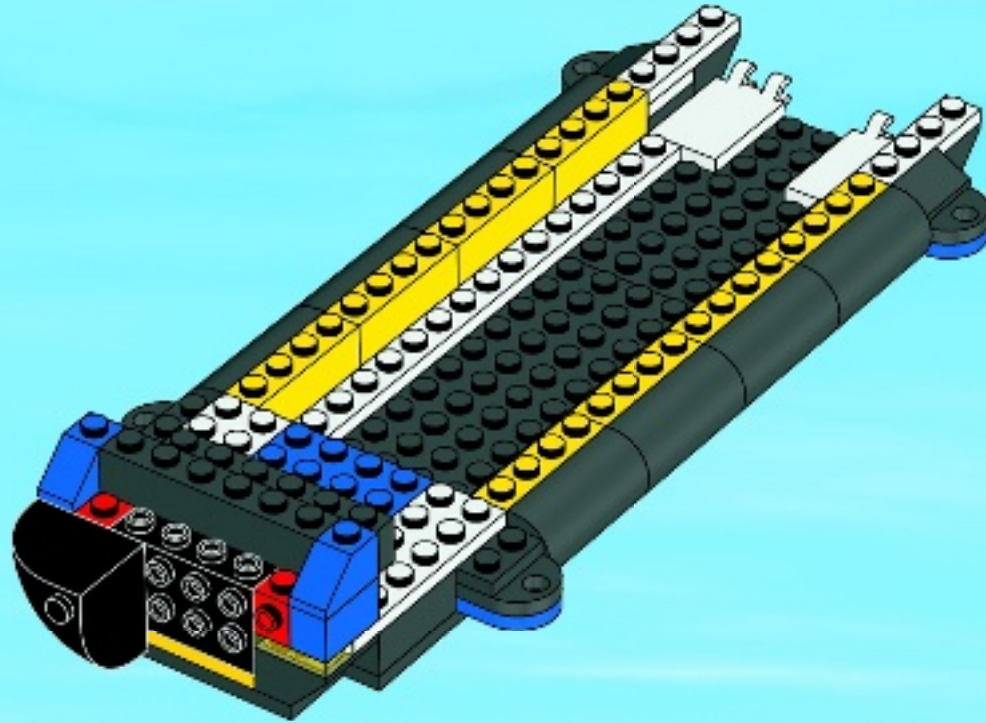



2x

# 29



2x

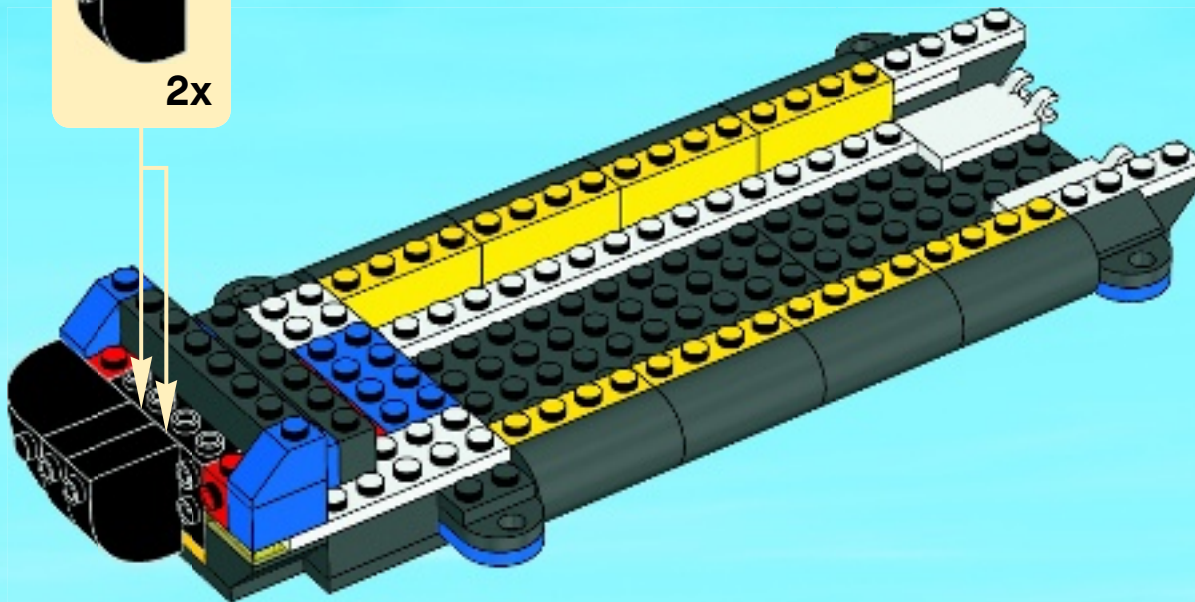







2x



4x

# 32

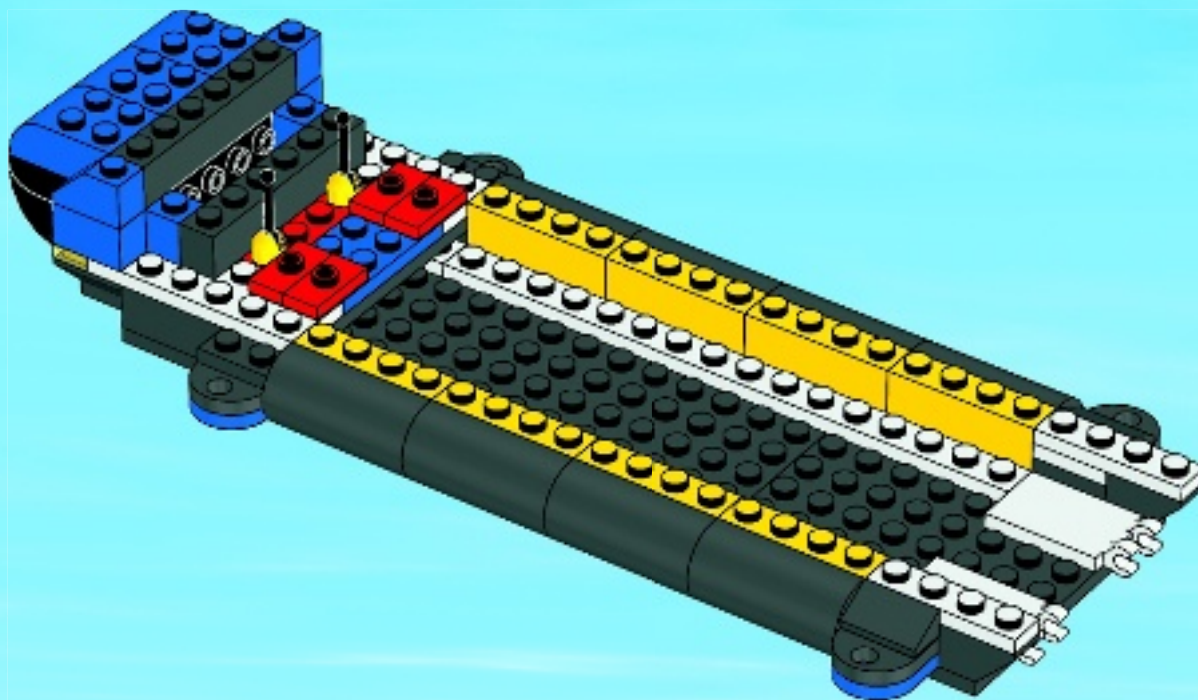





2x

33

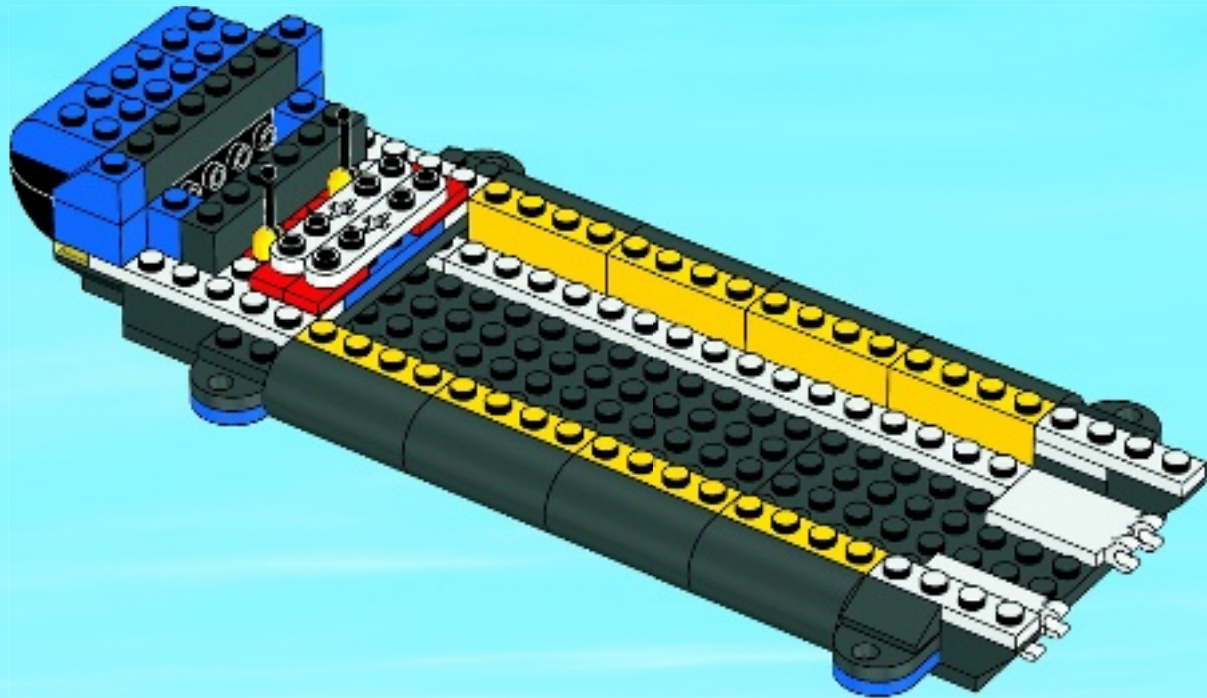

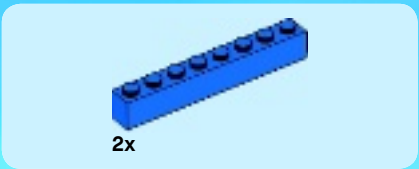

# 34

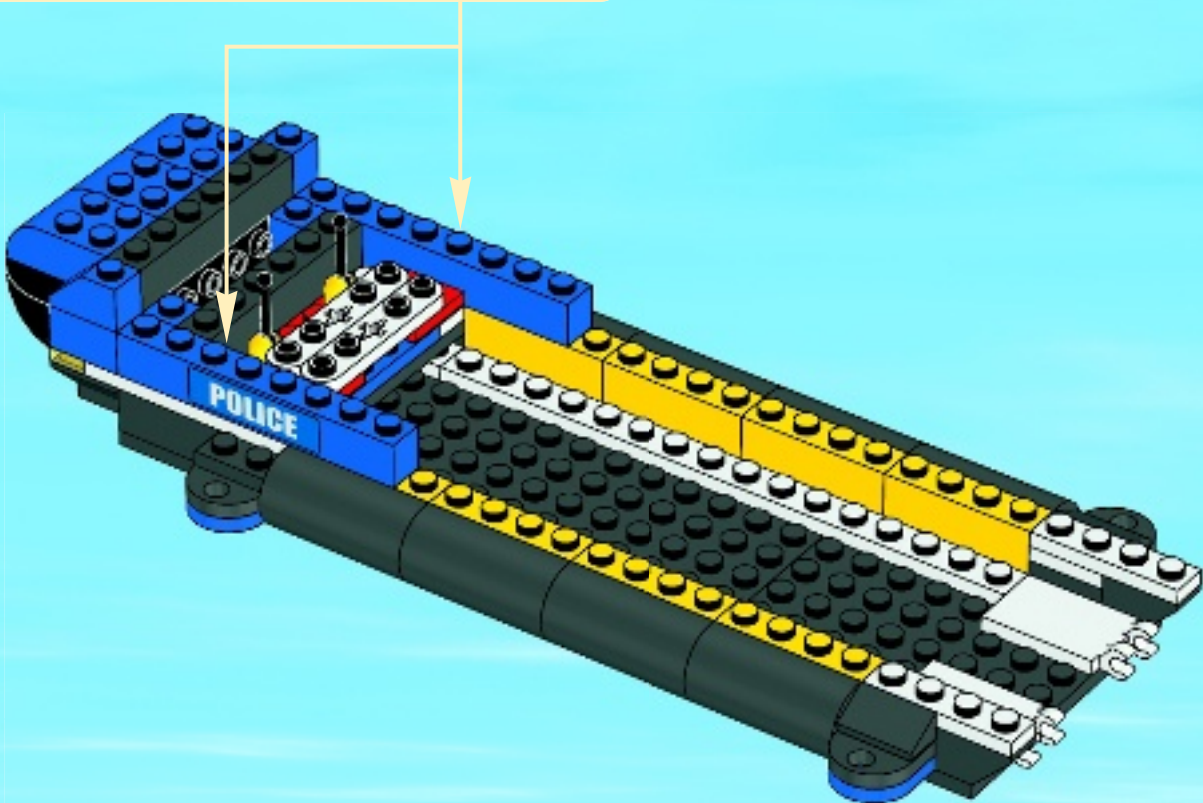
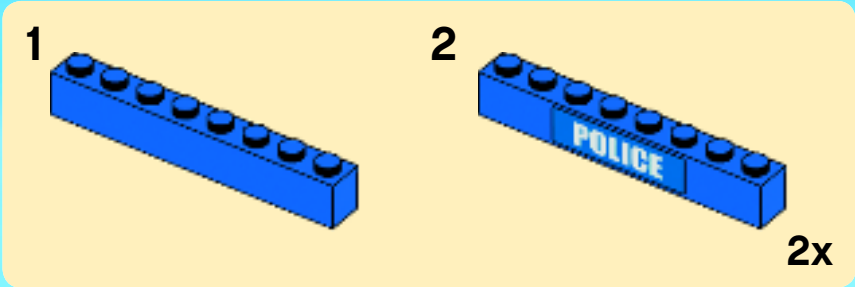



# 35

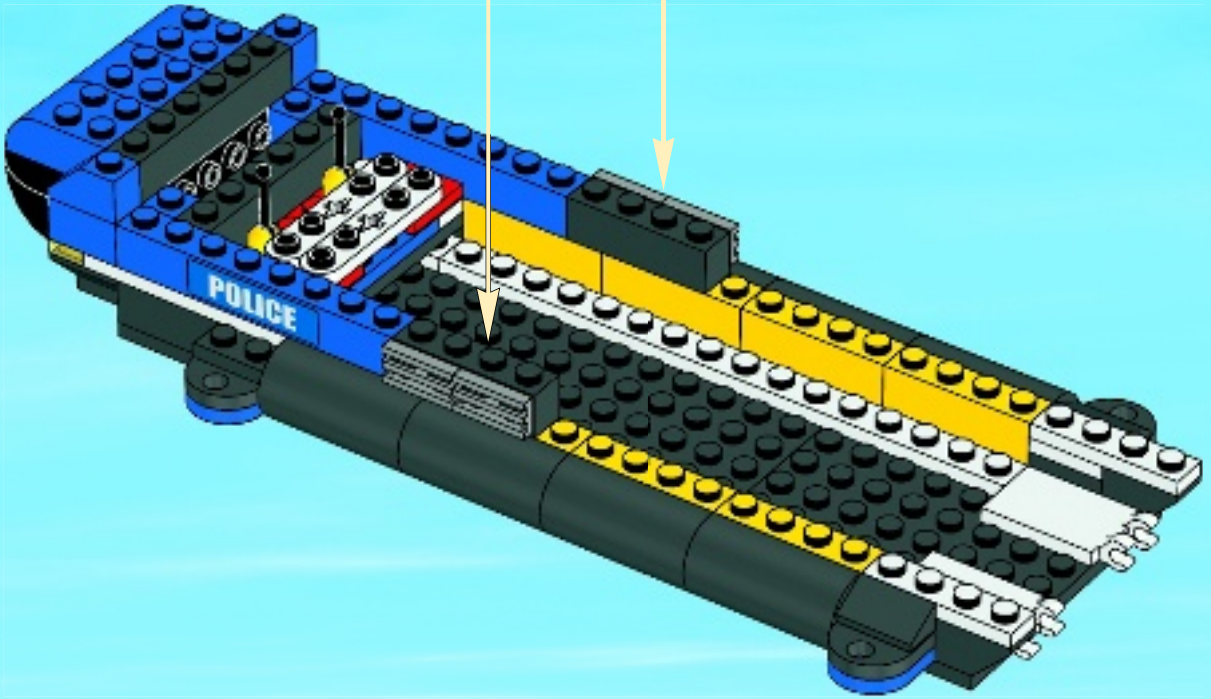
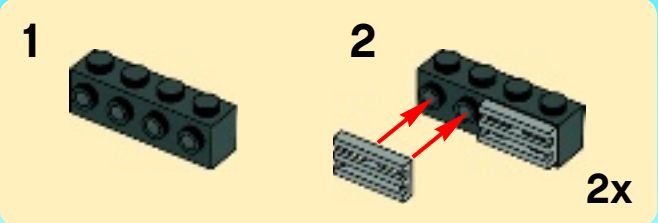

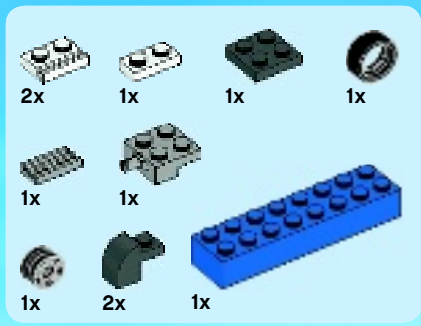

# 36

1

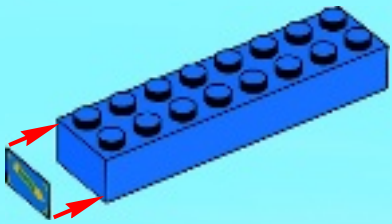

2

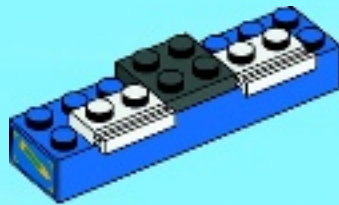

3

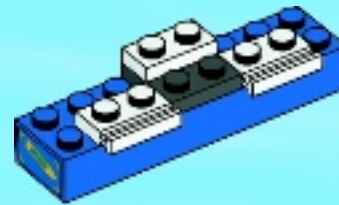

4

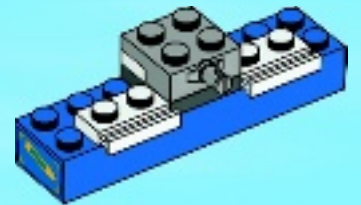

5

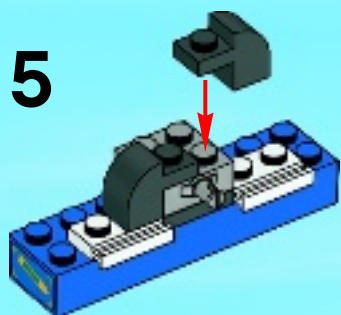

6

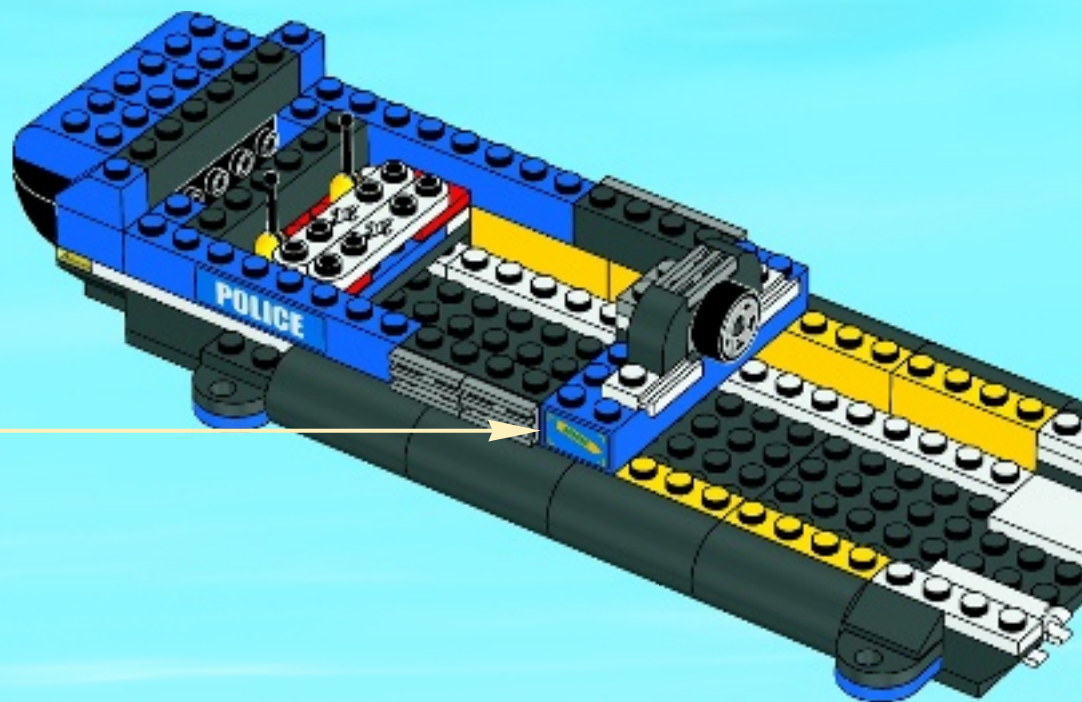
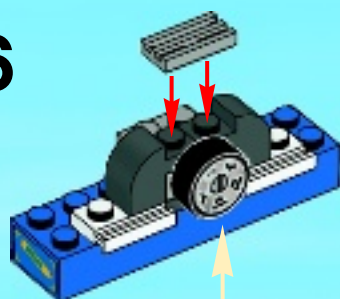

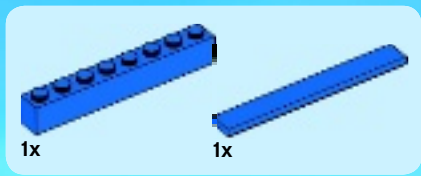

37

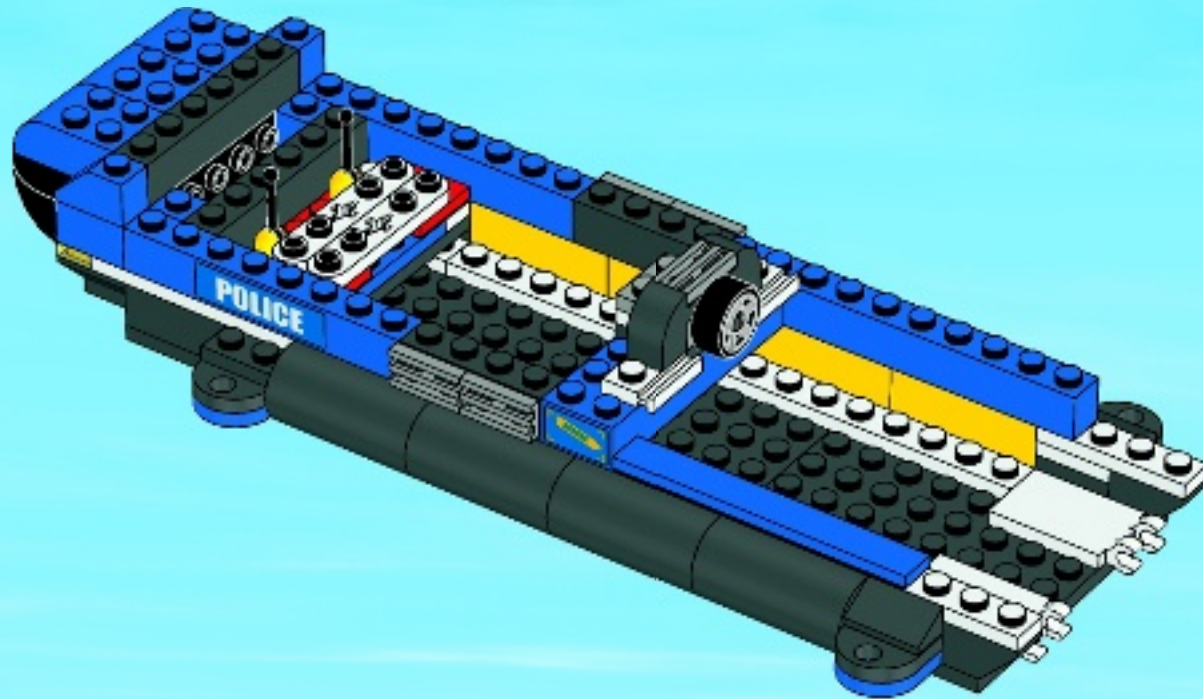



2x



2x

# 38

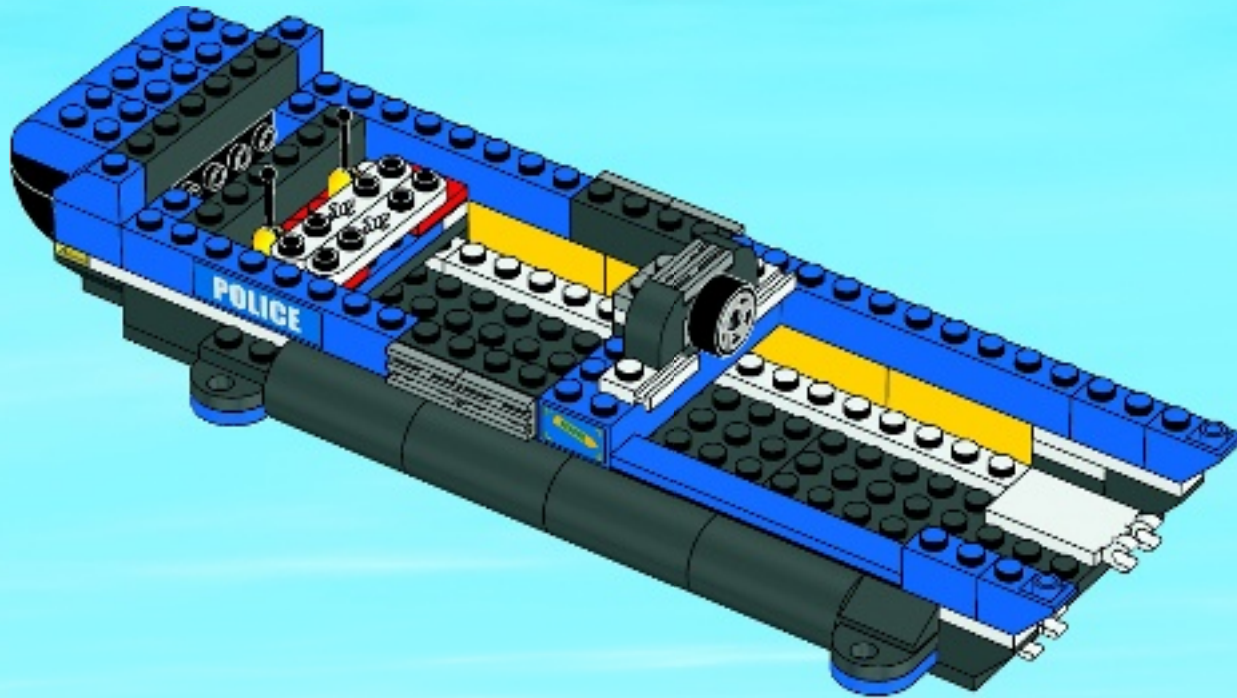



2x

# 39

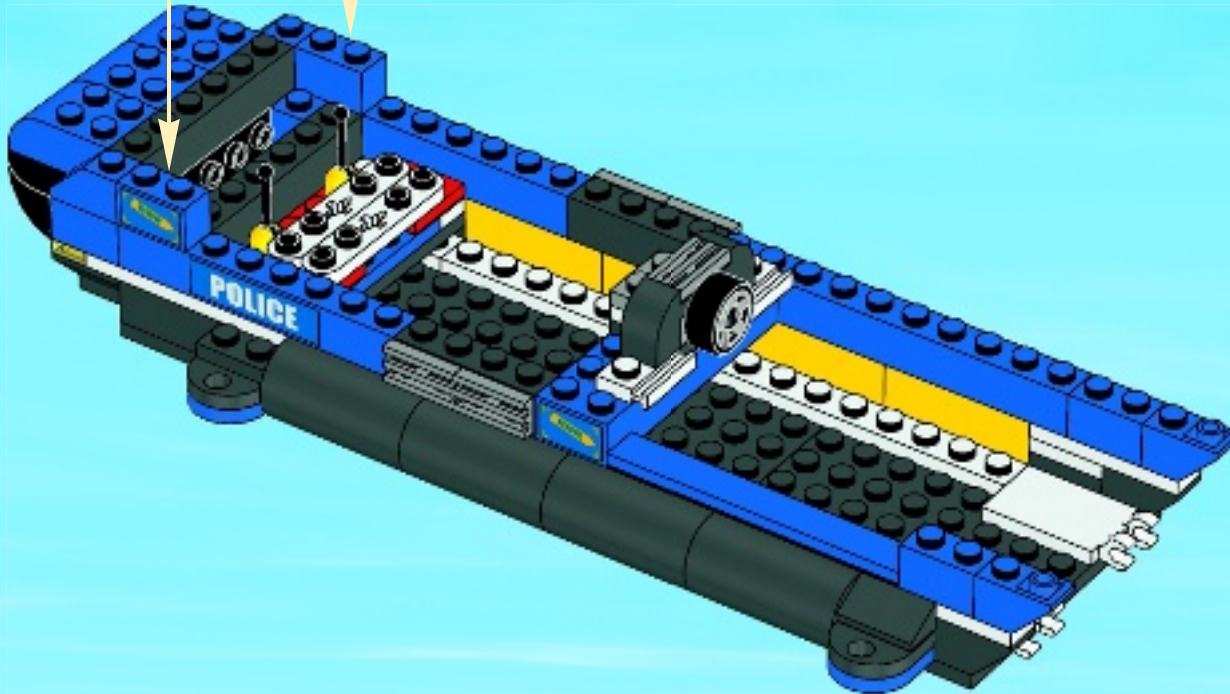
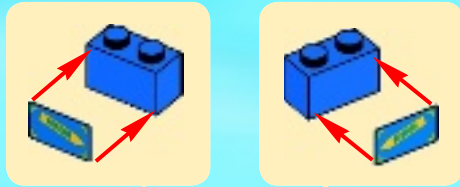





1x



1x

# 40

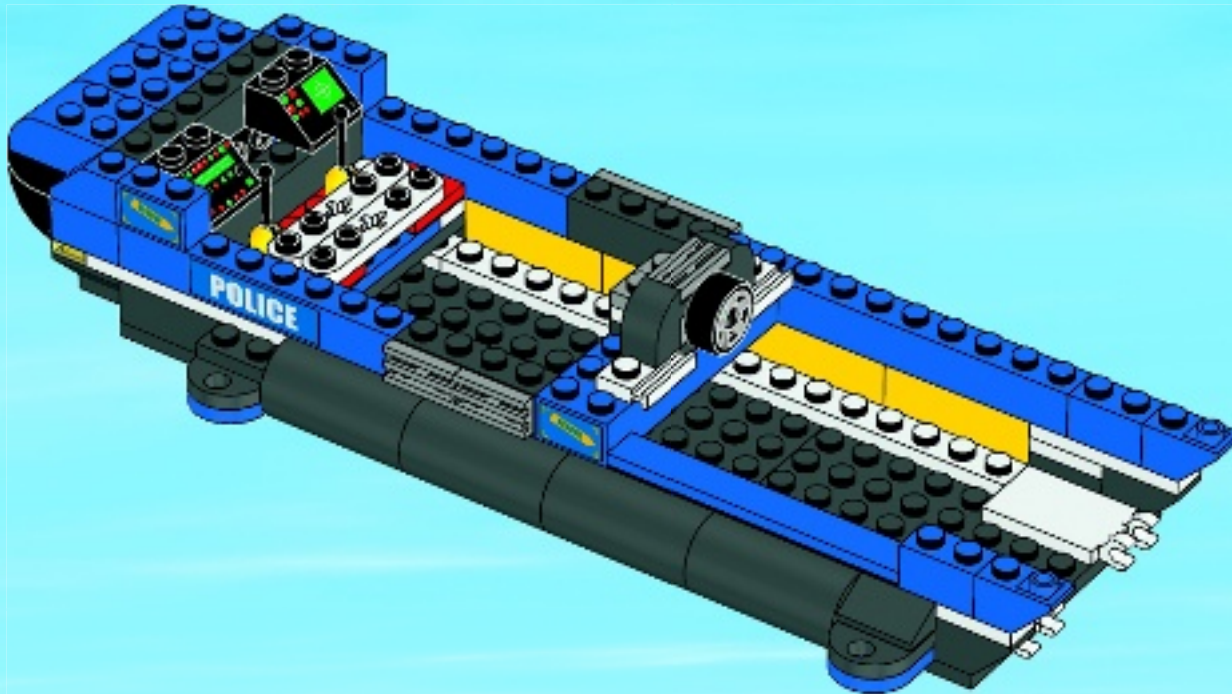



1x

41

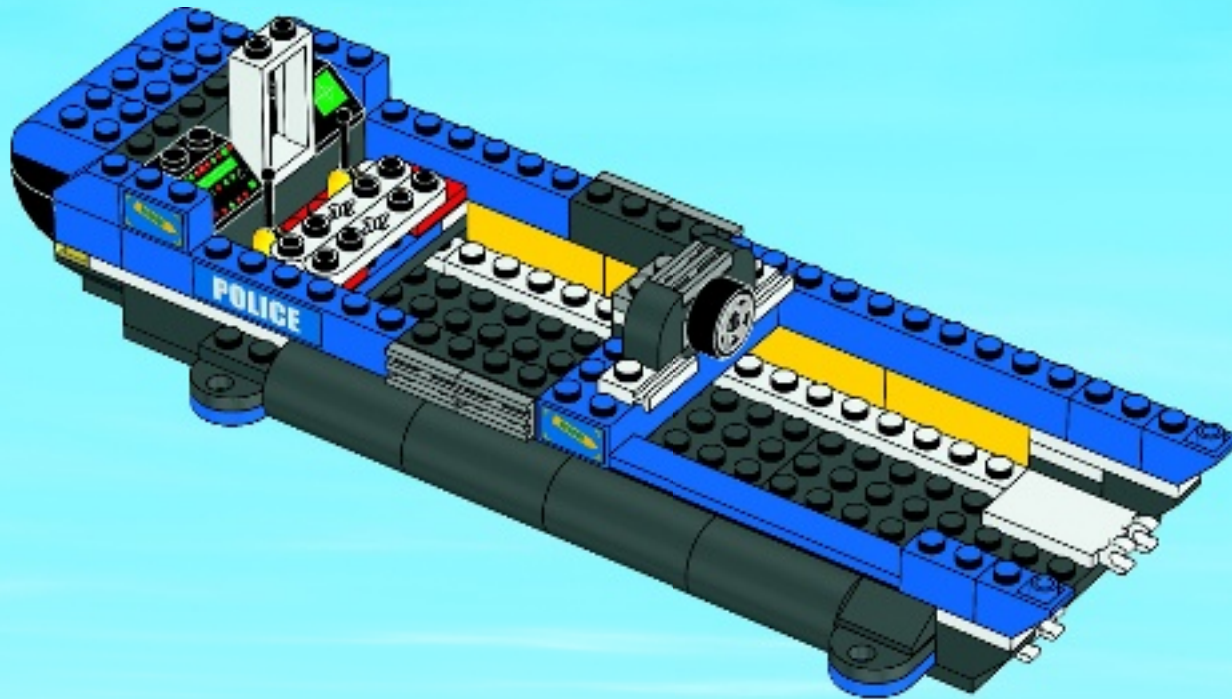



2x

# 42

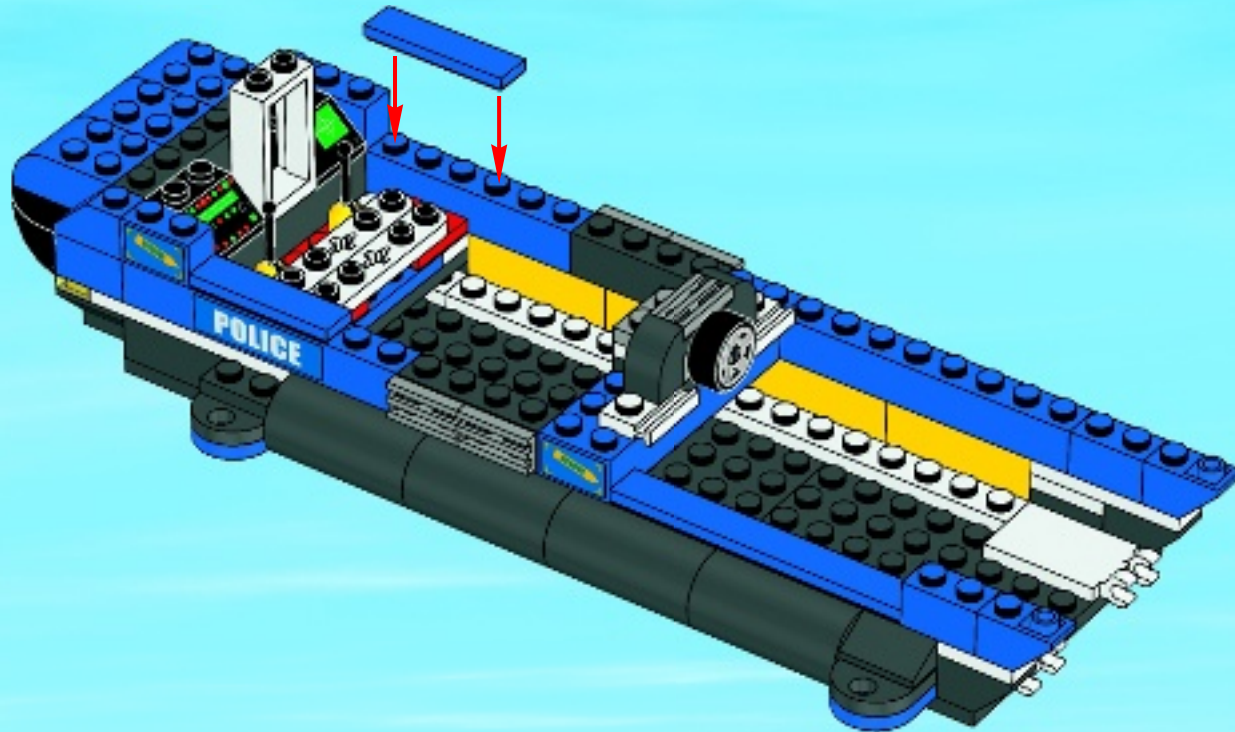



2x



1x

# 43

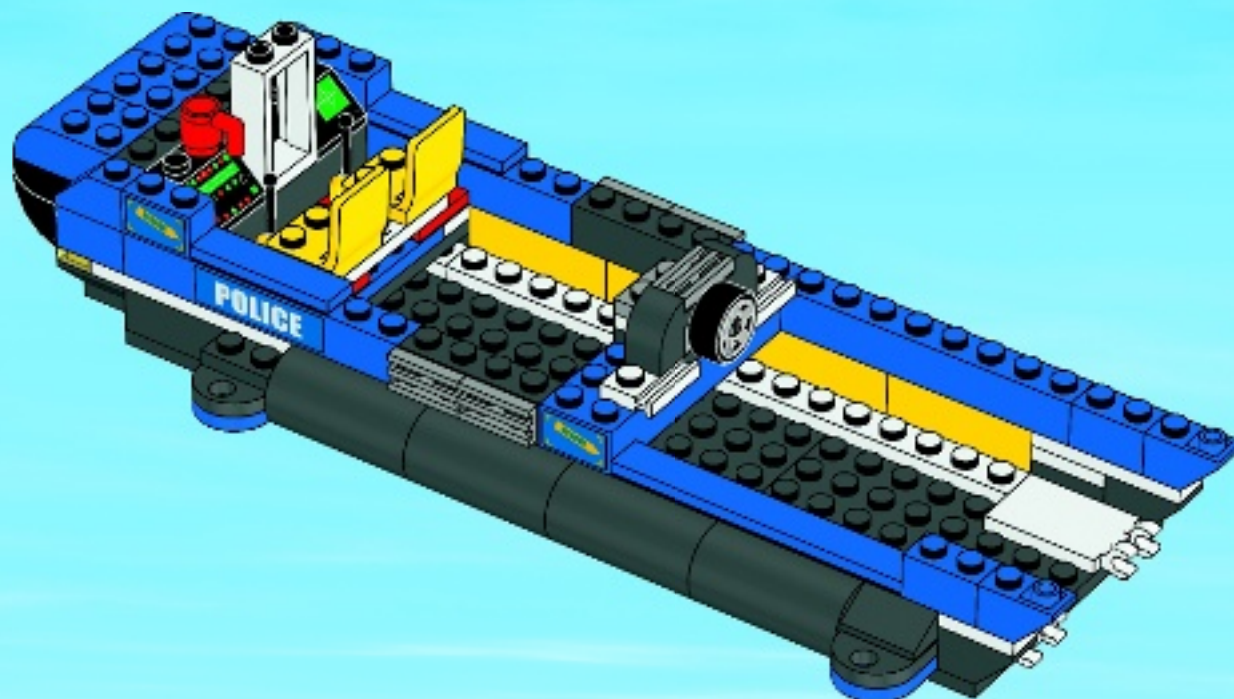

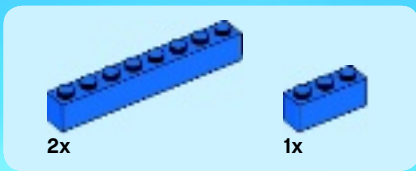

44

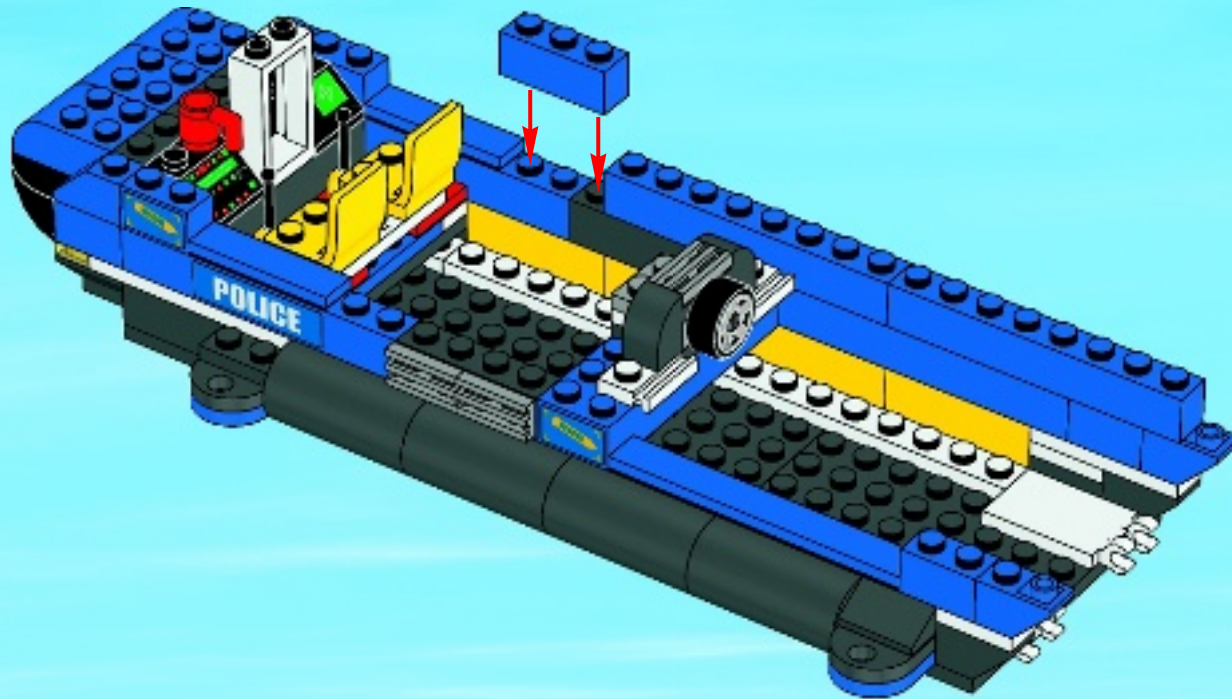

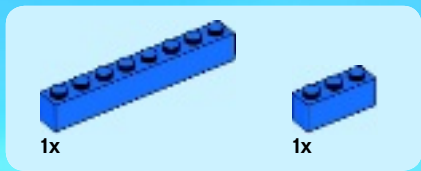

45

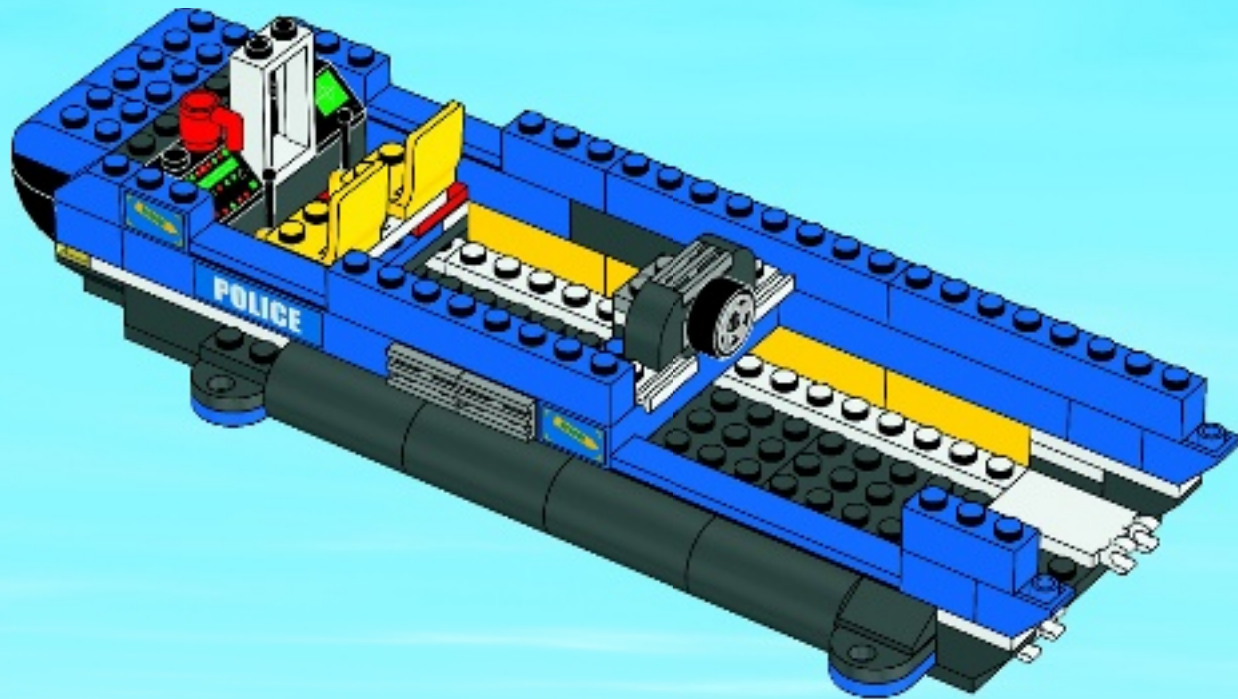



2x



2x

# 46

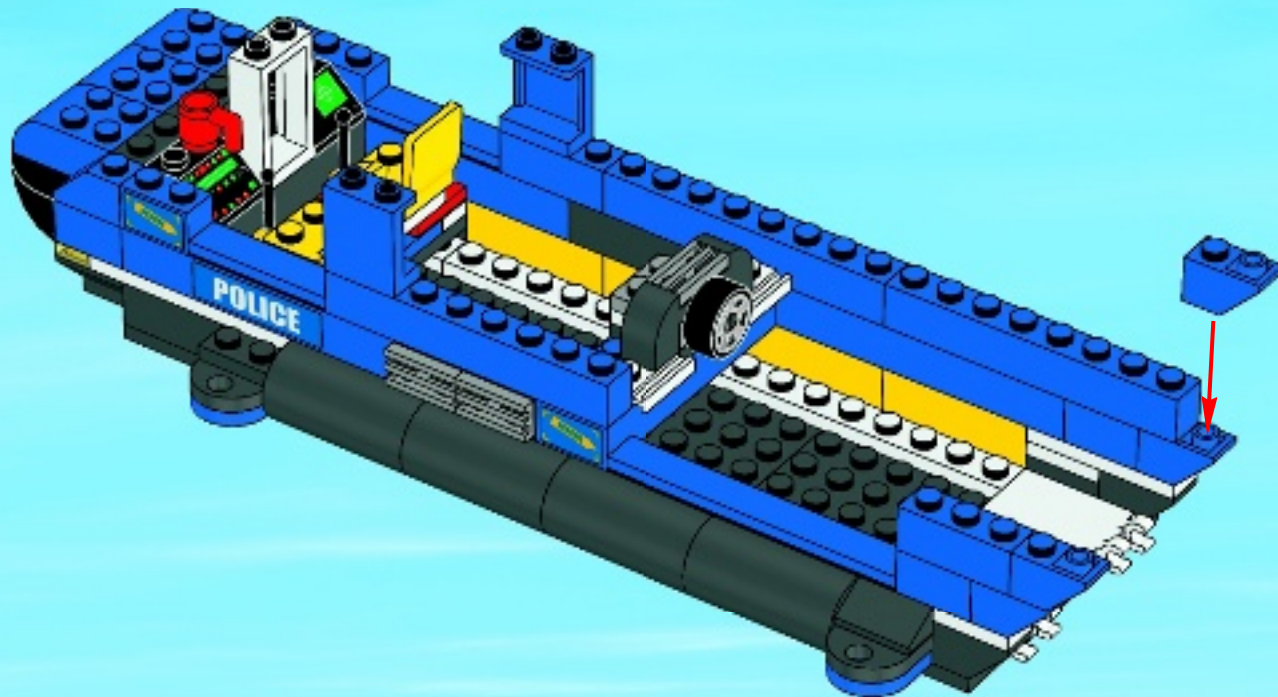

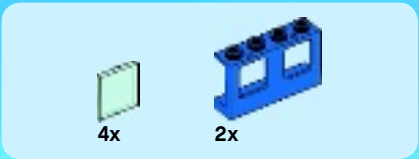

47

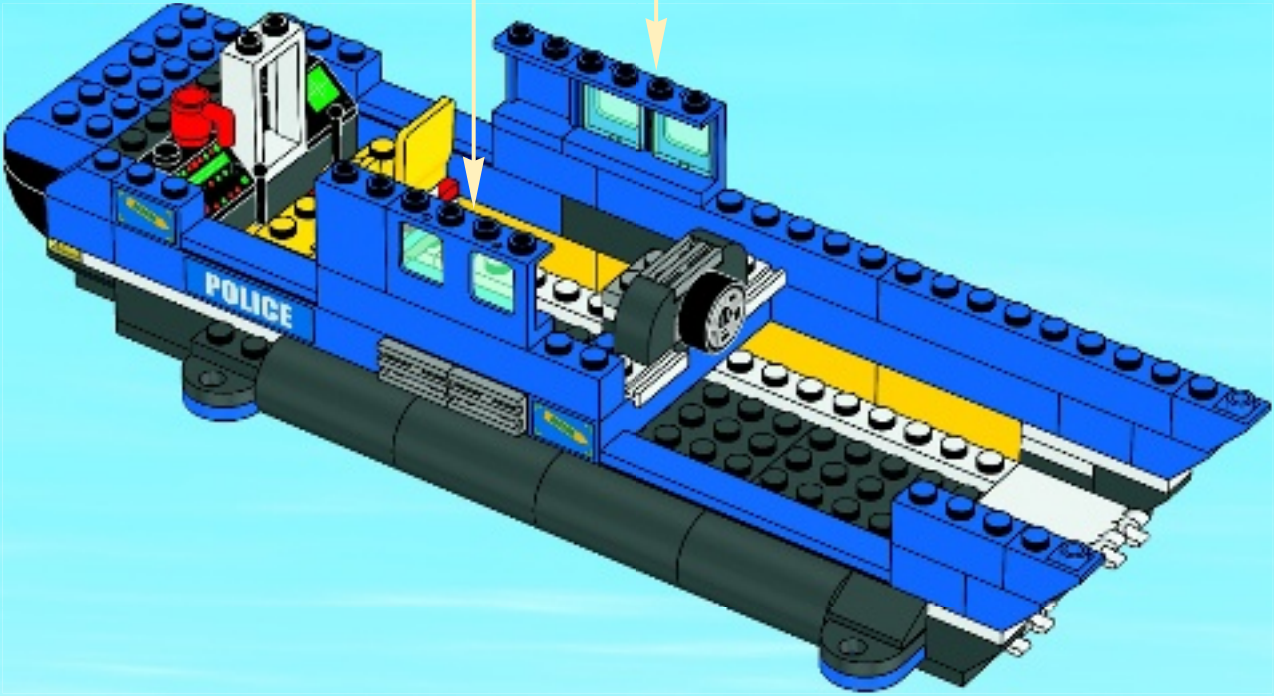
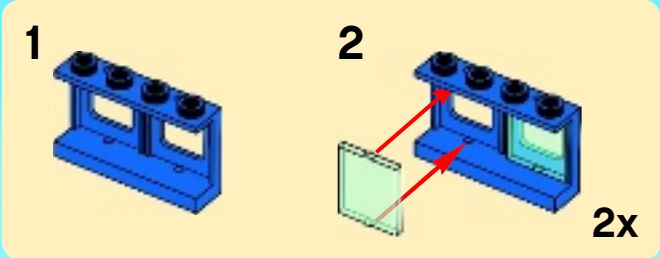





3x

# 48

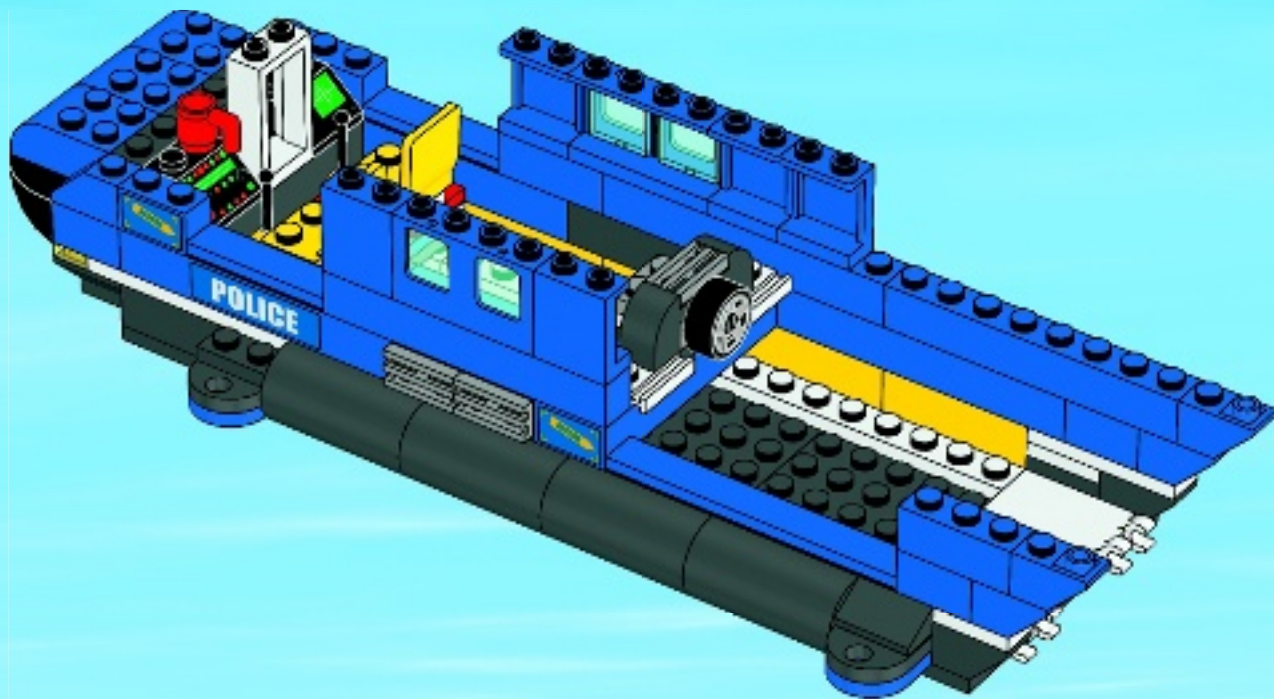

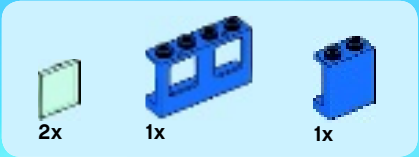

# 49

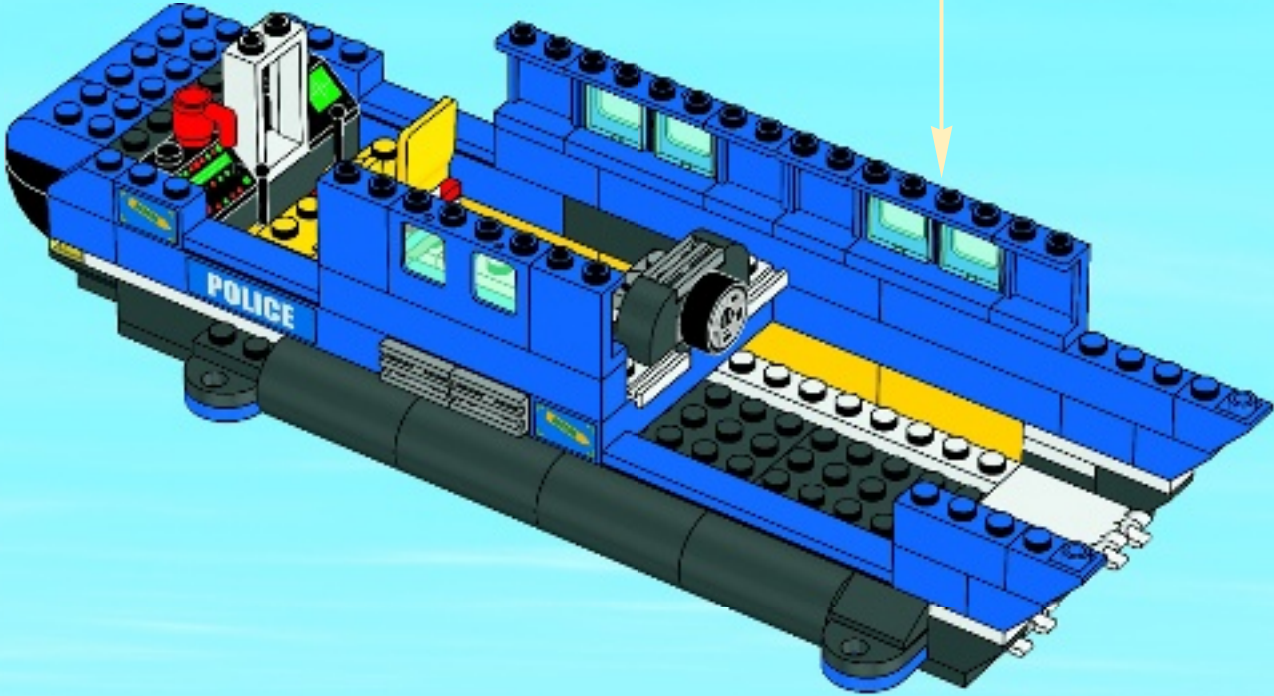
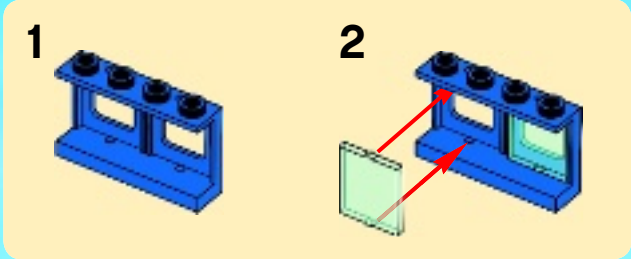

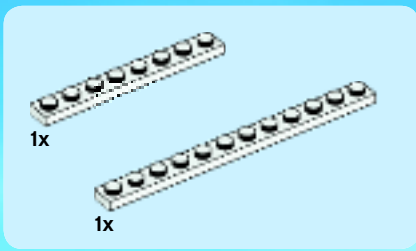

50

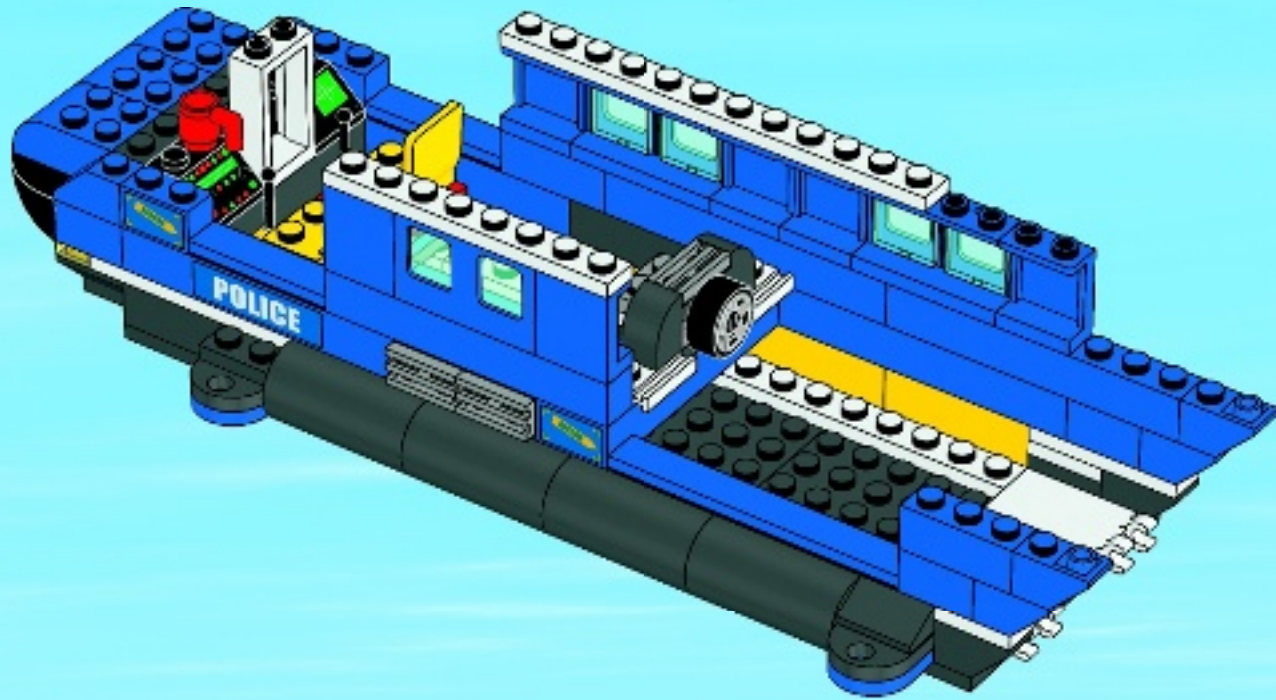



2x

# 51

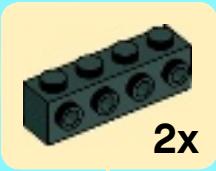
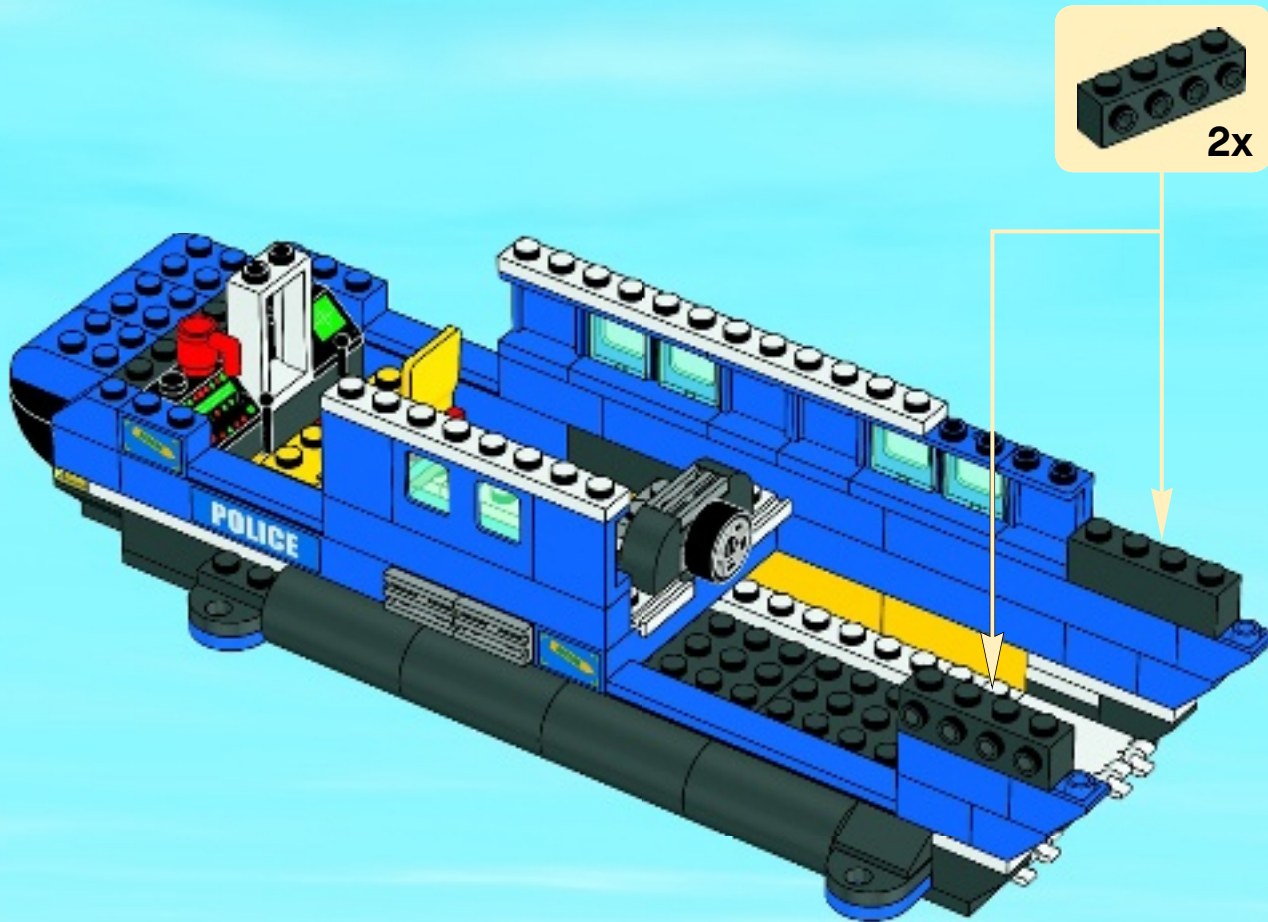



2x

# 52

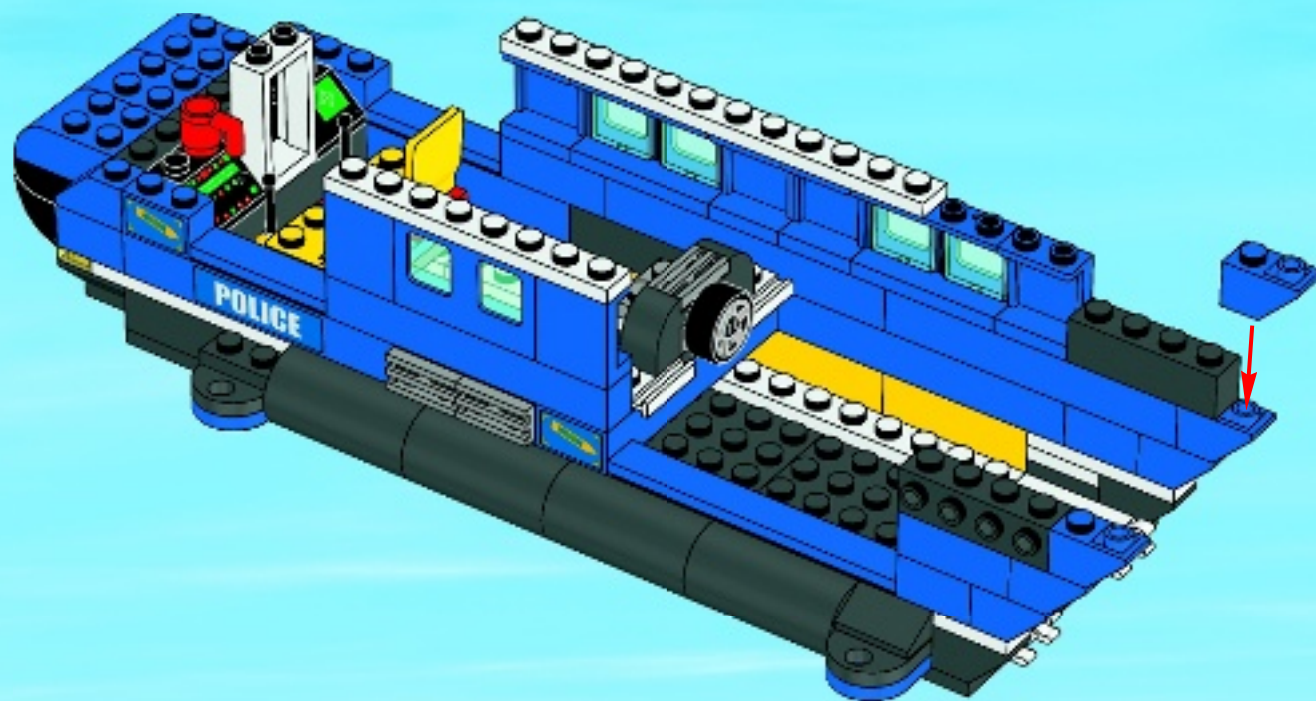

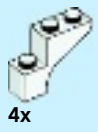

4x

# 53

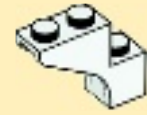

4x

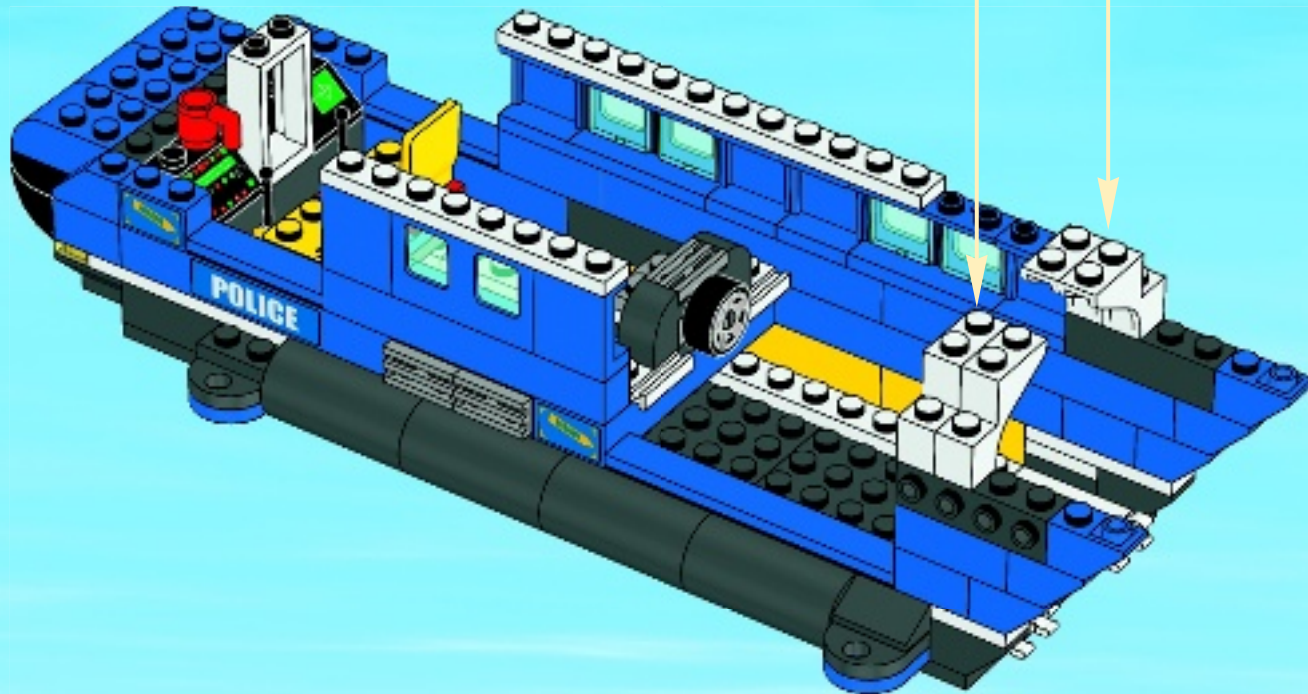



2x

# 54

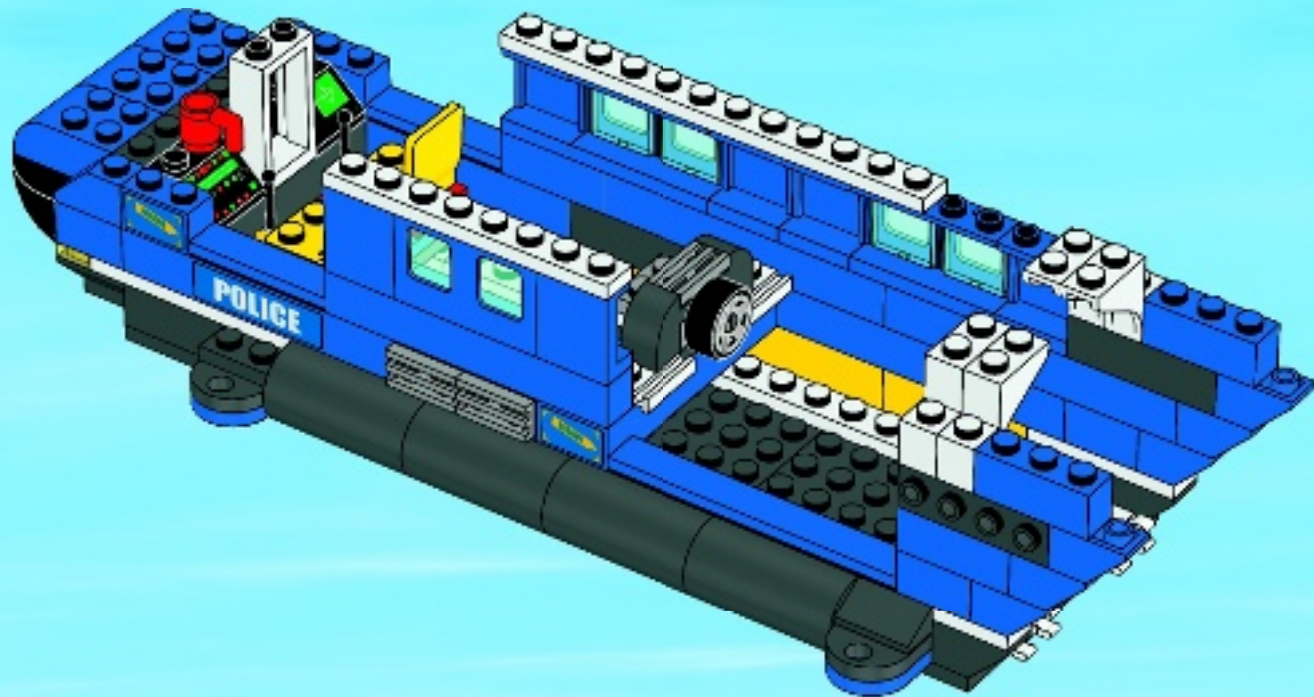



2x

# 55

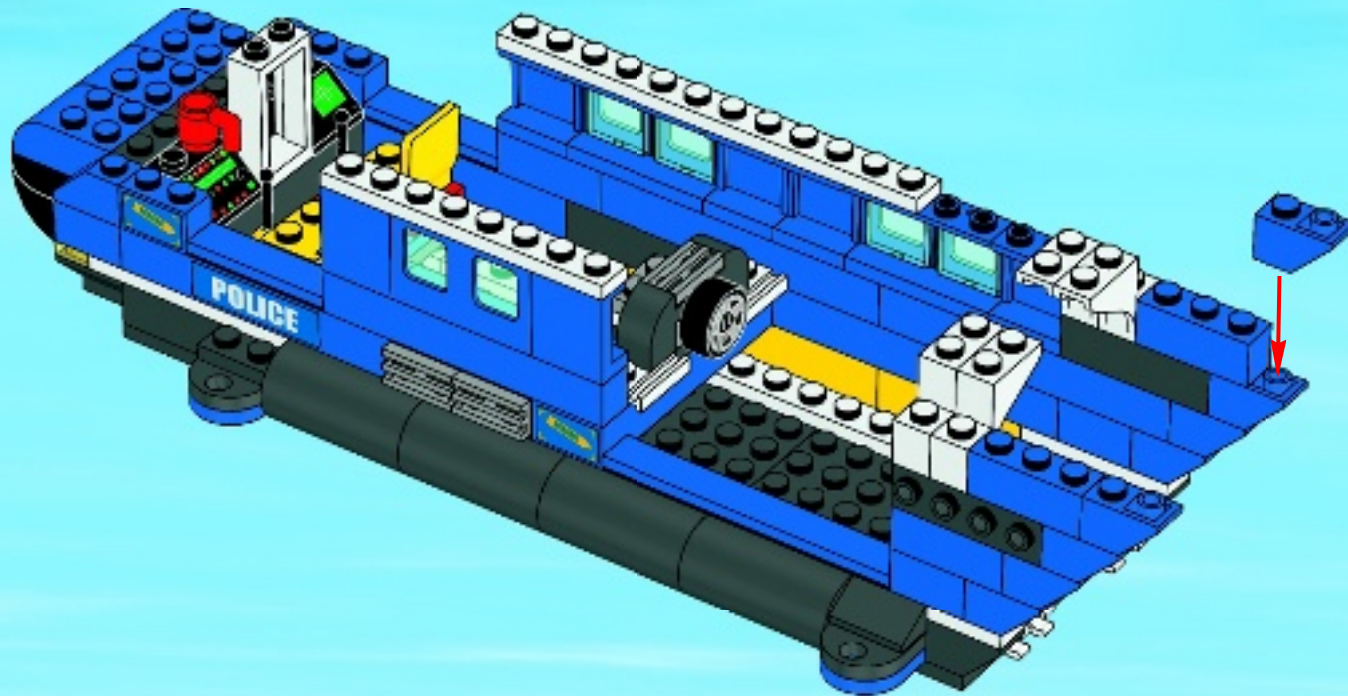



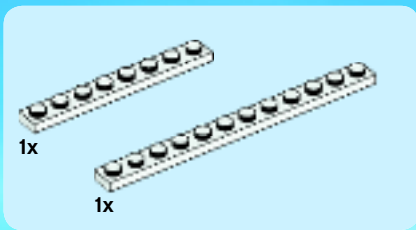

56

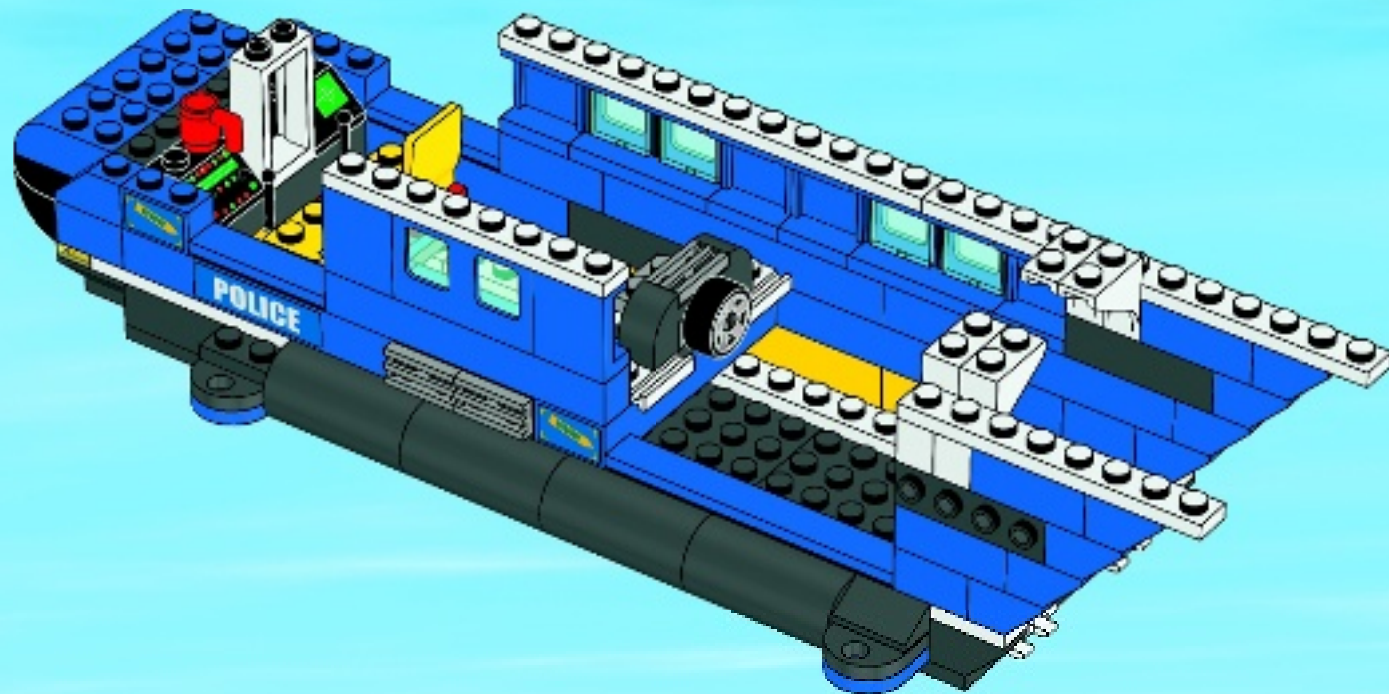

2x



1x



# 57

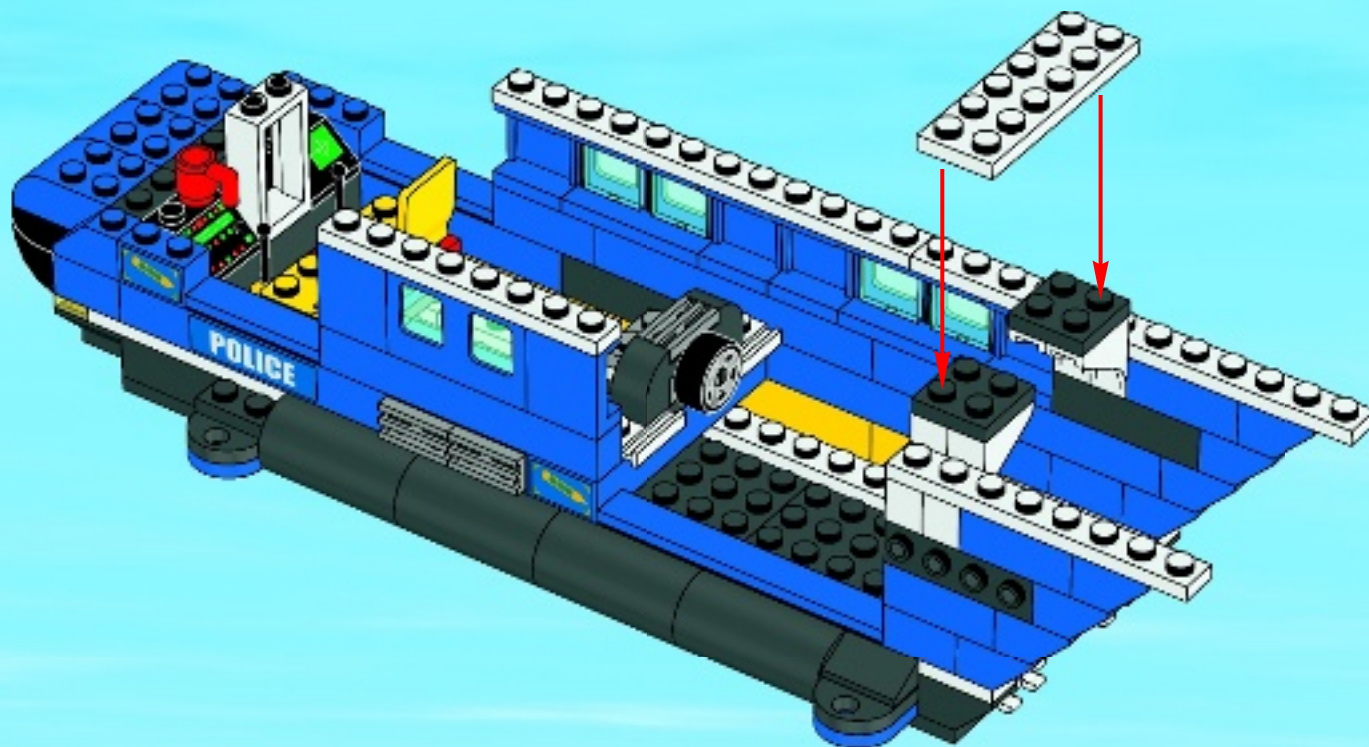



1x

# 58

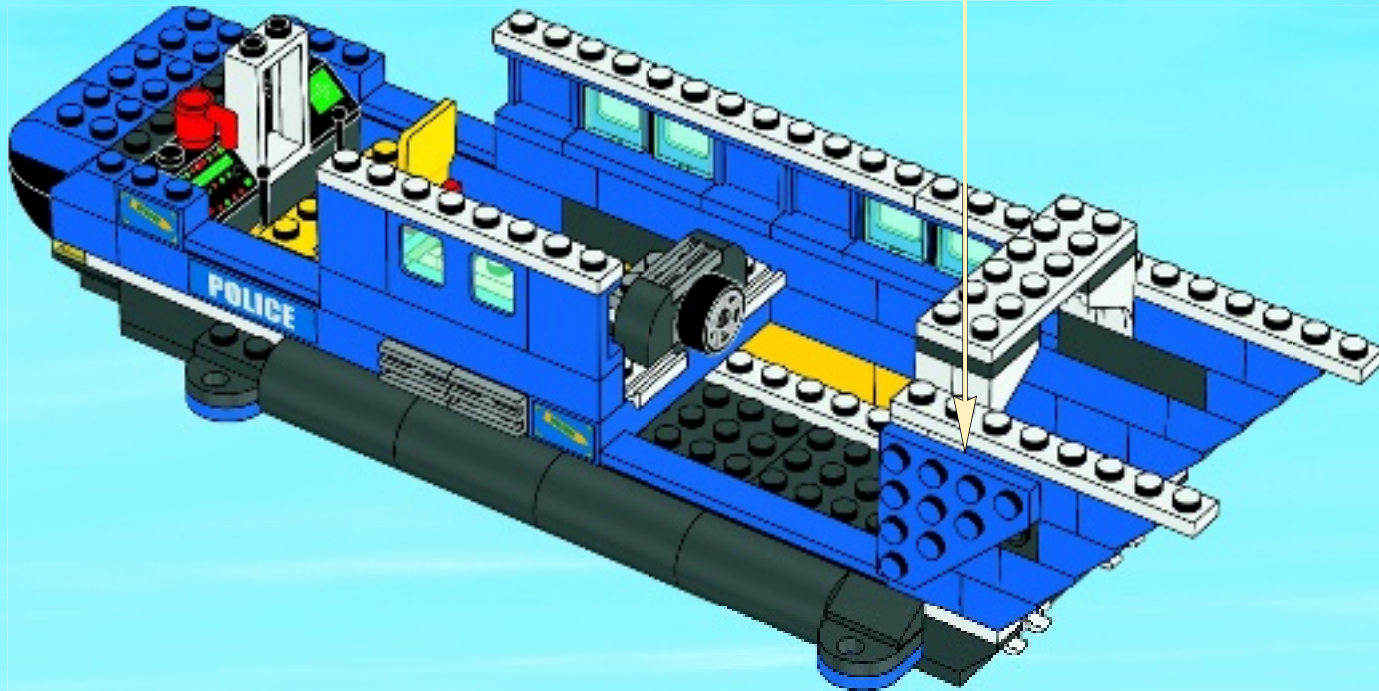
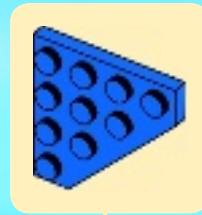



1x

# 59

