



# CITY

4436



**WARNING:** CHOKING HAZARD.  
Small parts. Not for children under 3 years.

1

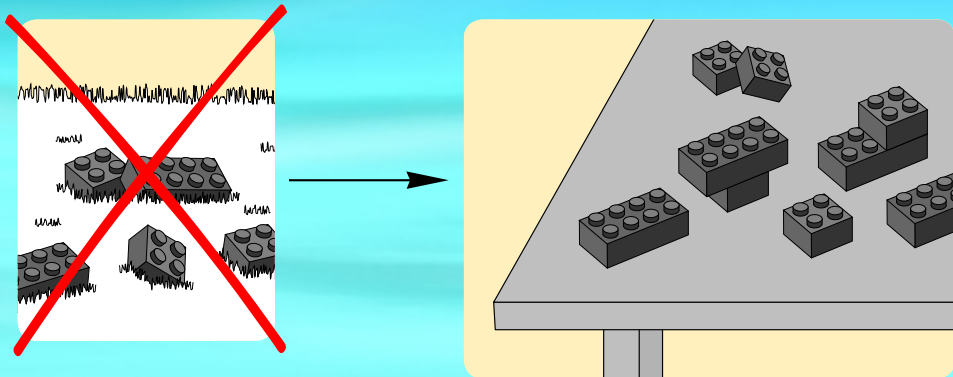

2

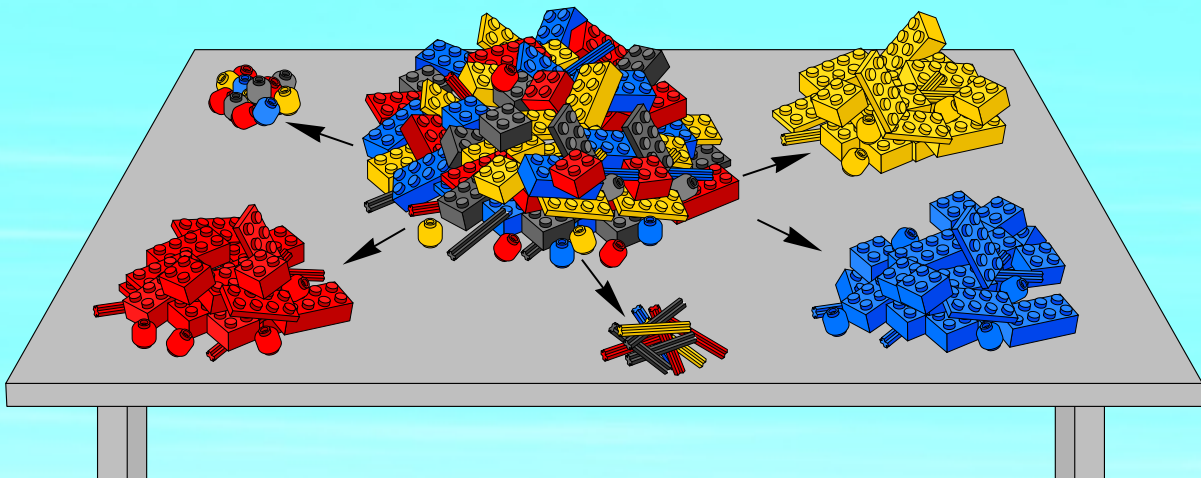

# 3



**AVERTISSEMENT : RISQUE D'ÉTOUFFEMENT.**  
Contient des petites pièces. Ne convient pas aux enfants de moins de 3 ans.



**ADVERTENCIA: PELIGRO DE ASFIXIA.**  
No recomendado para niños menores de 3 años. Contiene piezas pequeñas.





1

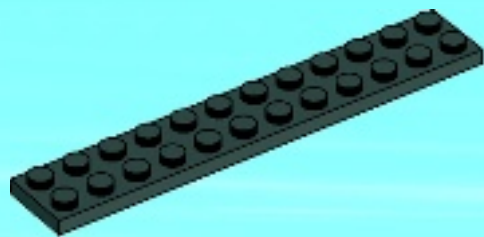

2

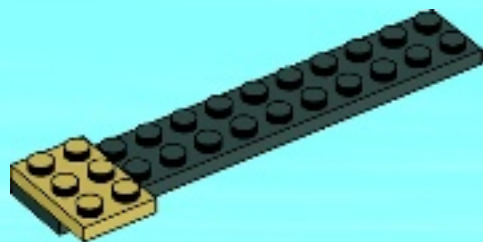

3

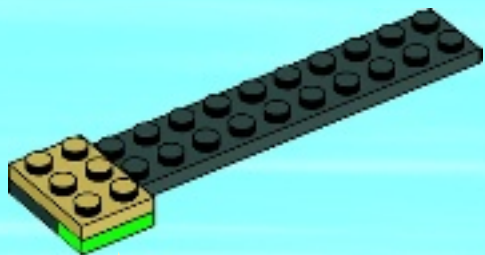

4

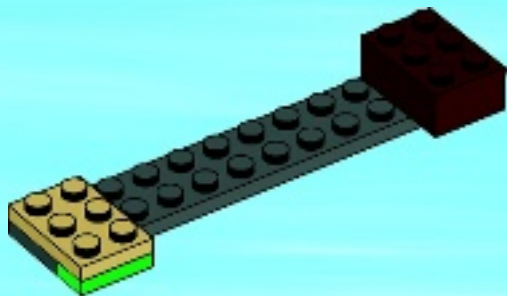

5

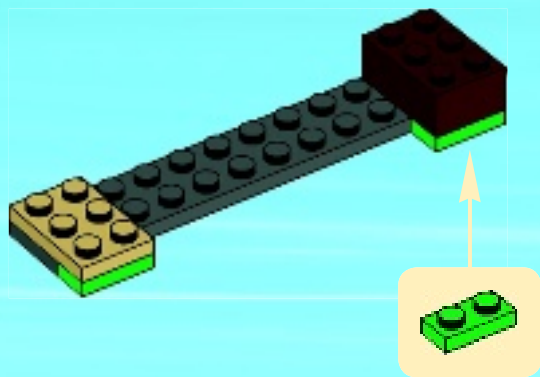

6

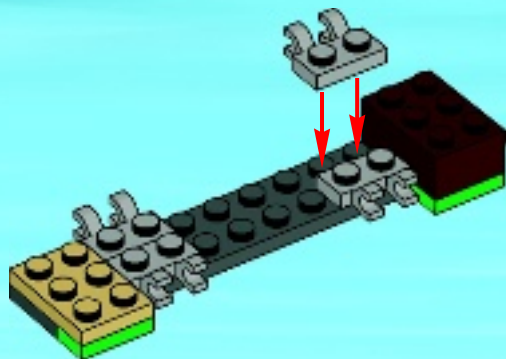

7

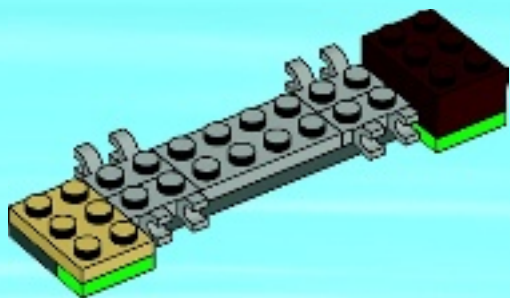

8

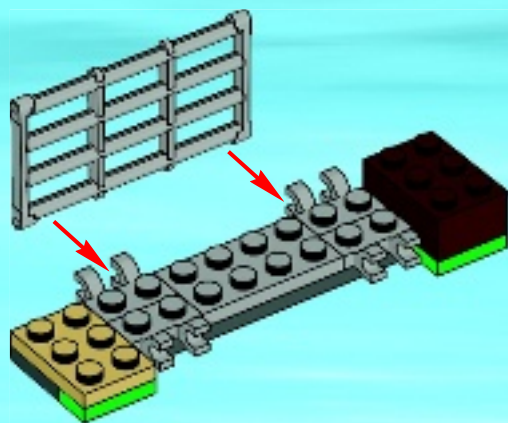



9

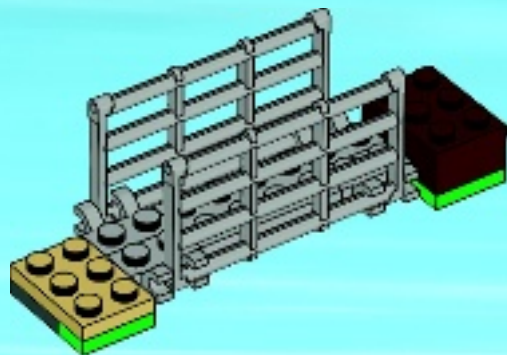

10

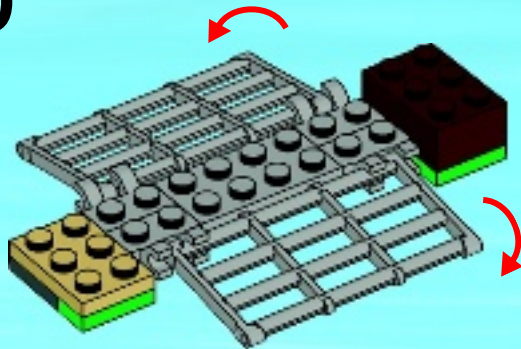



1

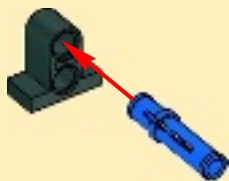

2



3



11

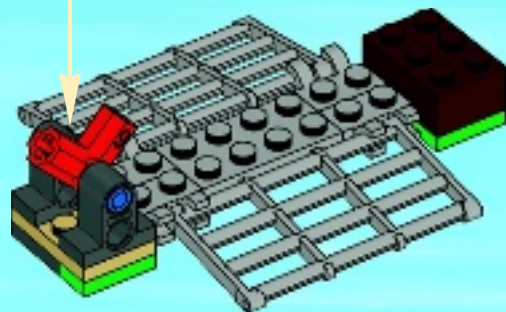

12

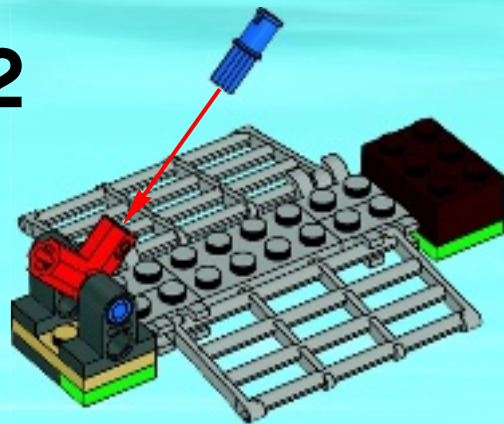

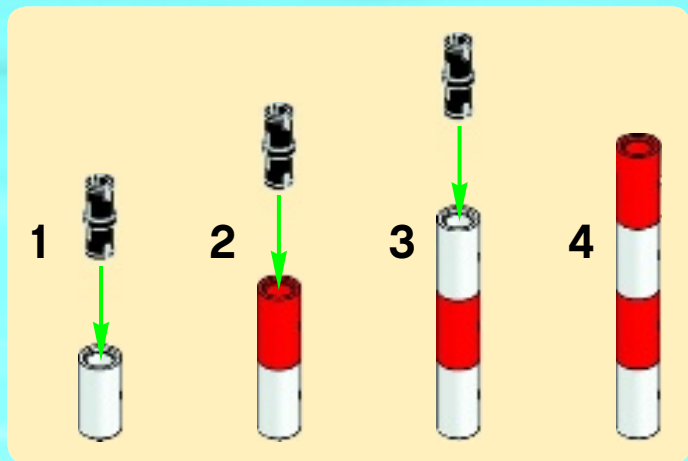

13

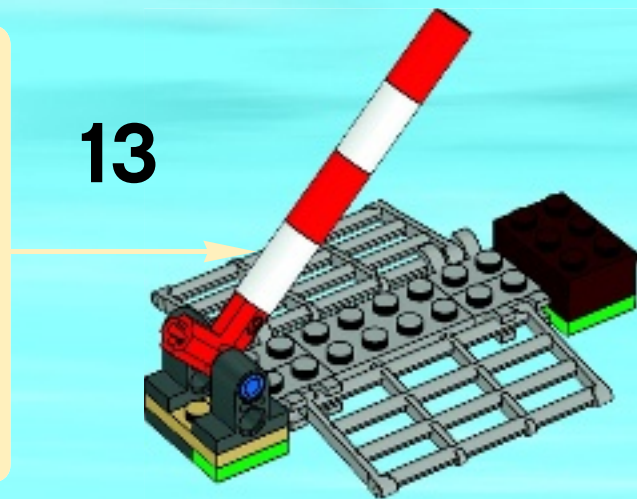

14

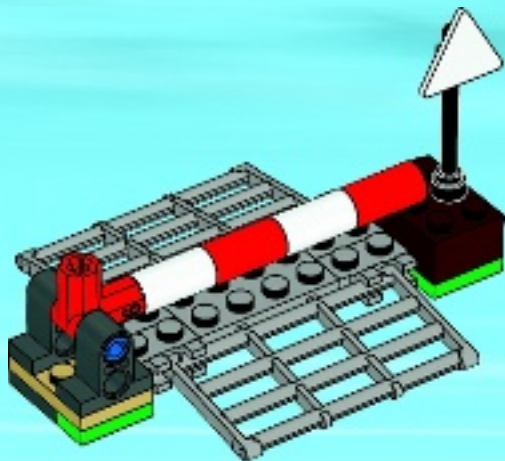

15

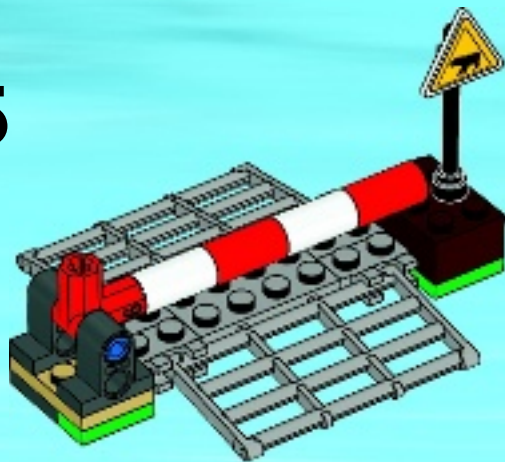



1

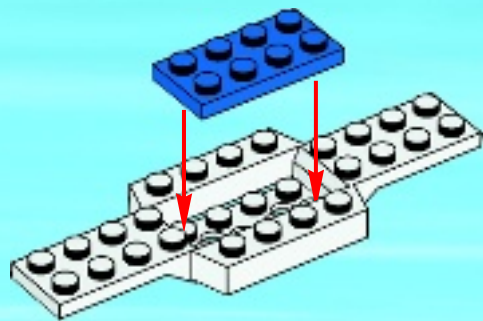

2

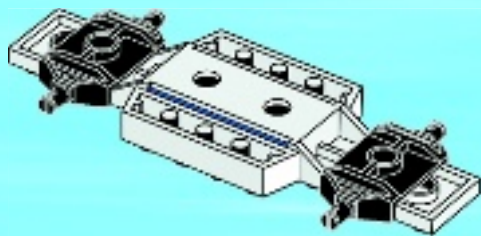

3

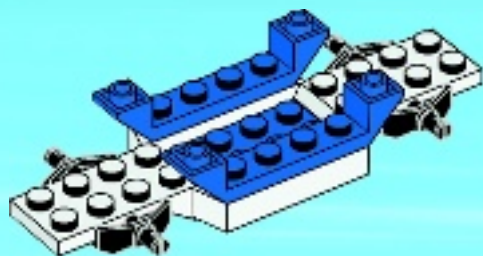

4

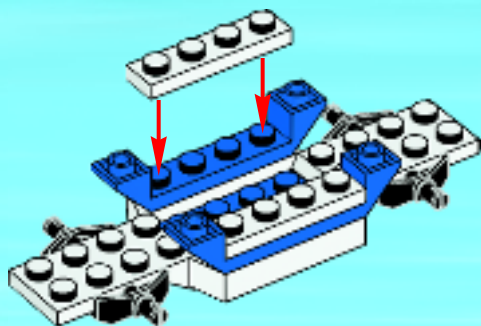

5

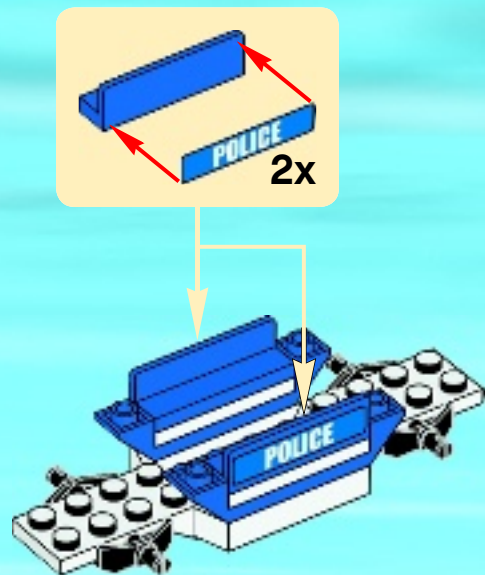

6

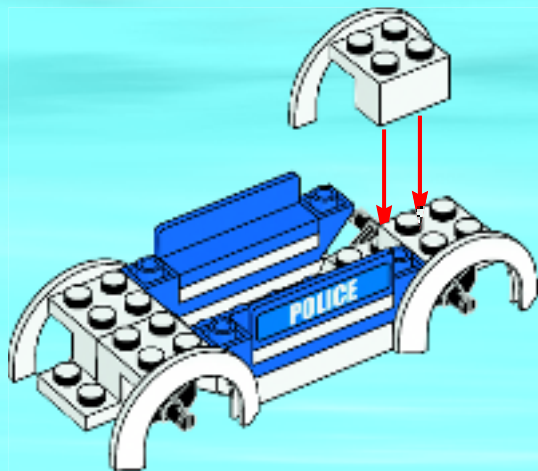



1

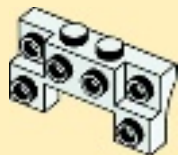

2

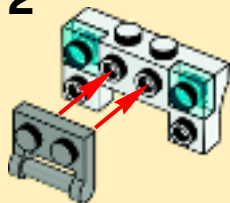

3



4



7



8



9

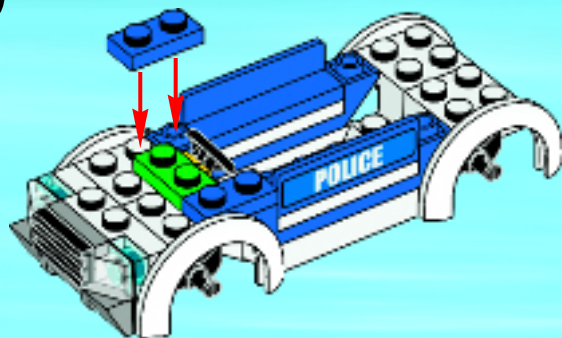

10

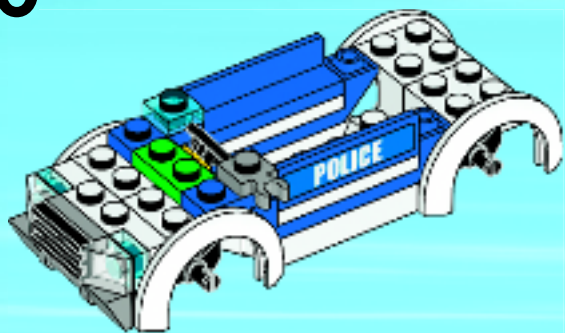

11

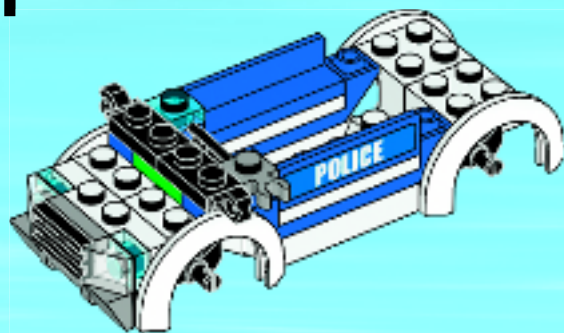

12

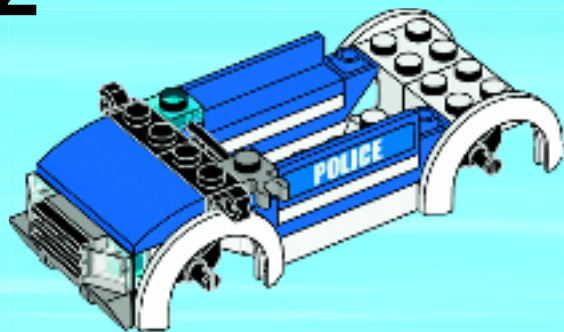

13

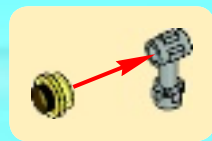
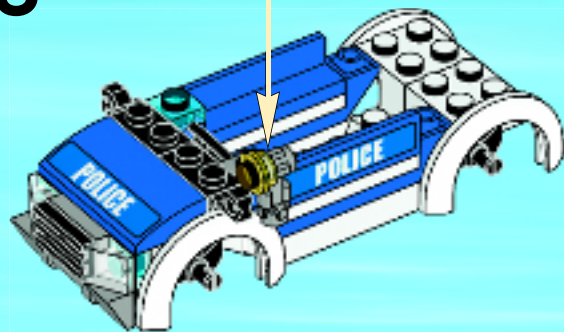

1

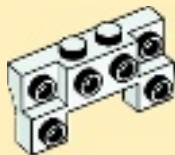

2

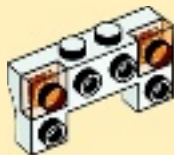

3

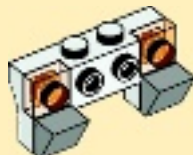

14



15

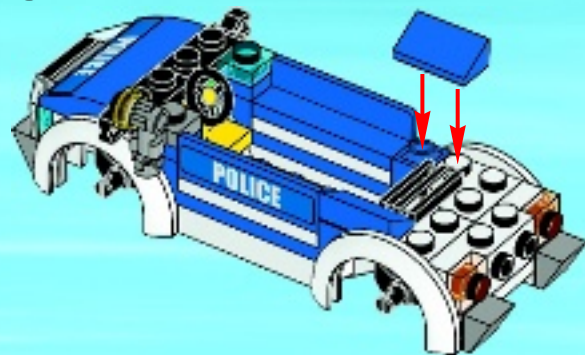

16



17





1



2

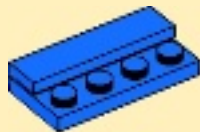

3

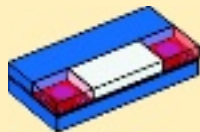

4

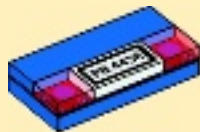

18



19

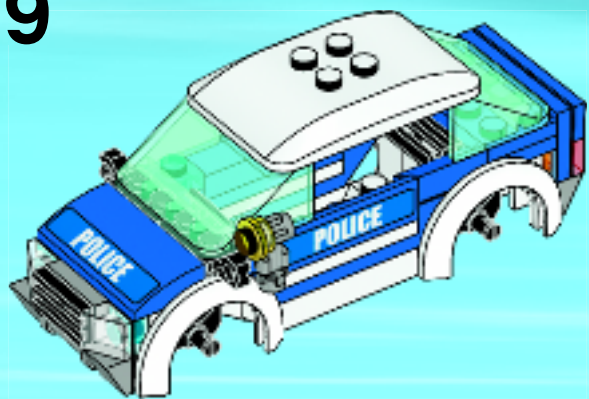

20

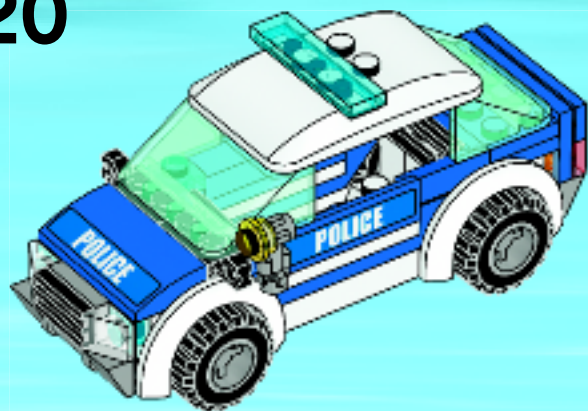

21

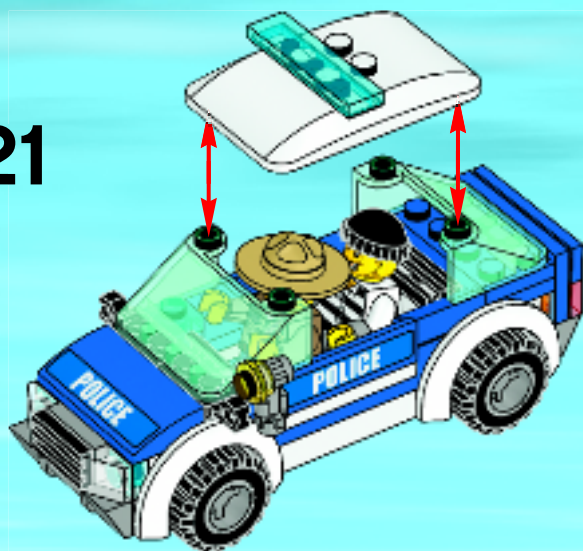

**LEGO CITY**



4440



4439



4441



4437



4436





# CITY



7279



7285



7286



7287



7288



7498

**LEGO** CITY



4209



4208



4427



# CITY



3865  
City Alarm

**6+**  







www.LEGOclub.com



LEGO® Club Email



LEGO® Club Magazine

**LEGO** club™

**FREE! GRATIS! GRATUIT!**

**SIGN UP ONLINE!**

**www.LEGOclub.com**



**00800 5346 5555\***



**1-866-534-6258 • 1-877-518-5346**

US & Canada only

Canada seulement

- \* Freephone. Mobile charges may apply.
- \* Numéro sans frais. Des frais peuvent s'appliquer avec les téléphones cellulaires.
- \* Gebührenfrei, Kosten für Anrufe aus Mobilfunknetzen können abweichen.
- \* Gratis telefoonnummer vanaf vaste lijn.
- \* Det er et gratis nummer, når du ringer fra fasttelefon.
- \* Det är gratis, när du ringer från en fast telefon.
- \* Numéro sans frais. Des frais peuvent s'appliquer avec les téléphones portables.



1x  
4275585



2x  
4259942



2x  
371001



1x  
306901



1x  
4540294



4x  
4259940



1x  
4646574

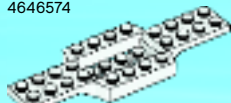

1x  
4651235



2x  
4526981



1x  
4118790



1x  
4648681



1x  
4162916



1x  
4189131



2x  
4526984



2x  
4651236



2x  
4294738



2x  
302323



4x  
302023



1x  
243123



2x  
4522164



1x  
4651237



1x  
4206482



1x  
4514553



1x  
4194017



1x  
4259915



1x  
9553



2x  
241226



2x  
4183043



1x  
395726



1x  
4157108



4x  
4568644



2x  
615726



3x  
4121715



3x  
302328



1x  
4651201



1x  
4216668



4x  
4521921



1x  
4211395



1x  
4594238



4x  
4556157



1x  
4244627



1x  
4641048



1x  
4640844



4x  
4211764



2x  
4599496



2x  
4542673



2x  
4498374



2x  
4210763



1x  
4222693



1x  
4211067



2x  
4244362



2x  
3003941



1x  
3005744



3x  
4266417



1x  
4590989



Customer Service

Kundenservice

Service Consommateurs

Servicio Al Consumidor

[www.lego.com/service](http://www.lego.com/service) or dial



: 00800 5346 5555

: 1-800-422-5346



# WIN!

Go to [www.LEGOsurvey.com/product](http://www.LEGOsurvey.com/product) to fill out a survey for a chance to win a cool LEGO® Product.

No purchase necessary.

Open to all residents where not prohibited.



## [www.LEGOsurvey.com/product](http://www.LEGOsurvey.com/product)

### GEWINNE!

Nimm an der Umfrage auf [www.LEGOsurvey.com/product](http://www.LEGOsurvey.com/product) teil und hab die Chance ein cooles LEGO® Produkt zu gewinnen!

Die Teilnahme am Gewinnspiel führt zu keinerlei Kaufverpflichtungen. Teilnahme in allen nicht ausgeschlossenen Ländern möglich.

### WIN!

Ga naar [www.LEGOsurvey.com/product](http://www.LEGOsurvey.com/product), vul een enquêteformulier in en maak kans op een cool LEGO® product.

Geen aankoopverplichting. Iedereen mag deelnemen, uitgezonderd ingezetenden van landen waar een enquêteverbod geldt.

### GAGNE!

Visite [www.LEGOsurvey.com/product](http://www.LEGOsurvey.com/product) pour répondre à un questionnaire et avoir une chance de gagner un produit LEGO® très cool!

Aucune obligation d'achat. Ouvert à tous les résidents des pays autorisés.

### 当てよう!

[www.LEGOsurvey.com/product](http://www.LEGOsurvey.com/product) にアクセスして、アンケートにご記入ください。当選者にはレゴ®製品を差し上げます。

お買い上げの必要はありません。禁止されていない限り、すべての皆様にご利用いただけます。



[www.LEGO.com](http://www.LEGO.com)

6020957

LEGO and the LEGO logo are trademarks of the/son des marques de commerce de/son marcas registradas de LEGO Group. ©2012 The LEGO Group.