



Disney

43249



Q LEGO® Builder



Get excited about our new packaging!

We're switching from plastic to paper-based packaging. That's why you might find a mix of paper and plastic in our boxes!

Nos nouveaux emballages vous emballeront !

Nous passons des emballages en plastique aux emballages à base de papier. C'est pourquoi vous pourriez trouver un mélange de papier et de plastique dans nos boîtes !

¡Te presentamos nuestros nuevos empaques!

Estamos sustituyendo las bolsas de plástico por bolsas con base de papel. ¡Por eso, puedes encontrar una mezcla de papel y de plástico en nuestras cajas!

[LEGO.com/sustainable-packaging](https://www.lego.com/sustainable-packaging)

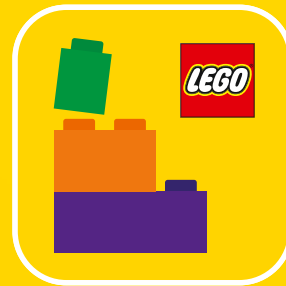

BUILDER



Apple and the Apple logo are trademarks of Apple Inc., registered in the U.S. and other countries and regions. App Store is a service mark of Apple Inc. Google Play and the Google Play logo are trademarks of Google LLC. Tencent and the Tencent logo are trademarks of Tencent Inc.

LEGO.com/devicecheck

EN Ask parents' permission before going online | DE Eltern um Erlaubnis bitten, bevor du online gehst | FR Demande l'autorisation d'un parent avant d'aller en ligne | IT Chiedi il permesso ai tuoi genitori prima di andare online | ES Pídeles permiso a tus papás antes de conectarte a Internet | PT Peça autorização aos pais antes de acederes online | ZH 上网前应先征得父母的同意 | PL Poproś rodziców o zgodę, zanim wejdiesz do Internetu | CS Než půjdeš na internet, požádej rodiče o svolení | SK Skôr než pôjdeš na internet, vypýtaj si povolenie od rodičov | HU Kérj szülői engedélyt, mielőtt online csatlakoznál! | RO Cere permisiunea părinților înainte de a te conecta online | BG Поискайте разрешение от родител, преди да влезете онлайн | LV Pirms došanās tiešsaistē palūdz atļauju vecākiem | ET Enne Interneti kasutamist küsi vanematelt luba | LT Prieš prisijungdami prie interneto, atsklauskite tėvų

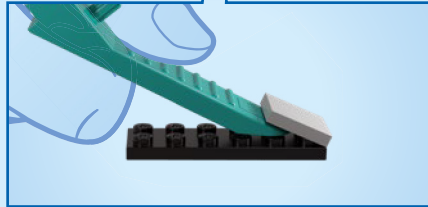
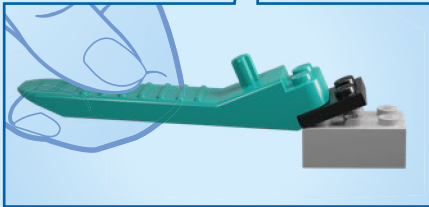
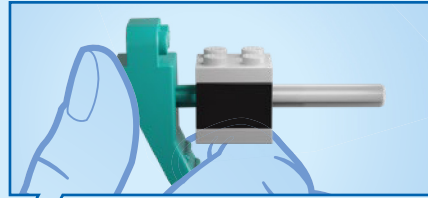
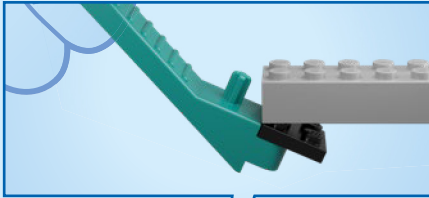

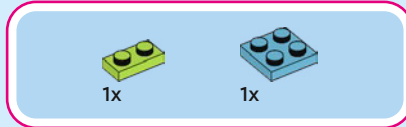

1

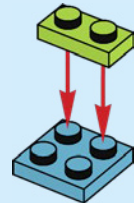



1x

2

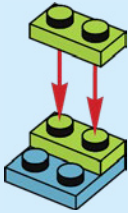

1x



1x

3

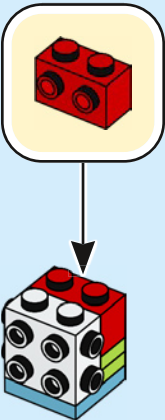

2x

4

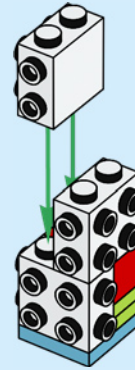

2x

5

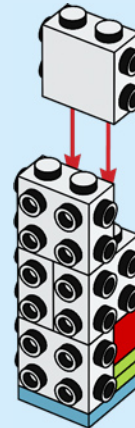

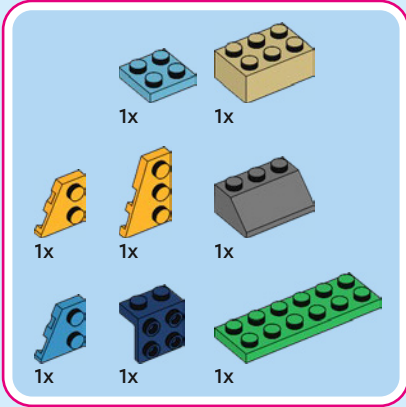
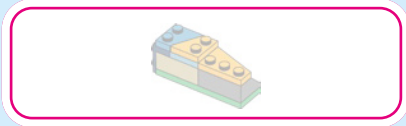

6

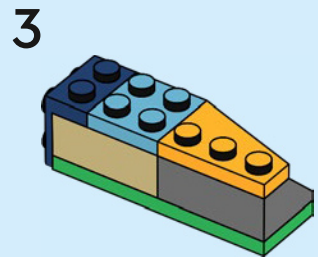
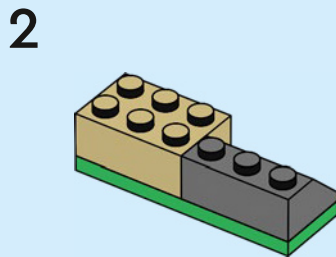
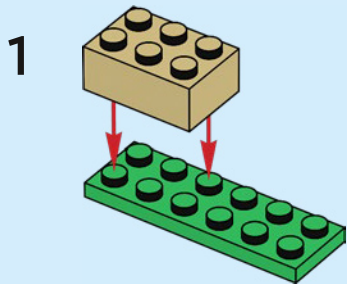

4

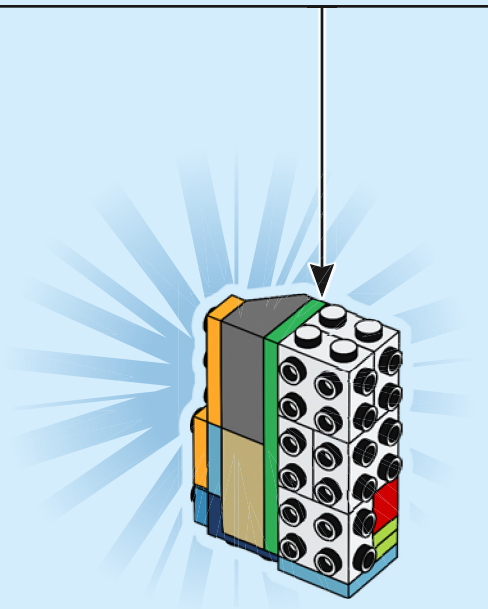
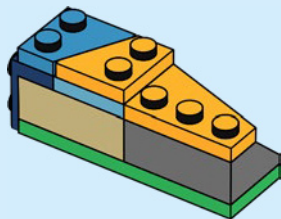

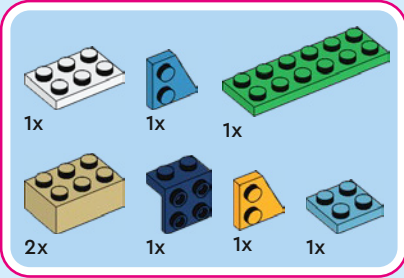
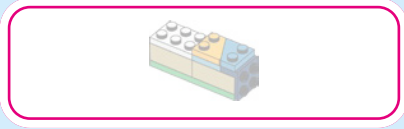

7

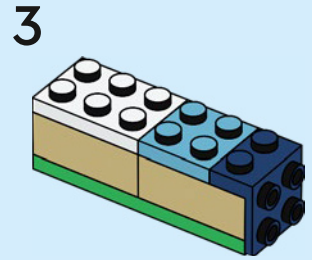
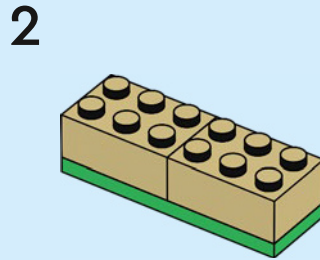
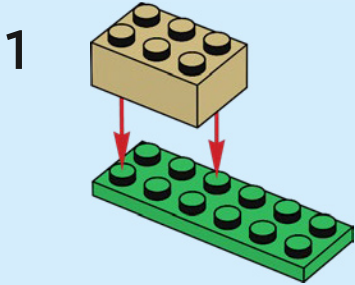

4

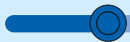
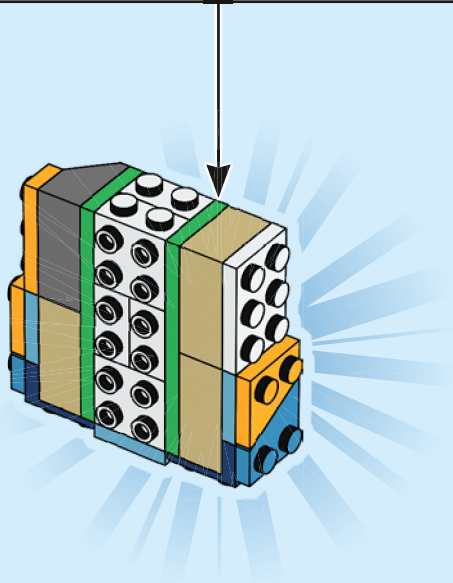
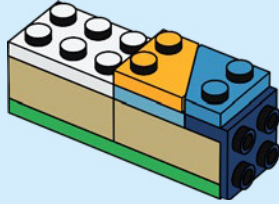

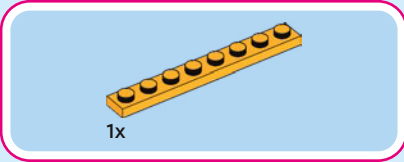
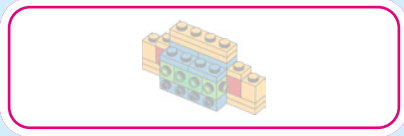

1x

8

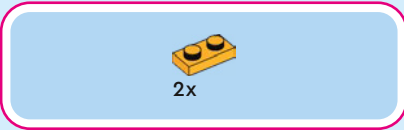
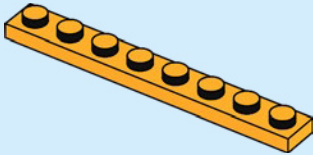

2x

9

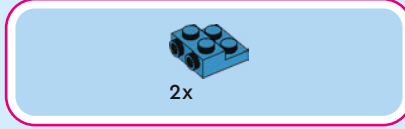
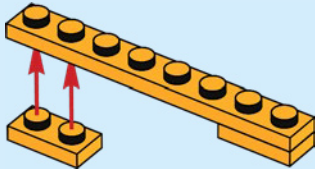

2x

10

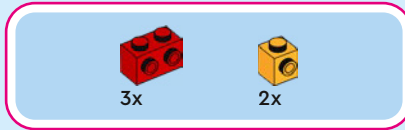
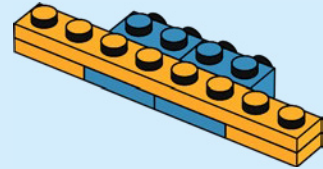

3x

2x

11

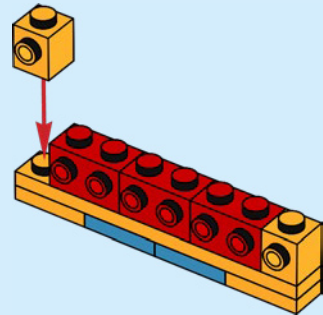



1x

12

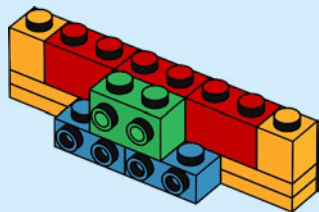

2x

13

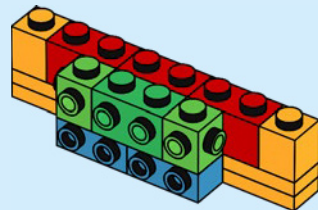

2x

14

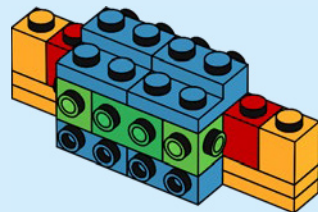



15

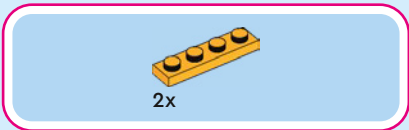
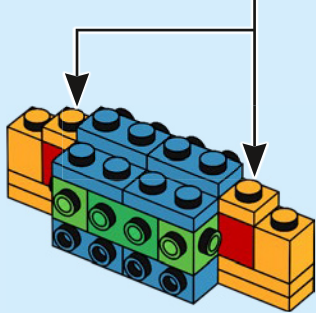

16

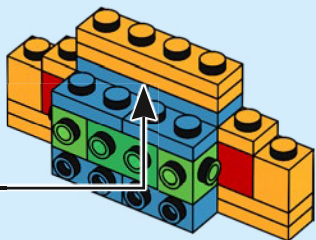
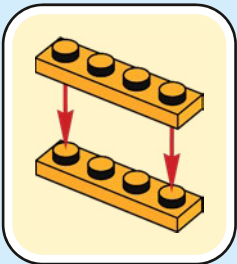

17

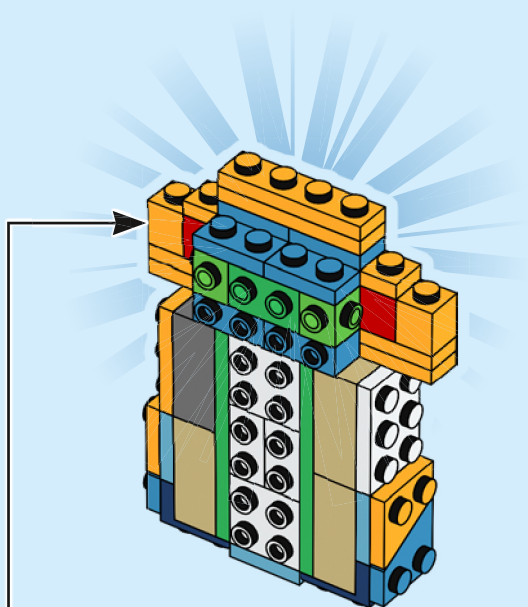

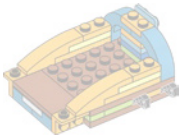

2x

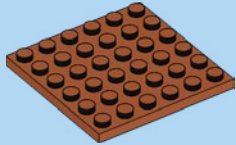

1x

18

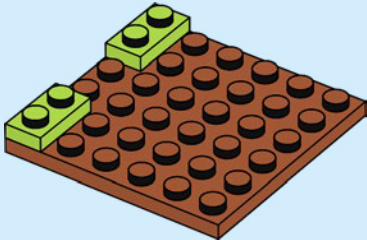

2x

19

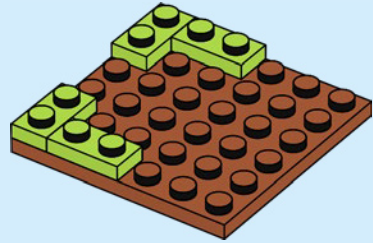

1x



2x



4x

20

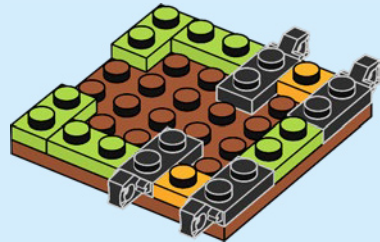

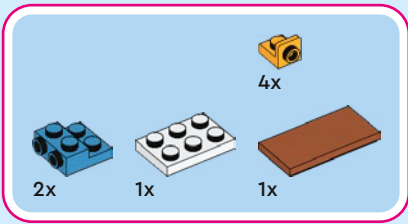

21

1



2

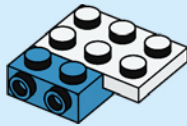

3

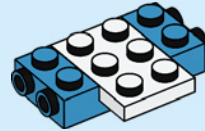

4

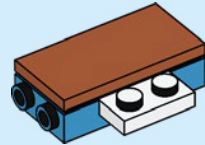

5

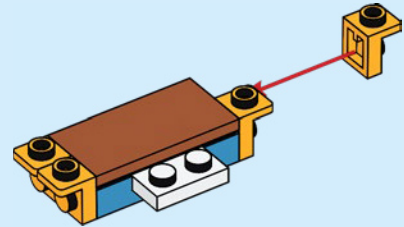

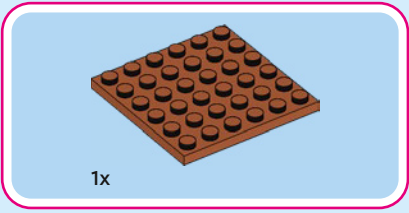

22

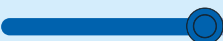
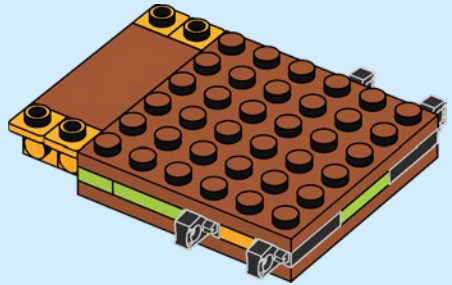
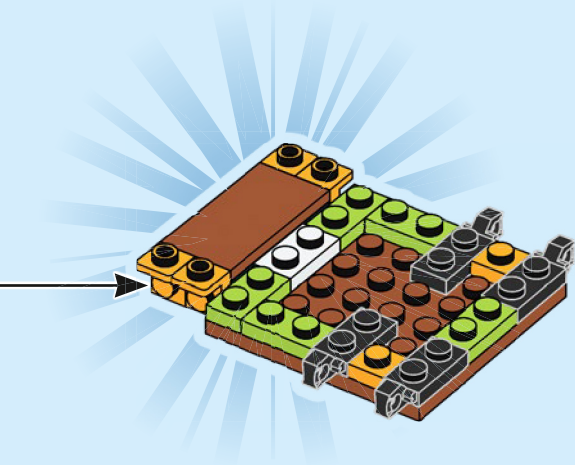



23

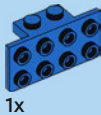
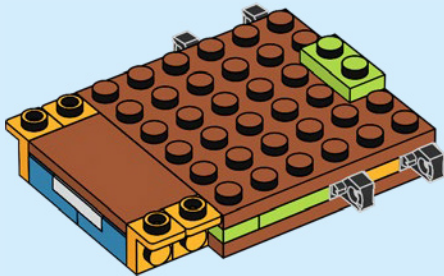

24

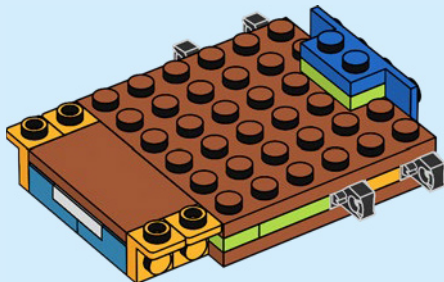

25

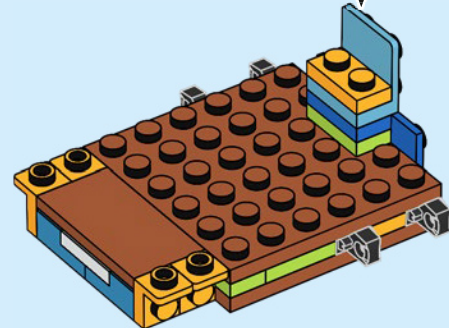
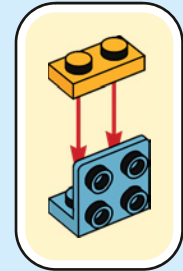

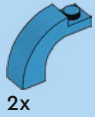

2x

26

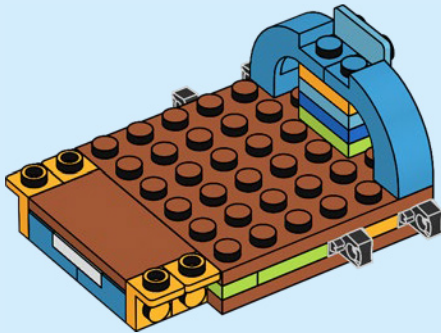

1x

27

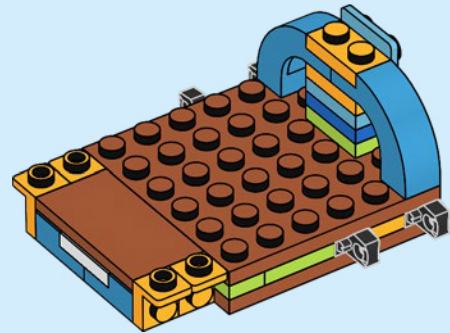

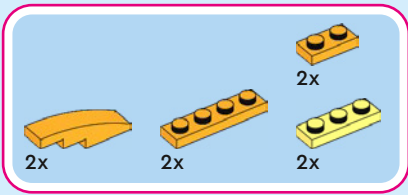

28

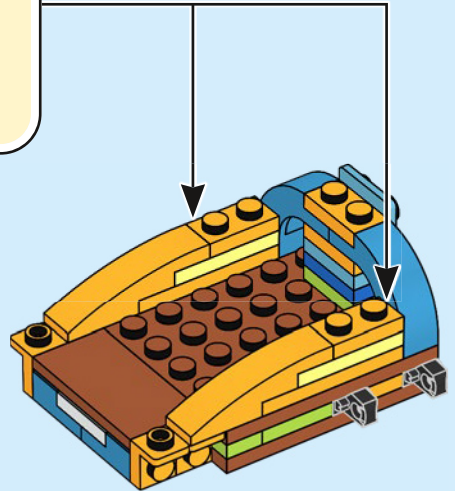
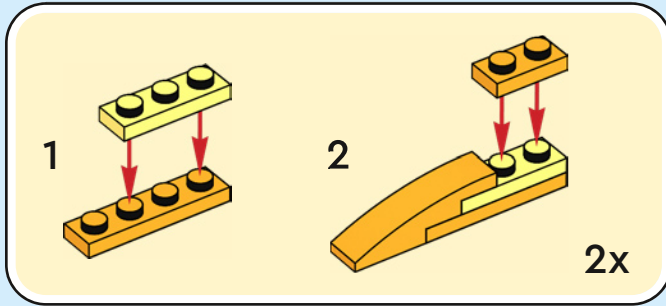

29

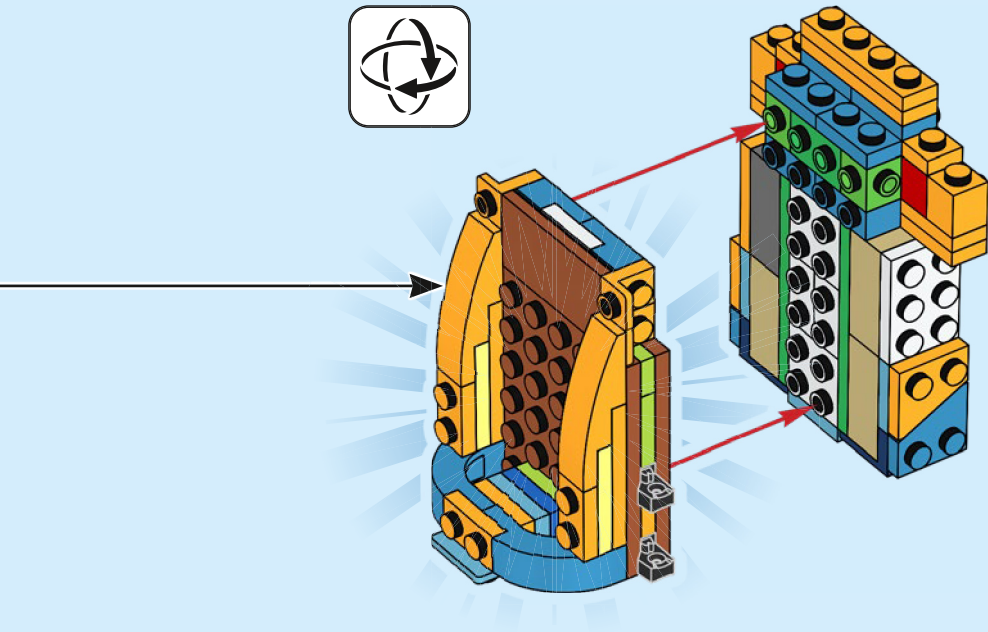
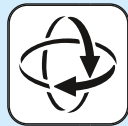

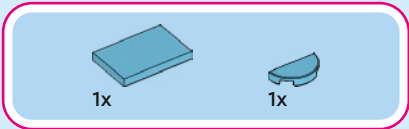

30

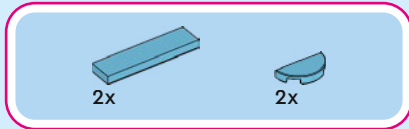
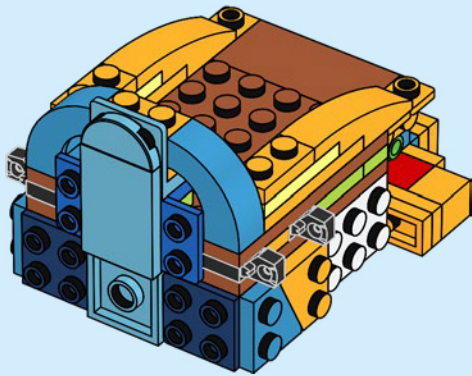

31

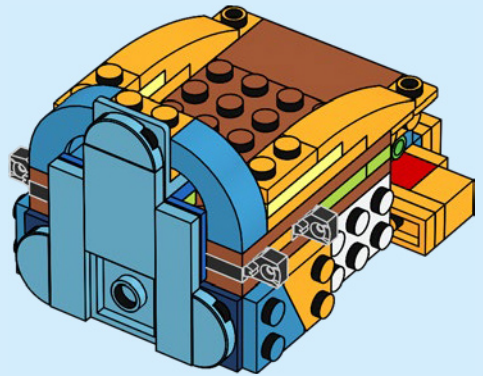

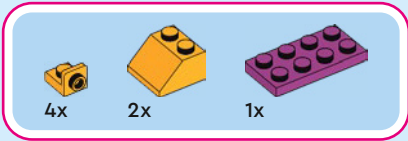

32

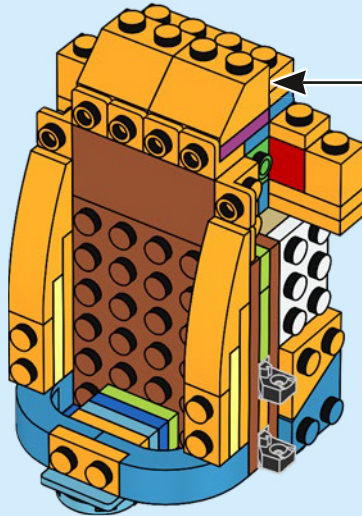
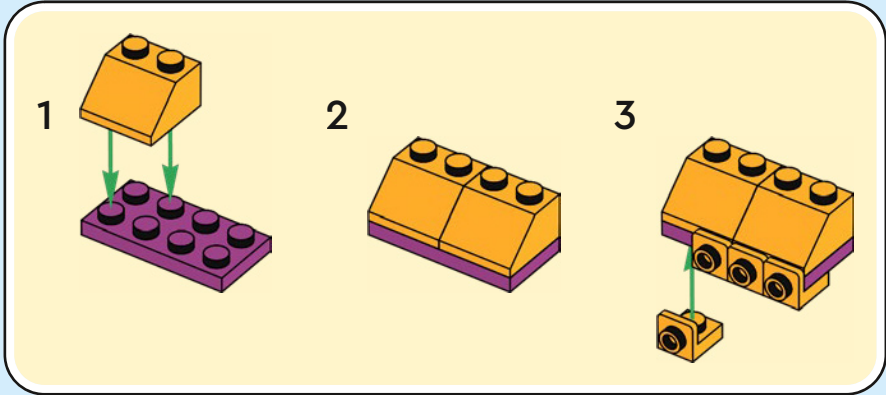

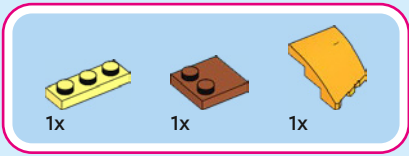

33

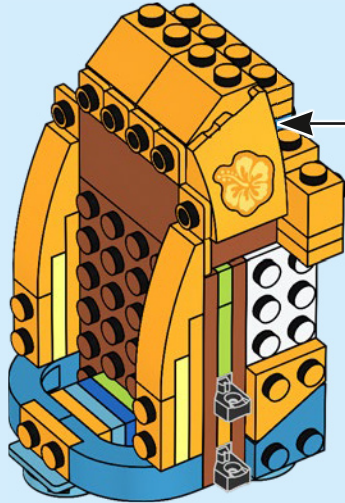
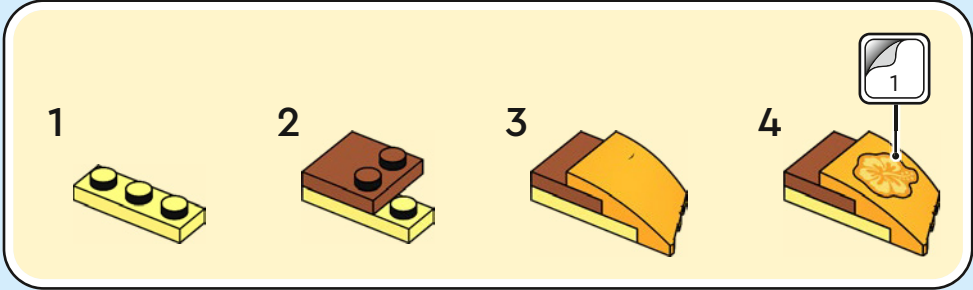

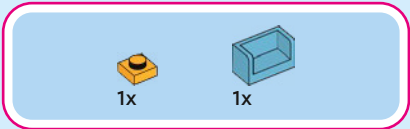

34

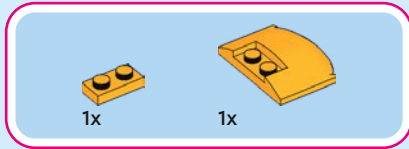
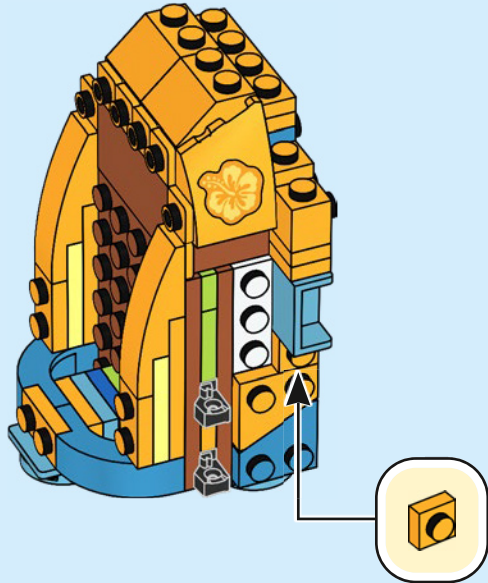

35

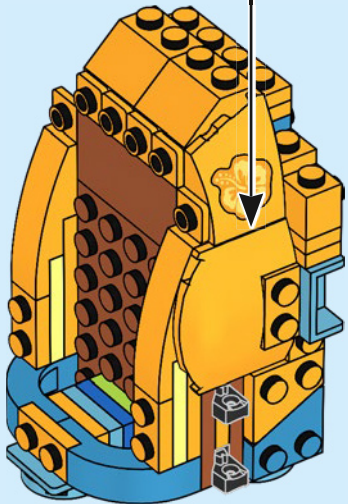
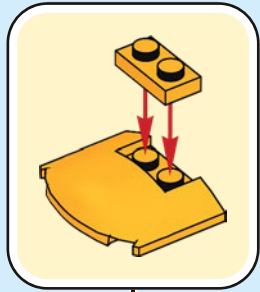

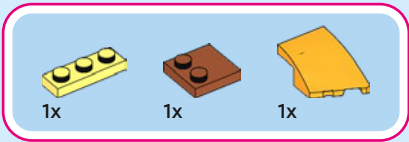

36

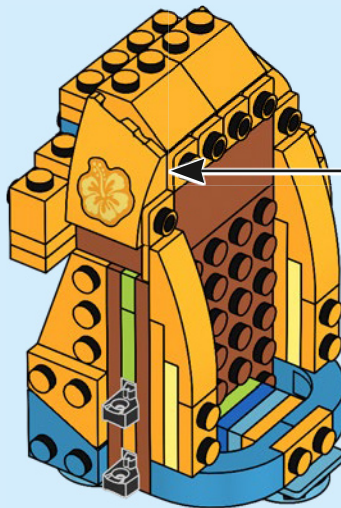
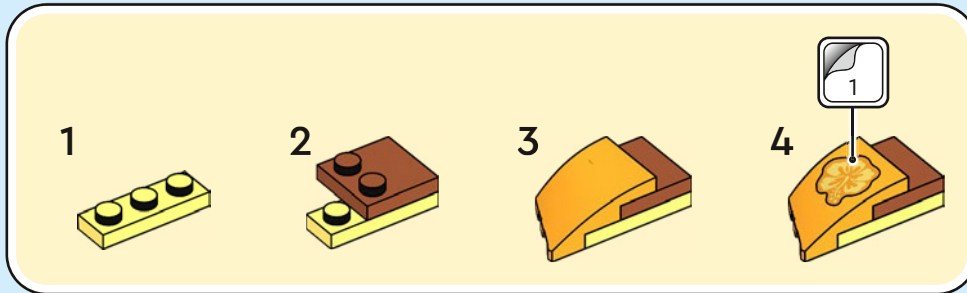

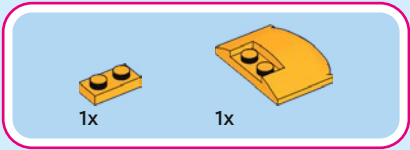

37

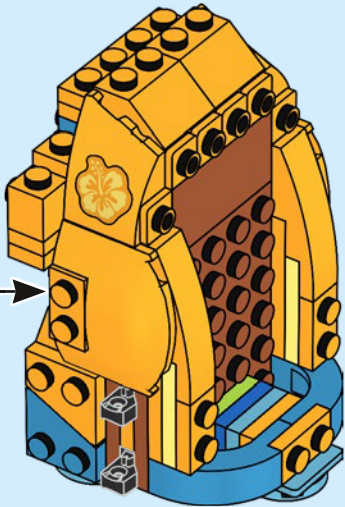
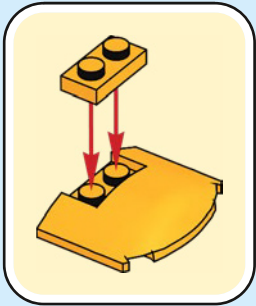

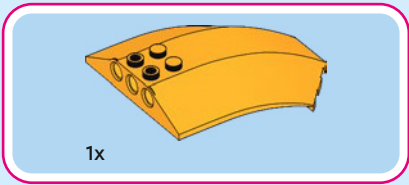

38

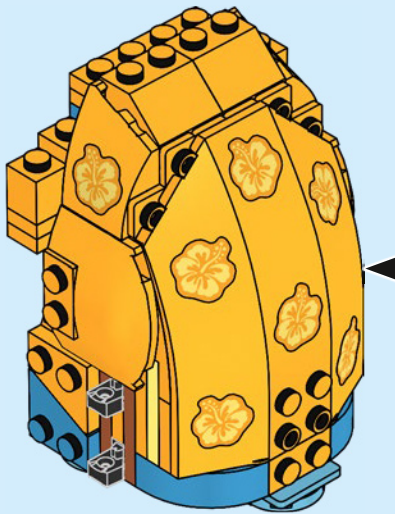
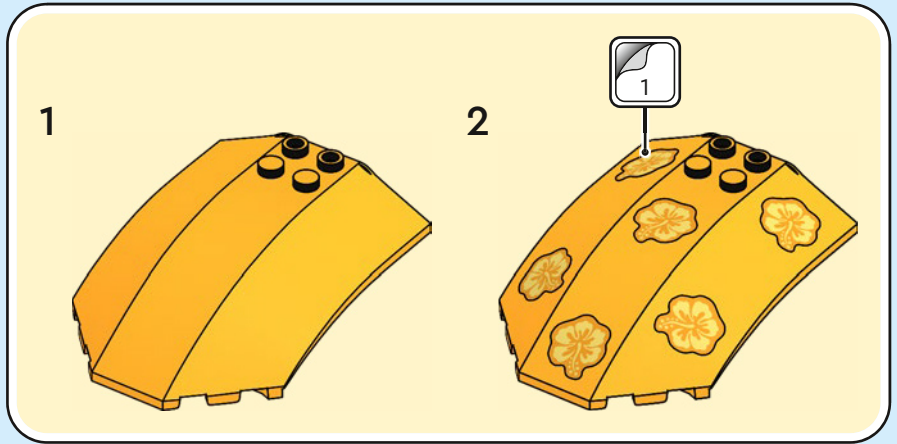



3x



1x

39

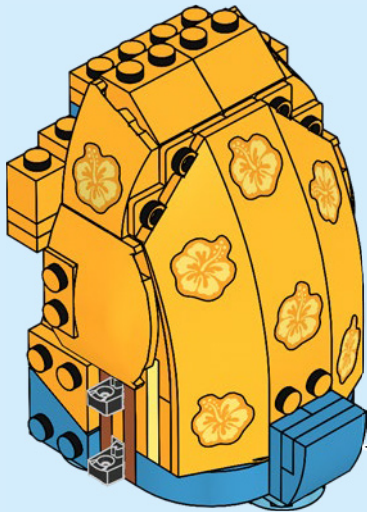

1



2



3

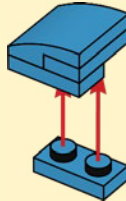

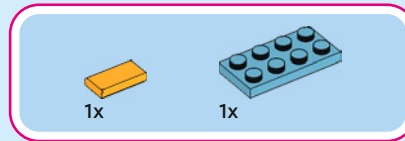
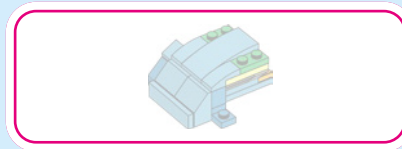

40

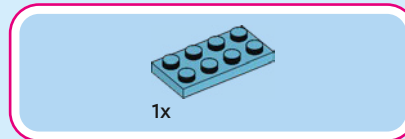
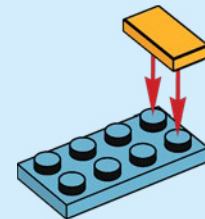

41

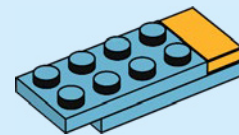

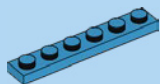

1x

42

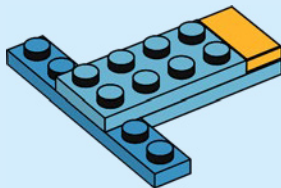

2x

43

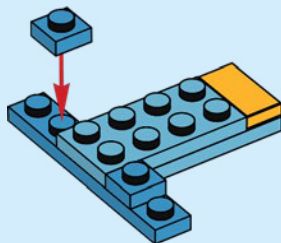

1x



1x

44

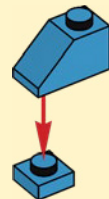
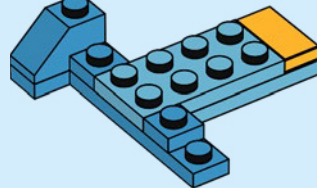

2x



2x

45

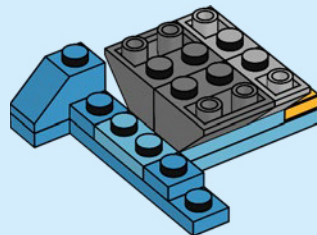

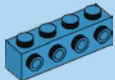

1x

46

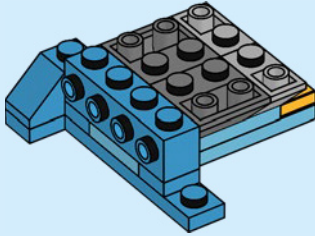

1x

47

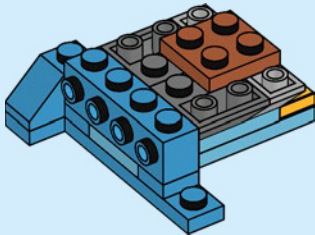

2x

48

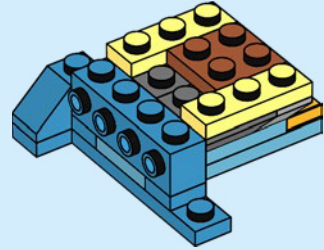

2x

49

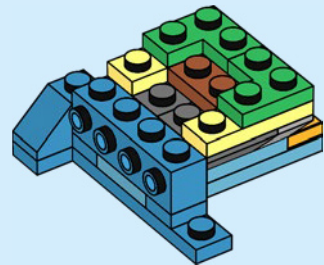

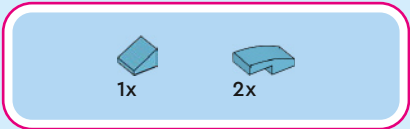

50

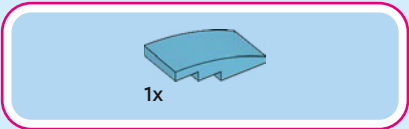
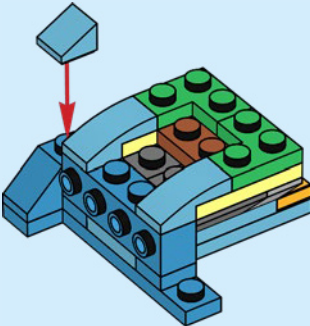

51

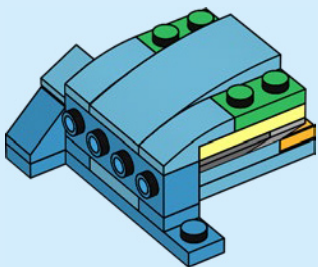



2x

52

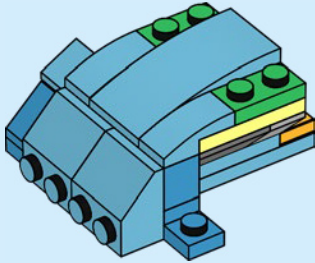

1x

53

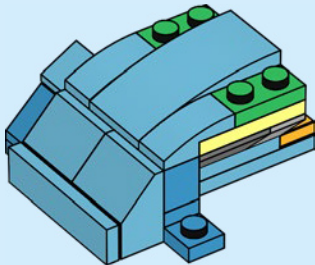

54

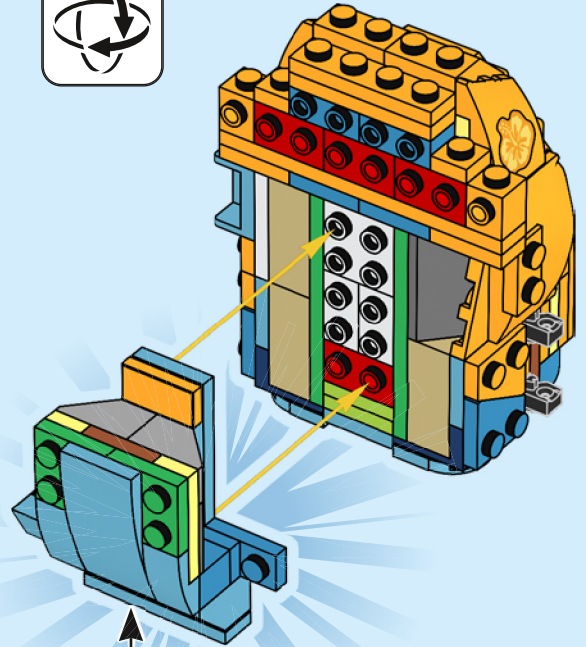

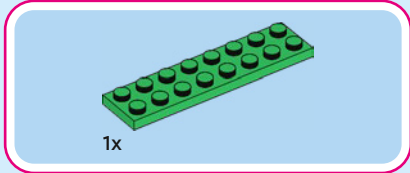
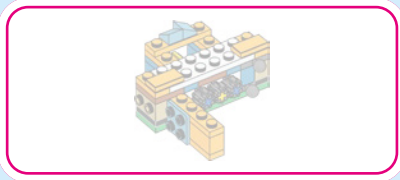

1x

55

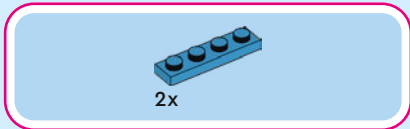
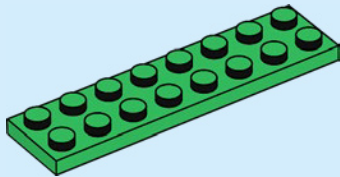

2x

56

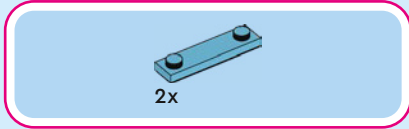
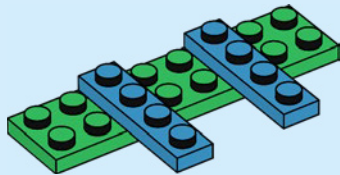

2x

57

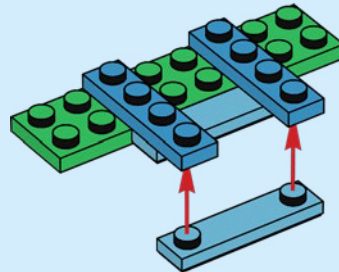

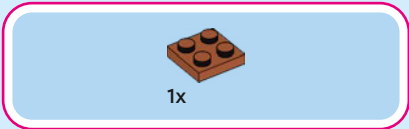

58

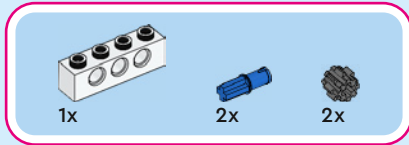
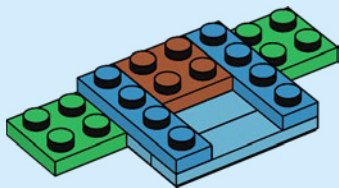

59

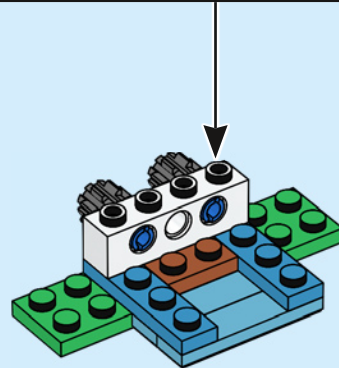
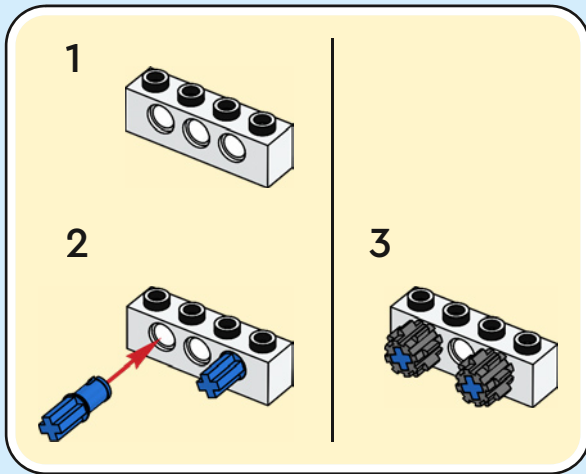

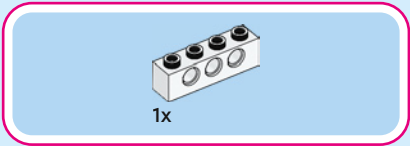

60

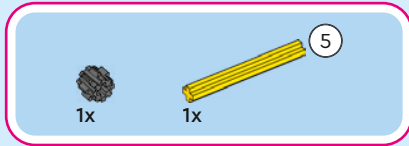
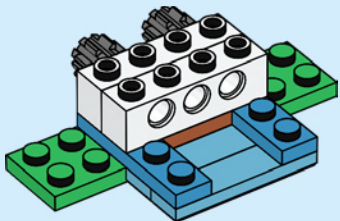

61

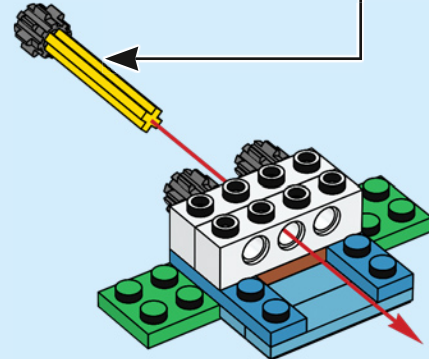
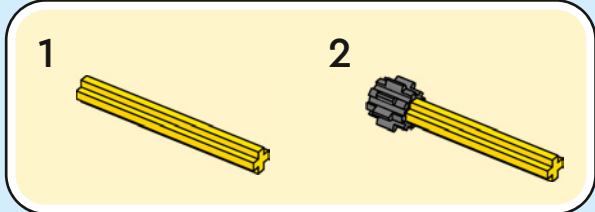



1x

62

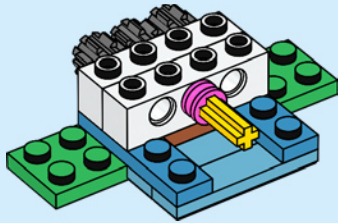

2x

63

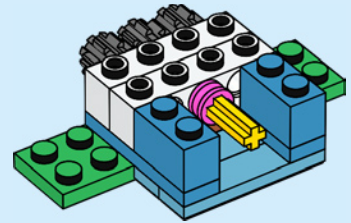

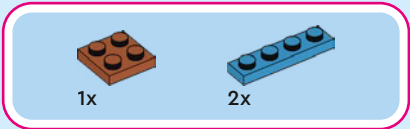

64

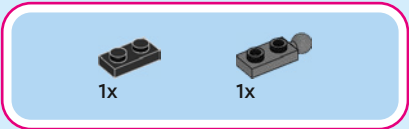
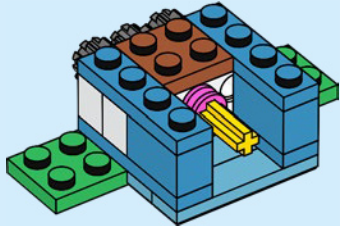

65

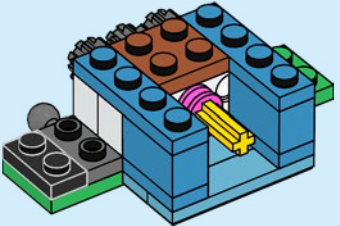



1x



1x

66

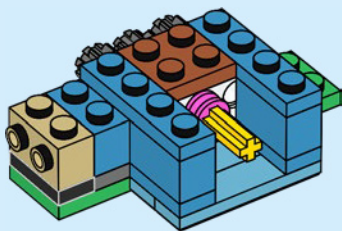

1x



1x

67

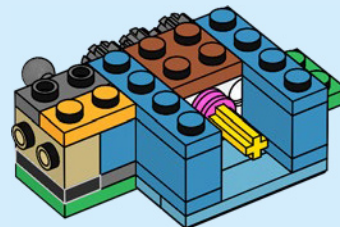

1x

68

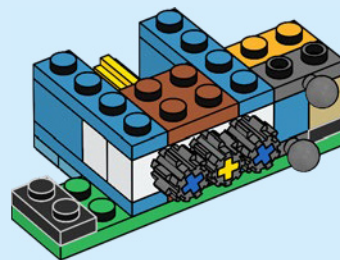

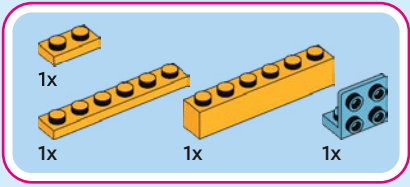

69

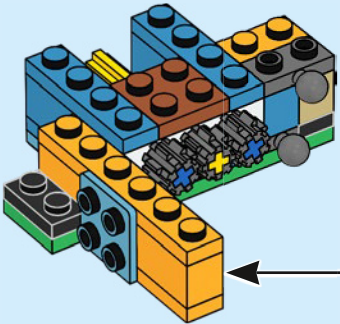
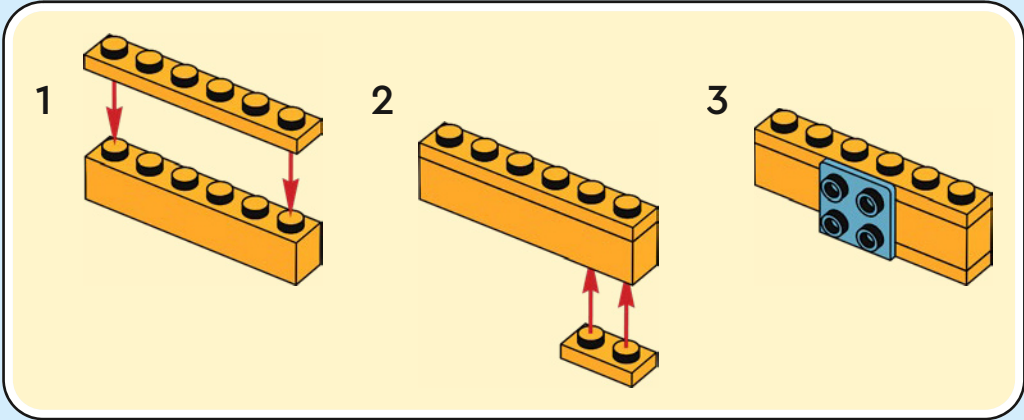



1x

70

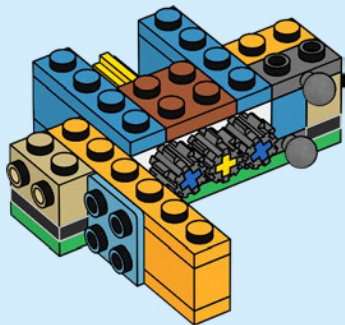

1x

71

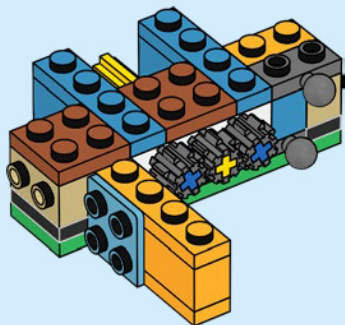

2x

72

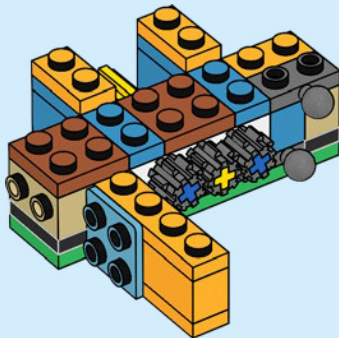

1x



2x

73

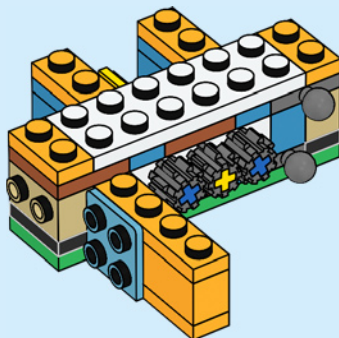

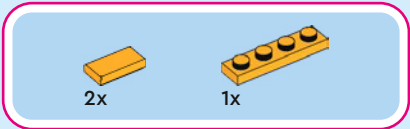

74

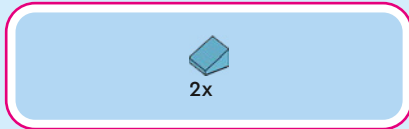
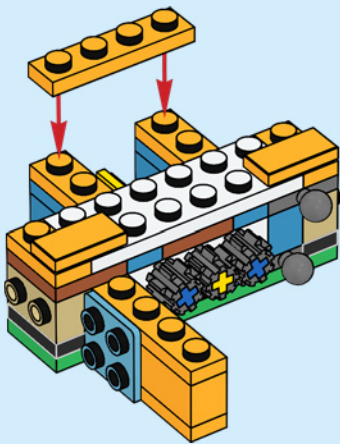

75

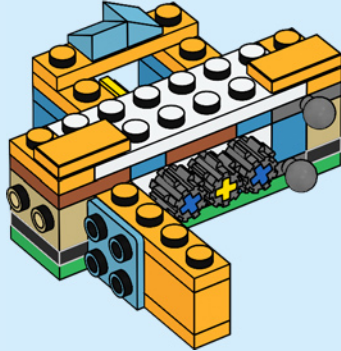

76

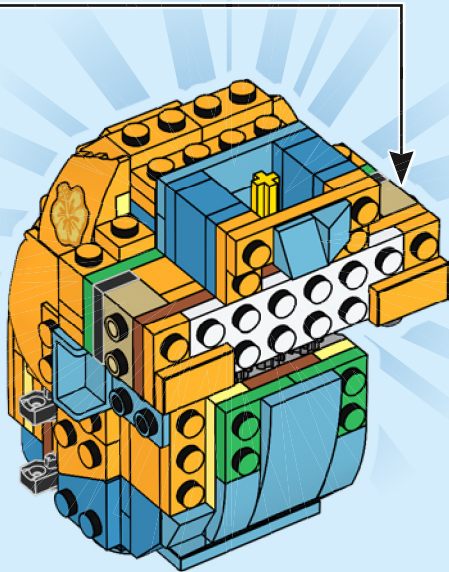

77

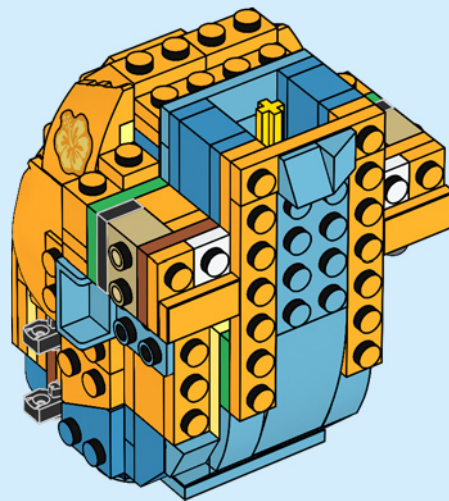
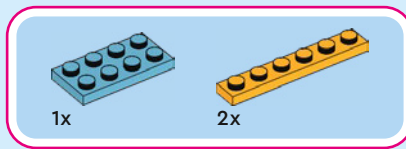

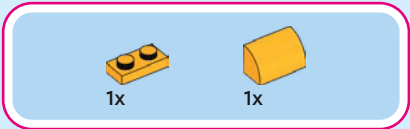

78

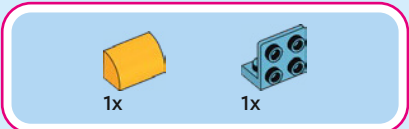
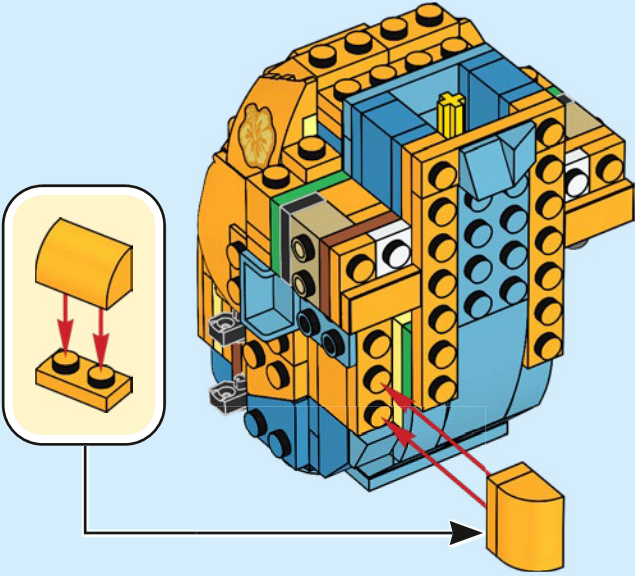

79

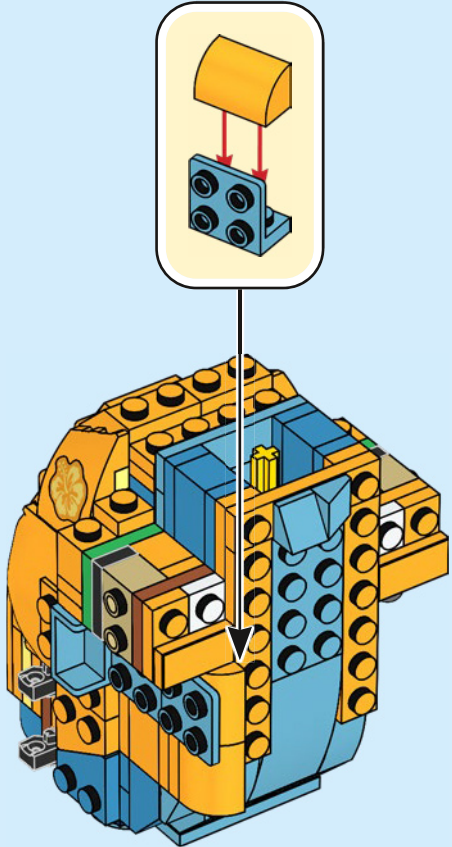

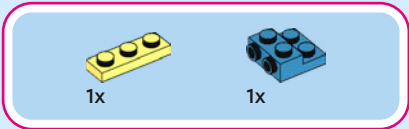

80

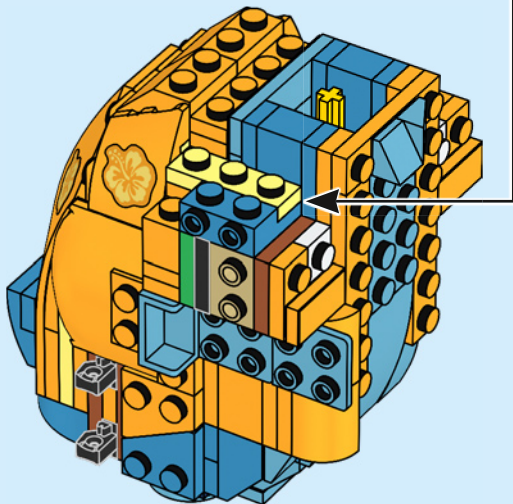
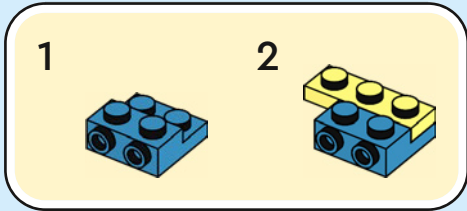

81

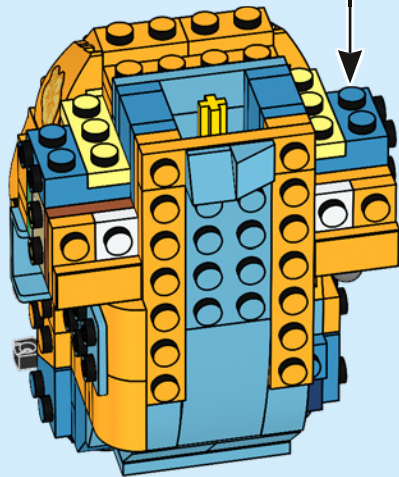
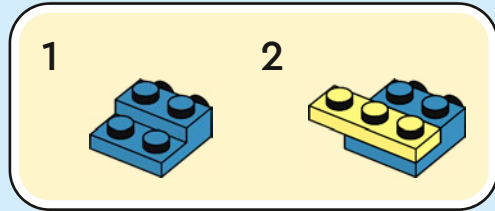



1x



2x

82

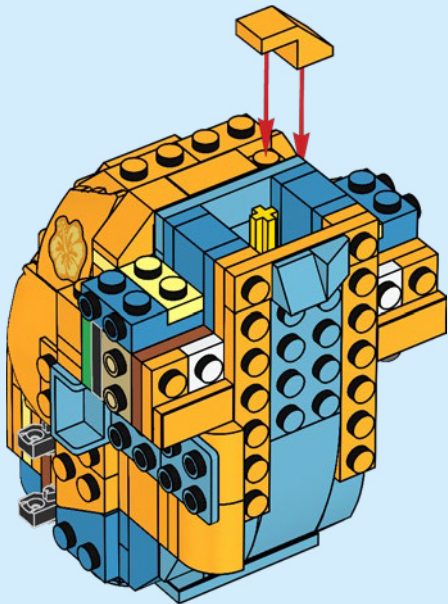

2x

83

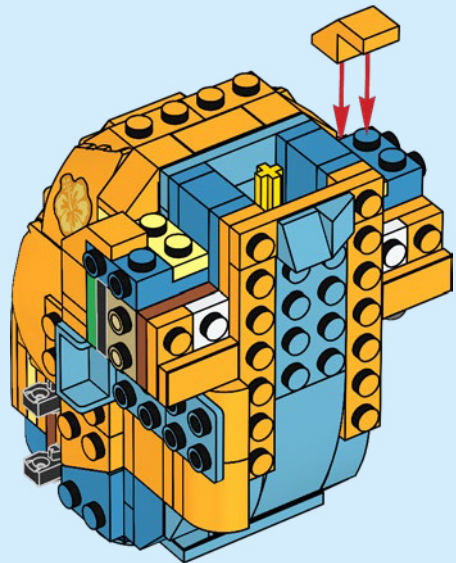



2x

84

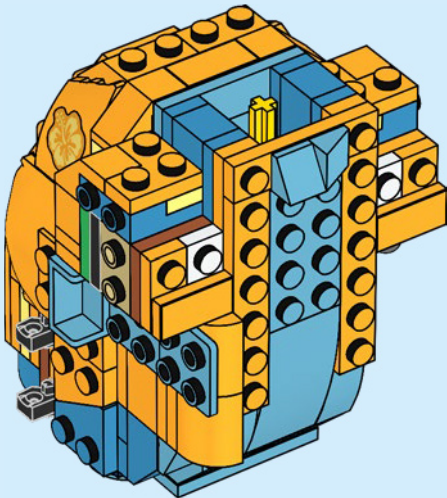

2x



2x

85

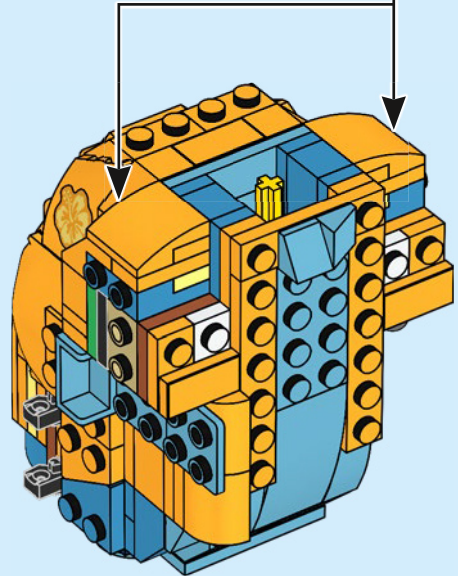
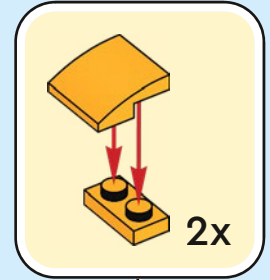

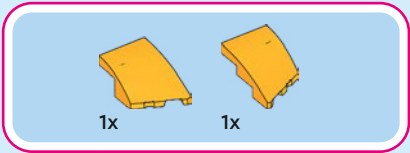

86

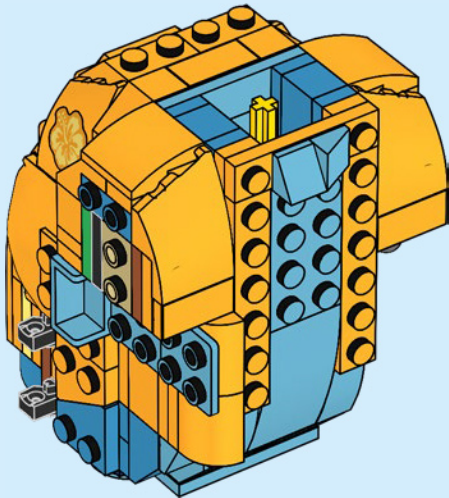

87

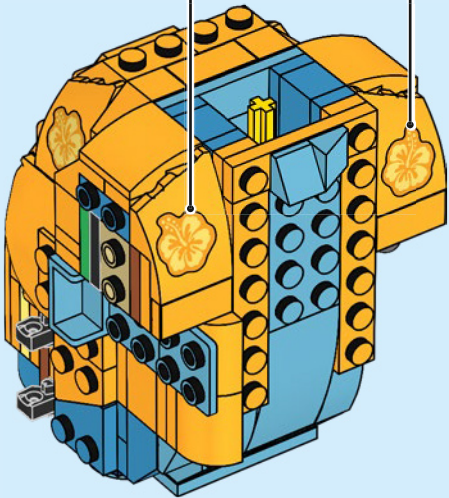



1x



1x

88

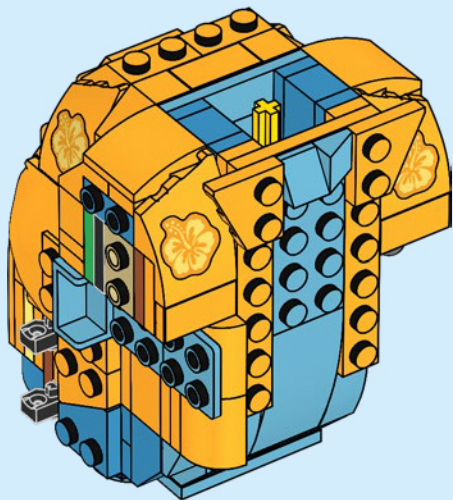

1x



1x

89

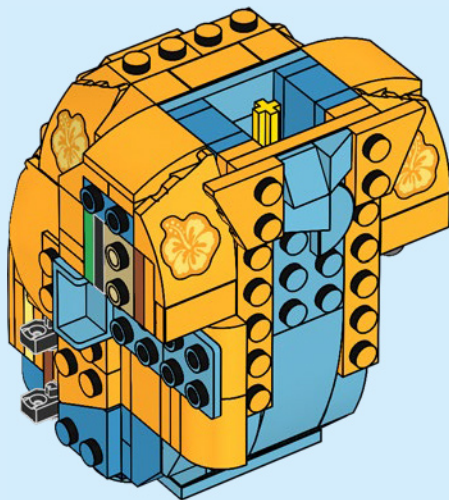

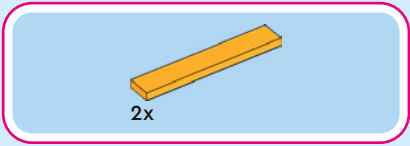

90

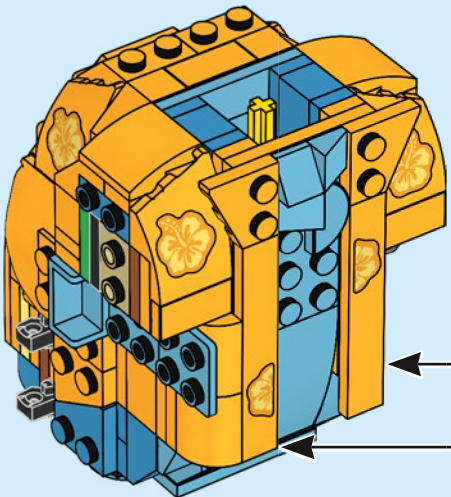
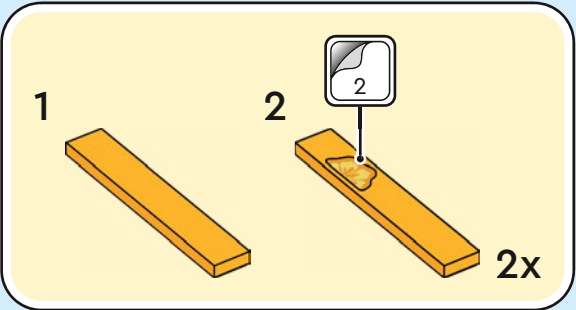

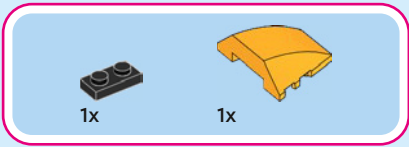

91

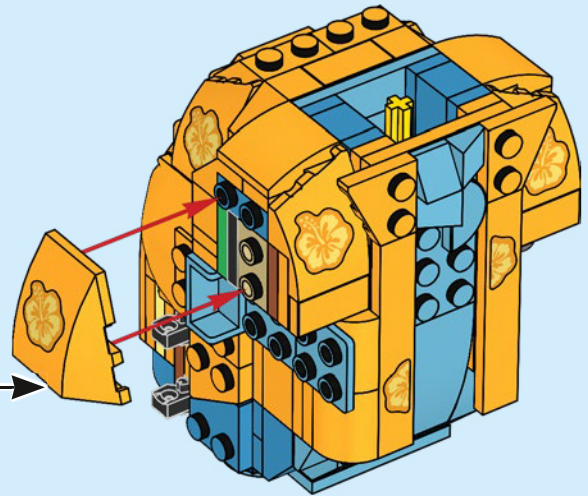
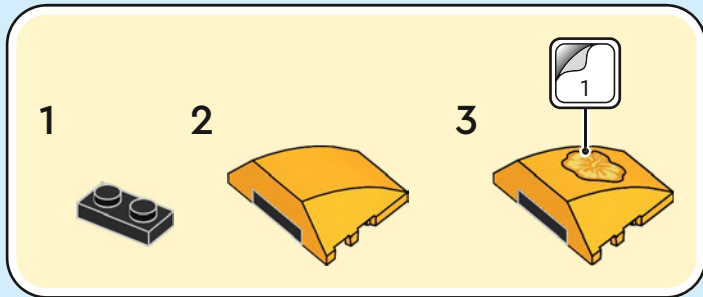

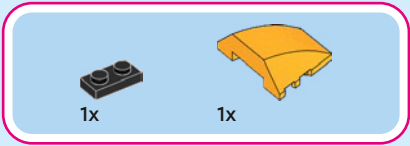

92

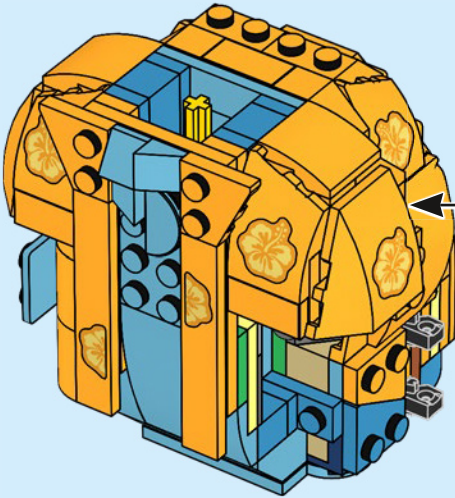
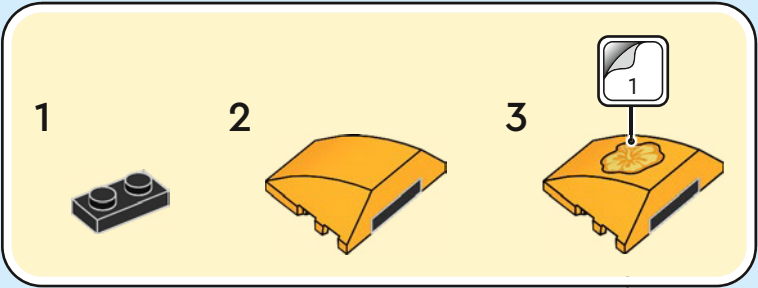

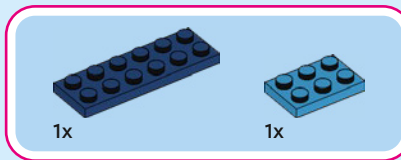
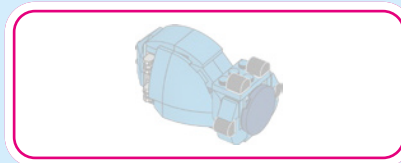

93

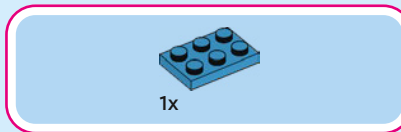
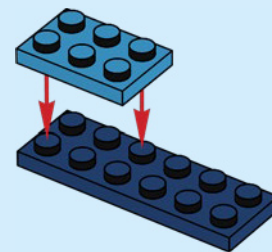

94

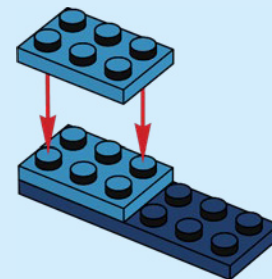



1x

95

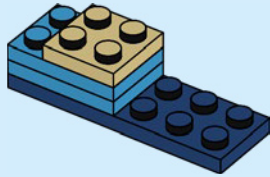

2x

96

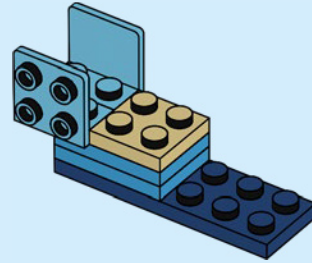

1x

97

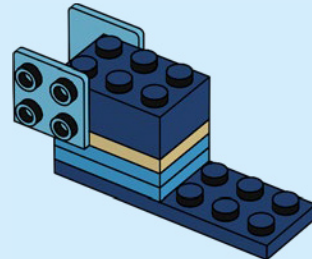



1x

98

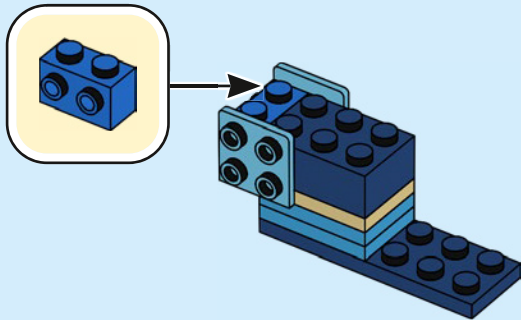

2x

99

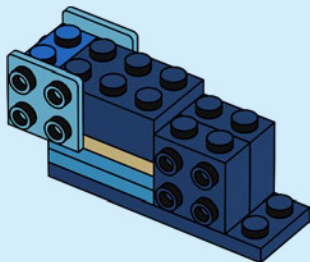

1x

100

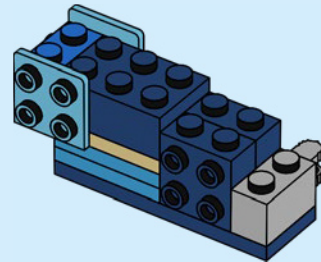

1x

101

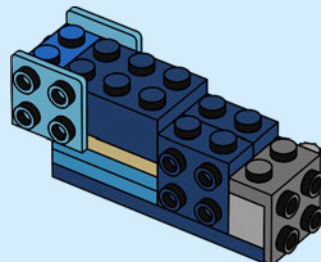



2x



2x

102

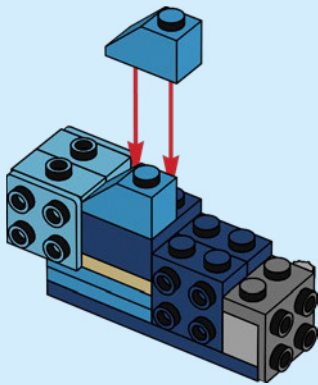

2x

103

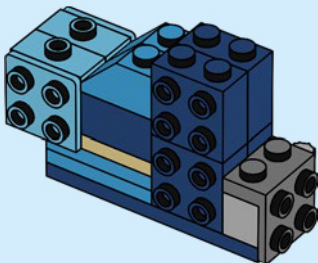

1x



1x



1x

104

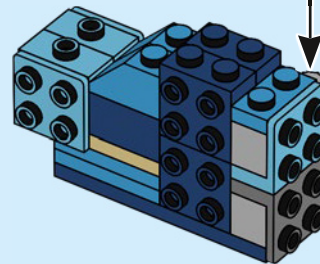
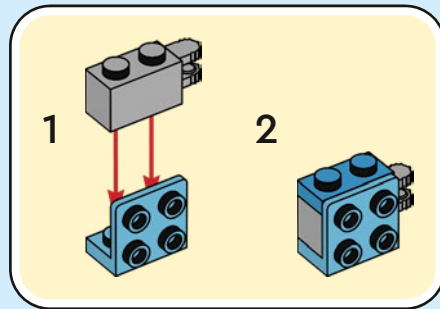



2x

105

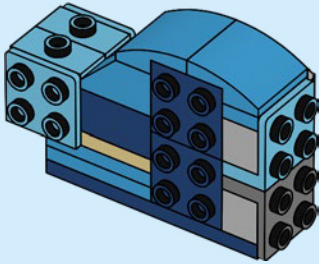

2x

106

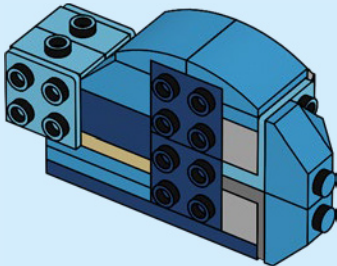

2x

107

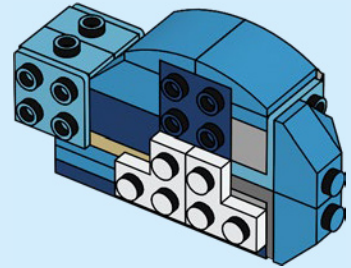

1x



1x

108

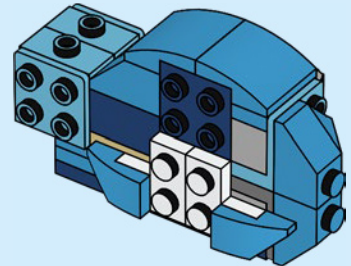



1x

109

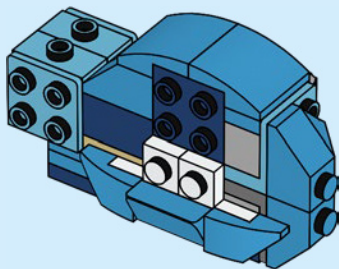

2x

110

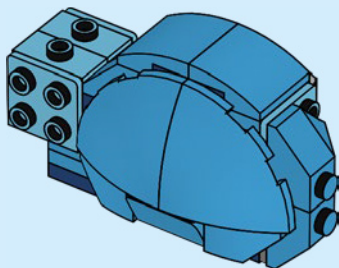

2x

111

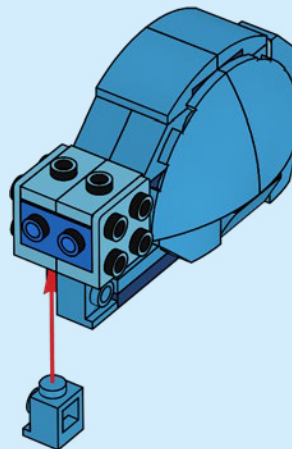



2x

112

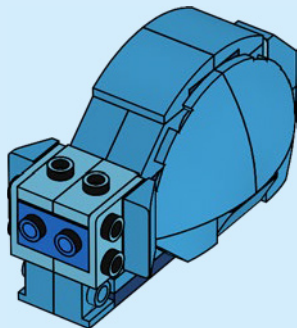

2x

113

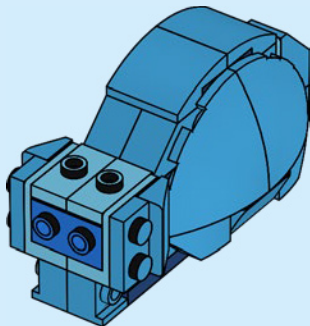

2x

114

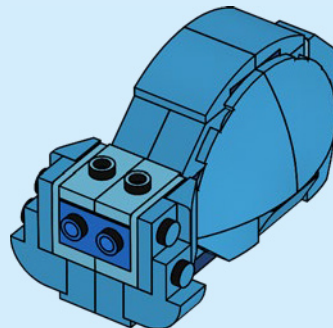

2x



2x

115

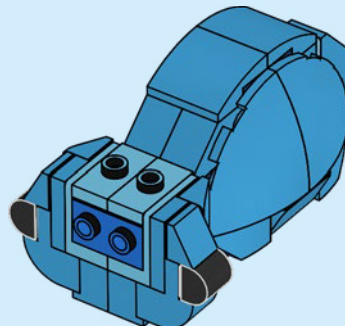

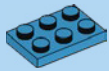

1x

116

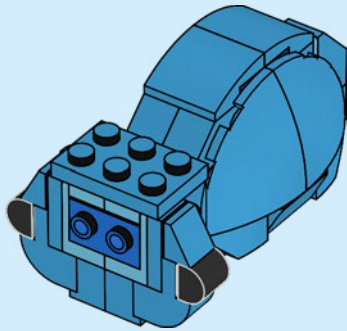

2x



1x

117

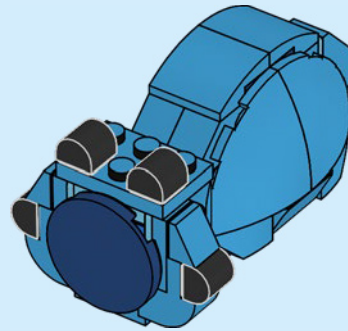

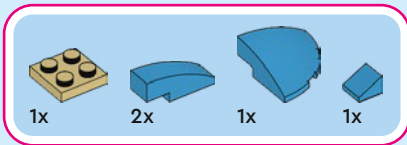

118

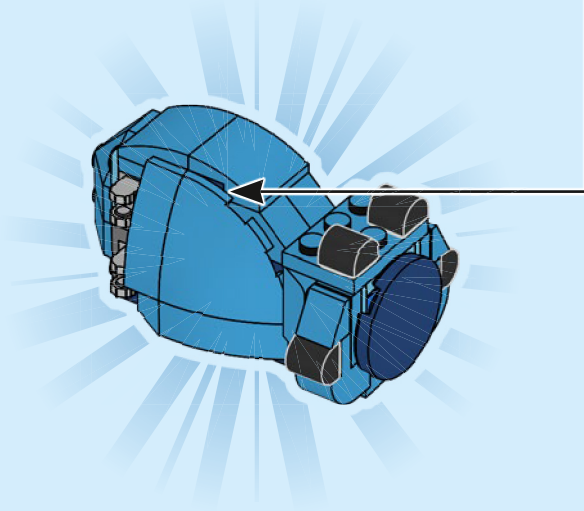
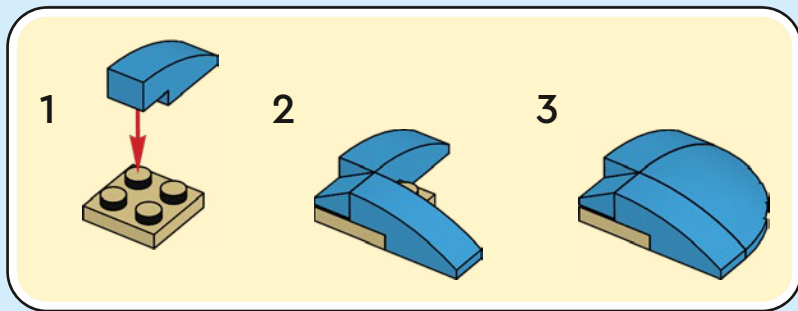

119

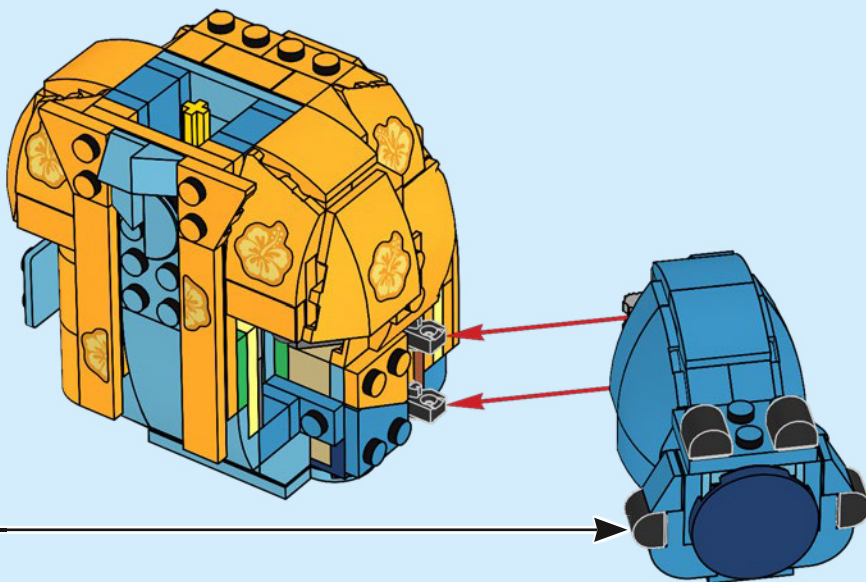

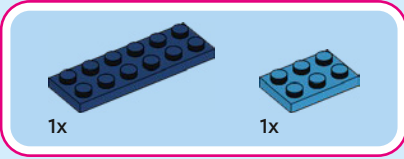
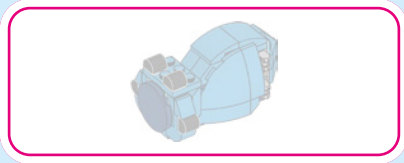

120

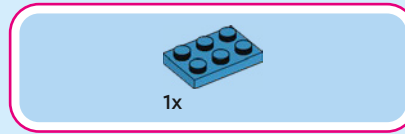
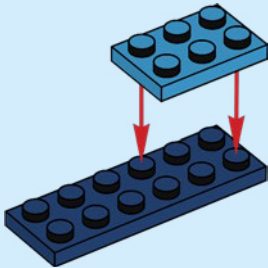

121

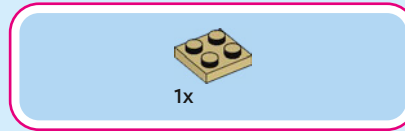
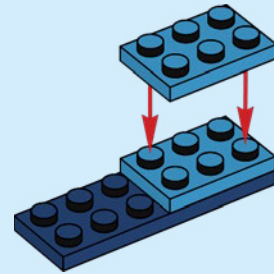

122

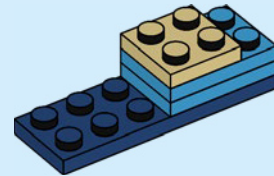



2x

123

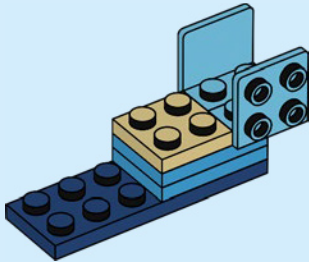

1x

124

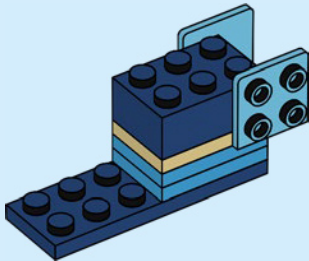

1x

125

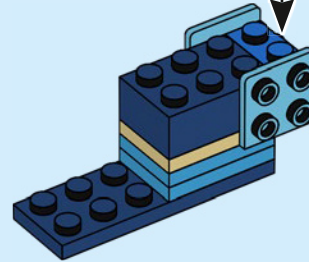
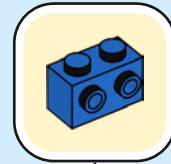

2x

126

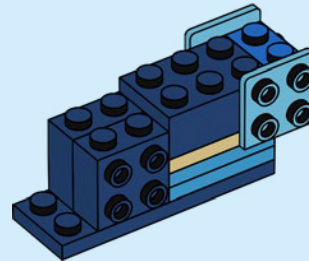



1x

127

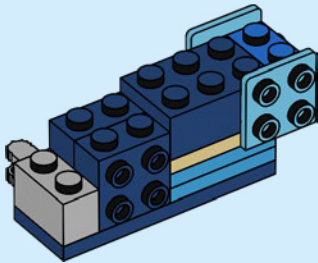

1x

128

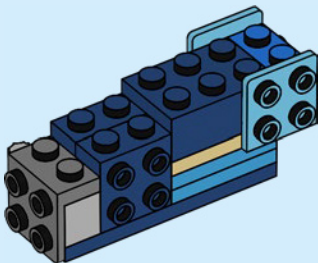

2x



2x

129

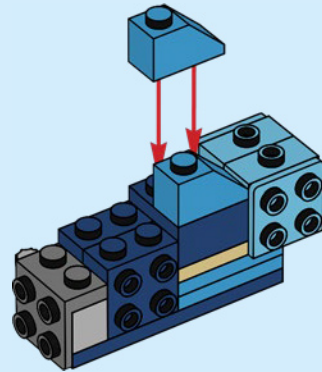

2x

130

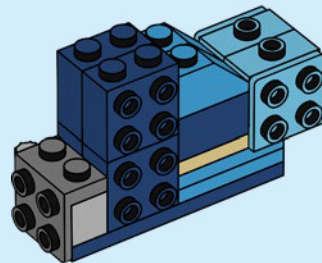

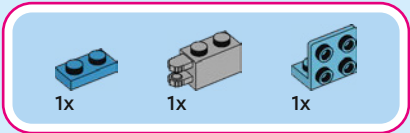

131

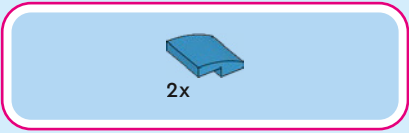
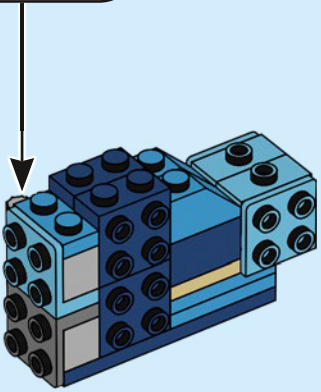
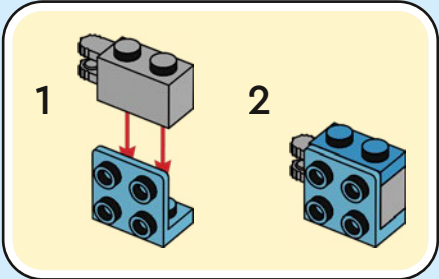

132

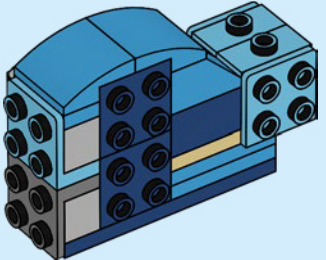

133

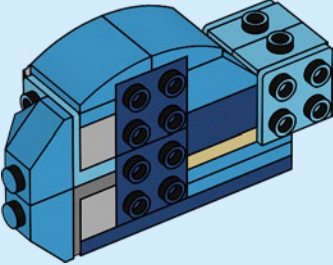



2x

134

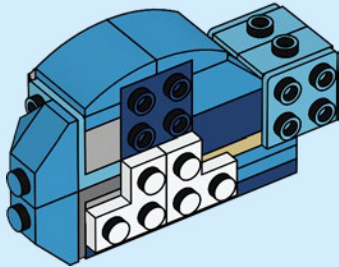

1x



1x

135

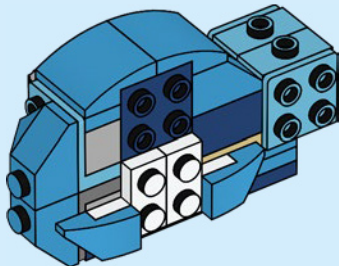

1x

136

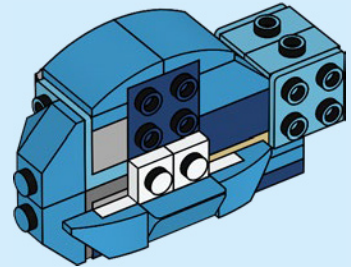

2x

137

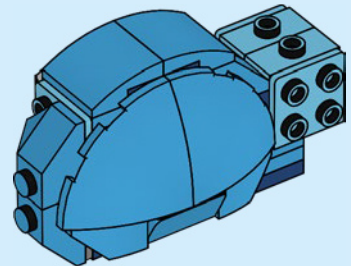



2x

138

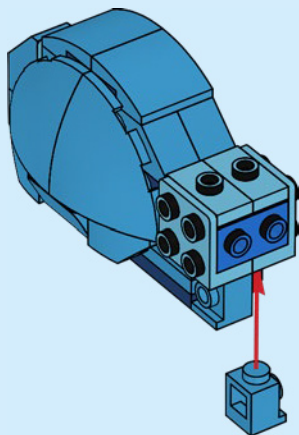

2x

139

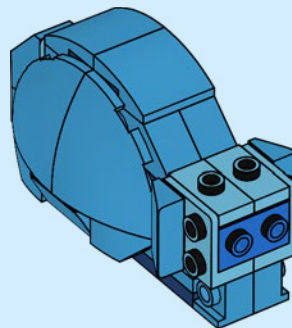

2x

140

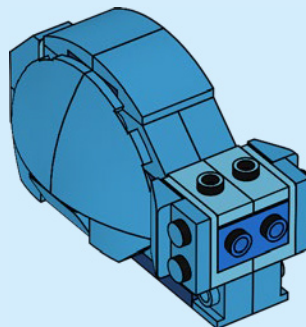



2x

141

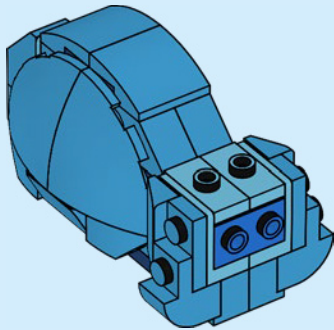

2x



2x

142

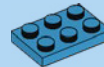
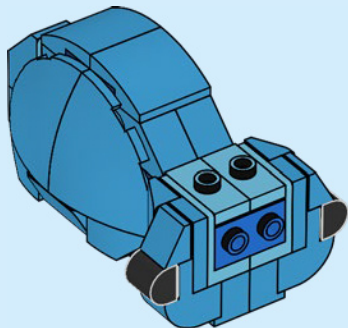

1x

143

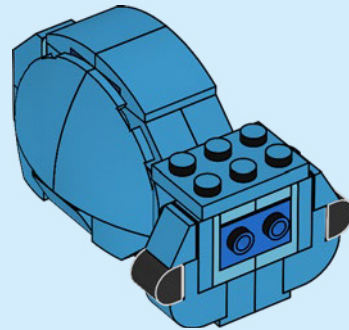

2x



1x

144

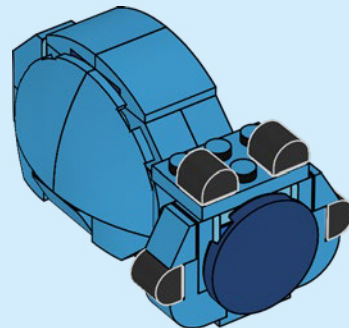

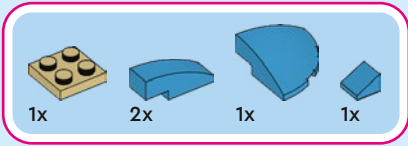

145

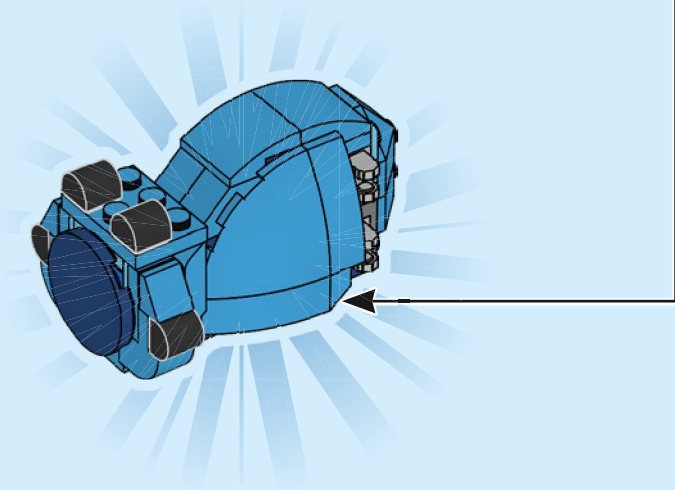
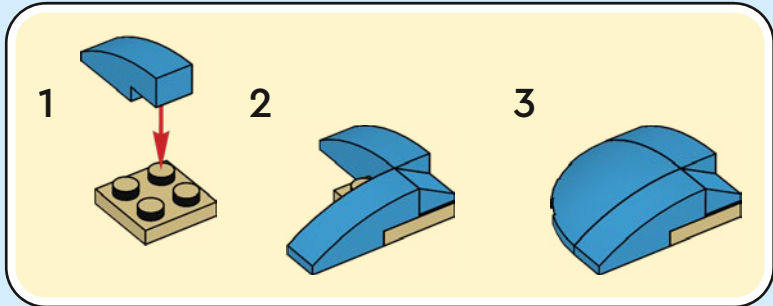

146

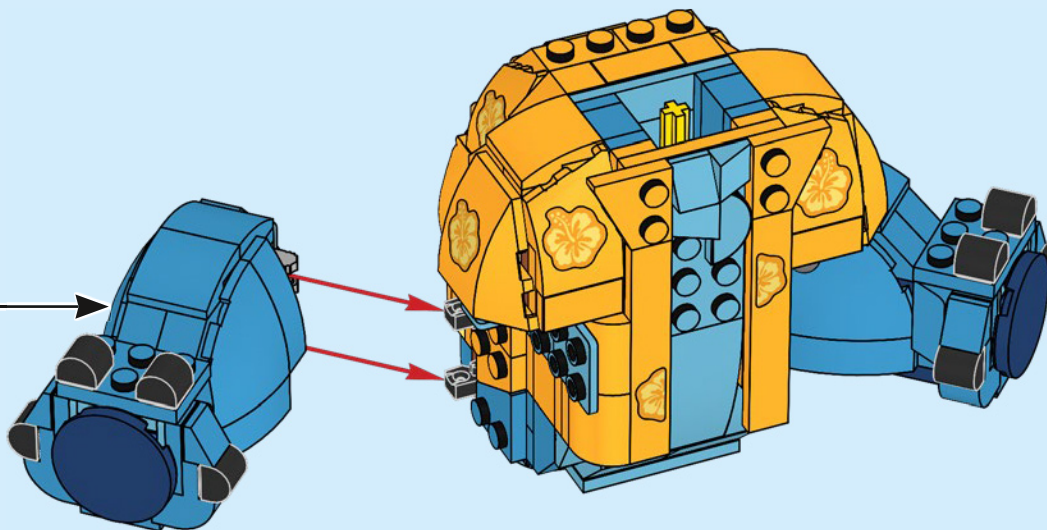

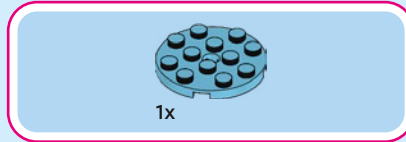
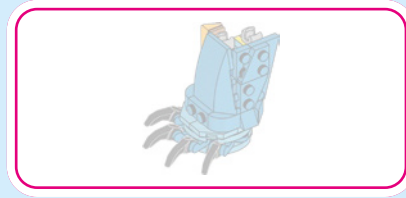

147

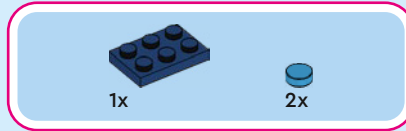
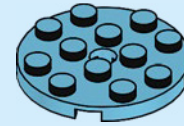

148

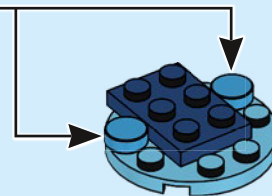
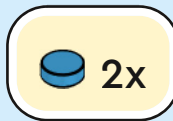



4x

149

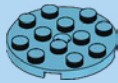
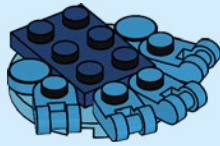

1x

150

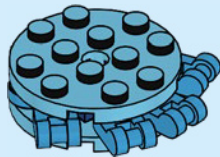

2x



1x

151

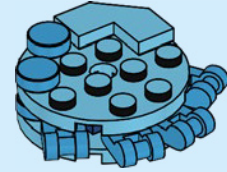

2x

152

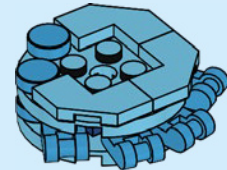

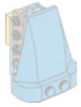

2x

153

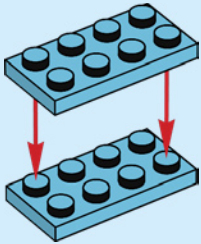

1x



1x



1x

154

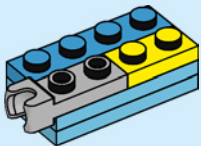

1x



1x

155

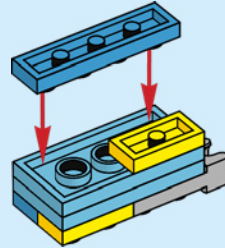

2x

156

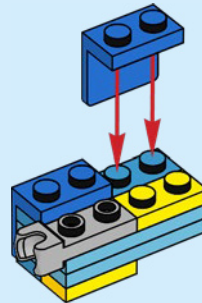

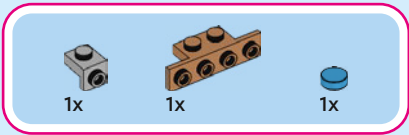

157

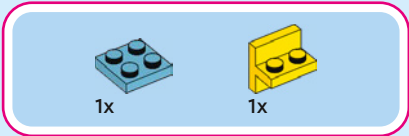
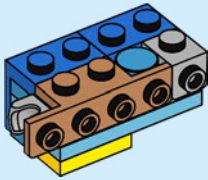

158

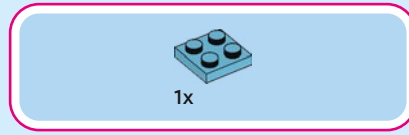
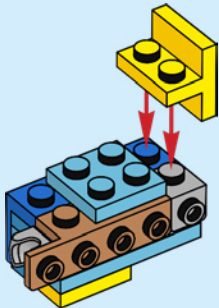

159

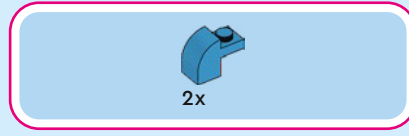
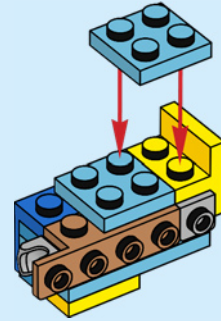

160

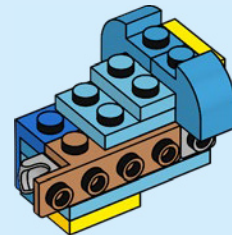

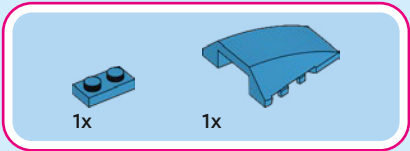

161

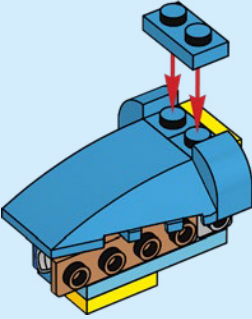

162

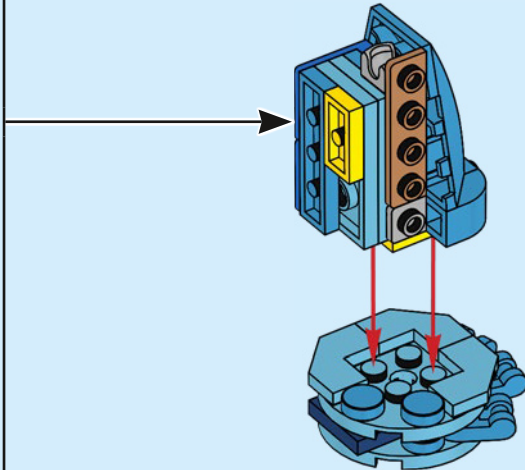



1x



1x

163

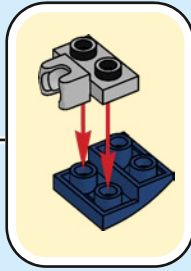
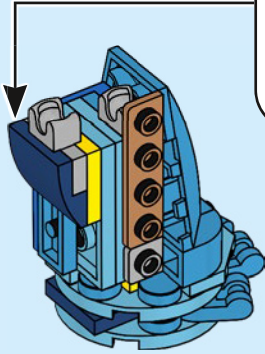

2x



1x

164

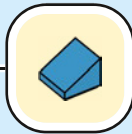
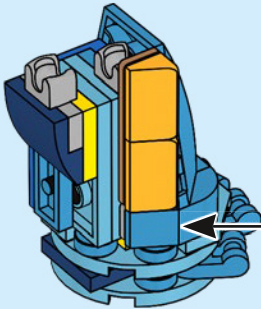

1x



1x

165

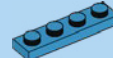
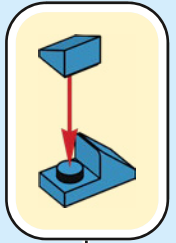
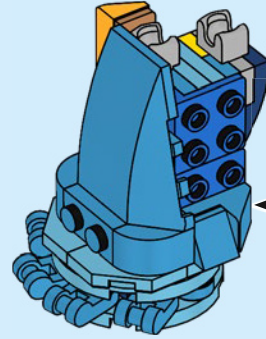

1x

166

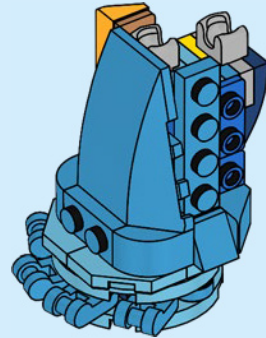



1x

167

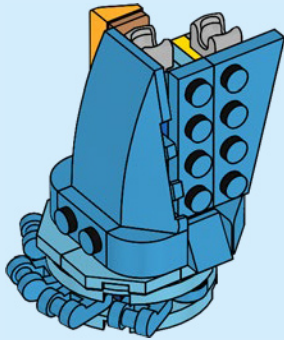

2x

168

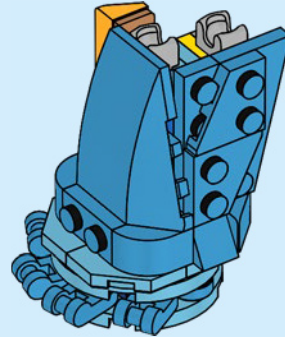

4x

169

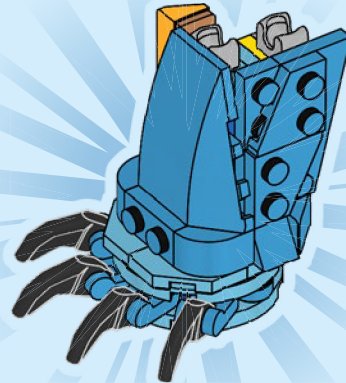

170

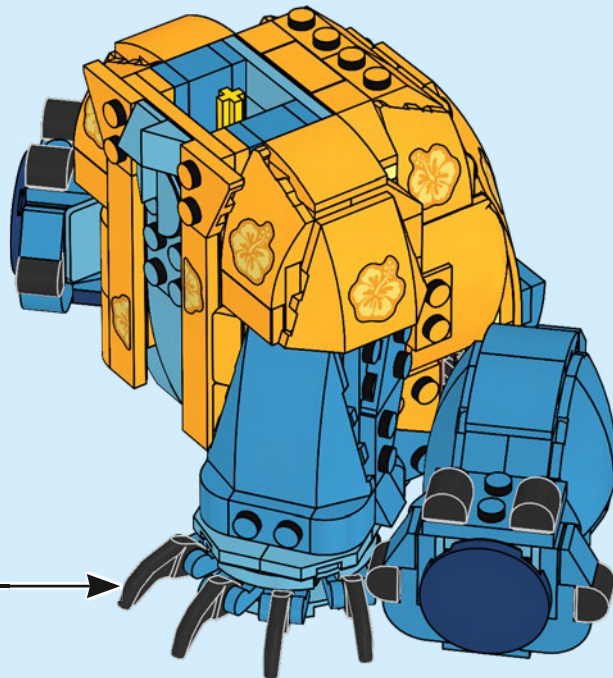

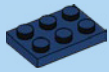

1x

171

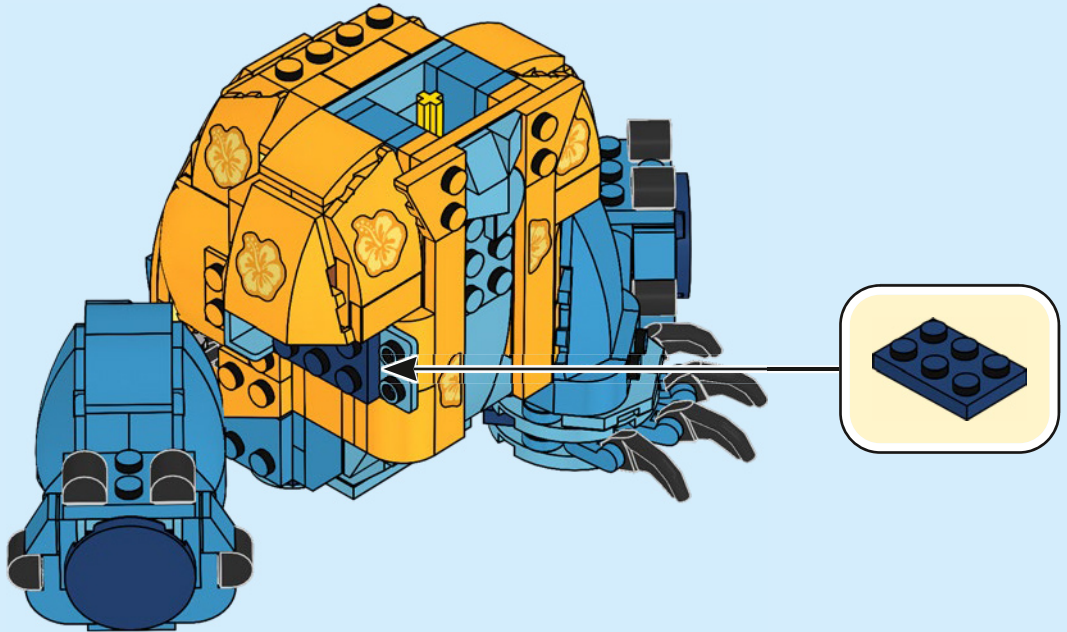



1x

172

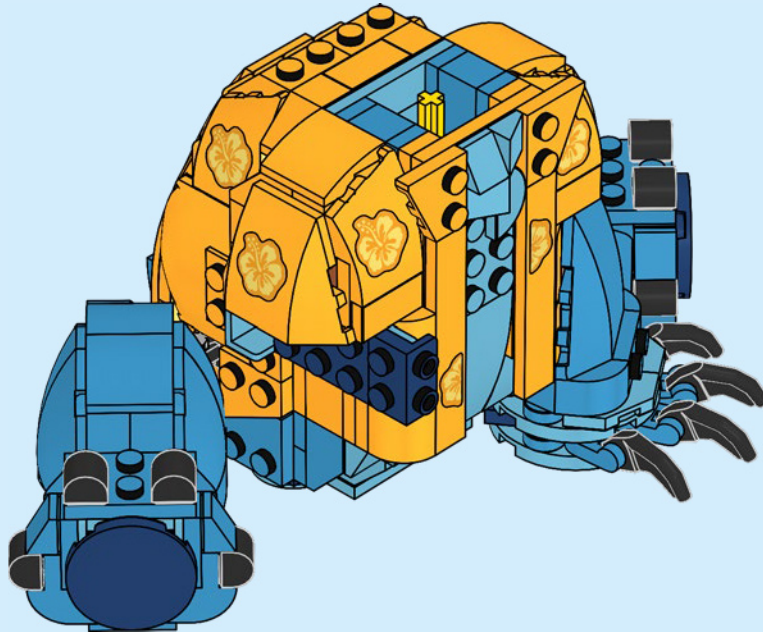

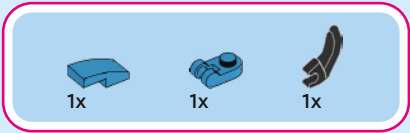

173

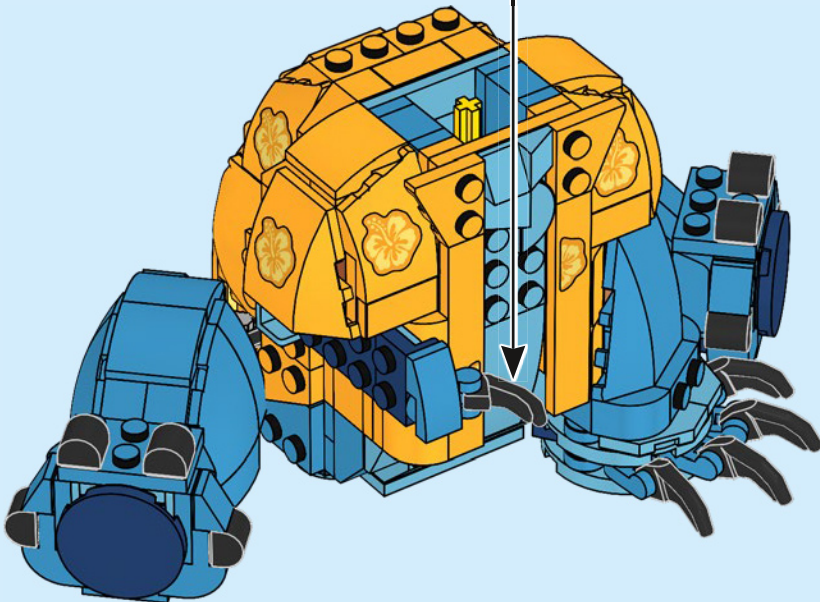
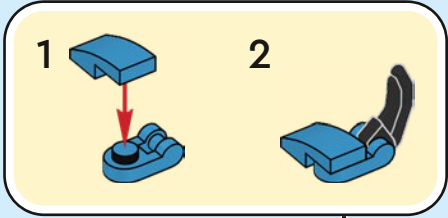

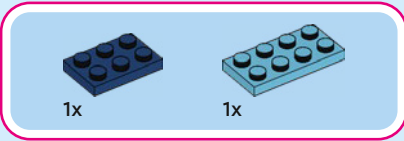
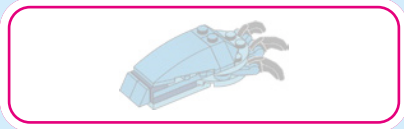

174

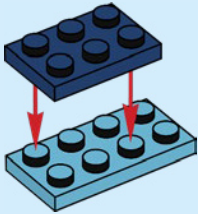

175

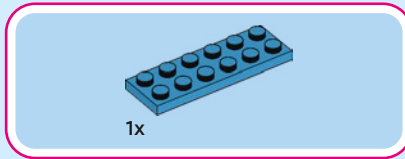
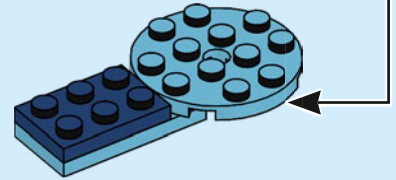
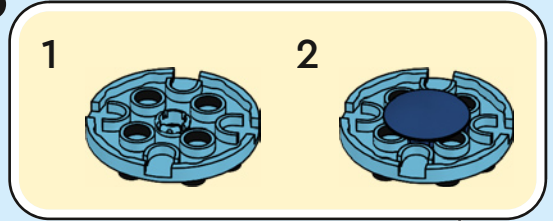

176

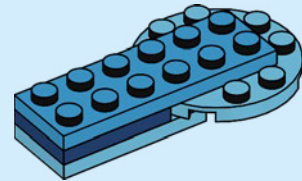



3x

177

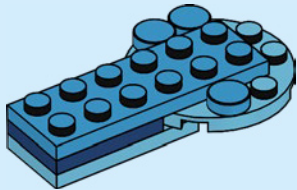

3x

178

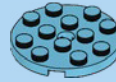
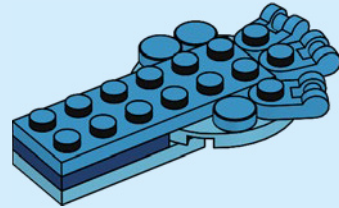

1x

179

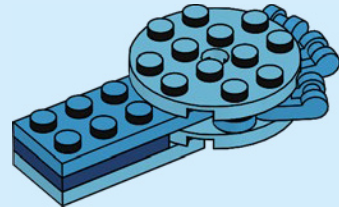

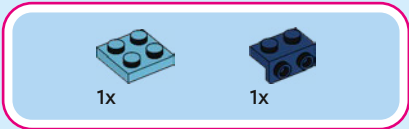

180

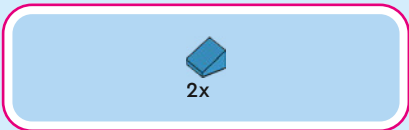
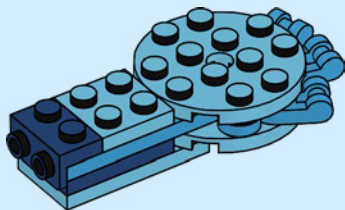

181

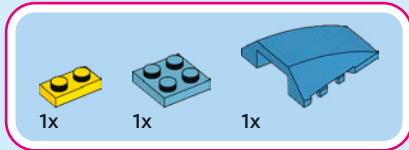
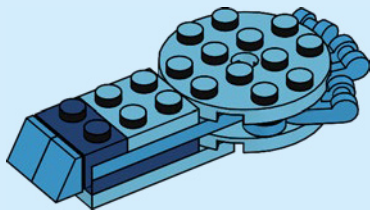

182

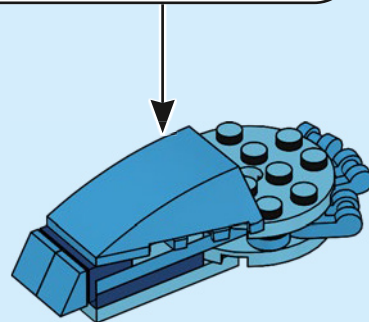
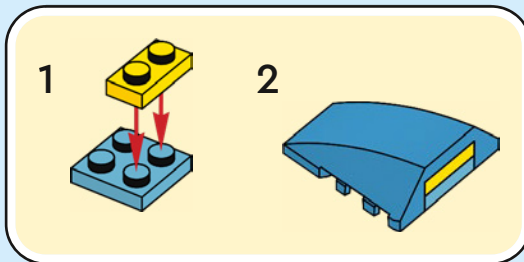



2x

183

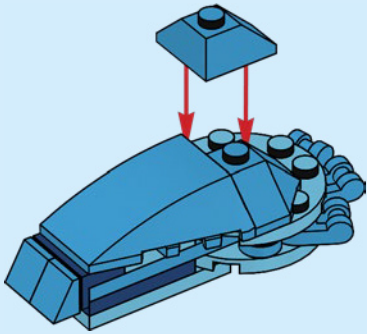

3x

184

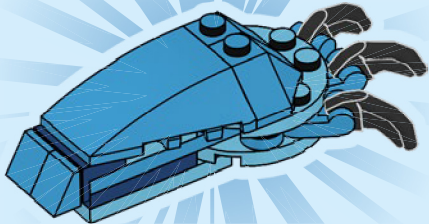

185

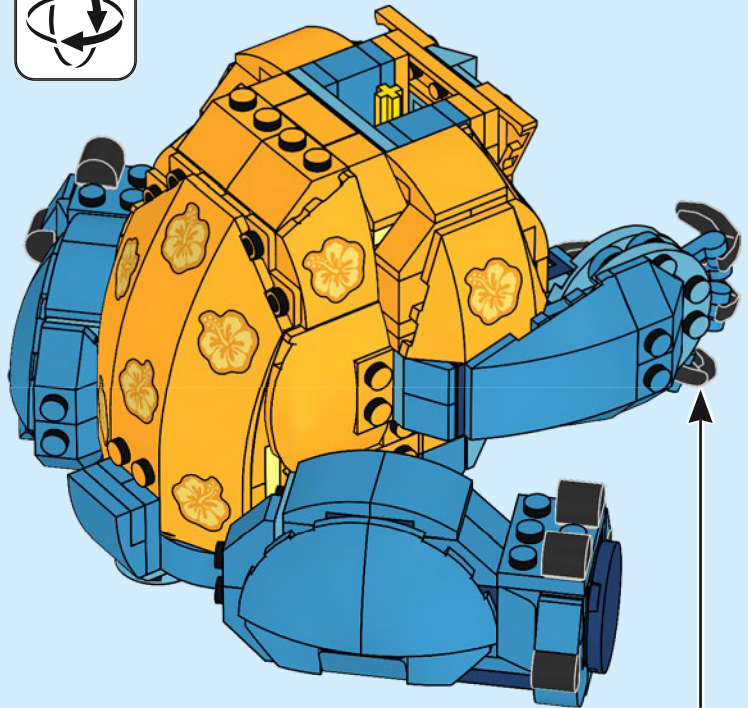

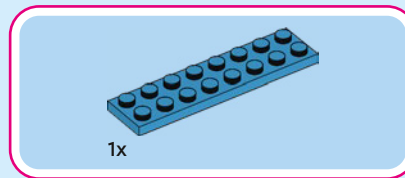

186

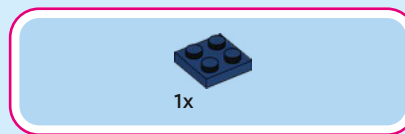
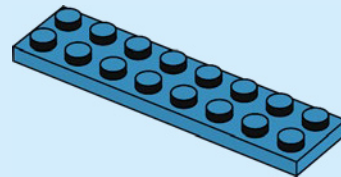

187

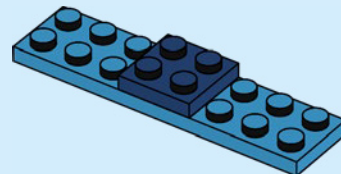



2x

188

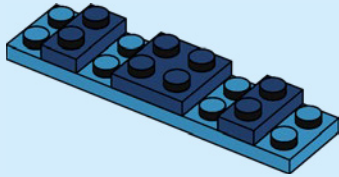

2x

189

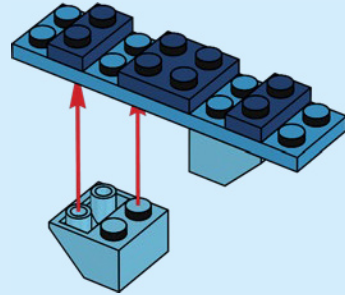

4x

190

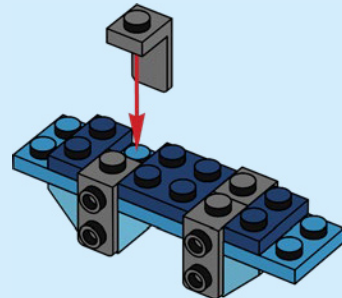

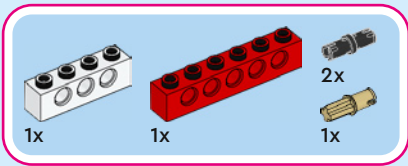

191

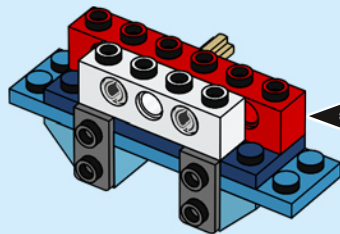
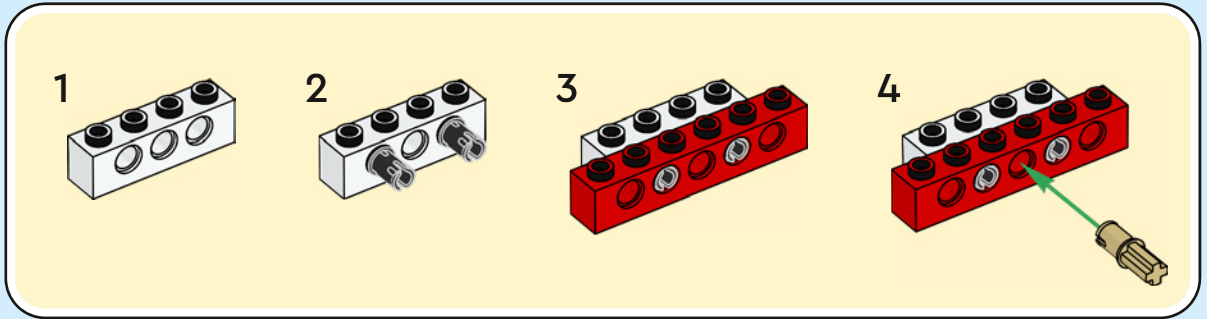



2x

192

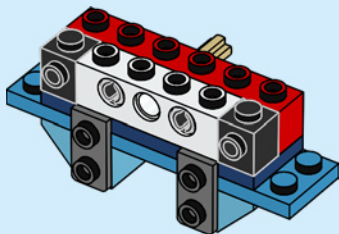

2x



2x

193

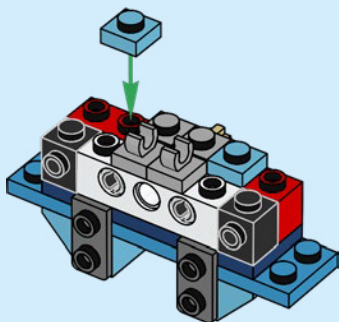

2x

194

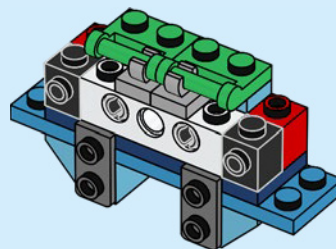

2x



1x

195

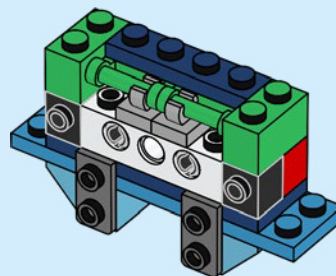

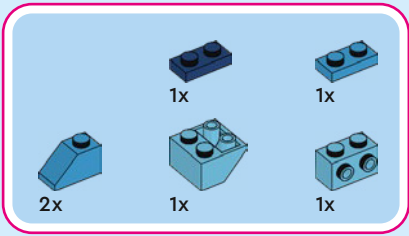

196

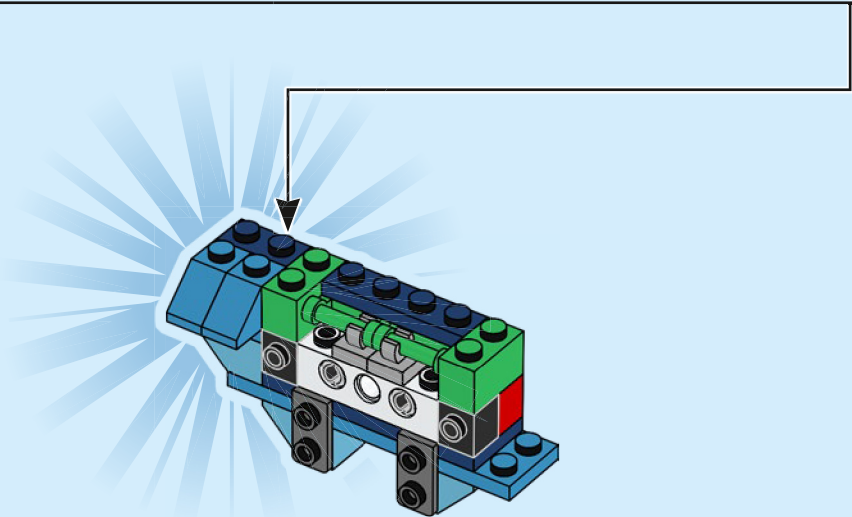
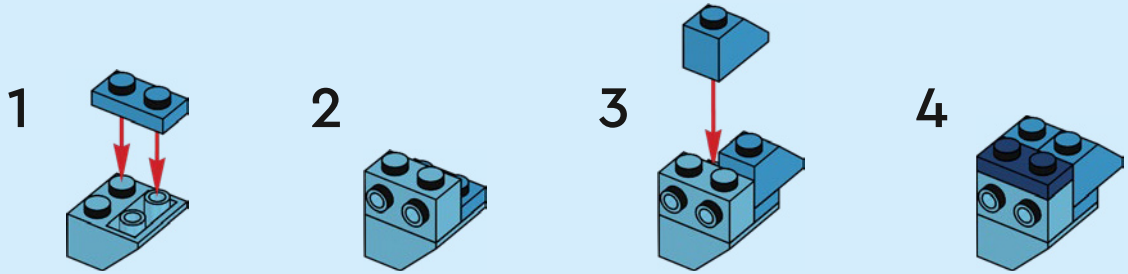

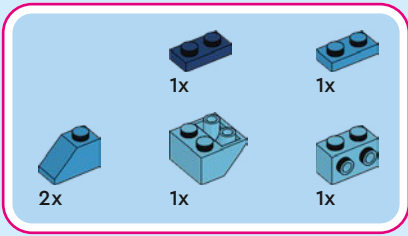

197

1

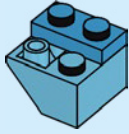

2

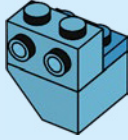

3

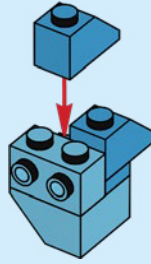

4

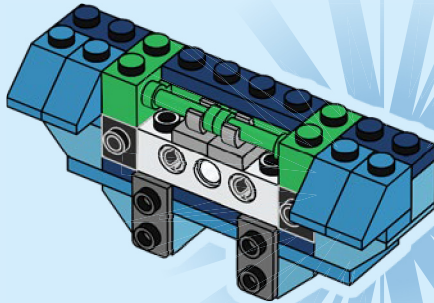
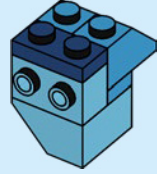

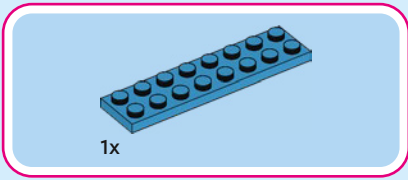

198

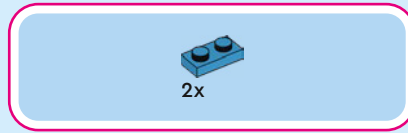
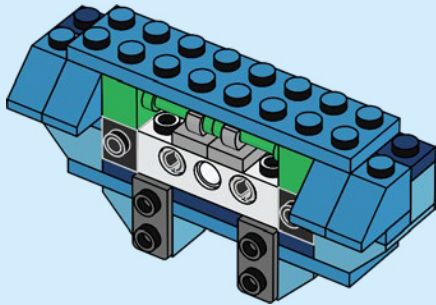

199

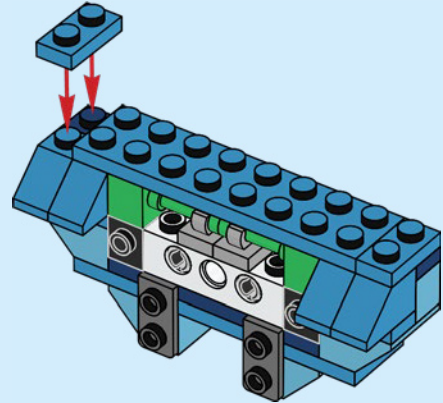



2x

200

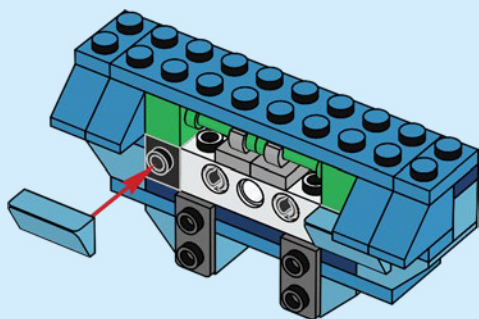

2x



2x



1x

201

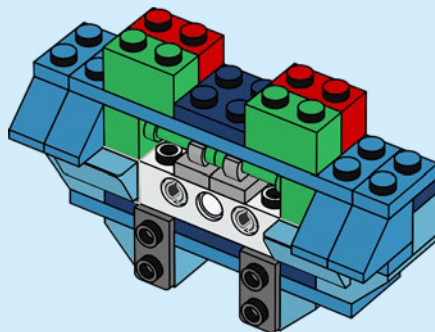



1x



1x

202

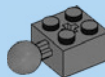
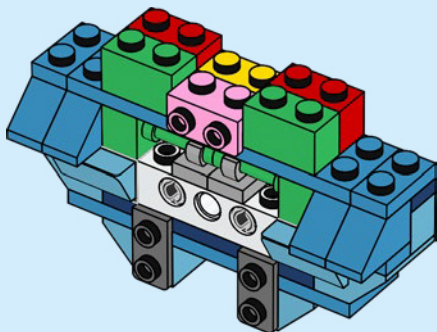

2x

203

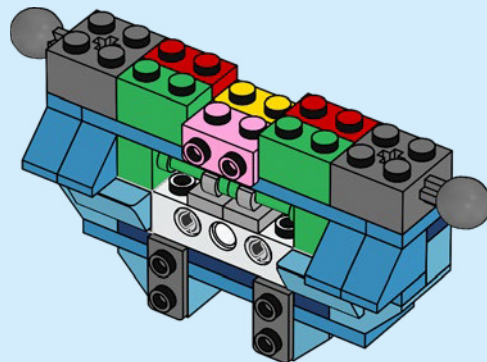



4x

204

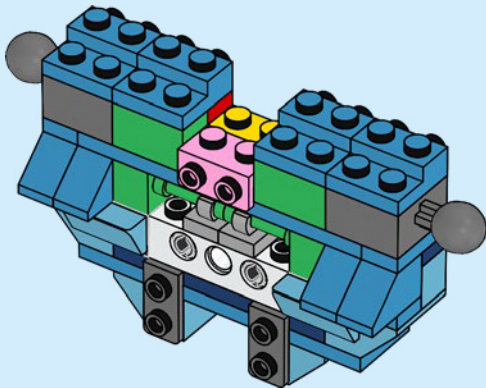

2x

205

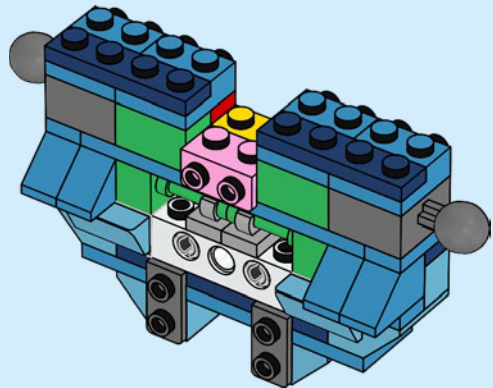

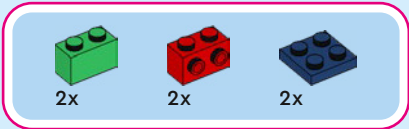

206

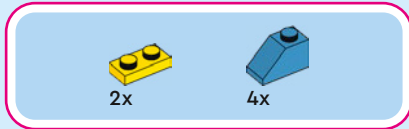
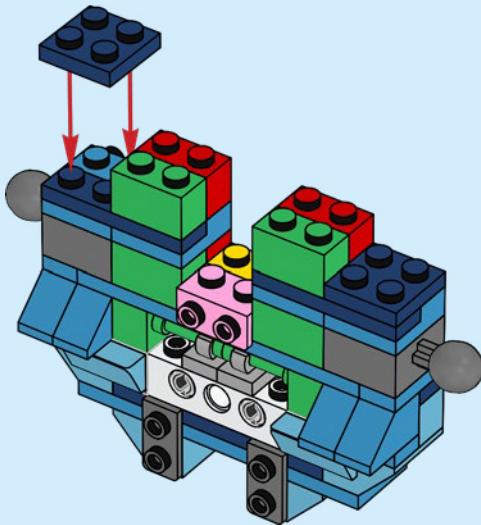

207

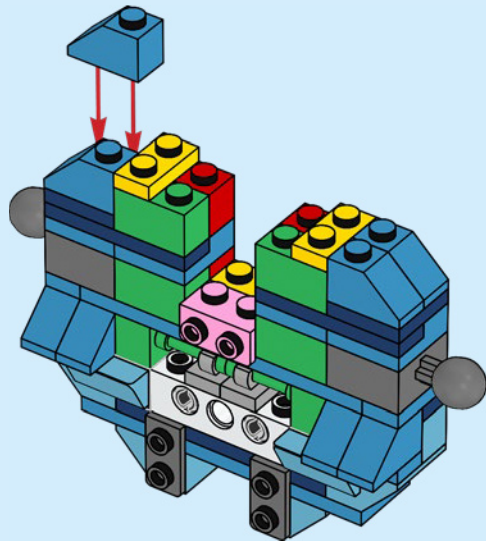

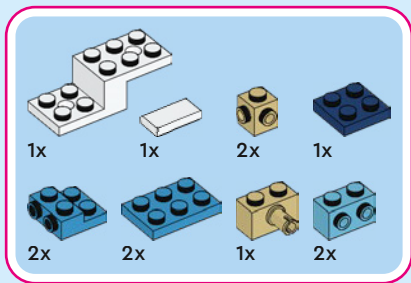

208

1

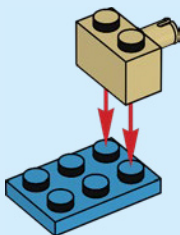

2

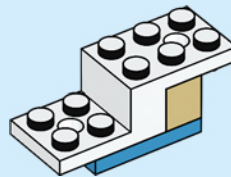

3

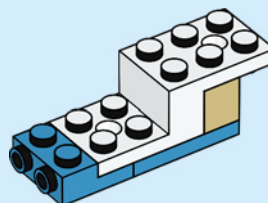

4

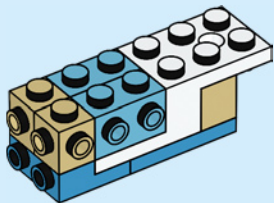

5

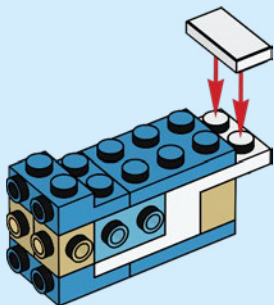

6

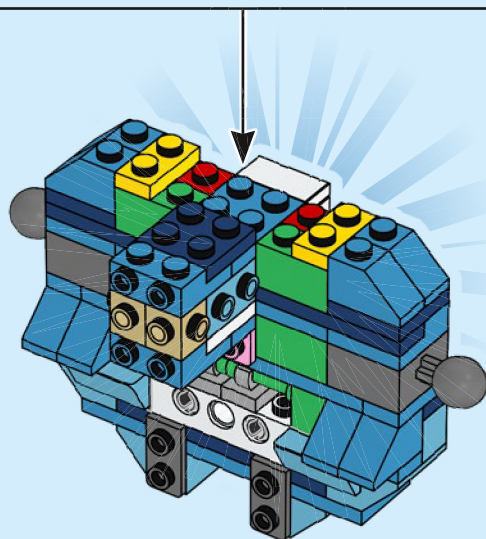
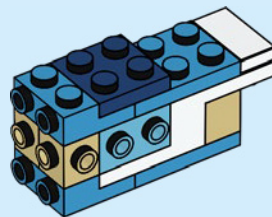



2x

209

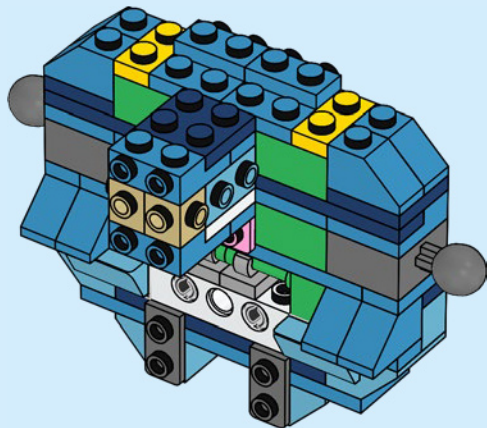

1x



1x

210

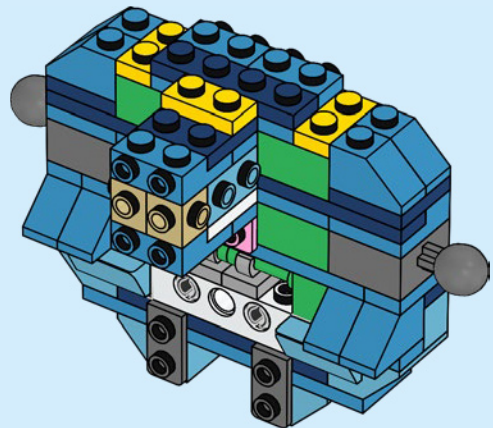



1x

211

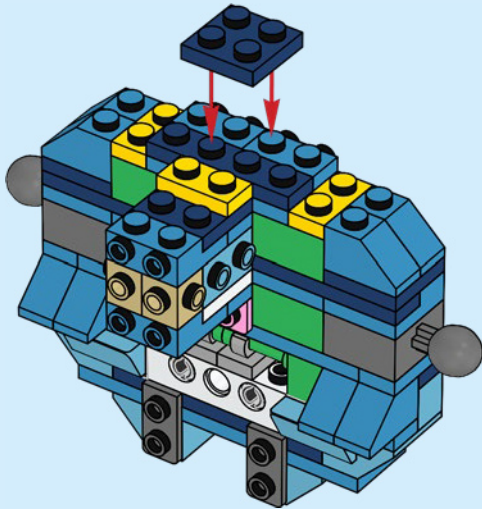

2x



1x



1x

212

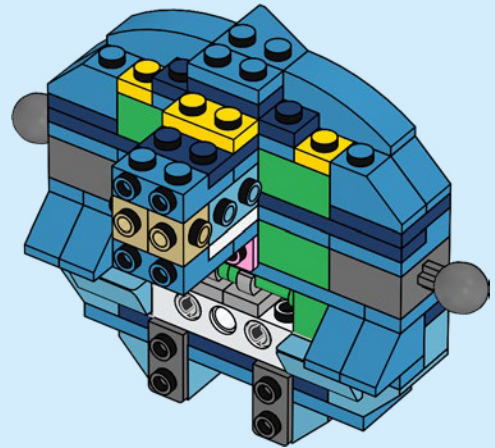



1x



1x

213

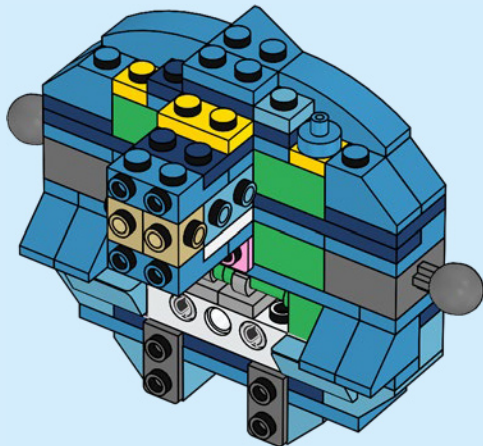

1x



2x



1x

214

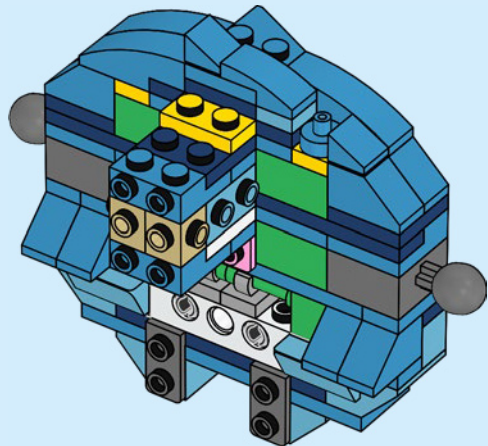



1x



1x

215

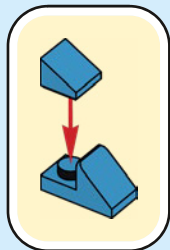

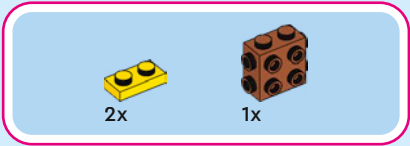

217

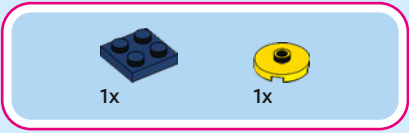
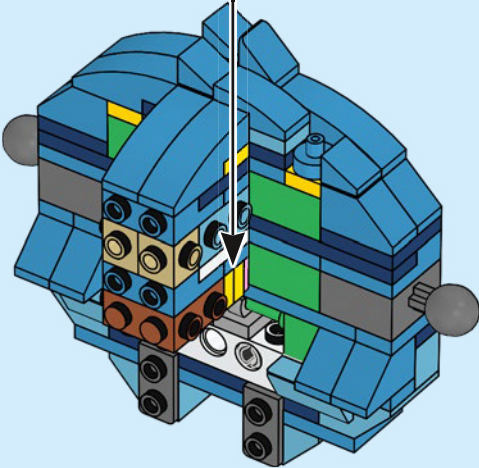
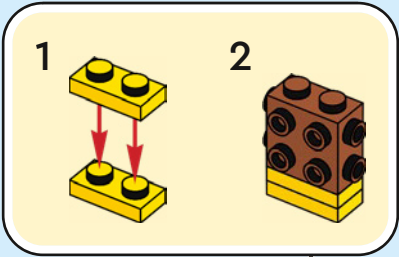

218

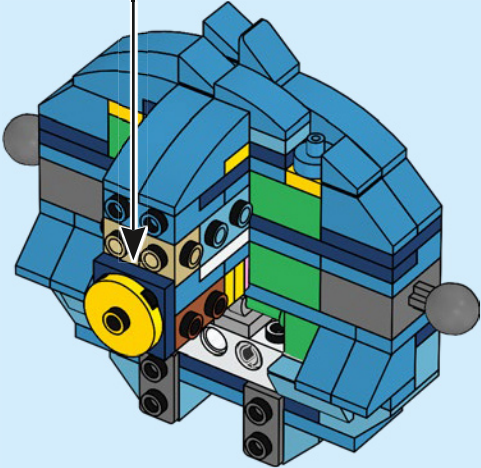
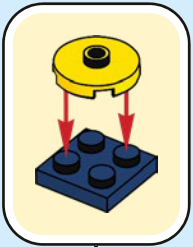



2x

219

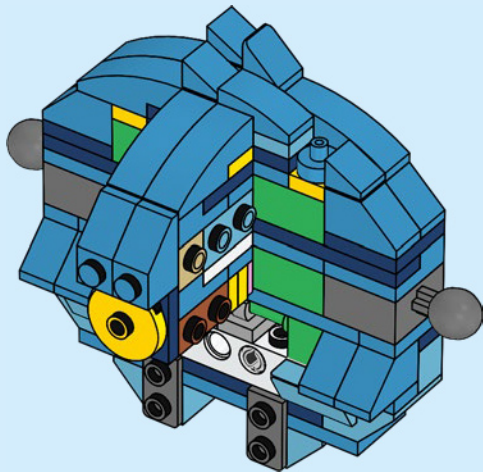

1x

220

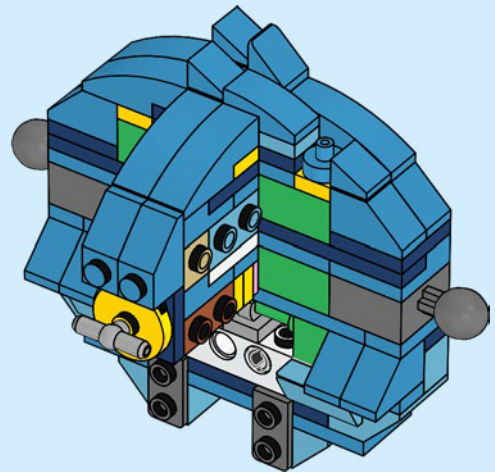

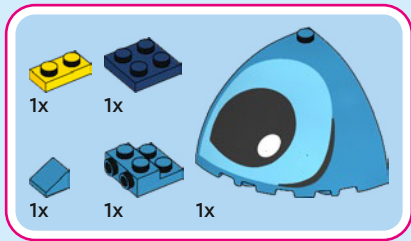

221

1

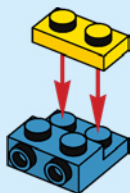

2



3

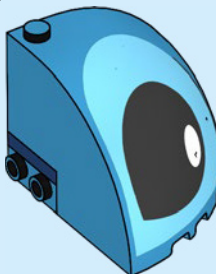

4

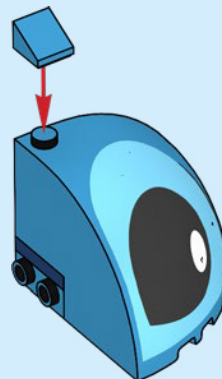

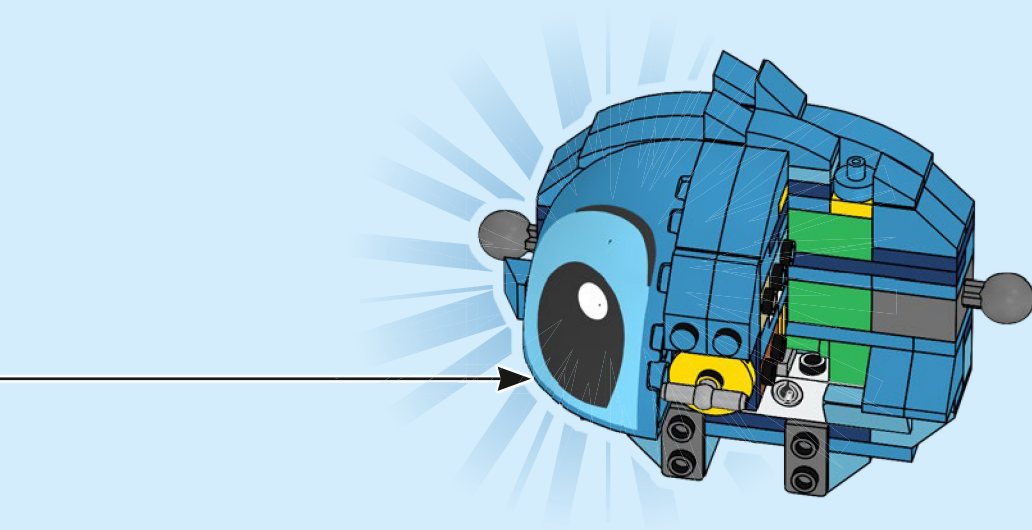

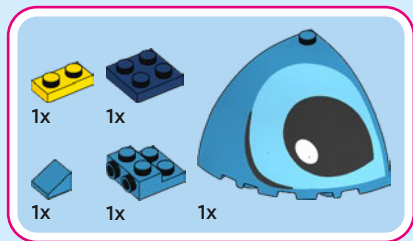

222

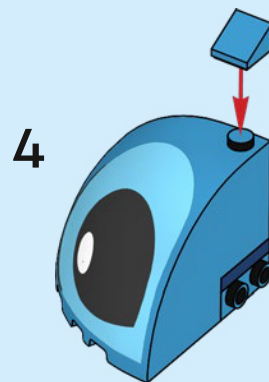
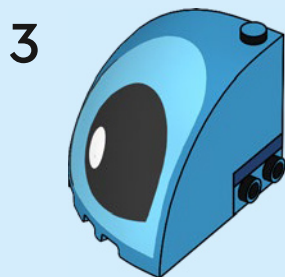
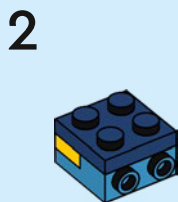
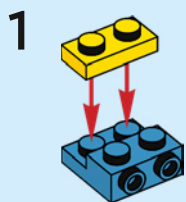

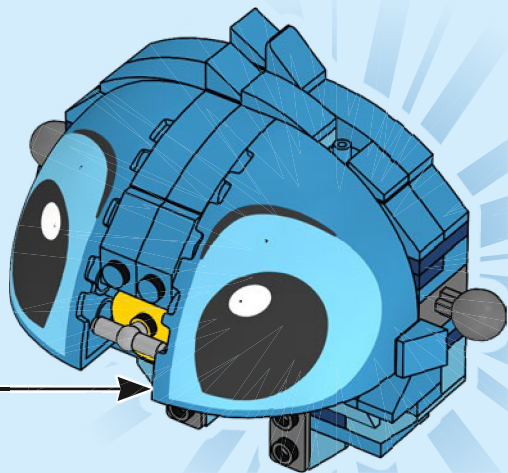

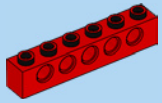

2x

223

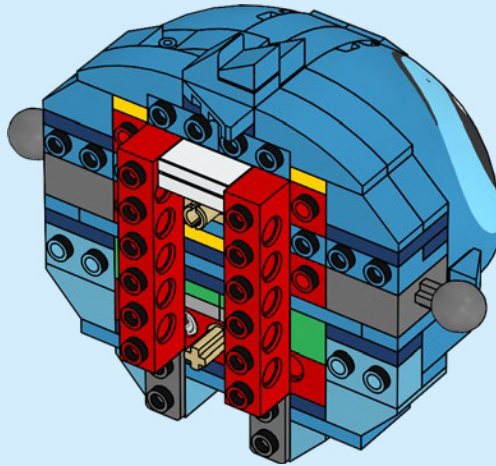



224

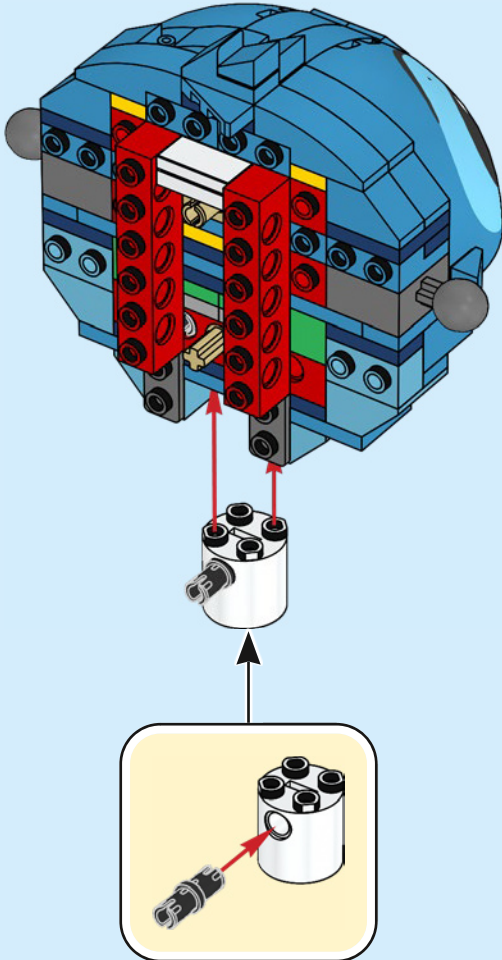

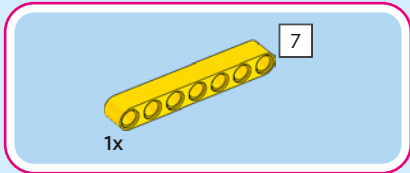

225

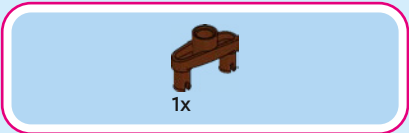
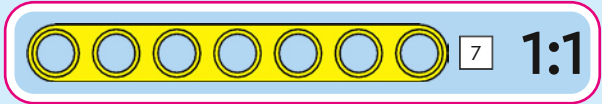
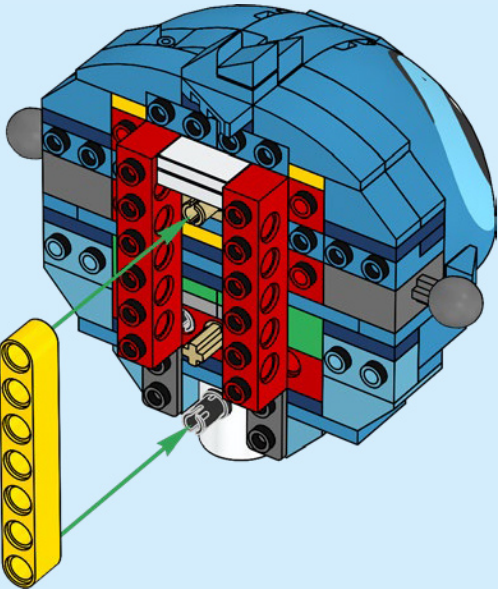

226

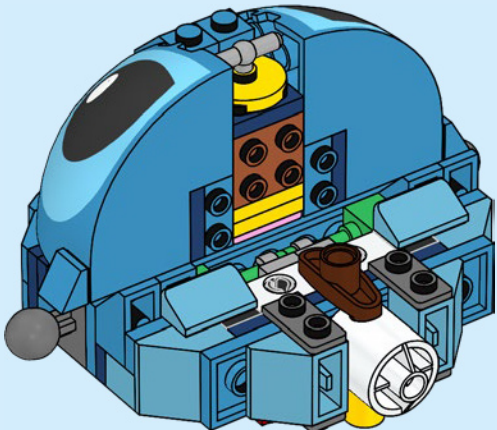



2x

227

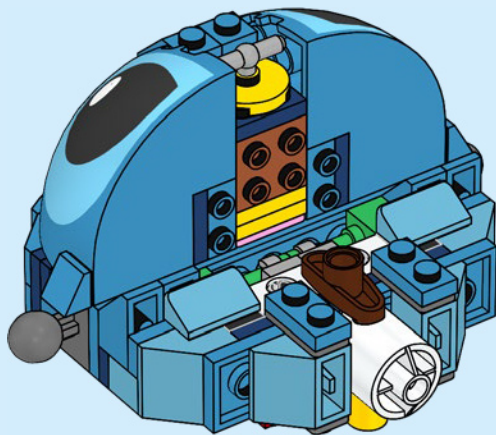

2x

228

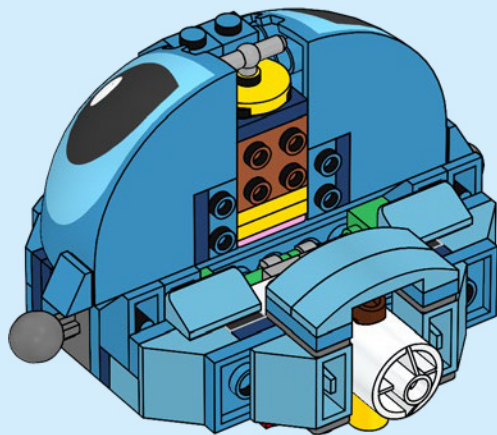

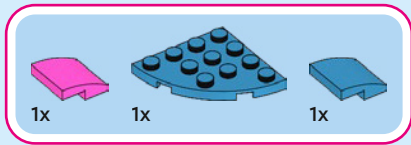

229

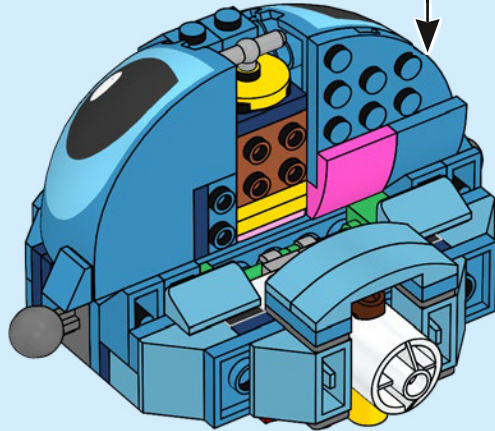
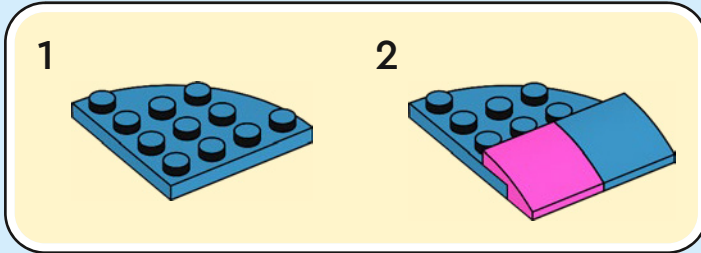

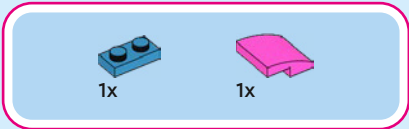

230

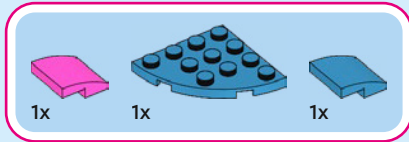
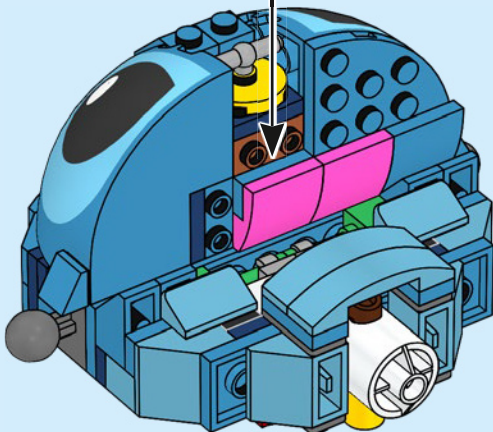
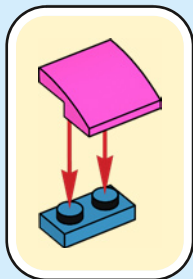

231

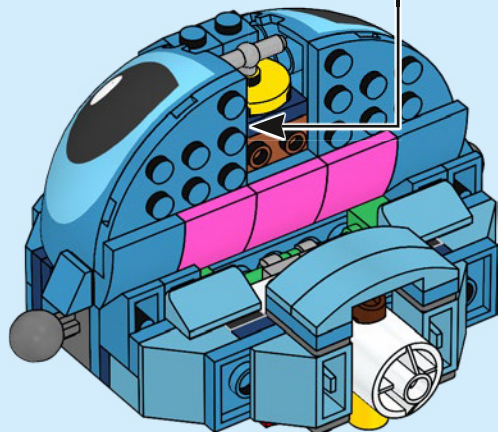
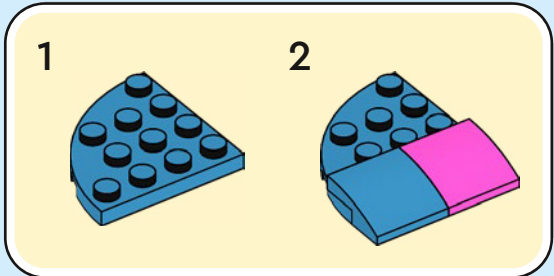

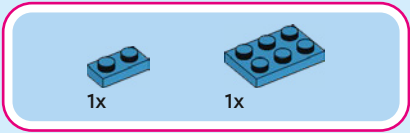

232

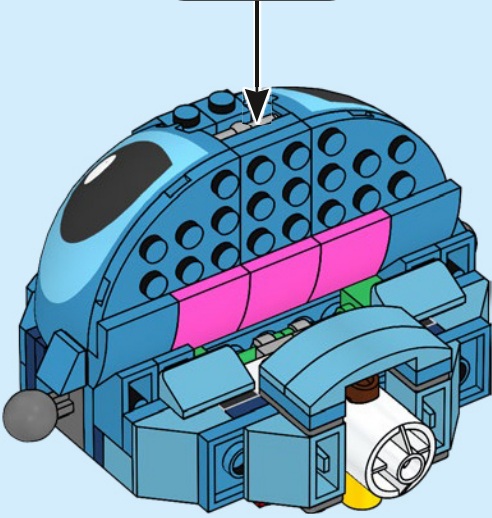
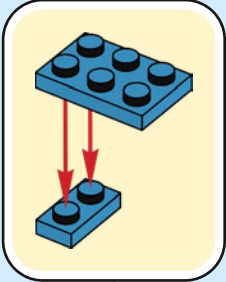

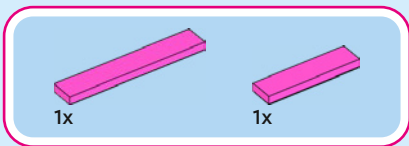

233

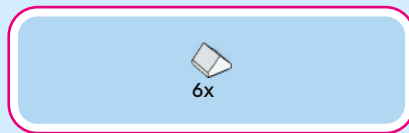
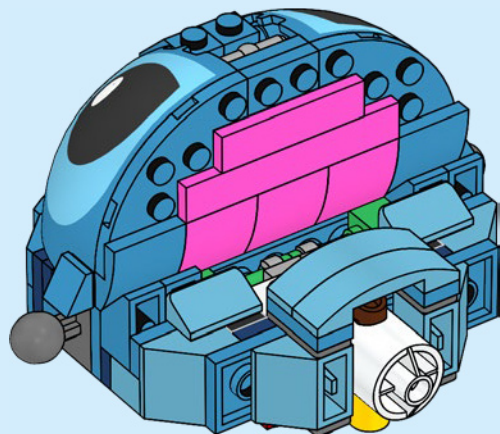

234

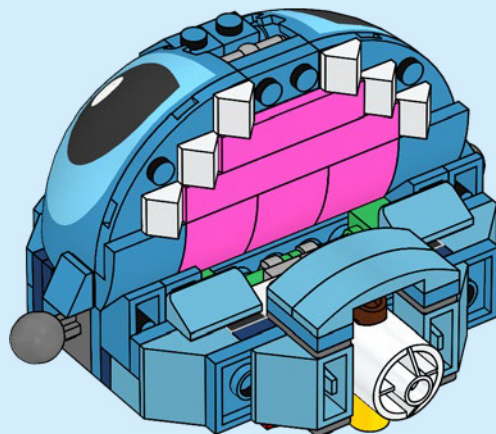



1x

1x

235

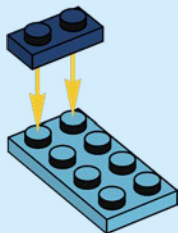

1x

236

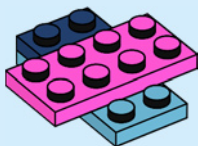

2x

237

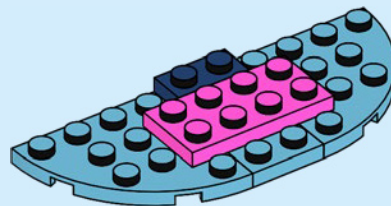

2x

238

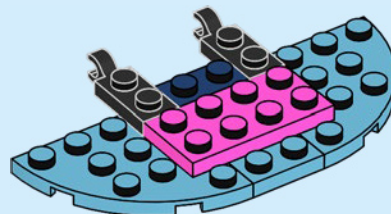

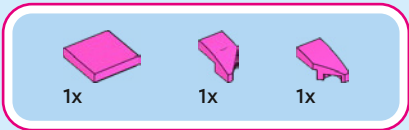

239

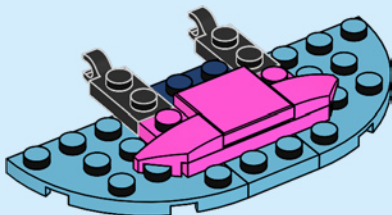

240

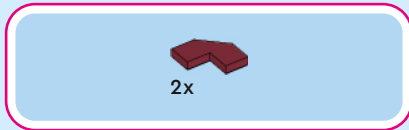
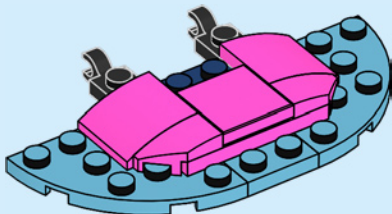

241

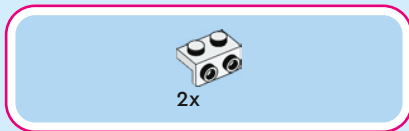
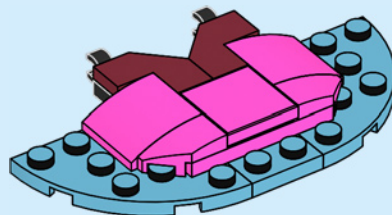

242

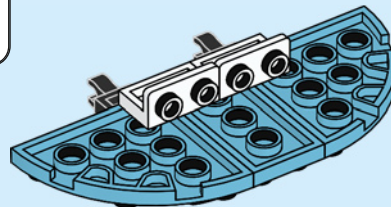



2x

243

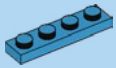
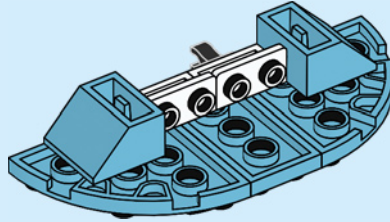

1x



1x



2x

244

1

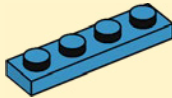

2

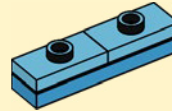

3

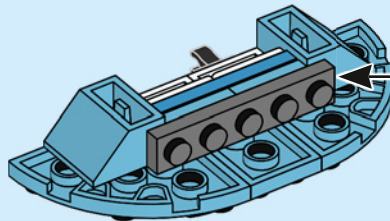
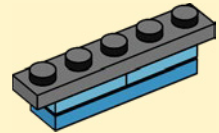

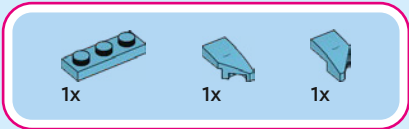

245

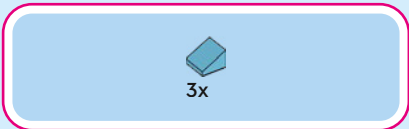
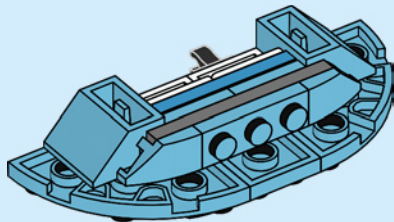

246

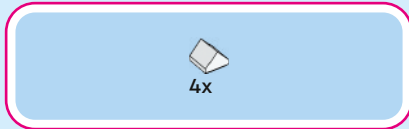
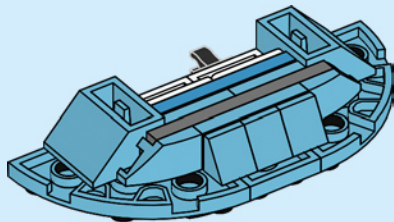

247

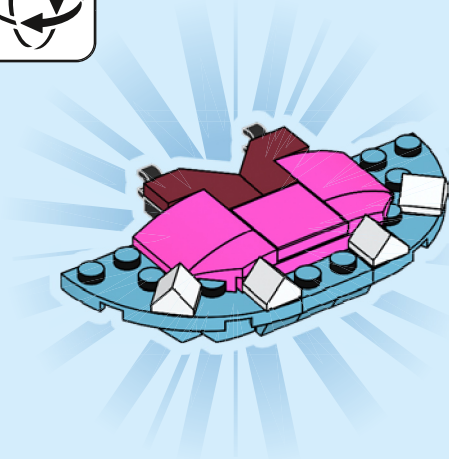
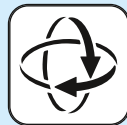

248

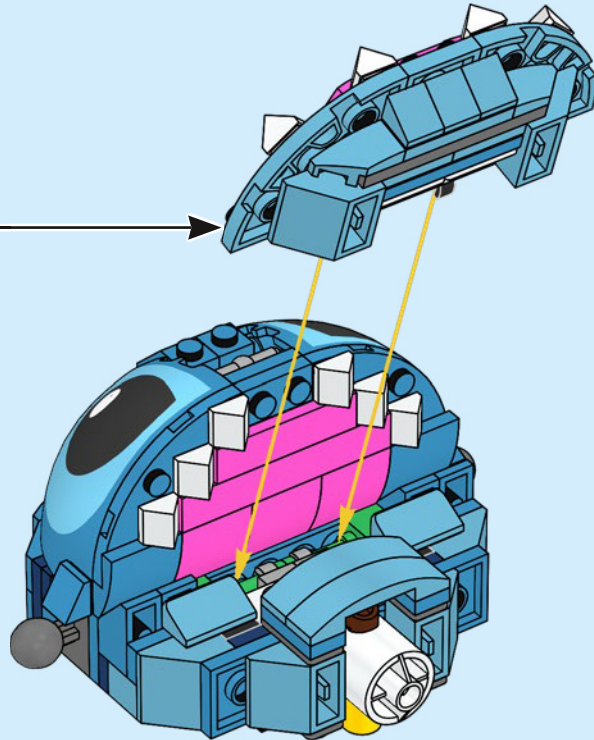

249

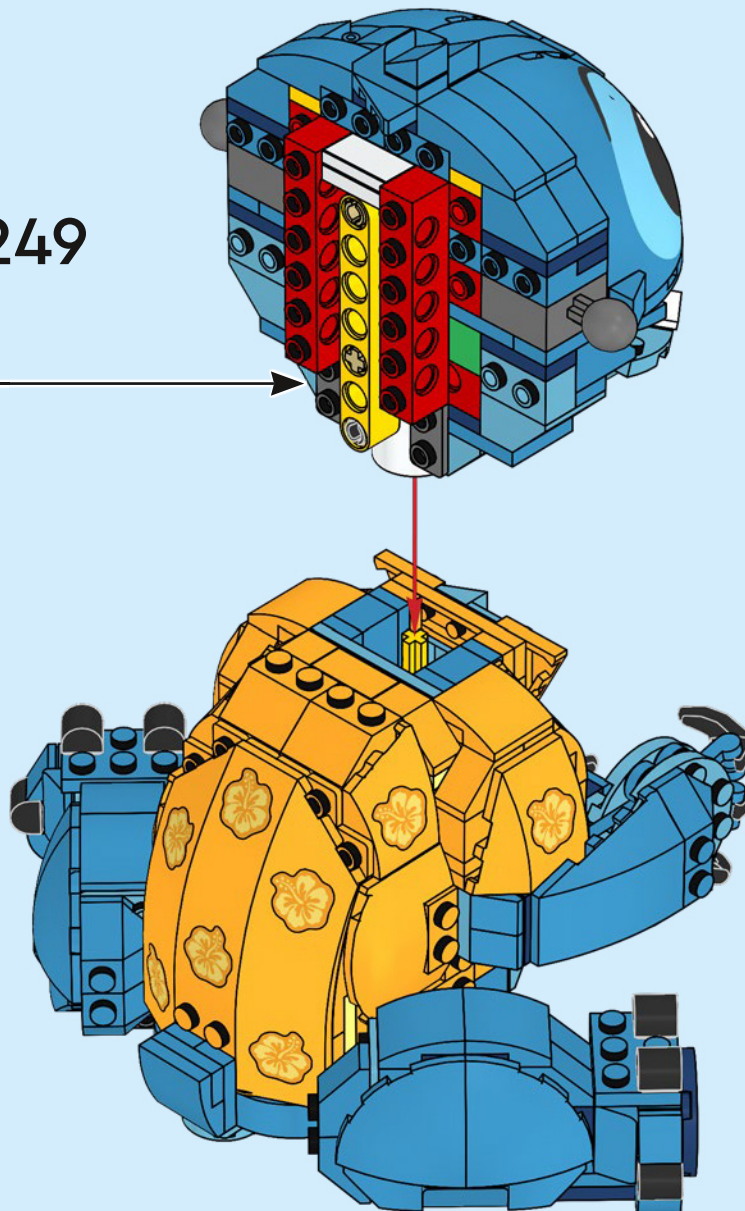



2x



2x

250

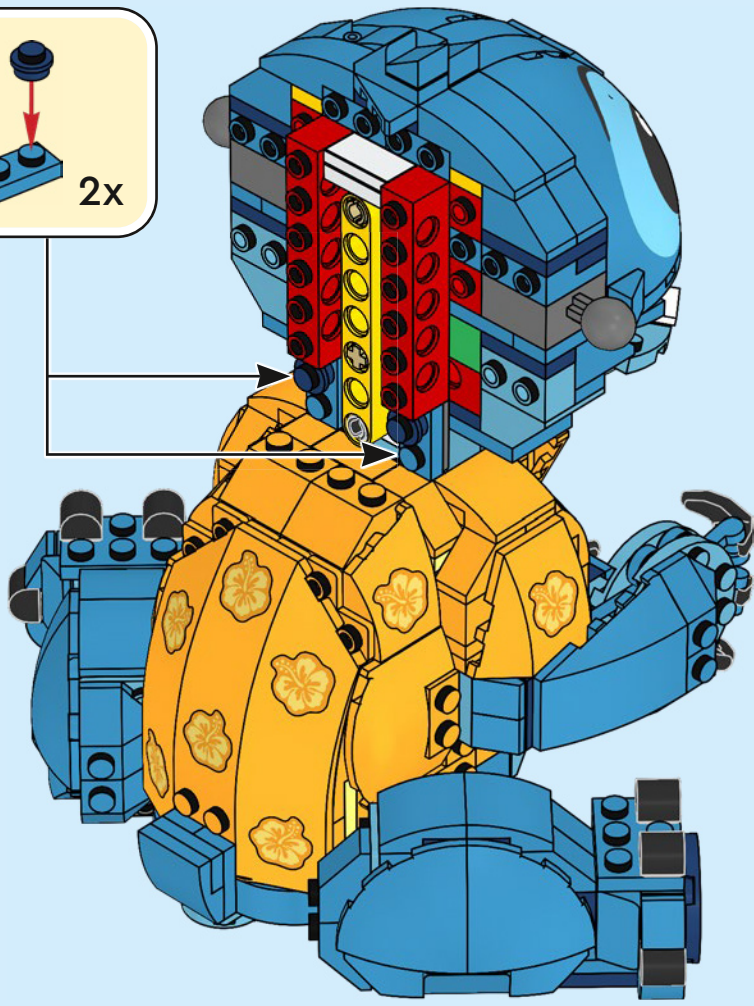
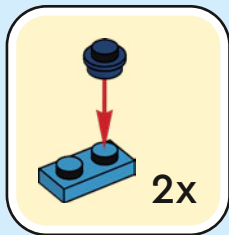



2x

251

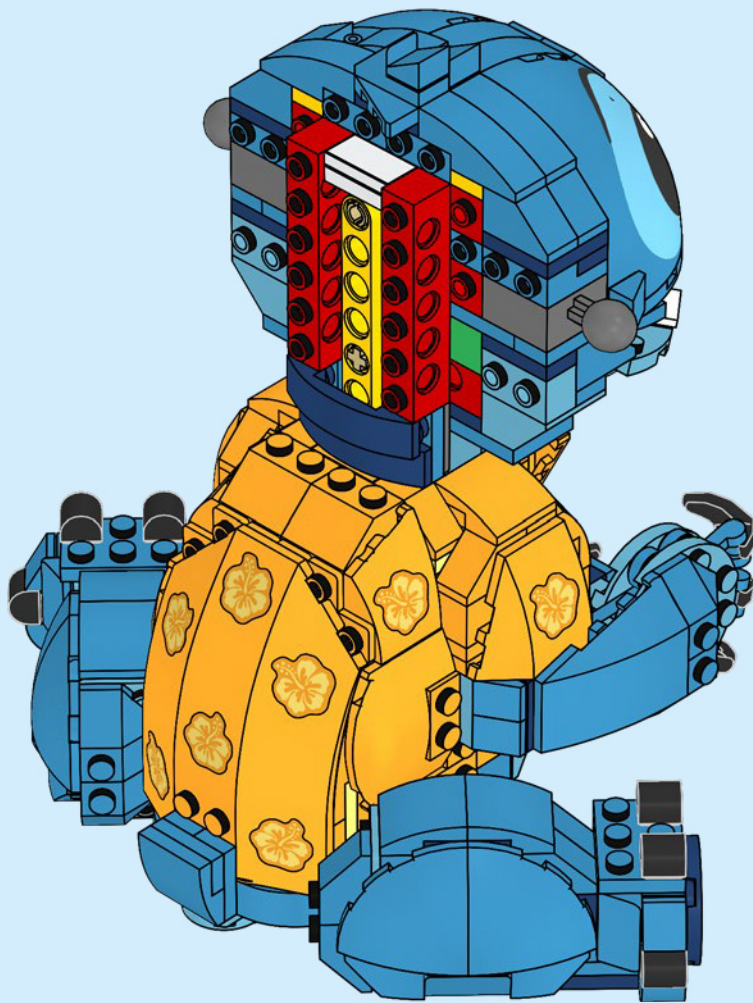

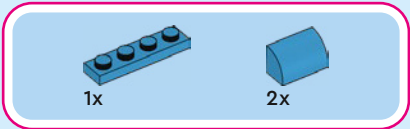

252

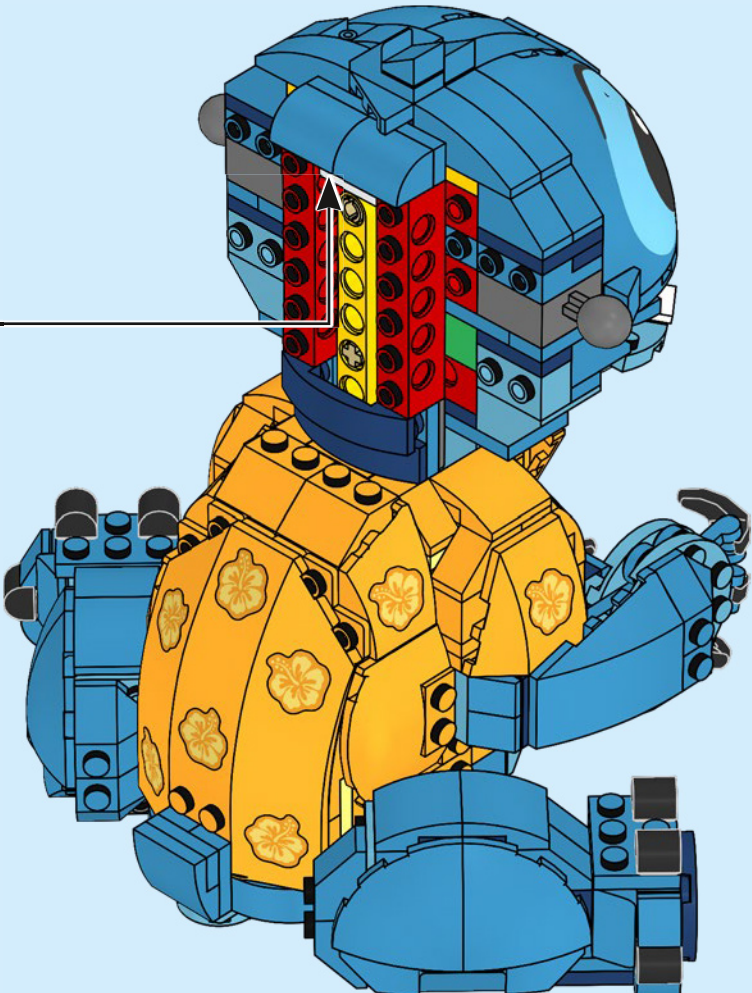
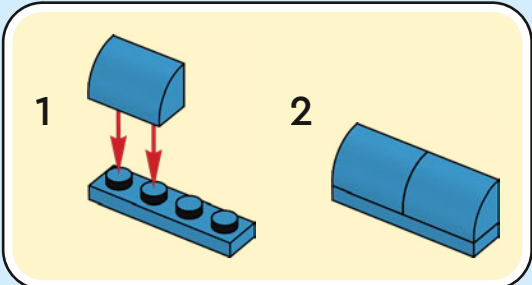

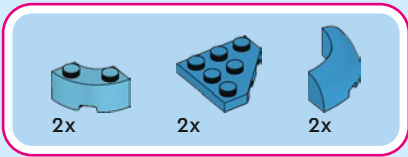

253

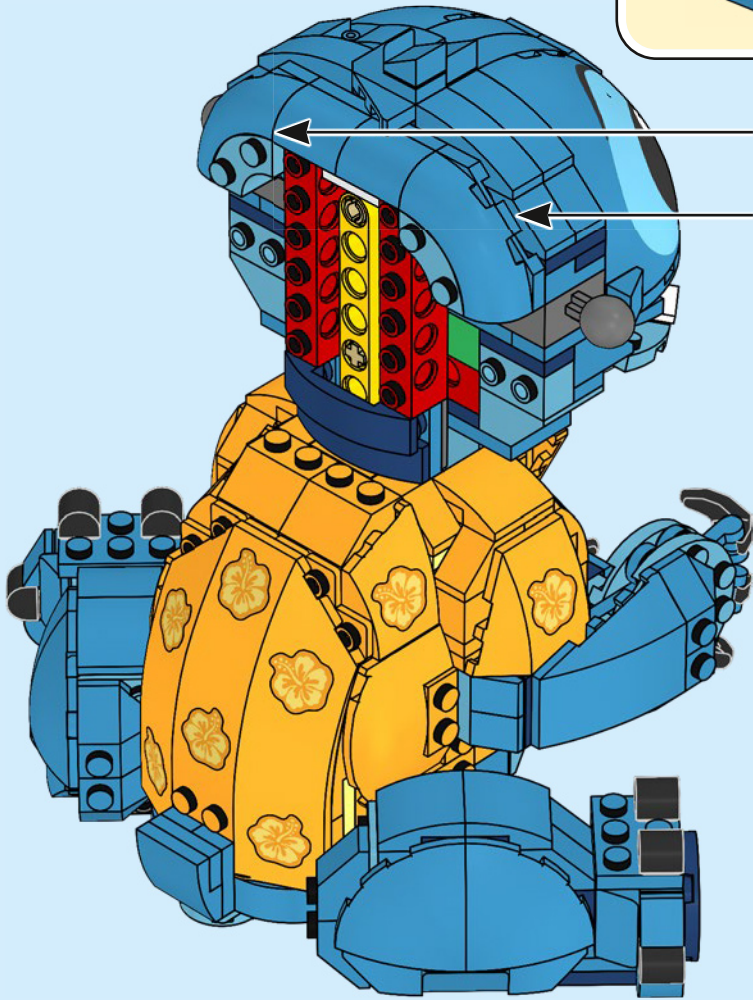
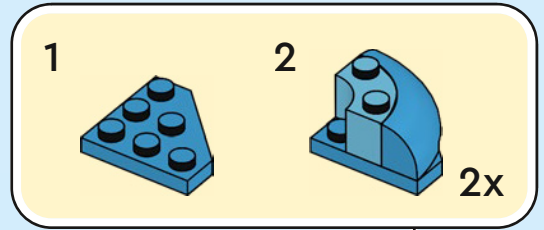

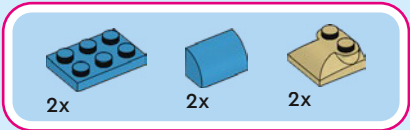

254

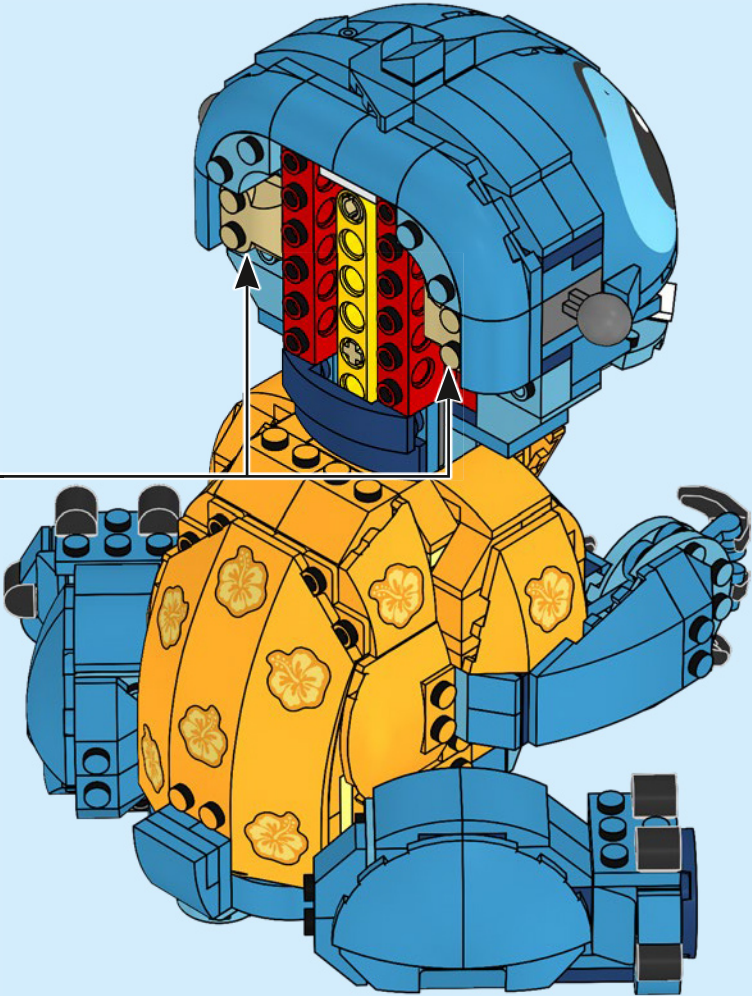
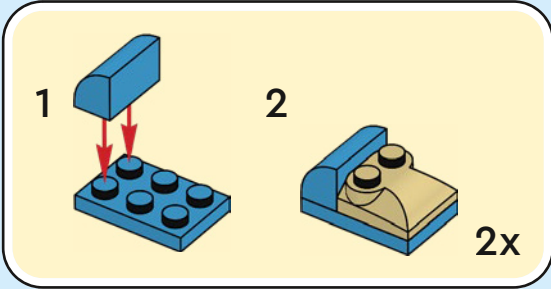

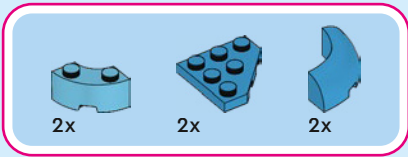

255

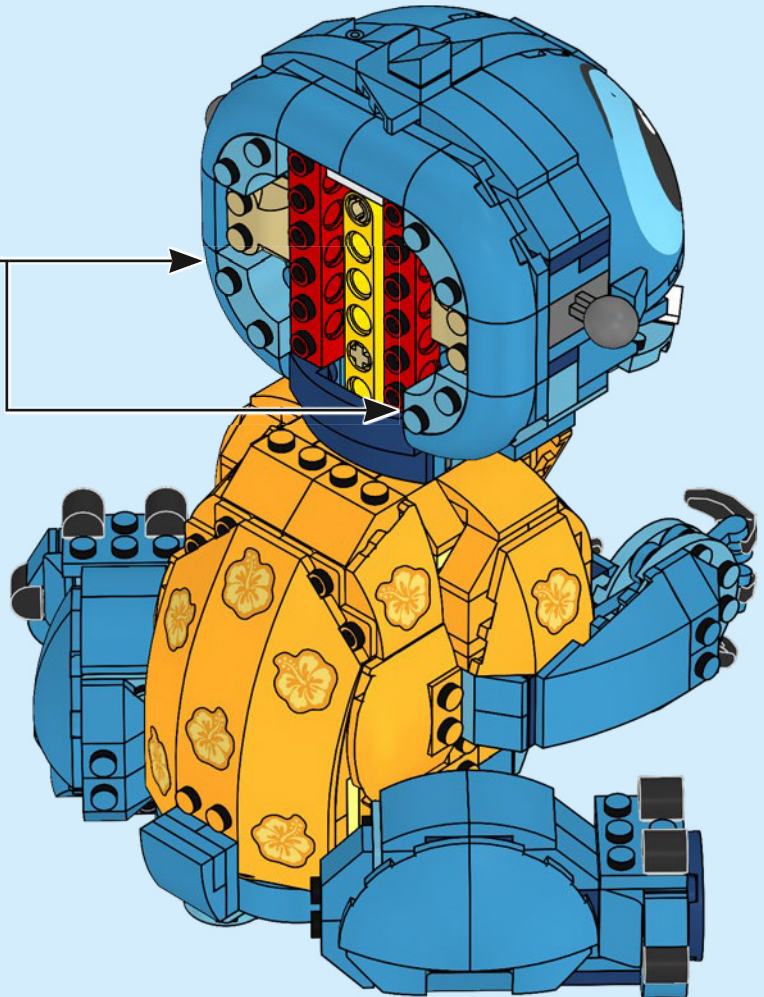
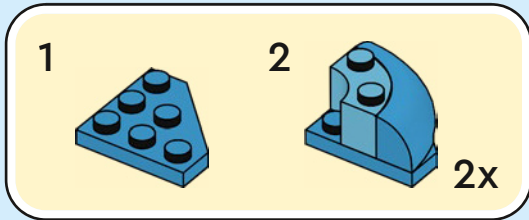

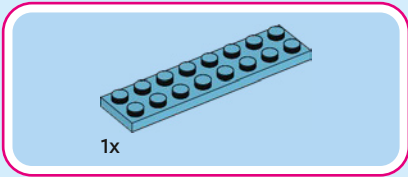

256

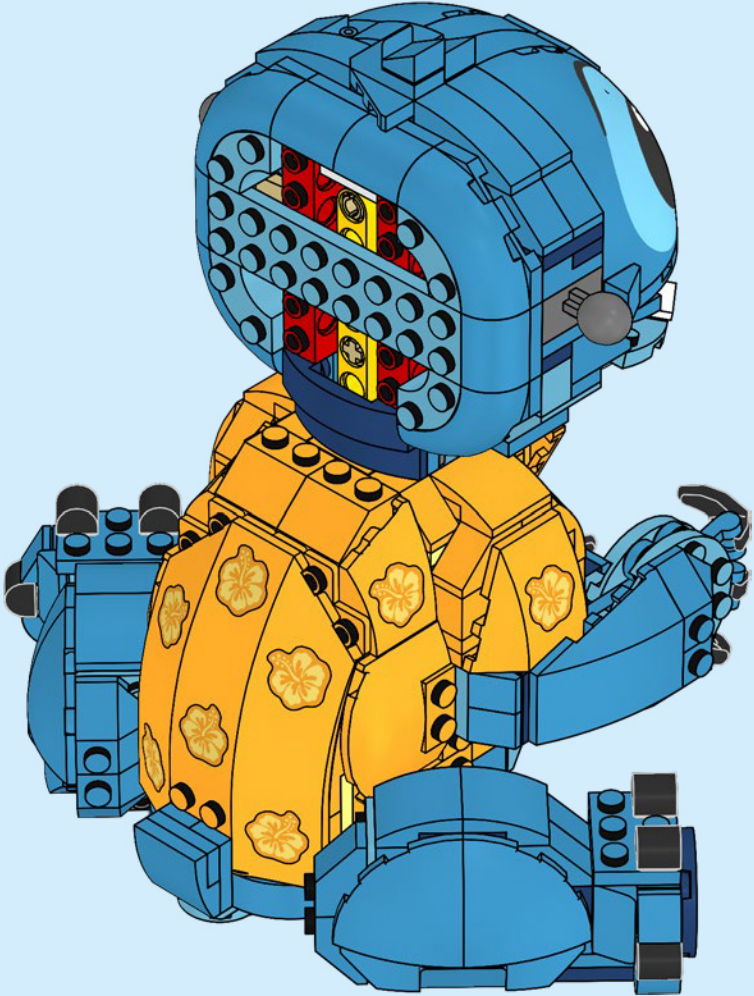

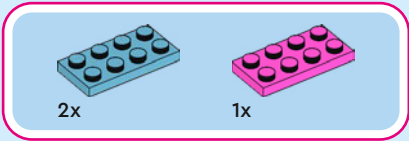

257

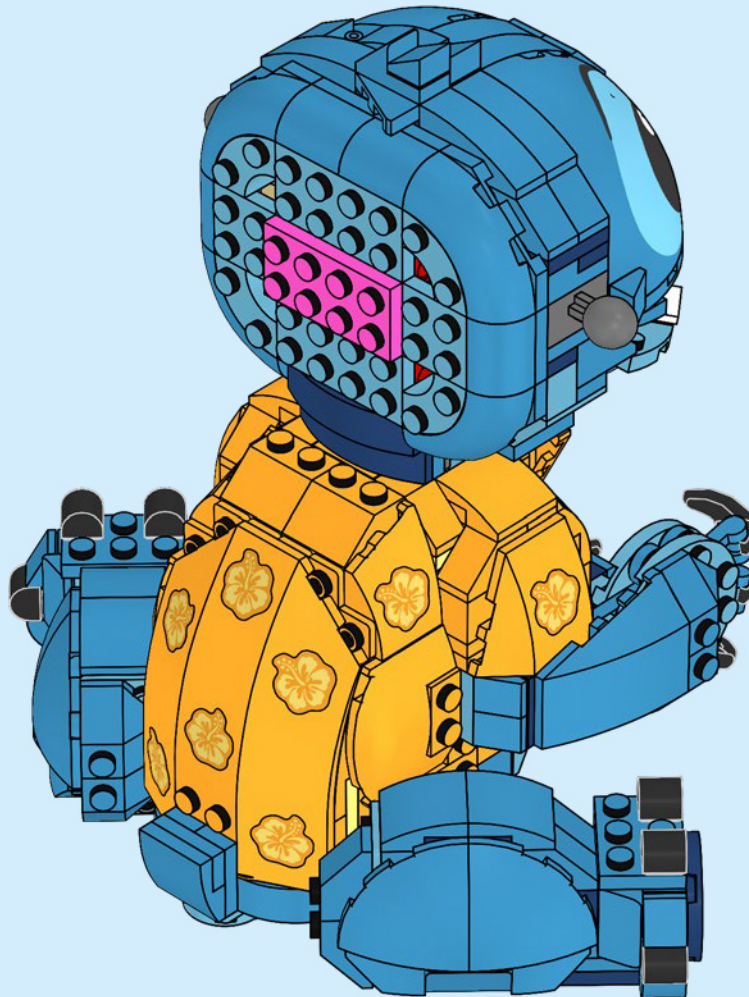



4x

258

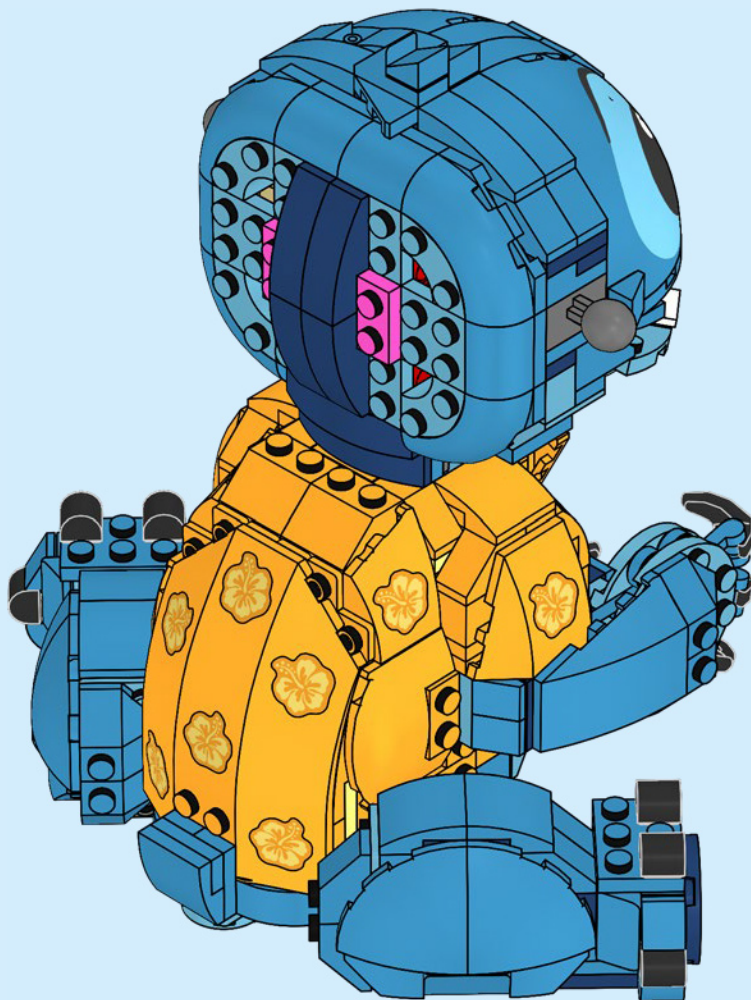



2x



2x

259

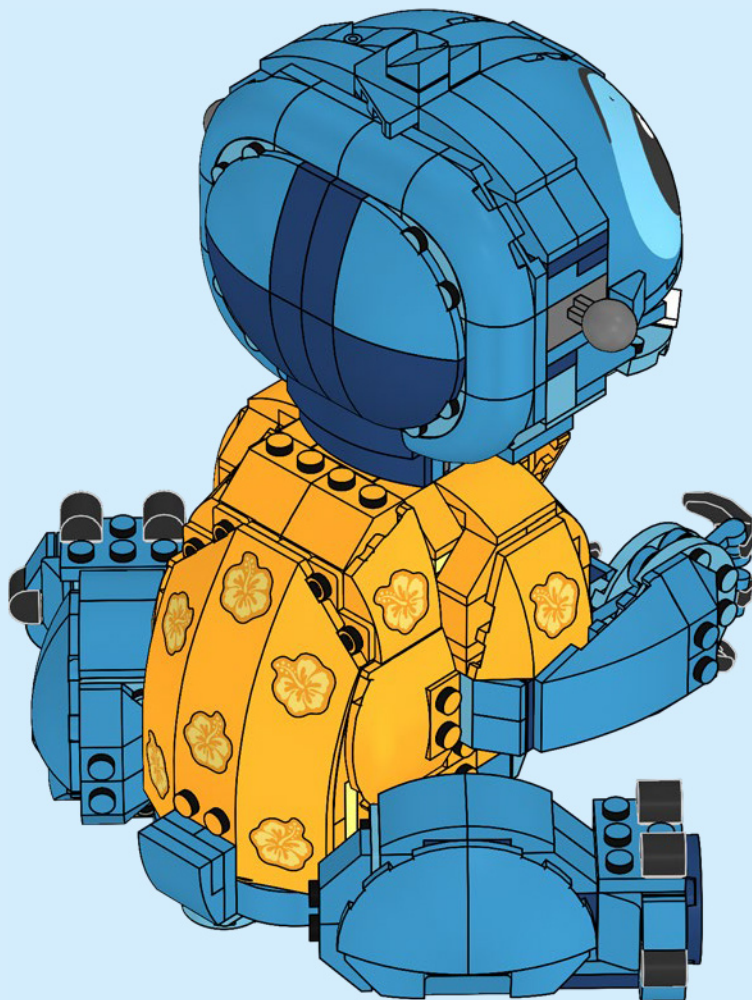

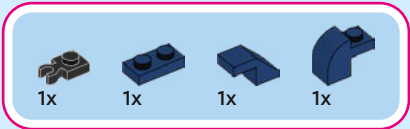

260

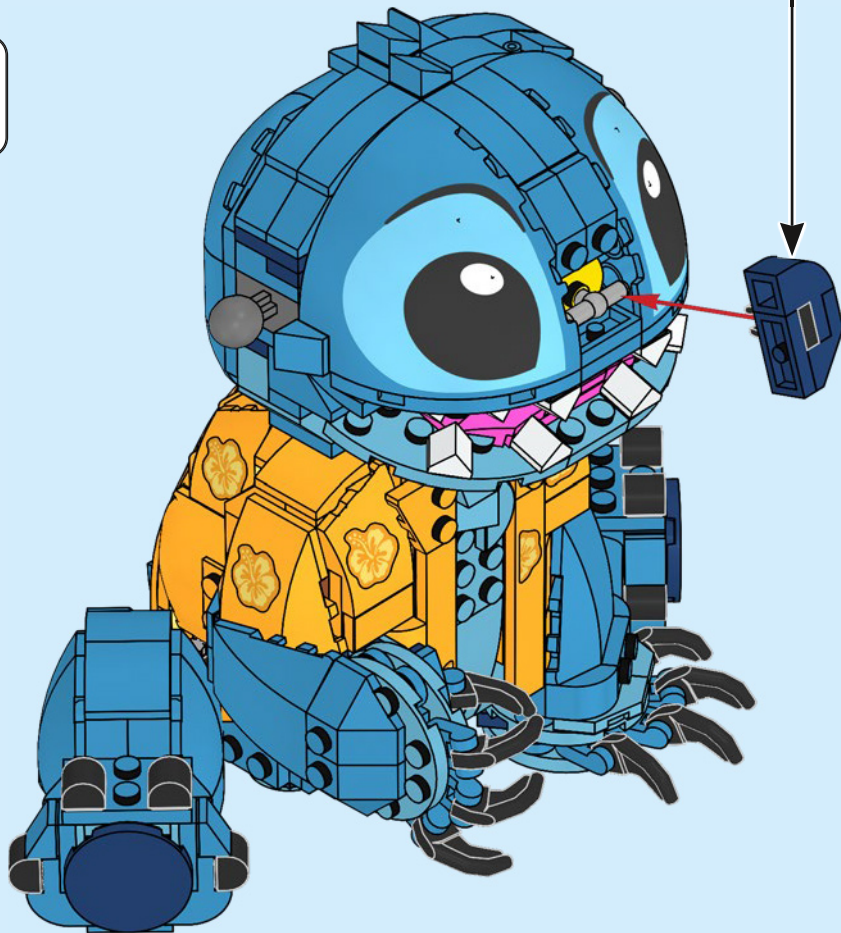
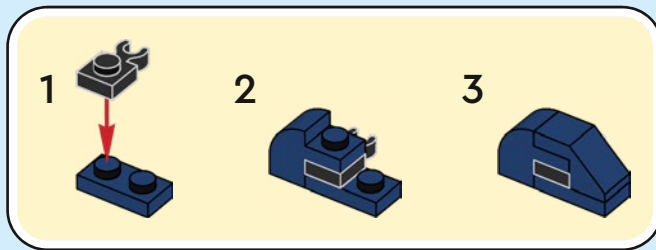
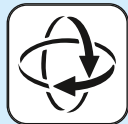

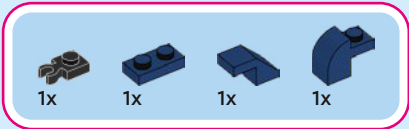

261

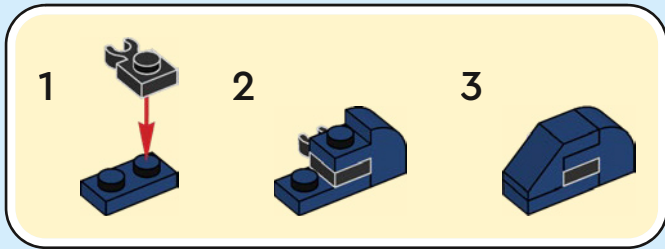

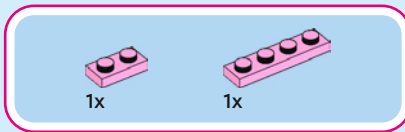
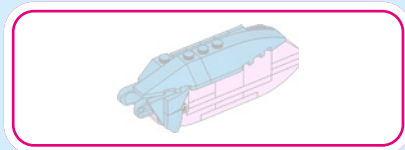

262

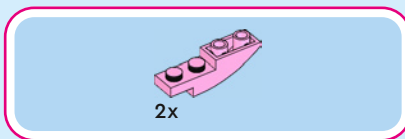
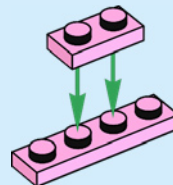

263

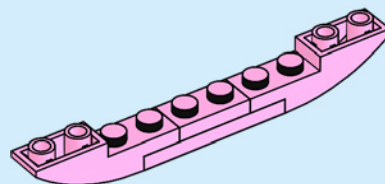

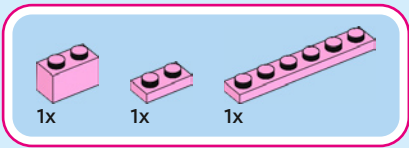

264

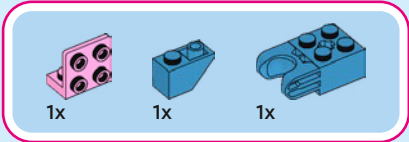
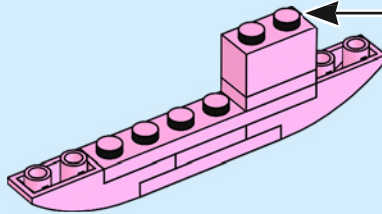
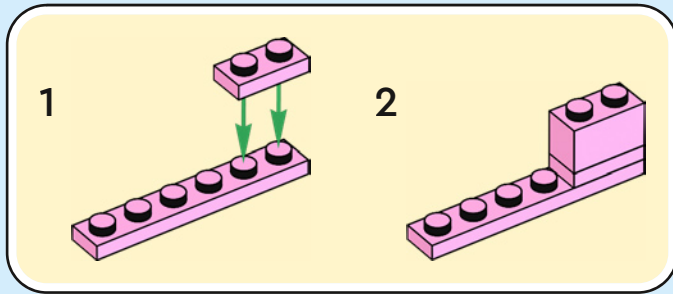

265

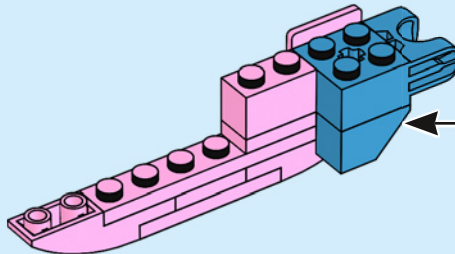
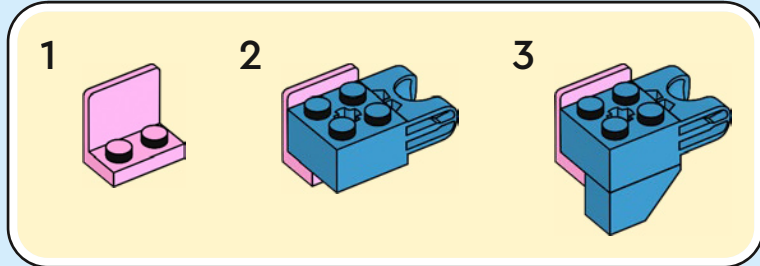



1x

266

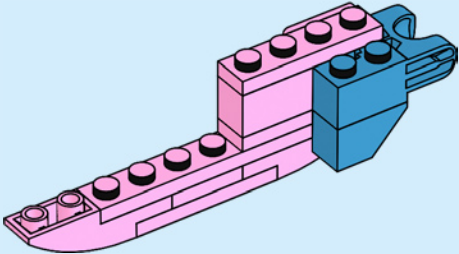

2x

267

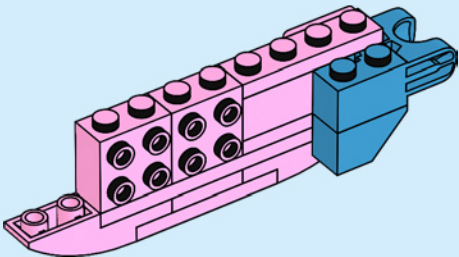

1x



2x

268

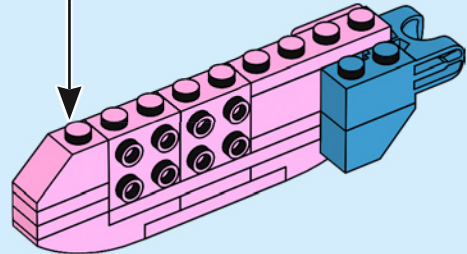
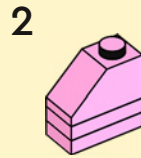
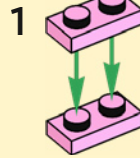

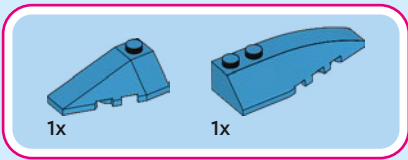

269

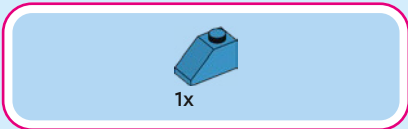
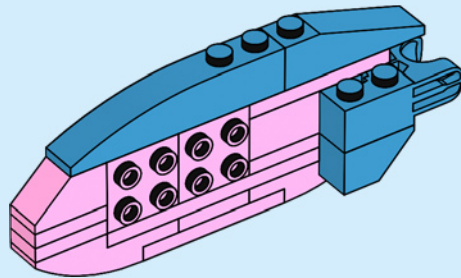

270

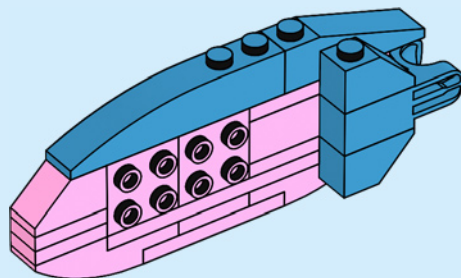

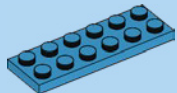
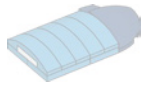

1x

271

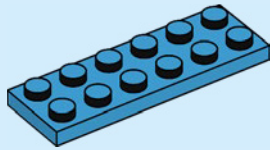

1x

272

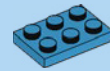
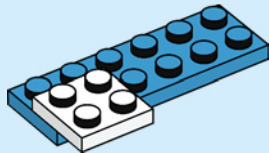

1x

273

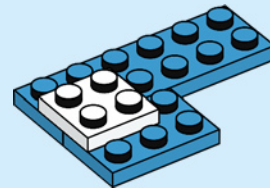

1x

274

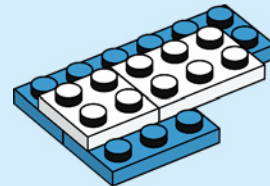



1x

275

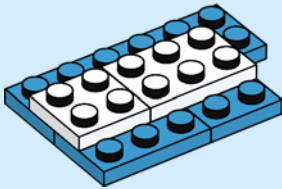

5x

276

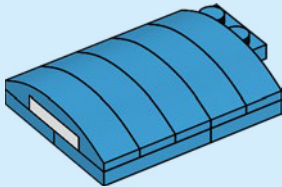

1x

277

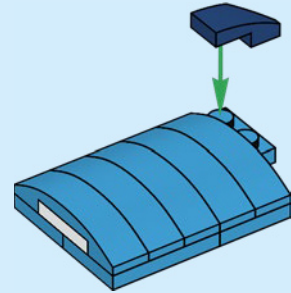

1x

278

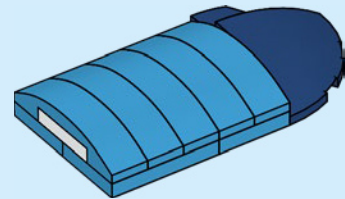

279

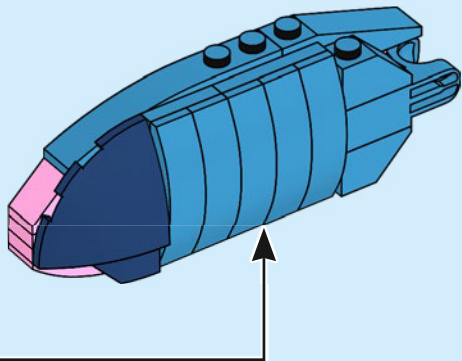

1x

280

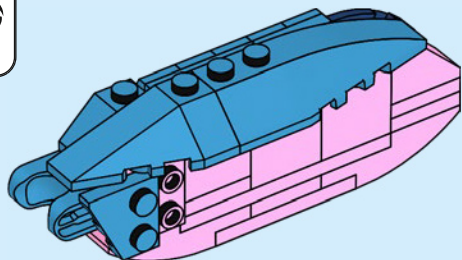

2x

281

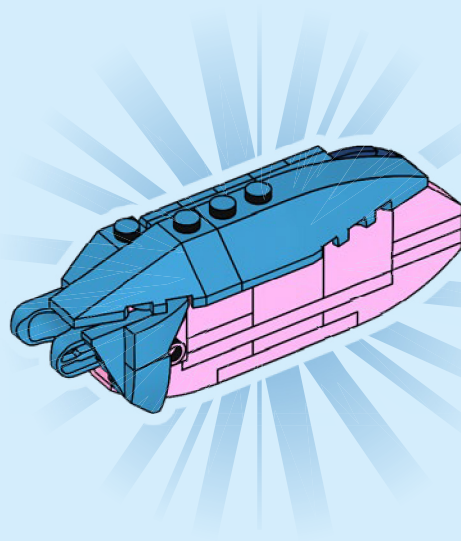

282

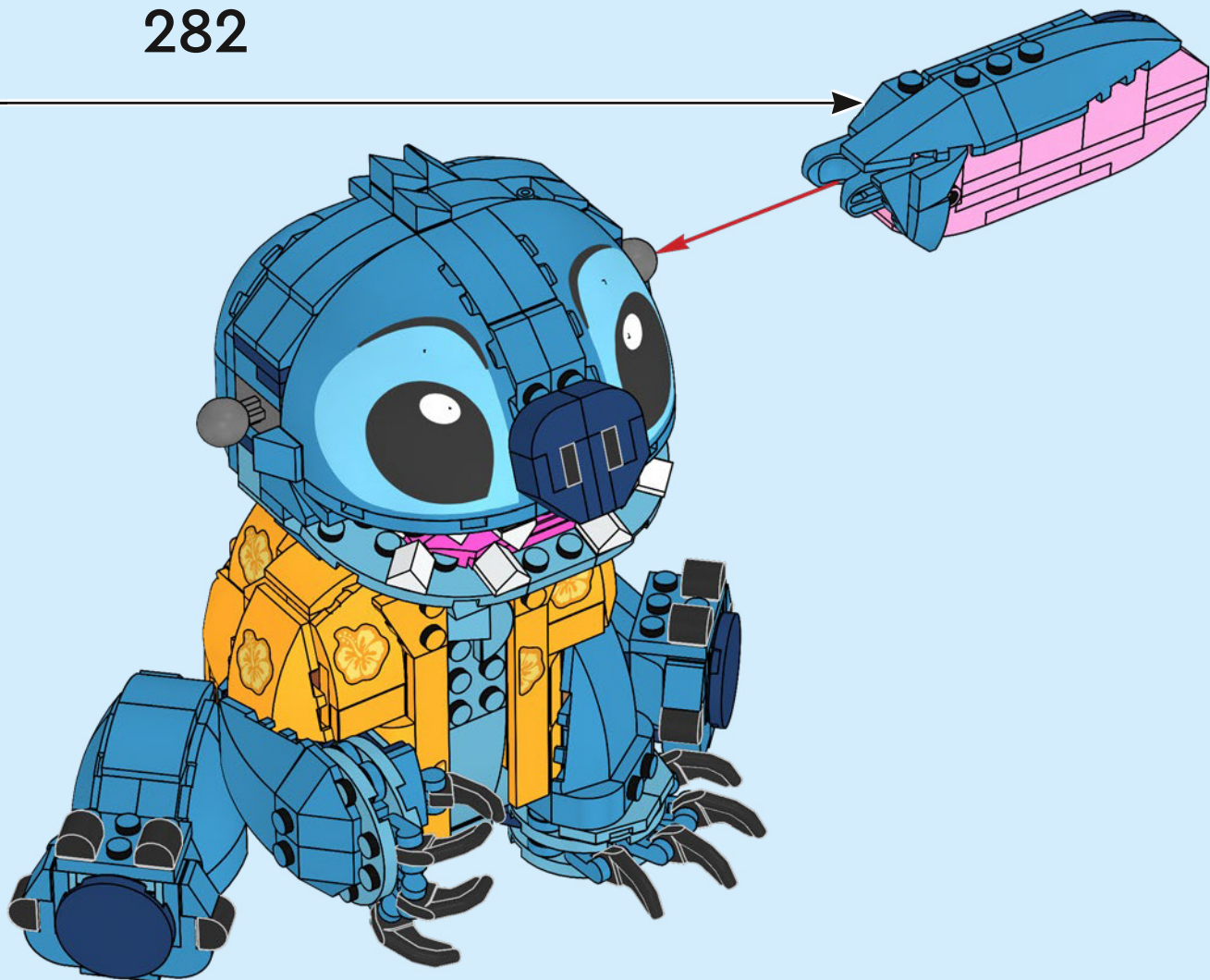

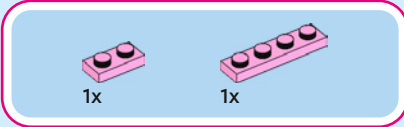
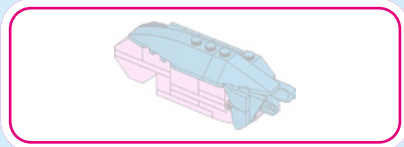

283

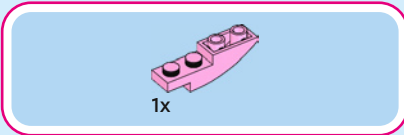
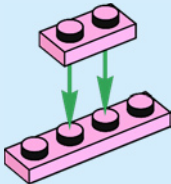

284

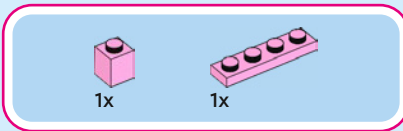
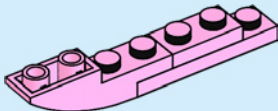

285

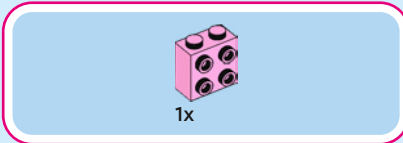
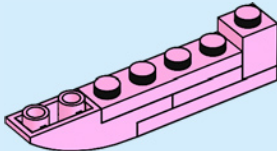

286

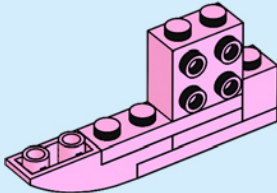

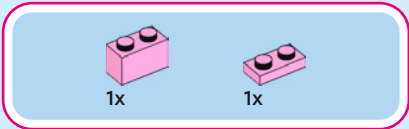

287

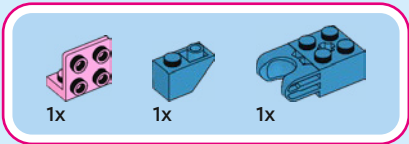
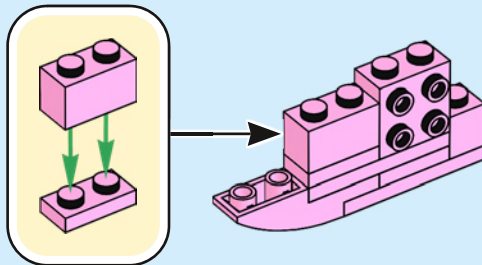

288

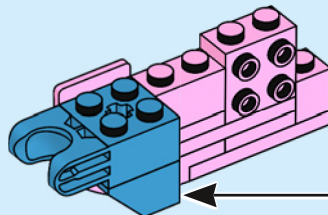
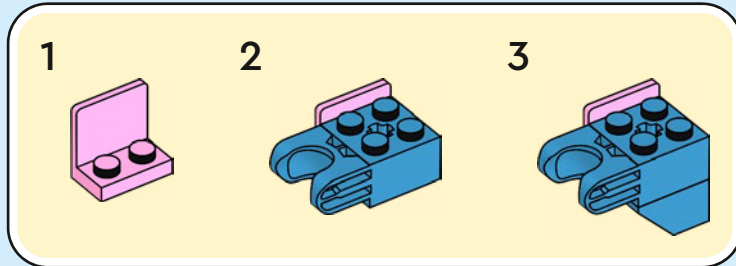



1x

289

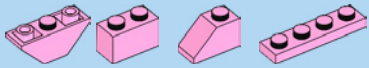
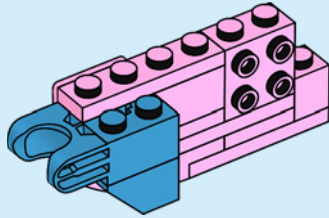

1x

1x

1x

1x

290

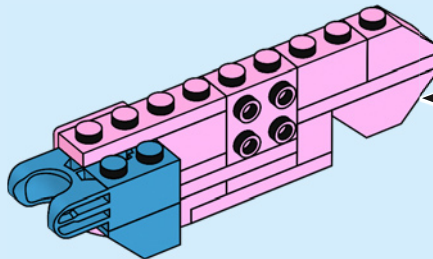
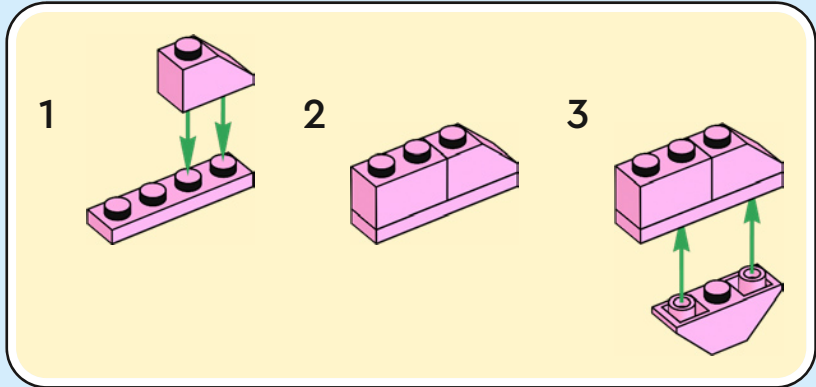

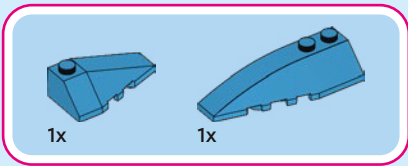

291

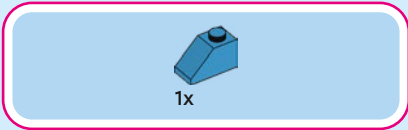
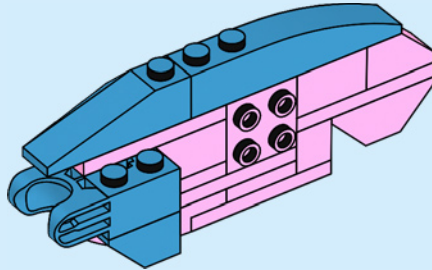

292

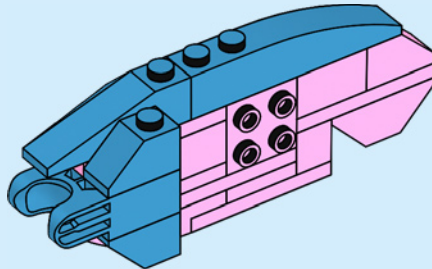



1x

293

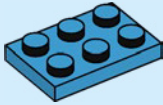

1x

294

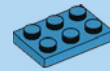
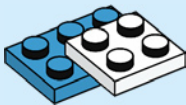

1x

295

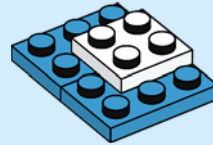

1x

296

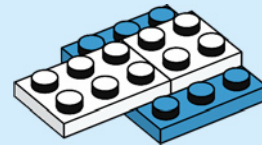

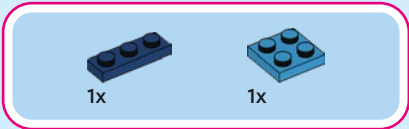

297

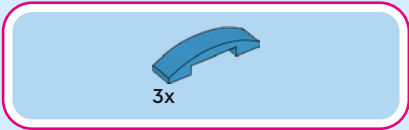
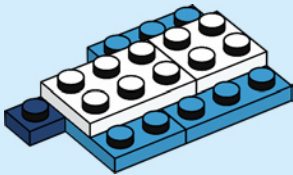

298

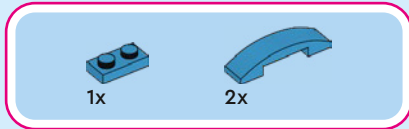
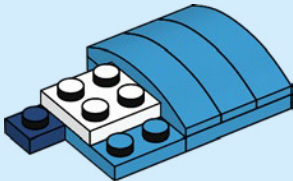

299

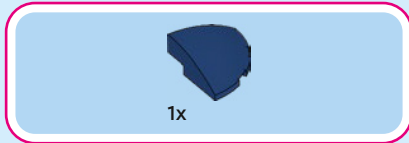
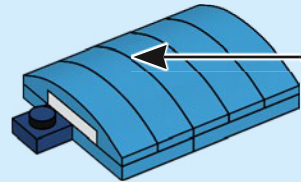
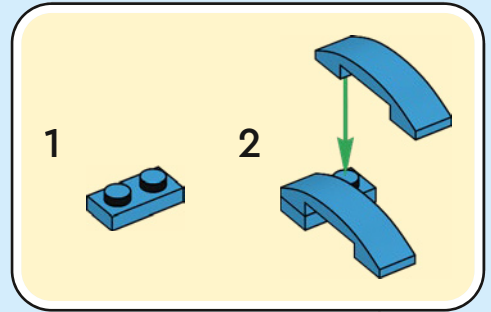

300

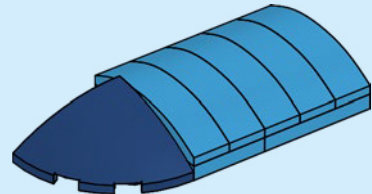

301

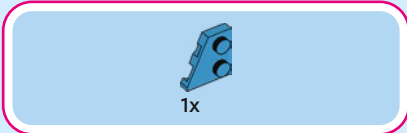
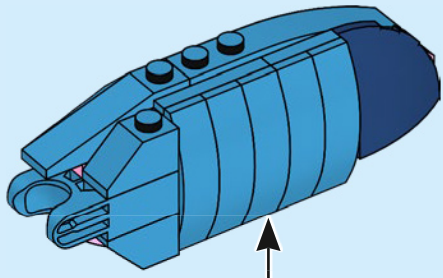

302

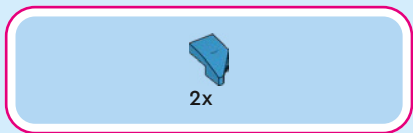
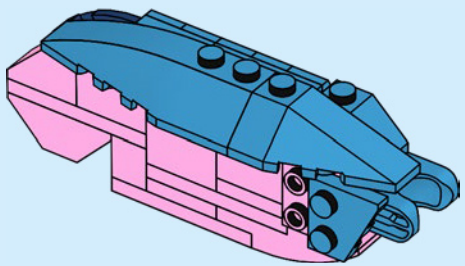
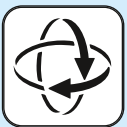

303

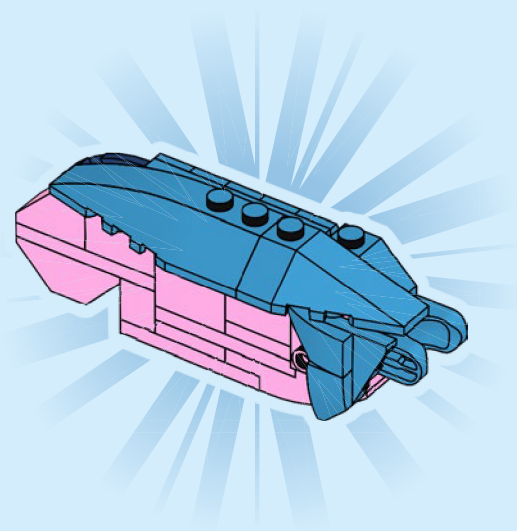

304



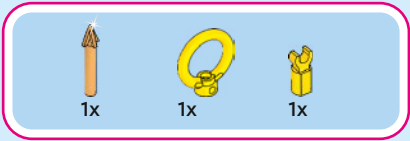

305

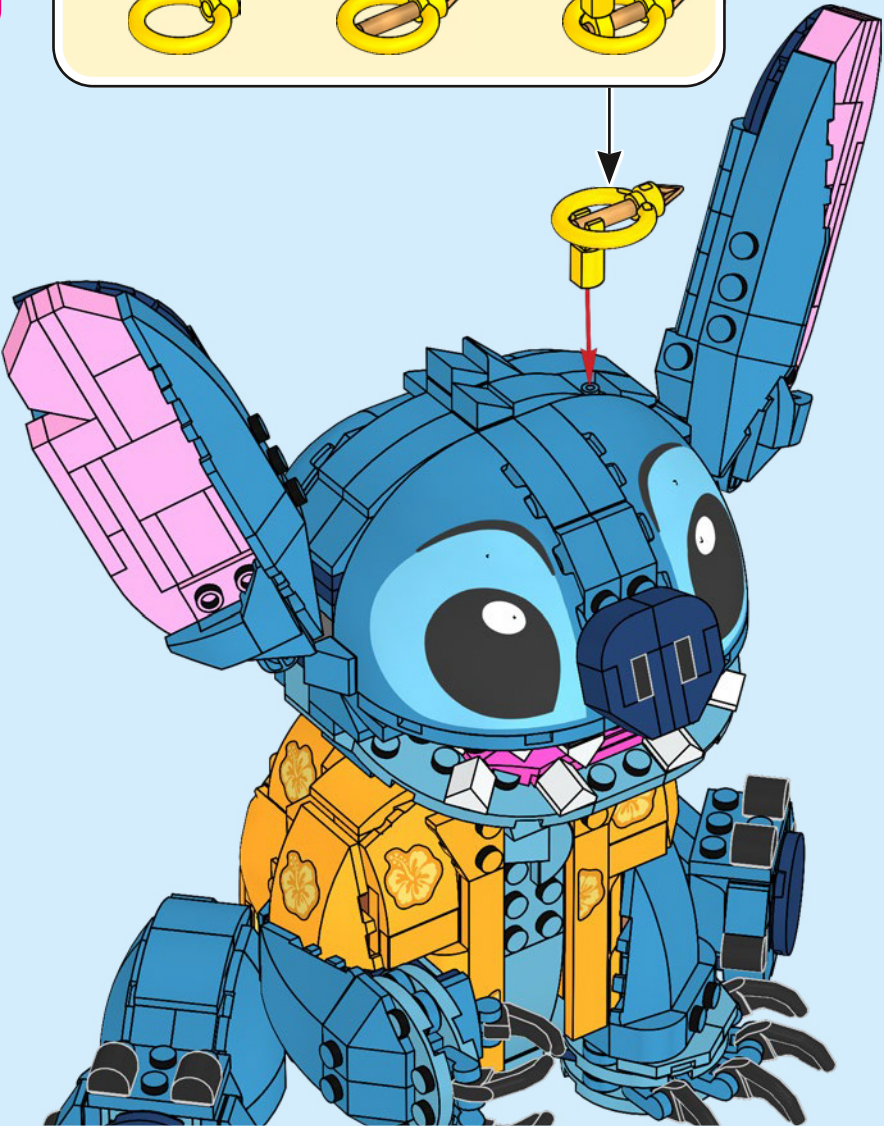
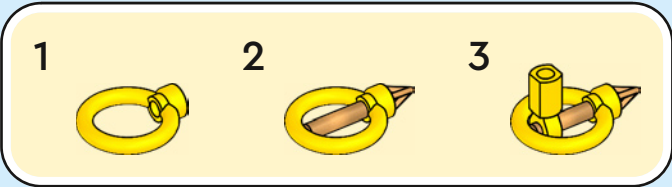



1x



1x



1x

306

1



2



3





5x



10x



5x



5x



5x

307

1



2

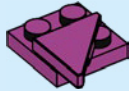

3



4

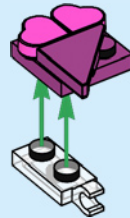

5x

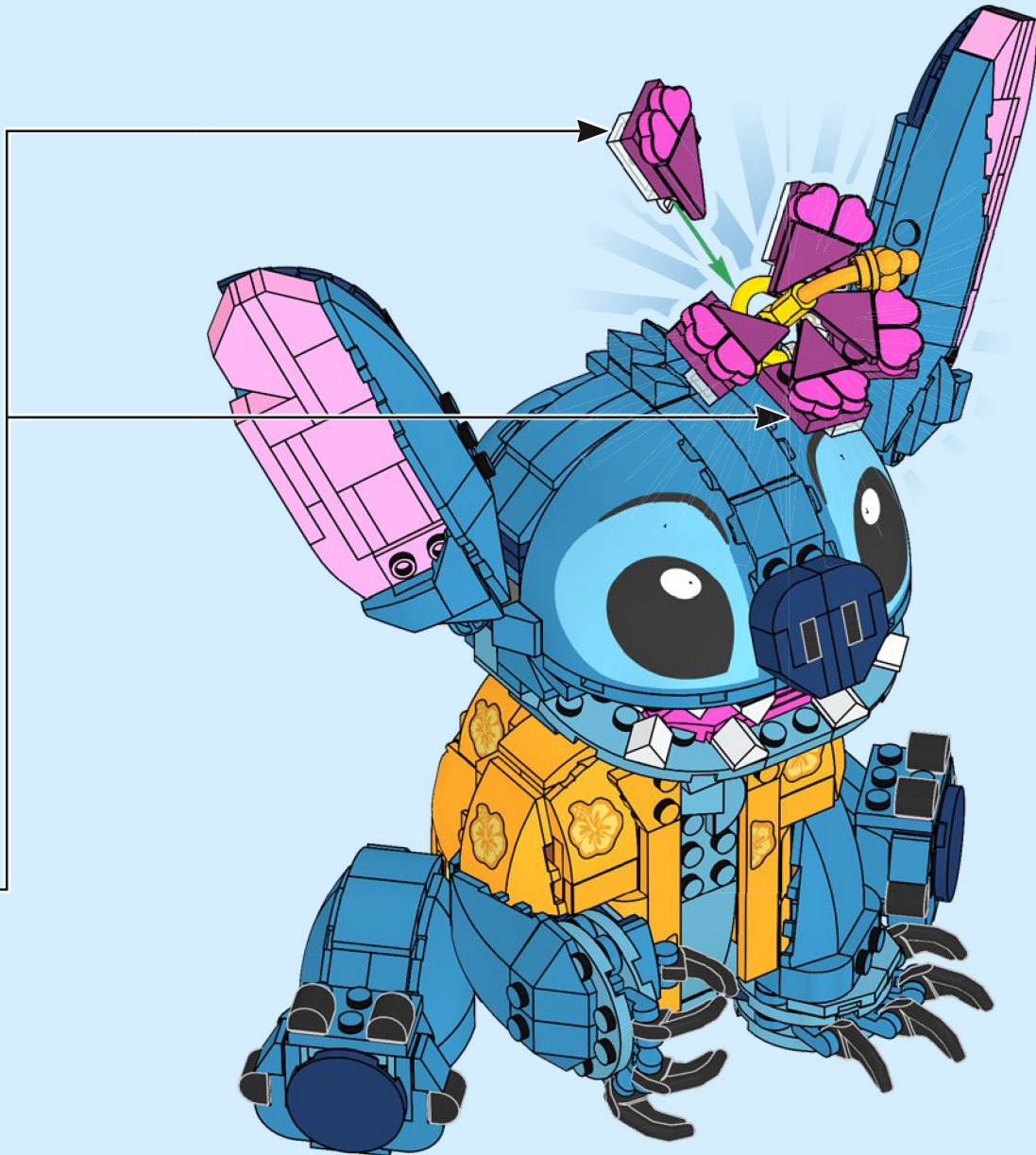

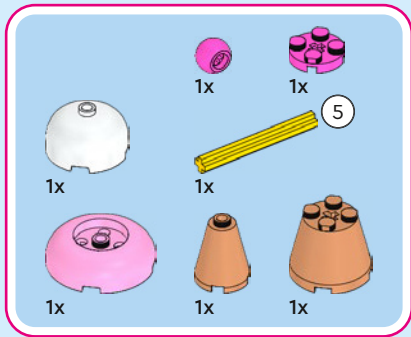

308

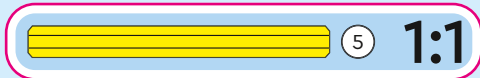
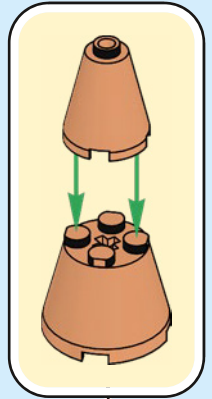
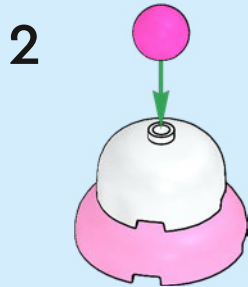
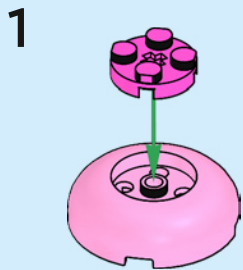







Disney

Disney
Stitch

43249



Disney
ENCANTO

43237



10x
6286834

1x
4194010

1x
306901

2x
6018774

5x
6312480

2x
302201

4x
242001

1x
6337515

4x
302101

3x
370101

1x
6053026

1x
379501

1x
4666579

2x
6024495

1x
6395748

2x
6055783

4x
4114084

3x
4159739

1x
6481642

1x
6481805

8x
6019155

3x
389421

2x
4206482

2x
6189191

2x
6117968

1x
6194751

2x
6341463

1x
6299764

1x
6441692

11x
302324

1x
6253273

2x
6130008

1x
4495934

8x
6420198

2x
4558954

8x
6273589

2x
6330189

3x
6279875

4x
302326

2x
6336989

4x
6266224

1x
6129807

6x
4107736

2x
4521931

2x
4157120

2x
379528

1x
303428

2x
6368621

1x
6254100



1x
6398380



2x
6394948



4x
4615606



1x
6058089



2x
6310668



5x
6358934



2x
6175968



8x
4164037



5x
6434321



5x
6109930



1x
6037658



2x
6021623



1x
6214811



1x
6440476



7x
4528981



2x
6411363



2x
6166857



8x
6429965



2x
6224778



2x
6350417



9x
6037890



1x
6470263



4x
6481827



2x
6389684



4x
4540280



1x
4177735



3x
4530028



2x
6385309



4x
4502089



2x
6037886



2x
6097420



2x
6364638



1x
4286789



2x
6092035



5x
6073040



8x
6249235



1x
6430410



2x
6296241



2x
6328059



1x
6020145



2x
6024286



17x
6028736



4x
4622062



4x
6485427



2x
6020181



2x
6334836



2x
6398304



2x
6099714



2x
6099730



2x
6398305



5x
6020073



2x
6482364



2x
6485426



2x
6218142



3x
6020074



2x
6365966

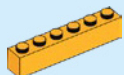

1x
6186542



1x
6192205



1x
6485425



1x
6323704



1x
6248078



1x
4211508



2x
4211437



2x
6326078



1x
6043656



4x
6267136



1x
6043639



3x
6012451



4x
6435043



1x
6039479



2x
6117972



1x
6123814



2x
4211000



1x
4218188



2x
4497253



1x
6413109



8x
6296492



1x
6162580



1x
6292914



1x
6443852



10x
6486304



1x
6228091



1x
6481633



1x
6481634



1x
6326495



5x
6222189



1x
6054406



1x
6147732



2x
6056263



1x
4649764



3x
6151664



8x
6322824



1x
6223733



15x
6133838



4x
6211418



4x
6374452



8x
6481638



4x
6453302



1x
6253906



6x
6151663



3x
6004943



18x
6470176



4x
6345712



5x
6145416



2x
6145418



2x
6137300



4x
6254306



2x
6151668



17x
6036851



2x
6298469



6x
6411366



6x
6327675



7x
6298471



2x
6441422



1x
6481828



2x
6369504



8x
6481632



4x
6369498



9x
4640901



14x
6144149



9x
6133728



1x
6250001



22x
4653988



1x
6481812



2x
6216890



2x
6206809



10x
6282122



2x
6021779



1x
6151657



1x
6501140



2x
6227474



2x
4640891



1x
6482955

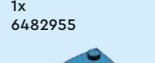

1x
6476337



1x
6476338



1x
6476338



1x
6476338



1x
4286050



3x
4517993



6x
4654128



3x
6403266



2x
4517995



1x
6353189



2x
6288181



1x
6484473



6x
6002148



3x
6484471



1x
6464977



1x
6058222



7x
4619520



3x
6097493



1x
6296904



4x
6445337



1x
6296901



2x
6097444



1x
6248486



2x
6071246



4x
6348142



6x
6331949



9x
6441006



7x
4625032



2x
6173655



6x
6070756



3x
6348141



4x
6176171



1x
6119107



1x
6233166



3x
4624705



2x
6252704



2x
6097093



4x
6102828



1x
6441153



9x
4655256



2x
6481835



1x
6253666

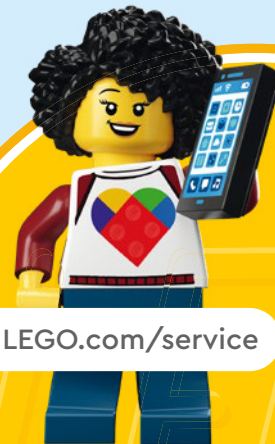

 [LEGO.com/service](https://www.LEGO.com/service)

YOU COULD **WIN**



Scan this QR code or go to
LEGO.COM/PRODUCTFEEDBACK and give us
your short feedback about this LEGO® set for a
chance to win a cool LEGO prize.

Terms and Conditions apply*

EN: YOU COULD WIN. Terms and Conditions apply* **DE: Du könntest GEWINNEN.** Es gelten die Teilnahmebedingungen* **FR: Tu pourrais GAGNER.** Des conditions s'appliquent* **IT: Potresti VINCERE tu.** Termini e condizioni sono applicabili* **ES: Puedes GANAR.** Aplican términos y condiciones* **PT: Poderá GANHAR.** Aplicam-se termos e condições* **ZH: 轻松获奖. 条款和条件适用*** **PL: Szansa na WYGRANĄ.** Obowiązują warunki korzystania* **CS: Máte šanci VYHRÁT.** Platí všeobecné smluvní podmínky* **SK: Máte šancu VYHRAŤ.** Platia všeobecné zmluvné podmienky* **HU: TE IS NYERHETSZ.** Felhasználási feltételek érvényesek* **RO: Ai putea CÂȘTIGA.** Se aplică termeni și condiții* **BG: Можете да СПЕЧЕЛИТЕ.** Има определени правила и условия* **LV: Tu vari LAIMĒT.** Ir spēkā noteikumi un nosacījumi.* **ET: Sul on võimalus VÕITA.** Kehtivad tingimused* **LT: Jūs galite LAIMĖTI.** Taikomos sąlygos*

*[LEGO.com/productfeedback-terms](https://www.lego.com/productfeedback-terms)