



Friends

41754





LEGO.com/sustainable-packaging



BUILDER



Apple and the Apple logo are trademarks of Apple Inc., registered in the U.S. and other countries and regions. App Store is a service mark of Apple Inc. Google Play and the Google Play logo are trademarks of Google LLC. Tencent and the Tencent logo are trademarks of Tencent Inc.

Q LEGO.com/devicecheck

EN Ask parents' permission before going online | **DE** Eltern um Erlaubnis bitten, bevor du online gehst | **FR** Demande l'autorisation d'un parent avant d'aller en ligne | **IT** Chiedi il permesso ai tuoi genitori prima di andare online | **ES** Pídeles permiso a tus papás antes de conectarte a Internet | **PT** Peça autorização aos pais antes de acederes online | **JA** オンラインになる前に ほご者の方のきょかをもらおう | **ZH** 上网前应先征得父母的同意 | **KO** 온라인 접속 전에 보호자 동의가 필요합니다 | **RU** Спроси разрешения у родителей, прежде чем заходить в интернет | **PL** Poproś rodziców o zgodę, zanim wejdiesz do Internetu | **CS** Než půjdeš na internet, požádej rodiče o svolení | **SK** Skôr než pôjdeš na internet, vypýtaj si povolenie od rodičov | **HU** Kérj szülői engedélyt, mielőtt online csatlakoznál! | **RO** Cere permisiunea părinților înainte de a te conecta online | **BG** Поискайте разрешението от родители, преди да влезете онлайн | **LV** Pirms došanās tiešsaistē palūdz atļauju vecākiem | **ET** Enne Interneti kasutamist küsi vanematelt luba | **LT** Prieš prisijungdami prie interneto, atsklaukite tėvų

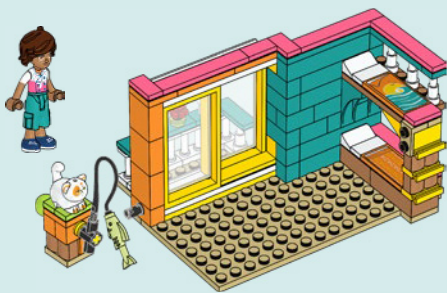

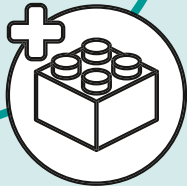
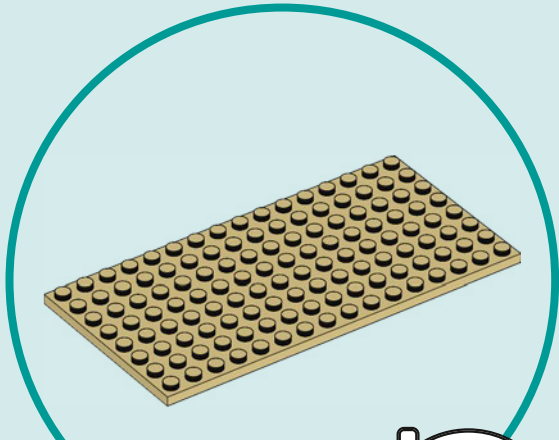

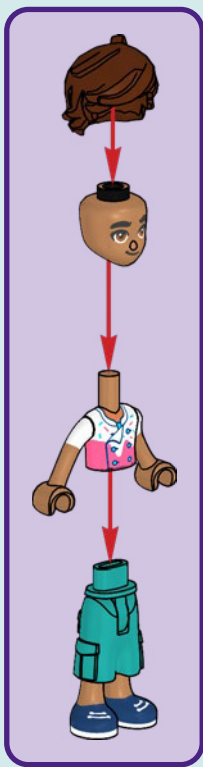

LEO

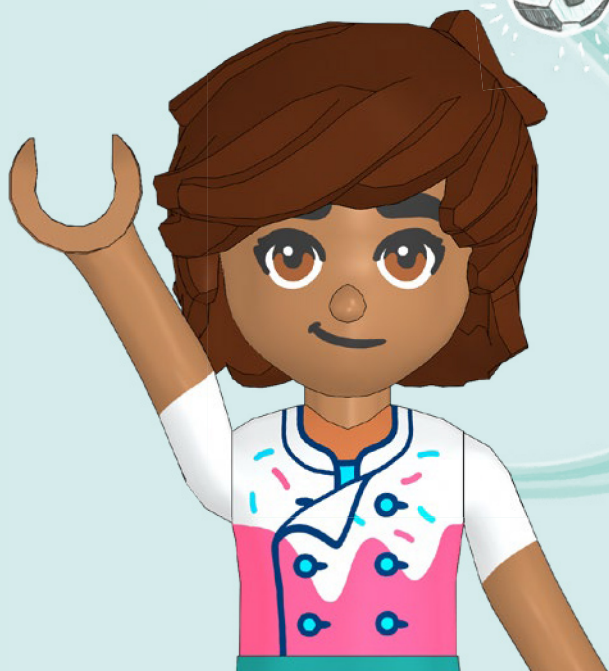



OLLY



LEO



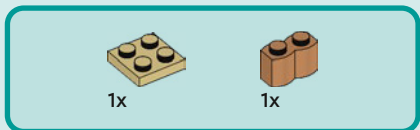

1

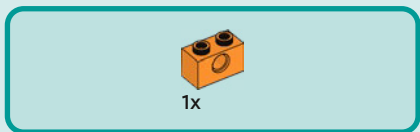
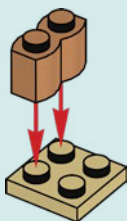

2

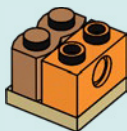



2x

3

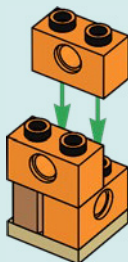



1x

4

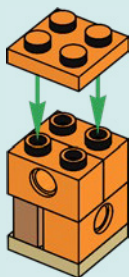

2x

5



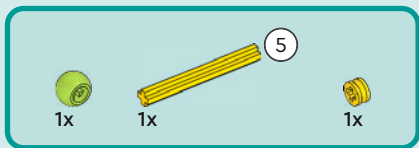

6

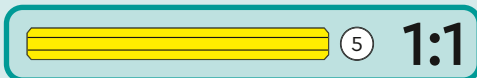
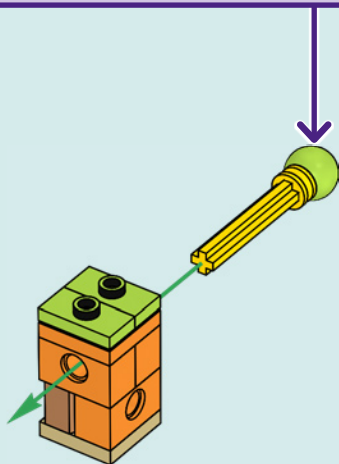
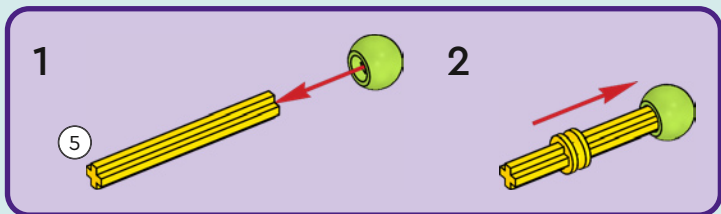



1x

7

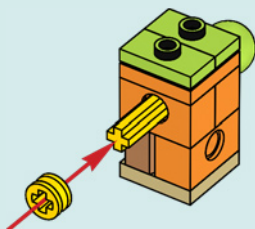

1x

8

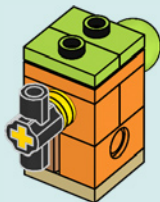

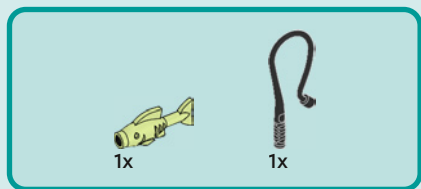

9

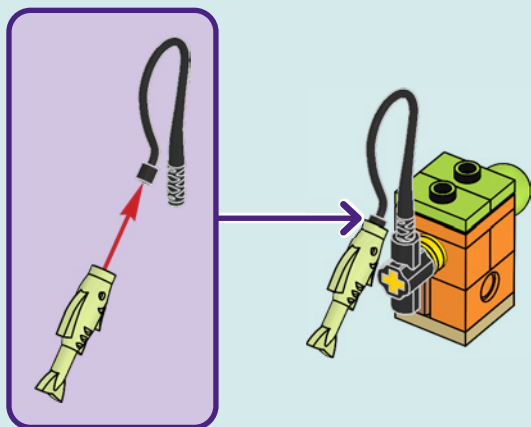



1x

10

CHURRO

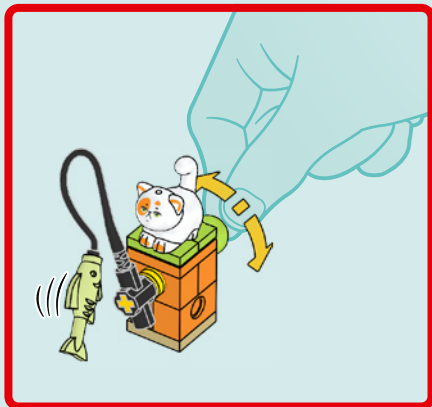
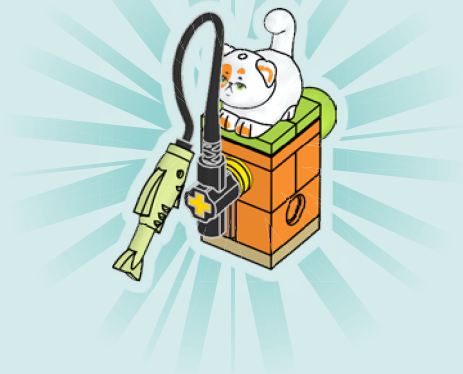

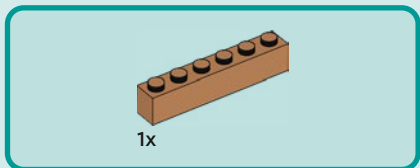

1

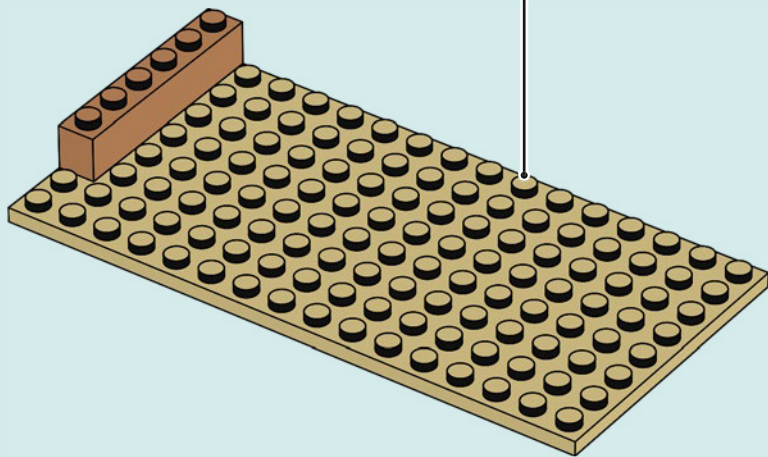

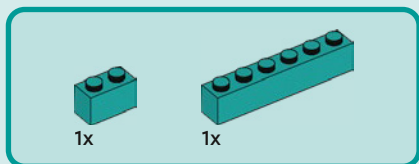

2

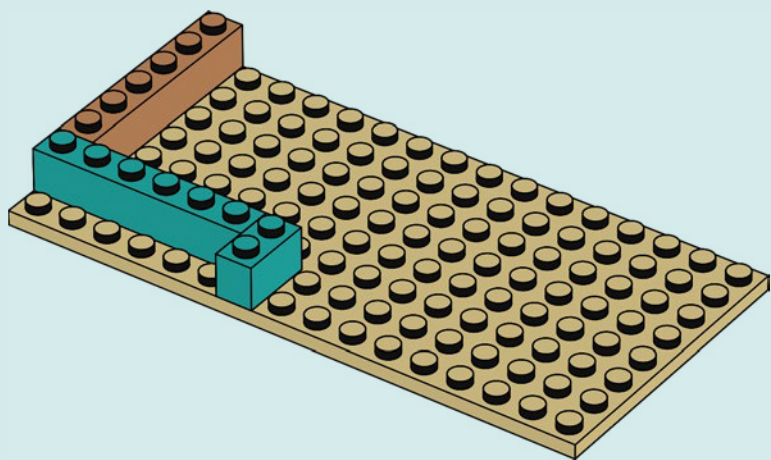

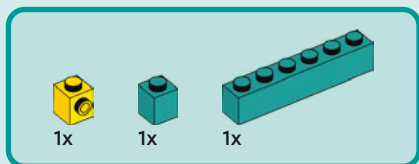

4

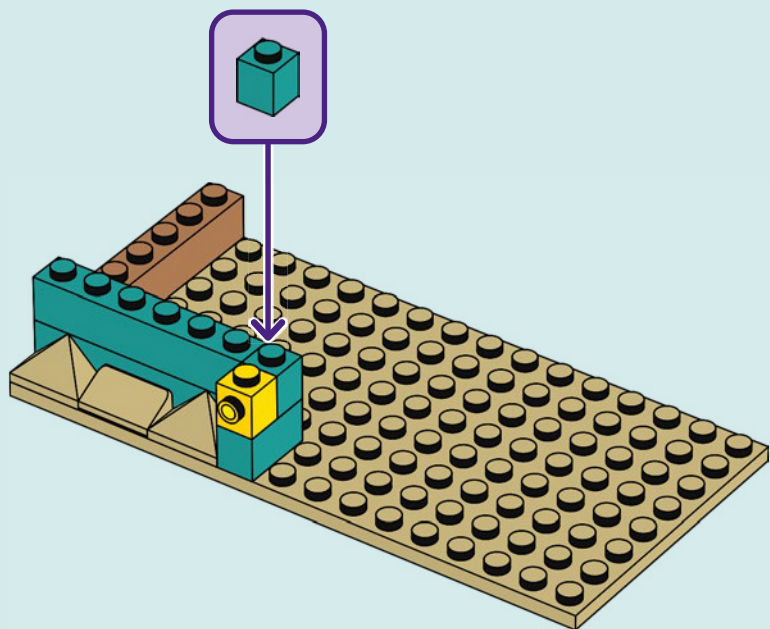

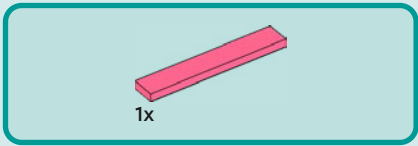

5

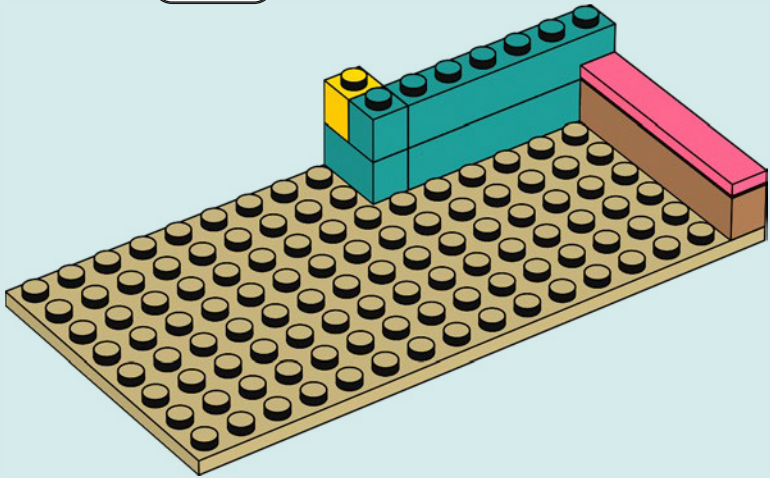



2x

6

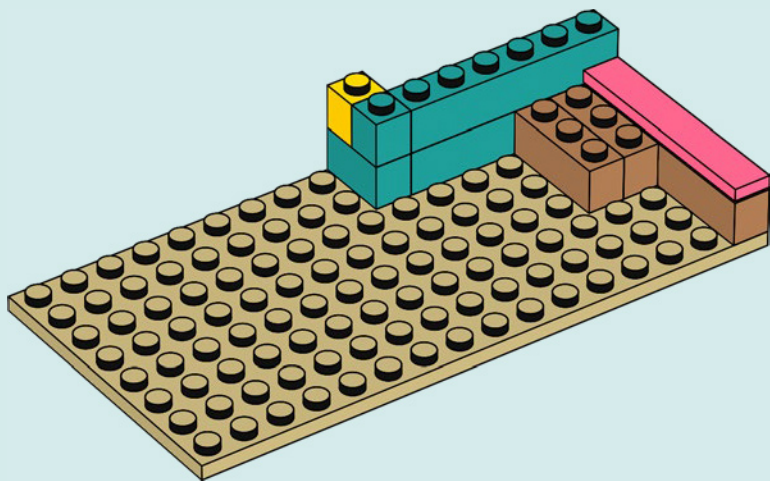

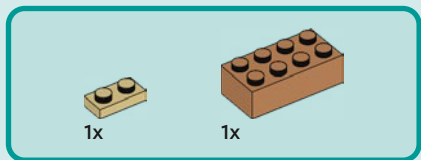

7

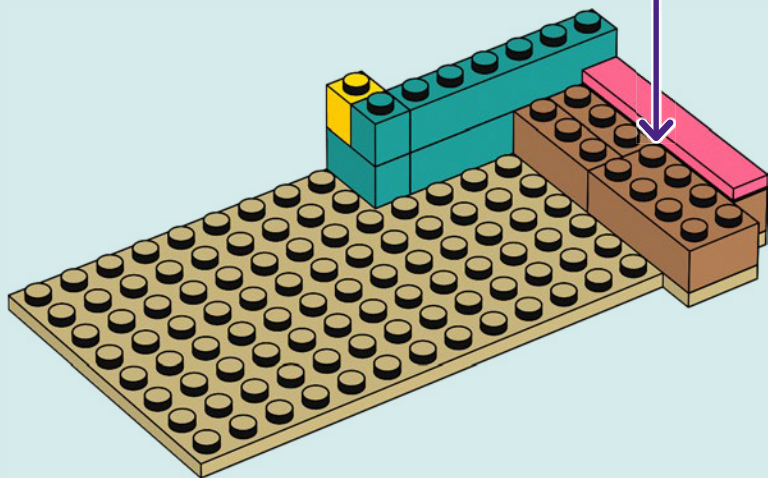
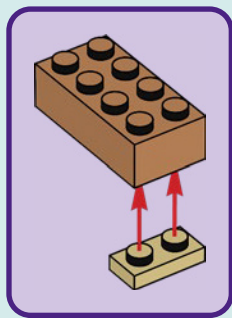



1x



1x



1x

8

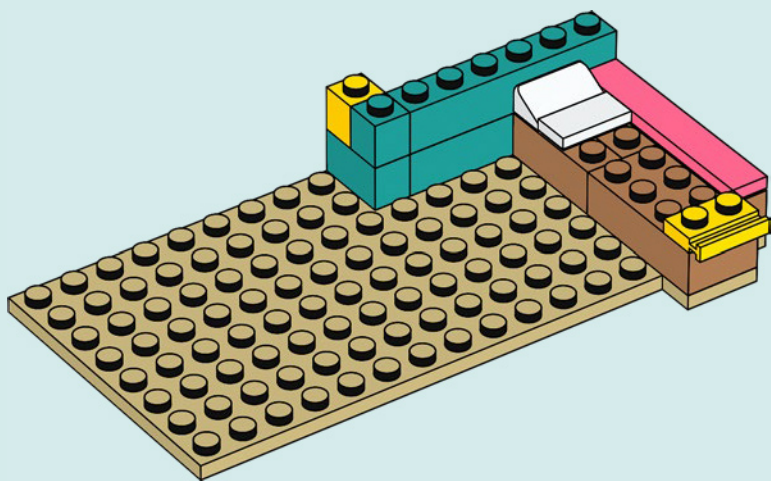

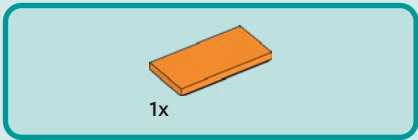

9

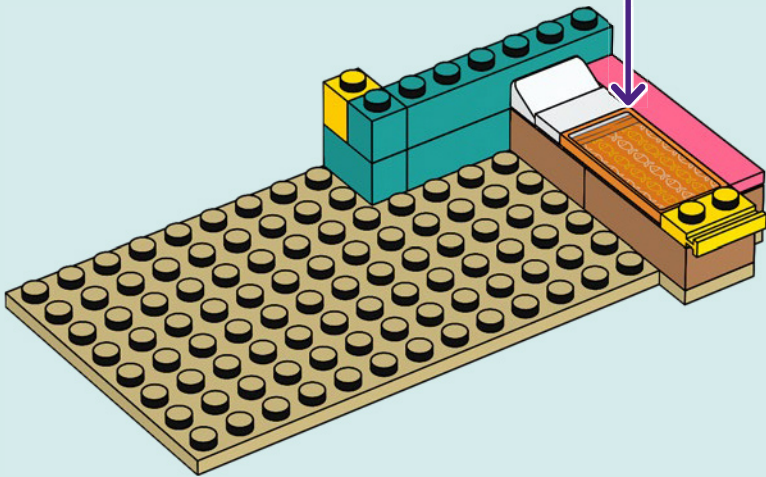
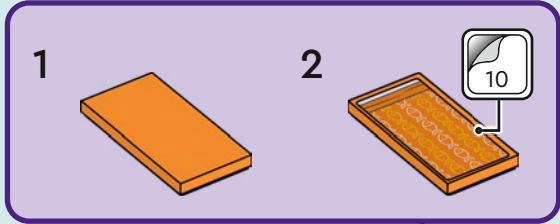

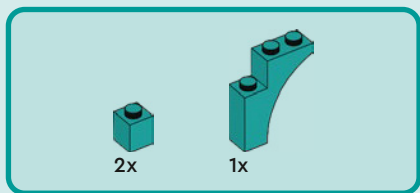

10

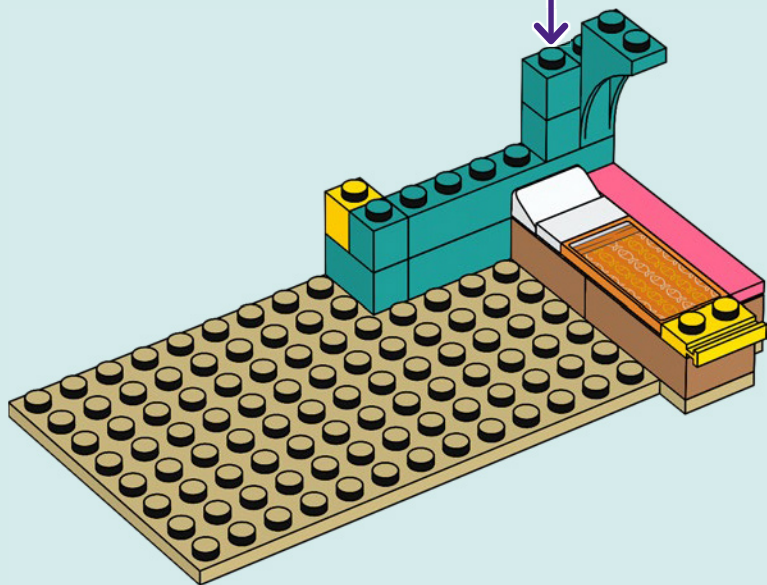
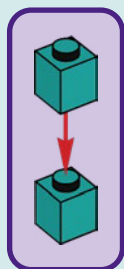

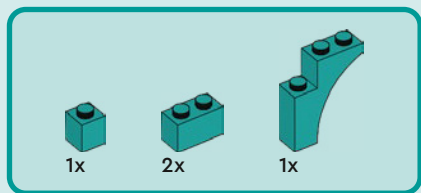

11

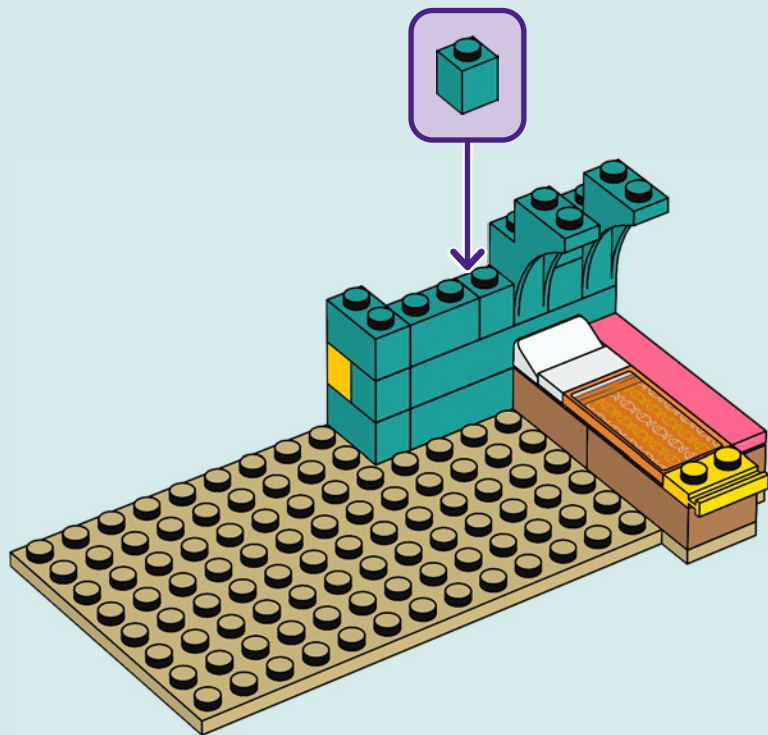



1x



2x

12

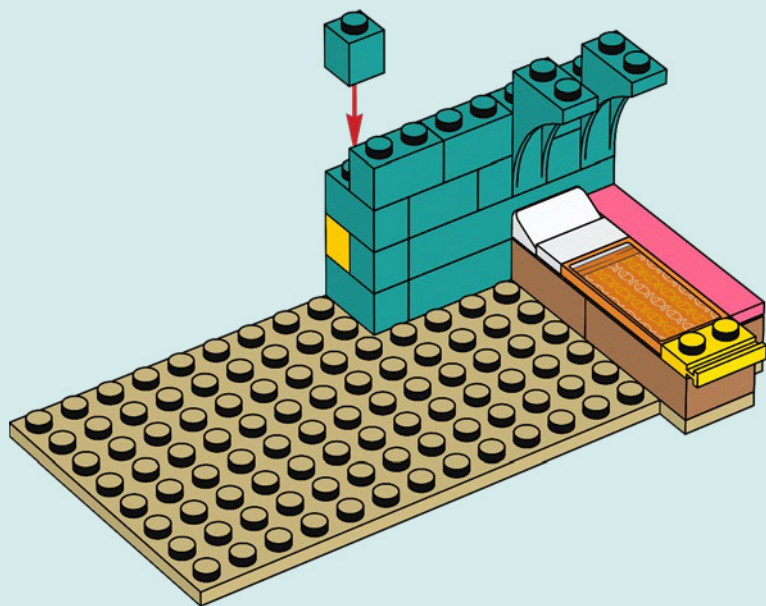



1x

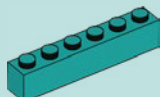

1x

13

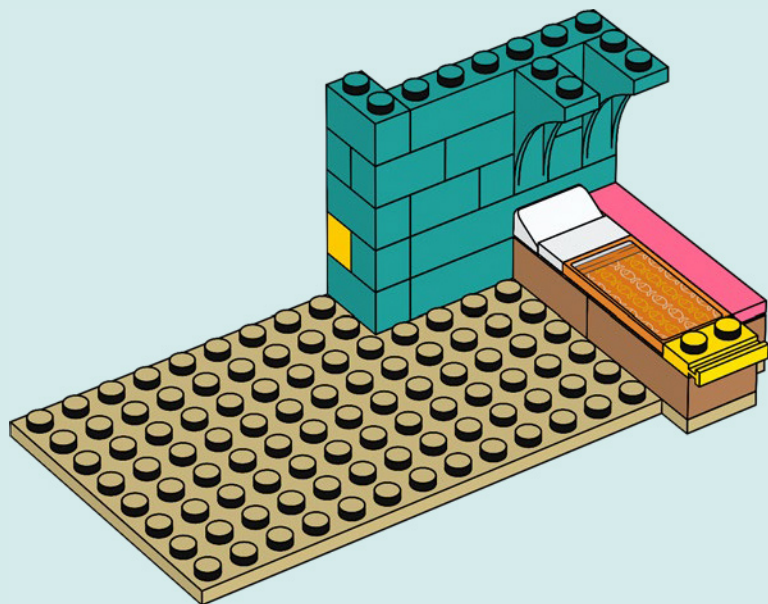

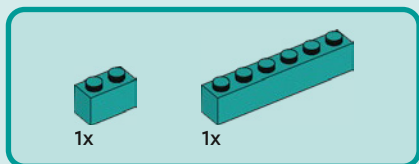

14

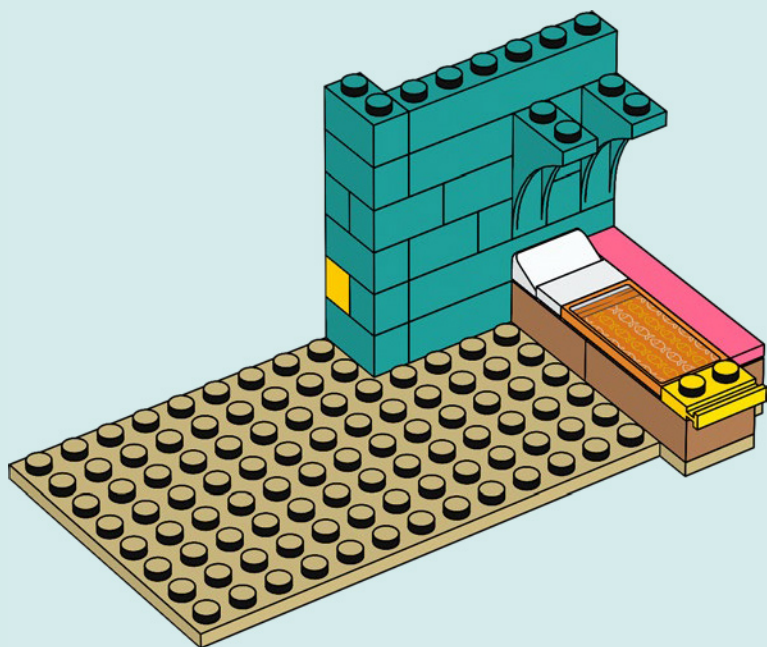

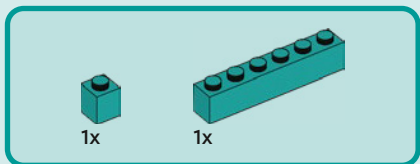

15

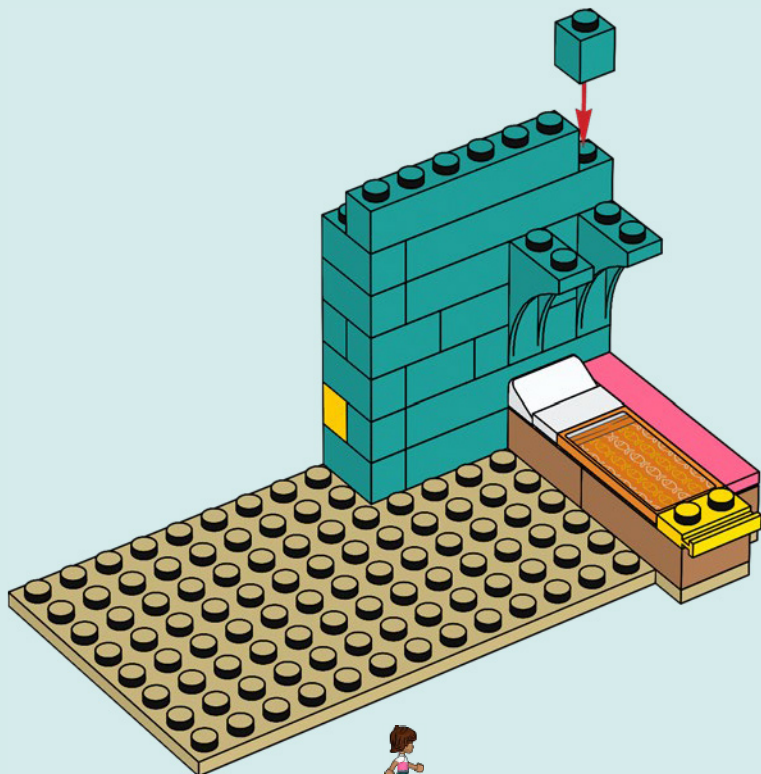



2x



2x

16

1

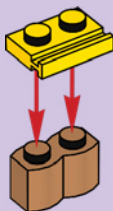

2

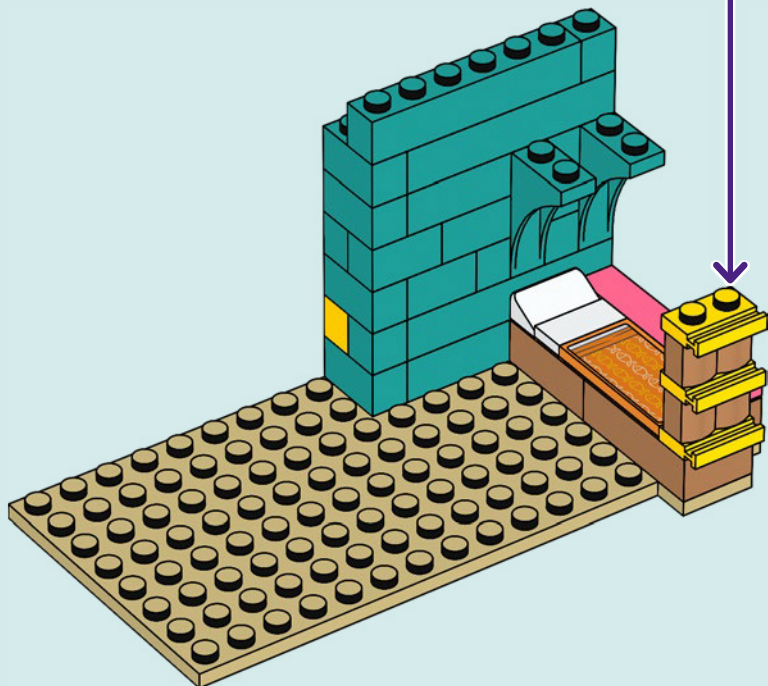
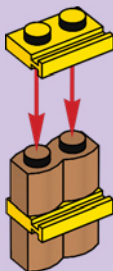

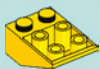

1x

17

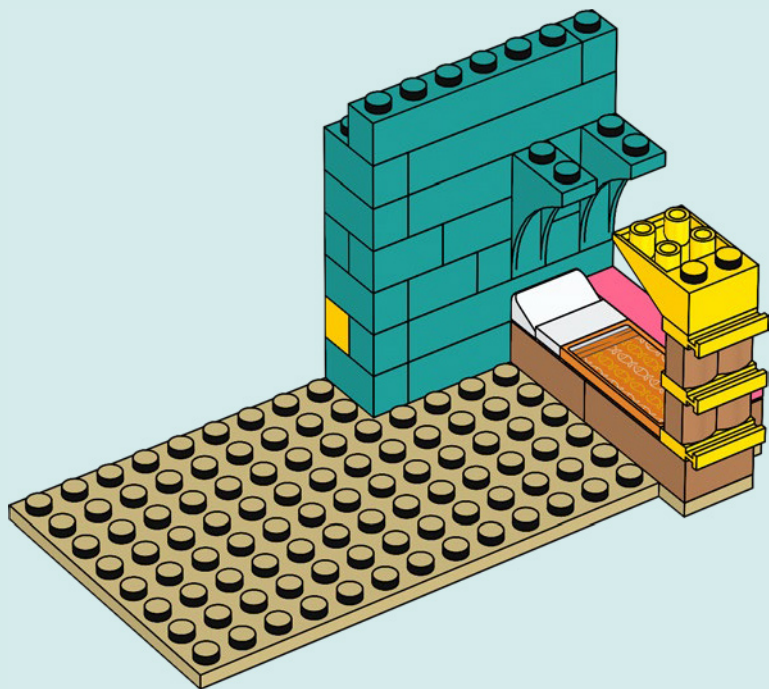

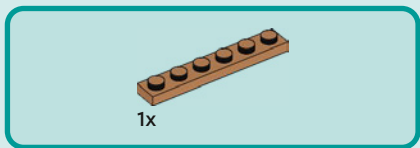

18

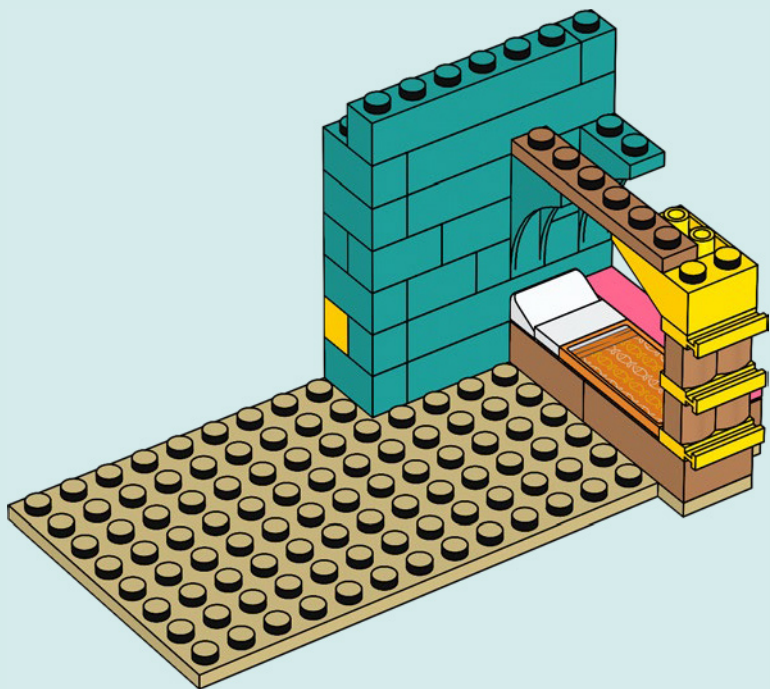



1x

19

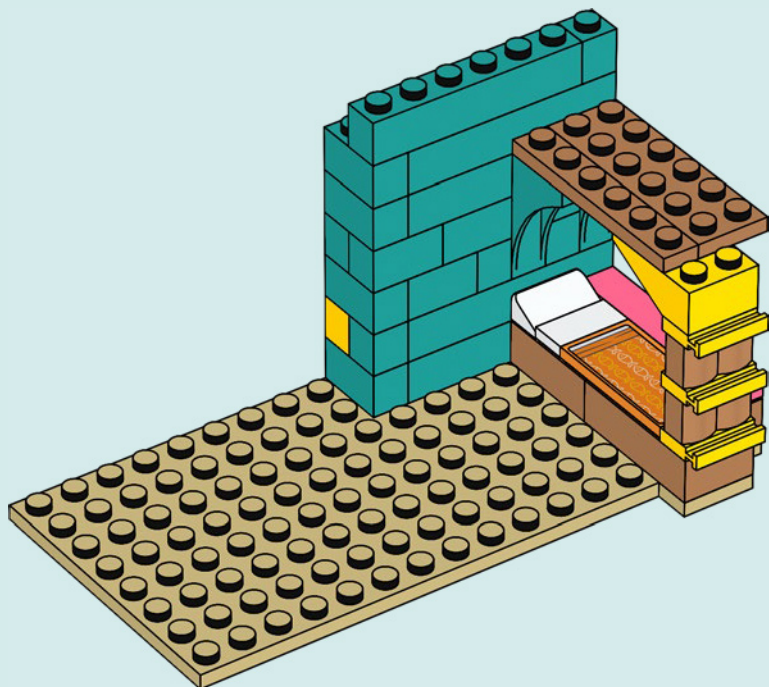

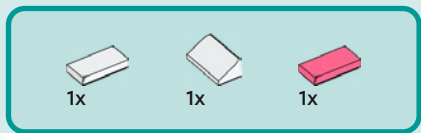

21

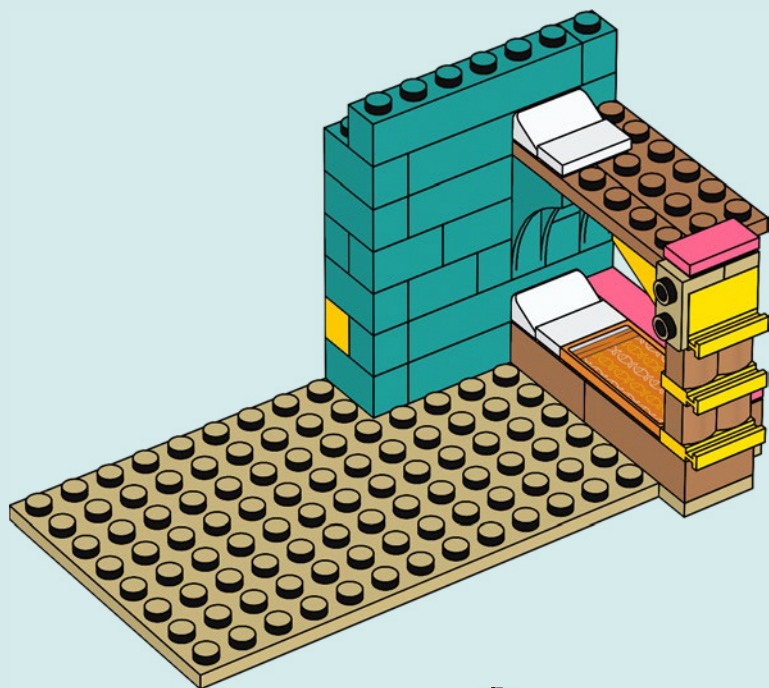

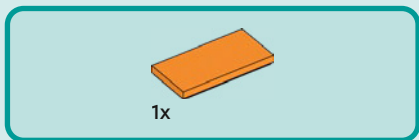

22

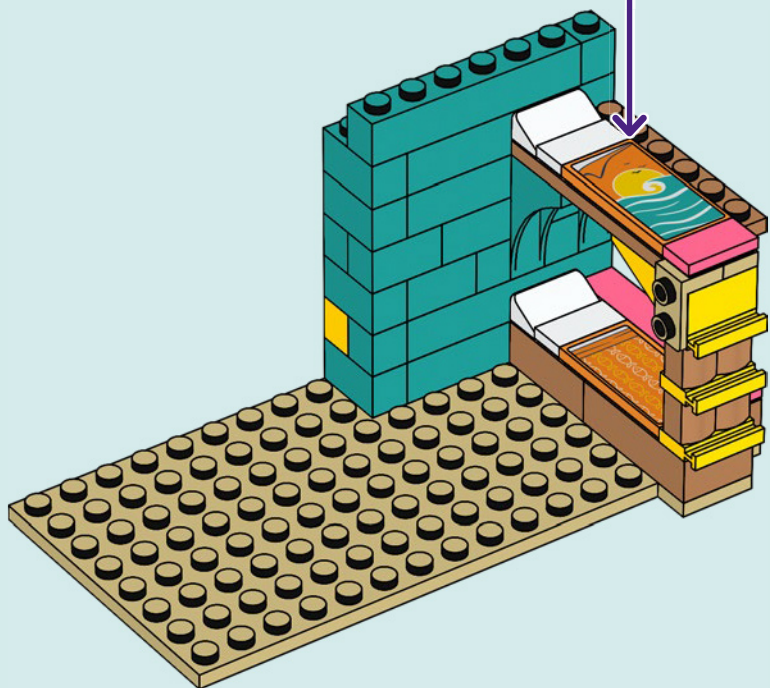
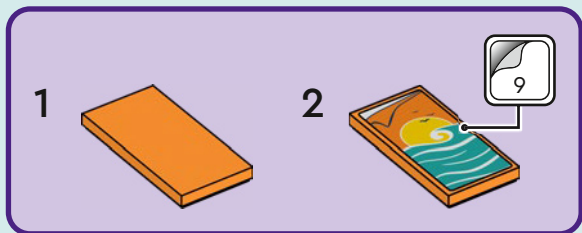



3x

23

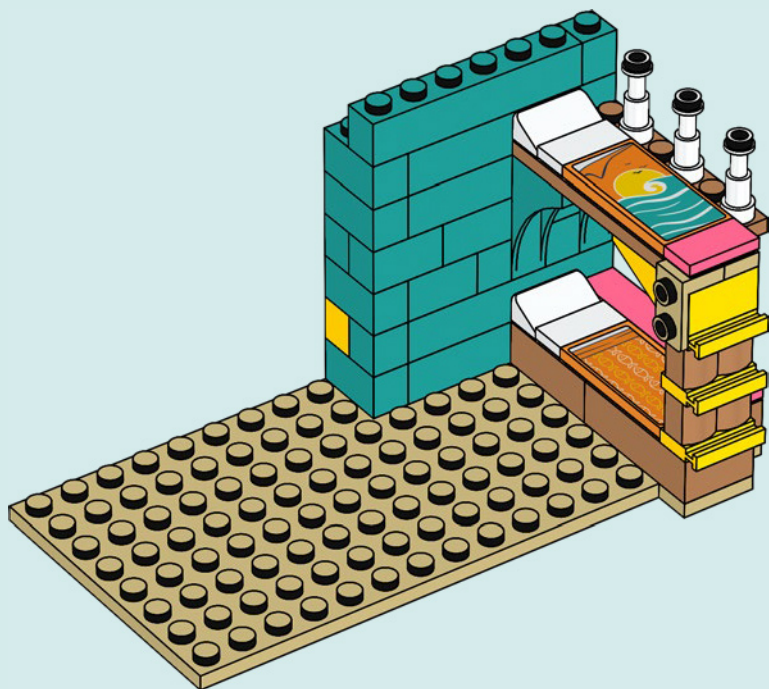

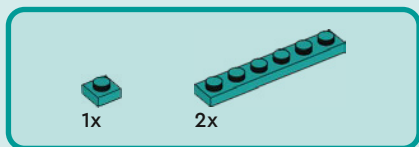

24

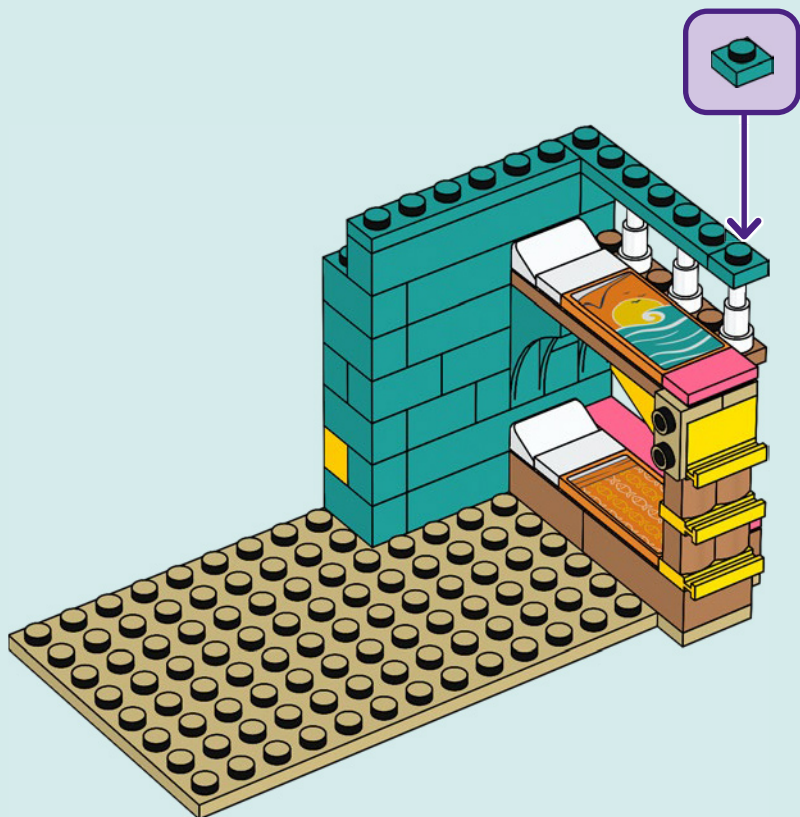



2x

25

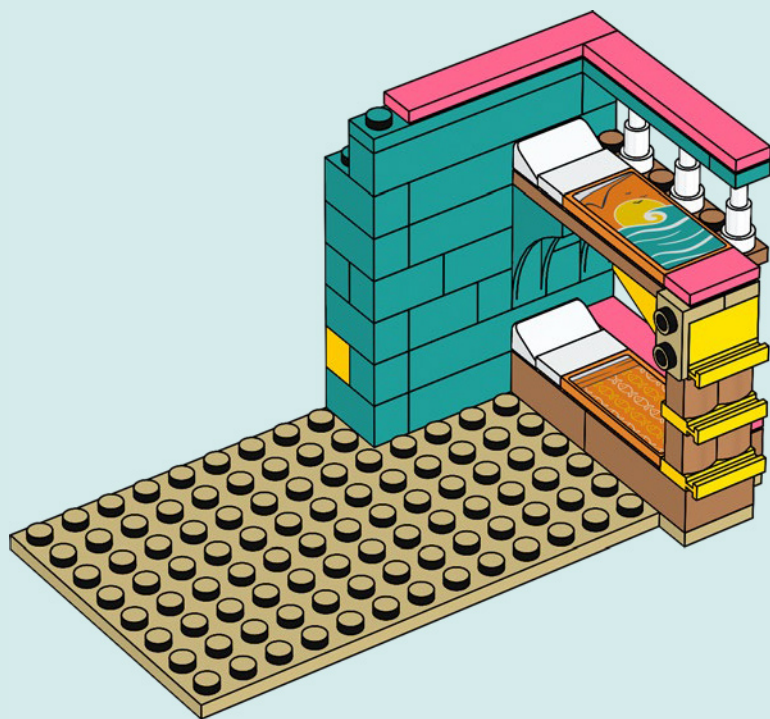



1x

26

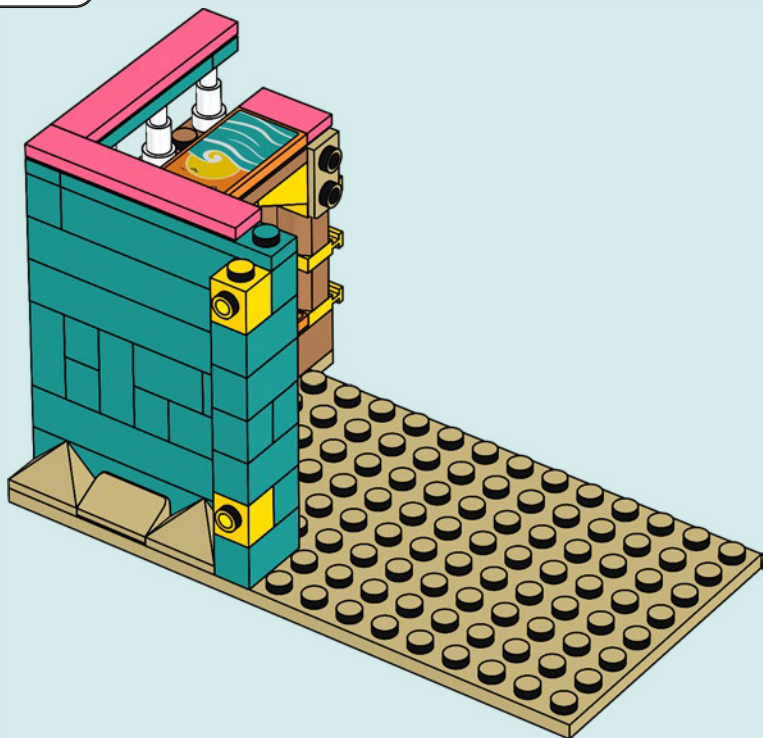

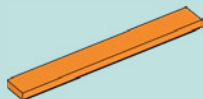

1x

27

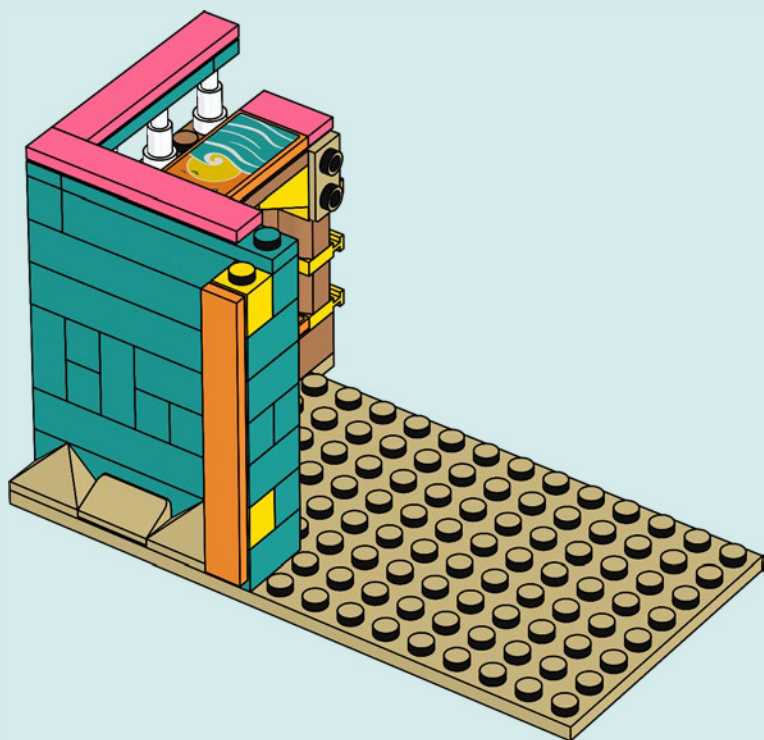

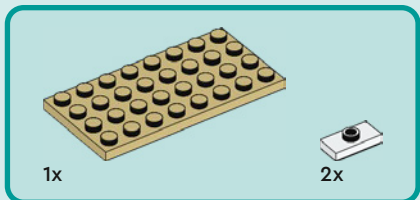
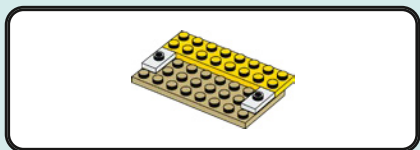

28

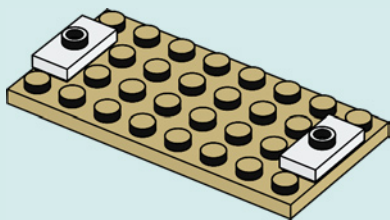

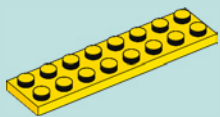

1x

29

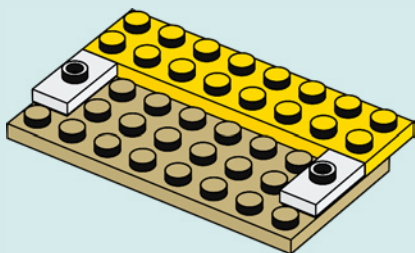

30

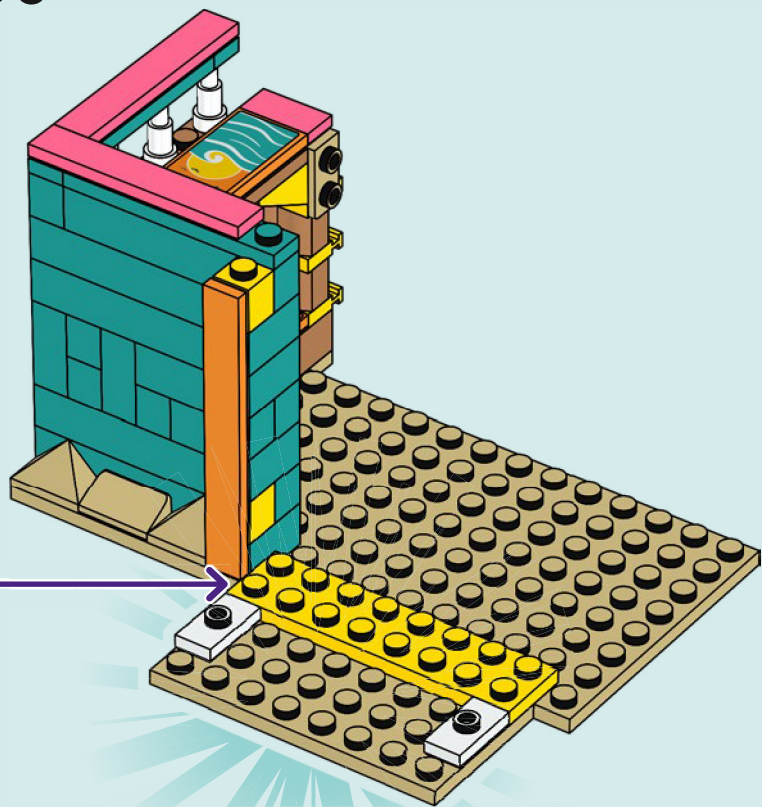

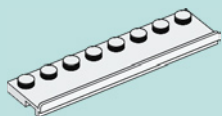

1x

31

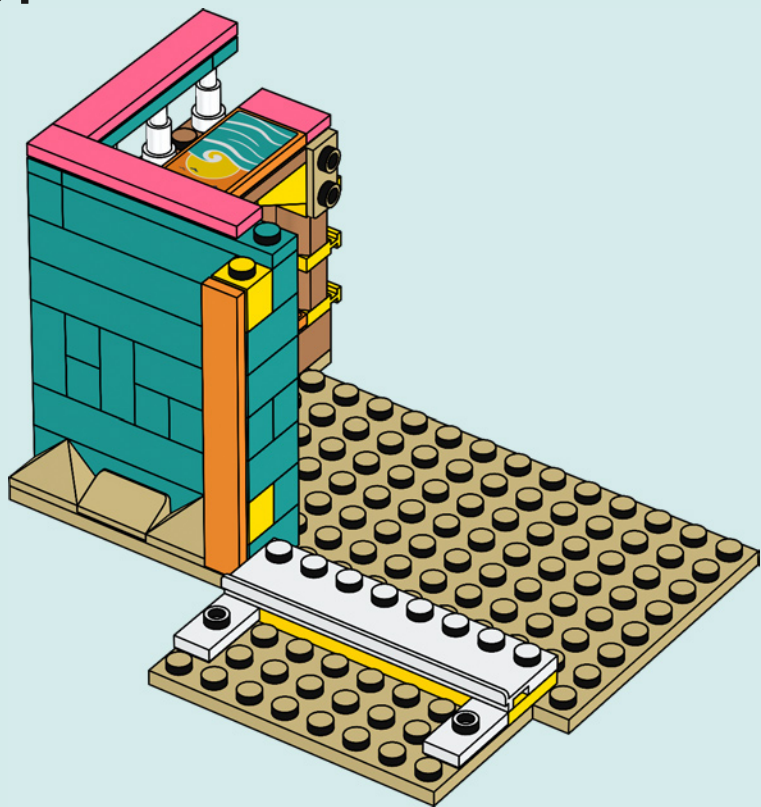



1x

32

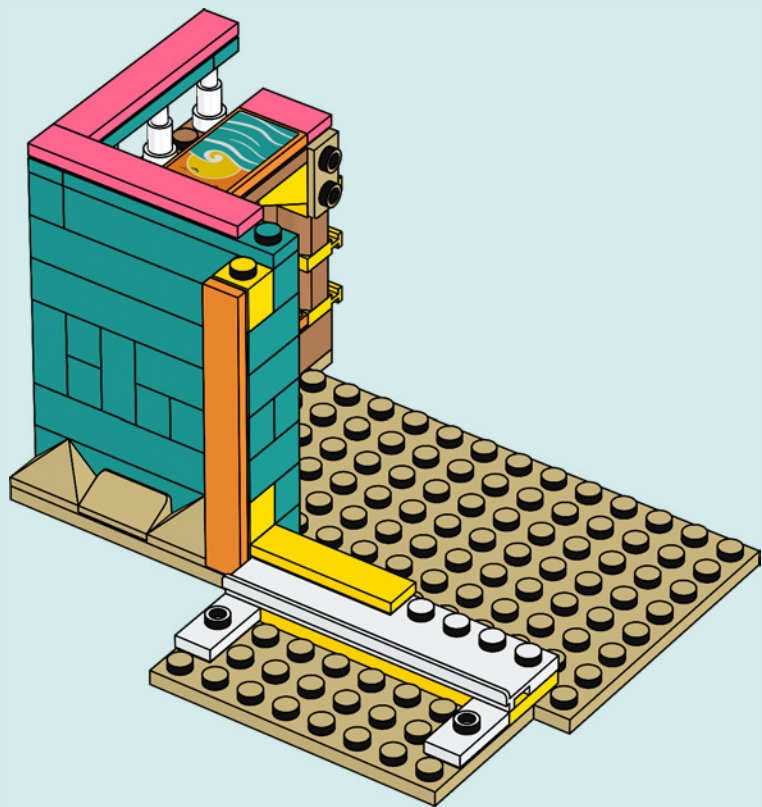

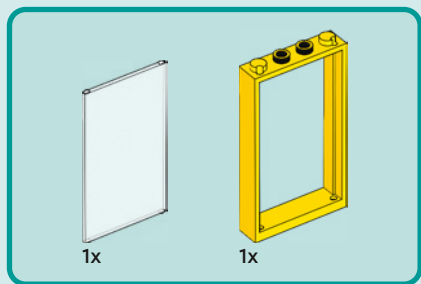

33

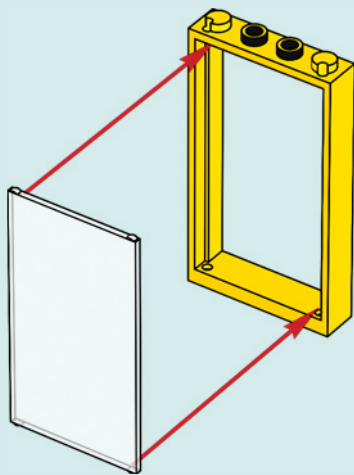

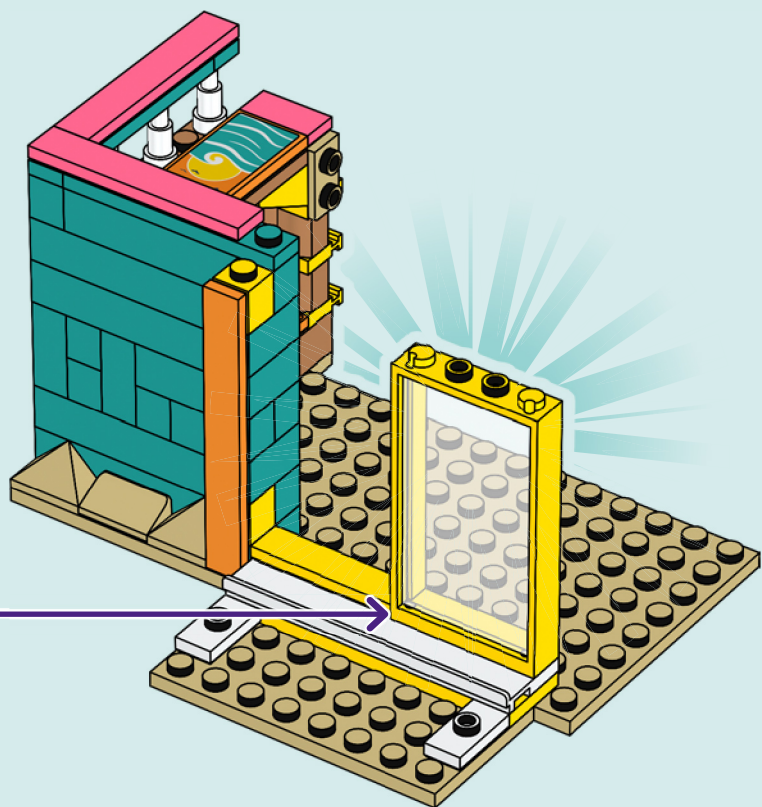



1x



1x

34

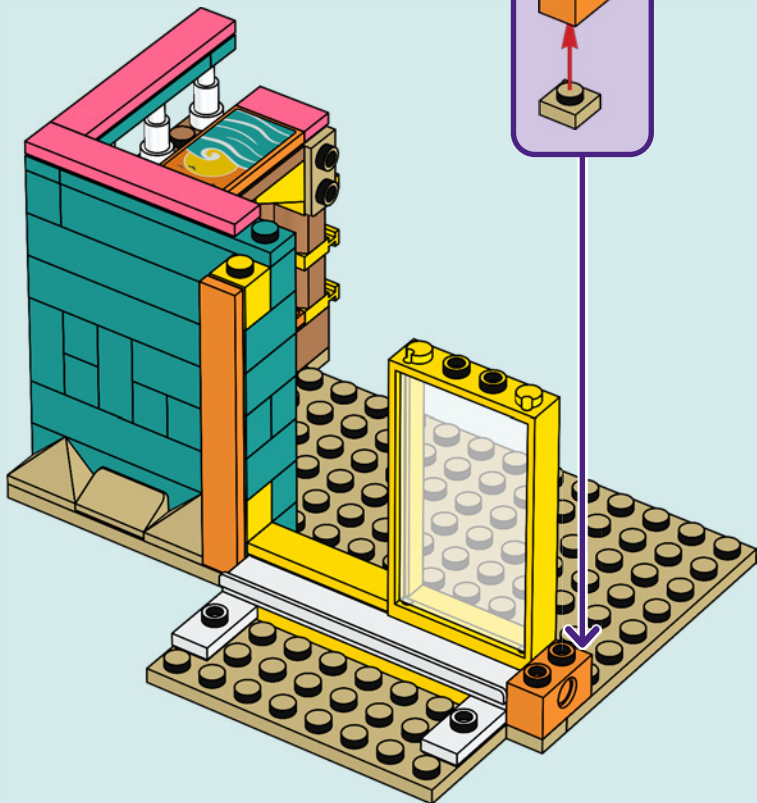



3x

35

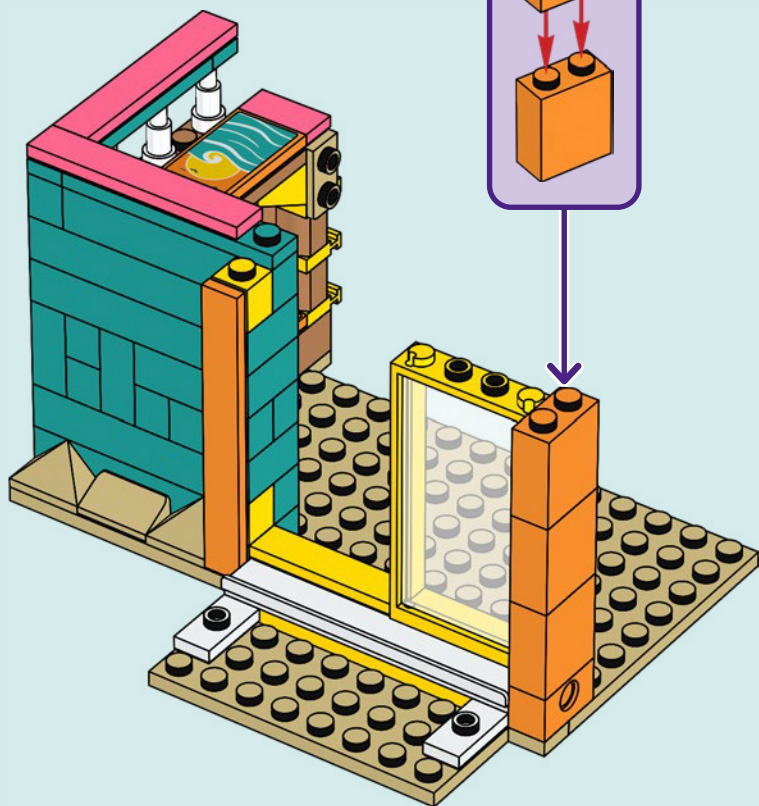

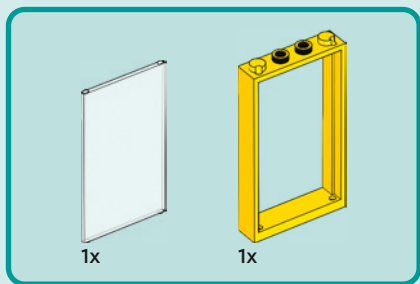

36

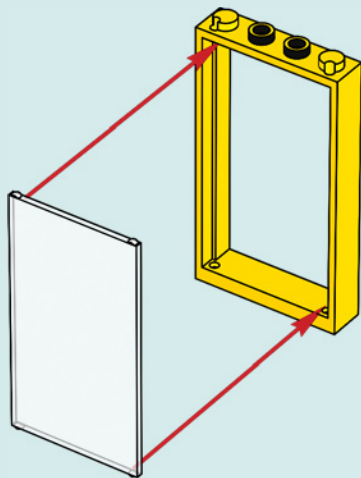

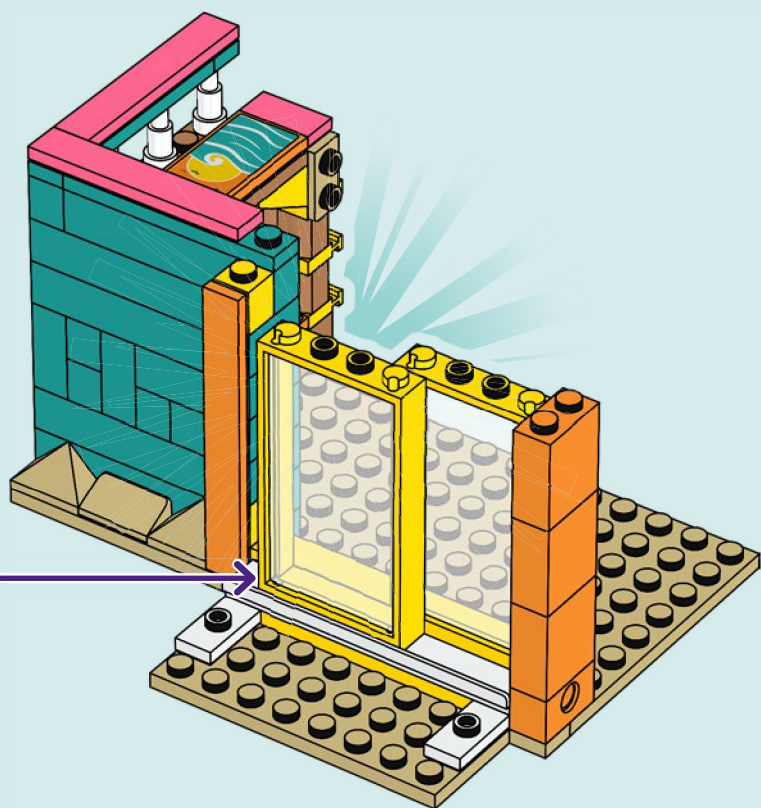

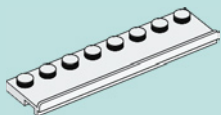

1x

37

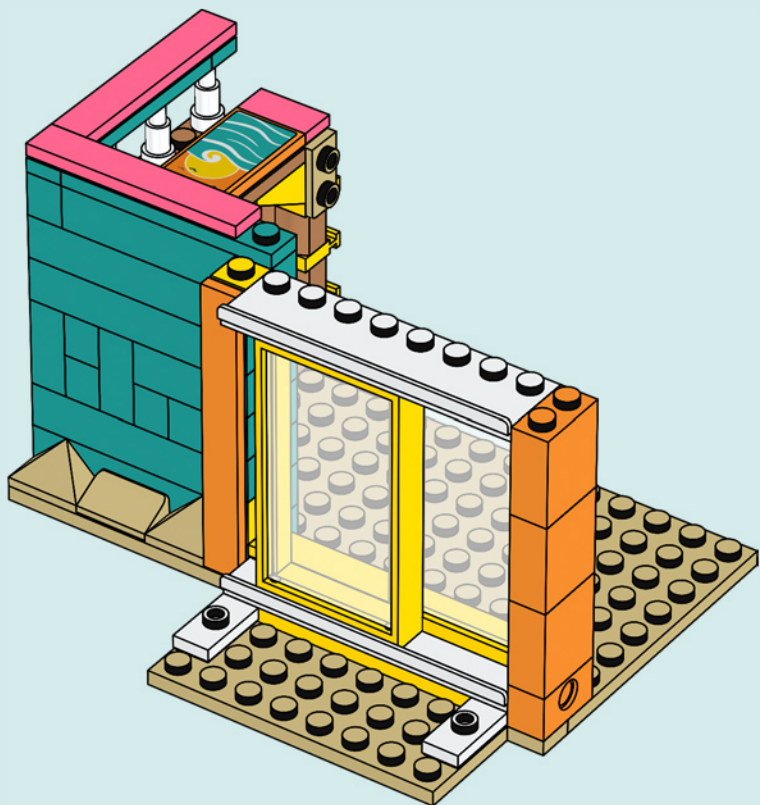



1x

38

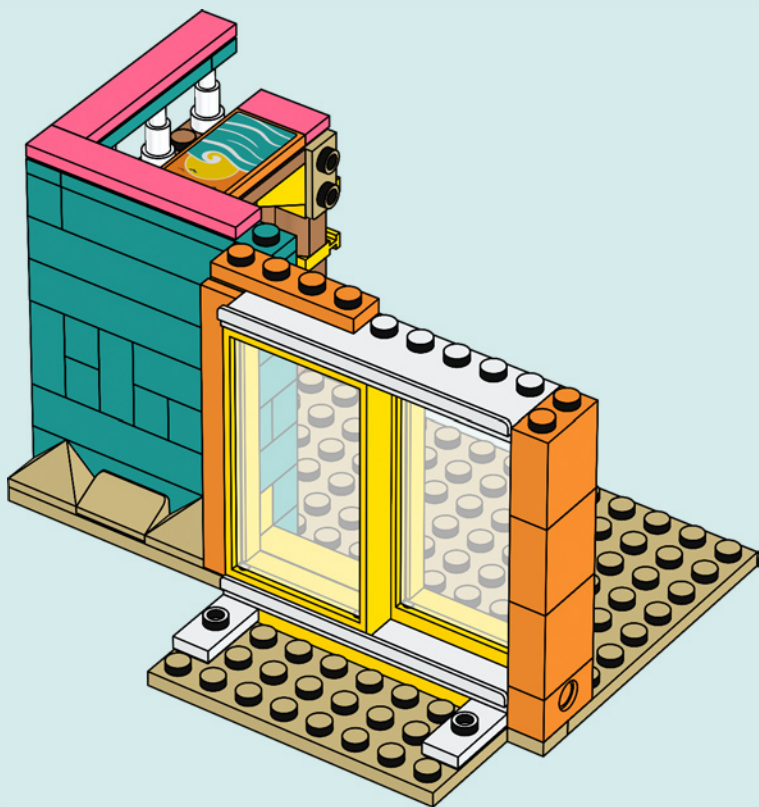



1x



1x

39

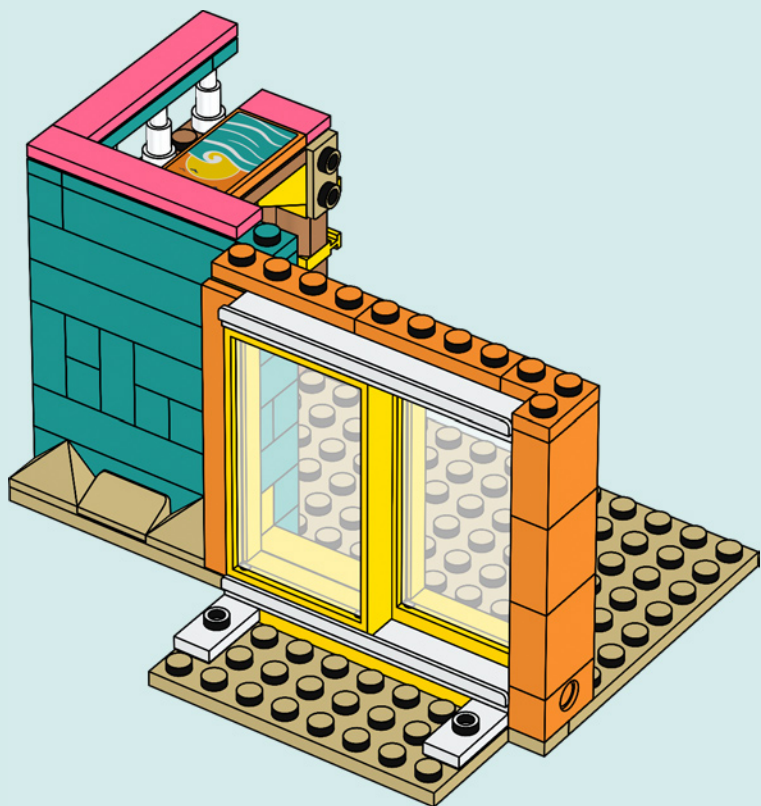

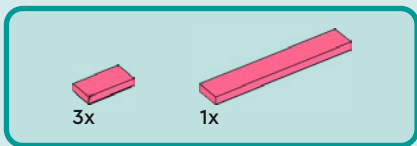

40

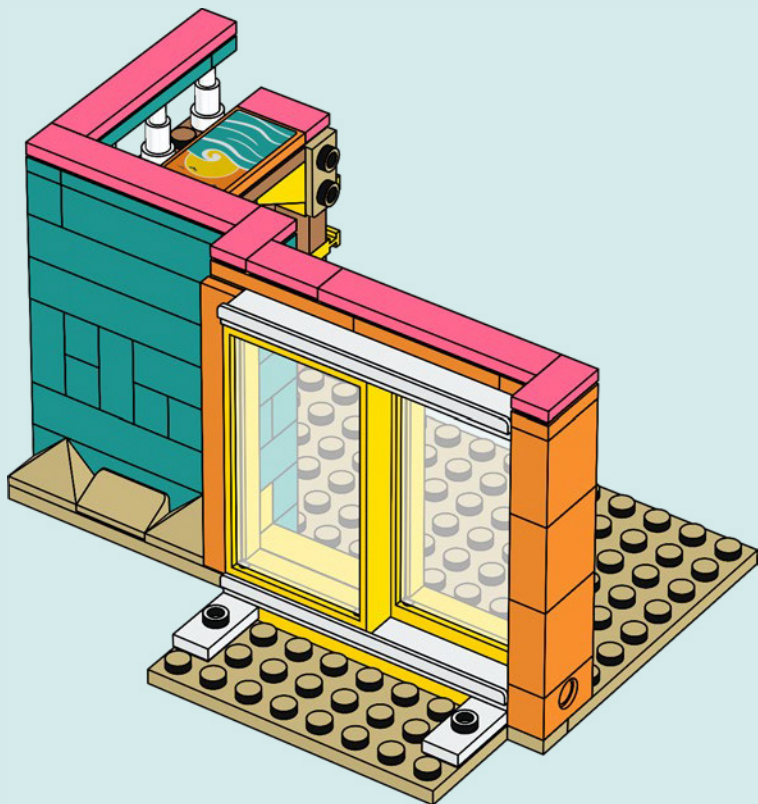

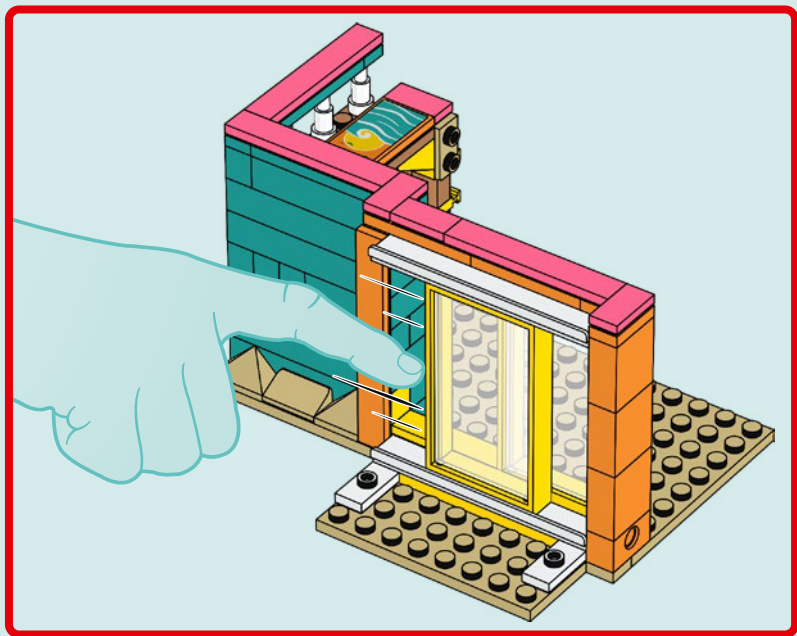



1x

41

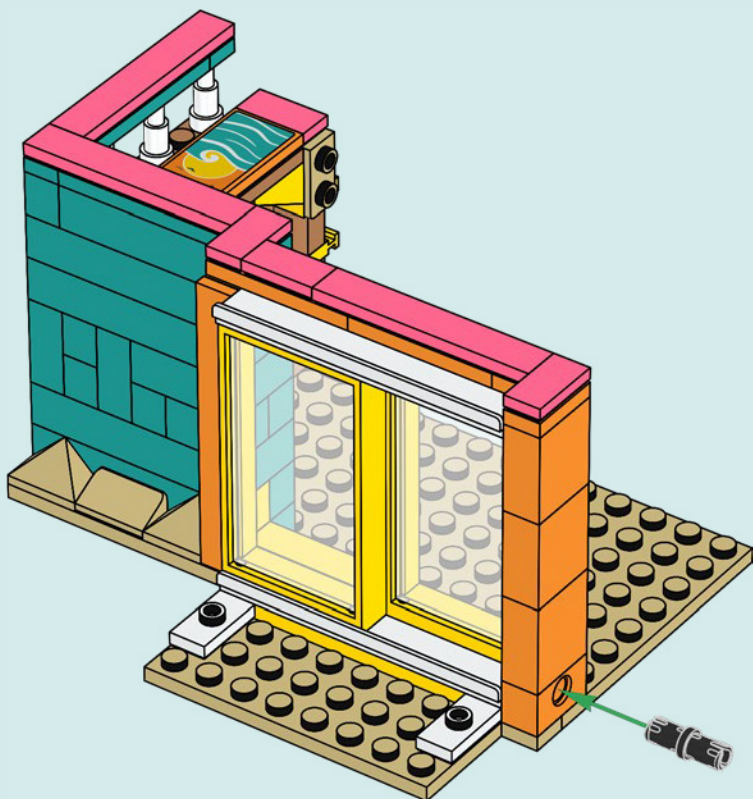



42

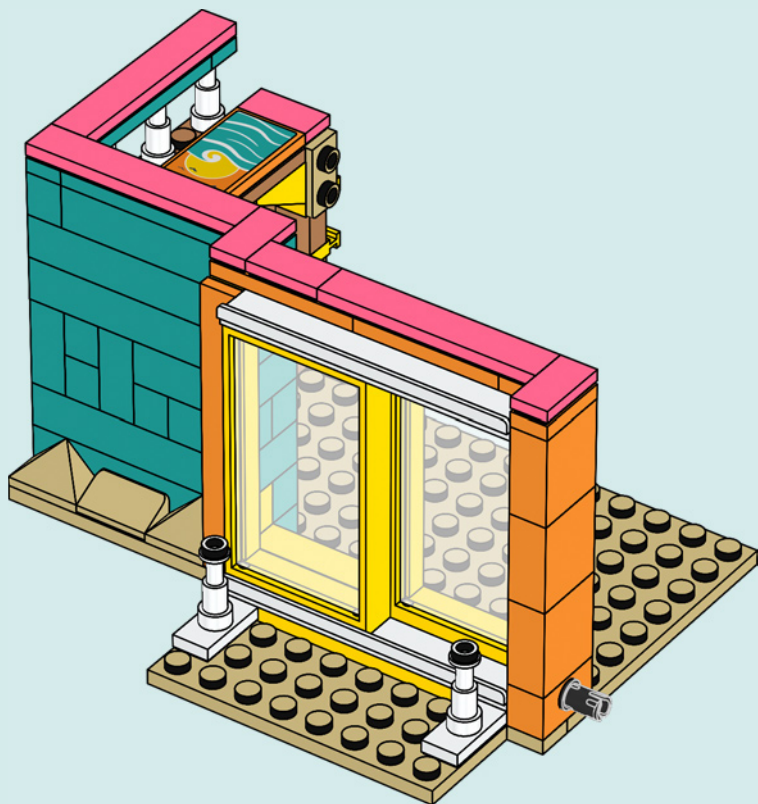



2x

43

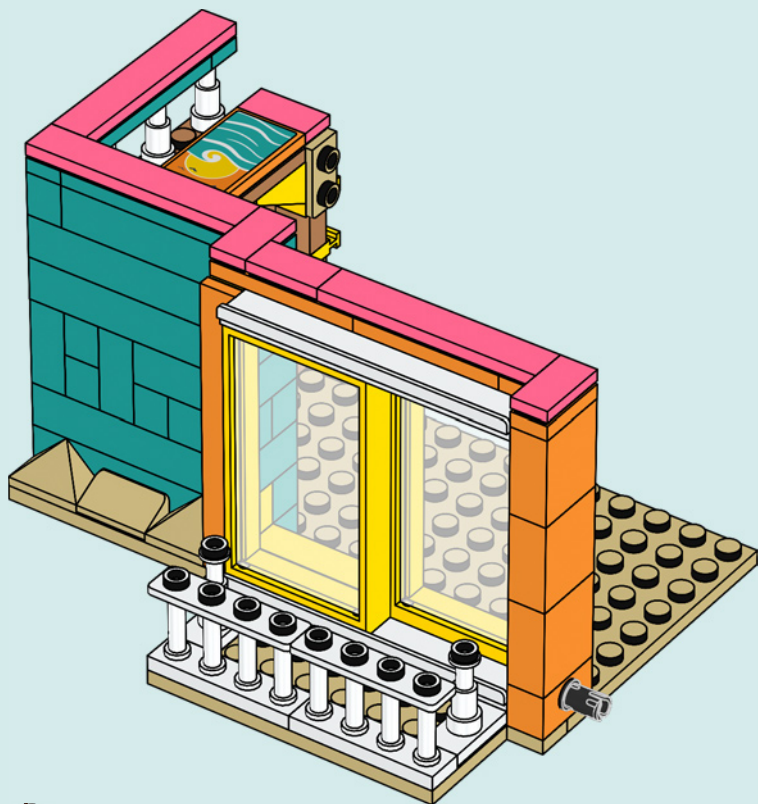



2x

44

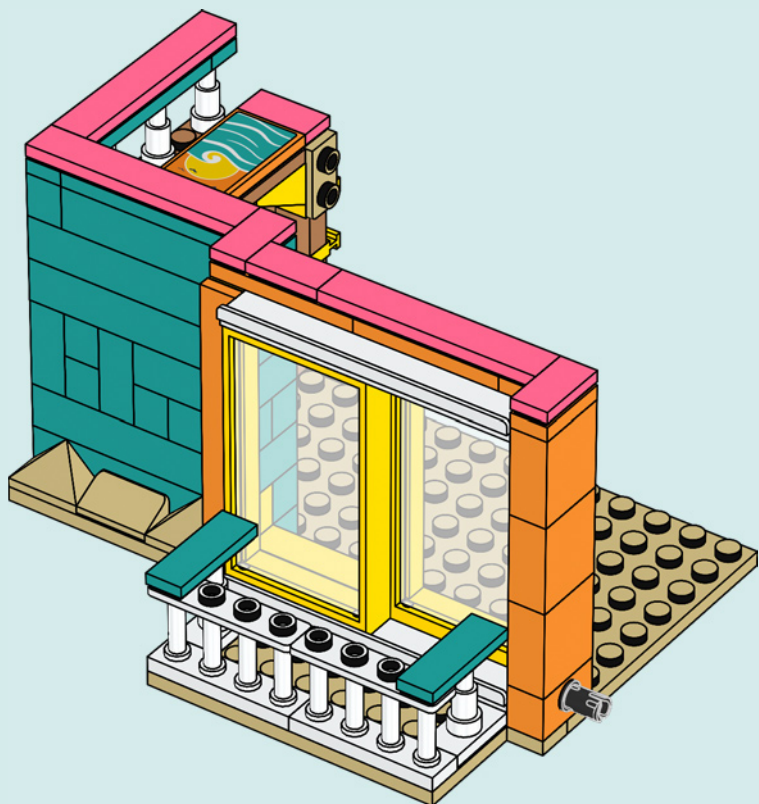



3x

45

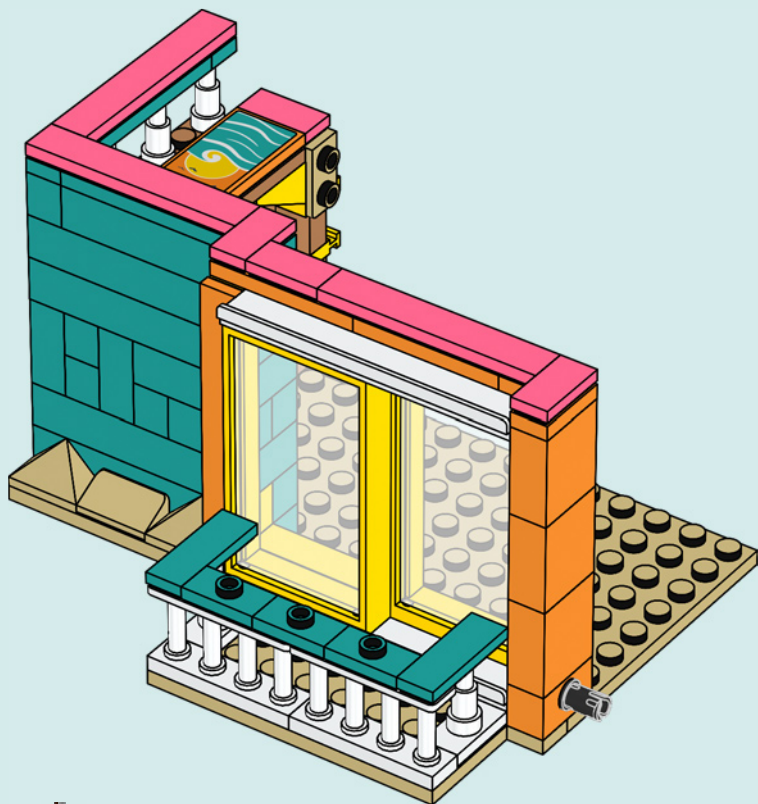



1x



1x

46

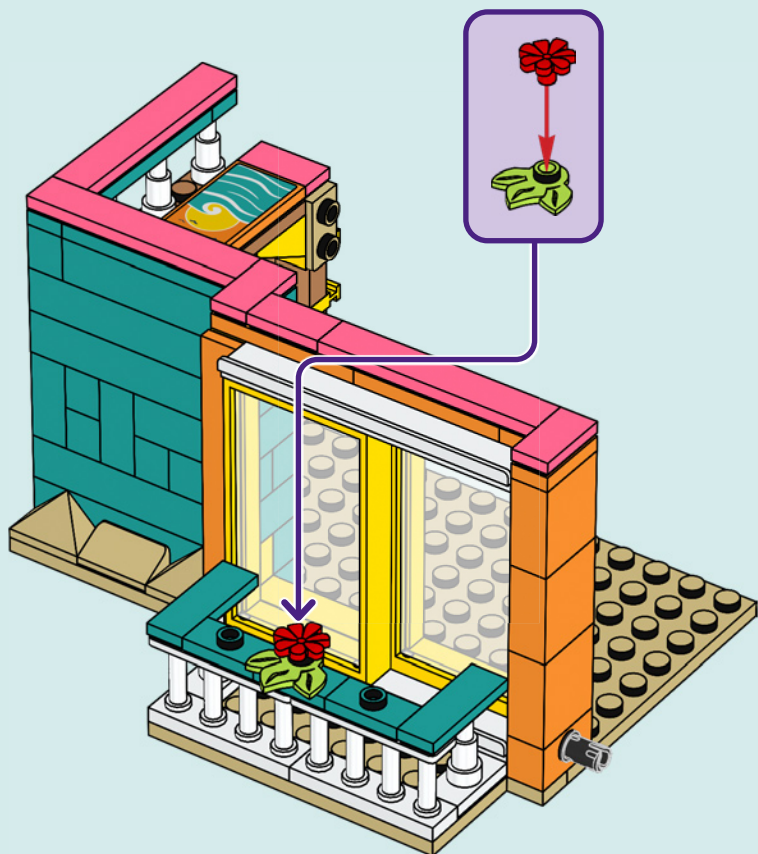



1x



1x

47





1x



1x

48

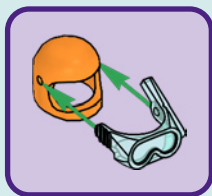



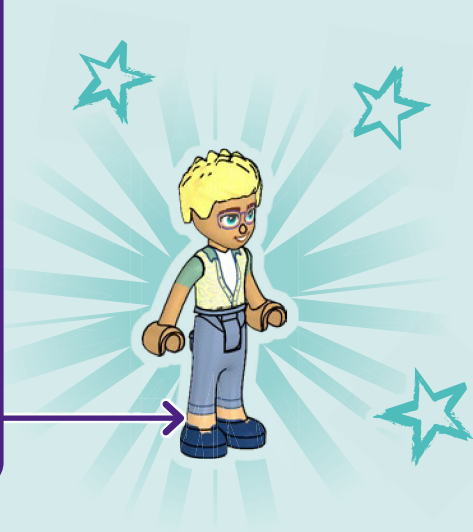
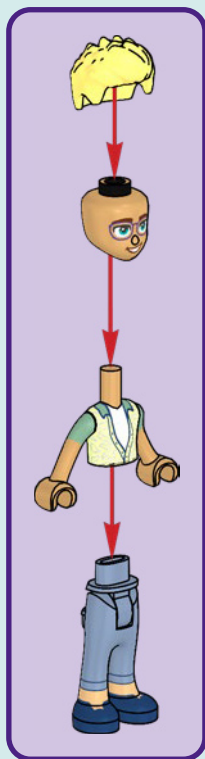

OLLY





2x



2x

49



2x





1x



1x



2x



1x

50

1

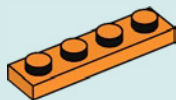

2

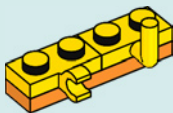

3



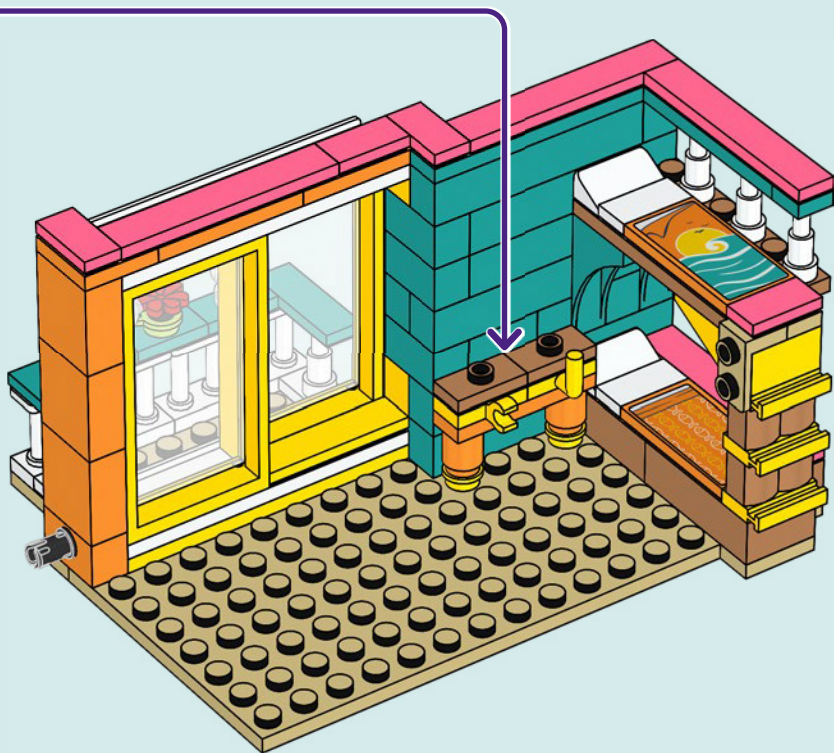



1x



1x



1x

51

1



2





2x



1x

52

1



2

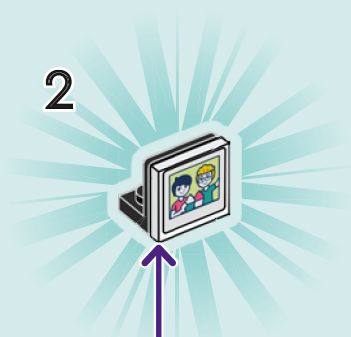

1



2



8

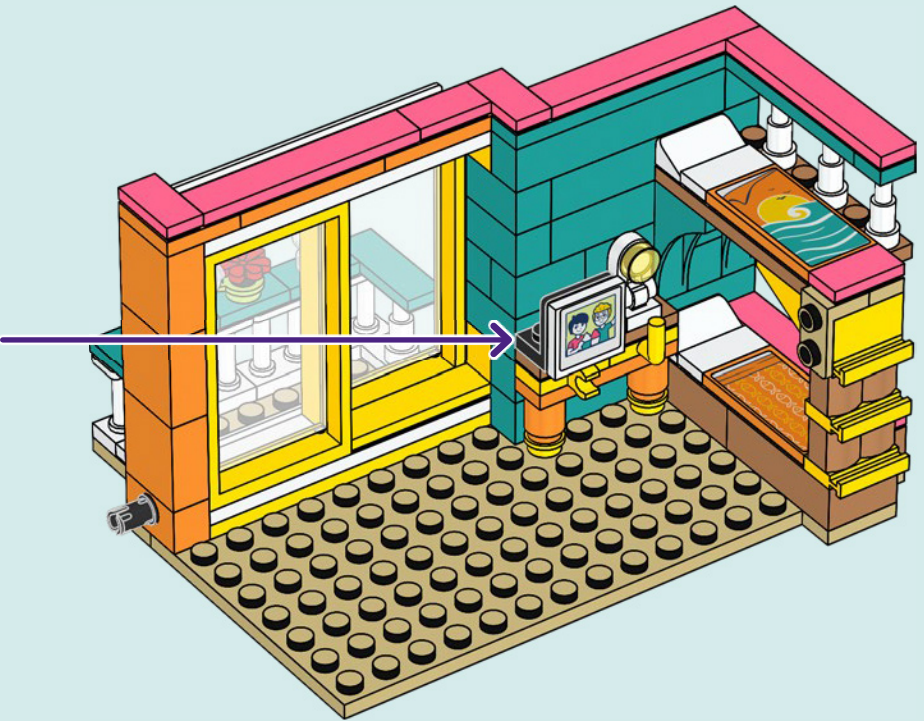
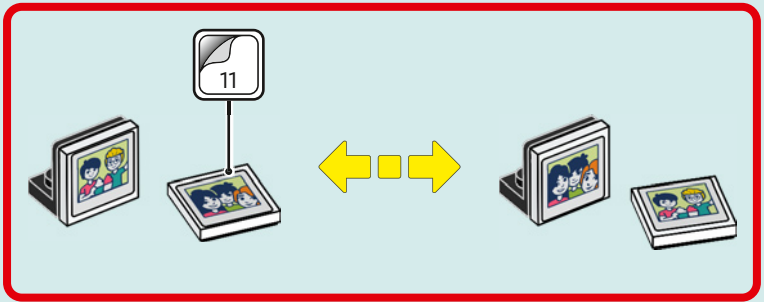



1x

53

1



2



5





1x



1x

54



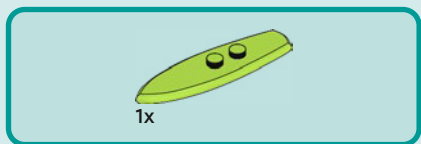

55

1

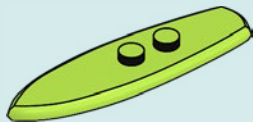

2

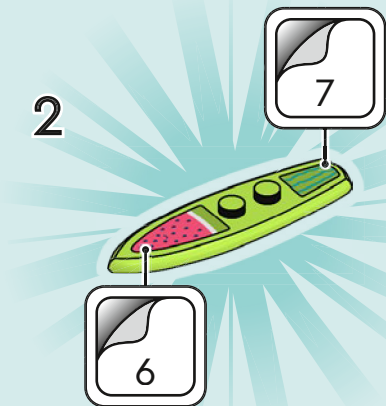





1x



1x



1x

56

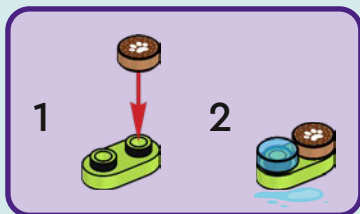



1x

57





1x



1x

58

1

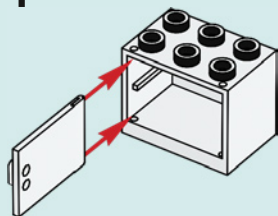

2







1x



1x



1x



1x

59

1

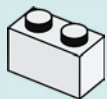

2

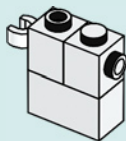

3

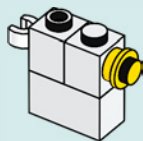





1x



1x

60





2x

61





2x

62





63

1

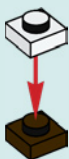

2



3



4

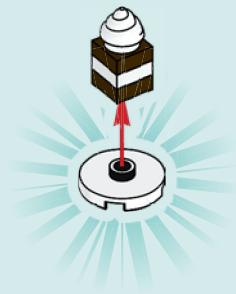





1x



1x

64





1x



1x

65





1x



2x

66

1



2





2x

67

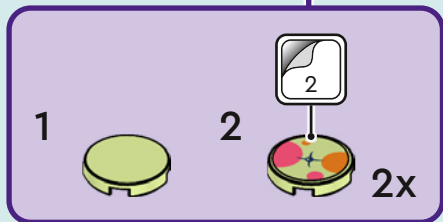

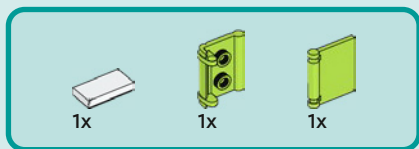

68

1

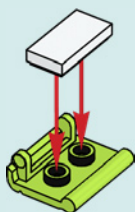

2

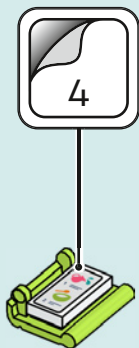

3

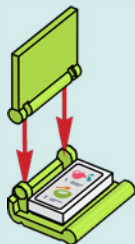

4

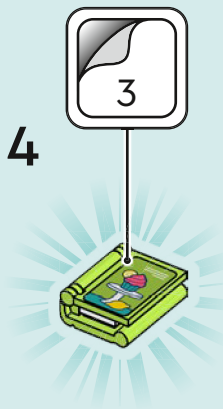



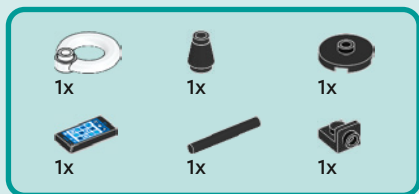

69

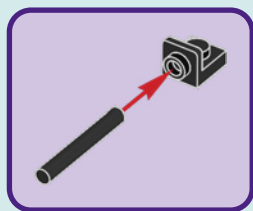

1



2

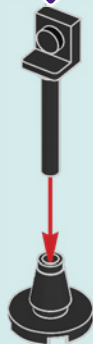

3



4

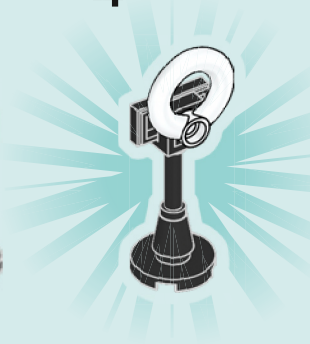



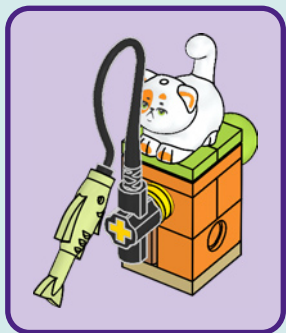

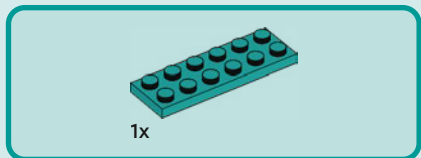

1

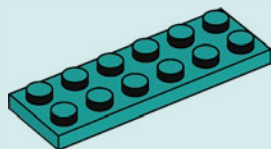



2x

2

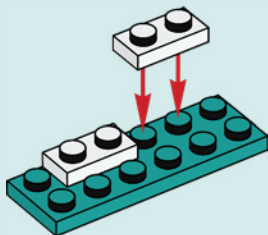

2x

3

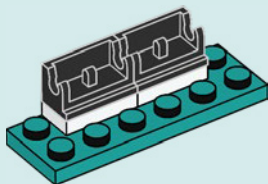



2x

4

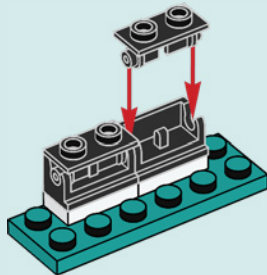

1x

5

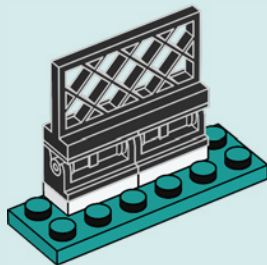

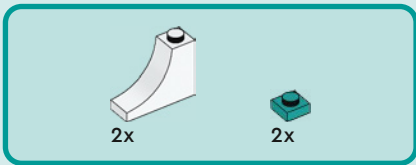

6

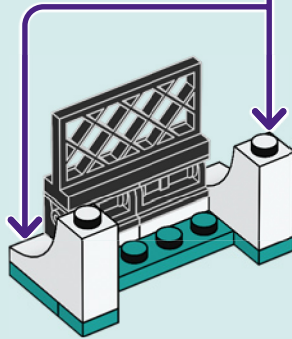
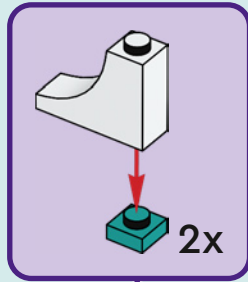

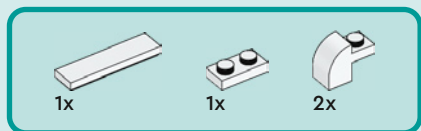

7

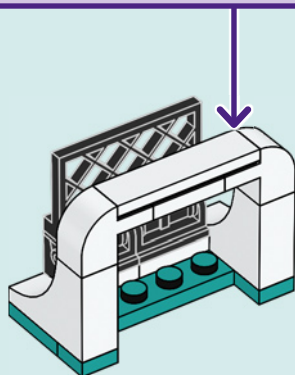
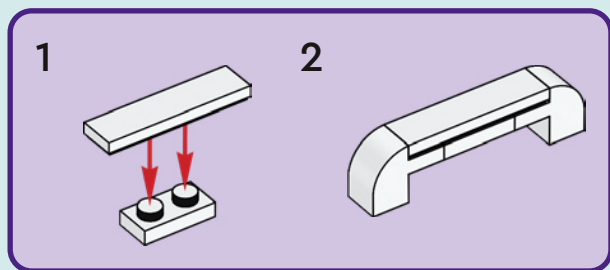

8

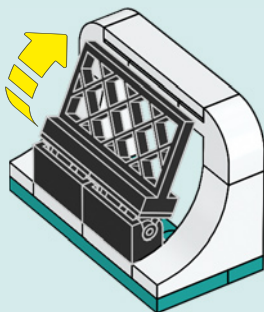



9

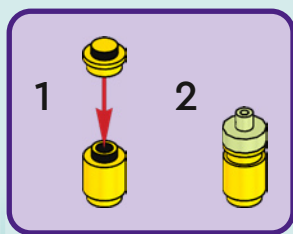
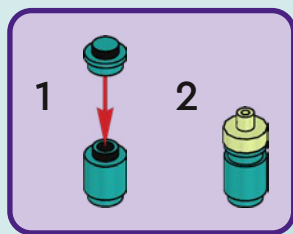

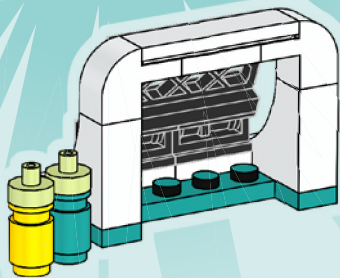



Friends

PAISLEY

AUTUMN

ALIYA

ZAC



LEO

LIANN

OLLY



NOVA



Friends

41727



41741

41738



41730





Friends

41731



41728



41743



1x
6292800

1x
4558952

2x
302401

1x
6348055

1x
6198979

1x
6321349

1x
6174310

1x
6174937

2x
4547489

1x
6093053

1x
6428858

3x
302301

2x
6285777

2x
6051511

1x
300401

1x
6248490

3x
306901



6x
6070327

1x
4261470

1x
4297083



2x
306801



1x
6300017

2x
6110019

1x
4619665

1x
243101

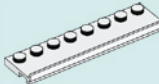
2x
6047813

2x
4500878

1x
6182260

2x
6271167

4x
614124

1x
306224

2x
4624985

1x
6261356



1x
6313121



3x
4141630

1x
374724

1x
243124

2x
6262947

1x
6130008

1x
303424

2x
6220715

1x
6136310

1x
6295184

1x
6261264

4x
6136553

3x
6078590



1x
4159007

1x
6106027

3x
4118782

2x
4648853

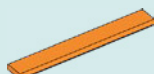
5



1x
6343067



1x
4529236



1x
6234695



1x
6359865



1x
6279875



1x
6195325



1x
6280097



2x
393726



2x
393826



1x
6329698



1x
6000650



1x
6093525



1x
4188953



1x
6306748



2x
6256058



1x
6244761



1x
6273627



1x
6274740



1x
6325978



1x
6325955



3x
6213778



6x
6213776



1x
6429249



3x
6210399



7x
6217659



2x
6342088



2x
6293302



2x
6213787

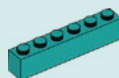

5x
6396079



2x
6291782



1x
6259794



1x
4624381



1x
6258352



1x
6258353



1x
6264062



1x
6286831



1x
6185108



2x
6092592



1x
6102906



1x
6430052



1x
6424457



1x
6060795



1x
6409759



4x
6194729



1x
6287856



1x
6416551



1x
6196796



2x
6312460



3x
4651231



2x
6223506



1x
4624086



1x
6226646



2x
6424480



1x
4113917



2x
6292154



1x
6291414



1x
4114084



1x
6429228



1x
6416639

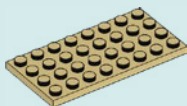

1x
4509897



2x
6192922



1x
6430144



1x
6135191



4x
6258566

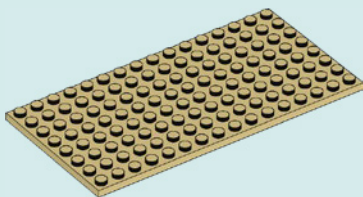

1x
4609726



1x
6093494



2x
6287638



1x
6099341



4x
6425367



1x
6295464



2x
4159553



1x
6313600



1x
6374151



 [LEGO.com/service](https://www.LEGO.com/service)

YOU COULD

WIN



Scan this QR code or go to
LEGO.COM/PRODUCTFEEDBACK
and give us your short feedback
about this LEGO® set for a chance
to win a cool LEGO prize.

Terms and Conditions apply*

DE: Du könntest GEWINNEN. Es gelten die Teilnahmebedingungen* **FR: Tu pourrais GAGNER.** Des conditions s'appliquent* **IT: Potresti VINCERE tu.** Termini e condizioni sono applicabili* **ES: Puedes GANAR.** Aplican términos y condiciones* **PT: Poderá GANHAR.** Aplicam-se termos e condições* **JA: プレゼント付き! 利用規約が適用されます*** **ZH: 轻松获奖. 条款和条件适用*** **KO: 상품의 주인이 되어보세요. 소정의 약관이 적용됩니다*** **RU: Вы можете ВЫИГРАТЬ.** Действуют положения и условия* **PL: Szansa na WYGRANĄ.** Obowiązują warunki korzystania* **CS: Máte šanci VYHRÁT.** Platí všeobecné smluvní podmínky* **SK: Máte šancu VYHRÁŤ.** Platia všeobecné zmluvné podmienky* **HU: TE IS NYERHETSZ.** Felhasználási feltételek érvényesek* **RO: Ai putea CÂȘTIGA.** Se aplică termeni și condiții* **BG: Можете да СПЕЧЕЛИТЕ.** Има определени правила и условия* **LV: Tu vari LAIMĒT.** Ir spēkā noteikumi un nosacījumi.* **ET: Sul on võimalus VÕITA.** Kehtivad tingimused* **LT: Jūs galite LAIMĖTI.** Taikomos sąlygos*

*[LEGO.com/productfeedback-terms](https://www.lego.com/productfeedback-terms)