



# Mixels™

# VAKA-WAKA

41553



7 [LEGO.com](http://LEGO.com)

6126532

1

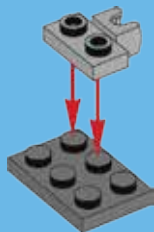

2



3



4

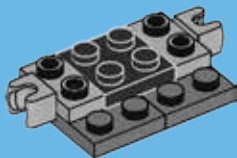

5

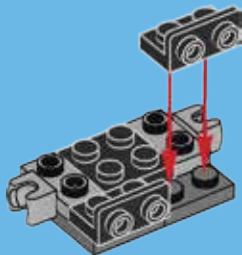

6

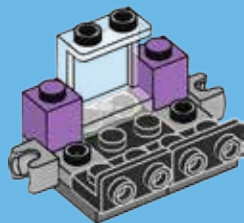

7

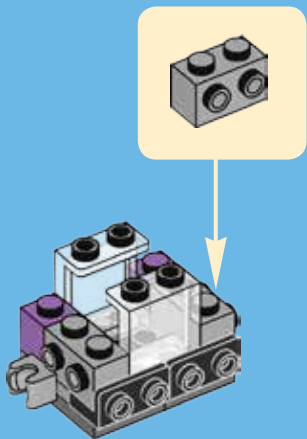

8

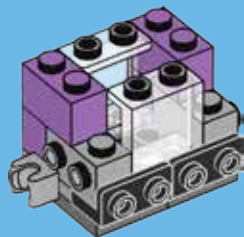

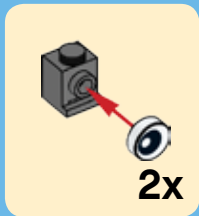

9

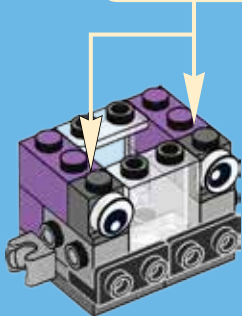

10

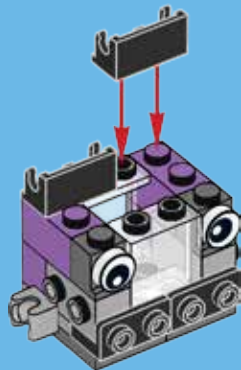

11

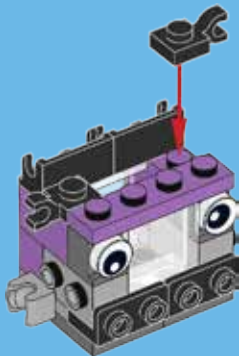

12

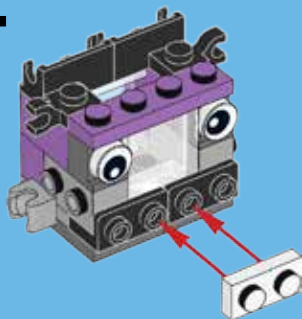

13

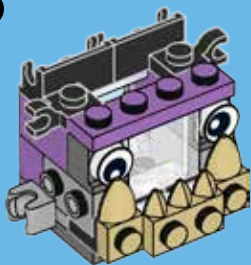

14

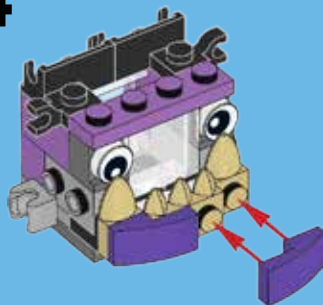

15

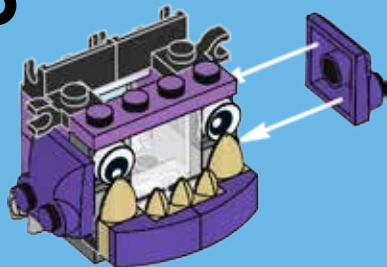

16

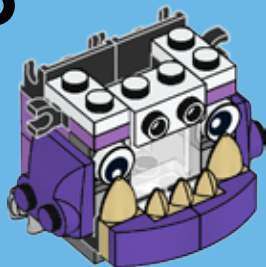



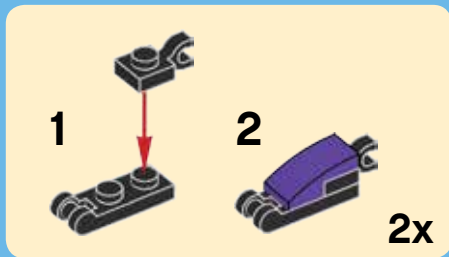

17

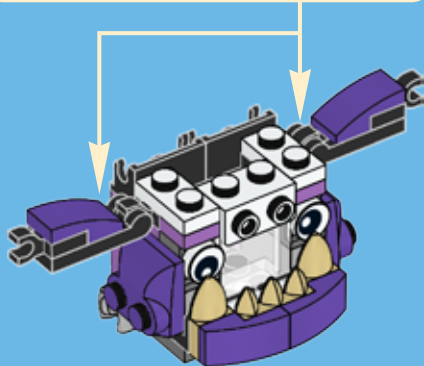

18

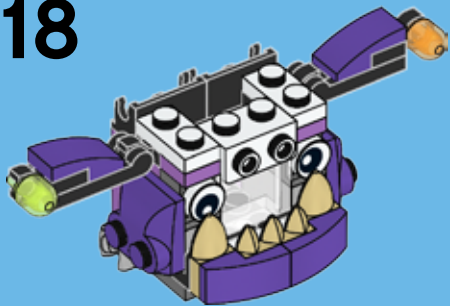

1



2

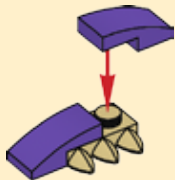

19

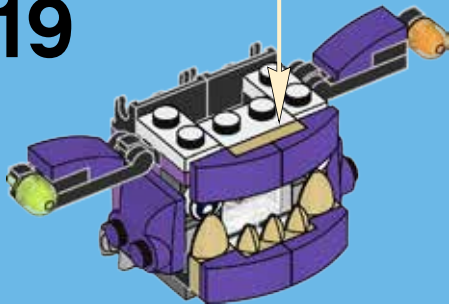

20

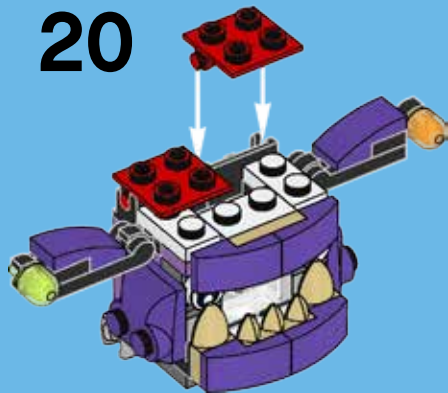

21

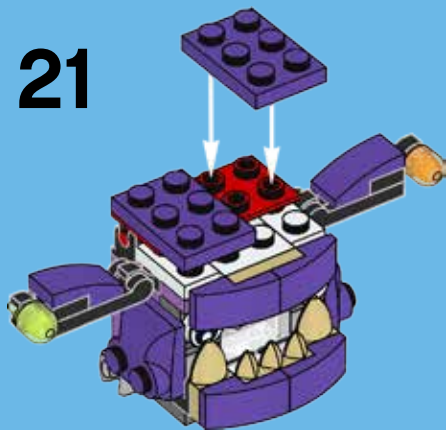

22

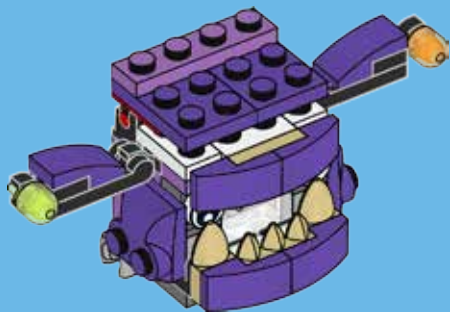

23

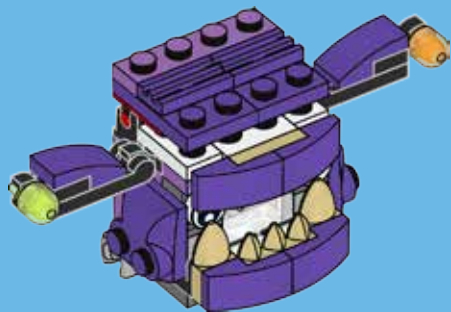

24

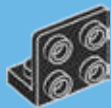

25

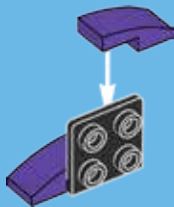

26

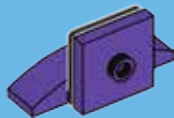

27



28

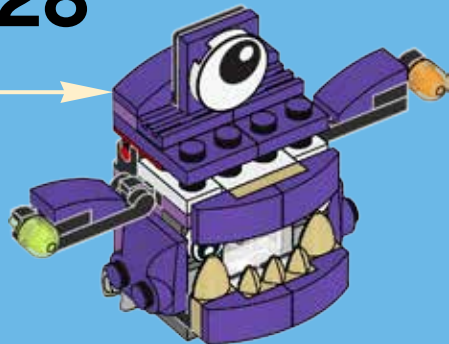

1

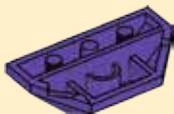

2

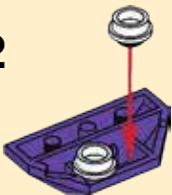

3



29

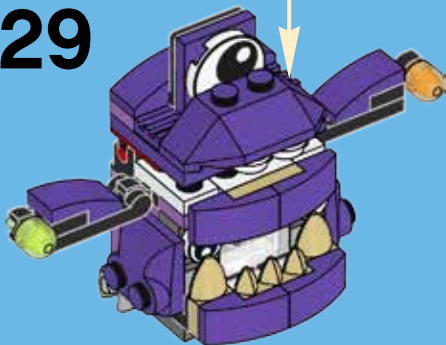





**30**



**31**



**32**

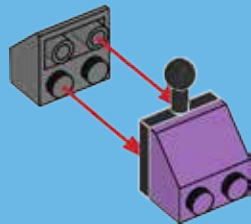

**2x**

33

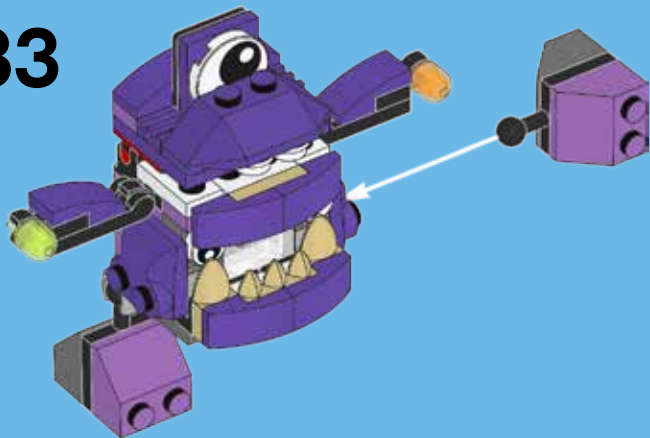

34

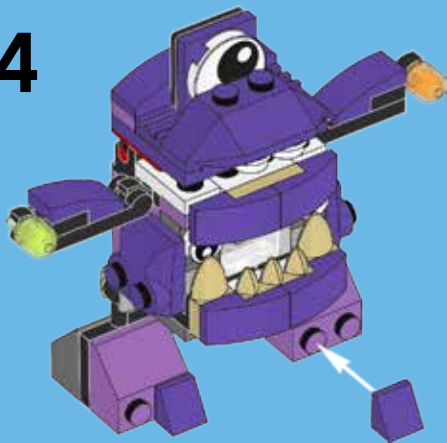



2x  
4224793



2x  
6000740



2x  
613421



2x  
4651903



3x  
302301



1x  
302226



2x  
4567509



2x  
6046907



2x  
6015344



2x  
4211044



2x  
4623598



1x  
6018774



1x  
6000650



8x  
6057390



1x  
4524365



2x  
6043656



2x  
4211000



2x  
6022023



2x  
614101



2x  
4515368



2x  
4655690



1x  
4570481



2x  
4211043



2x  
4619524



2x  
6029156



2x  
6051038



1x  
4659770



**Customer Service**

**Kundenservice**

**Service Consommateurs**

**Servicio Al Consumidor**

**LEGO.com/service or dial**



**00800 5346 5555 :**



**1-800-422-5346 :**



4x  
4517925



2x  
393726



2x  
4225142



2x  
6020193



1x  
6109767



2x  
6109766



**SNAX**  
41551



**MUNCHOS**  
**MAX!**



**BERP**  
41552



**VAKA-WAKA**  
41553



[LEGO.com/mixels](http://LEGO.com/mixels)





# Mixels™



**41545  
KRAMM**



**41546  
FORX**



**41547  
WUZZO**



**41548  
DRIBBAL**



**41549  
GURGGLE**



**41550  
SLUSHO**



**41551  
SNAX**



**41552  
BERP**



**41553  
VAKA-WAKA**



[LEGO.com/mixels](http://LEGO.com/mixels)





**YOU CAN BUY THE GAME!  
TU PEUX ACHETER LE JEU !  
¡PUEDES COMPRAR EL JUEGO!**

**DOUB1ETROUB1E**

**IN GAME CODE!  
CODE DANS LE JEU !  
¡CÓDIGO PARA EL JUEGO!**



# Mixels RUSH



Apple, the Apple logo, iPad, iPhone and iPod touch are trademarks of Apple Inc., registered in the U.S. and other countries. App Store is a service mark of Apple Inc.

Apple, le logo Apple, iPad, iPhone et iPod touch sont des marques de commerce d'Apple Inc., déposées aux États-Unis et dans d'autres pays. App Store est une marque de service d'Apple Inc.

Apple, el logotipo de Apple, iPad, iPhone e iPod touch son marcas comerciales de Apple Inc. registradas en EE. UU. y otros países. App Store es una marca de servicio de Apple Inc.

Google Play is a trademark of Google Inc.

Google Play est une marque de commerce de Google Inc.

Google Play es una marca comercial de Google Inc.