



# Mixels™

# WUZZO



41547



 [LEGO.com](http://LEGO.com)

6126513

1

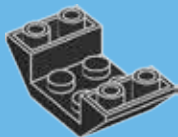

2



**3**

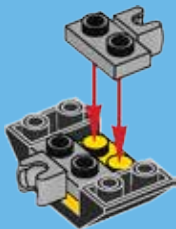

**4**

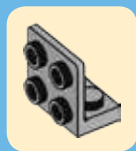

5

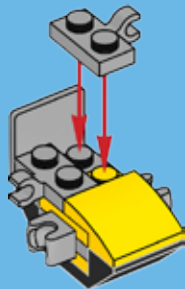

6

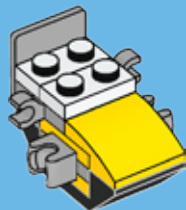



7



8



9

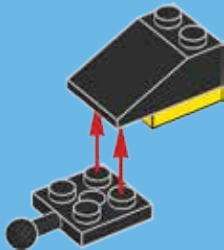

10

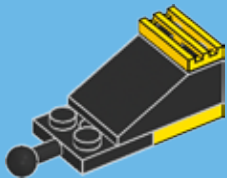

11

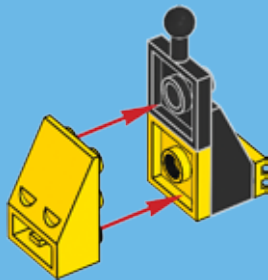

12



2x

13

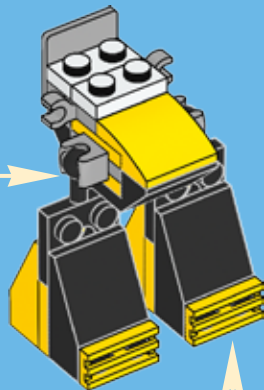

1



2



2x

14

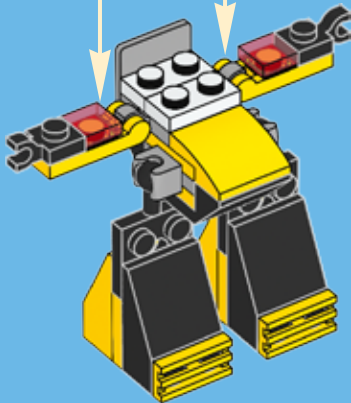



15

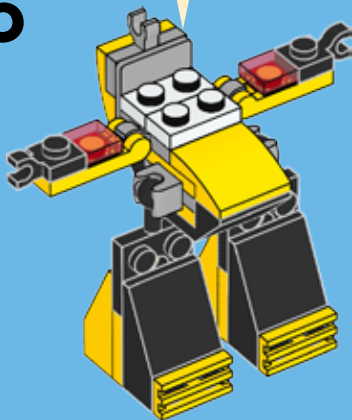
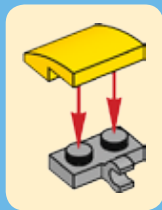



16

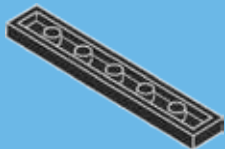

17

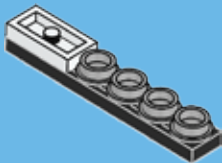

18

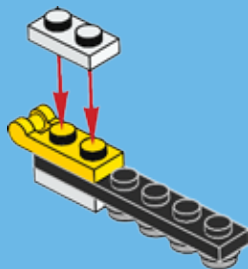

19

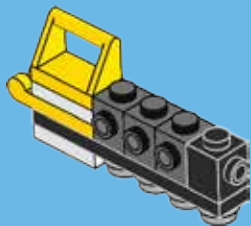

20

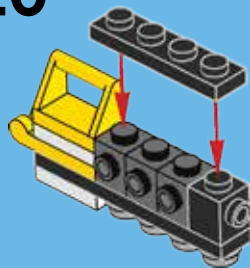

21

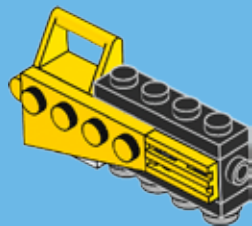

22

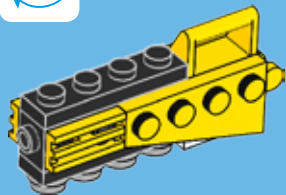

23

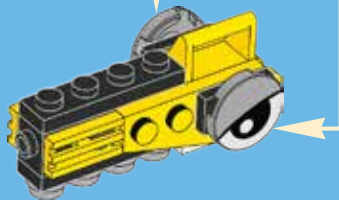
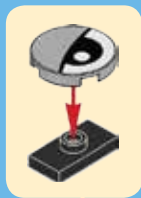

24

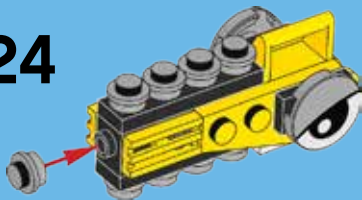

25

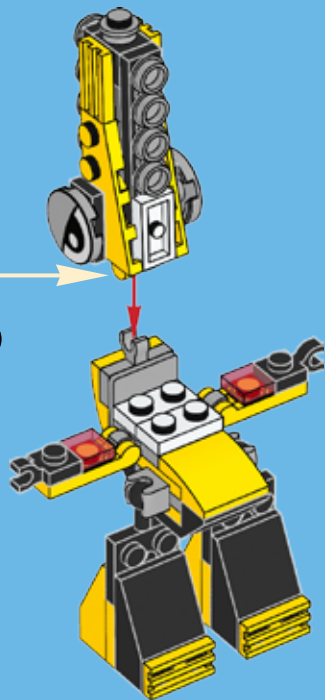



26



27

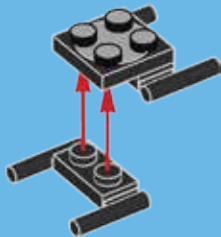

28

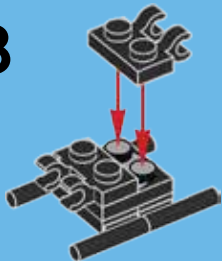

29

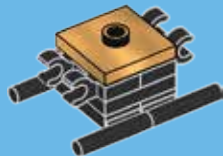

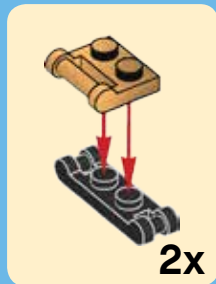

30

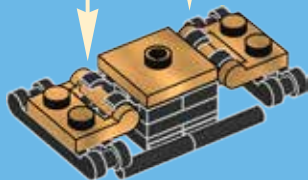





**31**

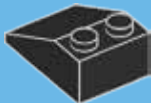

**32**

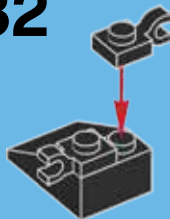

**33**

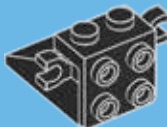

**34**

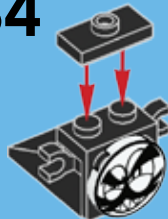

35

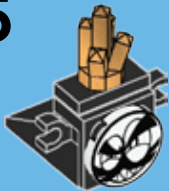

36

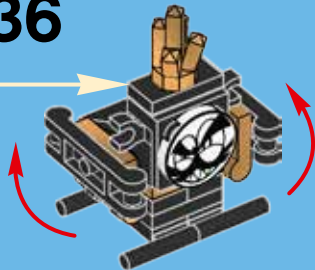



1x  
4558954



1x  
368026



1x  
243224



4x  
241224



3x  
4213574



2x  
3003941



4x  
4517925



2x  
6099483



3x  
4515367



4x  
302224



4x  
302301



1x  
6107193



3x  
6092585



1x  
371026



2x  
6079007



2x  
6043656



1x  
6097124



2x  
4585493



2x  
4556158

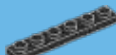

1x  
366626



2x  
374724



3x  
6028812



2x  
6100970



1x  
4516816



2x  
6051038



1x  
4188534



1x  
4161331



1x  
4654580



1x  
4540203



1x  
6117973



3x  
329826



1x  
4160868



9x  
4211525



2x  
383926



**Customer Service**

**Kundenservice**

**Service Consommateurs**

**Servicio Al Consumidor**

**LEGO.com/service or dial**



**: 00800 5346 5555**



**: 1-800-422-5346**



**LEGO.com/mixels**





**KRAMM  
41545**



**FORX  
41546**



**WUZZO  
41547**



**WELDOS MAX!**



[LEGO.com/mixels](http://LEGO.com/mixels)





# Mixels™



**41545  
KRAMM**



**41546  
FORX**



**41547  
WUZZO**



**41548  
DRIBBAL**



**41549  
GURGGLE**



**41550  
SLUSHO**



**41551  
SNAX**



**41552  
BERP**



**41553  
VAKA-WAKA**



[LEGO.com/mixels](http://LEGO.com/mixels)





**YOU CAN BUY THE GAME!  
TU PEUX ACHETER LE JEU!  
¡PUEDES COMPRAR EL JUEGO!**

**CH A 1 N S A 8**

**IN GAME CODE!  
CODE DANS LE JEU!  
¡CÓDIGO PARA EL JUEGO!**



# Mixels RUSH



Apple, the Apple logo, iPad, iPhone and iPod touch are trademarks of Apple Inc., registered in the U.S. and other countries. App Store is a service mark of Apple Inc.

Apple, le logo Apple, iPad, iPhone et iPod touch sont des marques de commerce d'Apple Inc., déposées aux États-Unis et dans d'autres pays. App Store est une marque de service d'Apple Inc.

Apple, el logotipo de Apple, iPad, iPhone e iPod touch son marcas comerciales de Apple Inc. registradas en EE. UU. y otros países. App Store es una marca de servicio de Apple Inc.

Google Play is a trademark of Google Inc.

Google Play est une marque de commerce de Google Inc.

Google Play es una marca comercial de Google Inc.