



Mixels™

SPUGG



41542



WARNING: CHOKING HAZARD.
Toy contains small parts and a small ball.
Not for children under 3 years.



LEGO.com

6126527

1



2

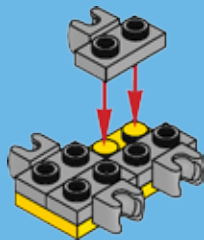

AVERTISSEMENT : RISQUE D'ÉTOUFFEMENT.

Le jouet contient des petites pièces ainsi qu'une petite boule.
Il ne convient pas aux enfants de moins de 3 ans.



ADVERTENCIA: PELIGRO DE ASFIXIA.

Juguete que contiene partes pequeñas y una pelota pequeña.
No recomendado para niños menores de 3 años.

3

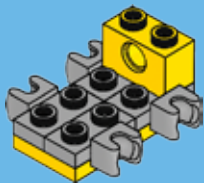

4

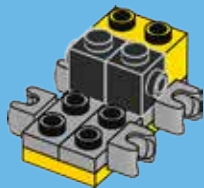

5

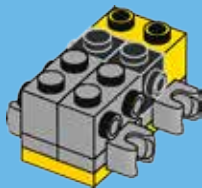

6

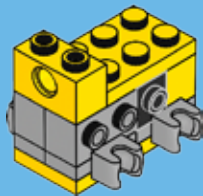

7

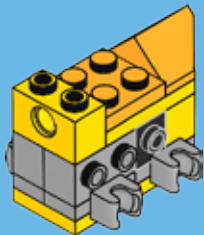

8

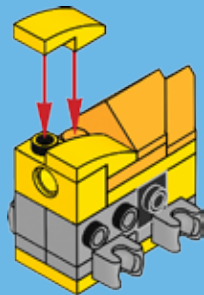

9

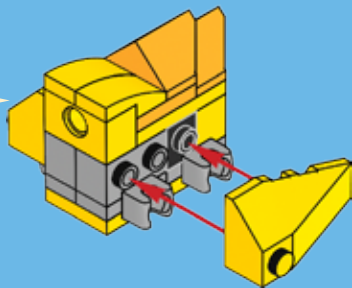
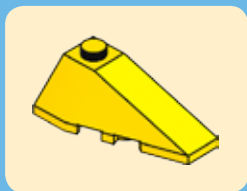

10

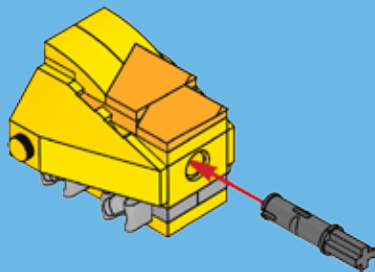

11

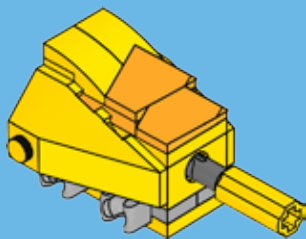

12

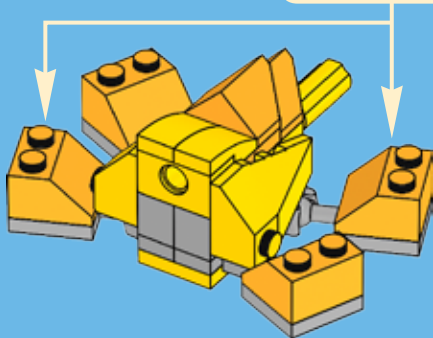
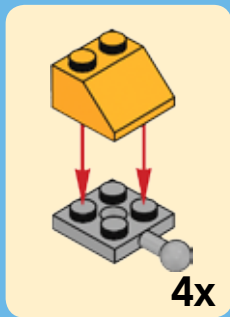

13

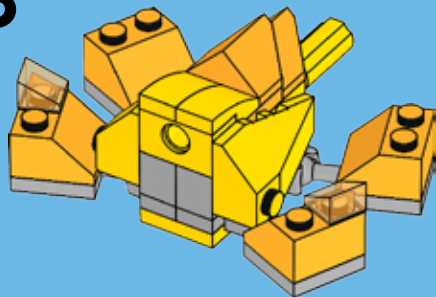

14

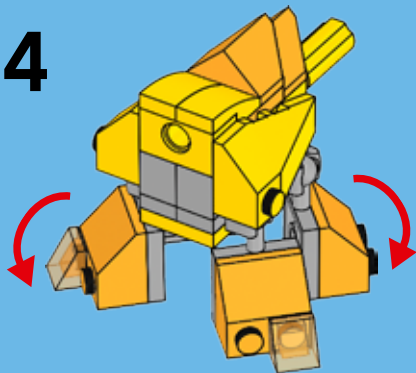



15



16



17



18



19



20



21



22



23



24

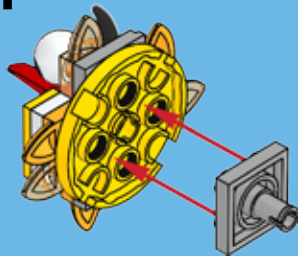

25

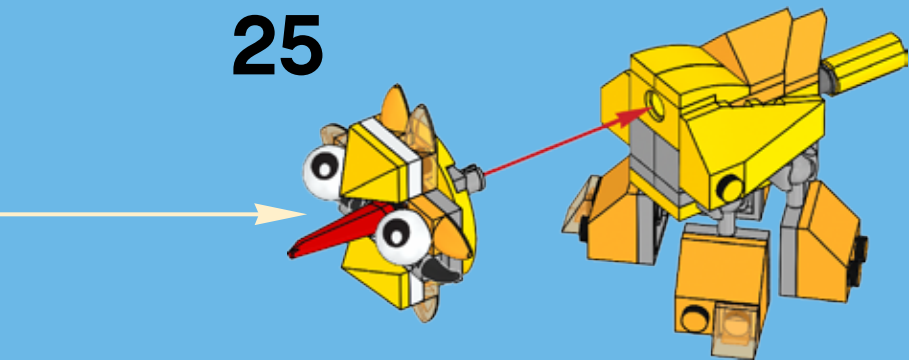

26

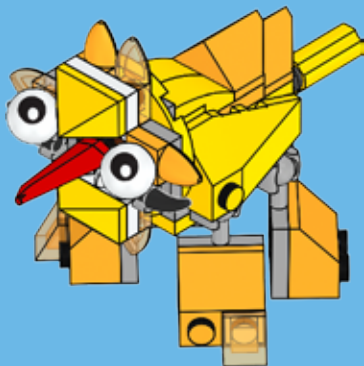

2x
6029947

2x
370024

1x
6015356

4x
6043656

3x
4282860

2x
6046381

2x
6075085

1x
302124

2x
4558954

2x
4598526

2x
6015238

2x
6056225

1x
4519010

1x
302024

2x
4568385

1x
4237084

4x
6020181

1x
4616842

1x
6056681

1x
4515349

2x
4244369

4x
6063611

1x
6003033

1x
6056679

1x
6102360

3x
6104016

2x
6015344



Customer Service

Kundenservice

Service Consommateurs

Servicio Al Consumidor

LEGO.com/service or dial



: 00800 5346 5555

: 1-800-422-5346



Mixels™



41536
GOX



41537
JINKY



41538
KAMZO



41539
KROG



41540
CHILBO



41541
SNOOF



41542
SPUGG



41543
TURG



41544
TUNGSTER



LEGO.com/mixels





**SPUGG
41542**



**LIXERS
MAX!**



**TURG
41543**



**TUNGSTER
41544**



LEGO.com/mixels





  **LEGO.com/mixels**  





**YOU CAN BUY THE GAME!
TU PEUX ACHETER LE JEU !
¡PUEDES COMPRAR EL JUEGO!**

P 2 P S Y D A 1 S Y

**IN GAME CODE!
CODE DANS LE JEU !
¡CÓDIGO PARA EL JUEGO!**



Apple, the Apple logo, iPad, iPhone and iPod touch are trademarks of Apple Inc. Apple, le logo Apple, iPad, iPhone et iPod touch sont des marques de commerce d'Apple Inc.

Apple, el logotipo de Apple, iPad, iPhone e iPod touch son marcas comerciales de Apple Inc.

Mixels RUSH



Google Play is a trademark of Google Inc.

Google Play est une marque de commerce de Google Inc.

Google Play es una marca comercial de Google Inc.