



Mixels



SNOOF
41541



MIX!



TUNGSTER
41544



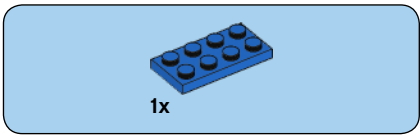

1

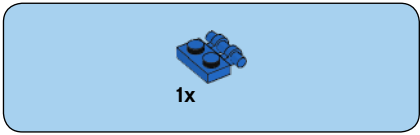
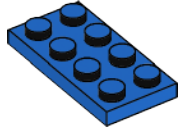

2

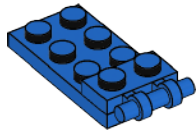



2x

3

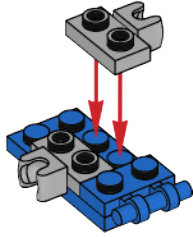

1x

4

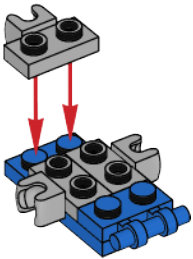



2x

5

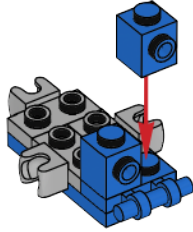

1x

6

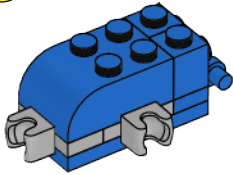
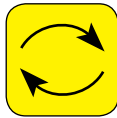

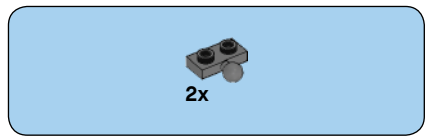

7

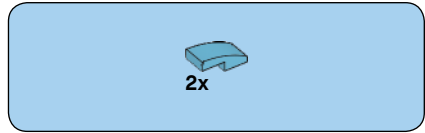
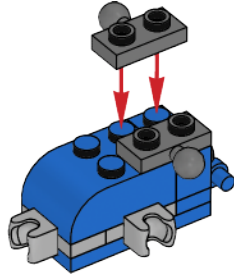

8

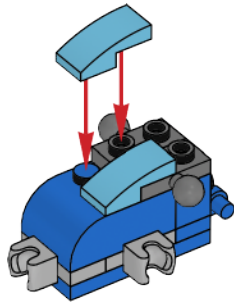



2x

9

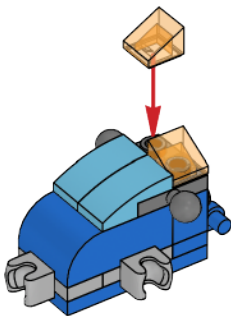

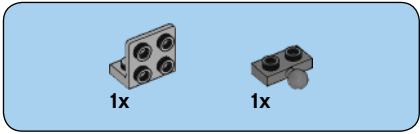
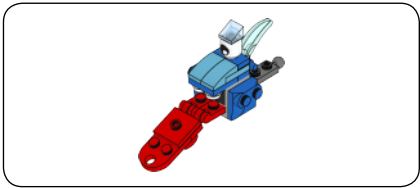

10

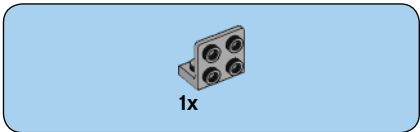
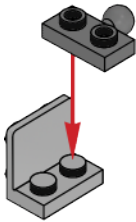

11

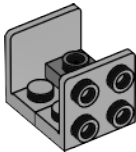

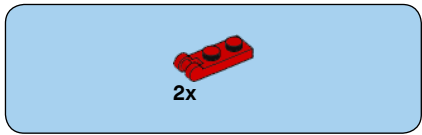

12

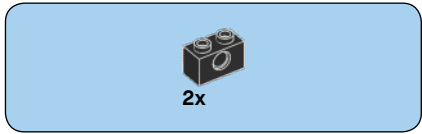
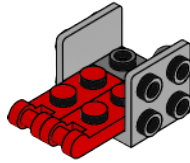

13

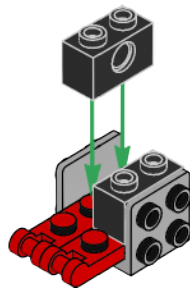

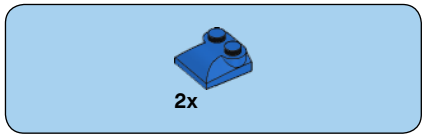

14

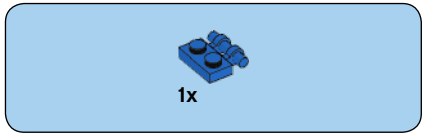
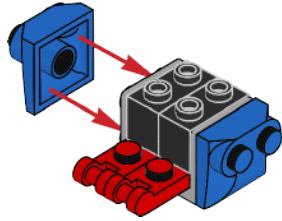

15

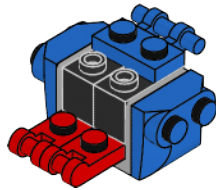



16

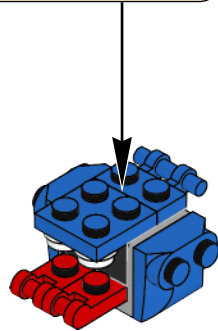
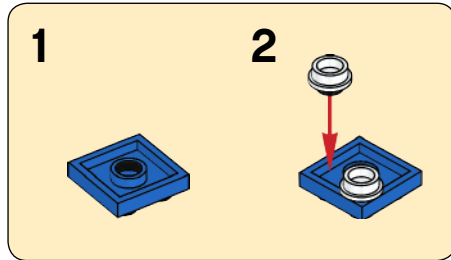

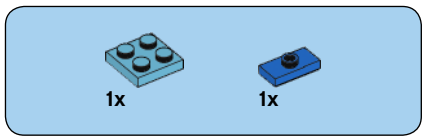

17

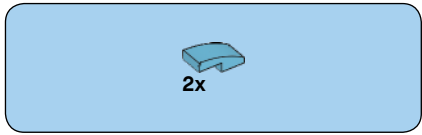
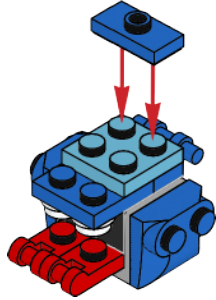

18

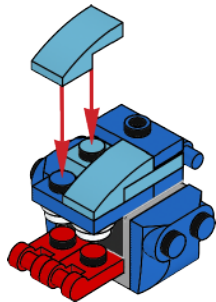

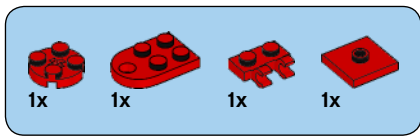

19

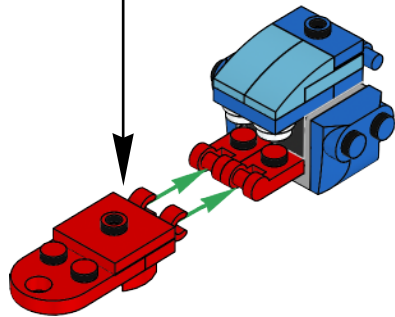
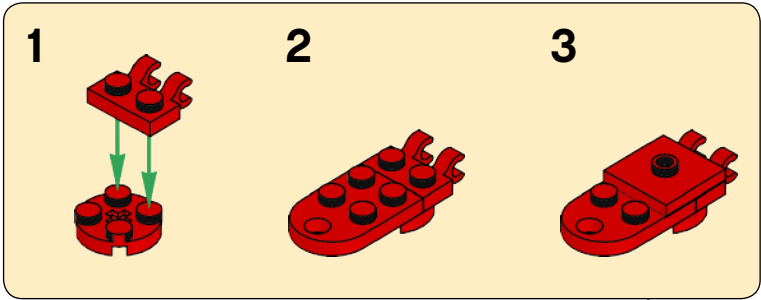

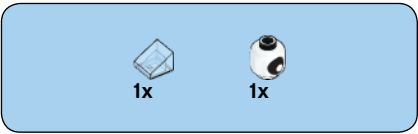

20

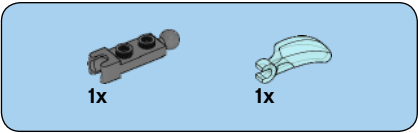
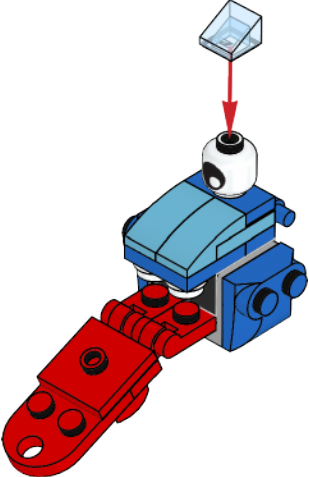

21

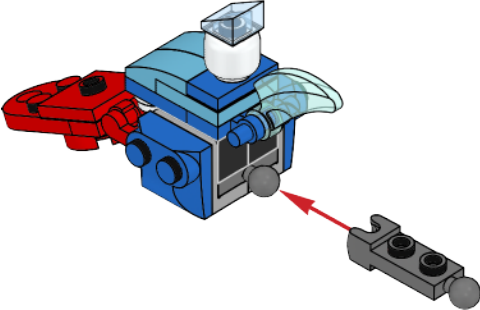



1x

22

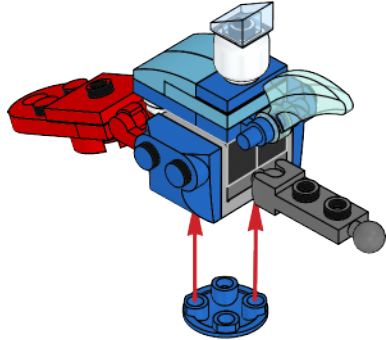

23

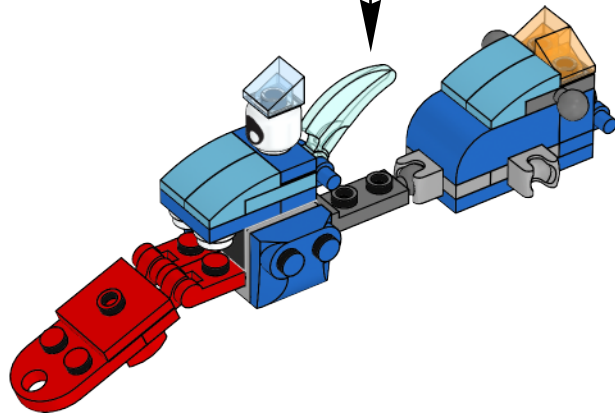

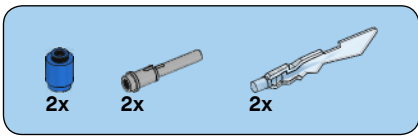

24

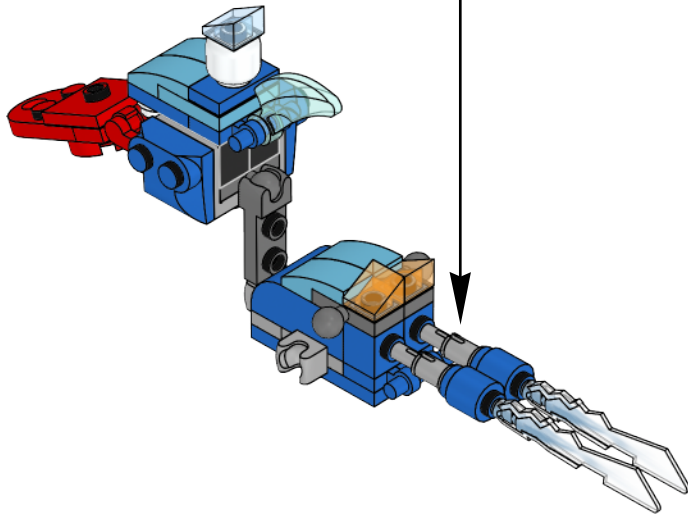
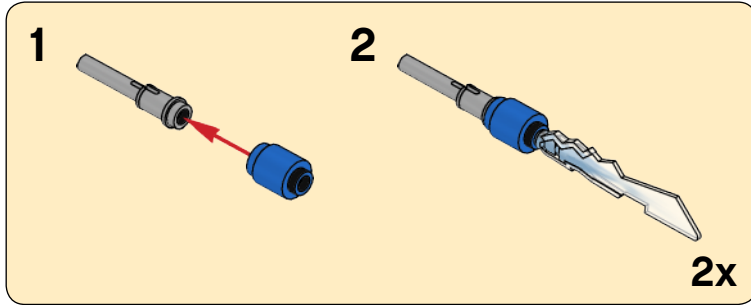

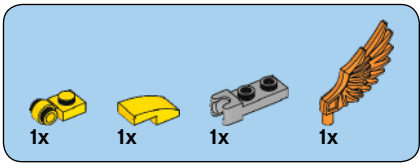

25

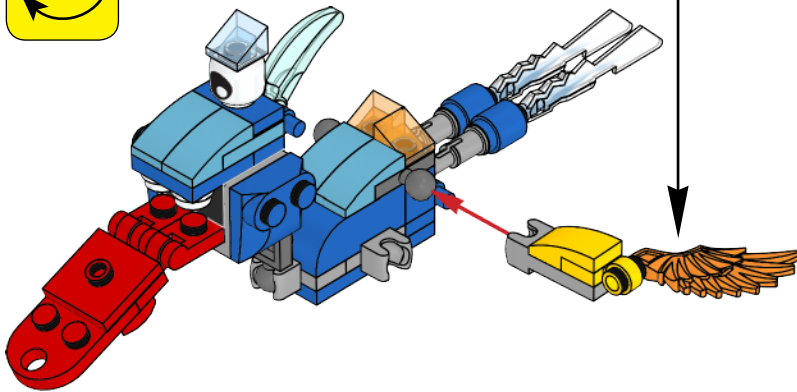
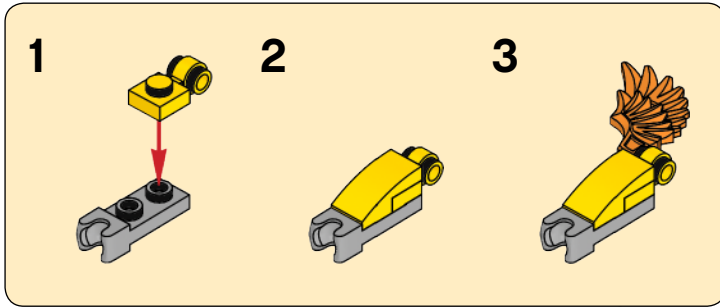

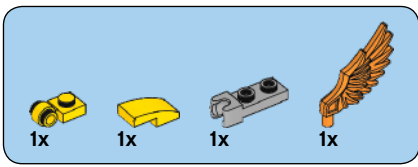

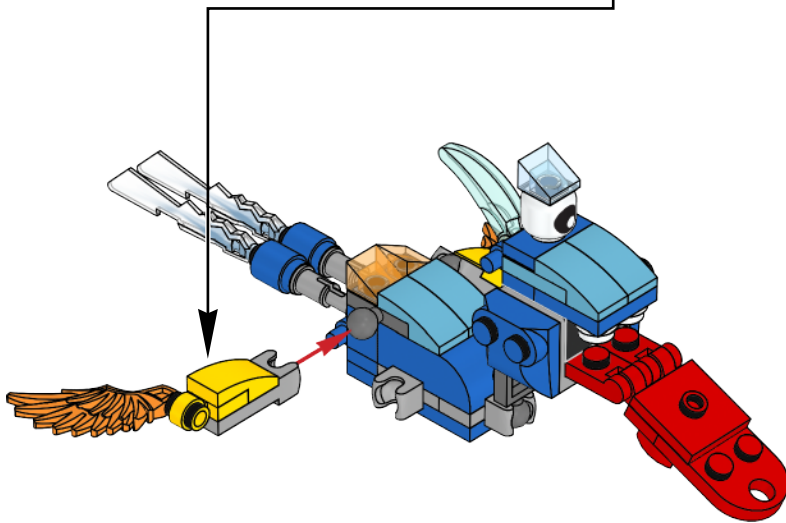
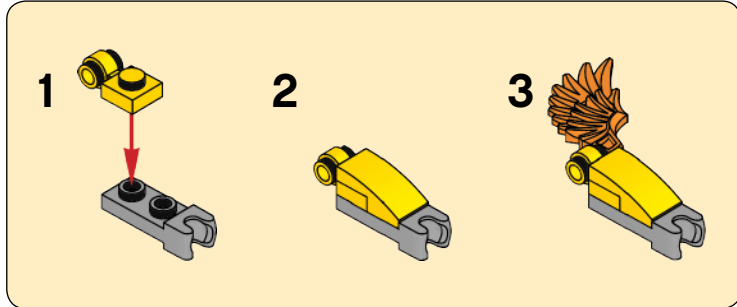

26

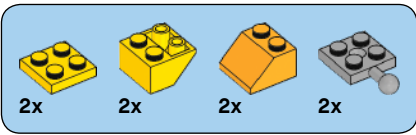



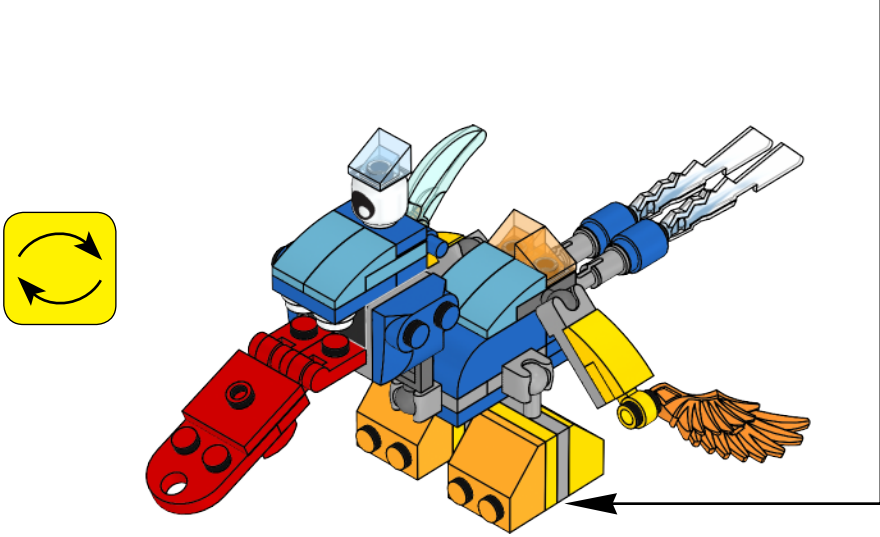
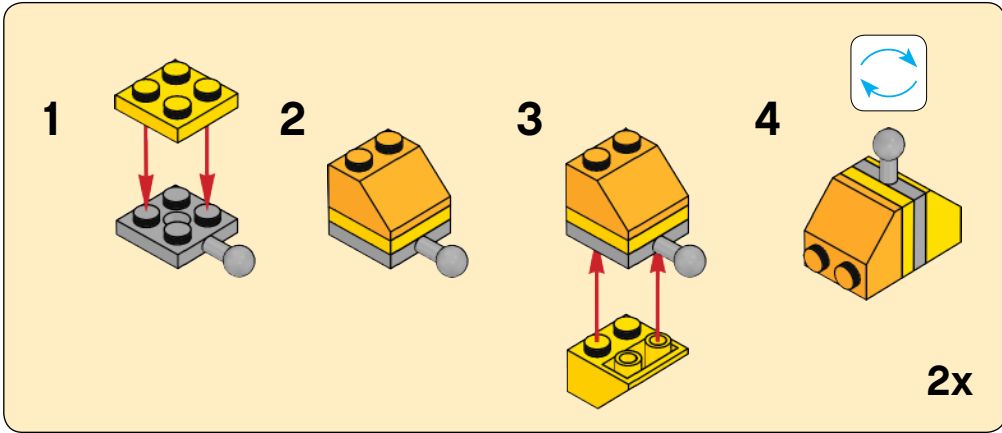



27

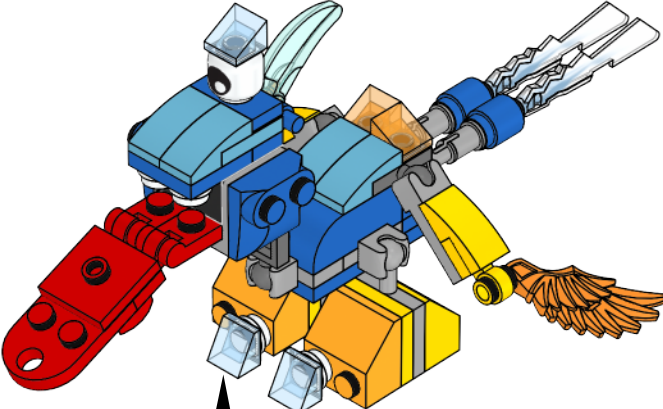

2x  2x 

28



1  2  2x 

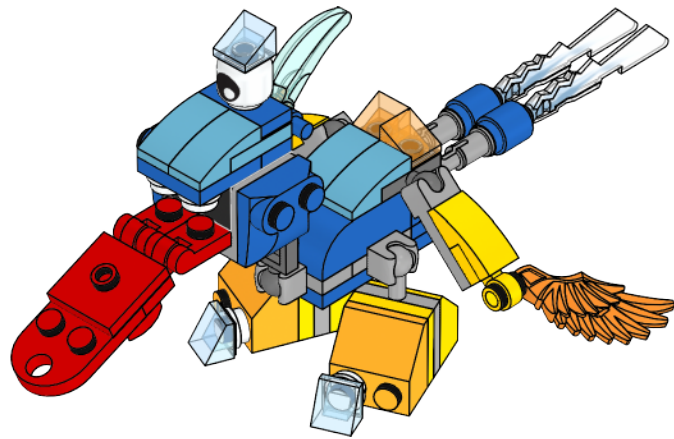



LEGO, the LEGO logo and MIXELS are trademarks of the/sont des marques de commerce du/son marcas registradas de LEGO Group. ©2015 The LEGO Group.

TM & © 2015 Cartoon Network