



Mixels™

SNOOF



41541



7 LEGO.com

6126523

1

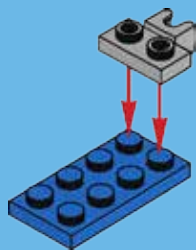

2

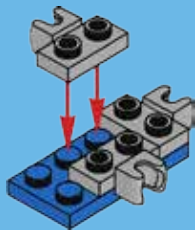

3

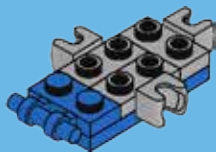

4

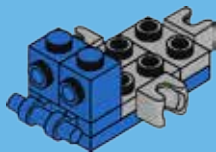

5

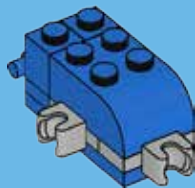

6

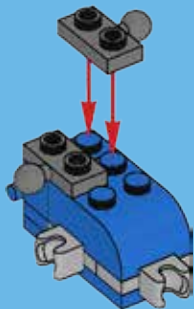

7

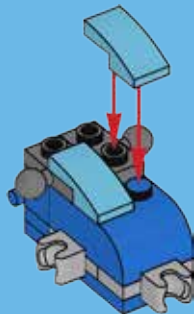

1



2



3

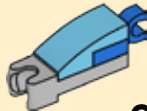

2x

8

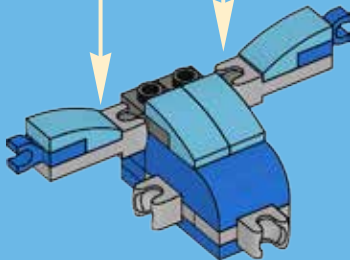



9

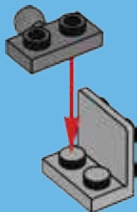

10

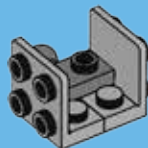

11

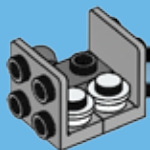

12

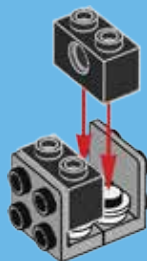

13

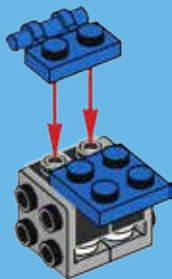

14

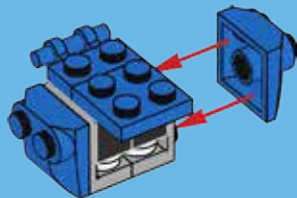

15

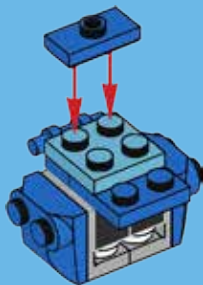

16



17

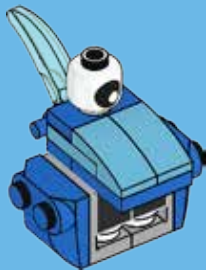

18

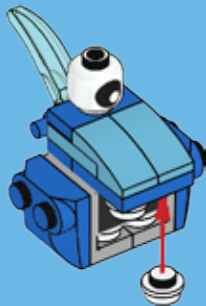

19

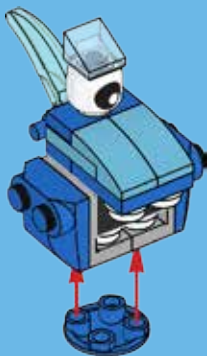

20

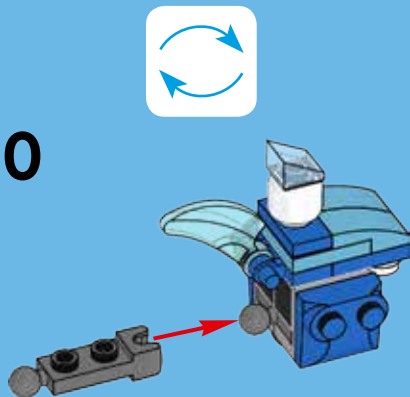

21

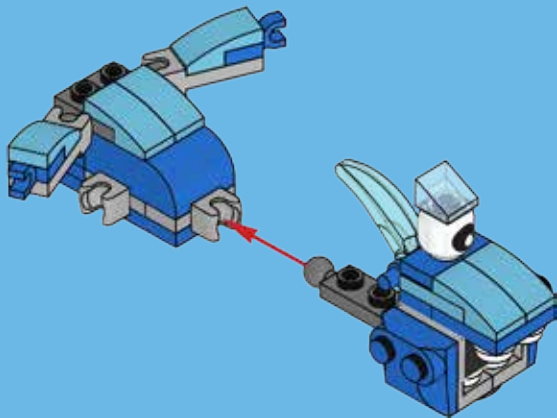

22

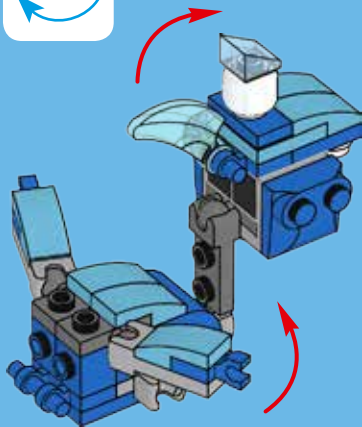



23

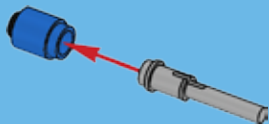

24



2x

25

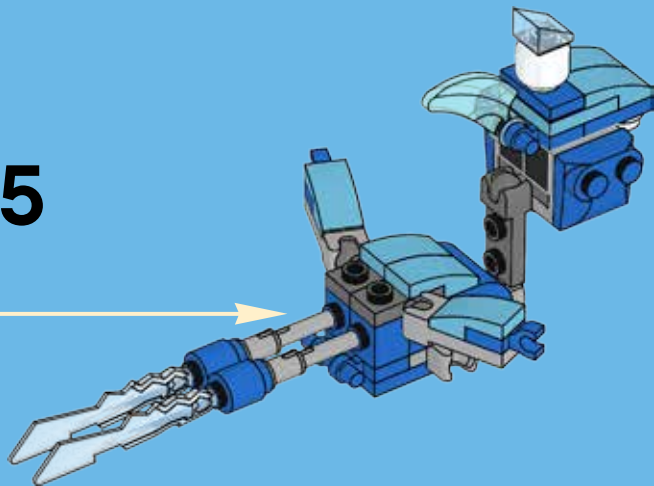

26

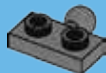

27

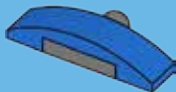

28



29



30

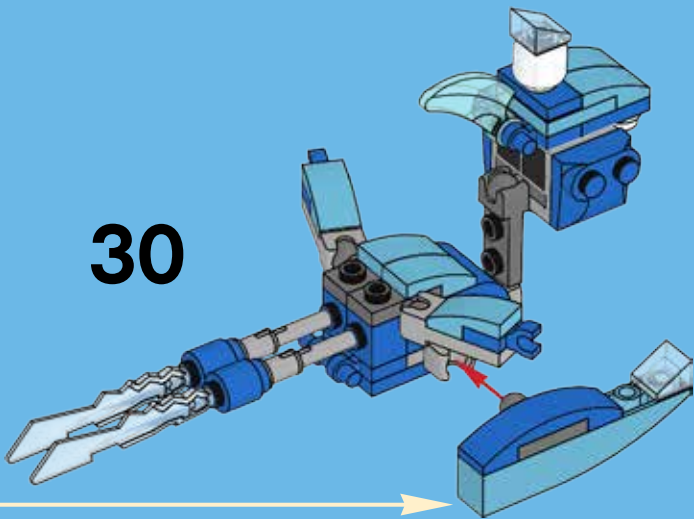

31

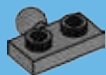

32



33

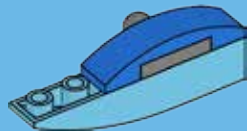

34



35

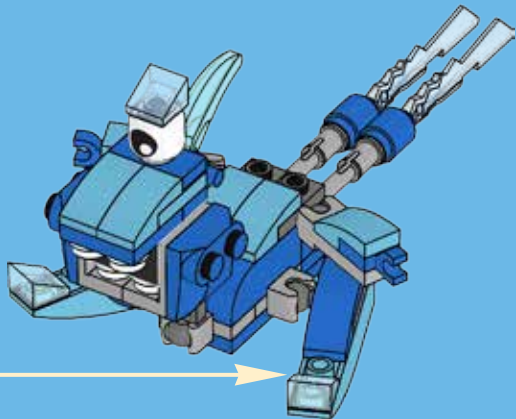

6x
6071246

4x
614101

2x
6022109

3x
6043656

2x
4520946

1x
6092582

1x
4625032

1x
6060802

2x
370026

2x
4654580

2x
4140586

2x
4583862

2x
6102650

1x
6071312

5x
6039479

2x
6043639

1x
4278276

2x
306223

3x
4611464

1x
6039482

2x
4520320

2x
4496366

1x
302223

1x
621523



Customer Service

Kundenservice

Service Consommateurs

Servicio Al Consumidor

LEGO.com/service or dial



00800 5346 5555 :

1-800-422-5346 :



1x
302023

2x
4649773



**KROG
41539**



**FROSTICONS
MAX!**



**CHILBO
41540**



**SNOOF
41541**



LEGO.com/mixels





Mixels™



41536
GOX



41537
JINKY



41538
KAMZO



41539
KROG



41540
CHILBO



41541
SNOOF



41542
SPUGG



41543
TURG



41544
TUNGSTER



LEGO.com/mixels





**YOU CAN BUY THE GAME!
TU PEUX ACHETER LE JEU !
¡PUEDES COMPRAR EL JUEGO!**

IC Y H A Y S 7 7 D

**IN GAME CODE!
CODE DANS LE JEU !
¡CÓDIGO PARA EL JUEGO!**



Apple, the Apple logo, iPad, iPhone and iPod touch are trademarks of Apple Inc. Apple, le logo Apple, iPad, iPhone et iPod touch sont des marques de commerce d'Apple Inc.

Apple, el logotipo de Apple, iPad, iPhone e iPod touch son marcas comerciales de Apple Inc.

Mixels RUSH



Google Play is a trademark of Google Inc.

Google Play est une marque de commerce de Google Inc.

Google Play es una marca comercial de Google Inc.