



ELVES

41188





LEGO.com/brickseparator

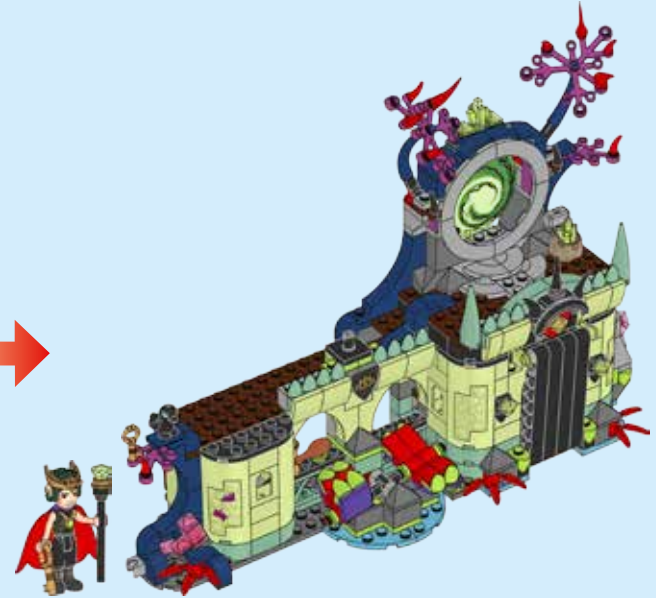
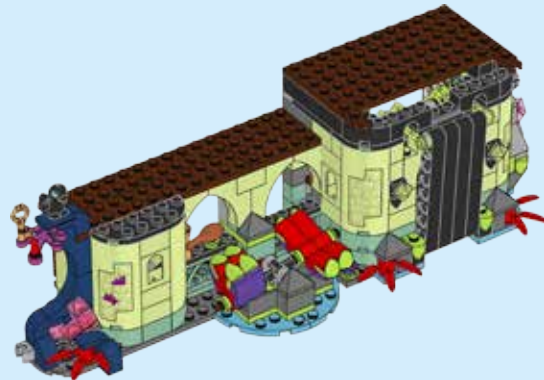
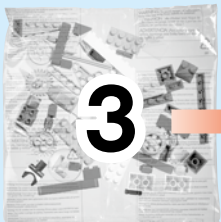
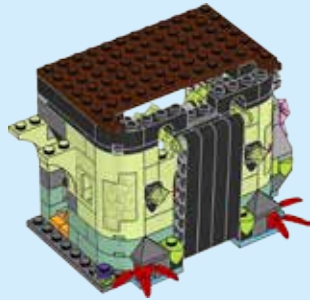
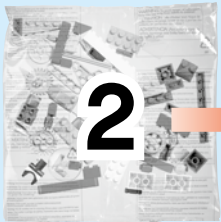

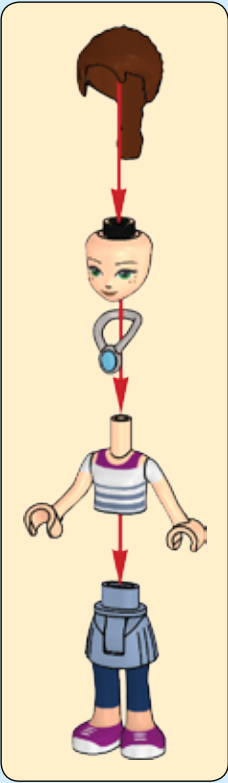
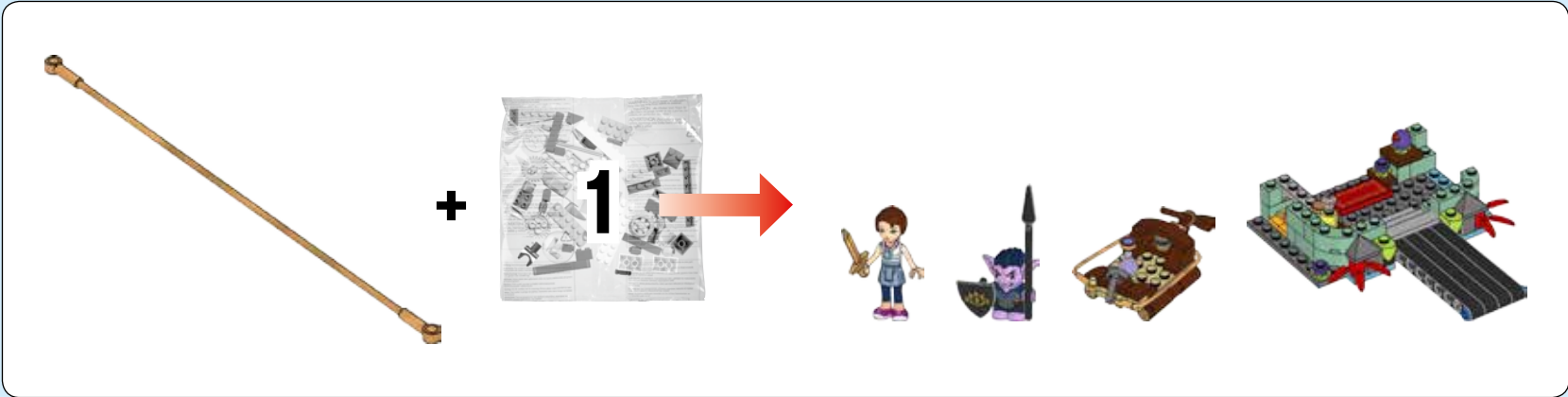

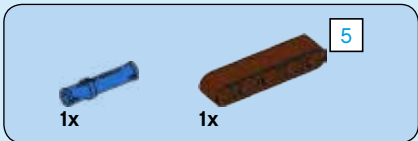

1

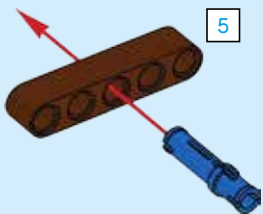

2

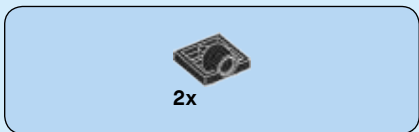
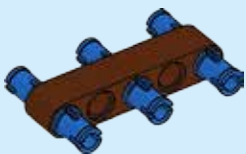

3



4

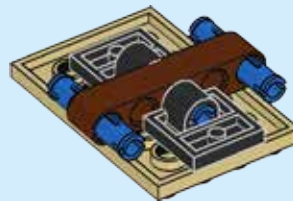

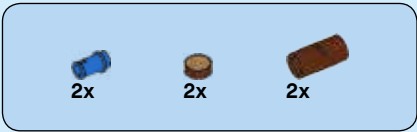

5

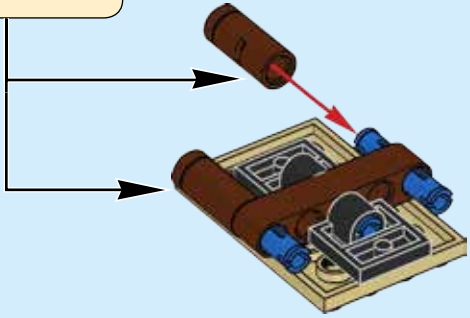
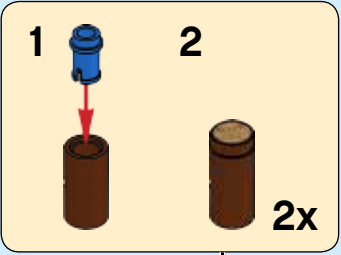

6

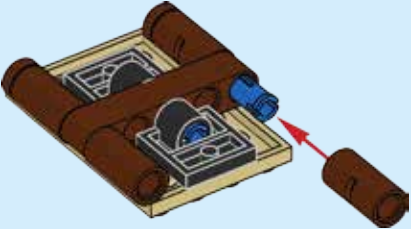



7

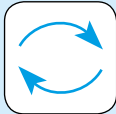

8

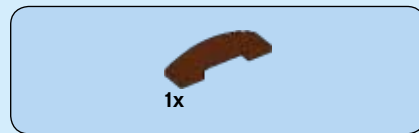

9





10



11

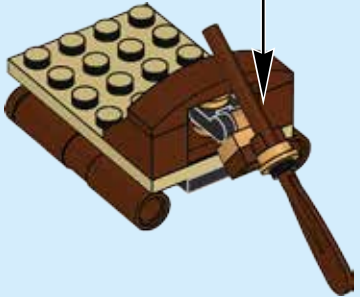
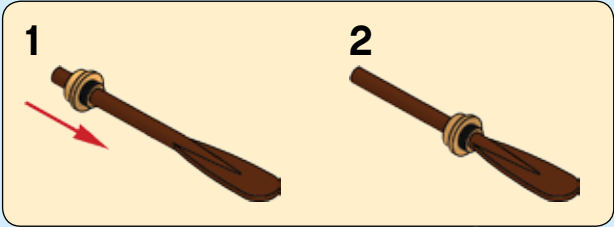



12



13

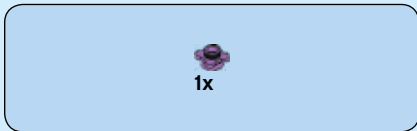

14



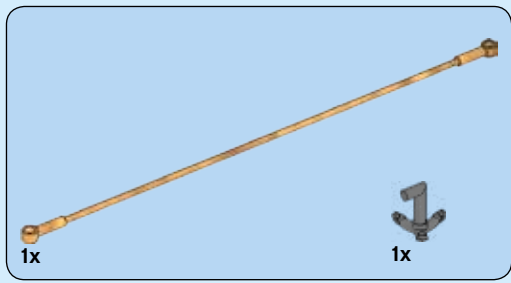

15

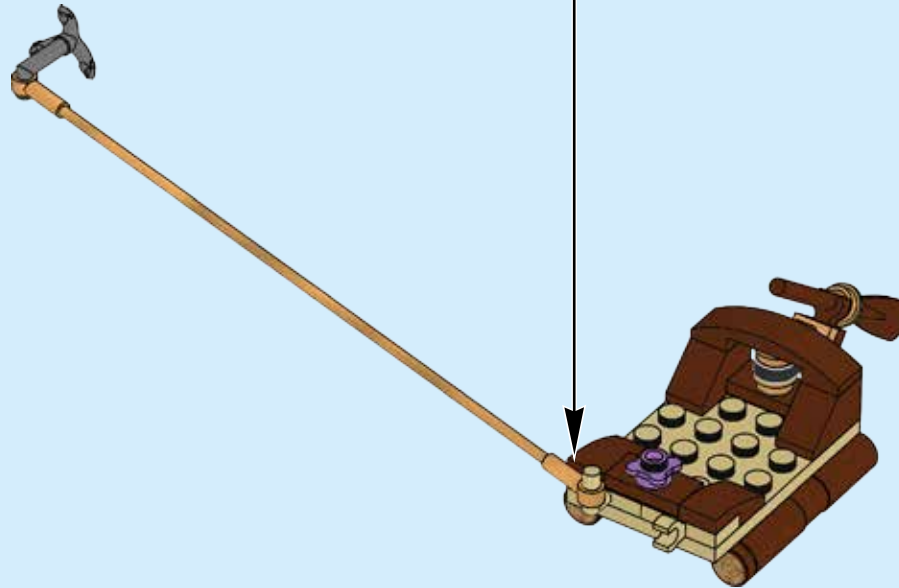
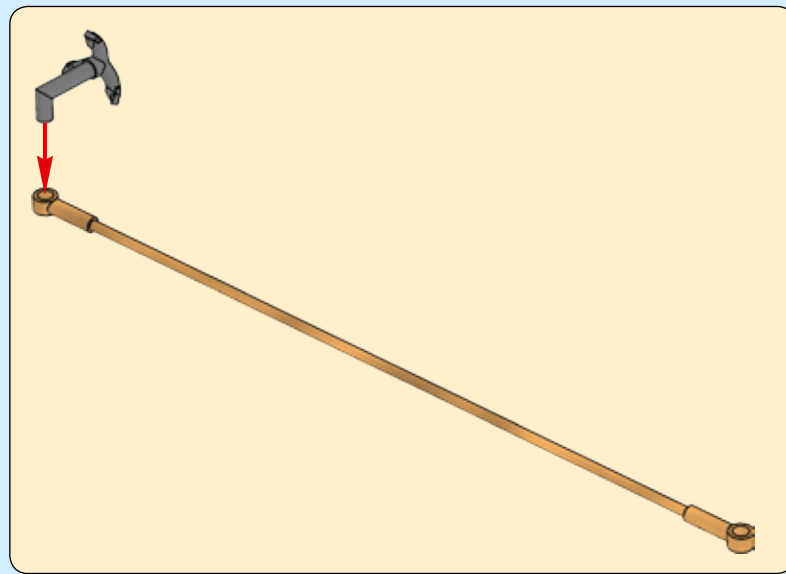

16

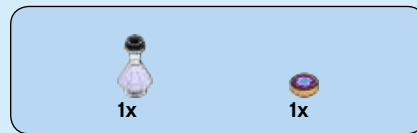

17

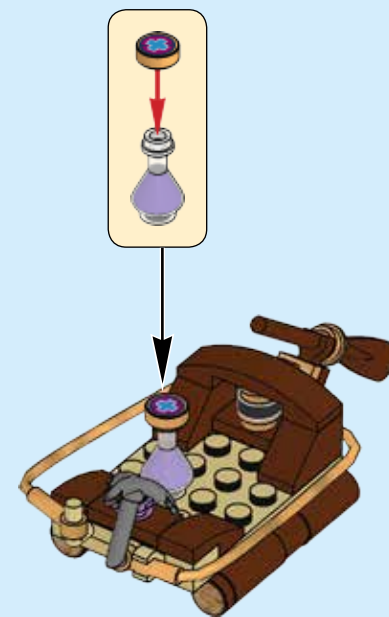

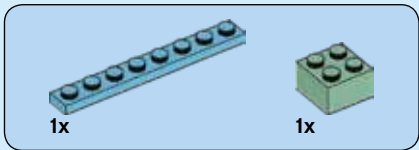
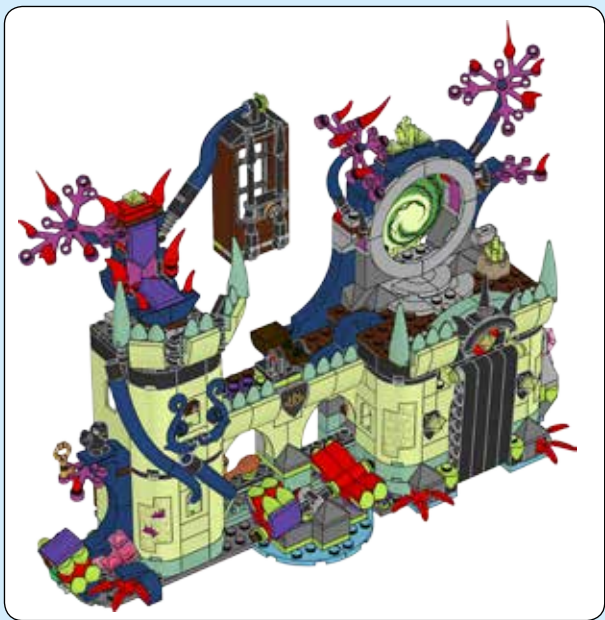

1

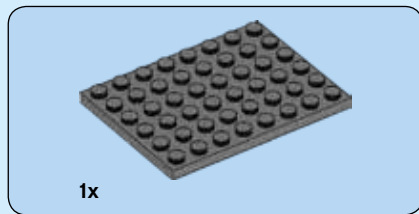
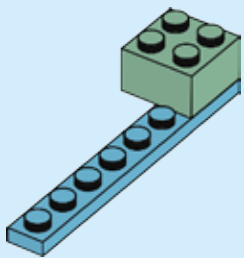

2

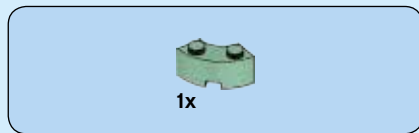
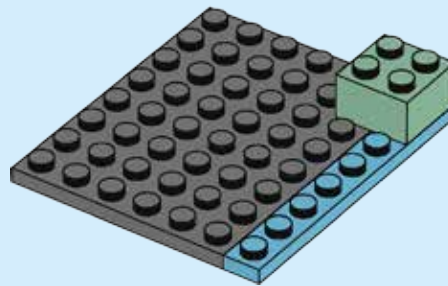

3

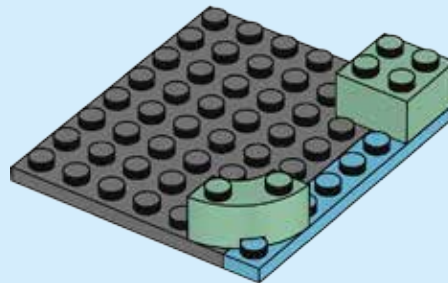

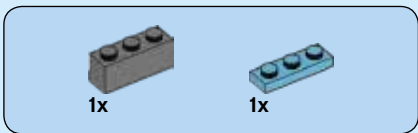

4

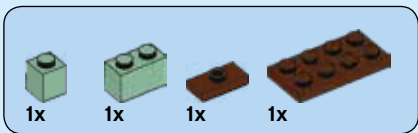
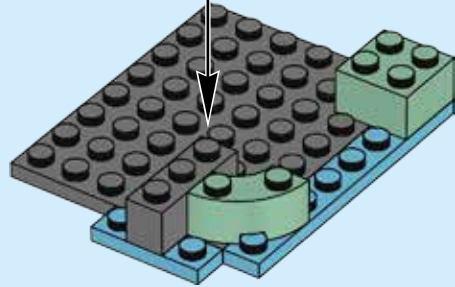
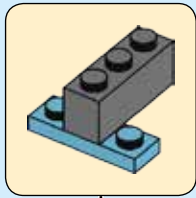

5

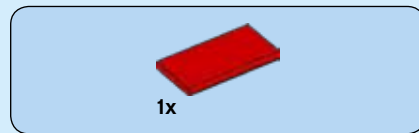
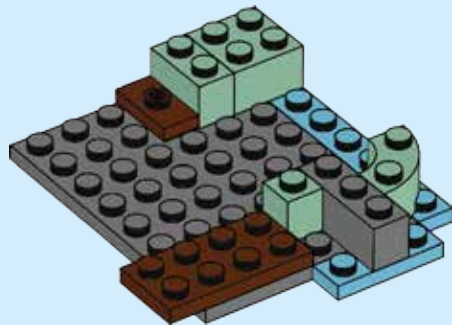
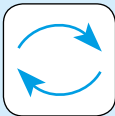

6

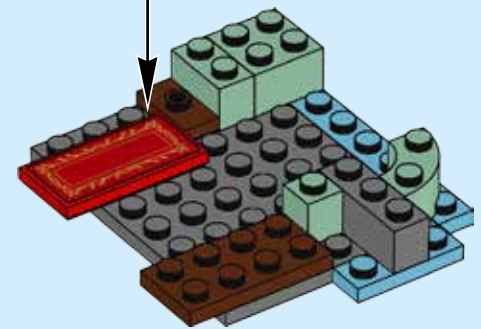
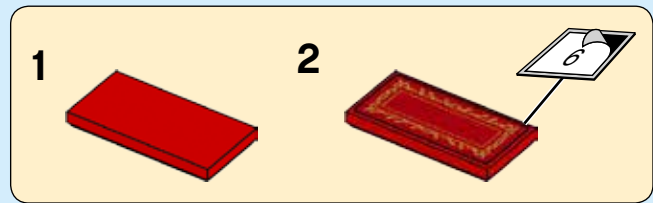

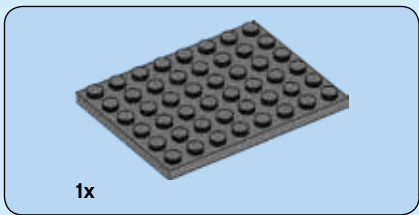

1x

7

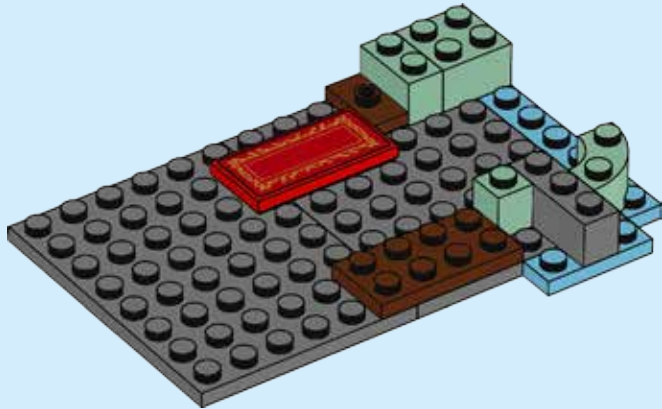

1x

2x

8

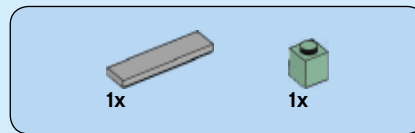
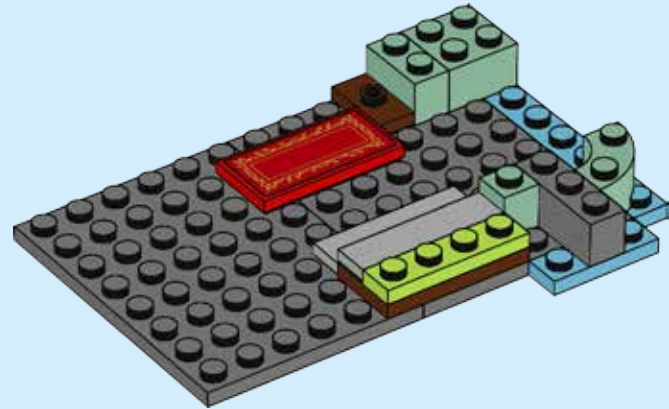

1x

1x

9

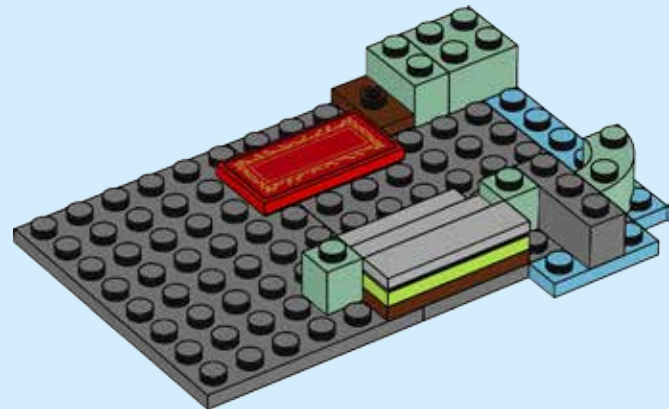

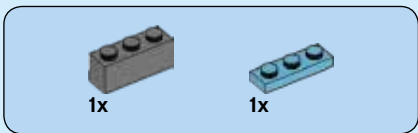

10

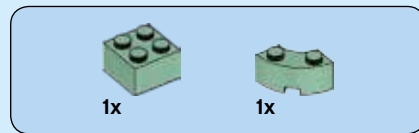
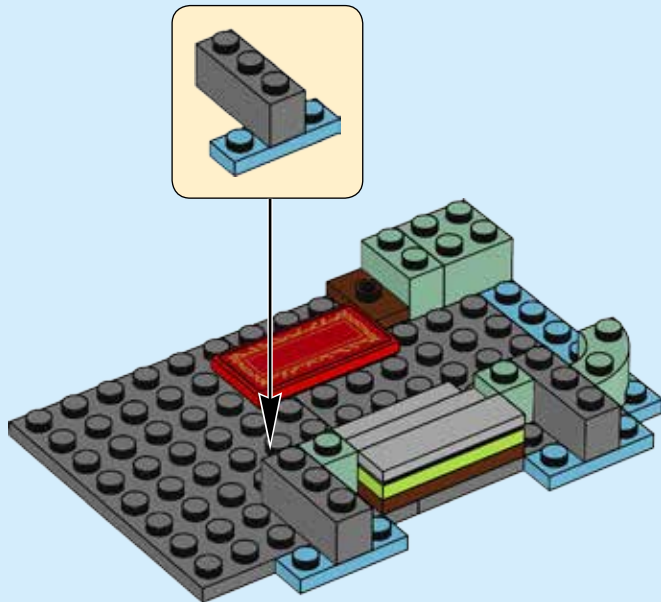

11

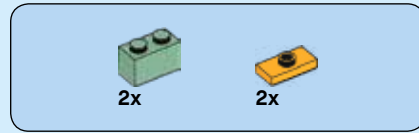
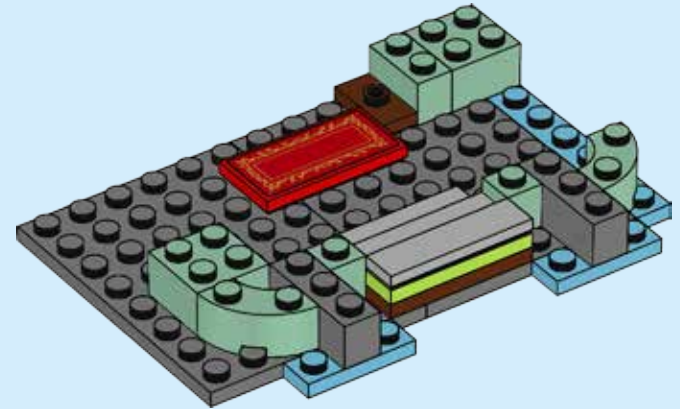

12

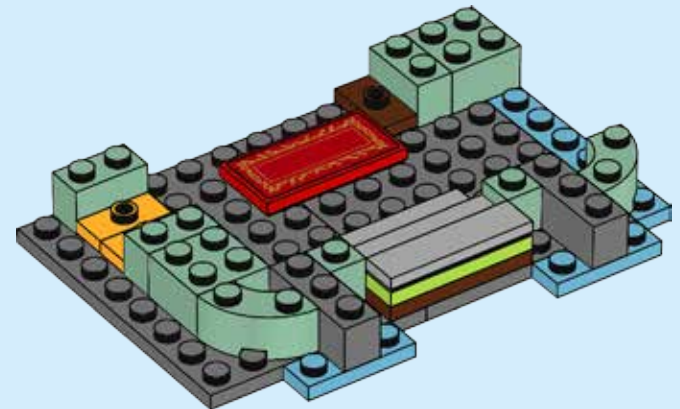



2x



2x

13

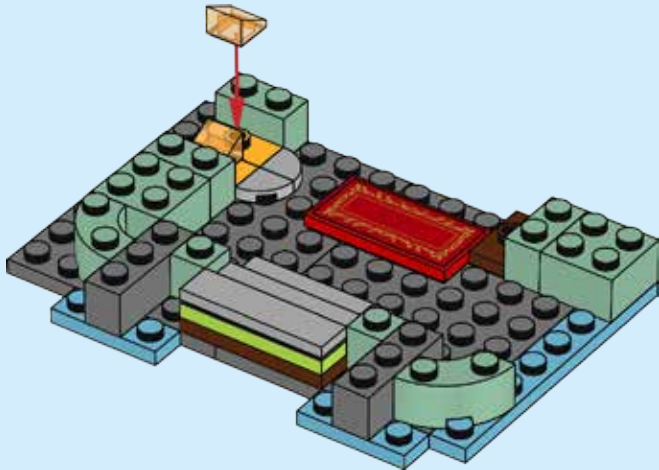

2x



1x

14

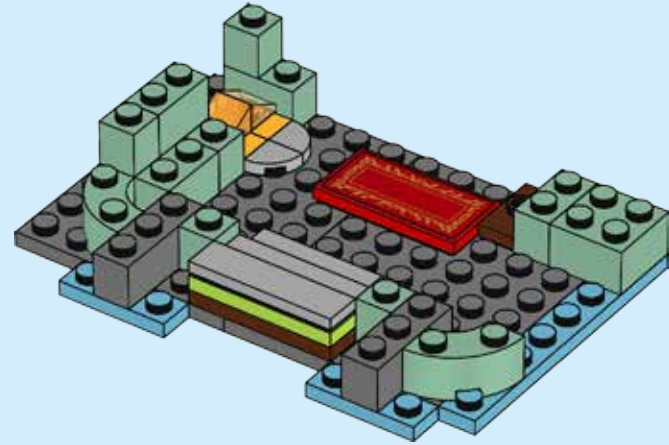

1x



1x

15

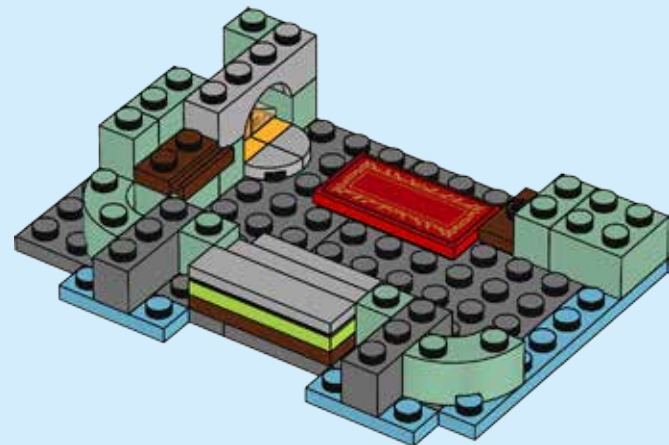

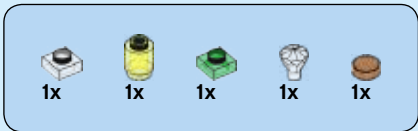

16

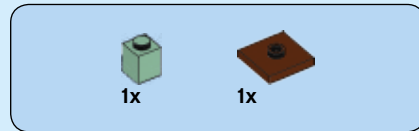
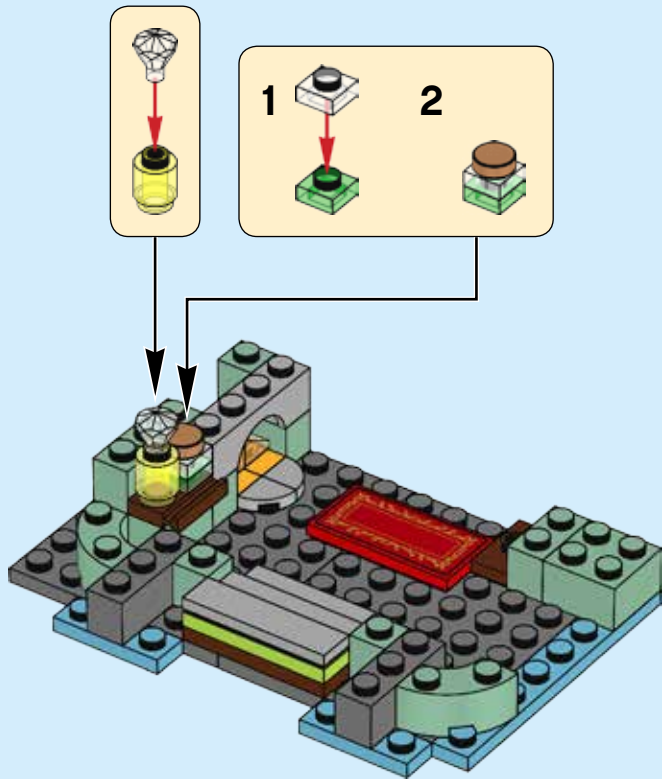

17

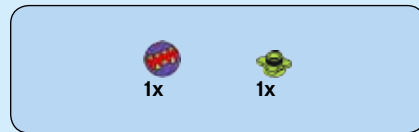
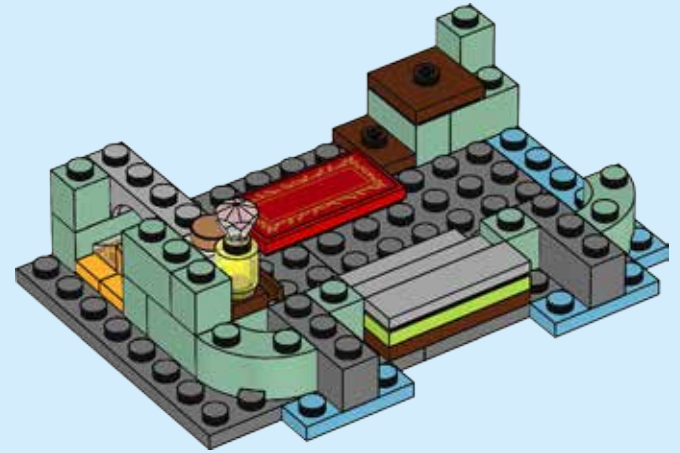
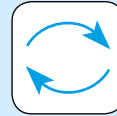

18

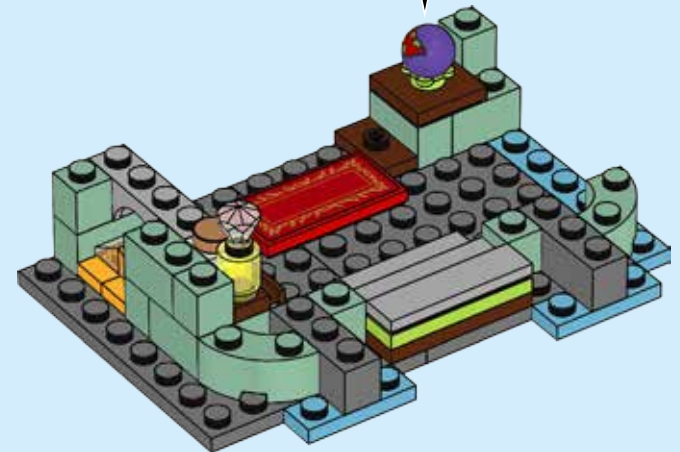



2x



2x

19

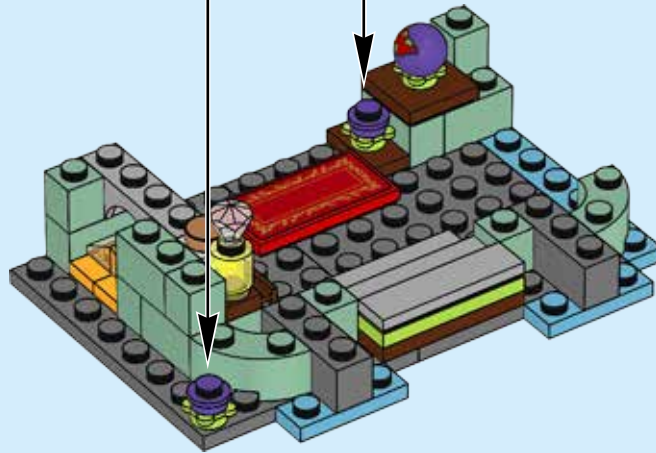
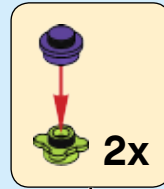

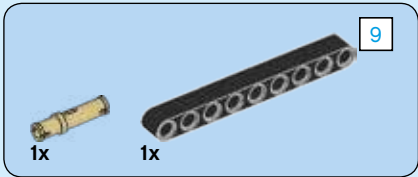
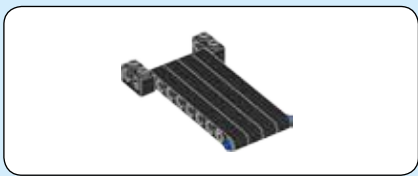

20

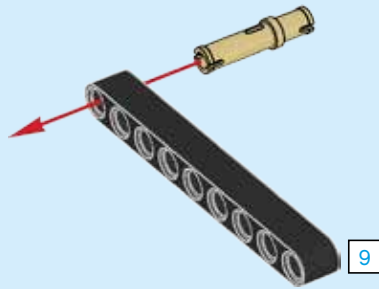

21

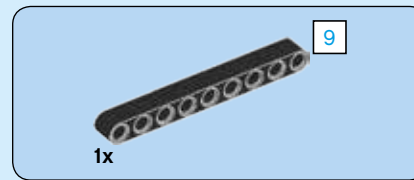
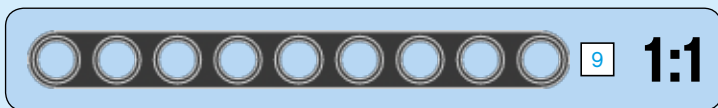
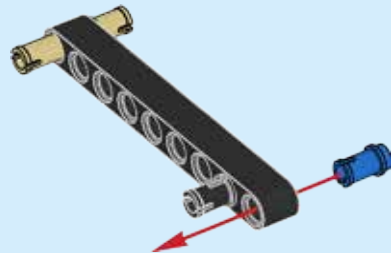

22

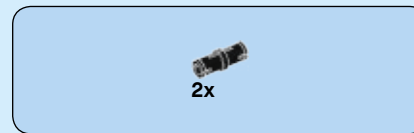
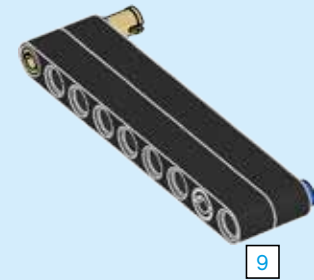

23

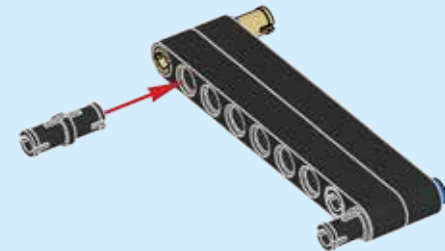

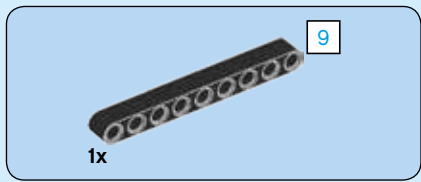

24

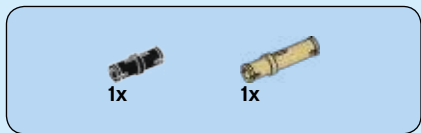
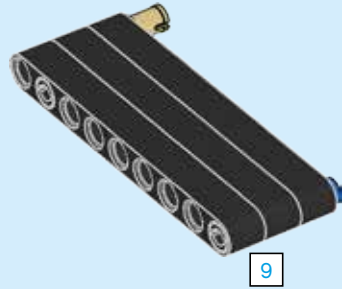

25

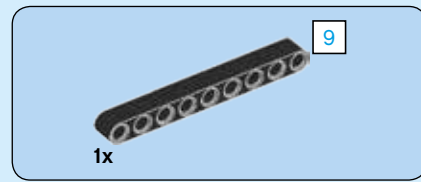
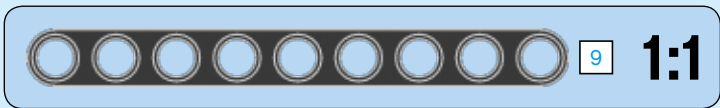
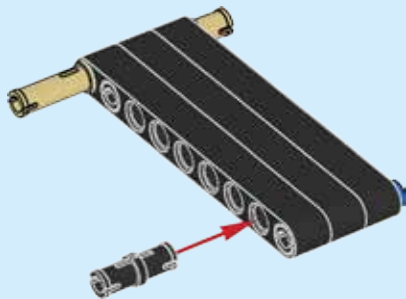

26

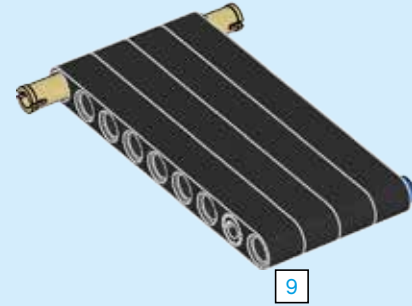

27

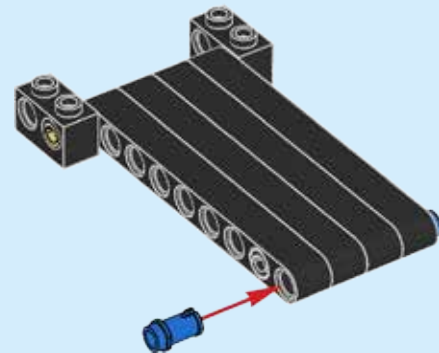

28

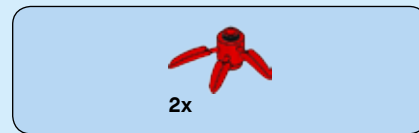
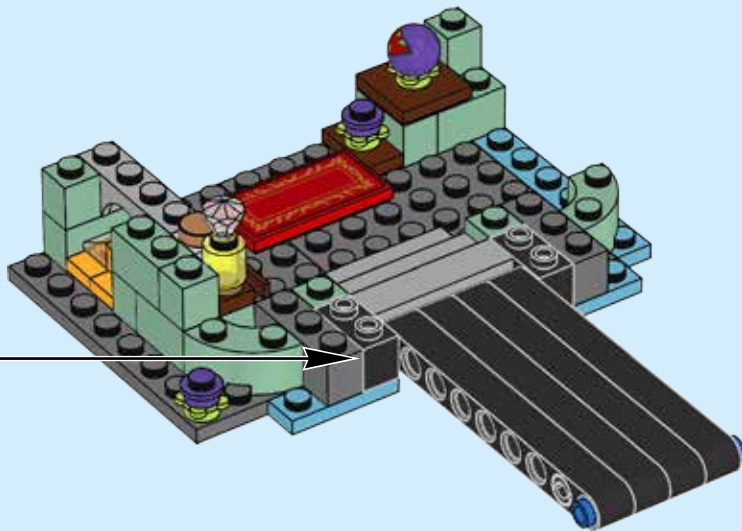

29

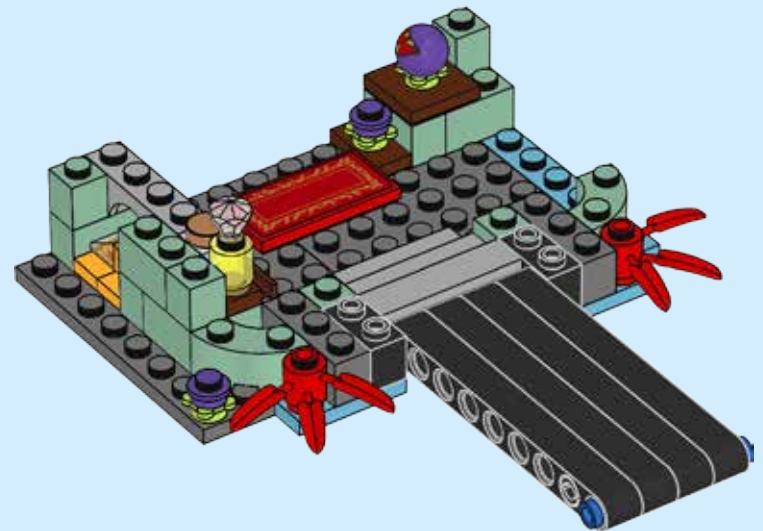

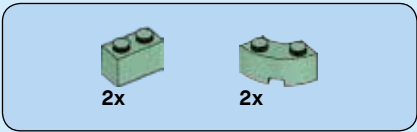

30

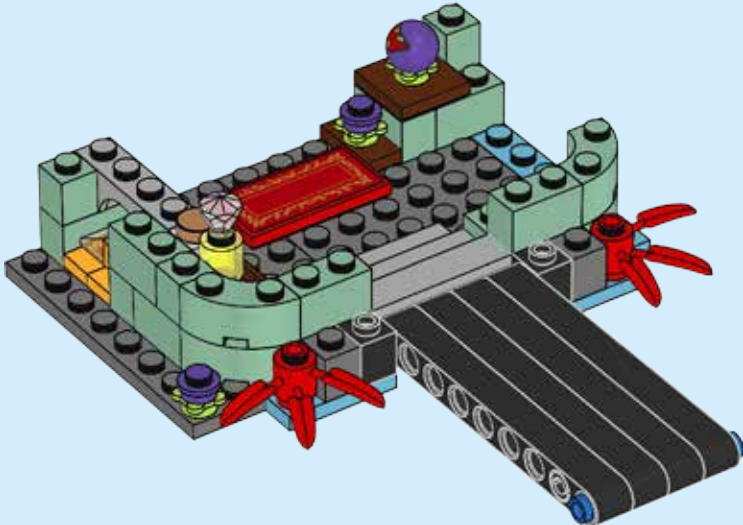

31

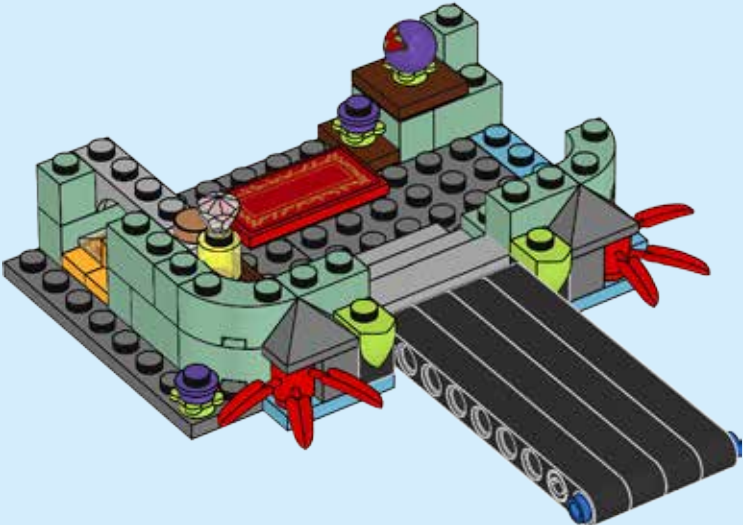

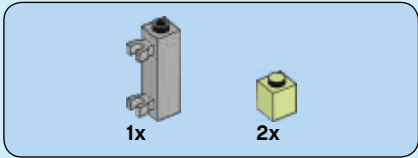
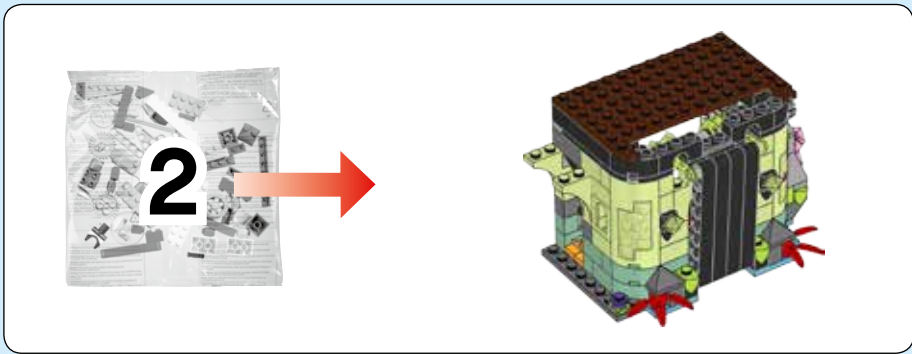

32

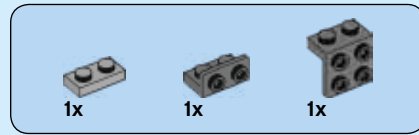
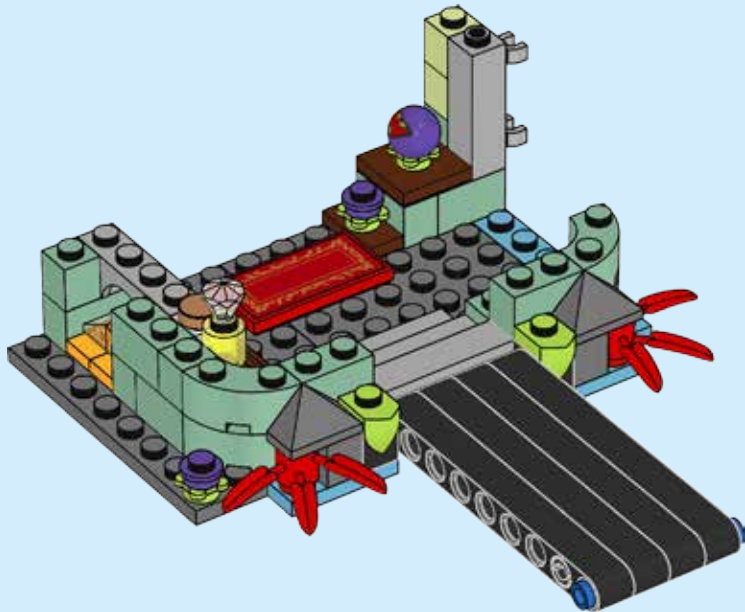
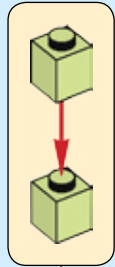

33

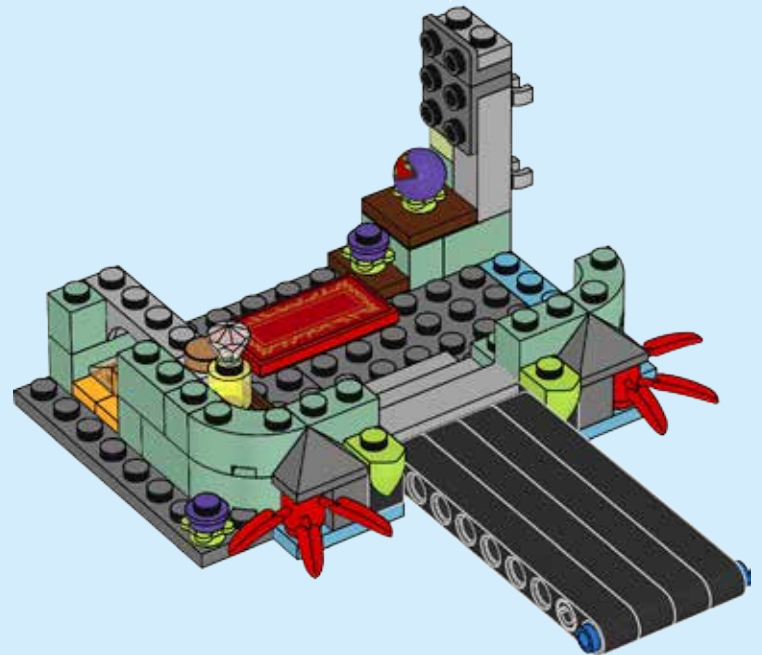
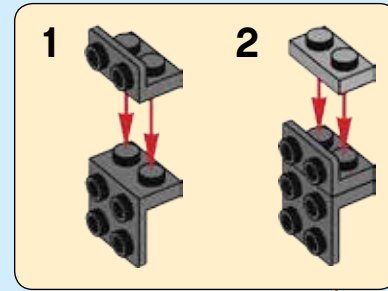



34

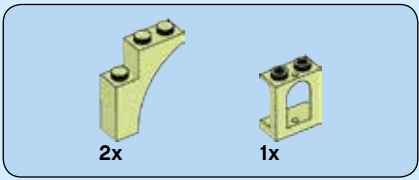
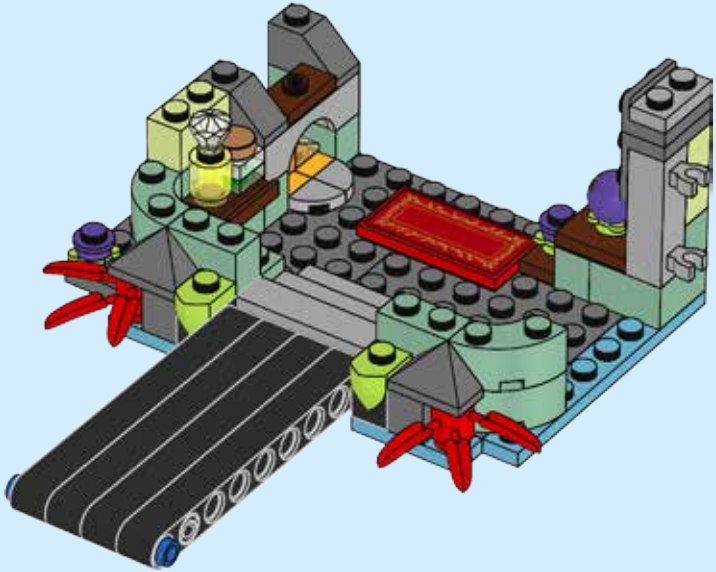
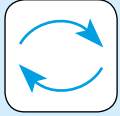

35

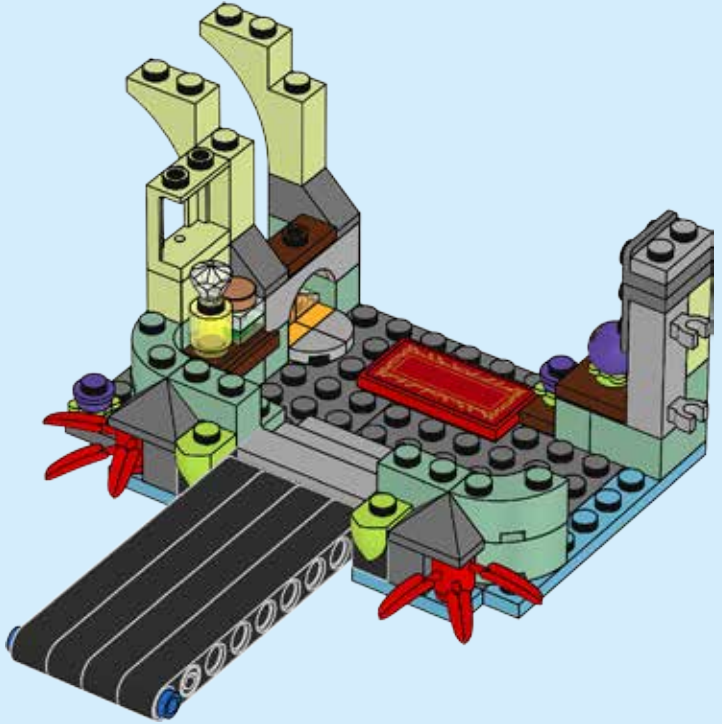

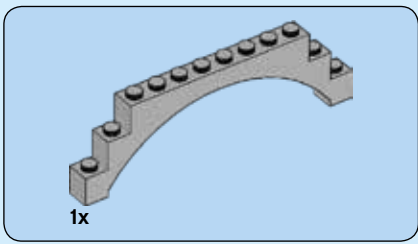

36

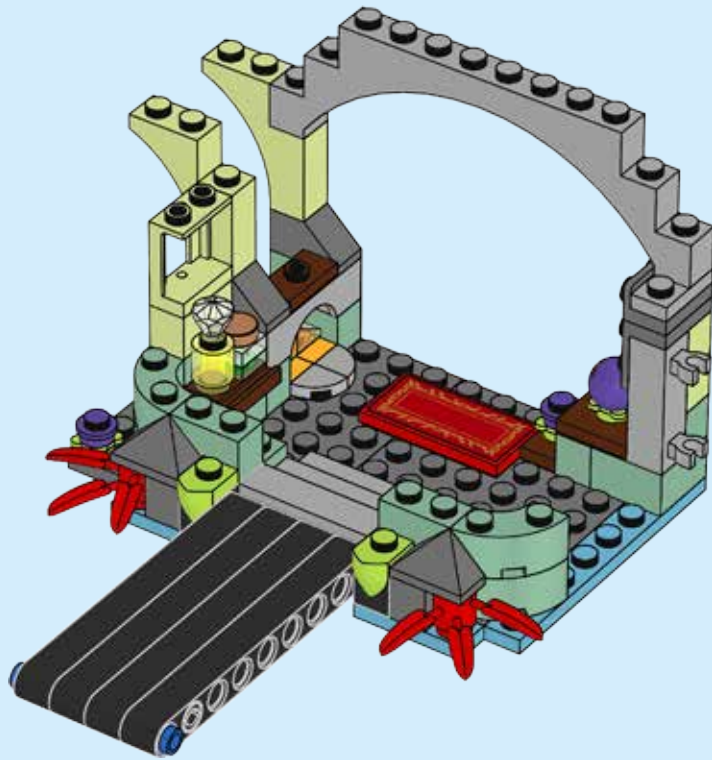

37

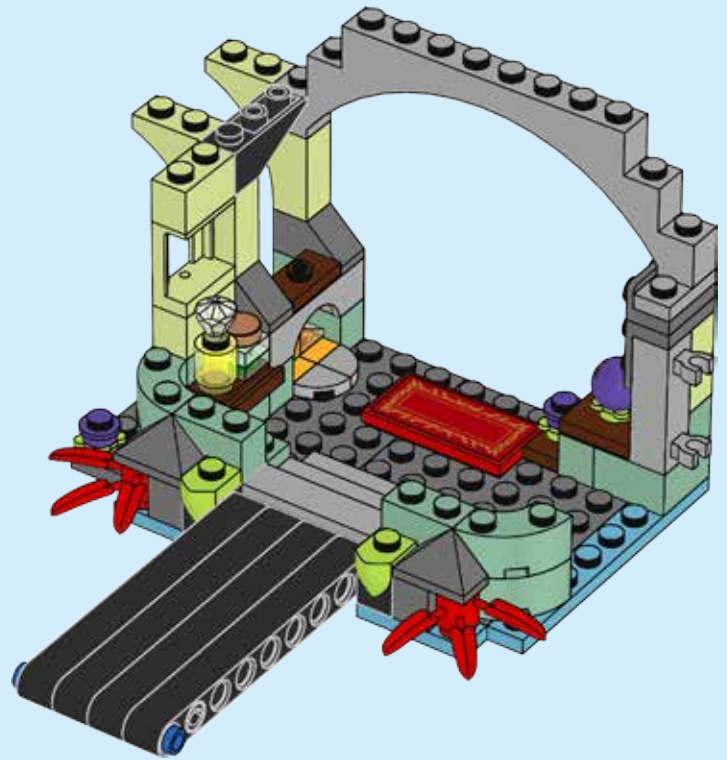

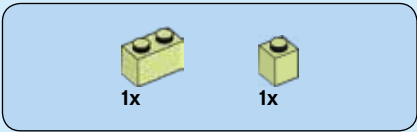

38

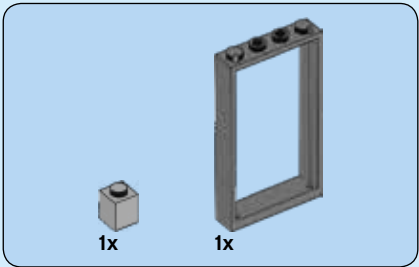
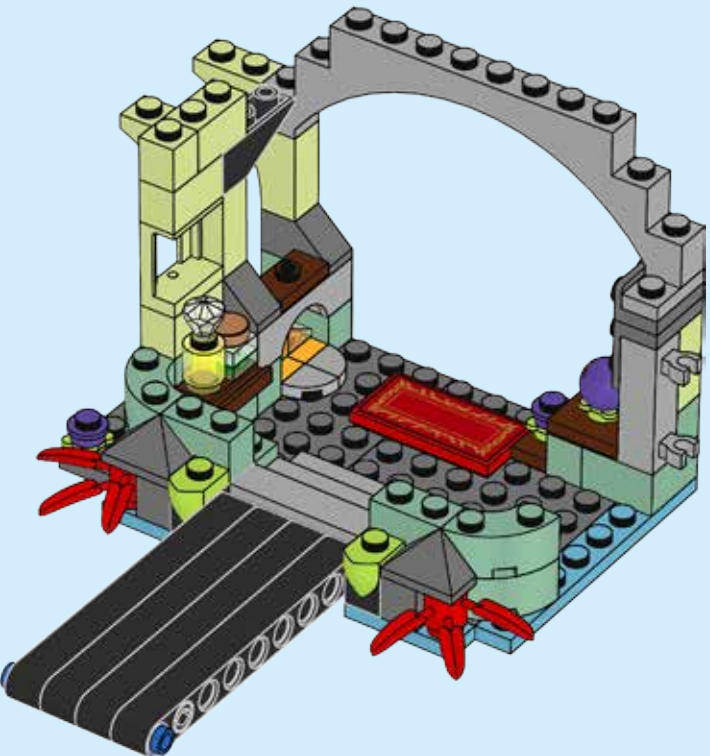

39

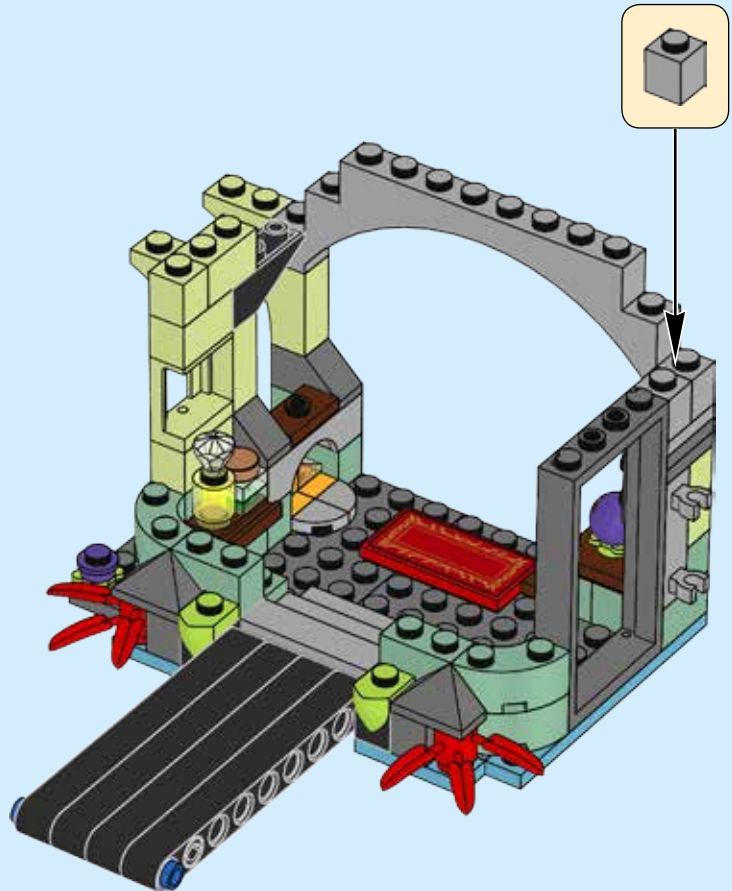

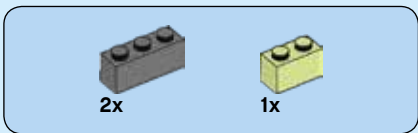

40

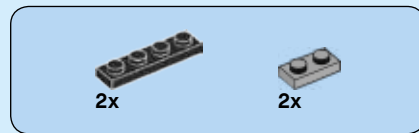
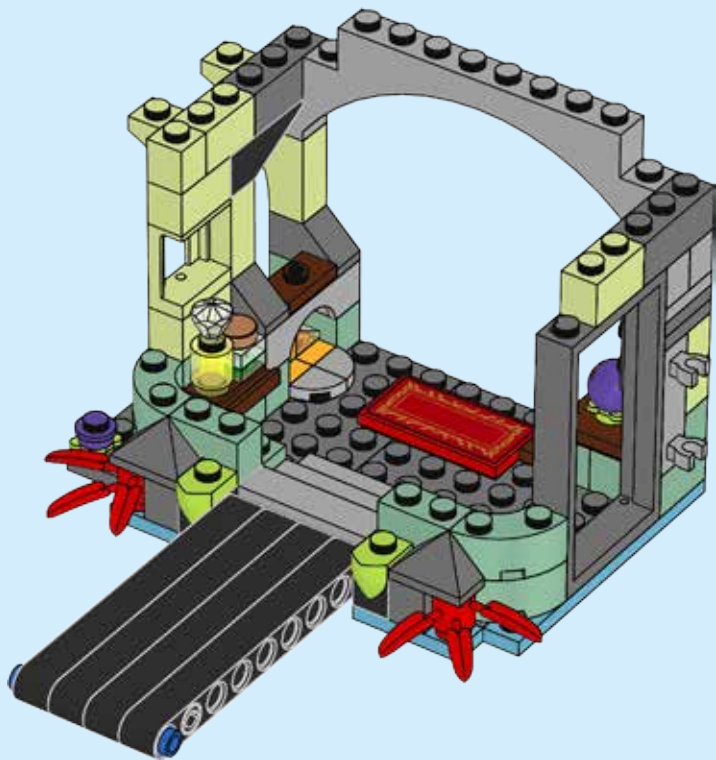

41

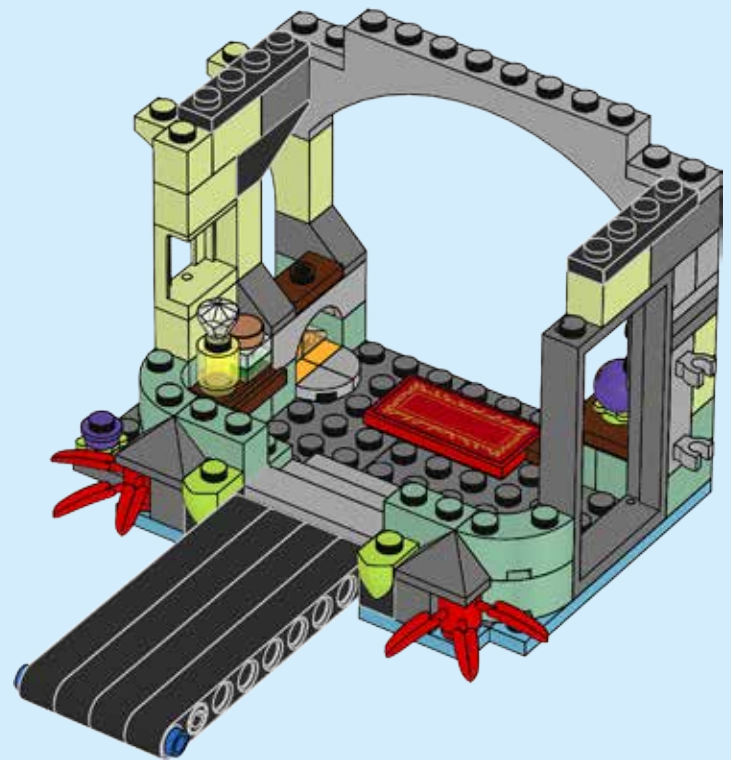

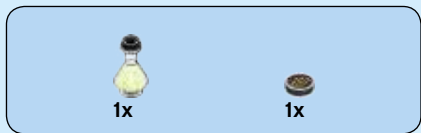

42

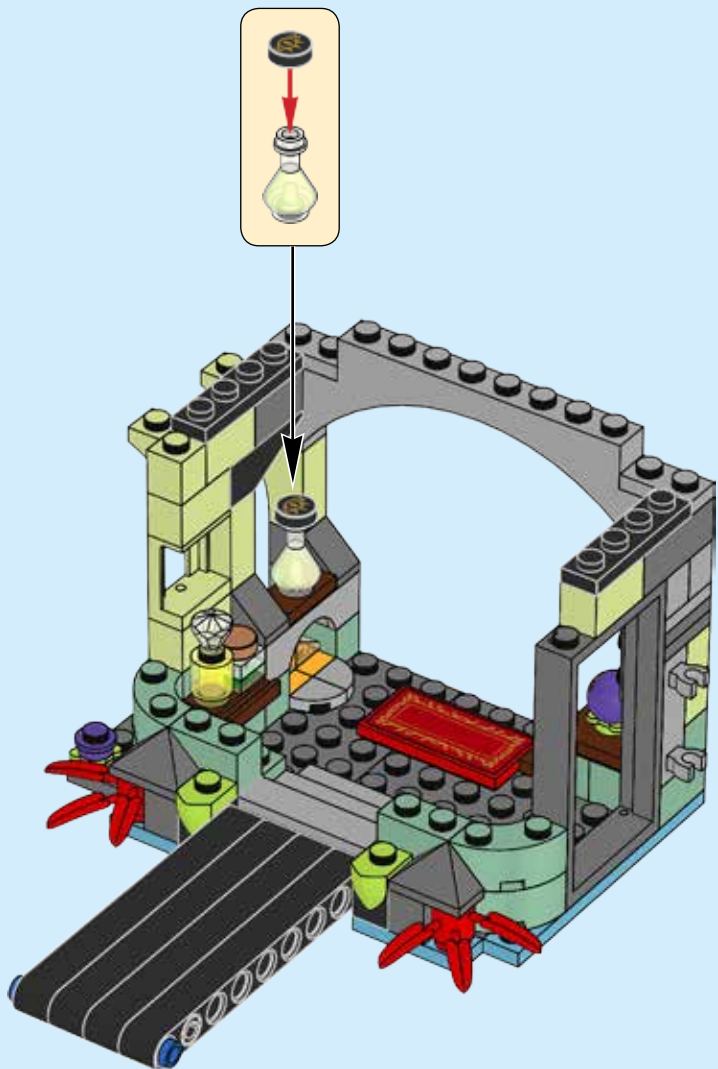

43

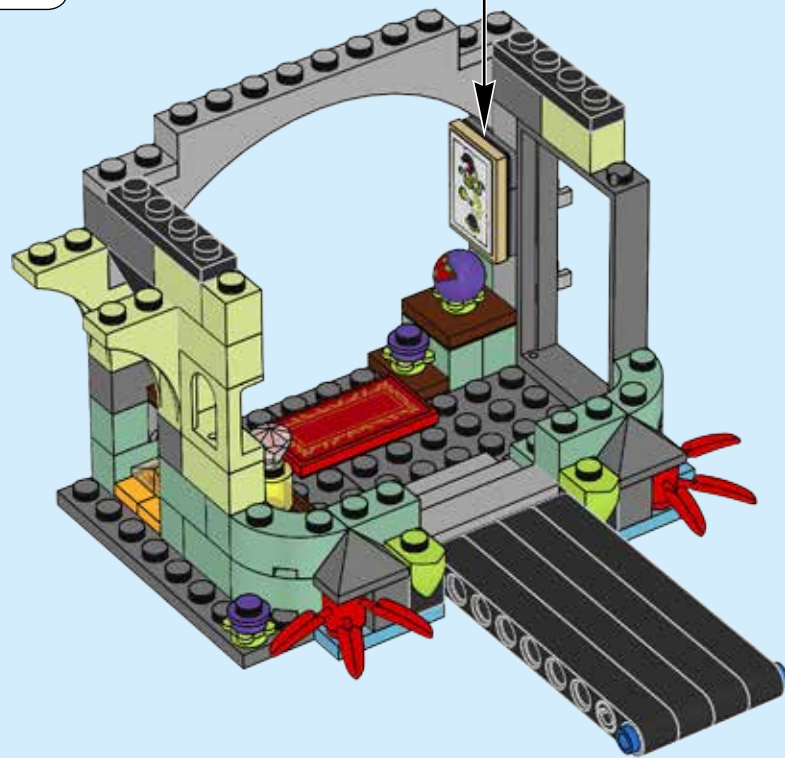
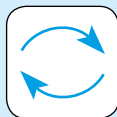
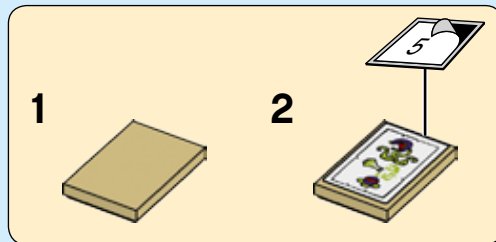



44

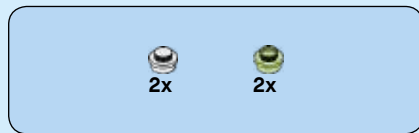
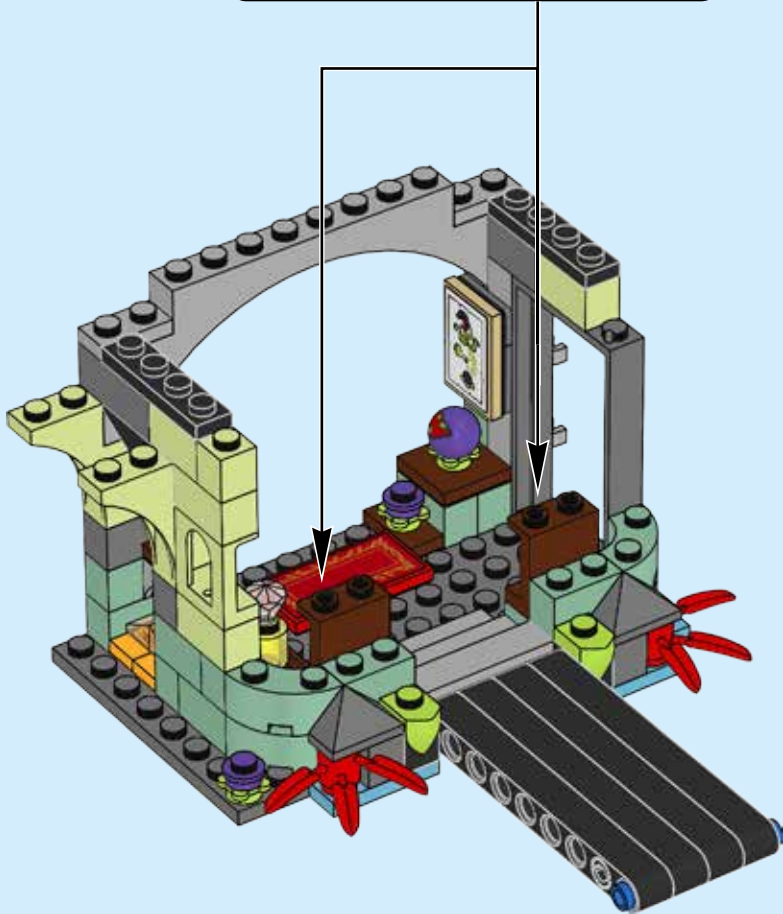

45

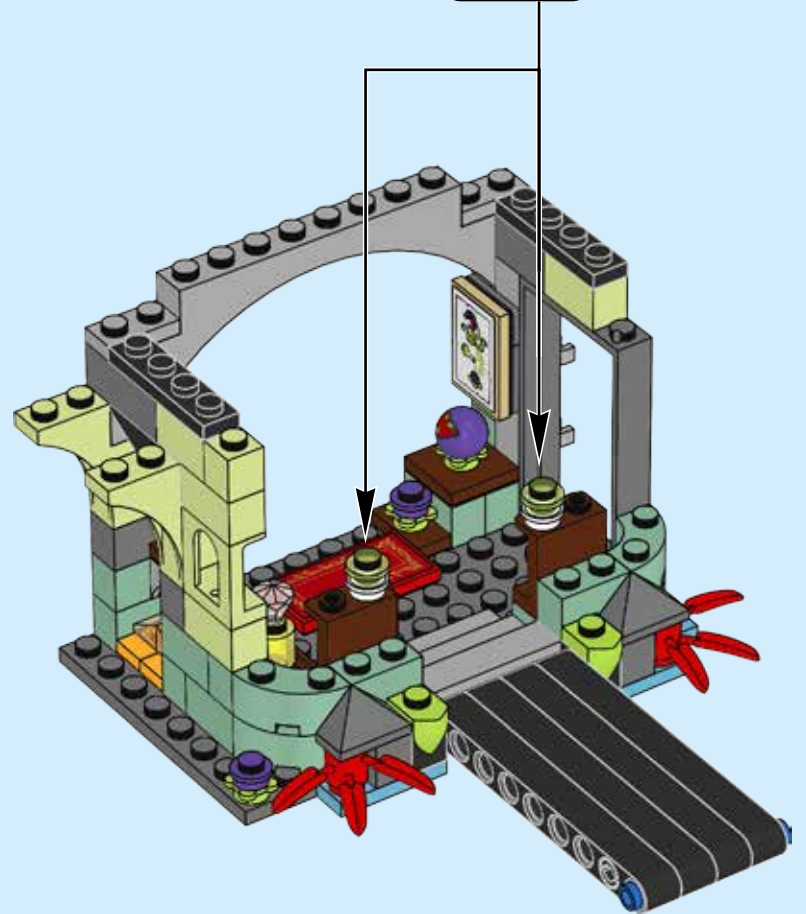
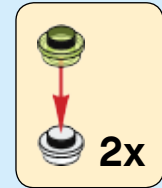



46

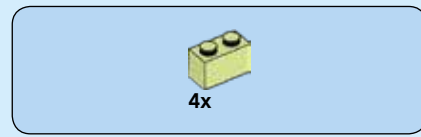
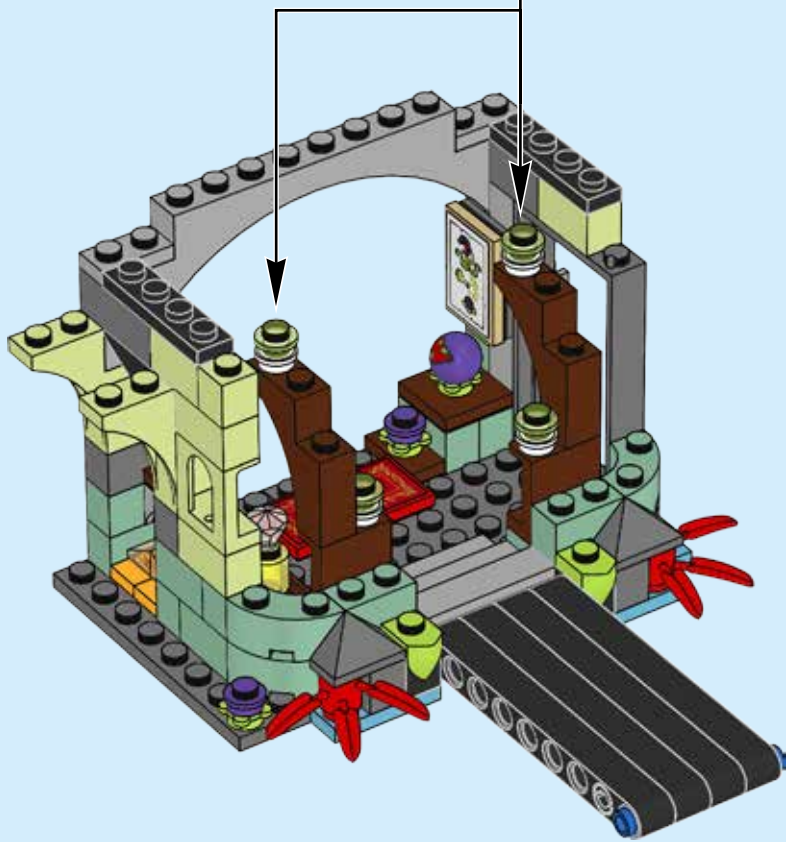
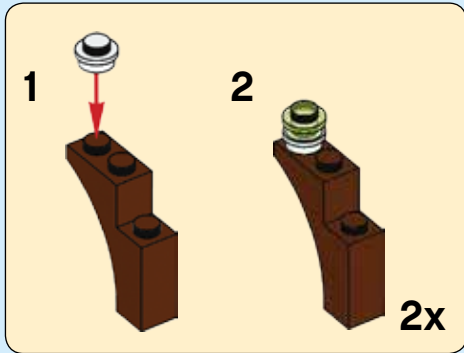

47

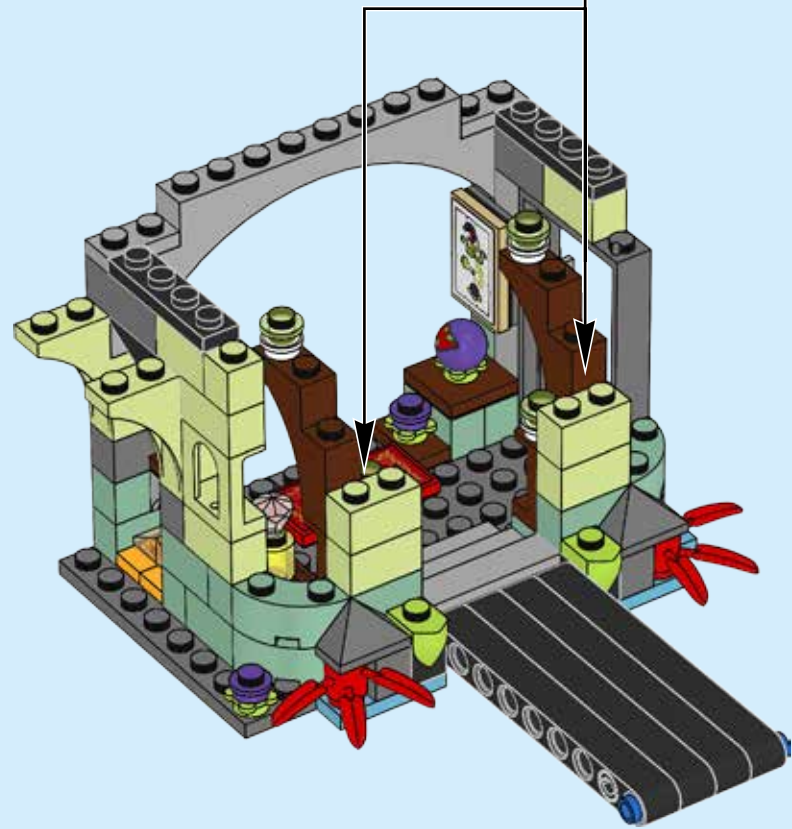
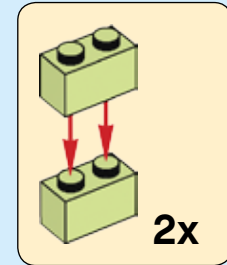



2x

48

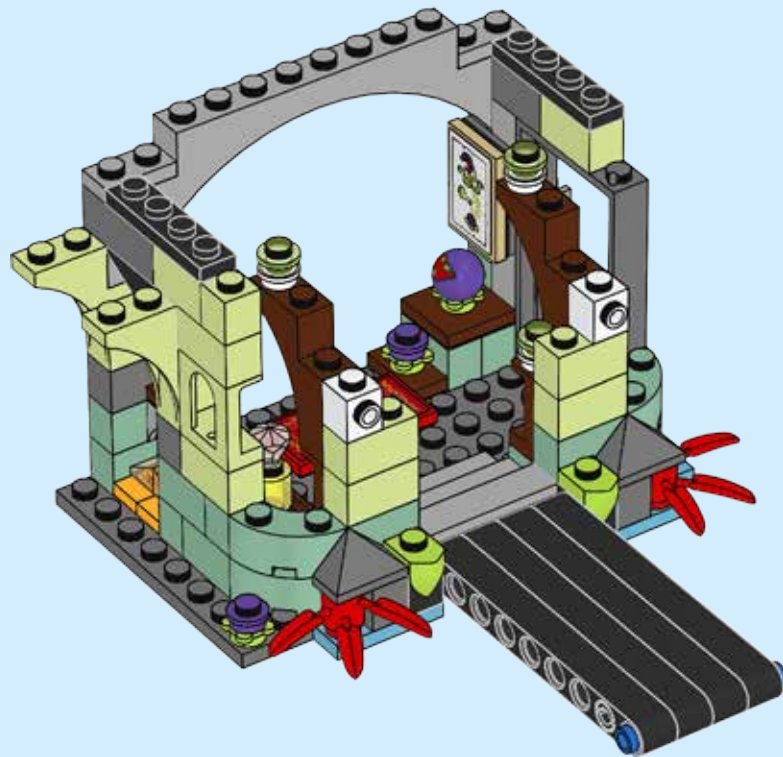

2x

49

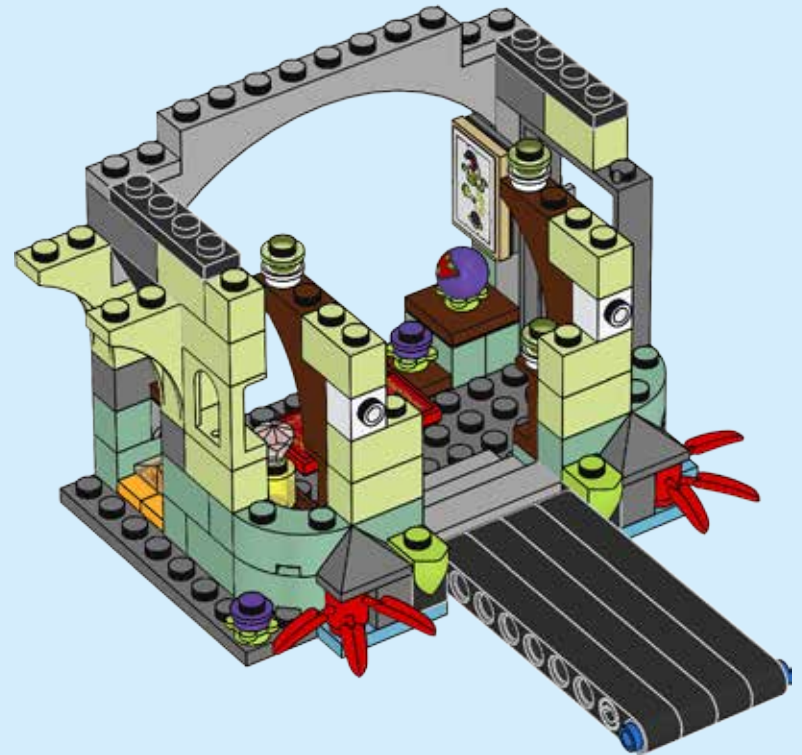

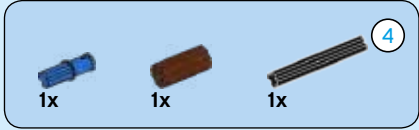

50

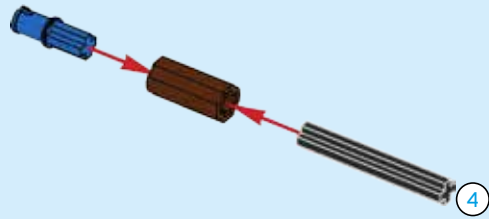

51

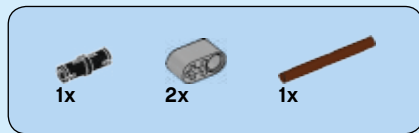
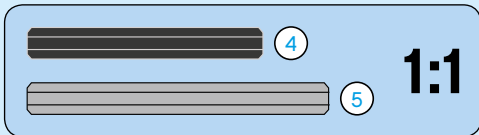

52

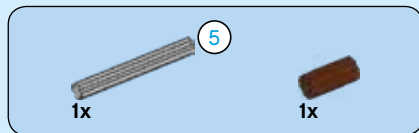
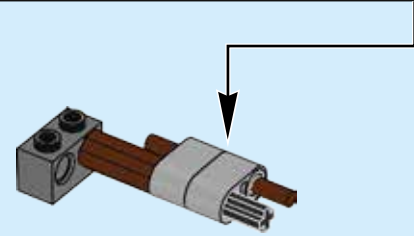
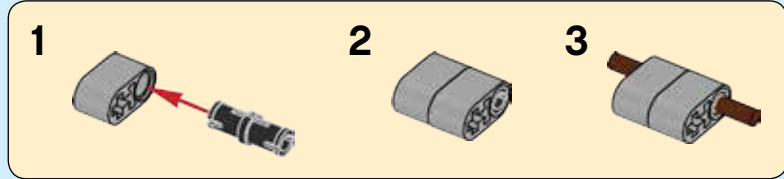

53

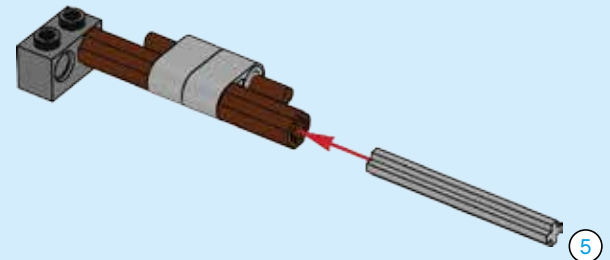



54

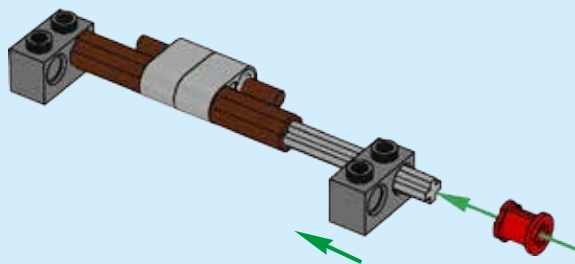

55

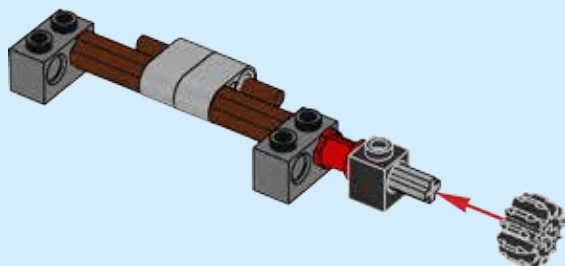

56

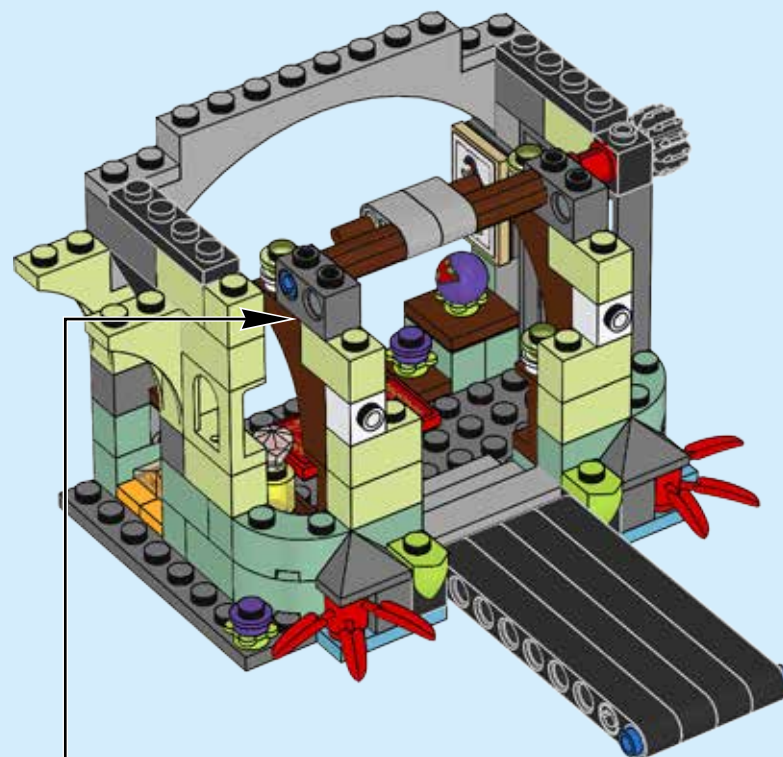

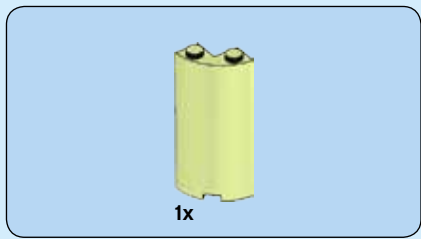

57

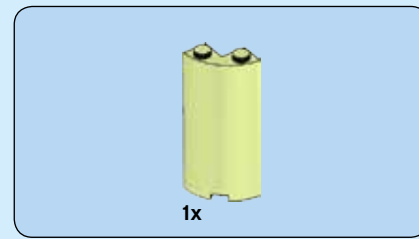
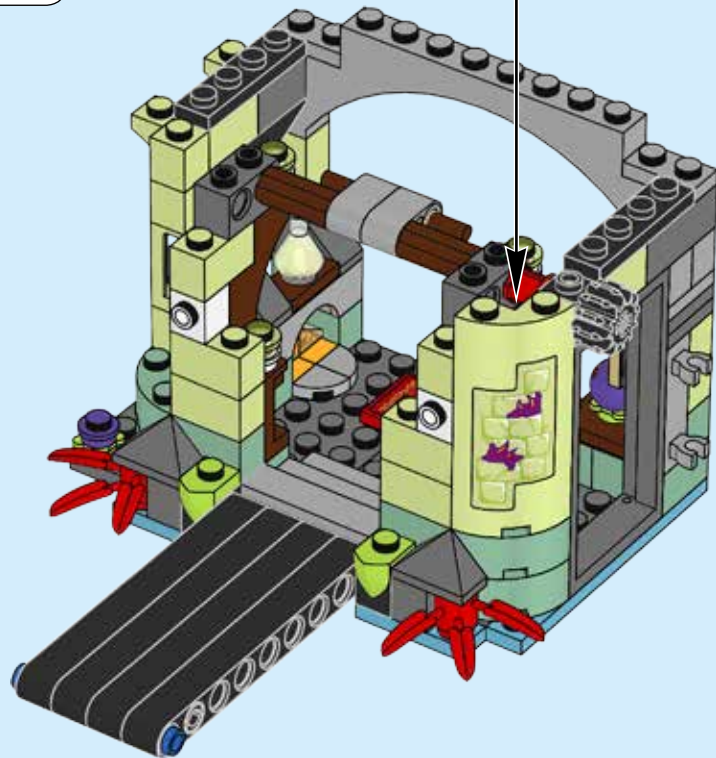
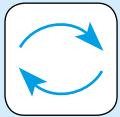
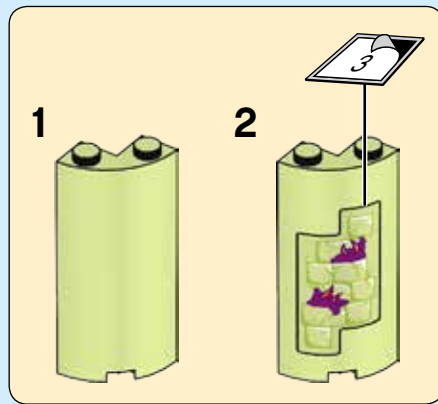

58

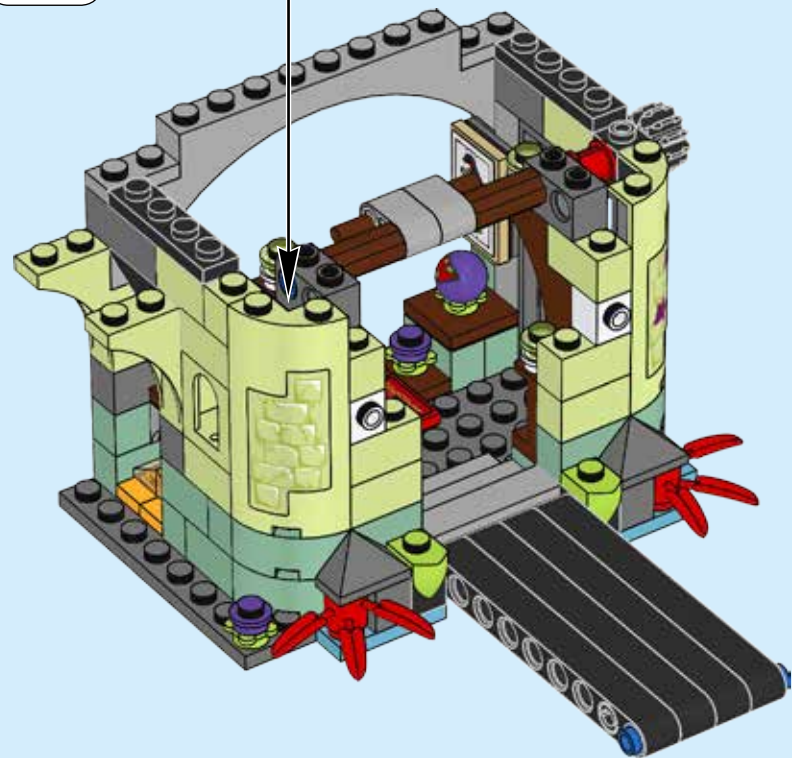
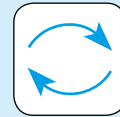
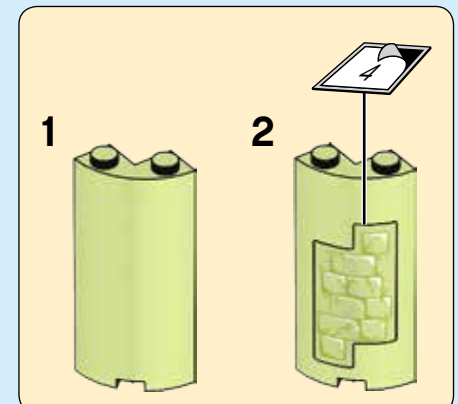

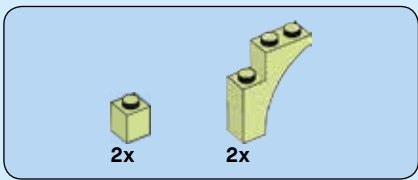

59

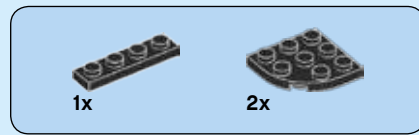
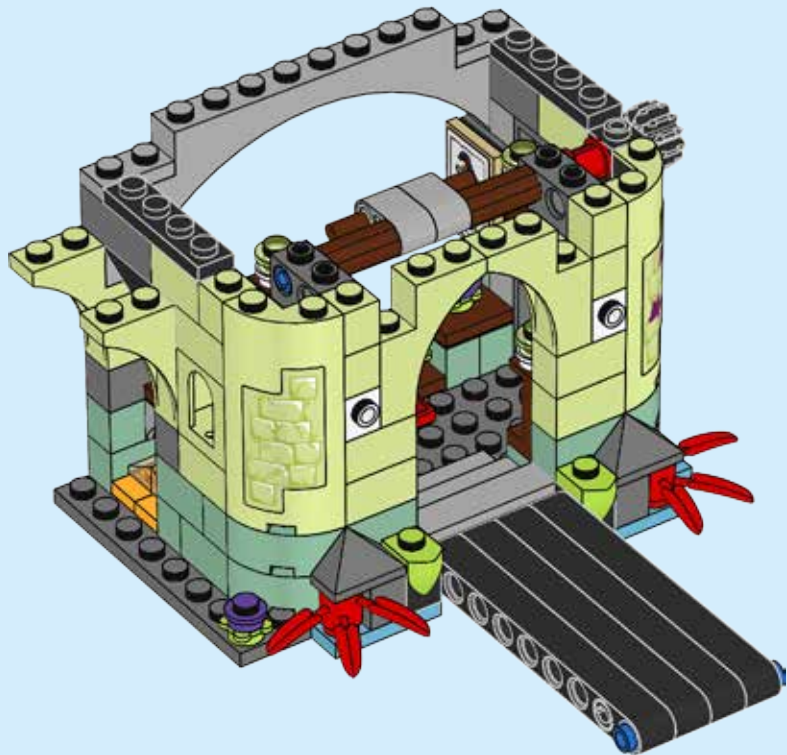

60

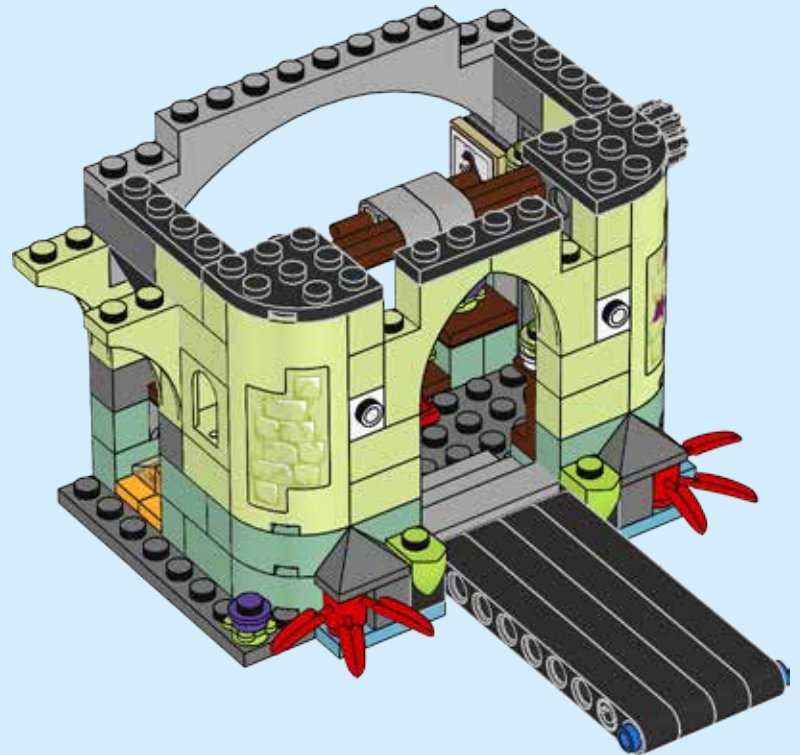



2x



2x

61

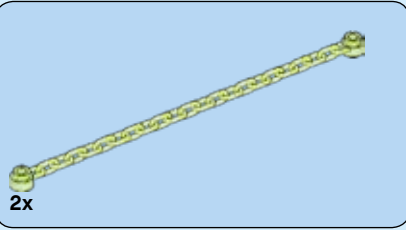
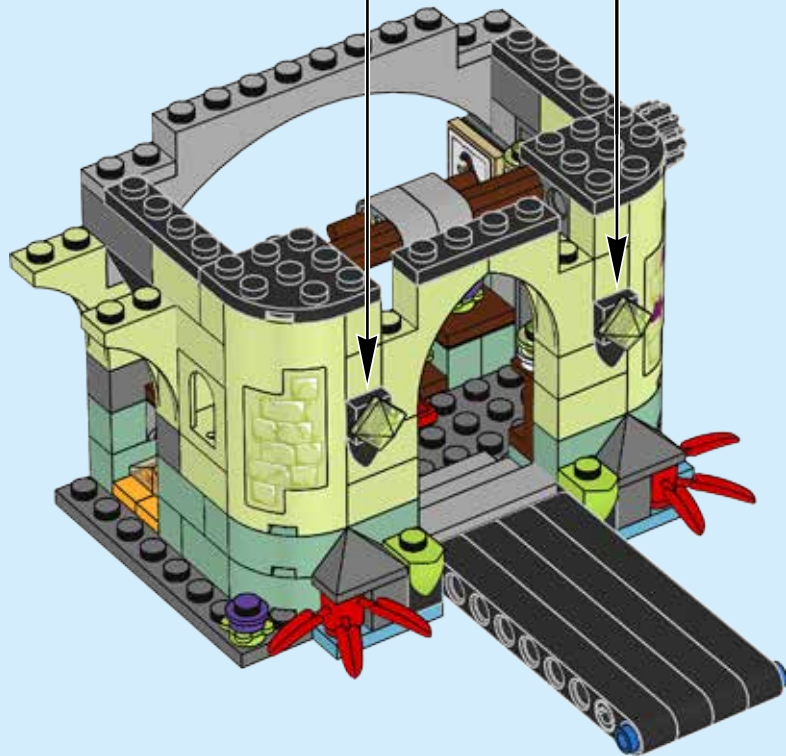
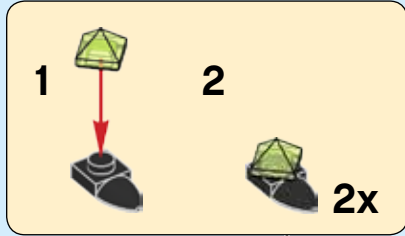

62

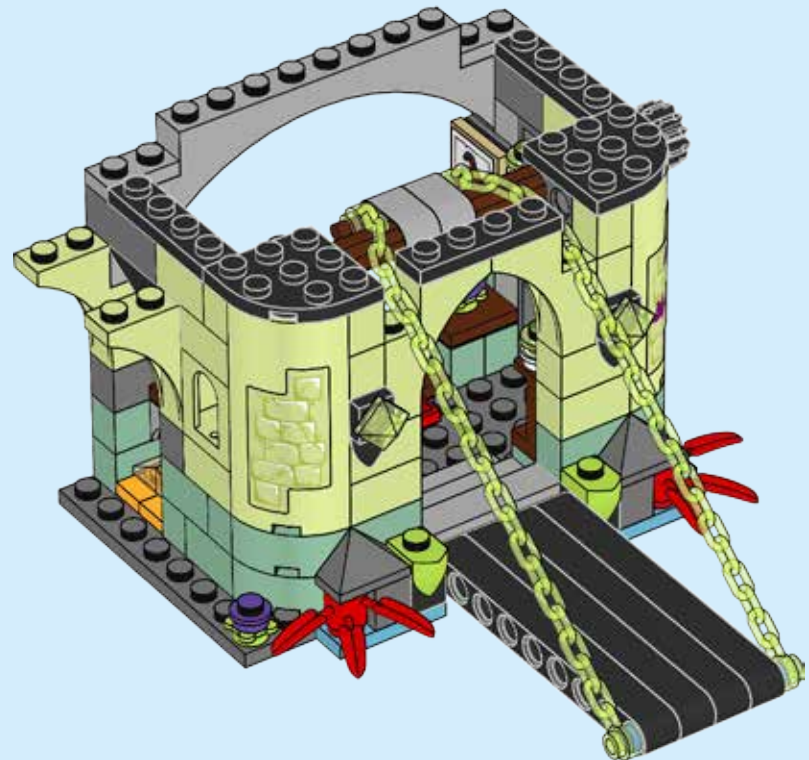

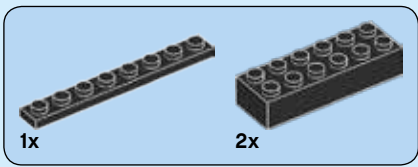

63

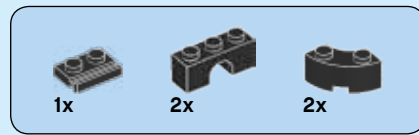
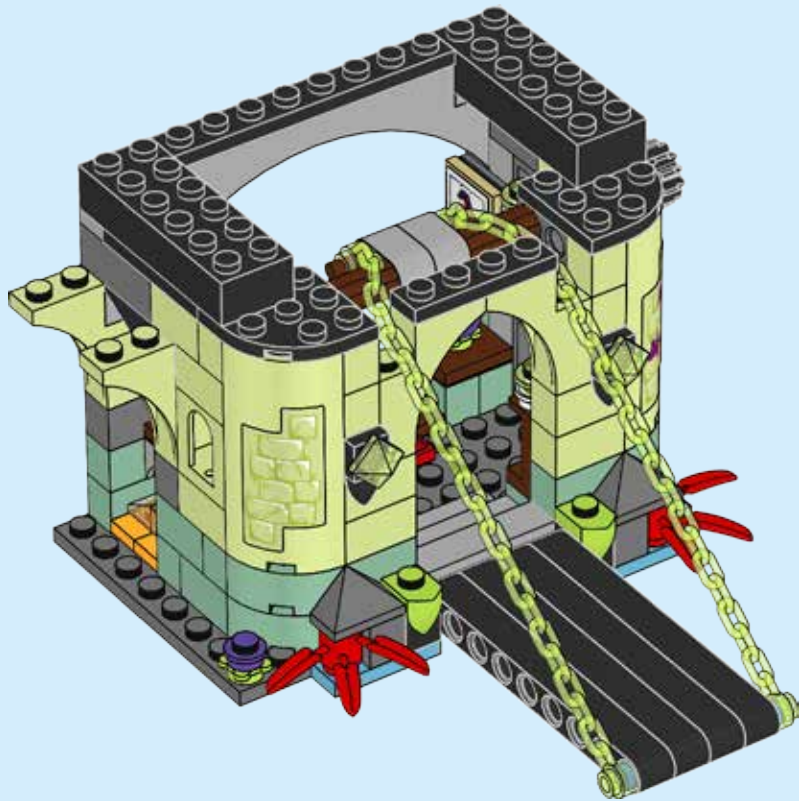

64

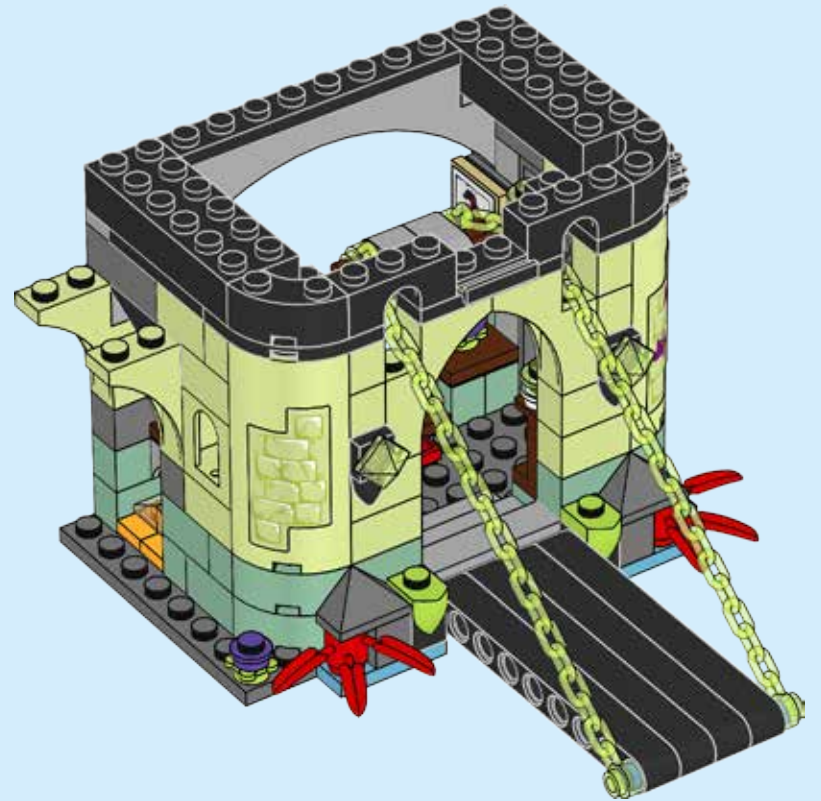

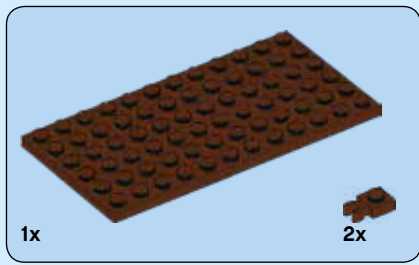

65

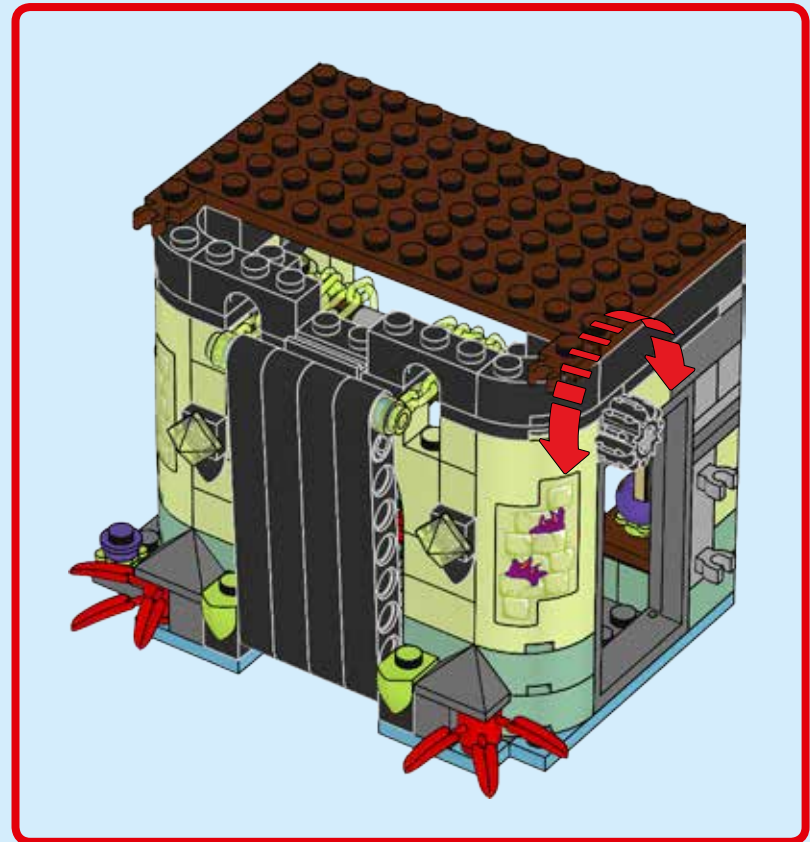
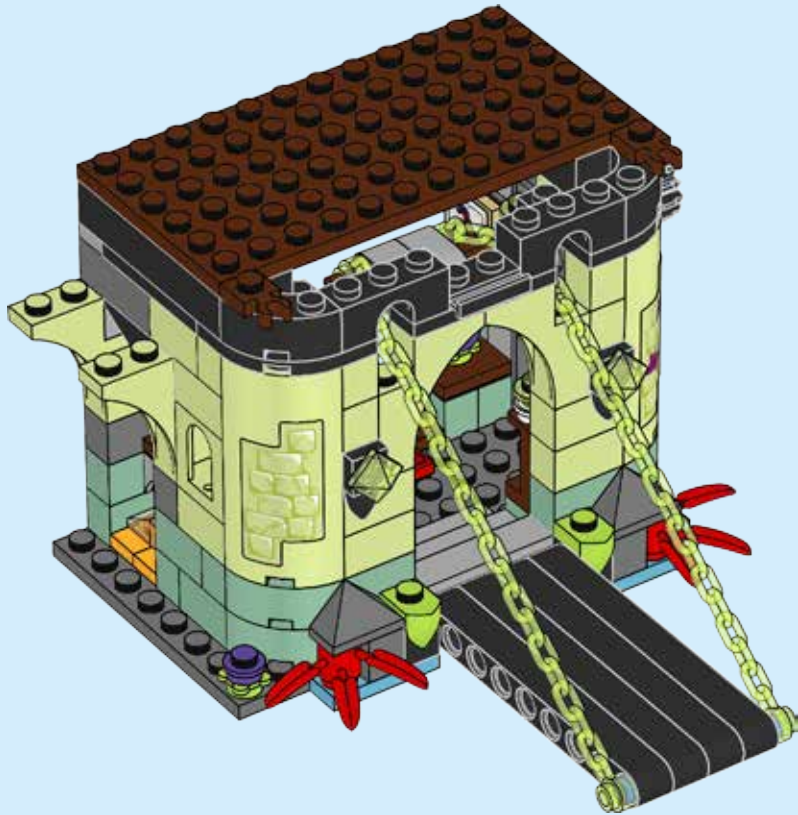

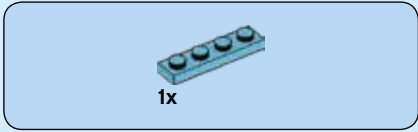
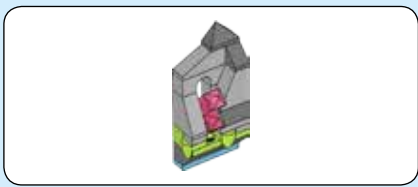

66

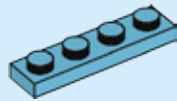

67

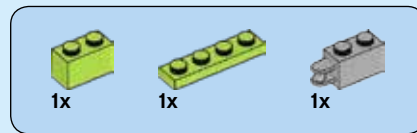
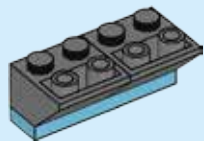

68

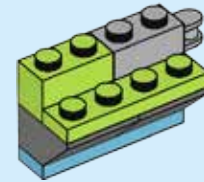

69

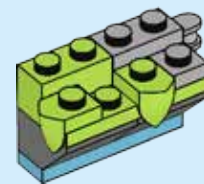

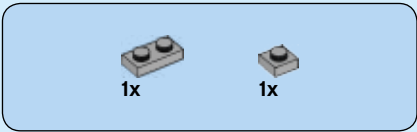

70

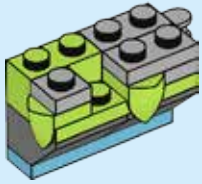

71

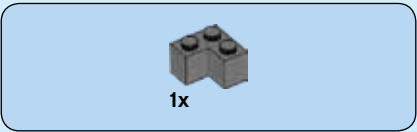
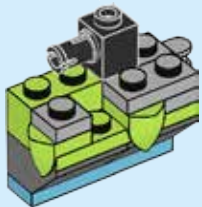
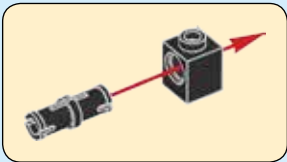

72

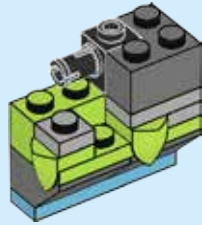

73

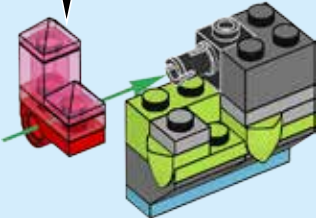
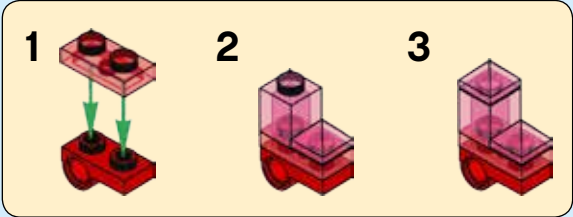

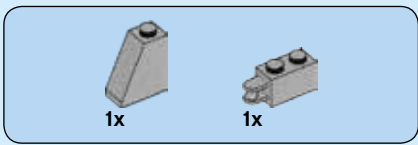

74

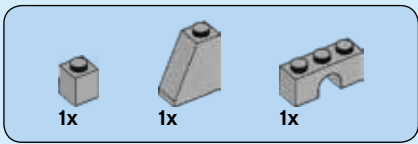
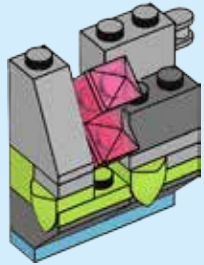

75

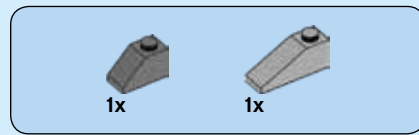
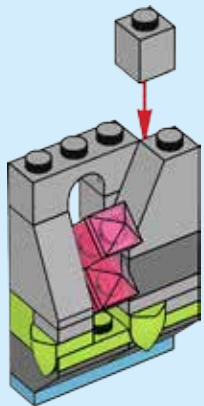

76

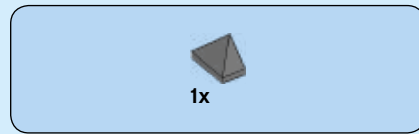
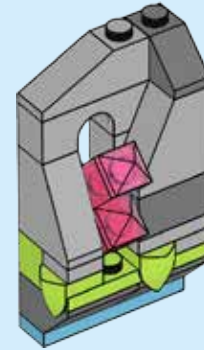

77

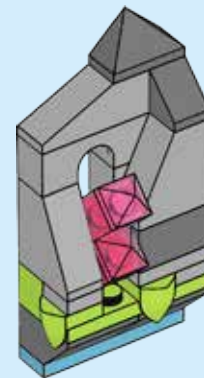

78

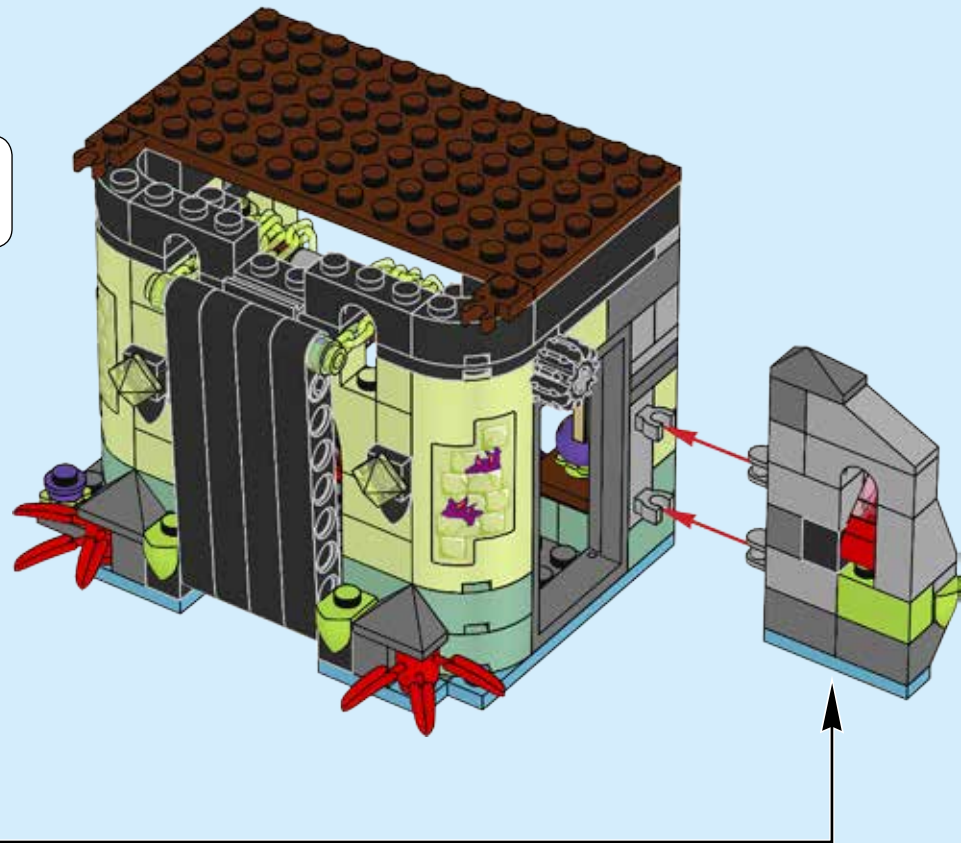
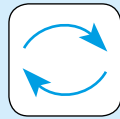

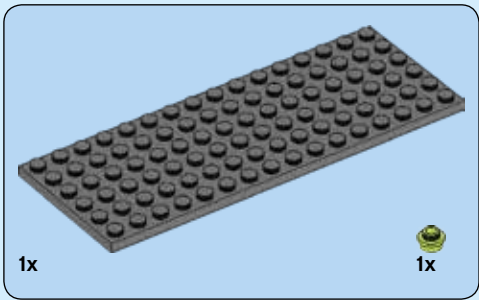
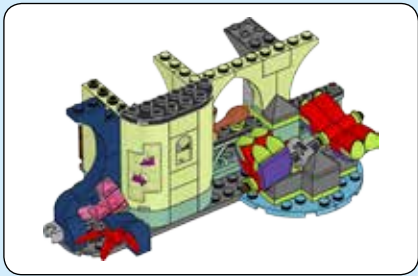
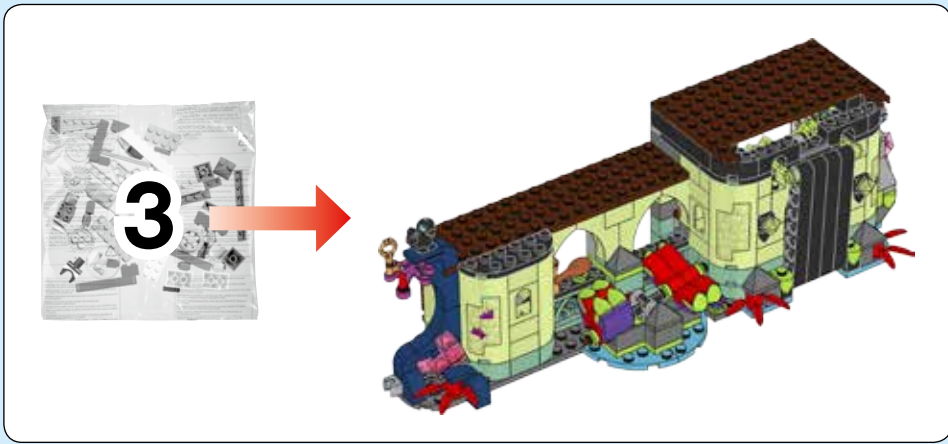

79

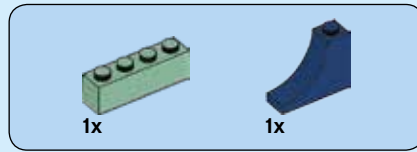
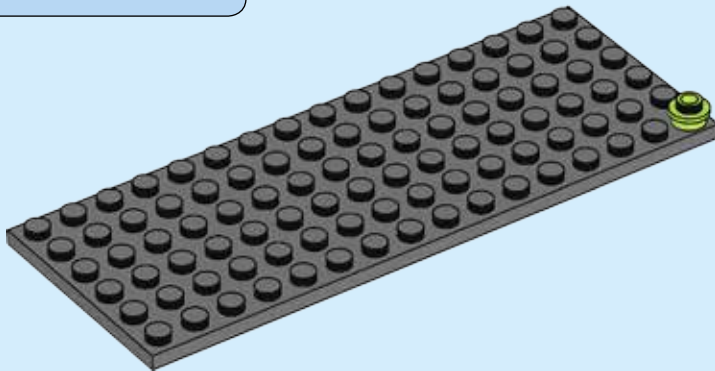

80

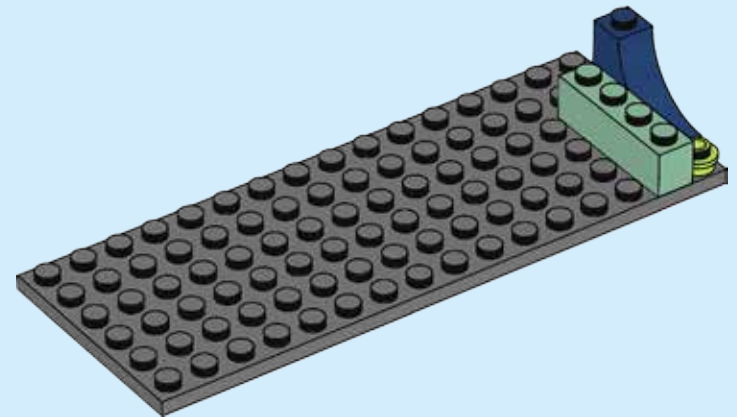

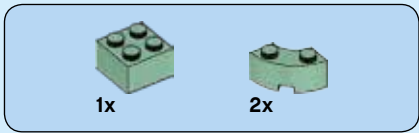

81

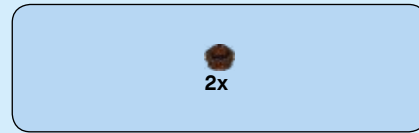
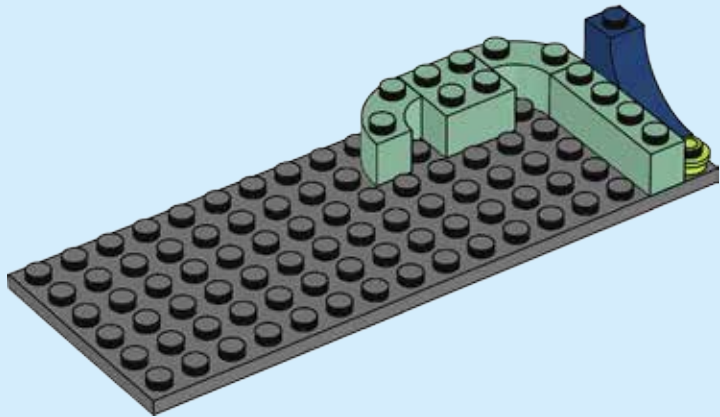

82

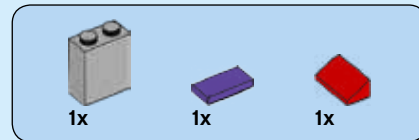
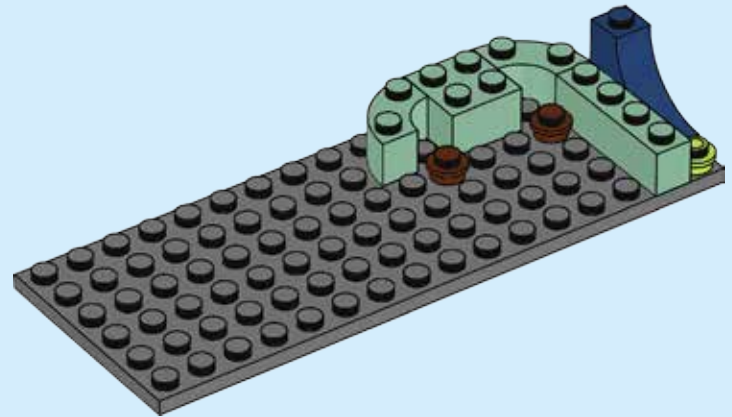

83

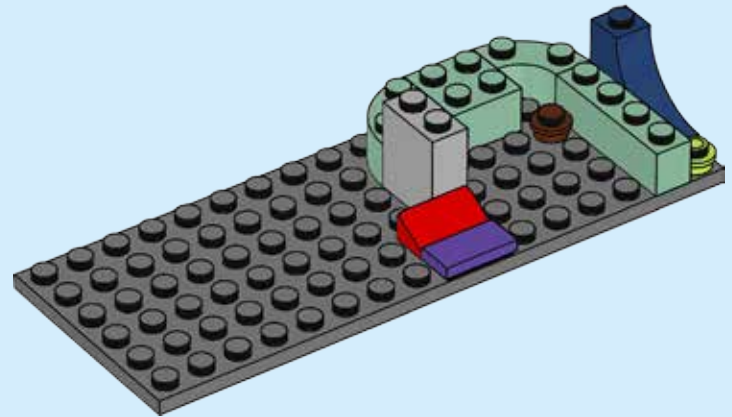

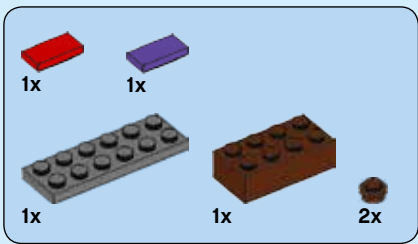

84

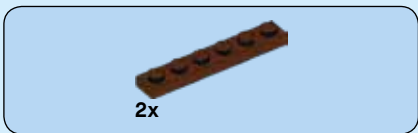
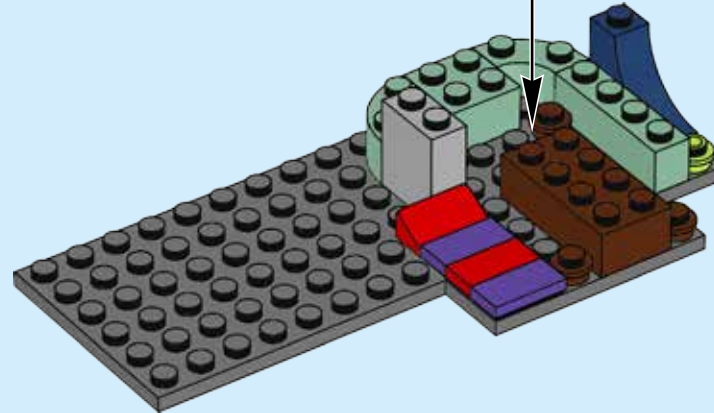
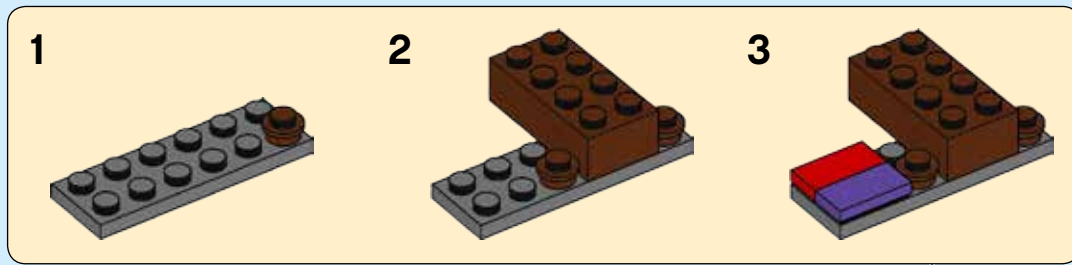

85

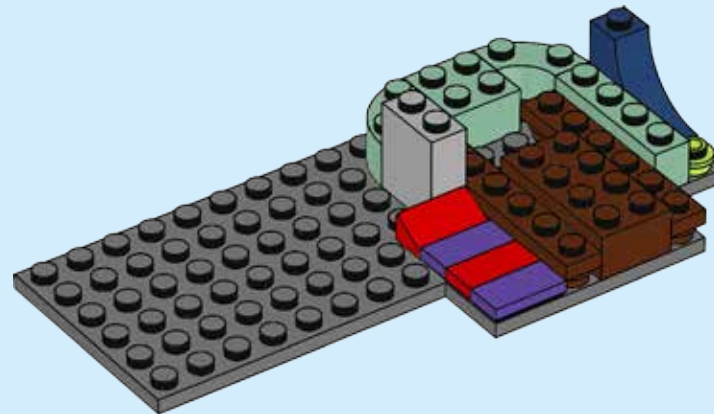



86

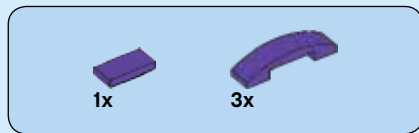
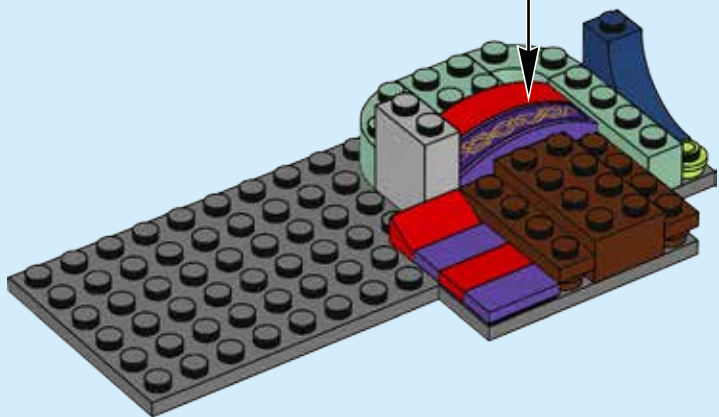
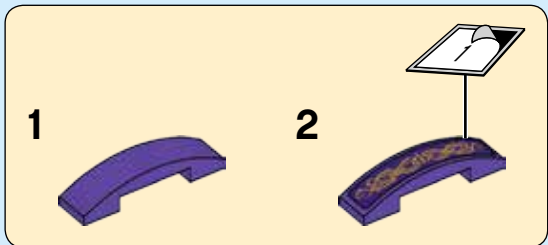

87

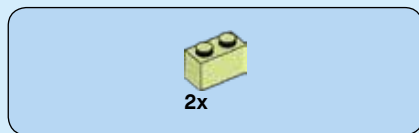
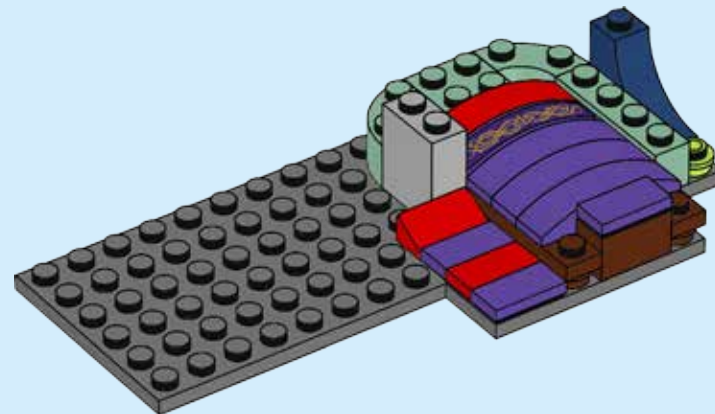

88

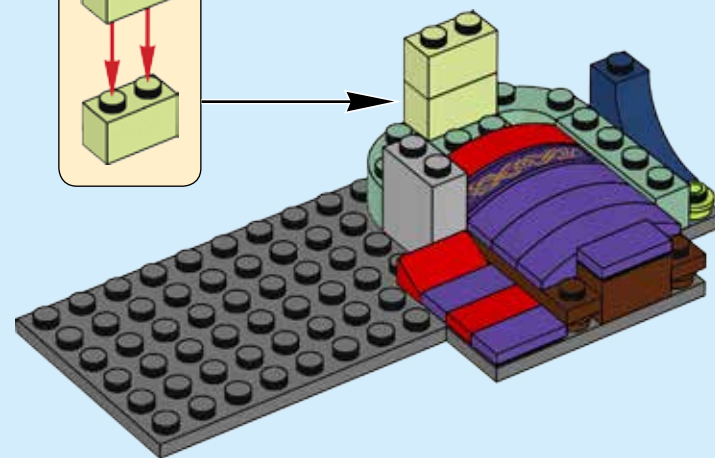
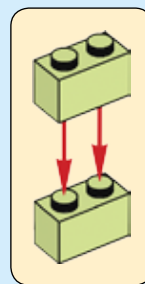



89

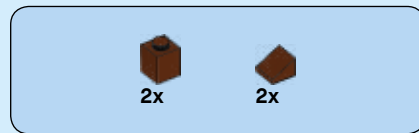
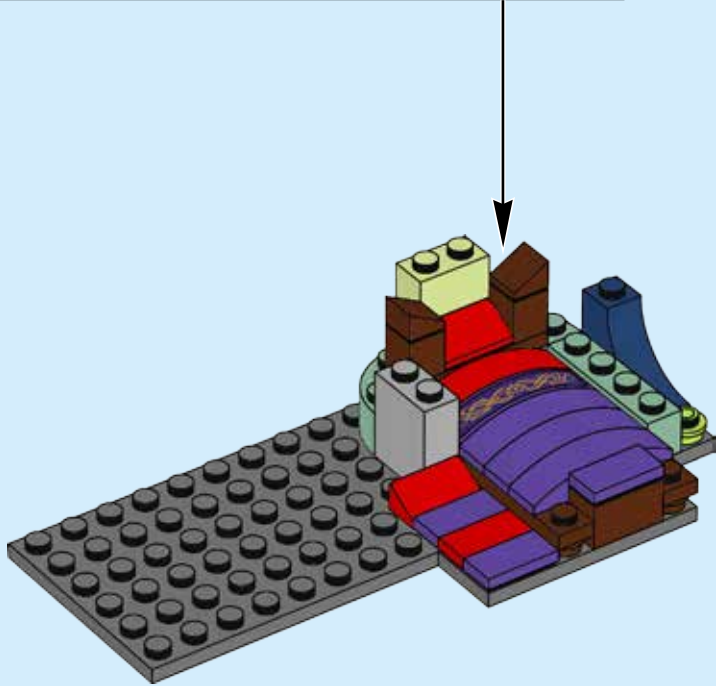
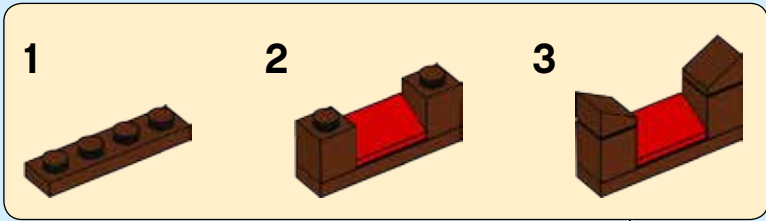

90

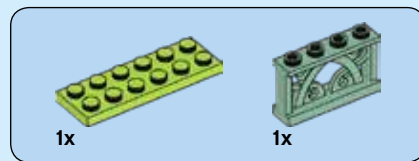
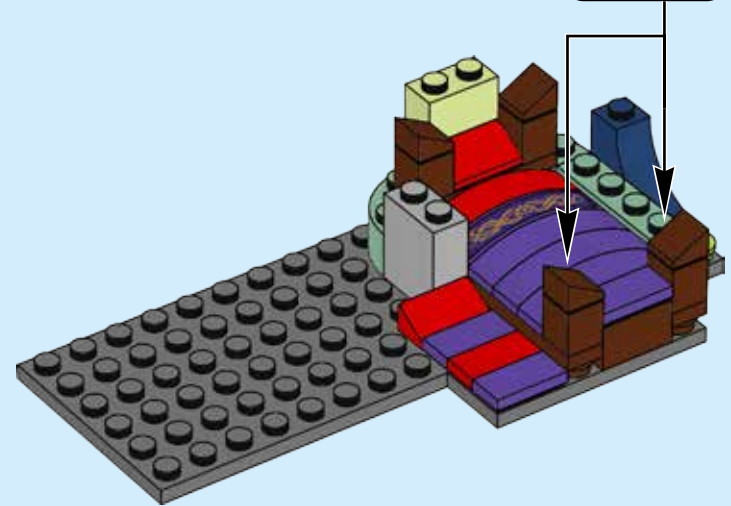
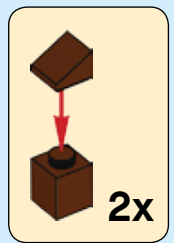

91

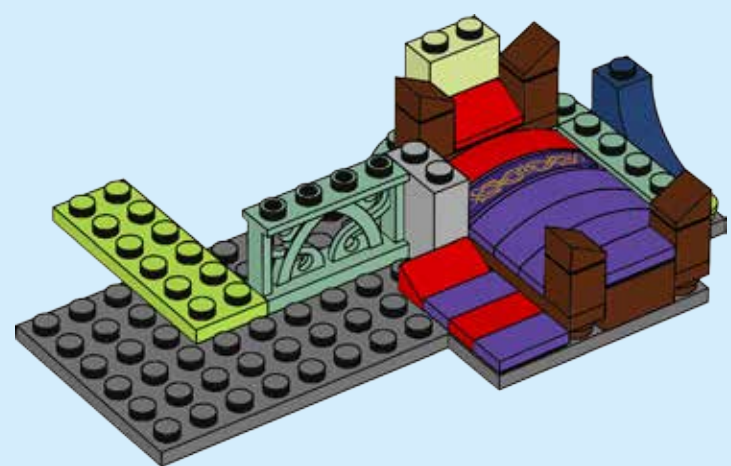

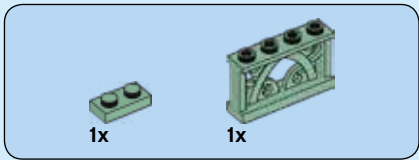

92

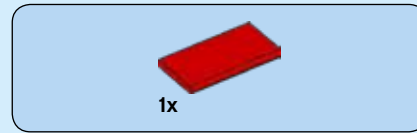
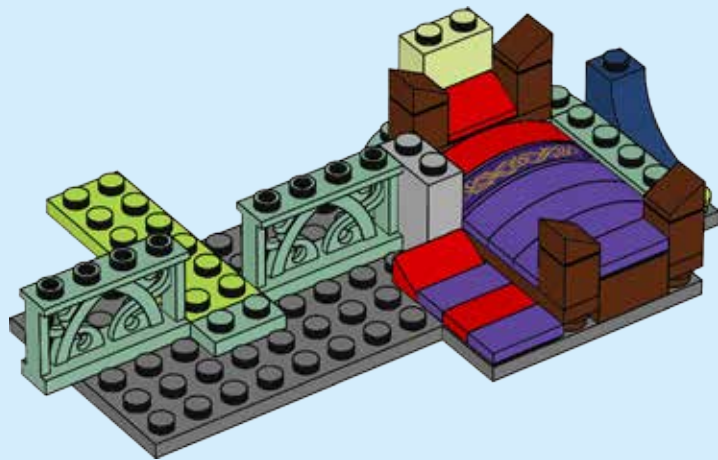

93

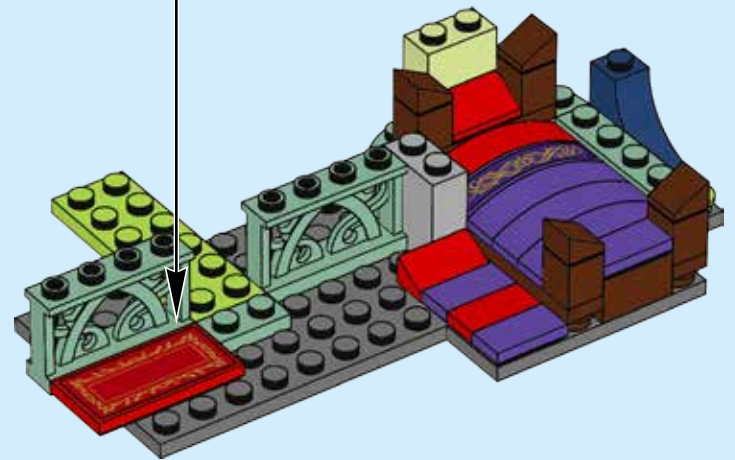
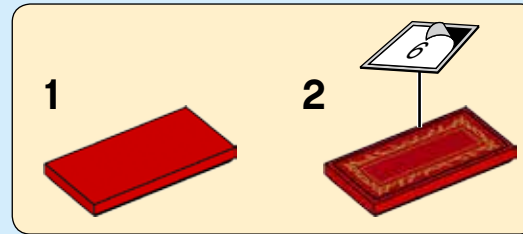

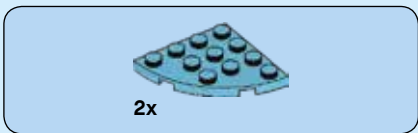

94

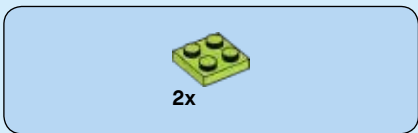
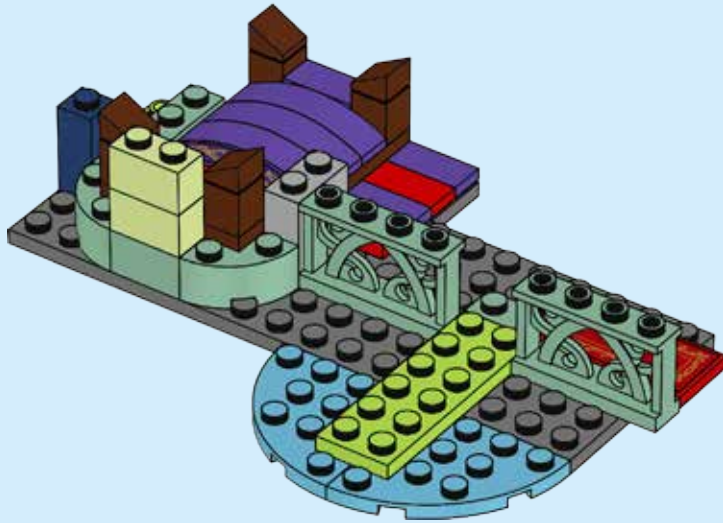
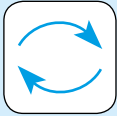

95

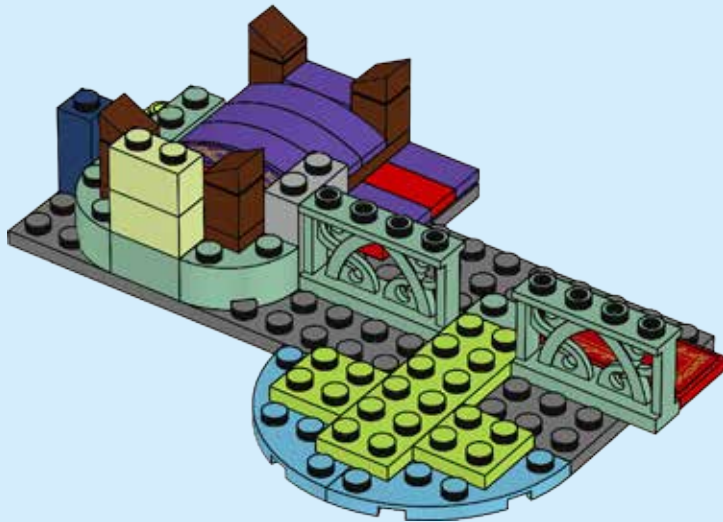

96

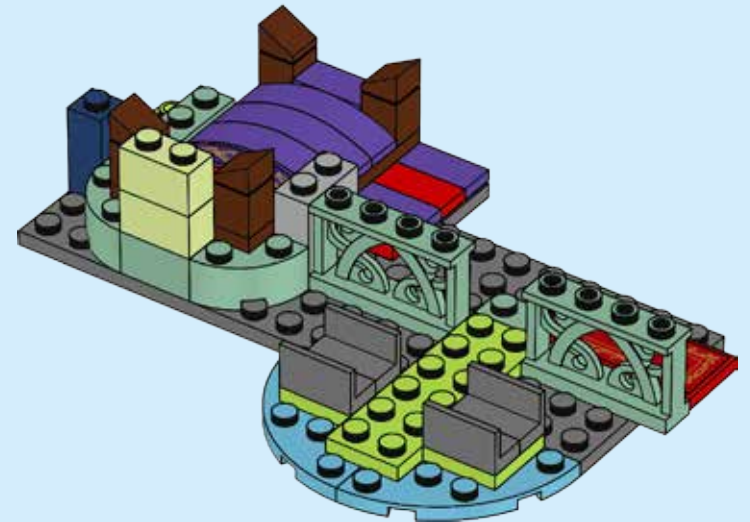

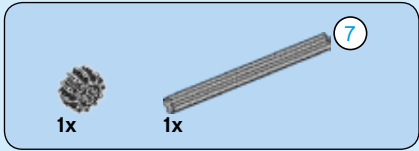
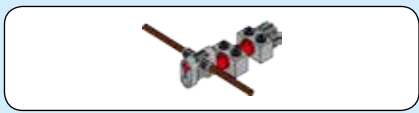

97

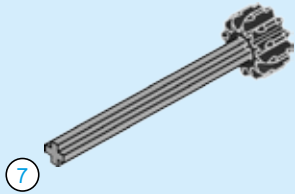

98

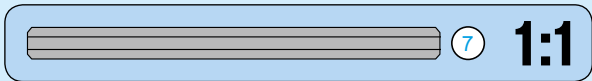
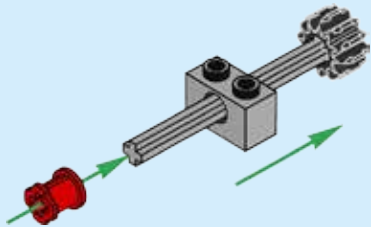

99

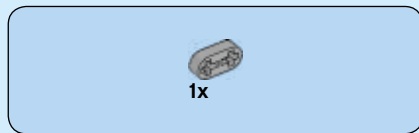
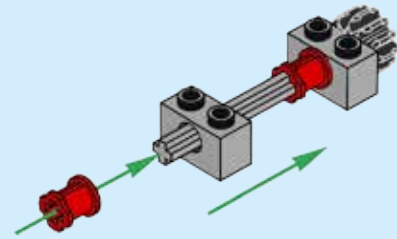

100

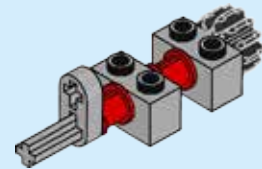

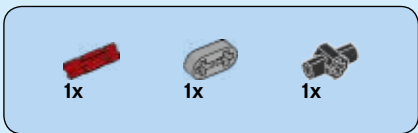

101

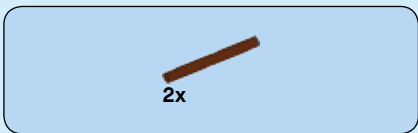
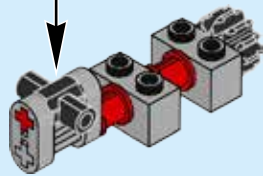

102

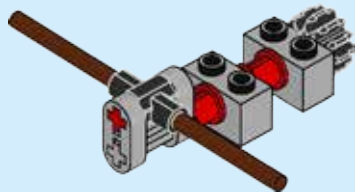

103

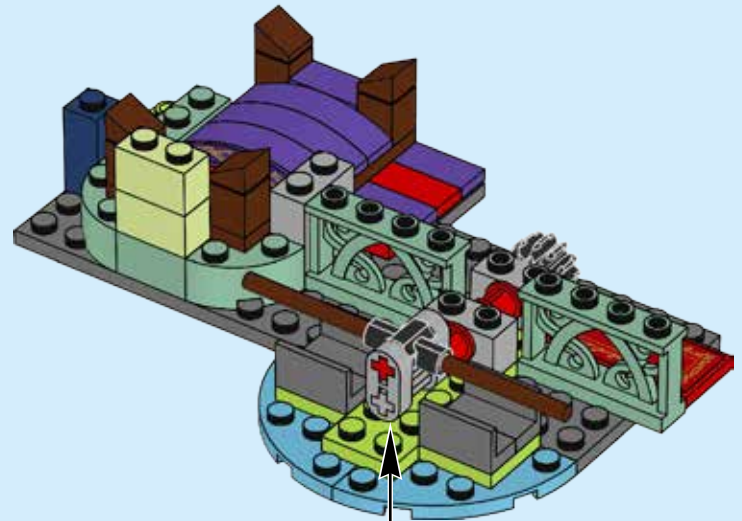

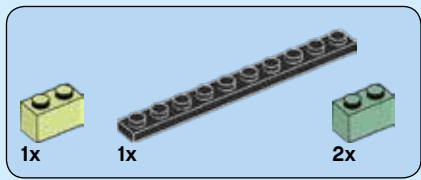

104

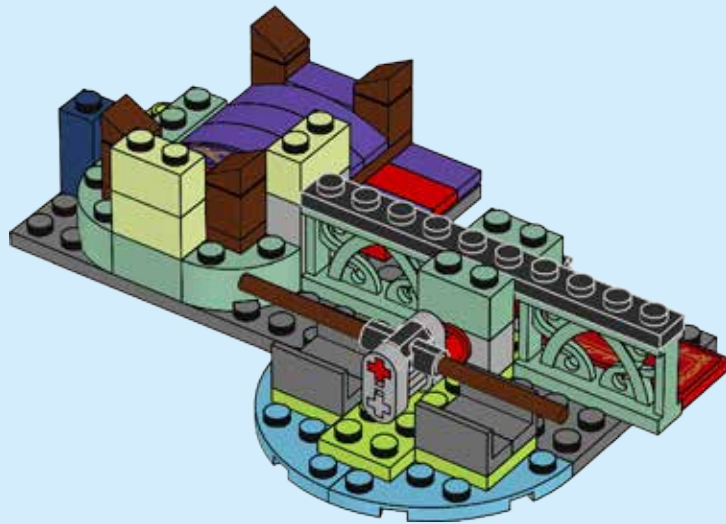



105

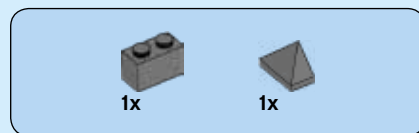
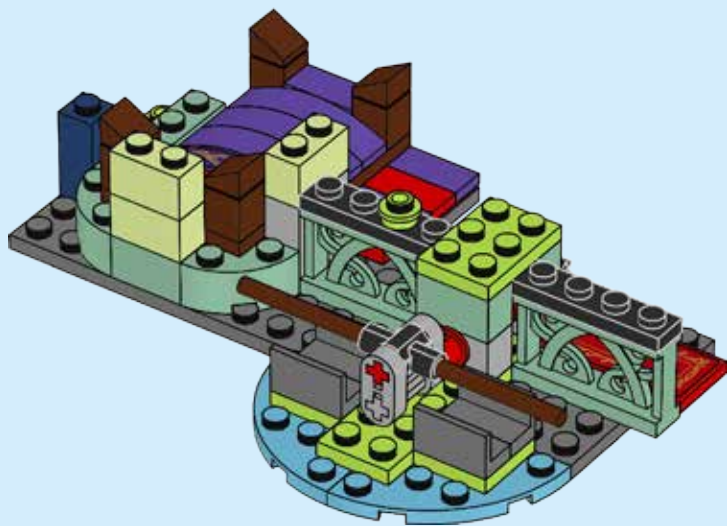

106

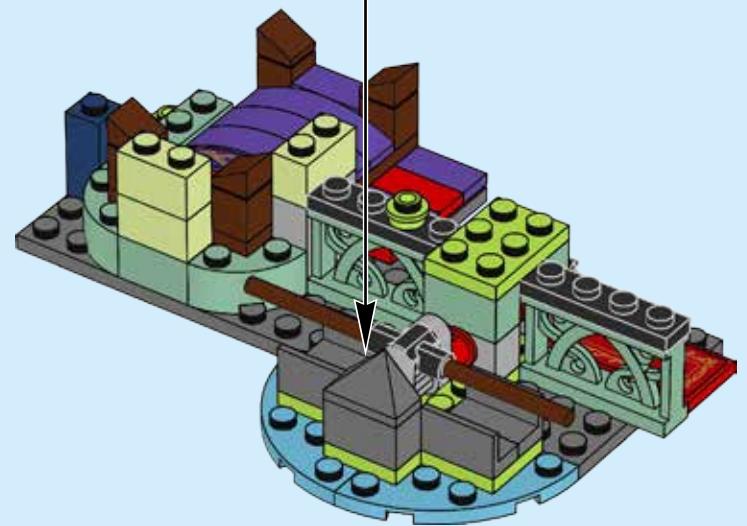
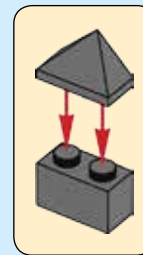



2x



2x



4x



2x



2x



4x



2x



2x

107

1

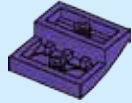

3

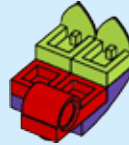

5

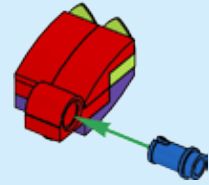

2



4

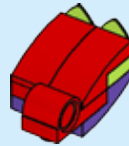

6



2x

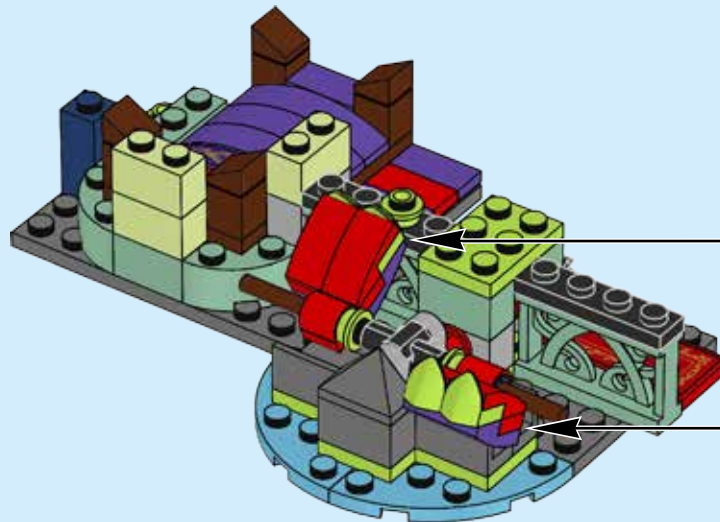

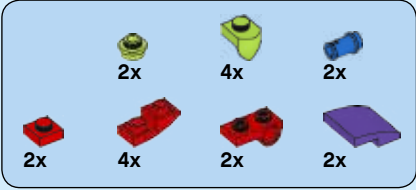

108

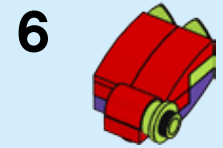
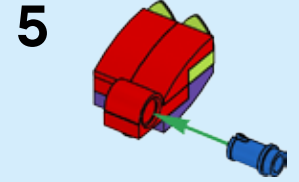
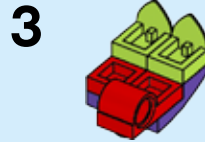
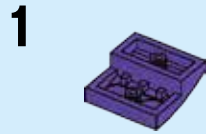

2x

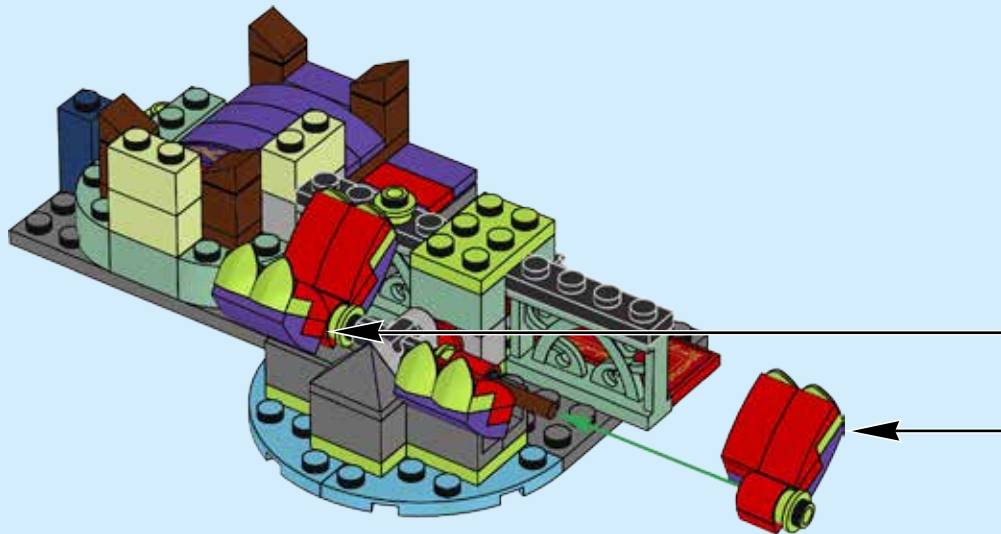

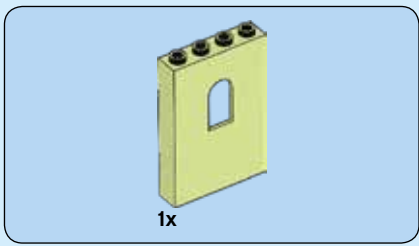

109

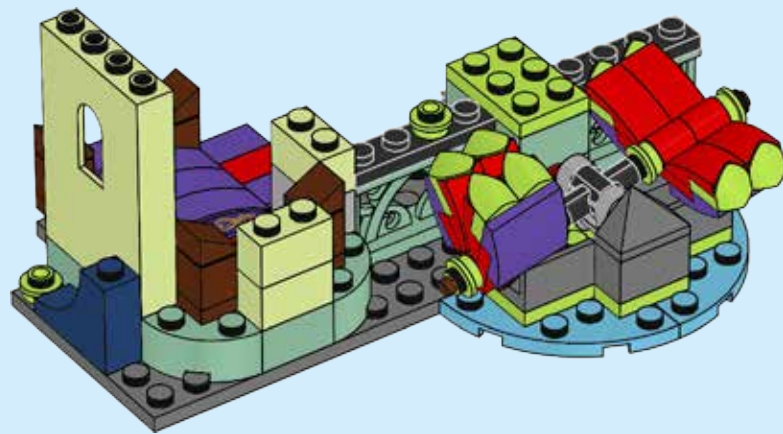

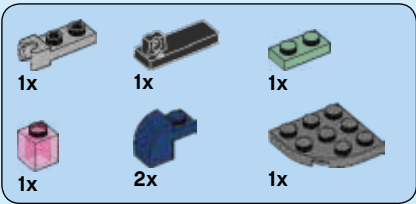

110

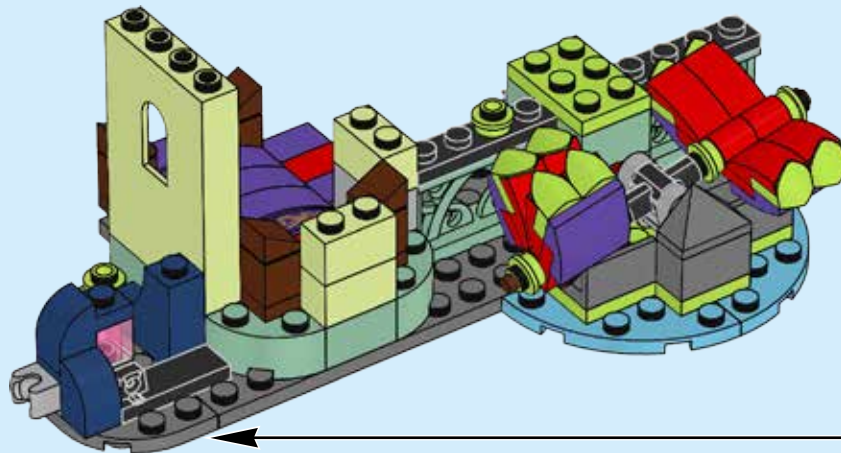
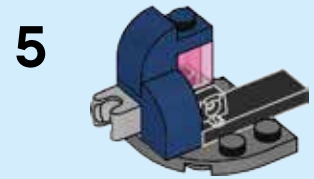
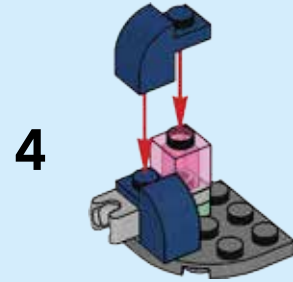
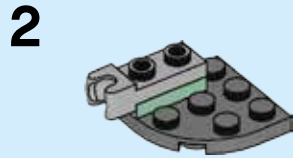



1x

111

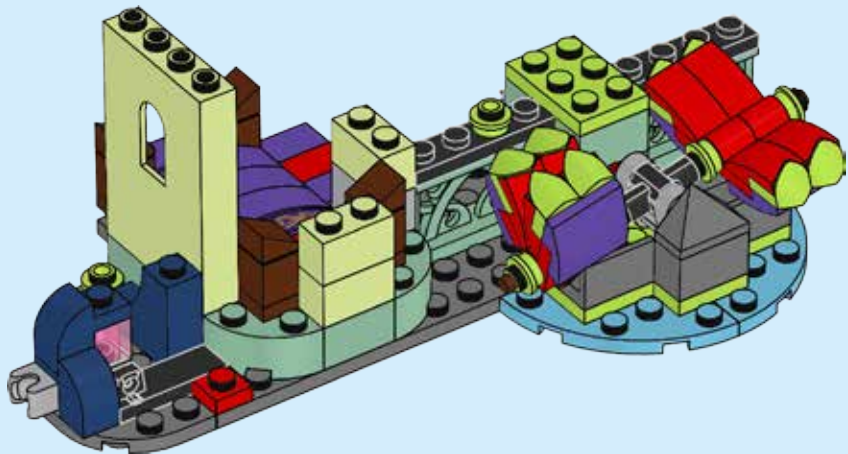

1x



1x



1x



2x

112

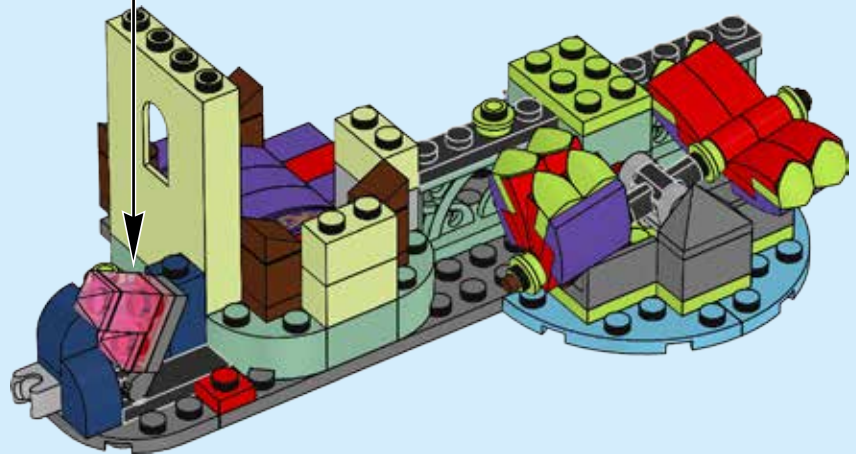
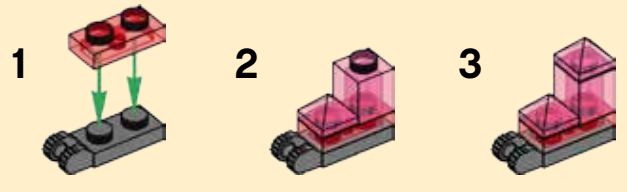

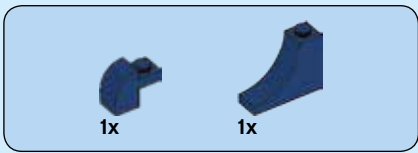

113

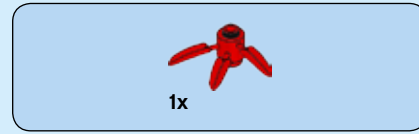
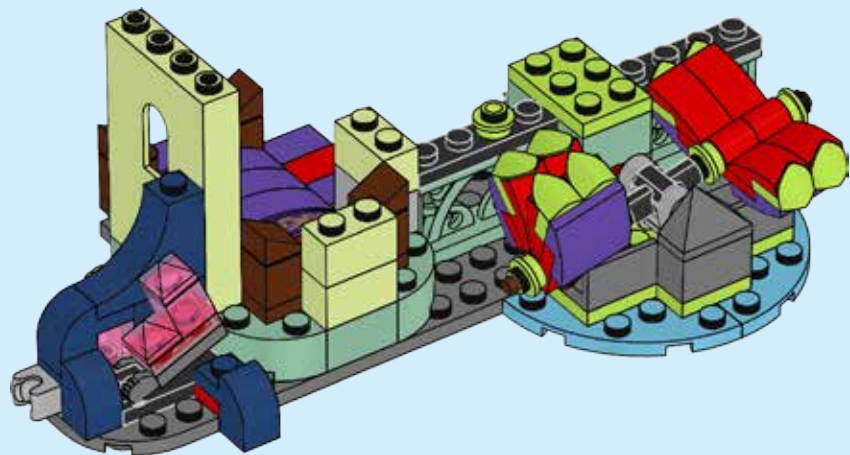

114

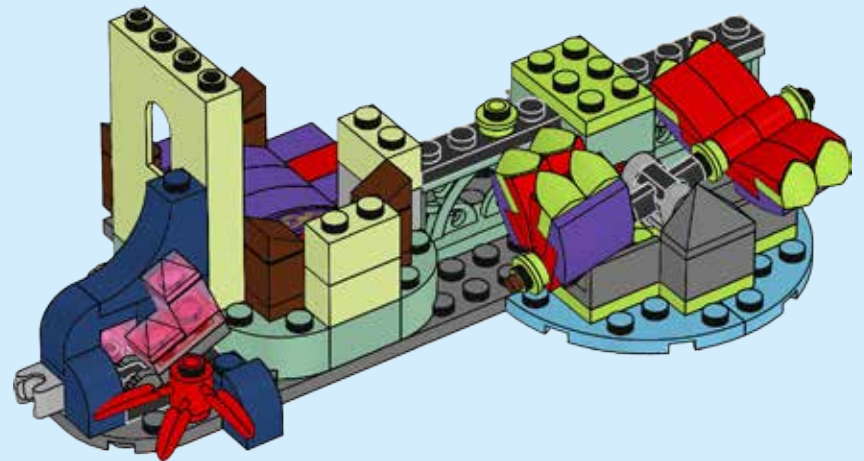

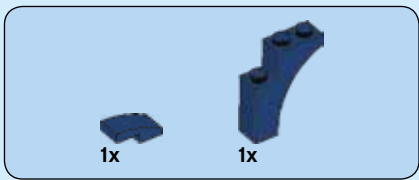

115

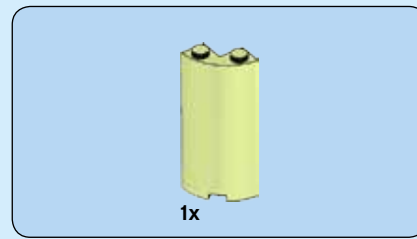
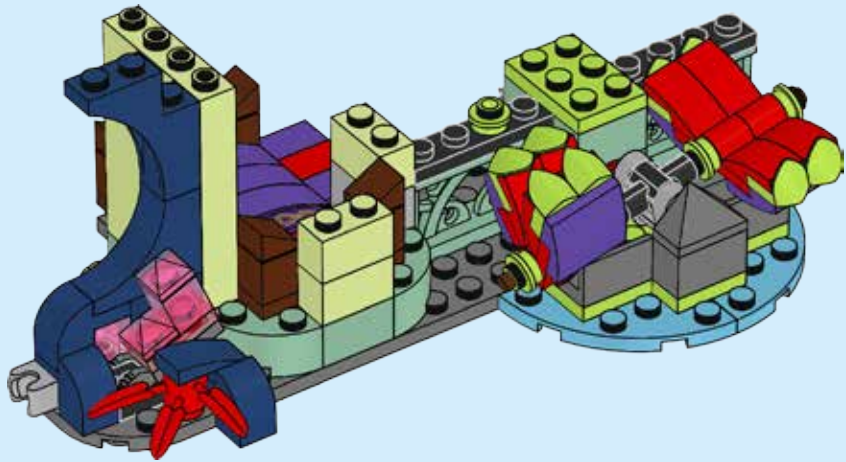

116

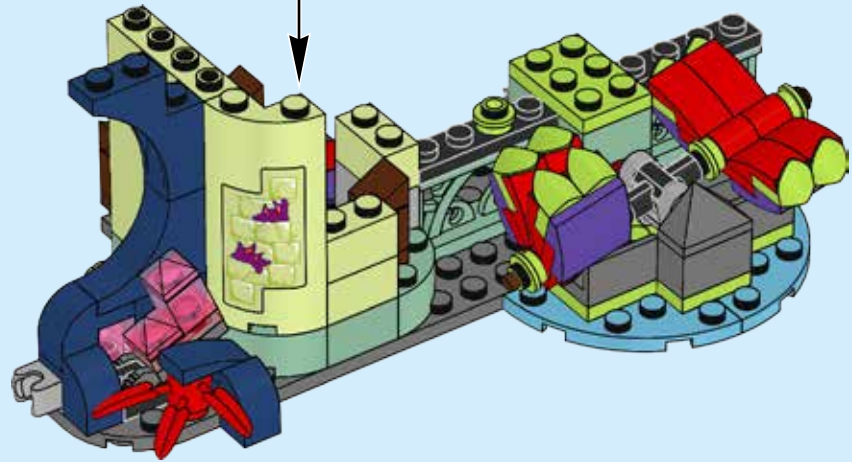
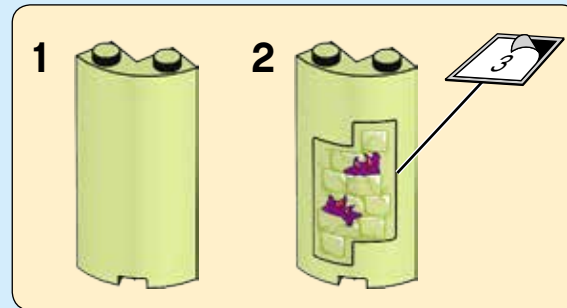

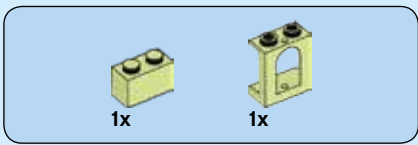

117

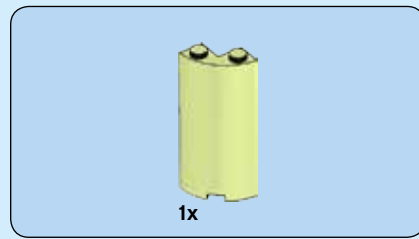
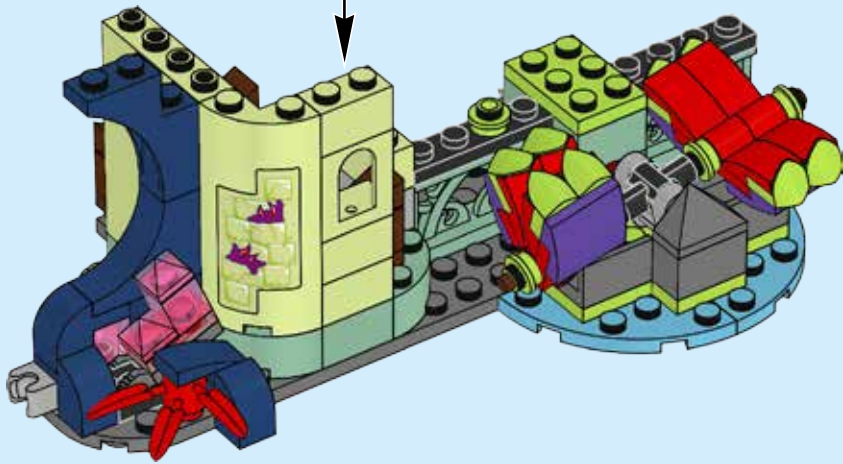
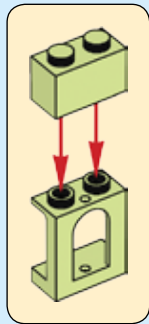

118

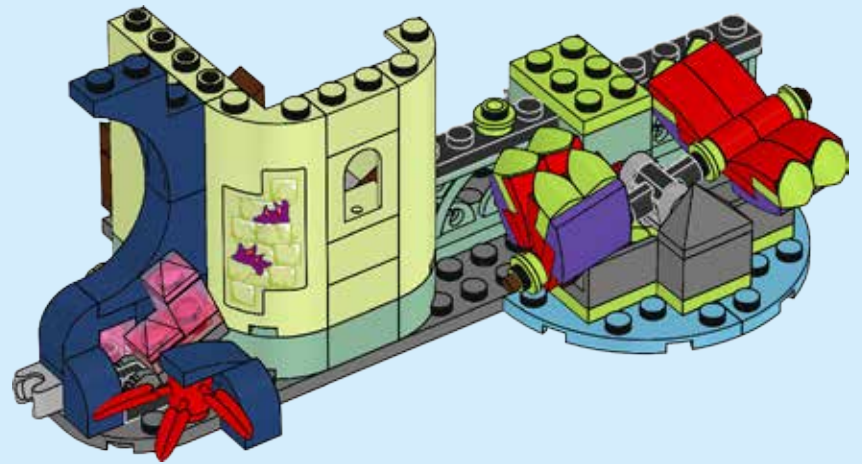

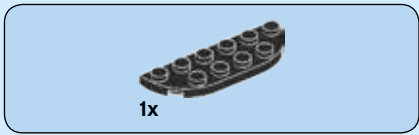

119

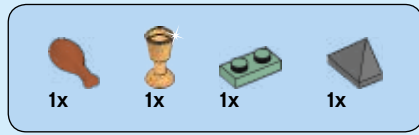
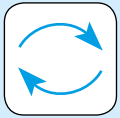

120

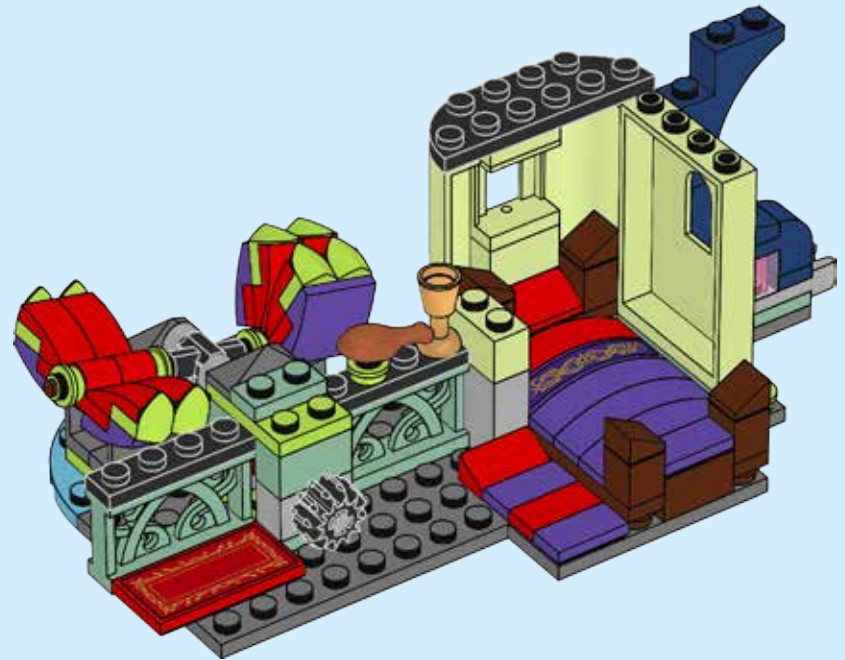

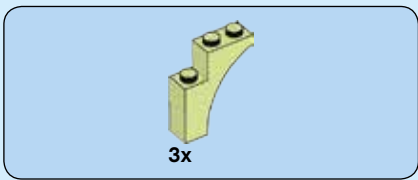

121

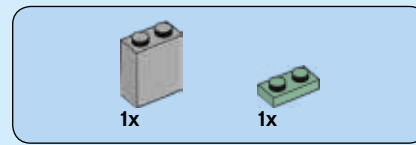
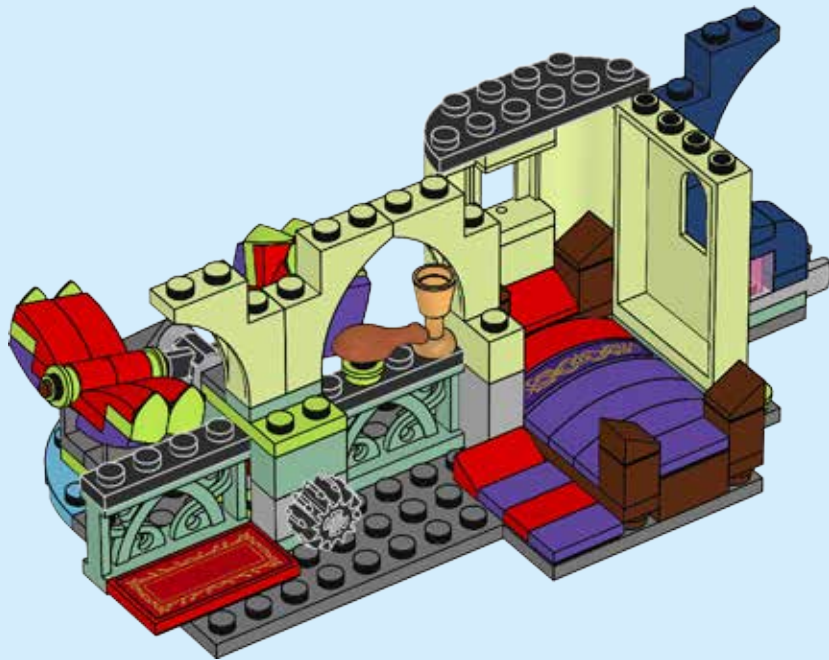

122

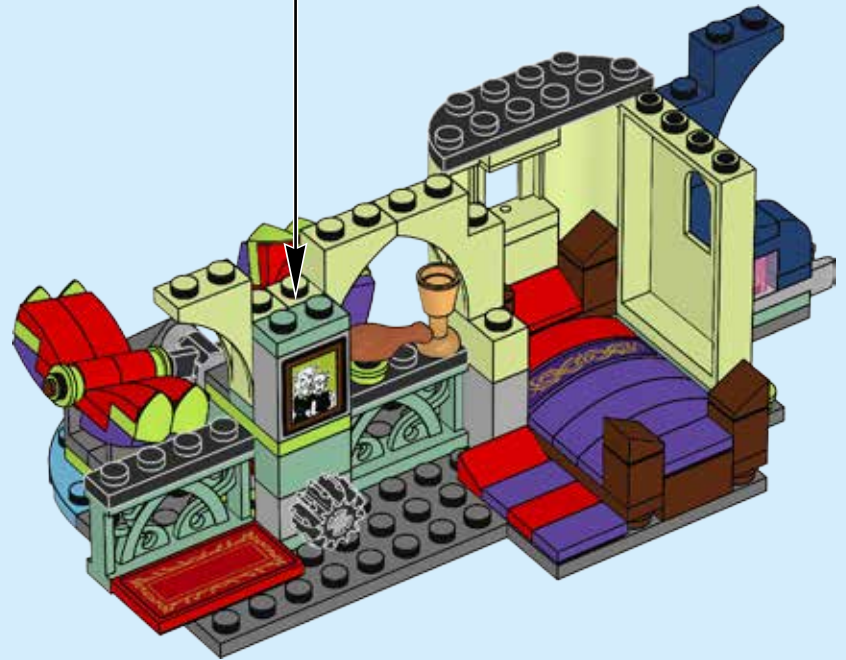
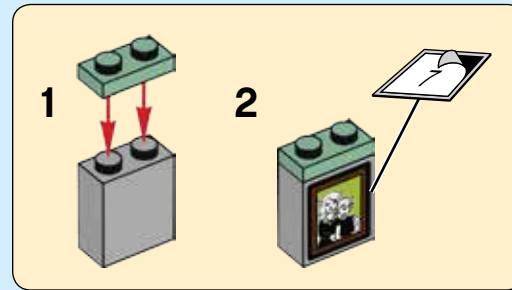

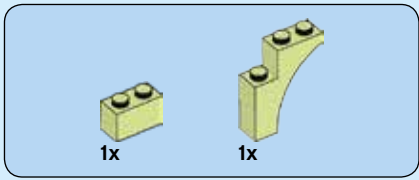

123

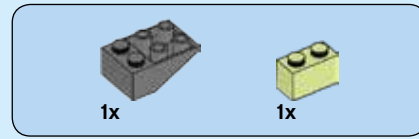
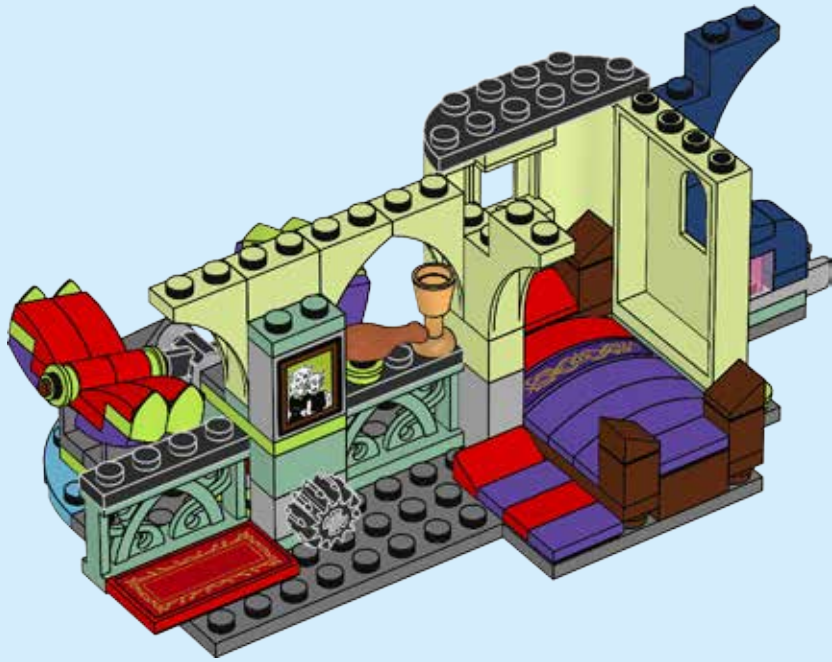

124

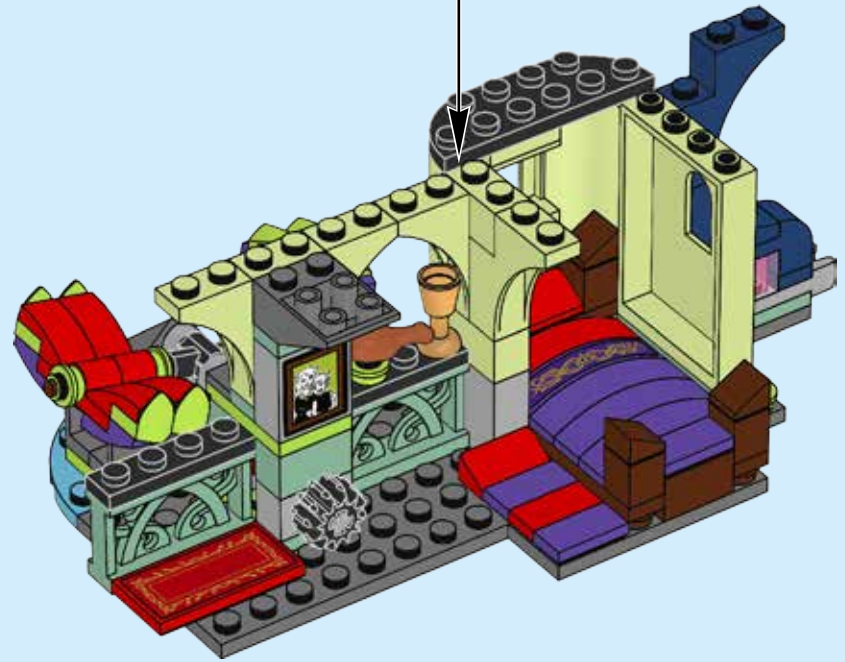
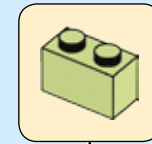

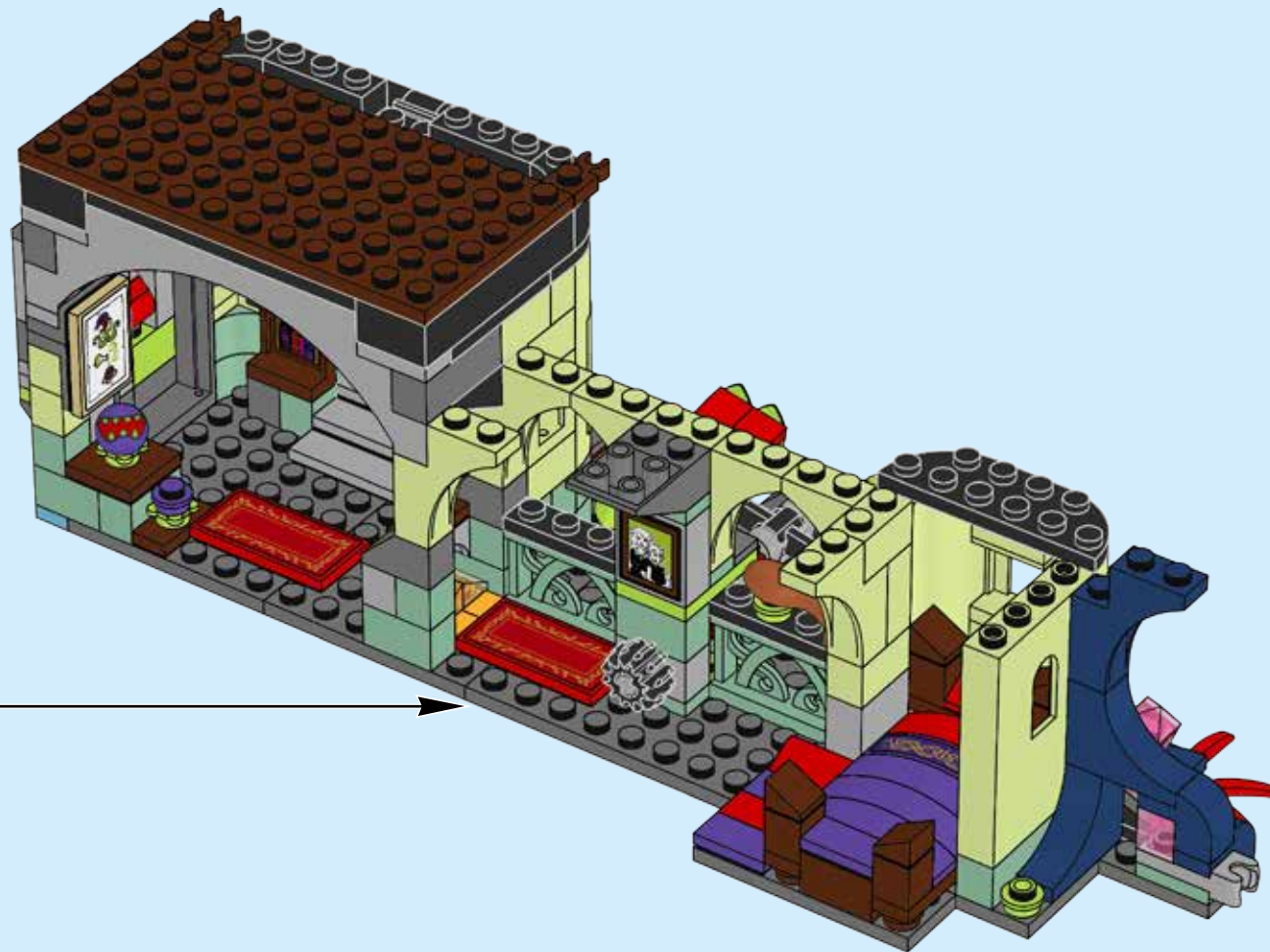
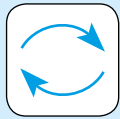

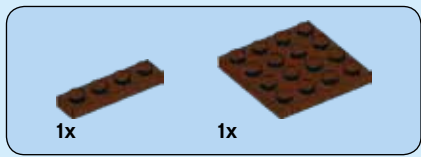

126

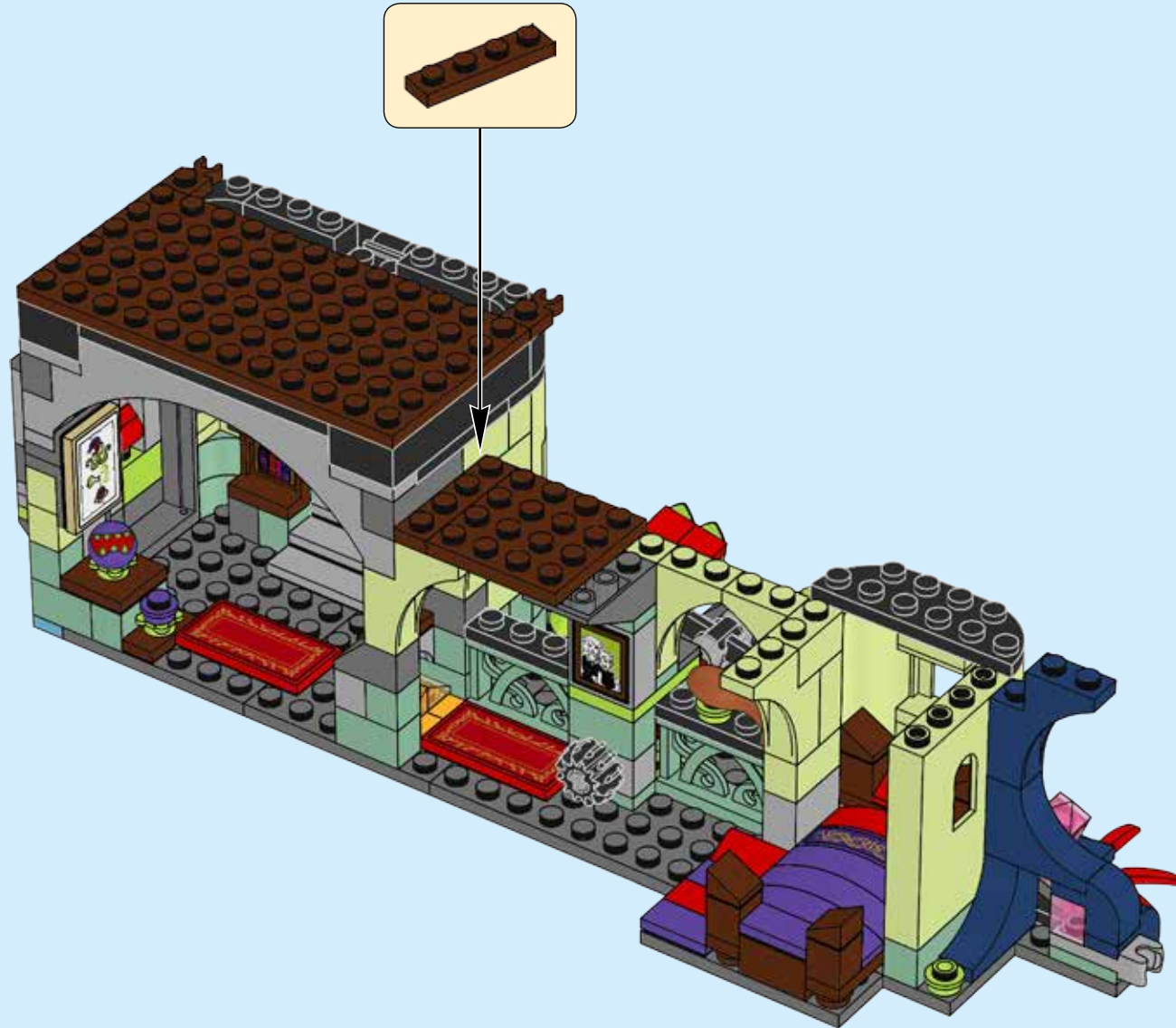

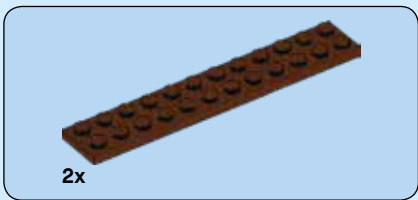

127

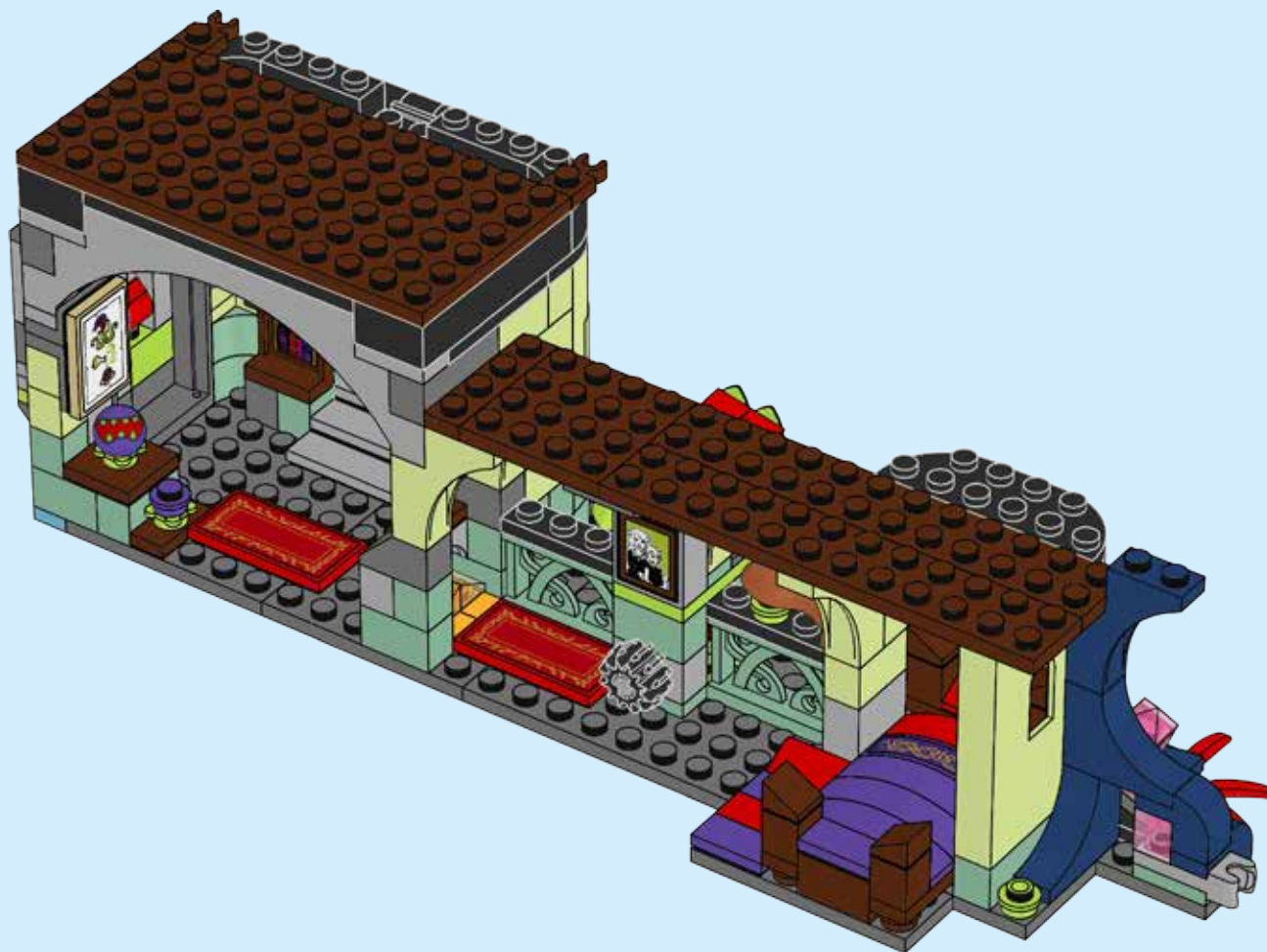



1x

128

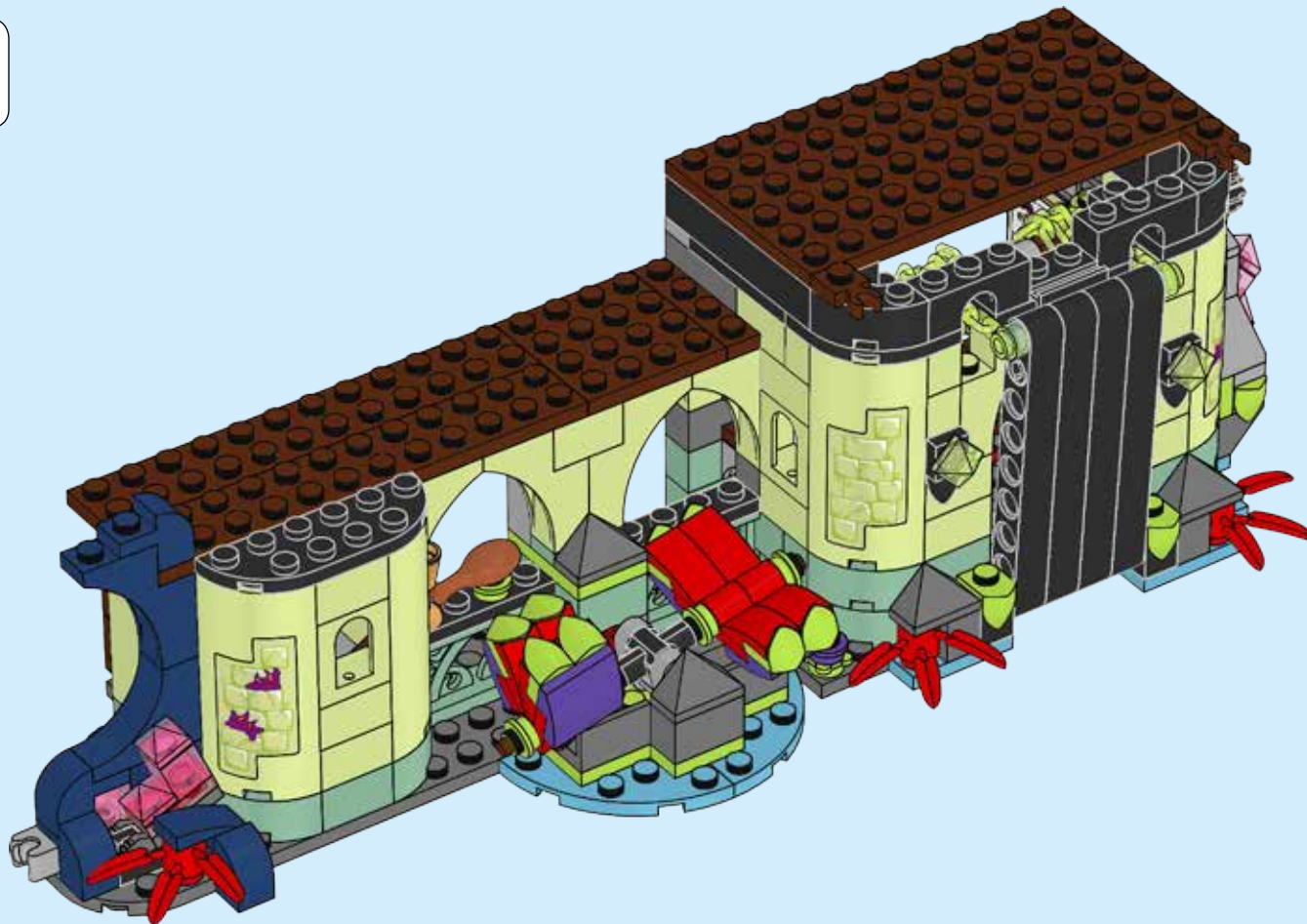
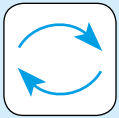

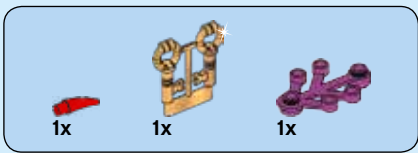

129

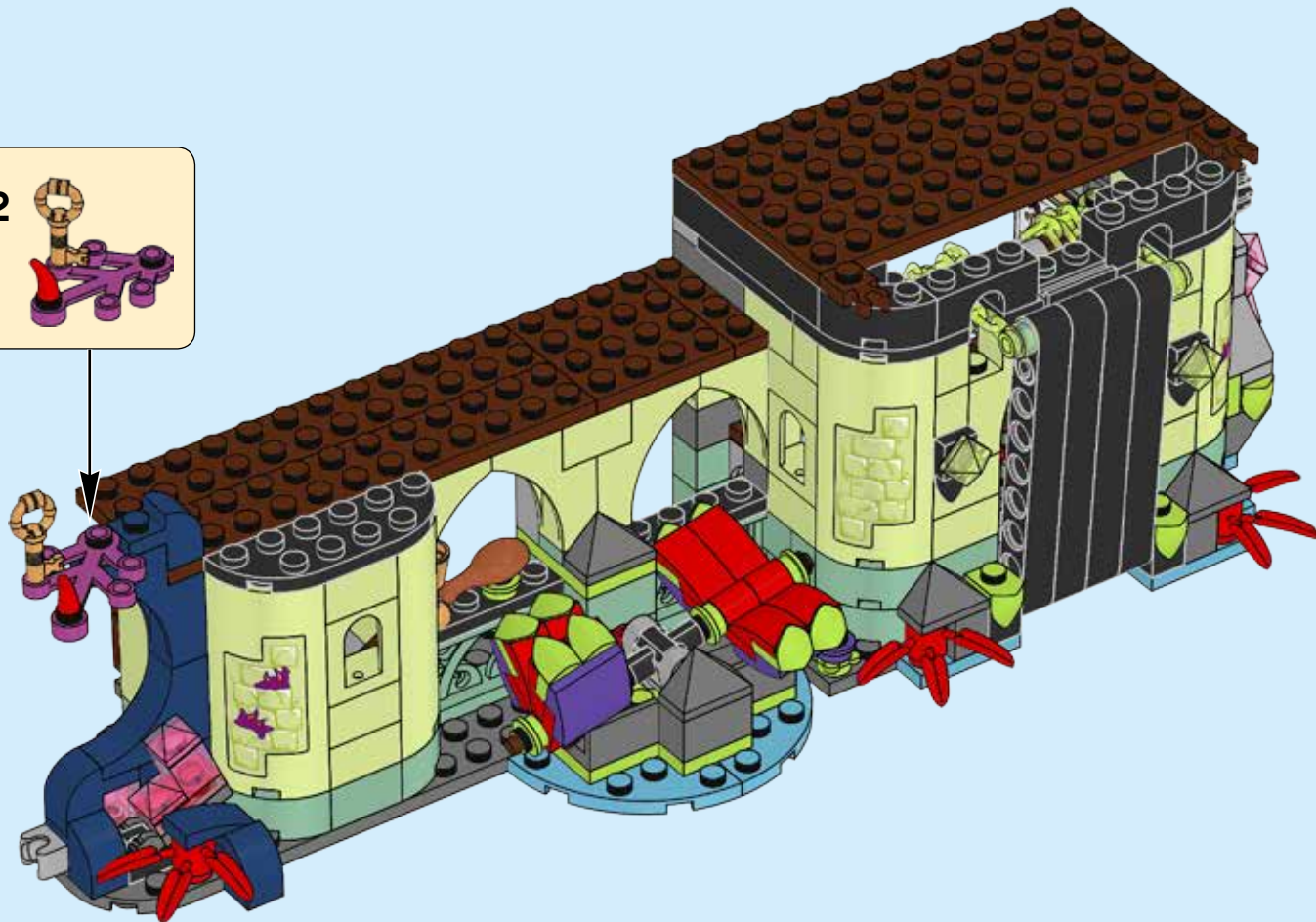



130

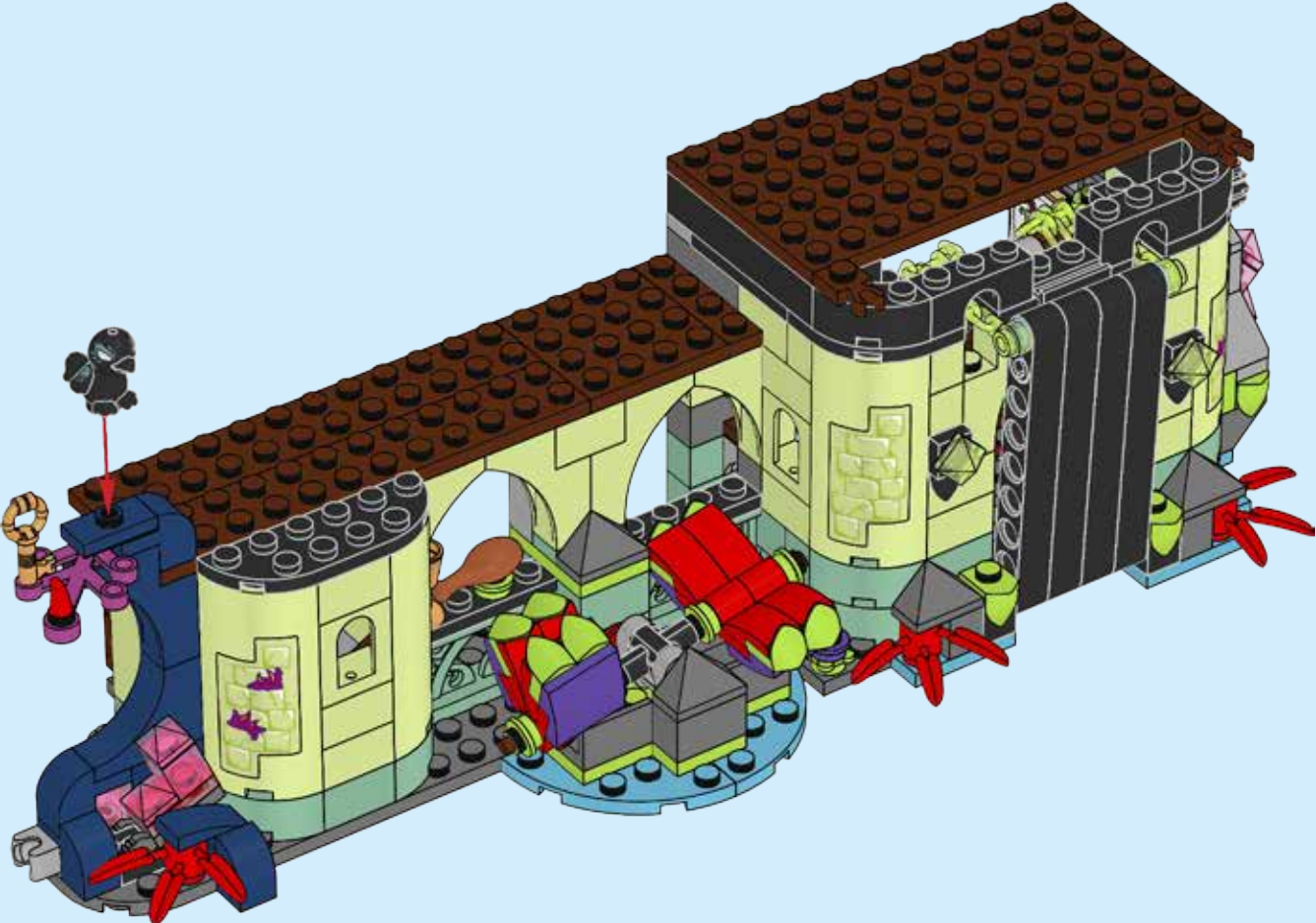

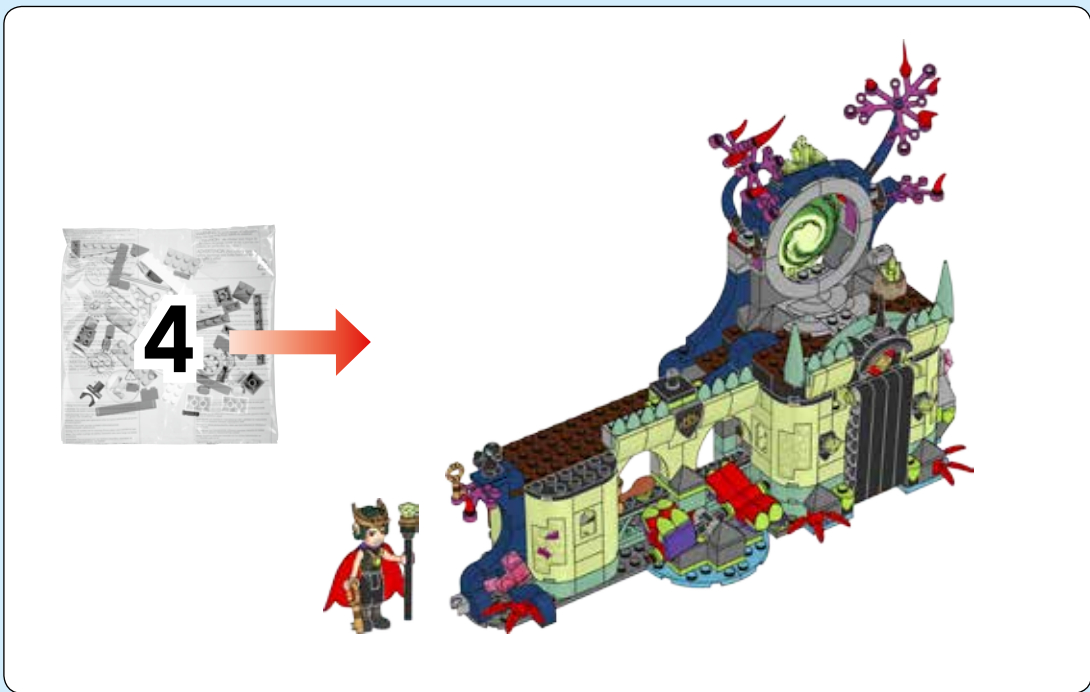

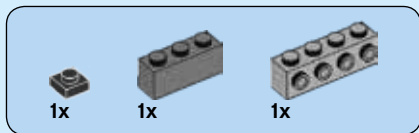

131

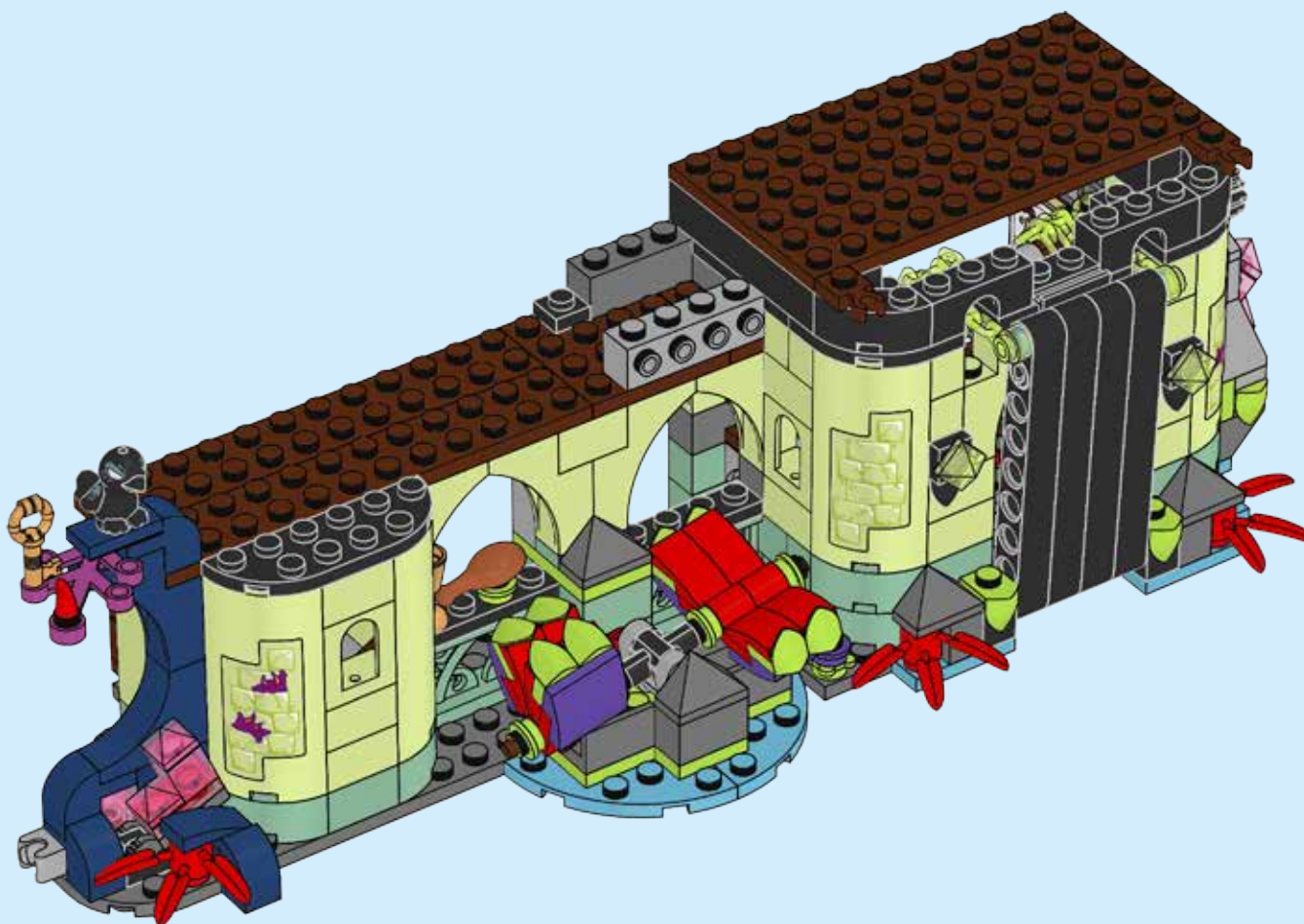



132

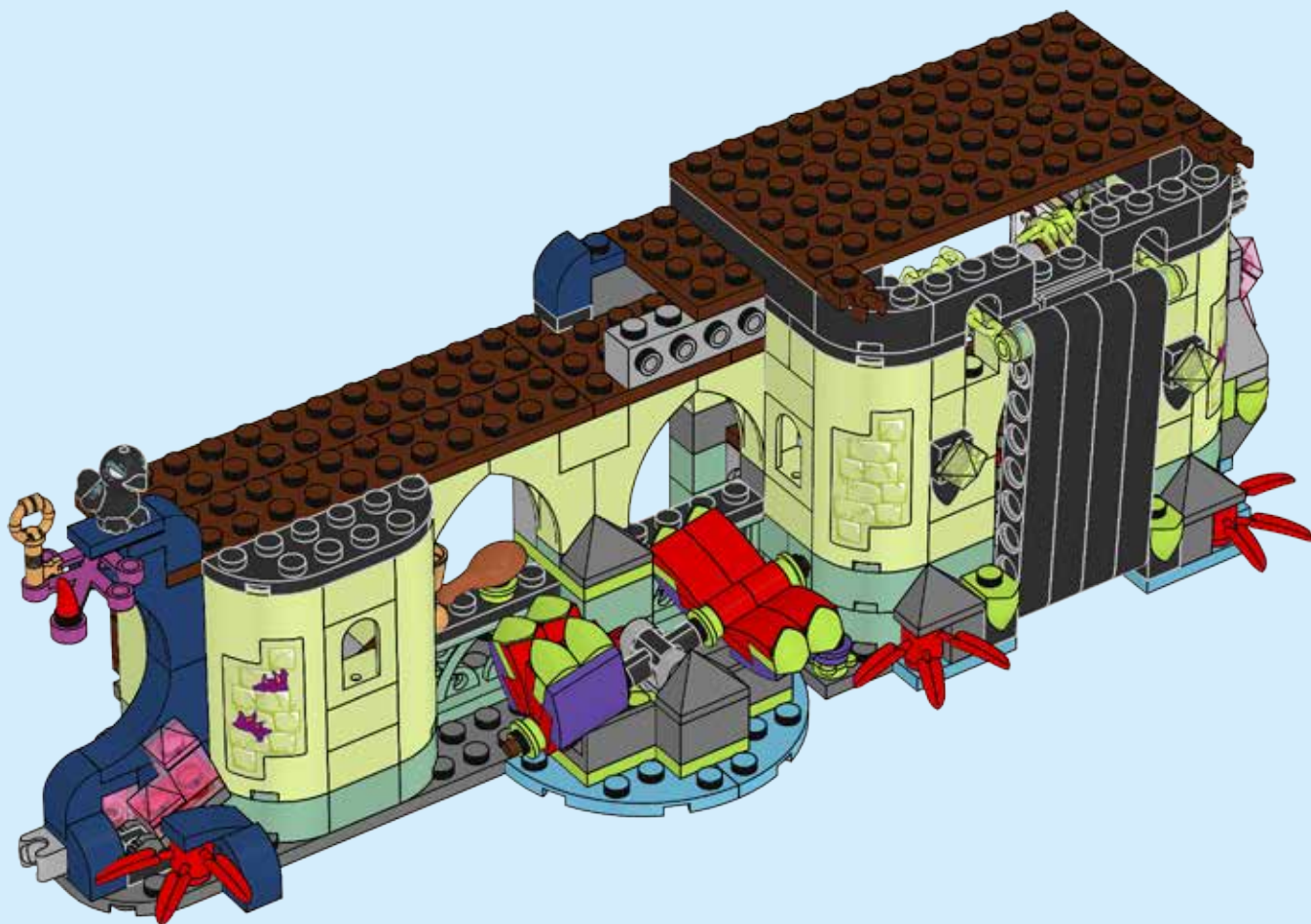

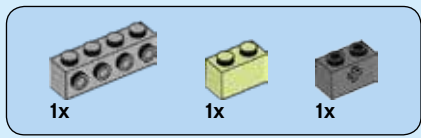

133

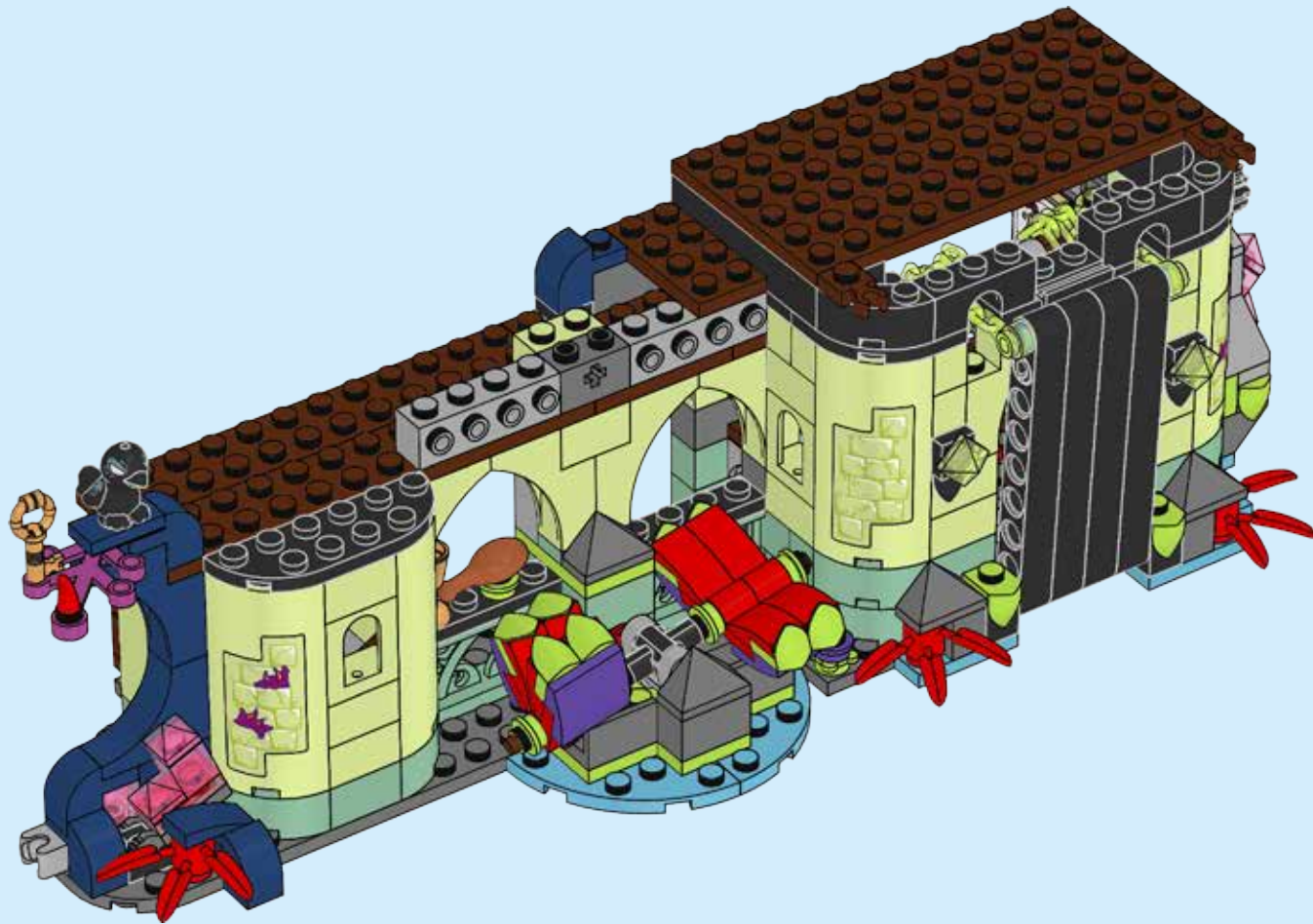



134

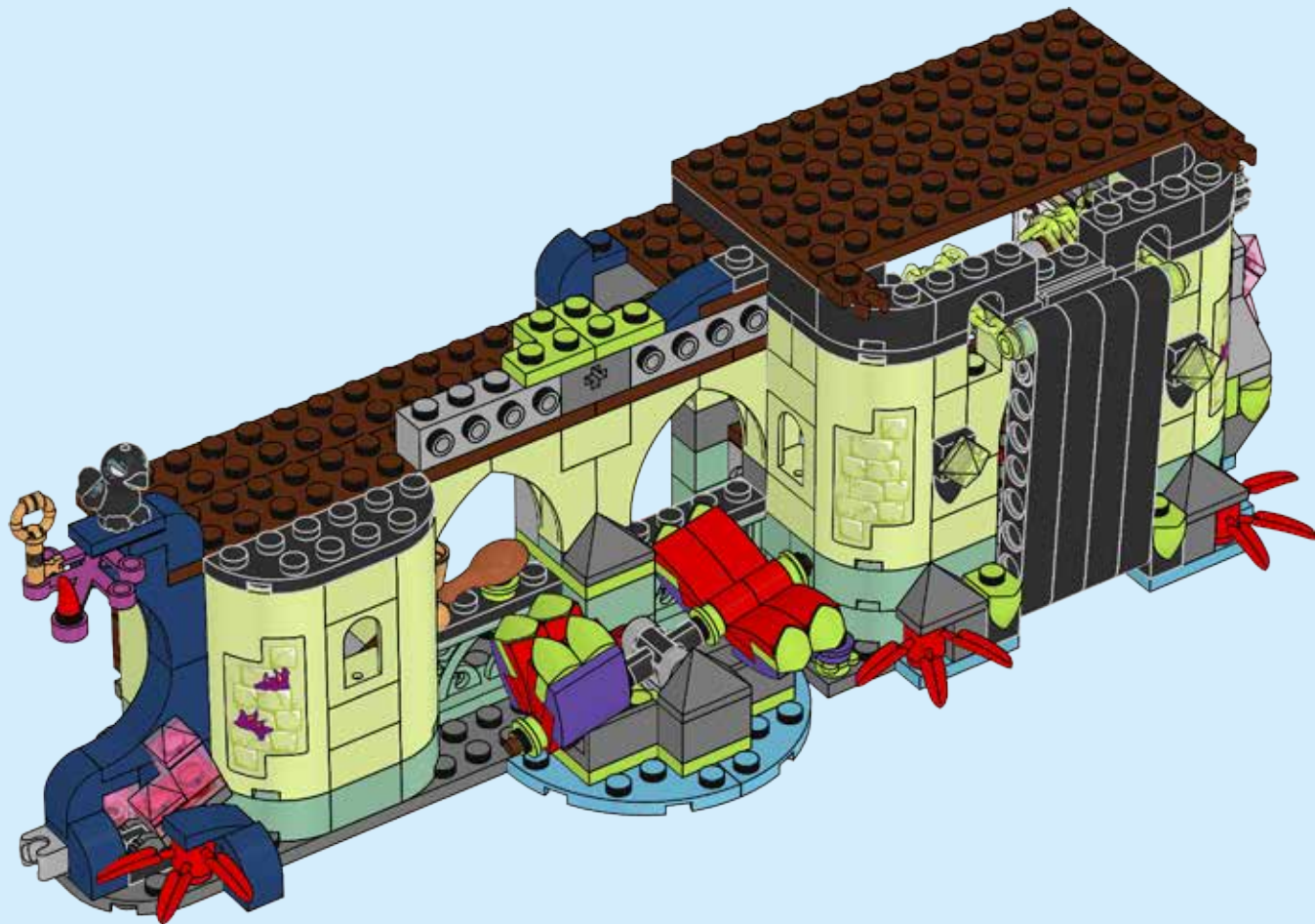



135

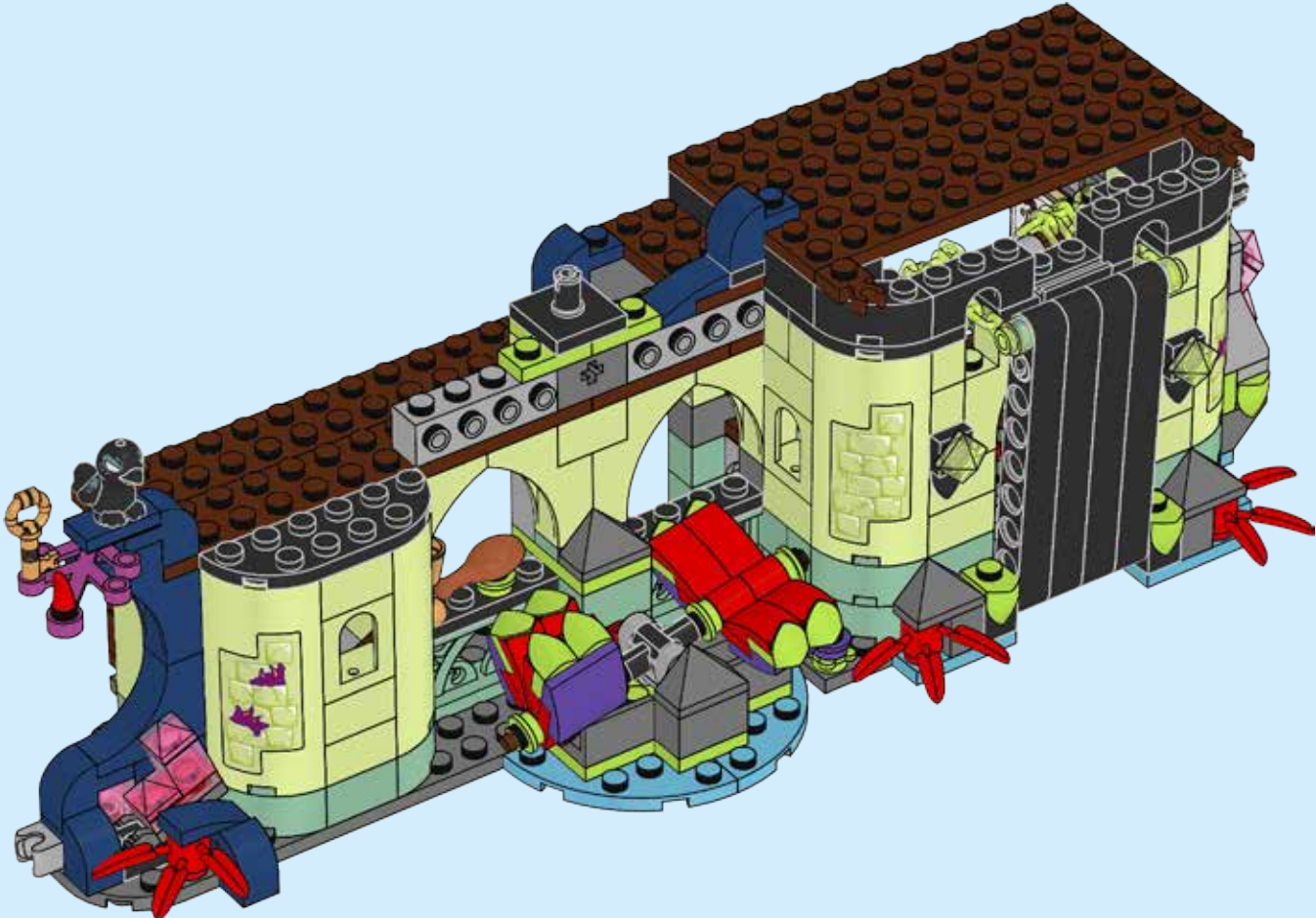

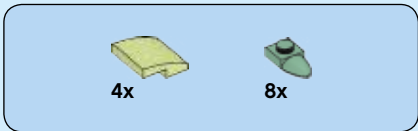

136

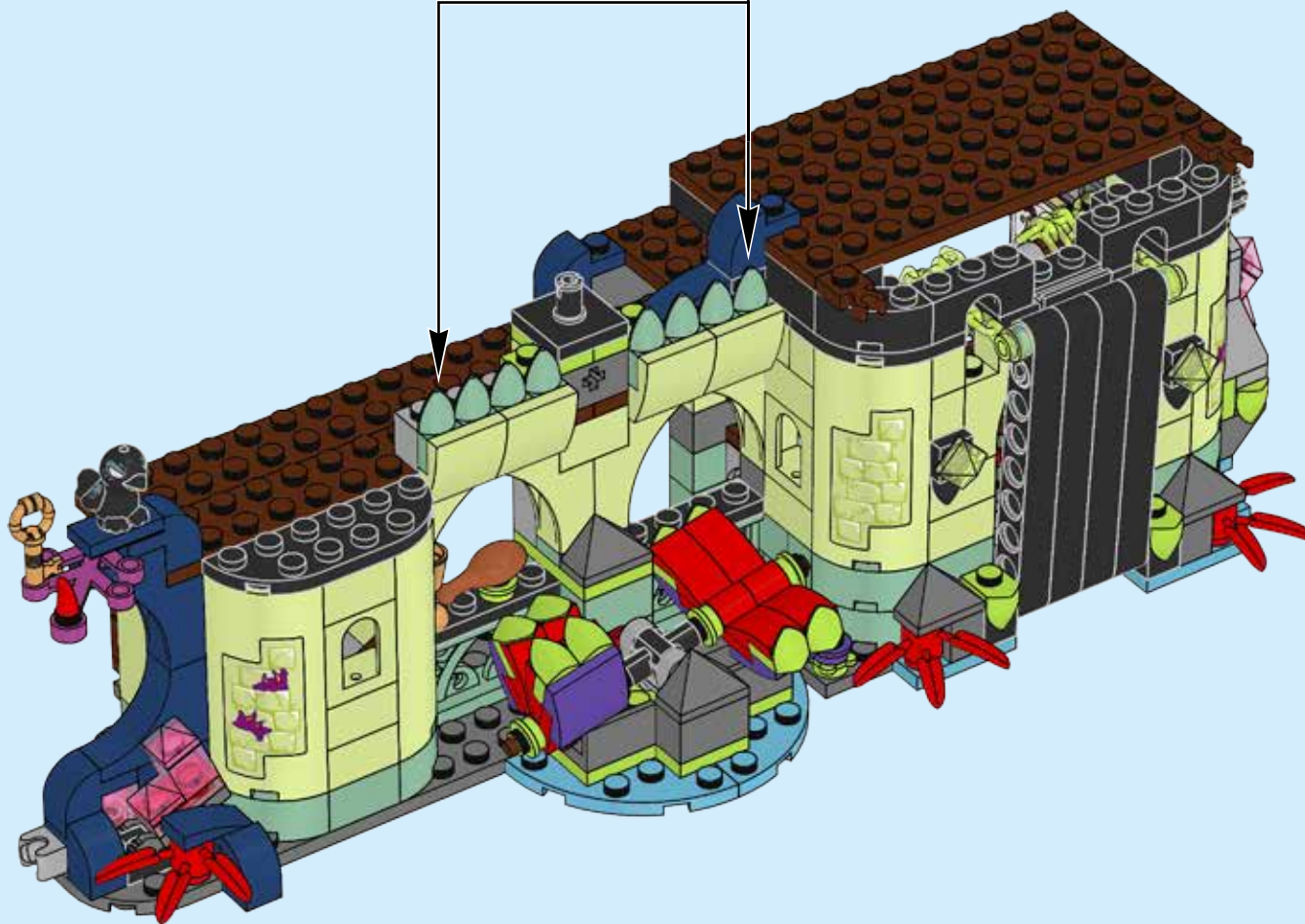
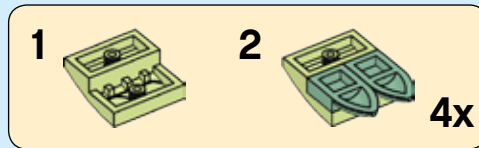



1x

137

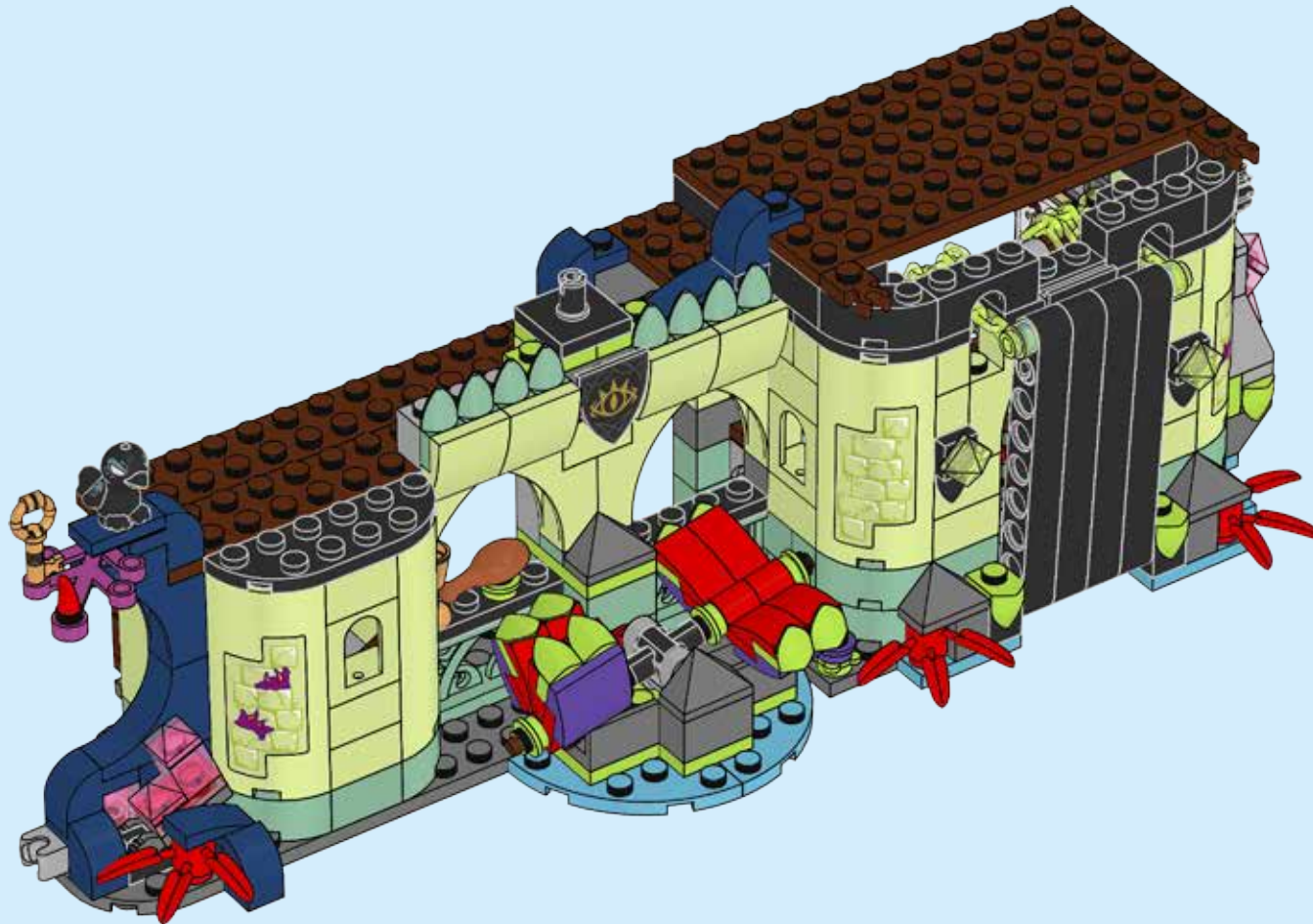



138

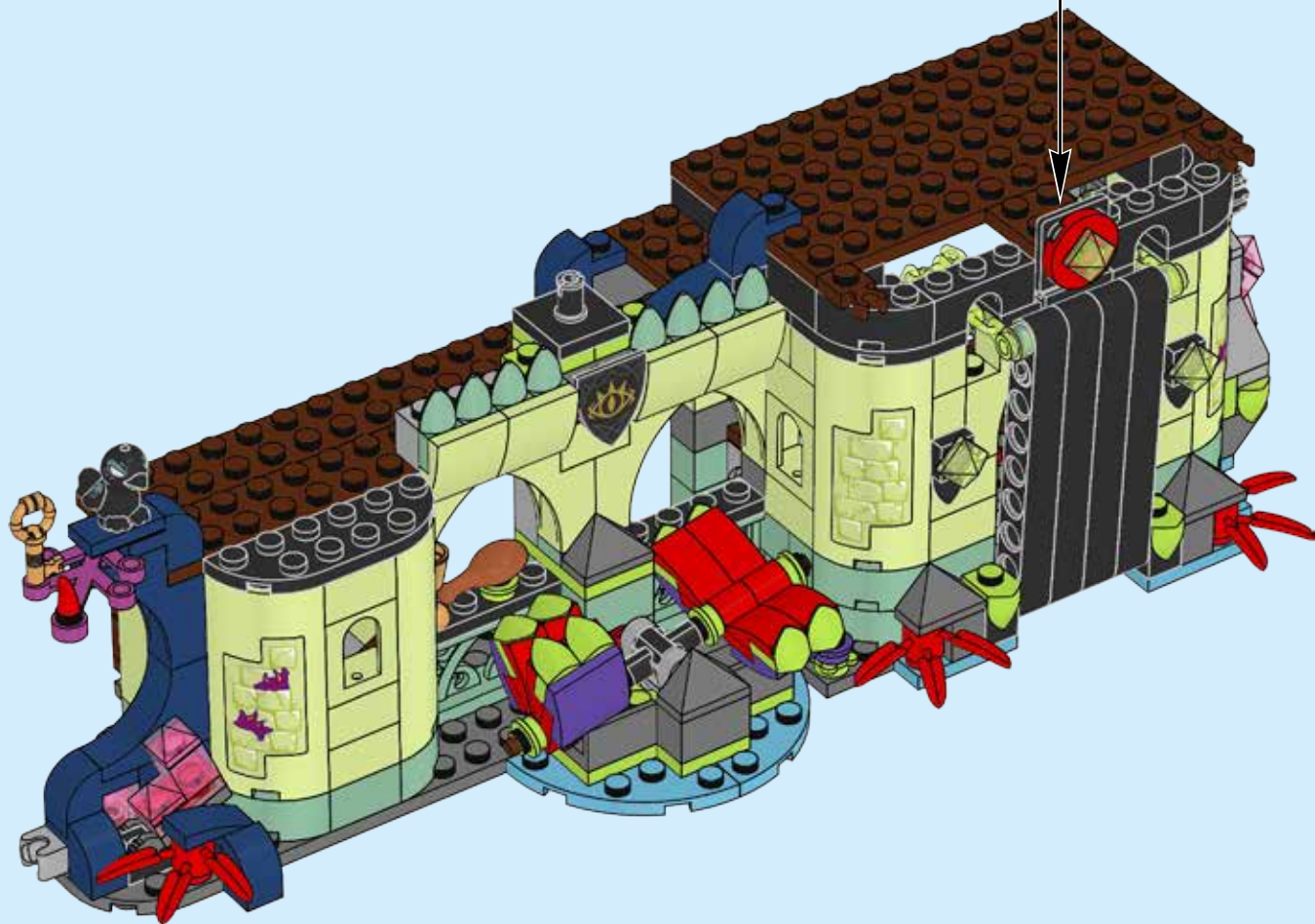
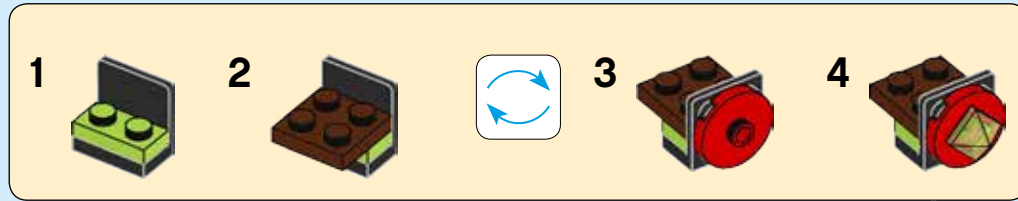

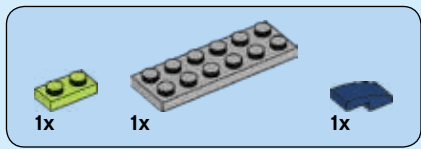

139

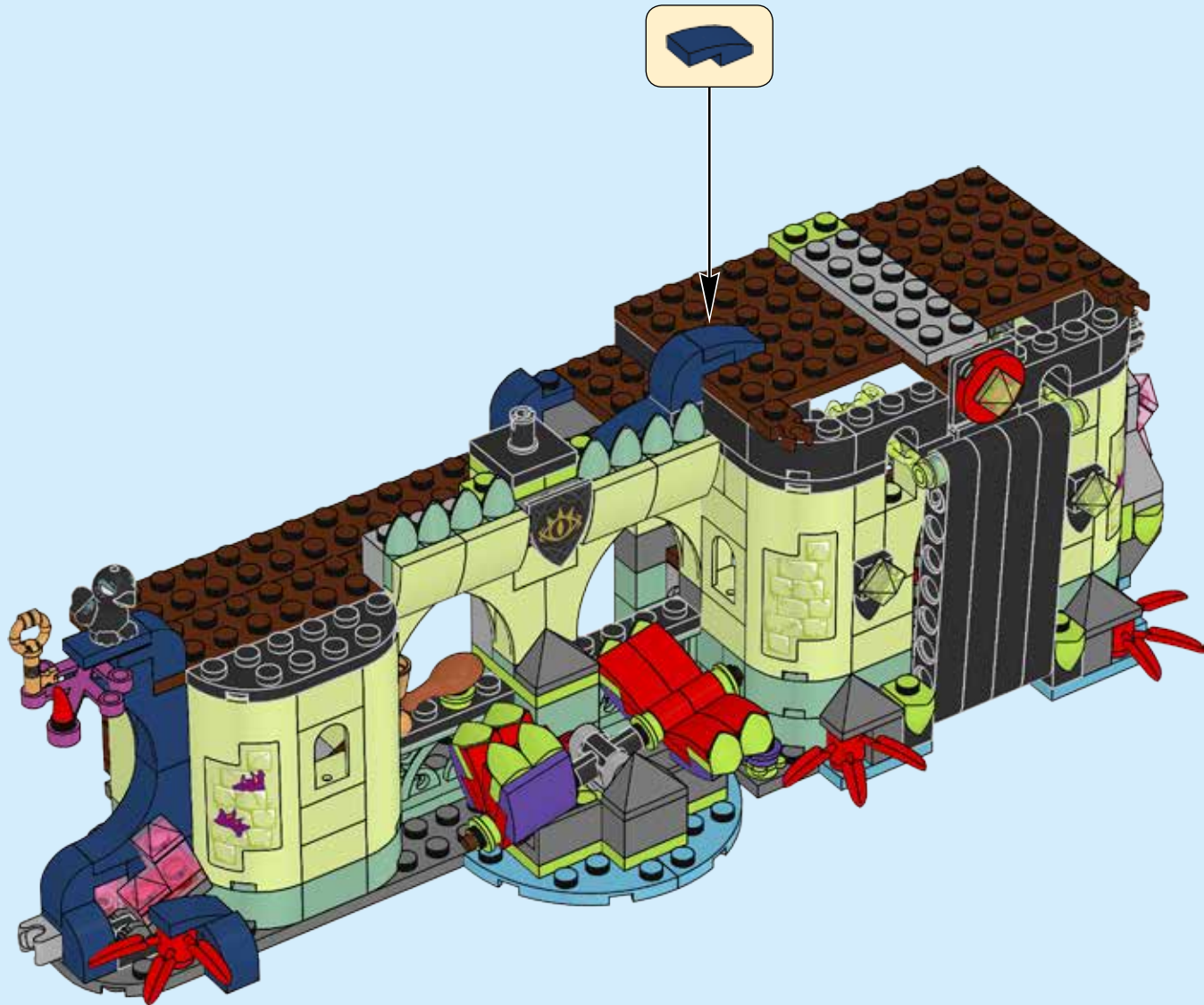

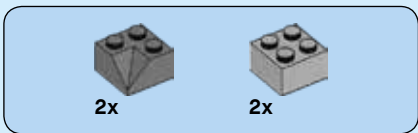

140

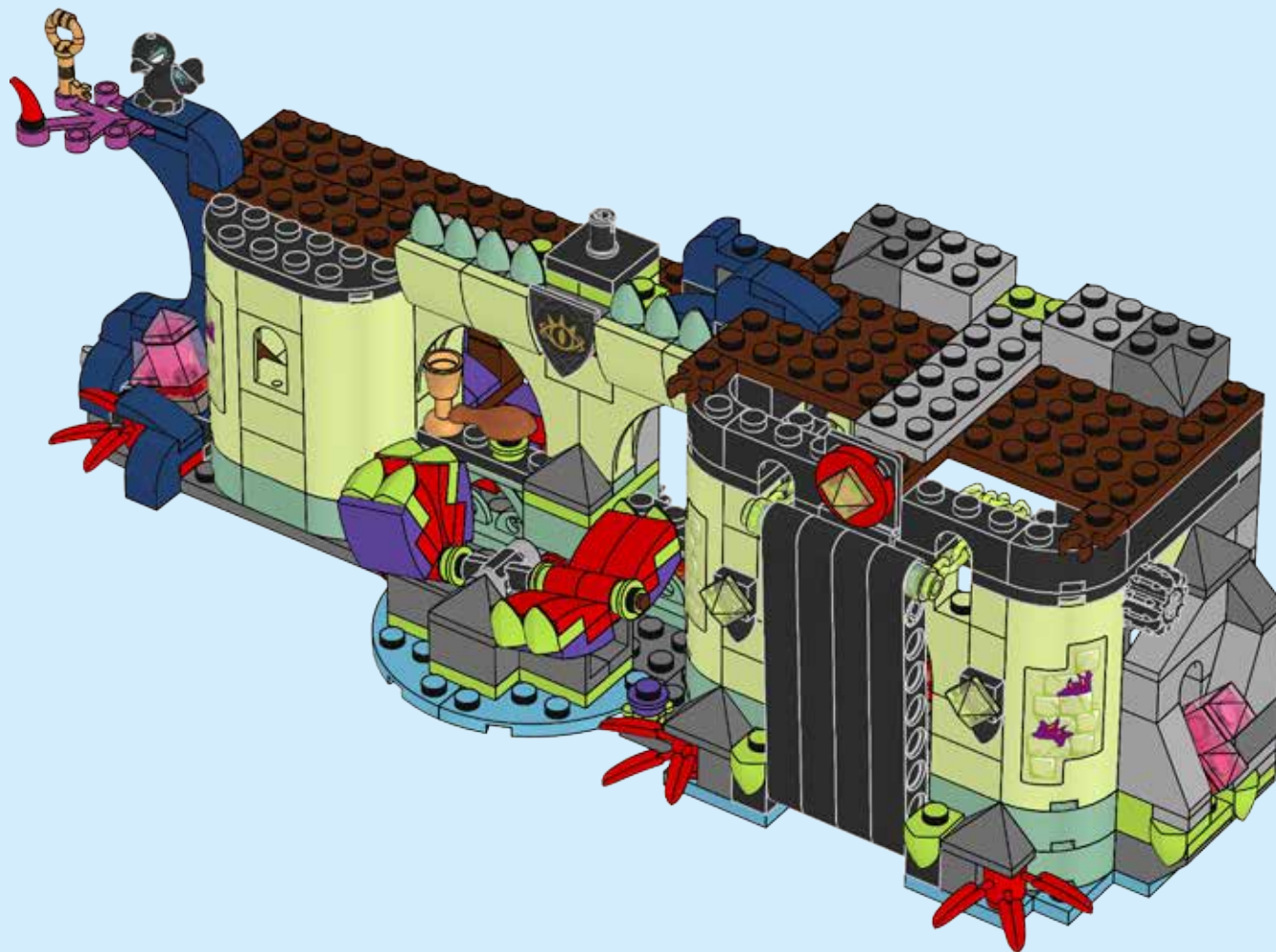

3x
2x
2x

141

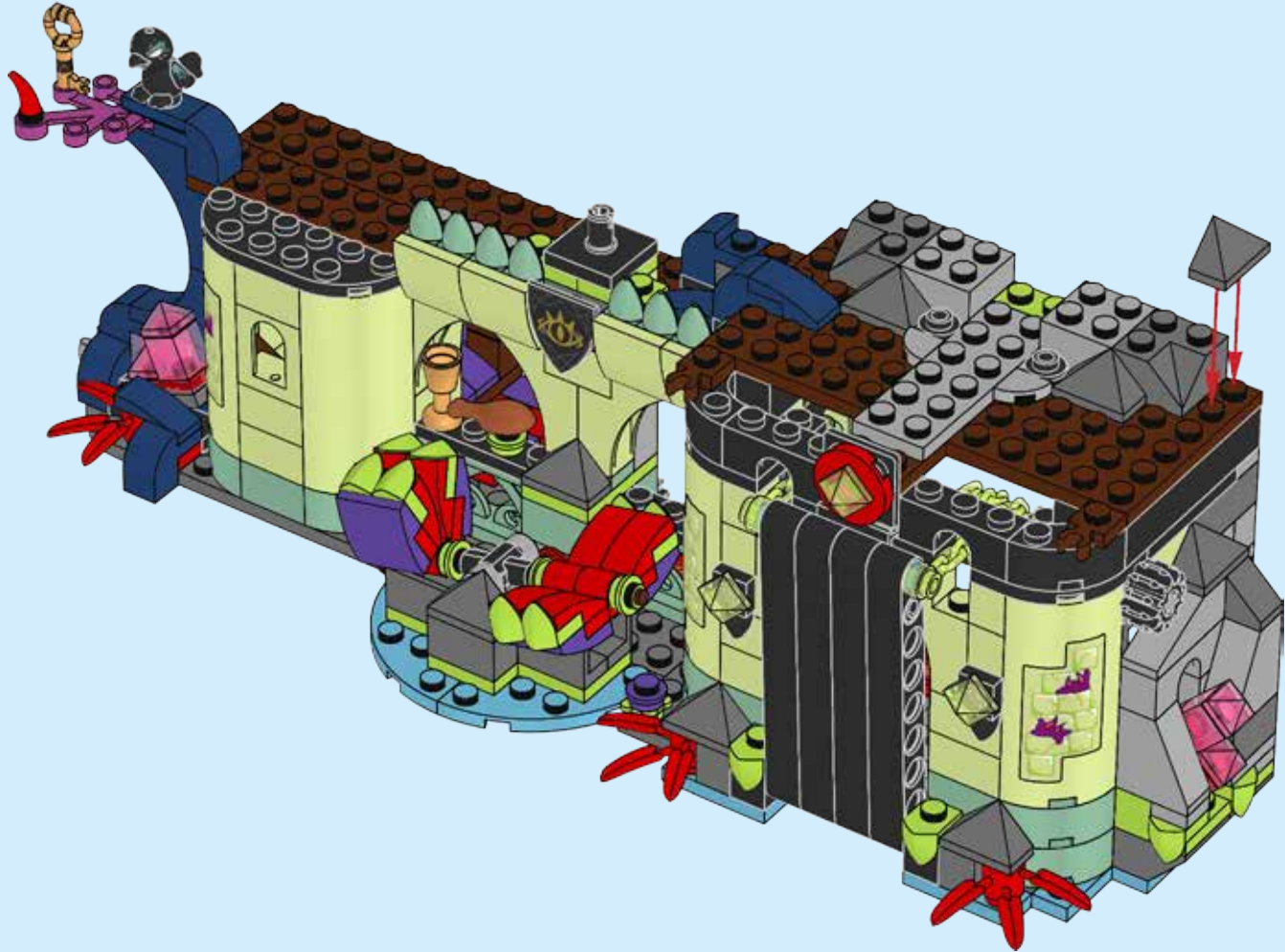



2x

142

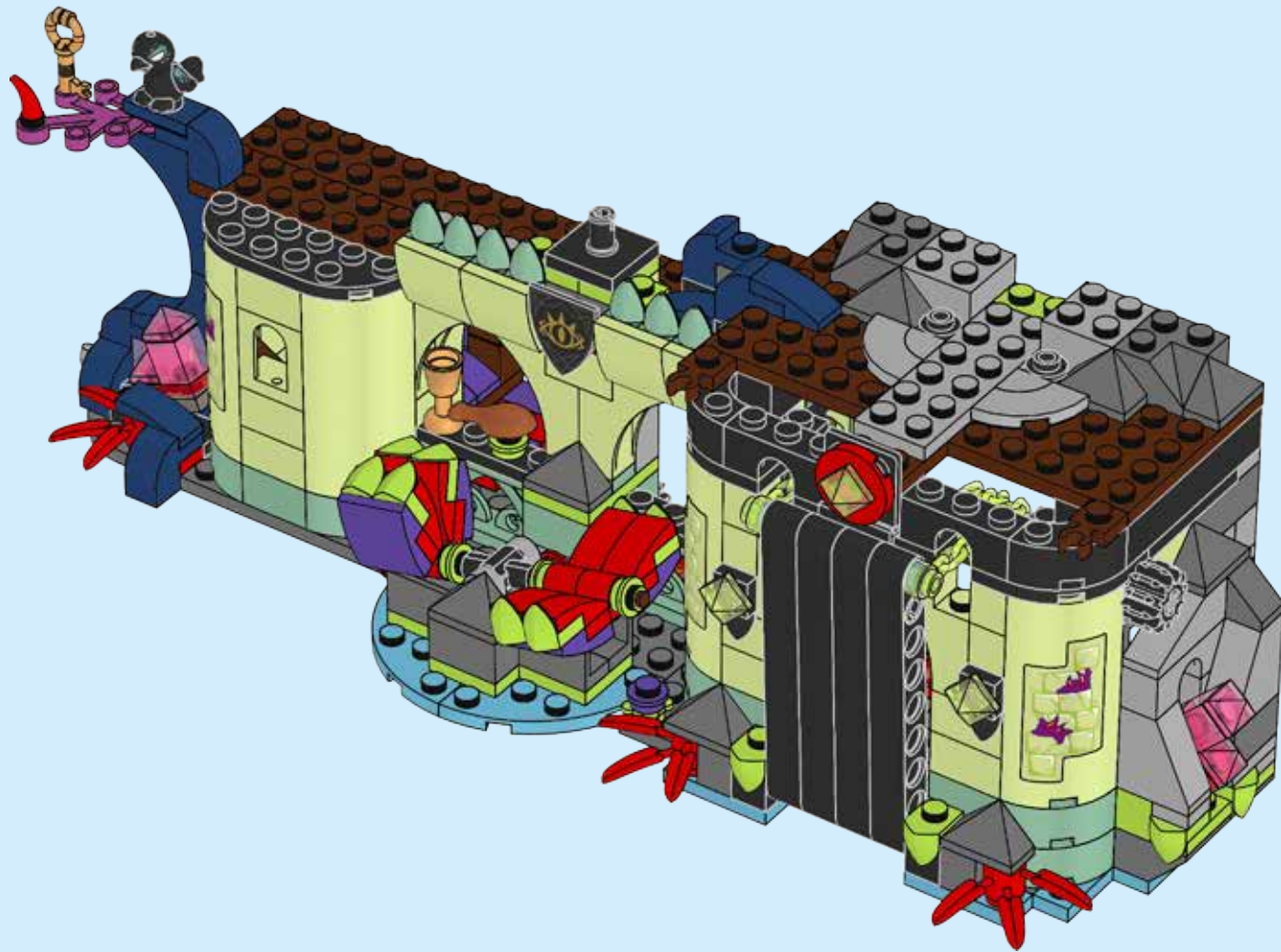



2x



2x

143

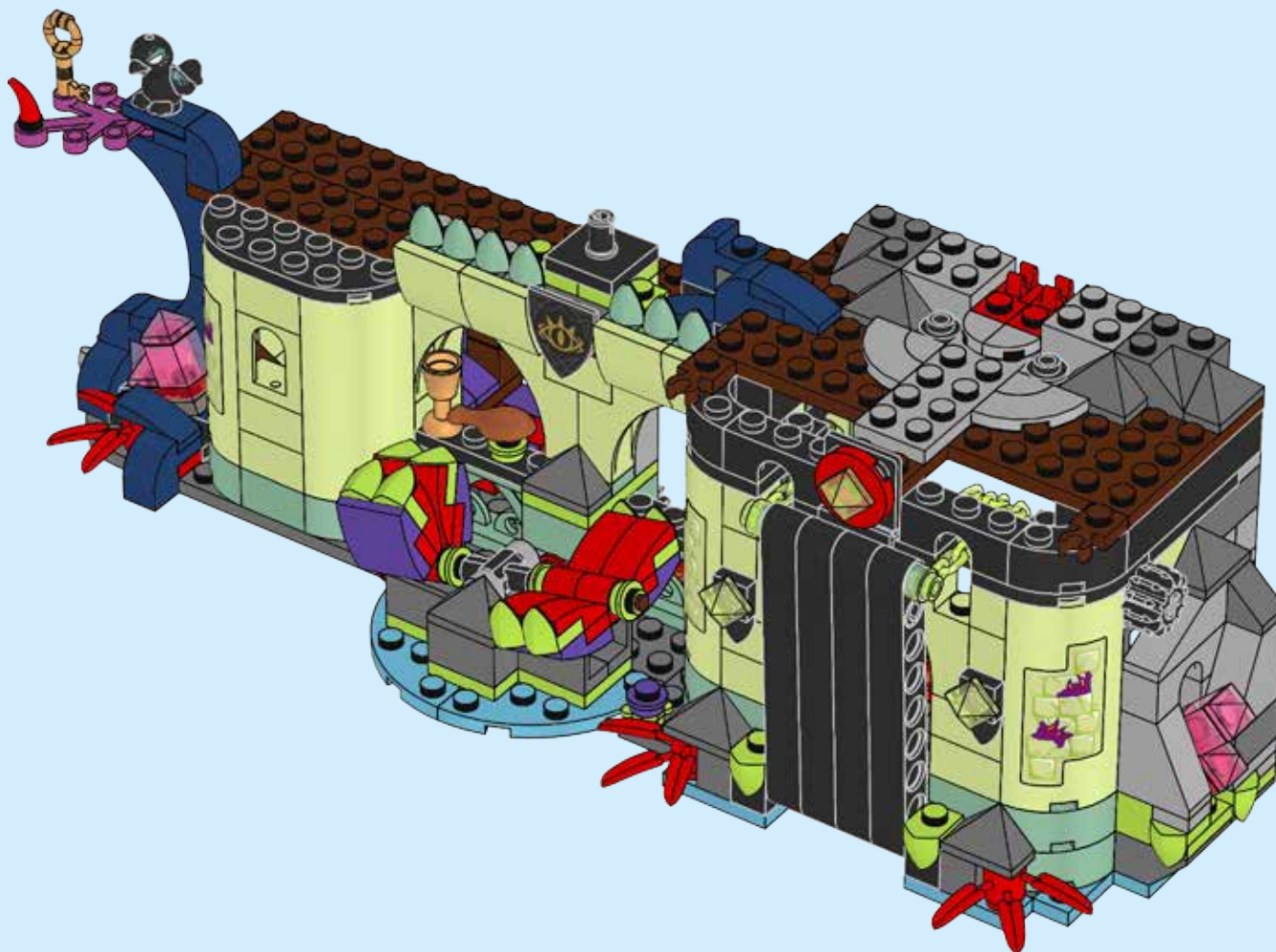



2x

144

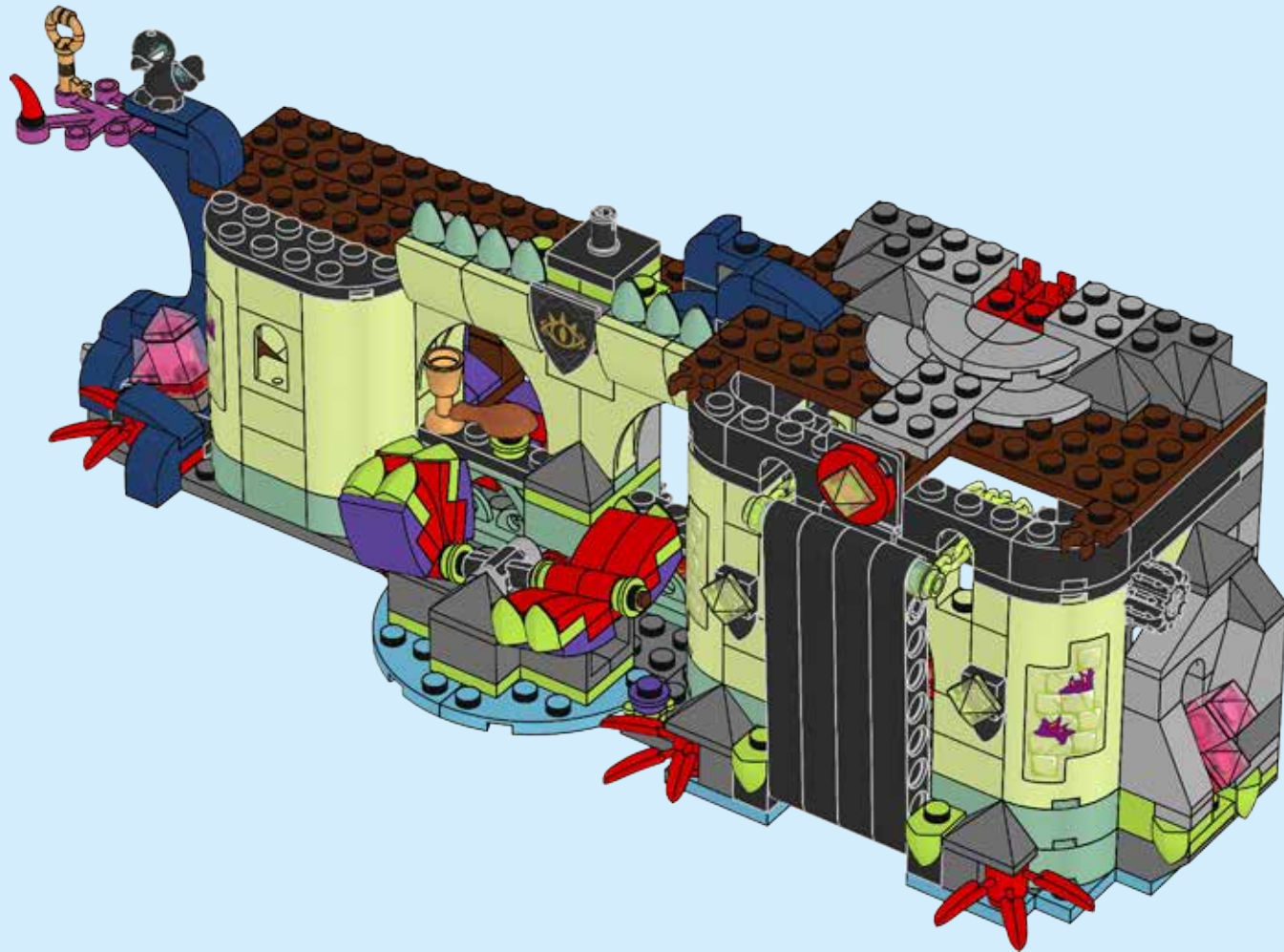

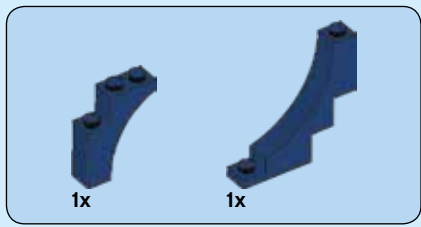

145

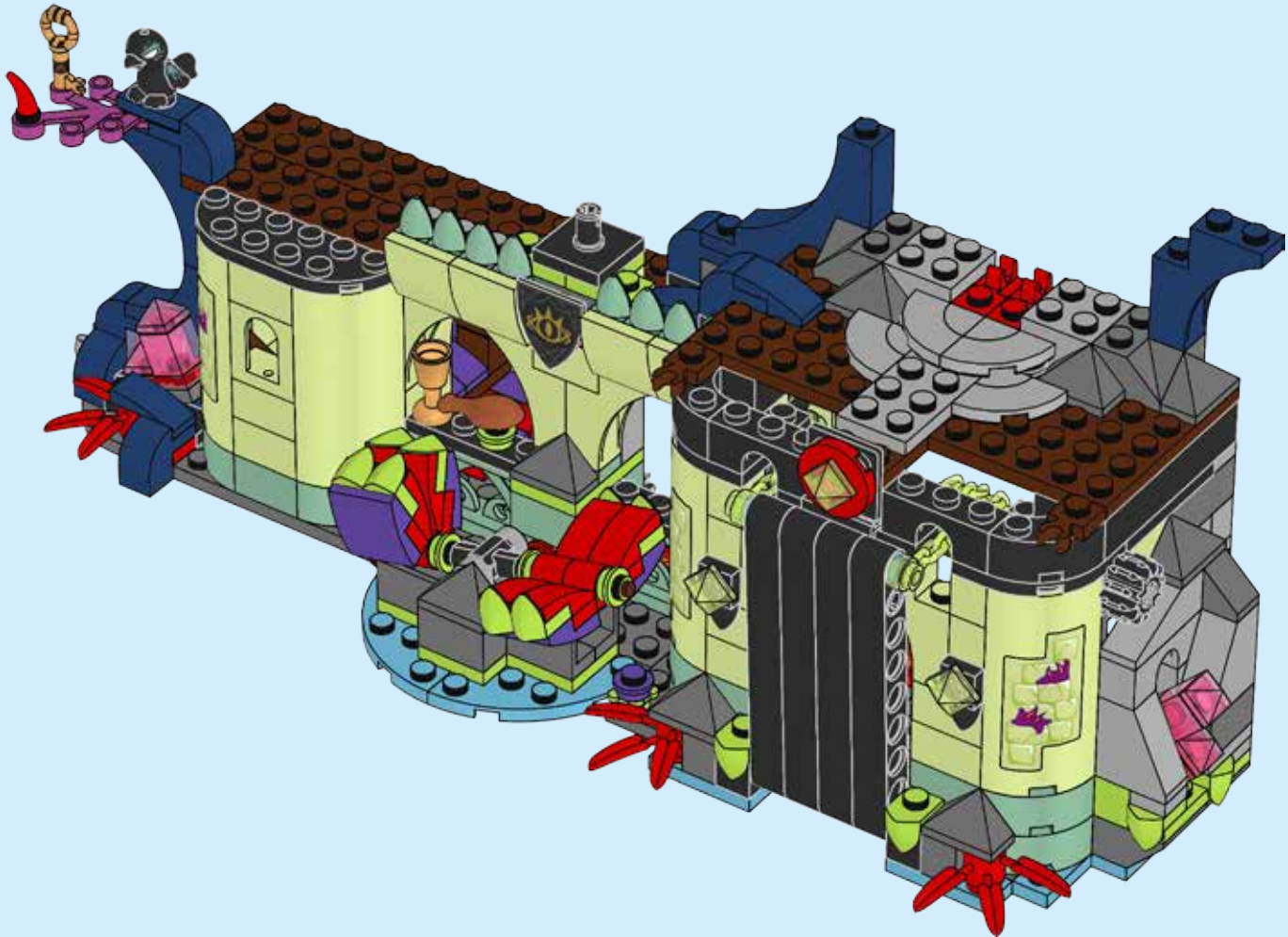

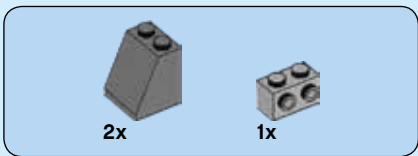

146

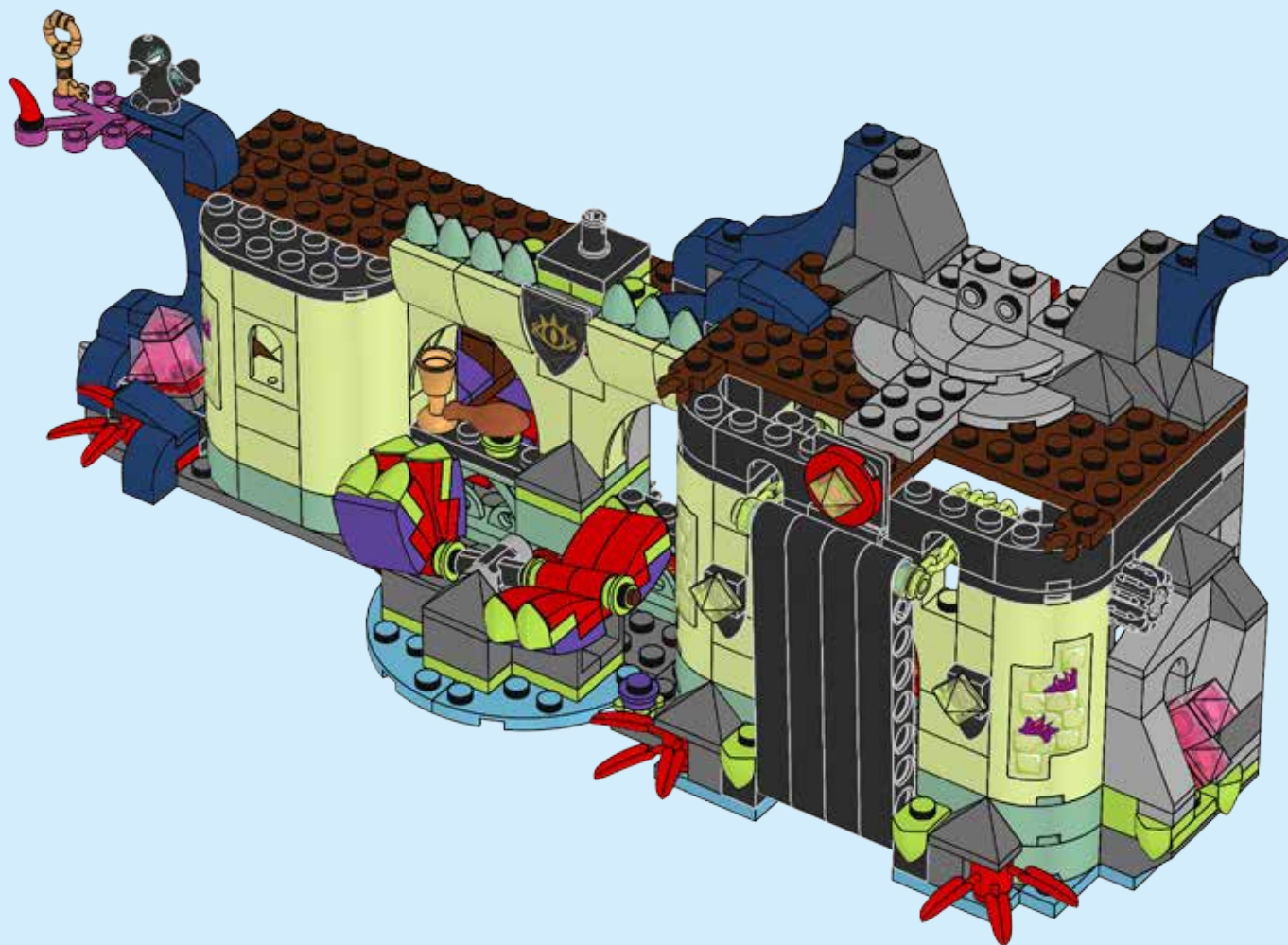



2x

147

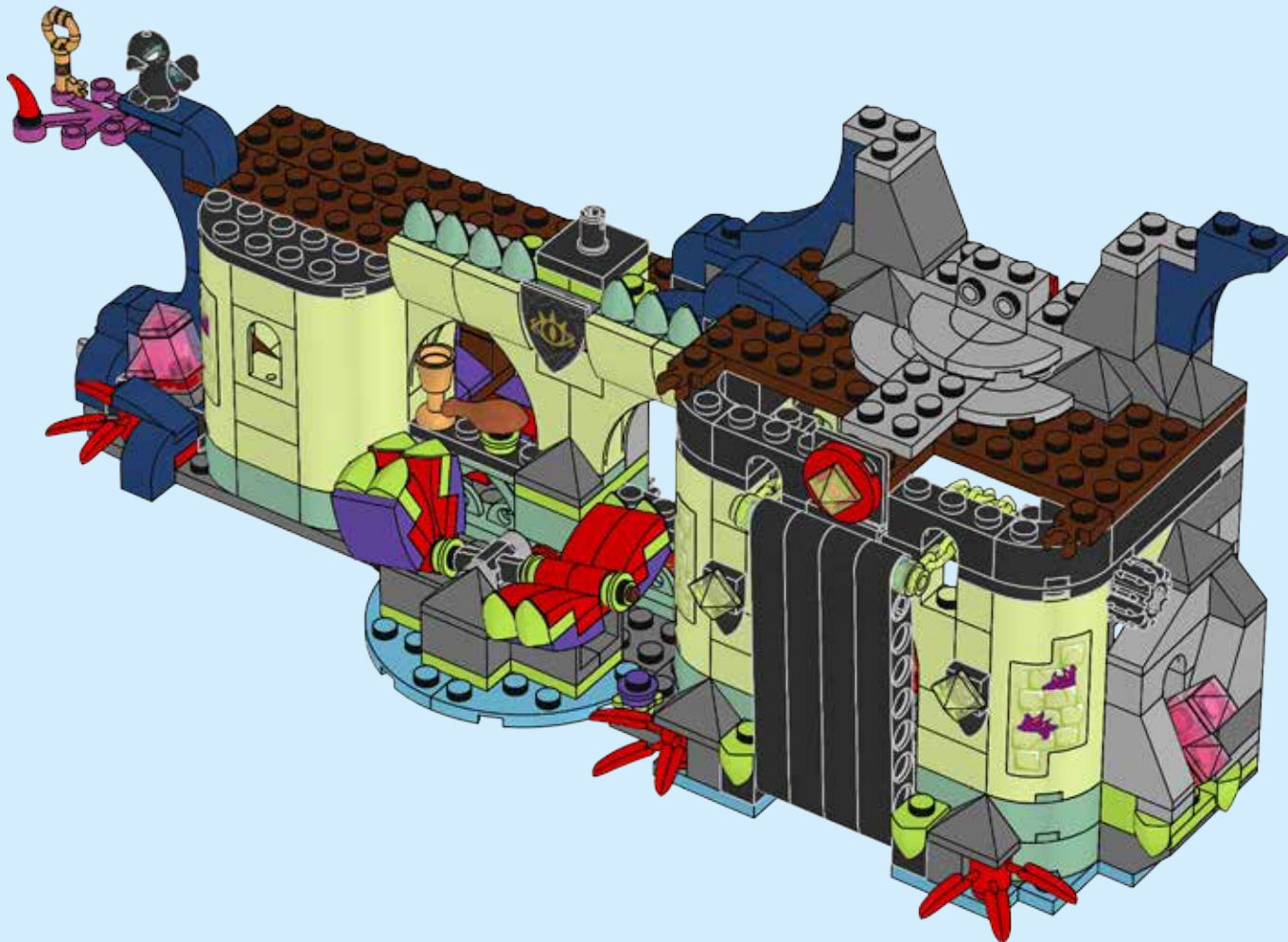



2x



2x

148

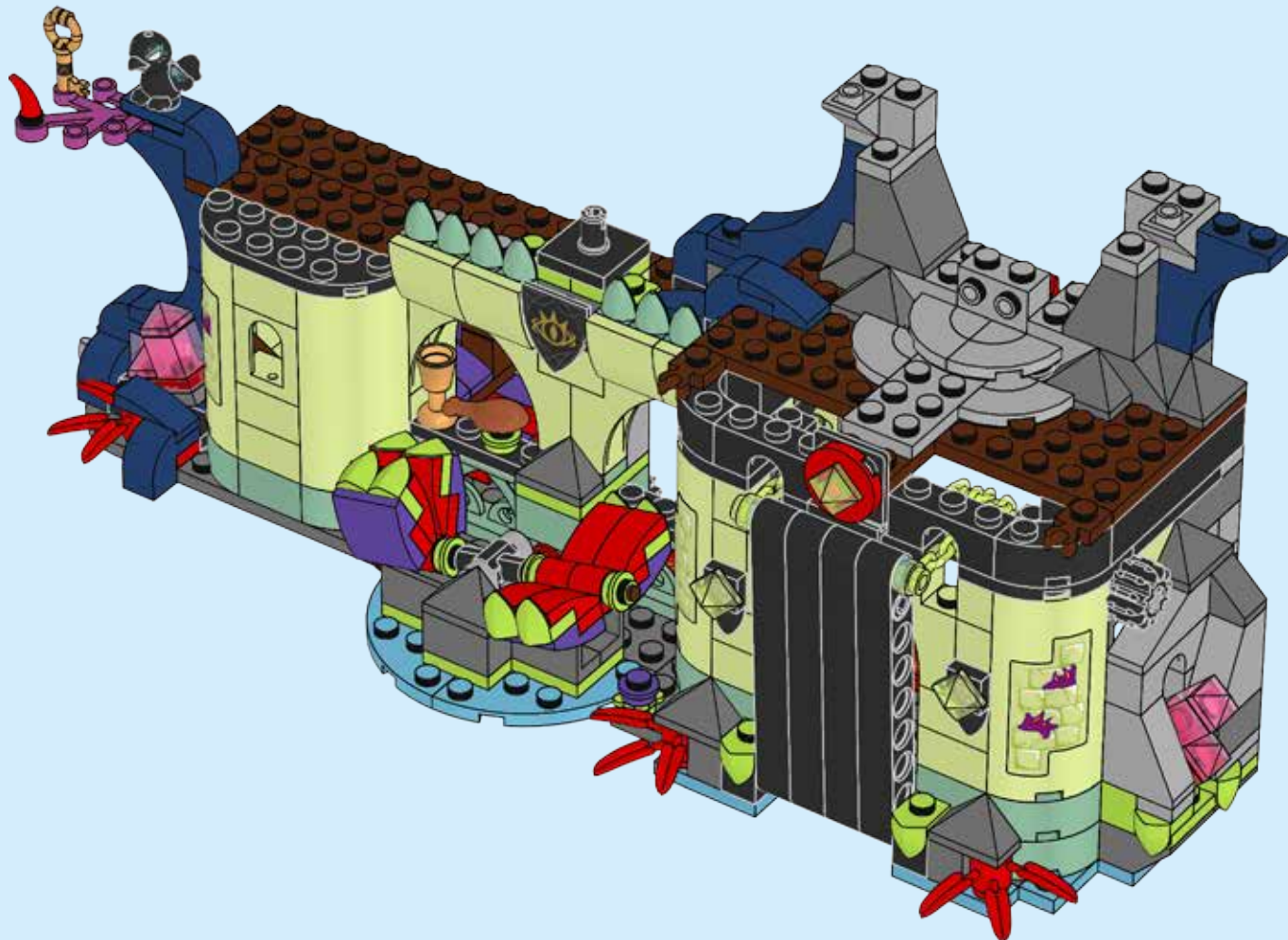

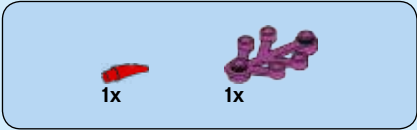

149

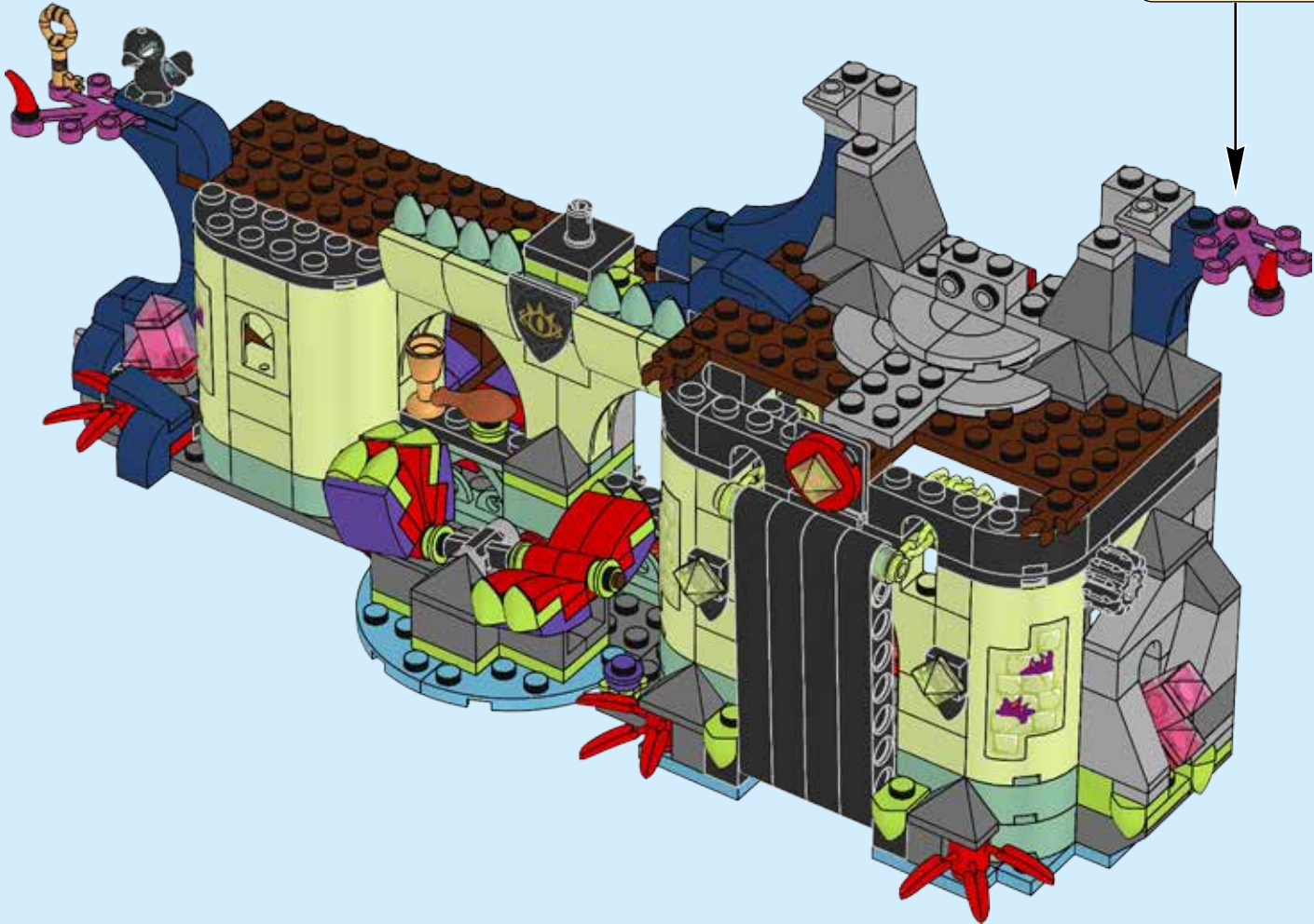
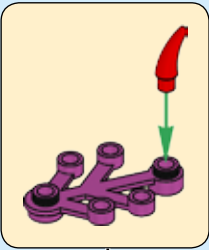



2x



1x

150

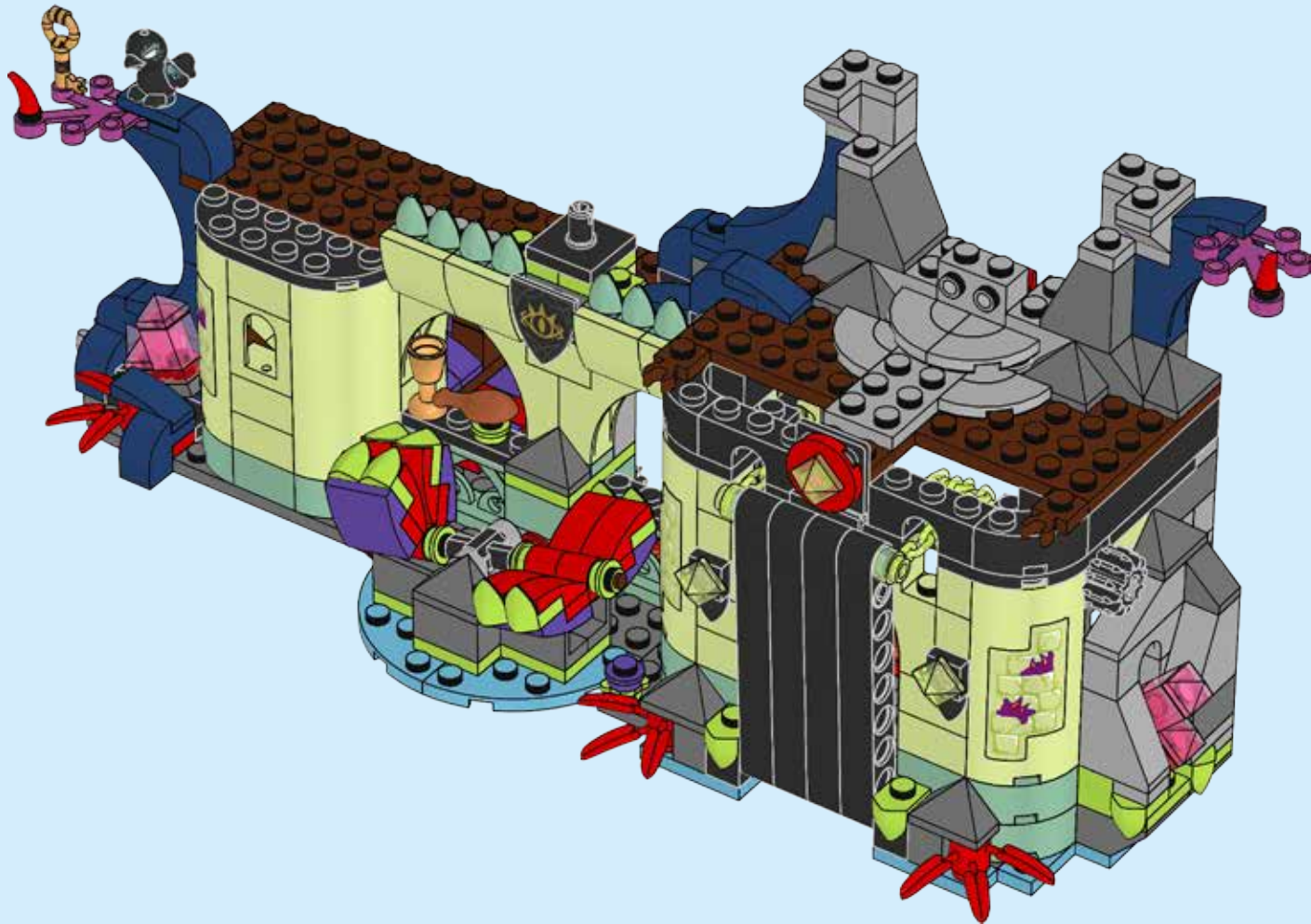

2x  2x 

151

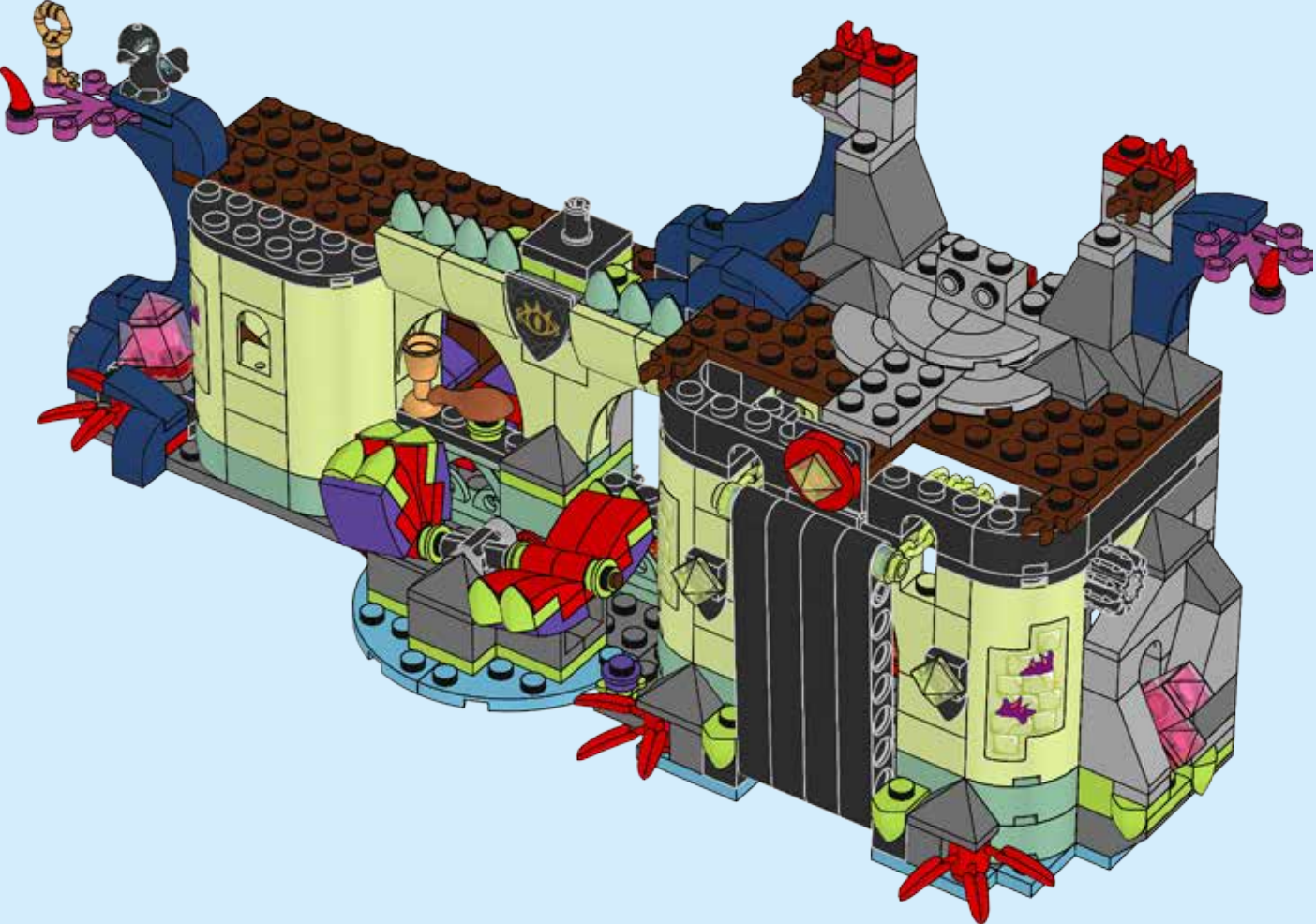



2x

152

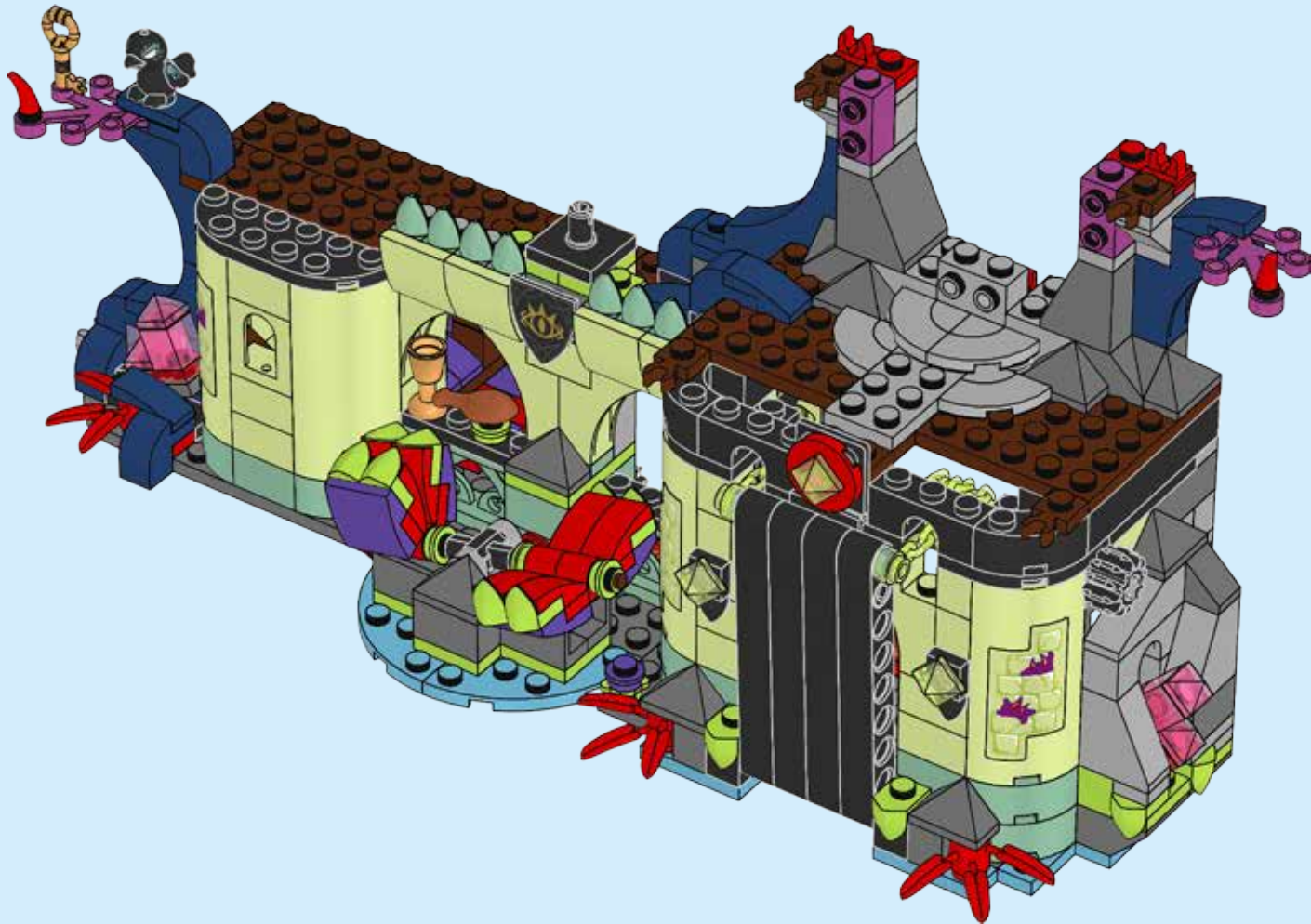



2x

153

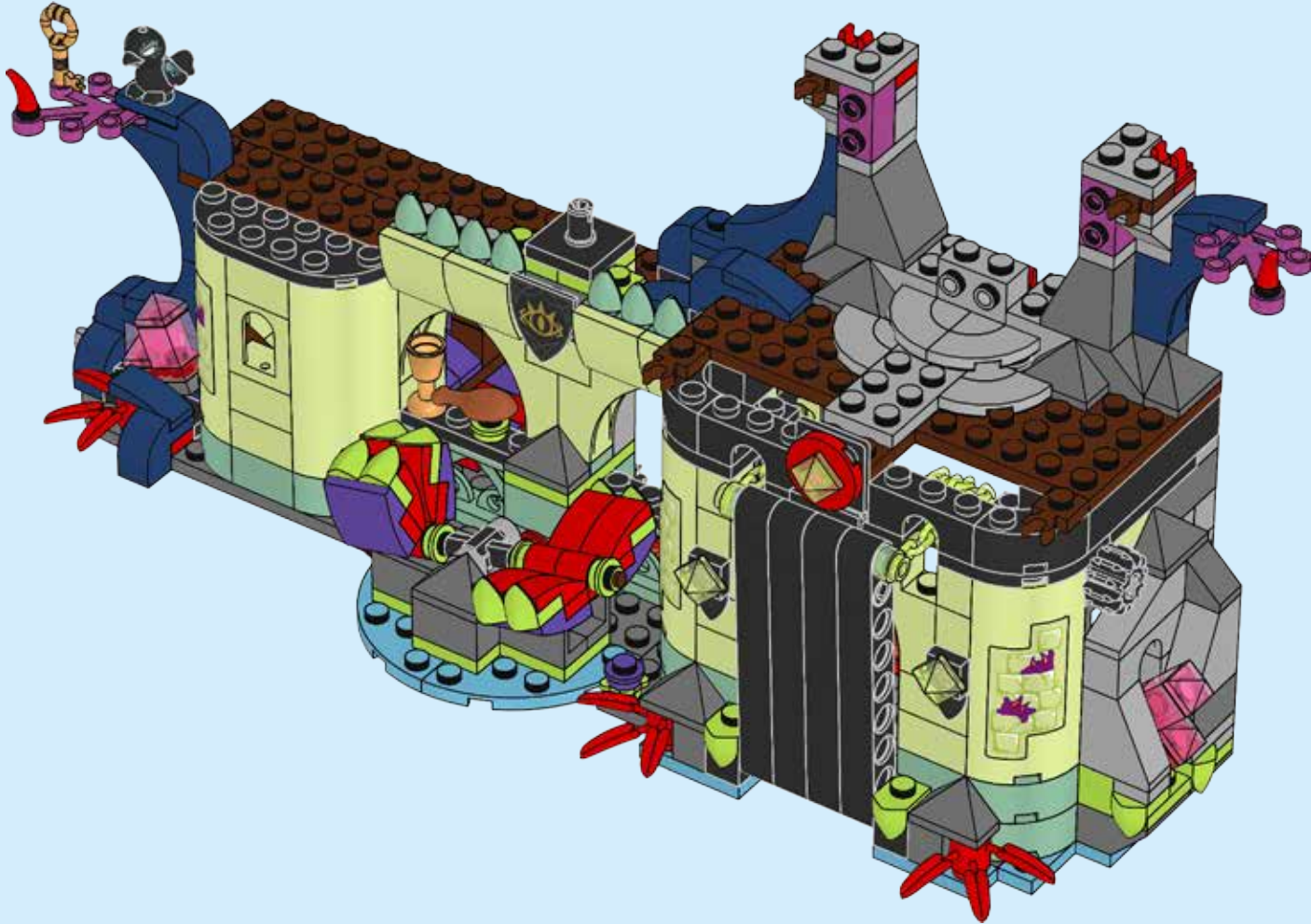

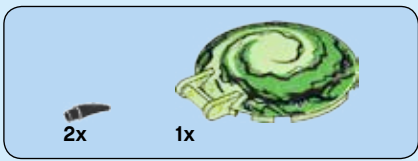

154

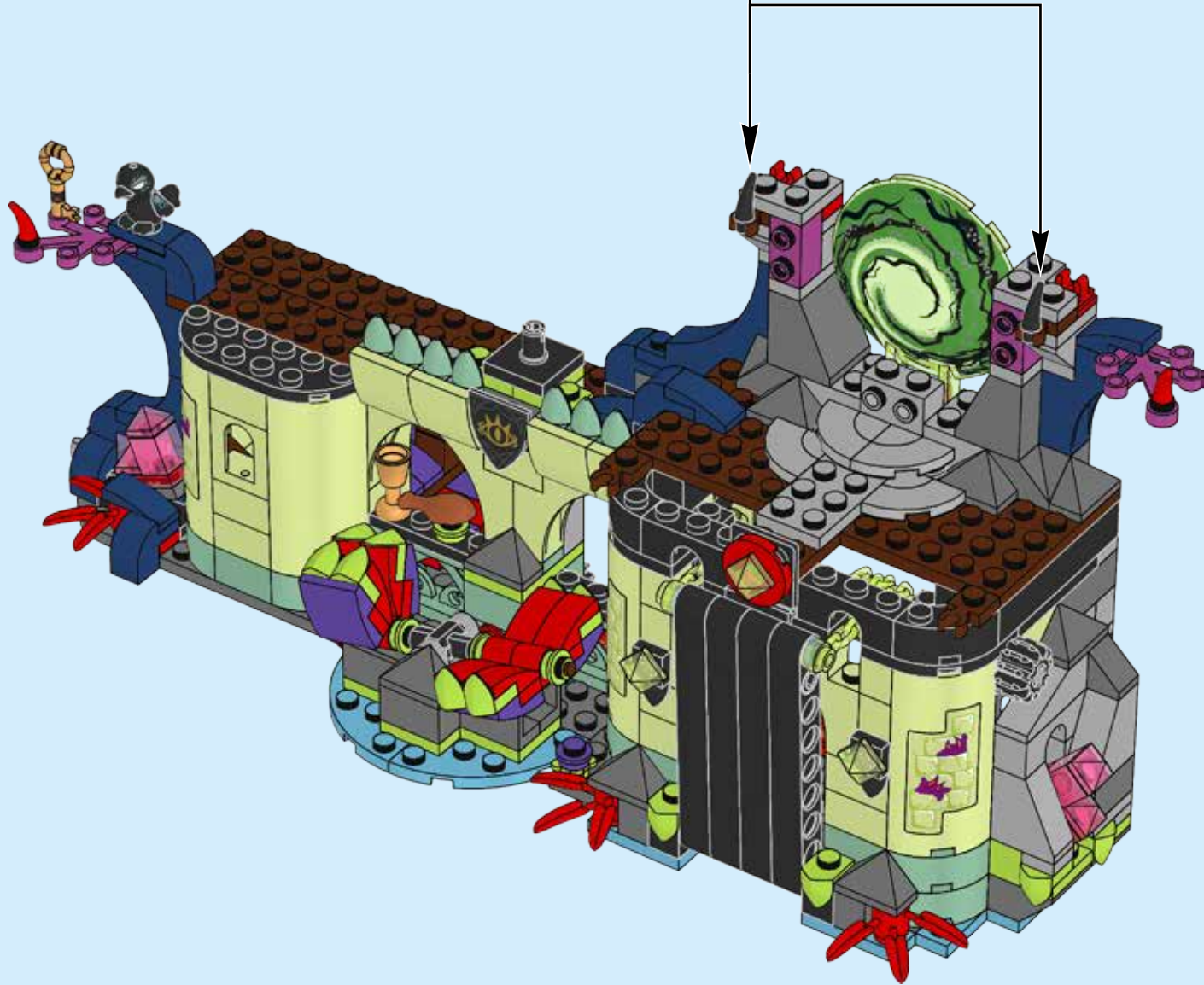
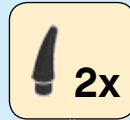

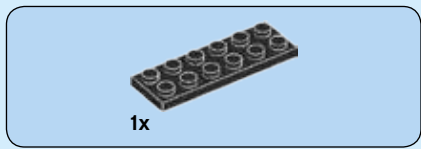

155

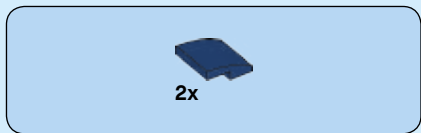
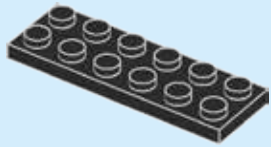

156

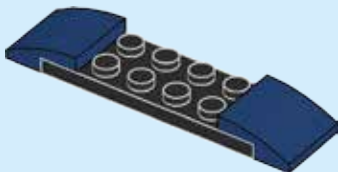

157

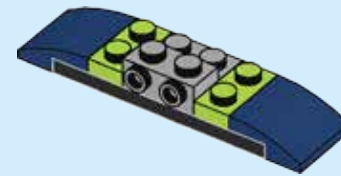

158

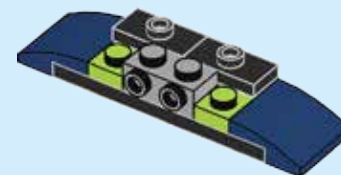

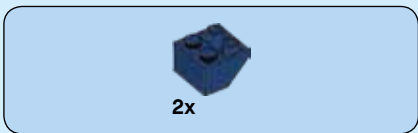

159

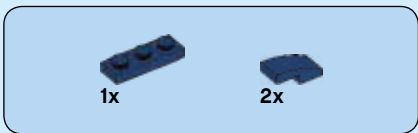

160

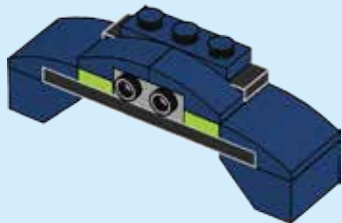
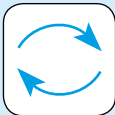

161

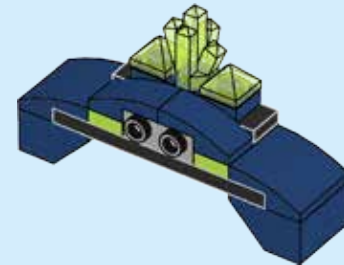

162

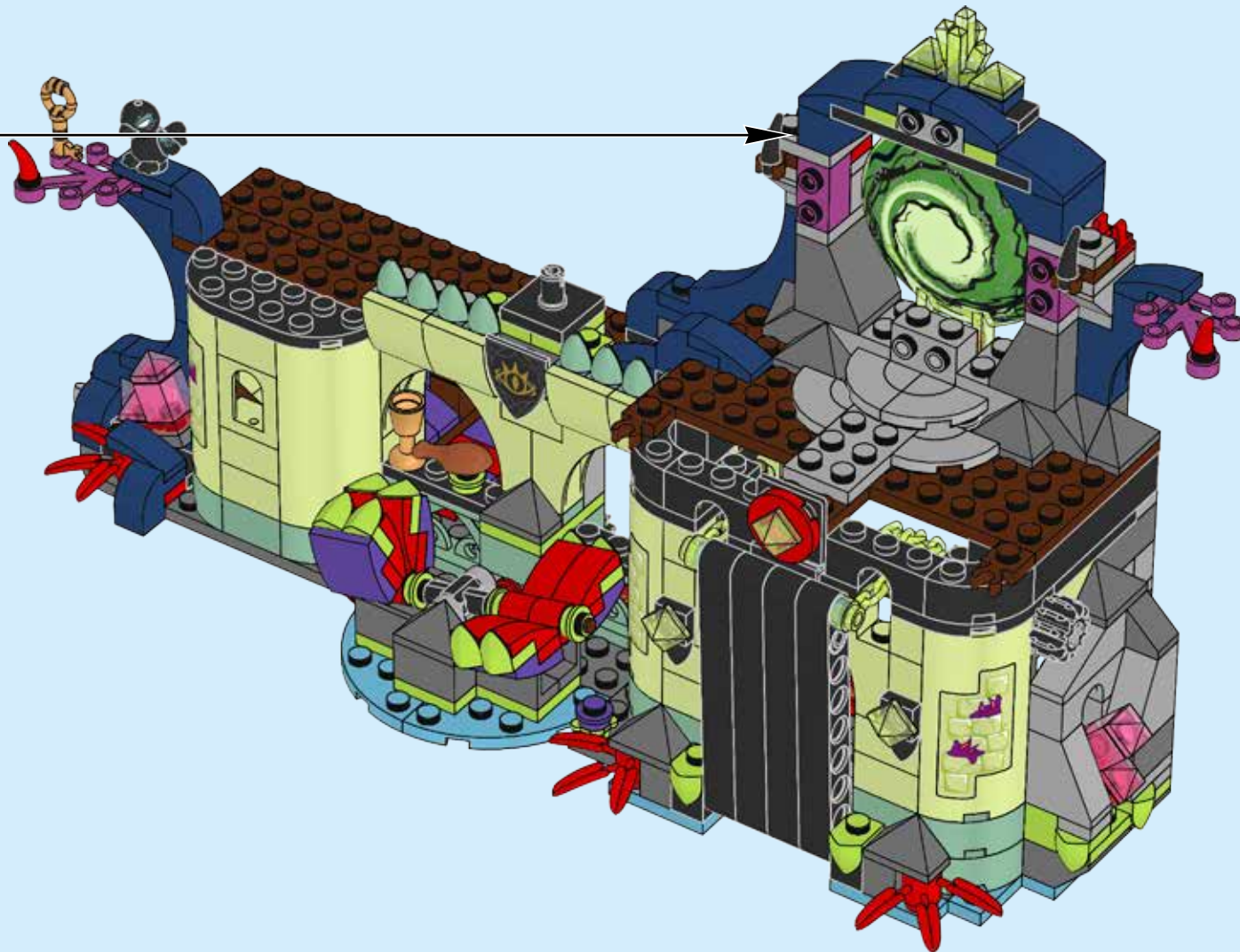

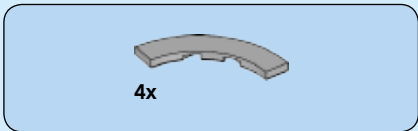

163

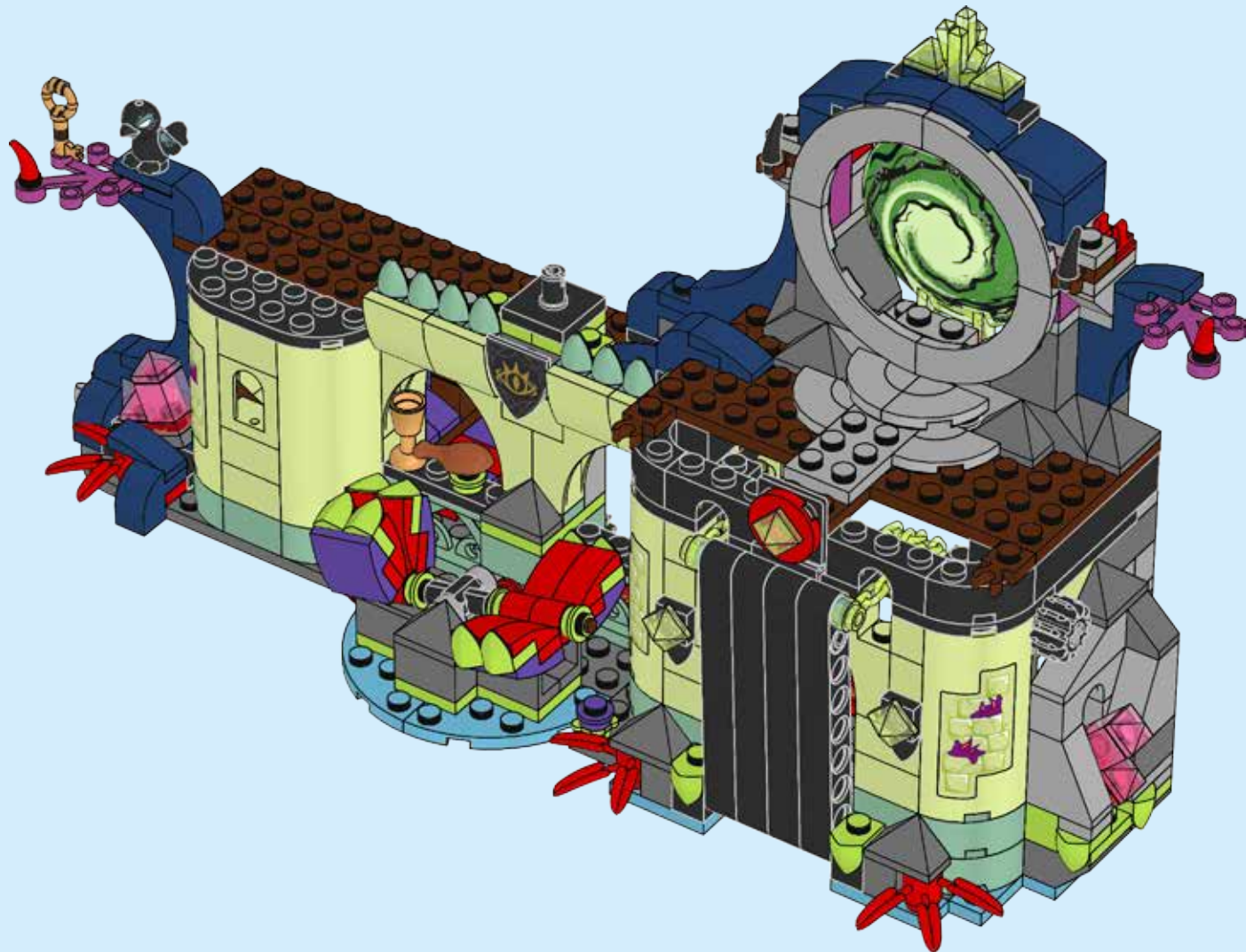

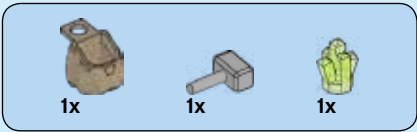

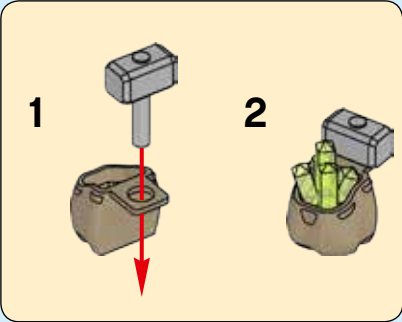
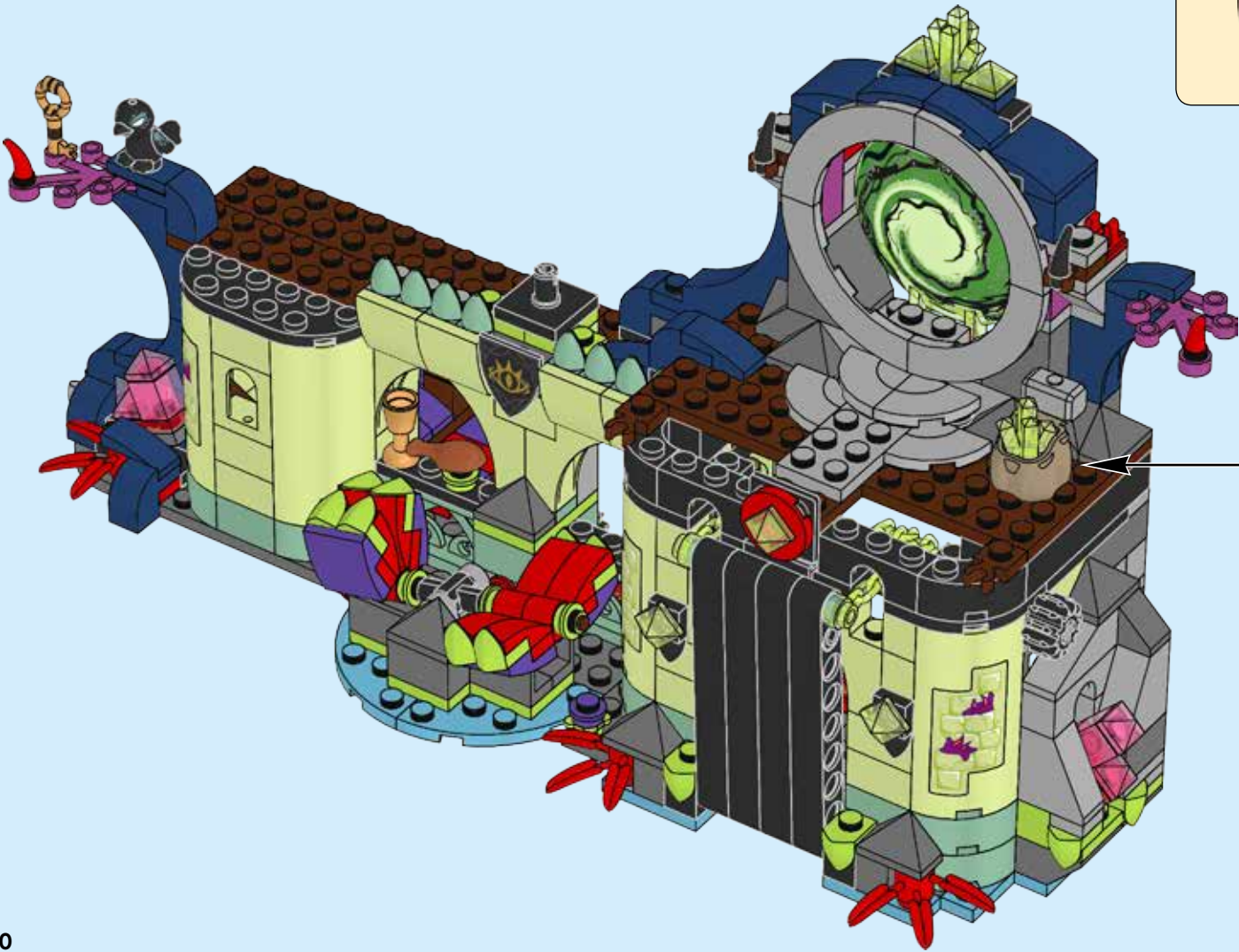

164

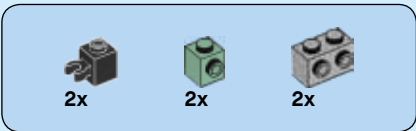

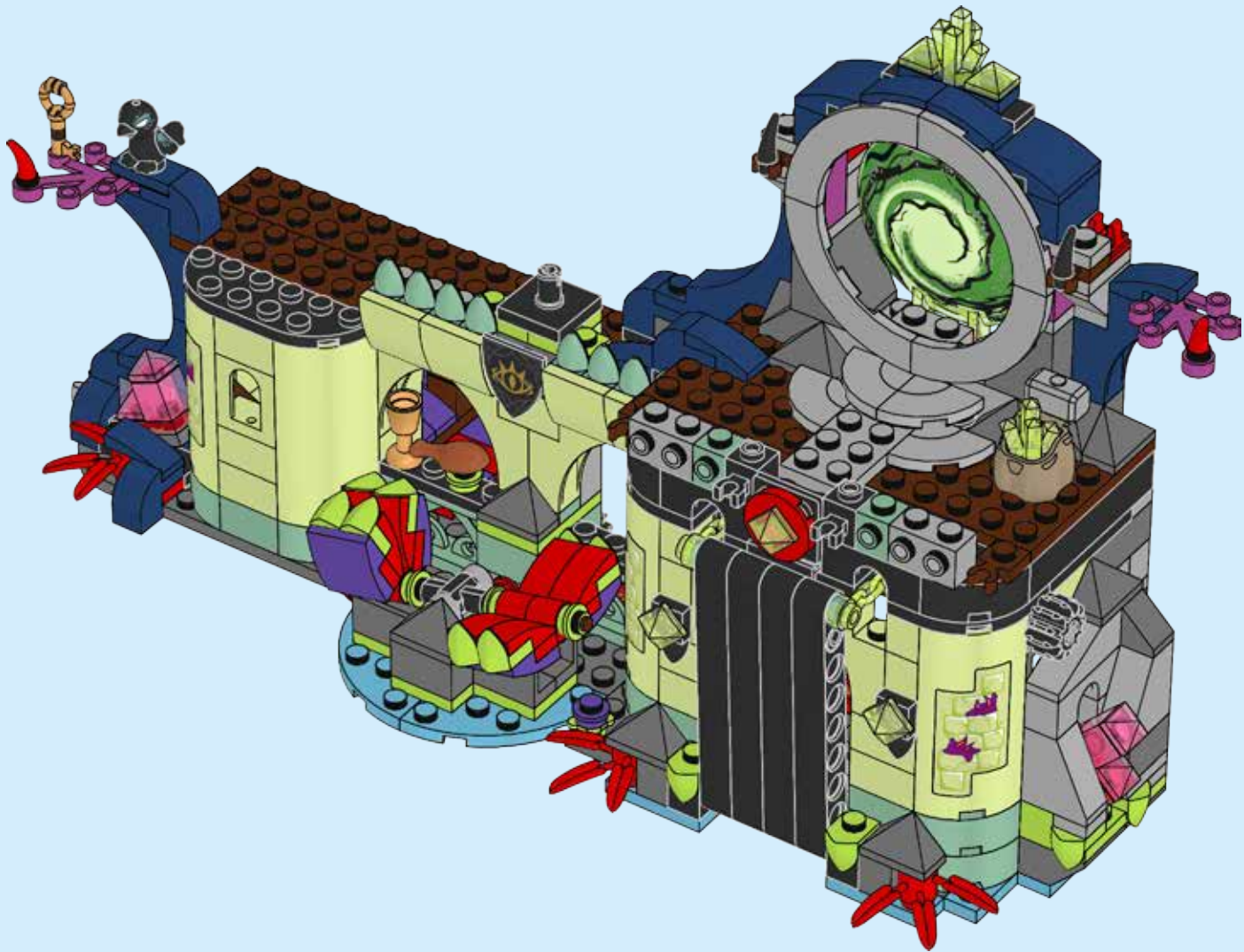

165



2x  4x 

166

1  2  2x

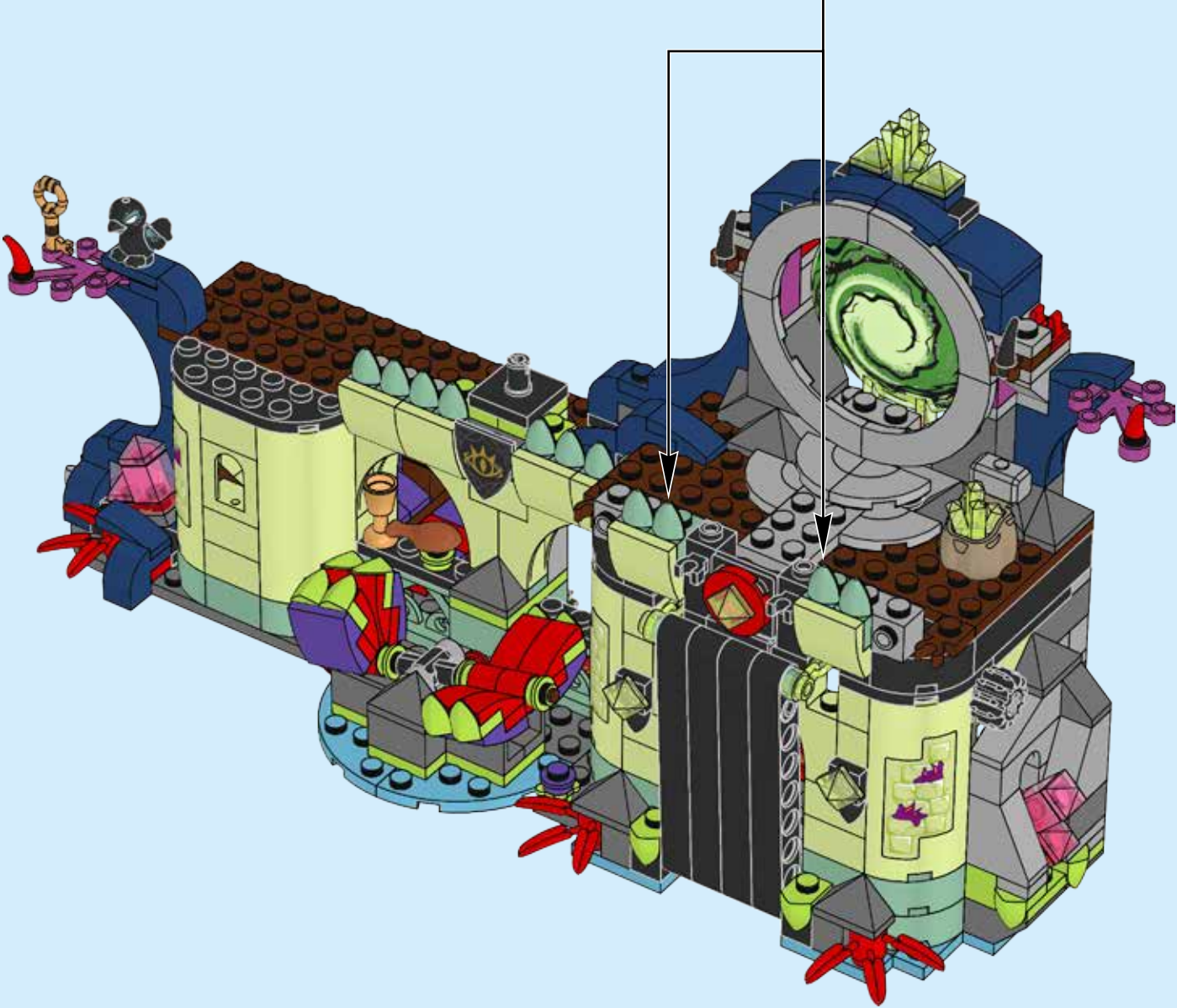

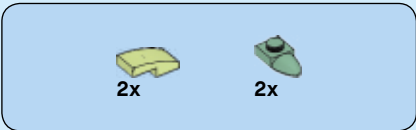

167

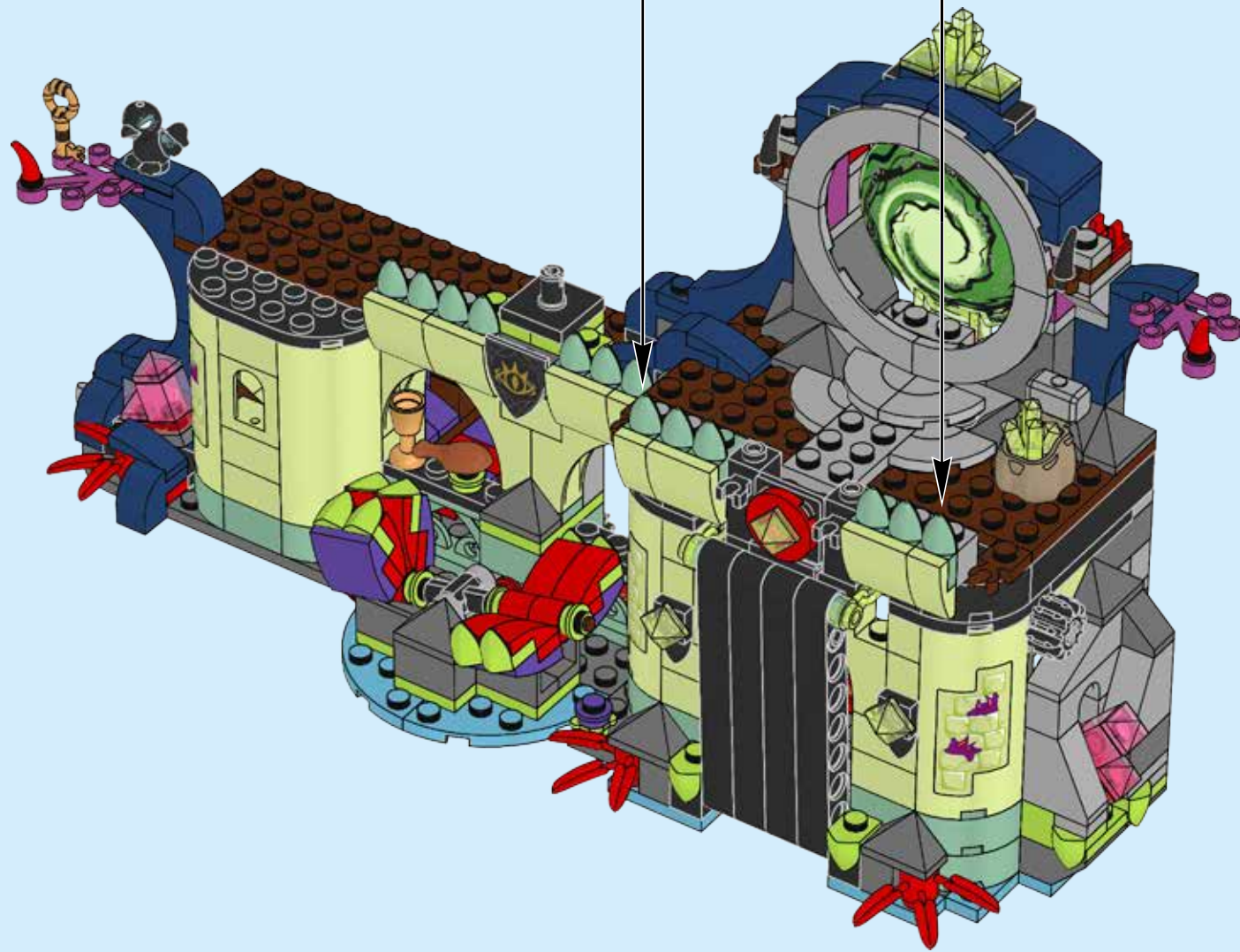
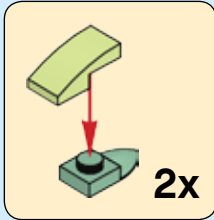

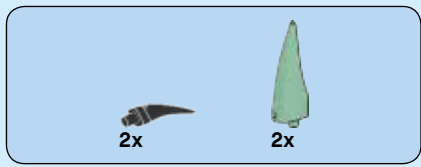

168

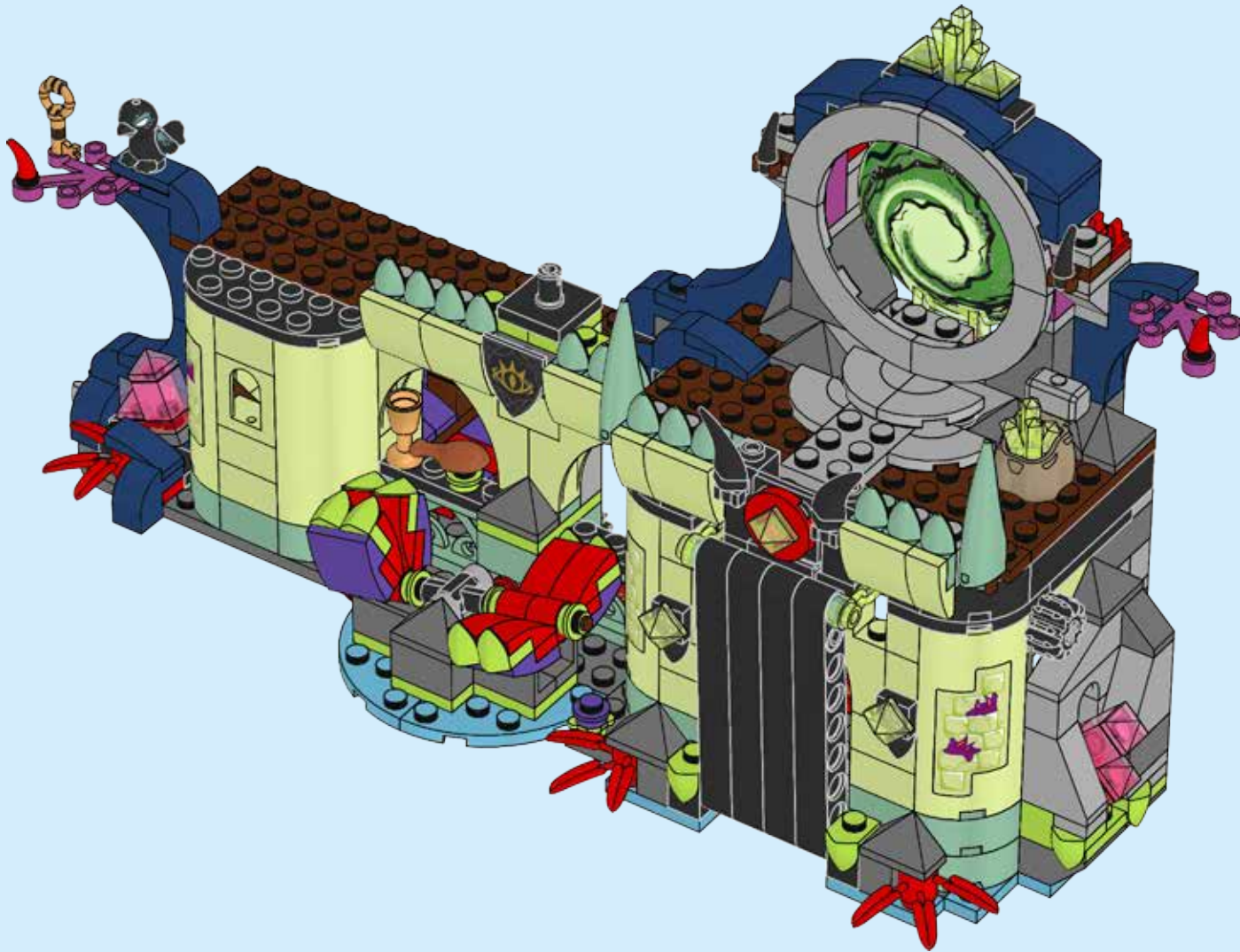



169

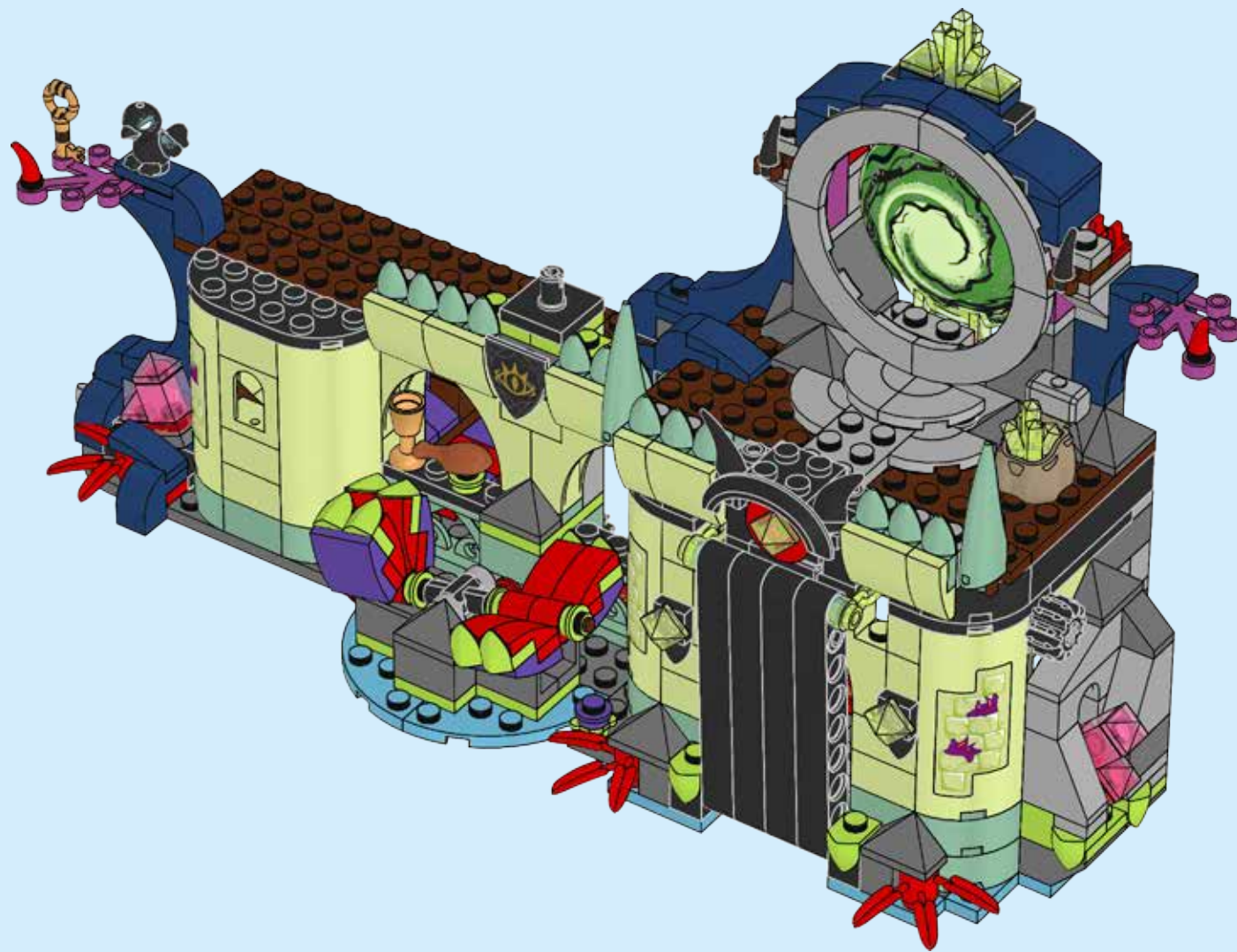



2x

170

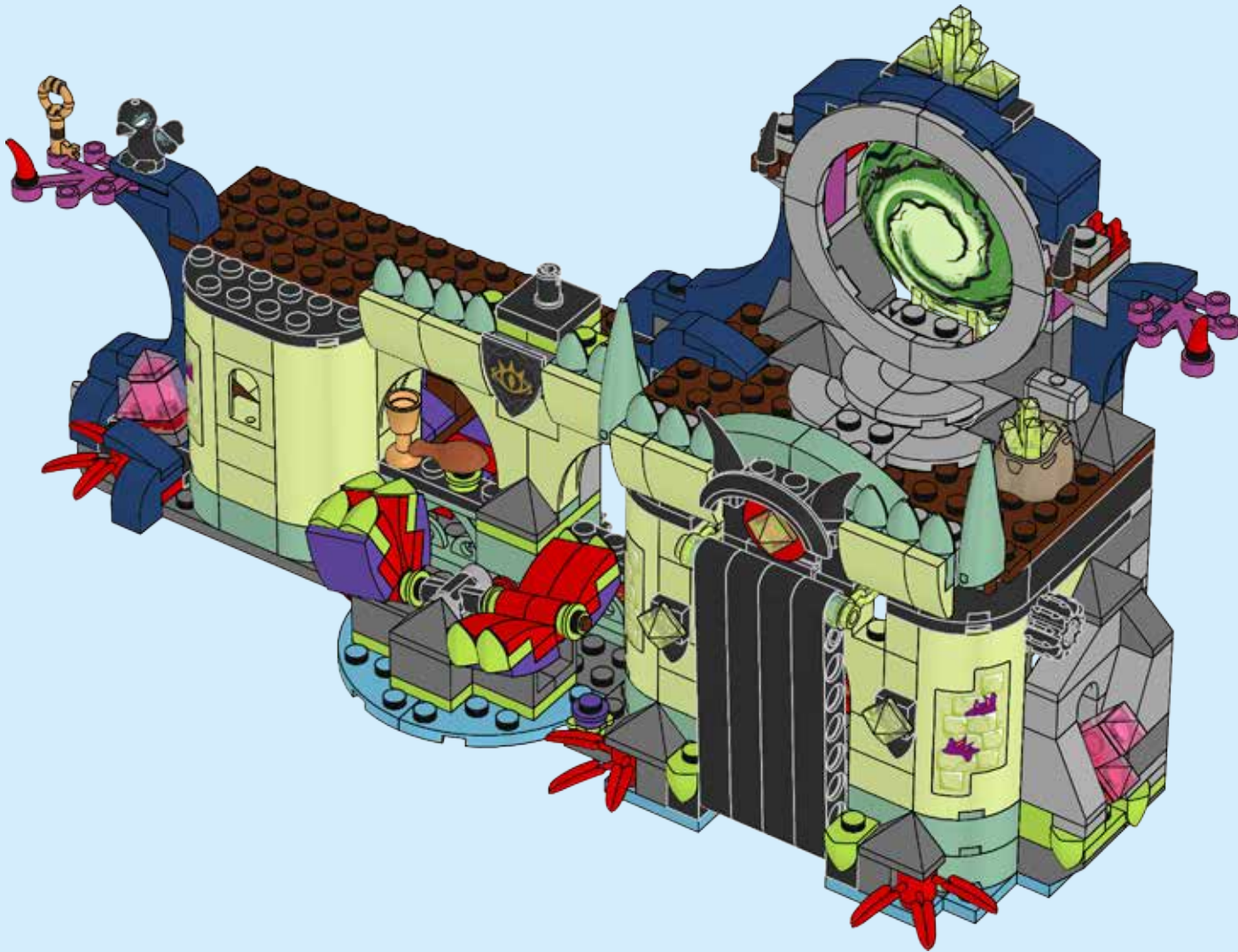



171

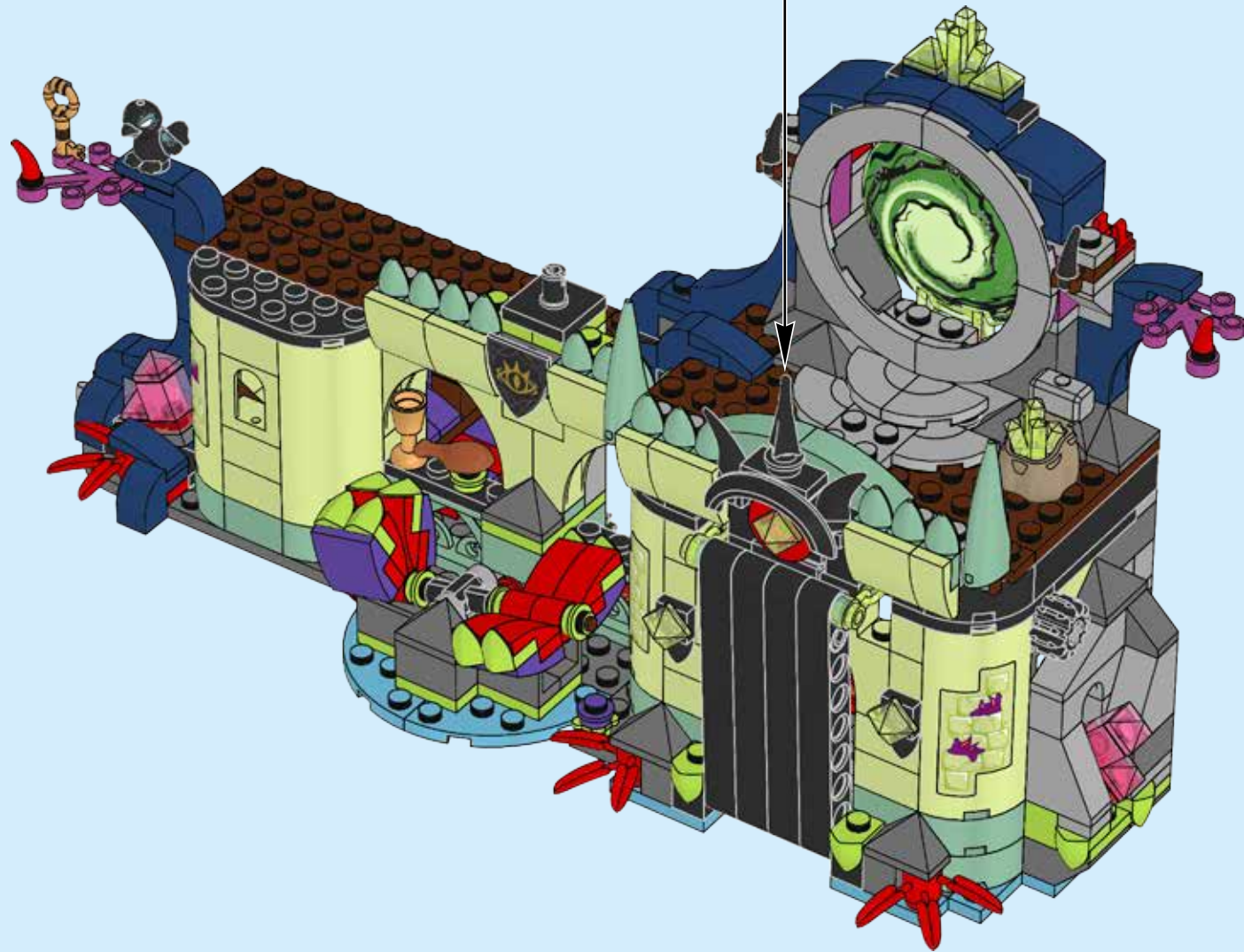
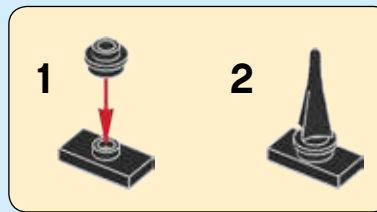



2x



2x

172



2x

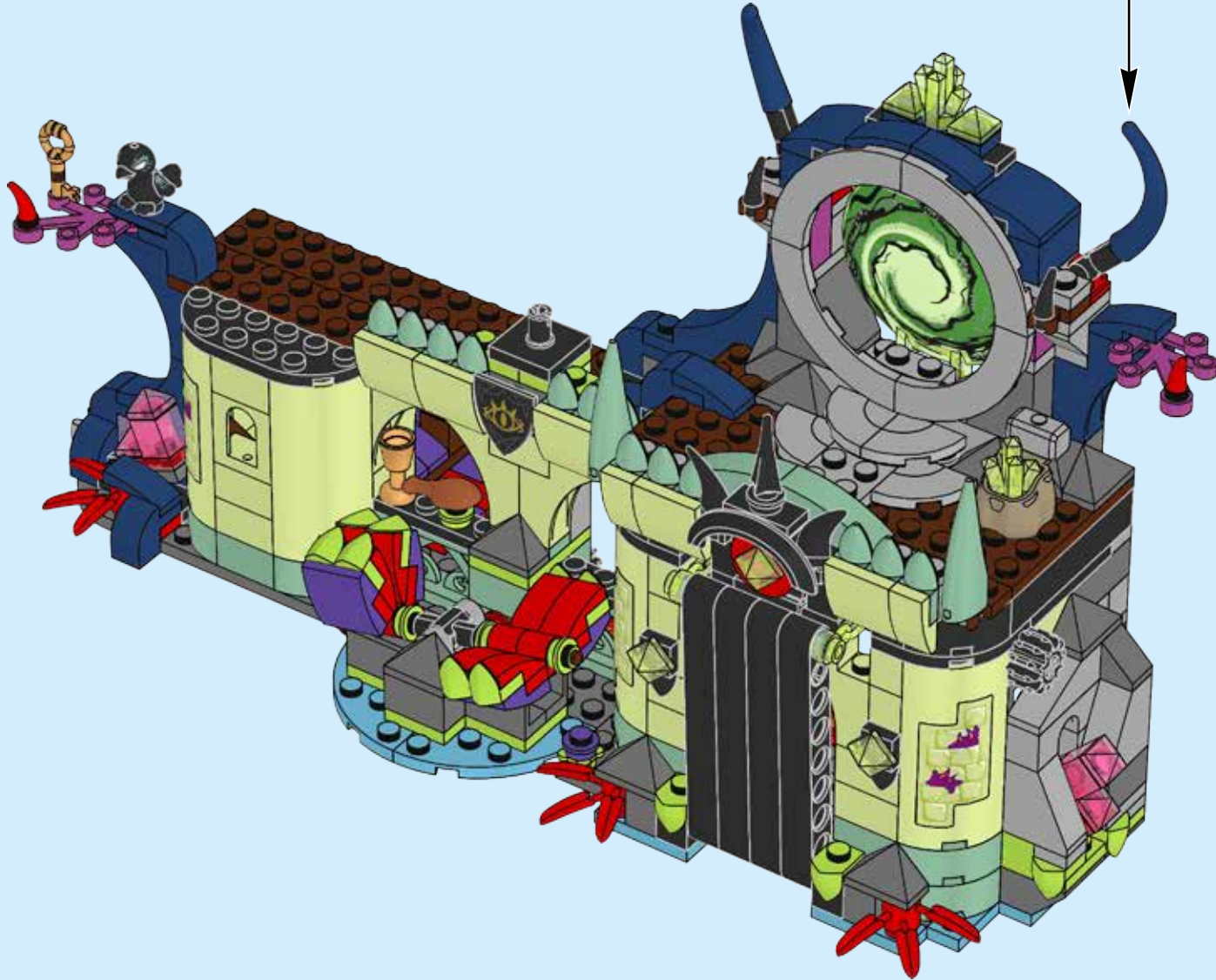

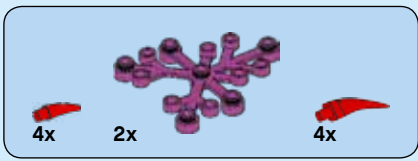

173

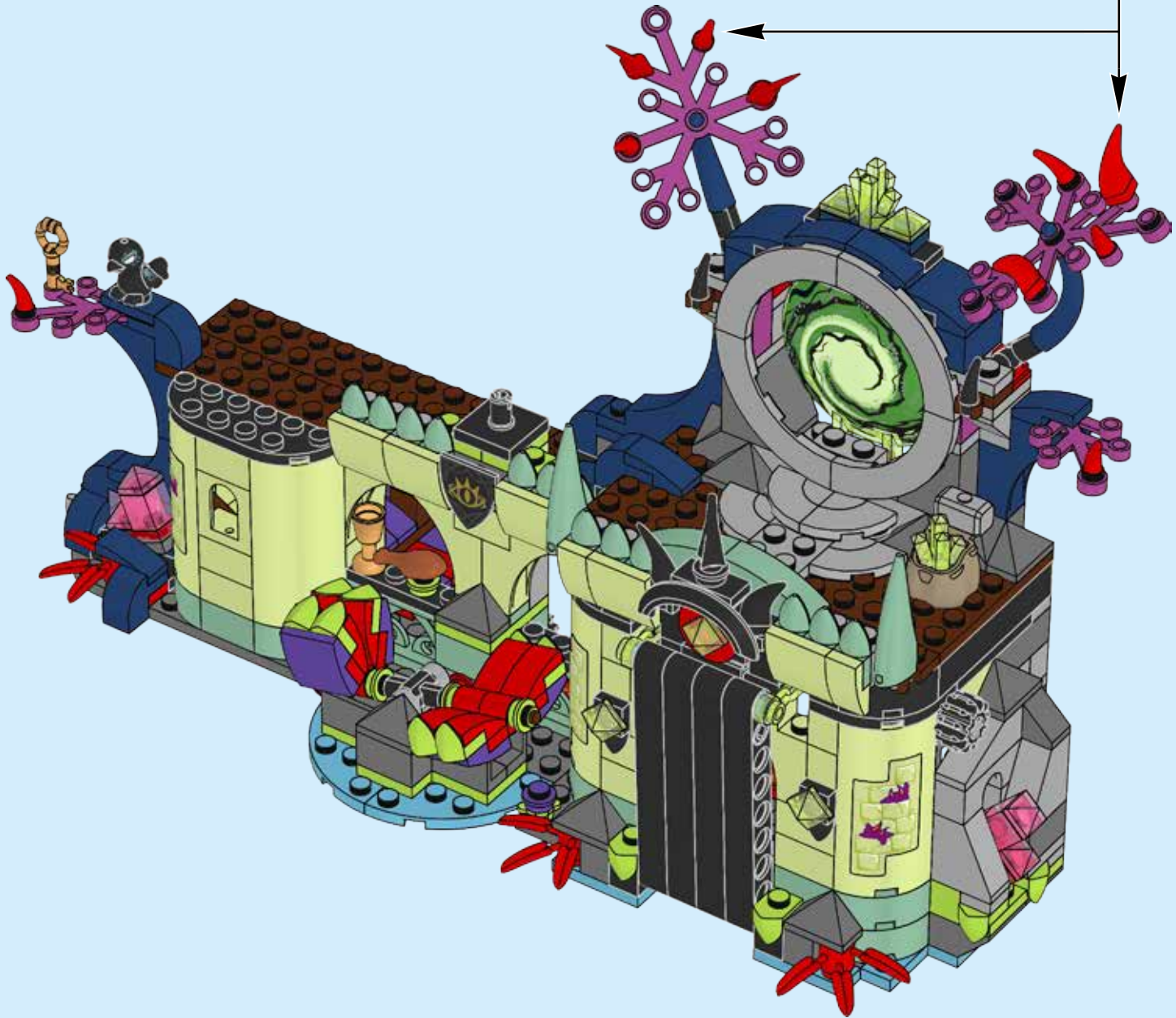
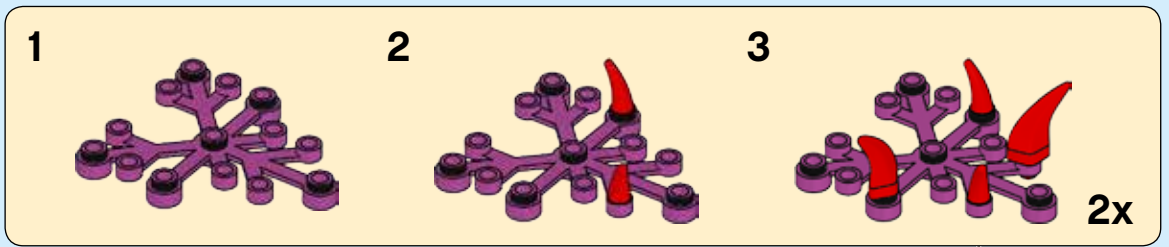

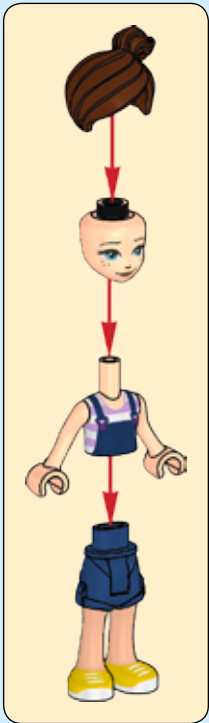
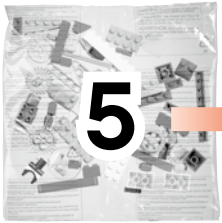

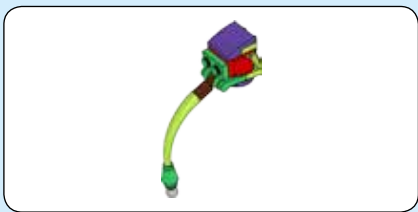

1x

174



1x

175

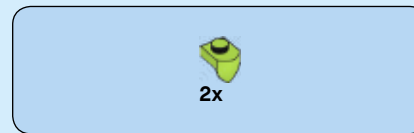

2x

176

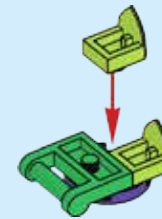

1x

177





178

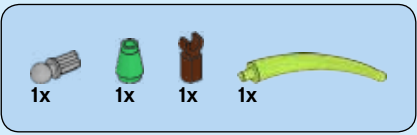
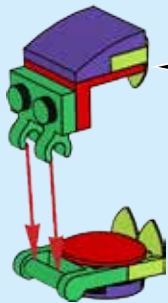
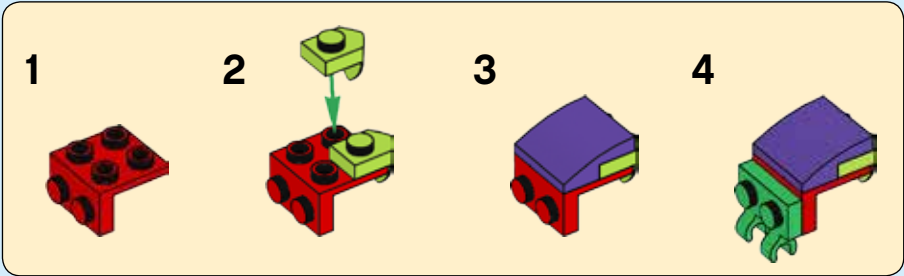

179

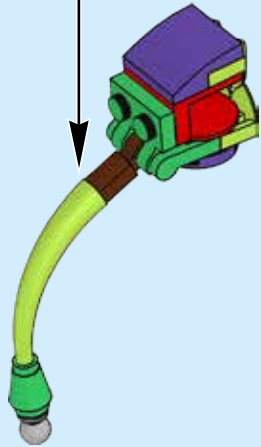
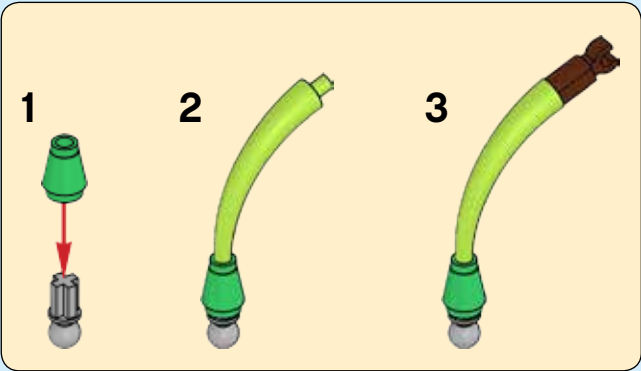

180

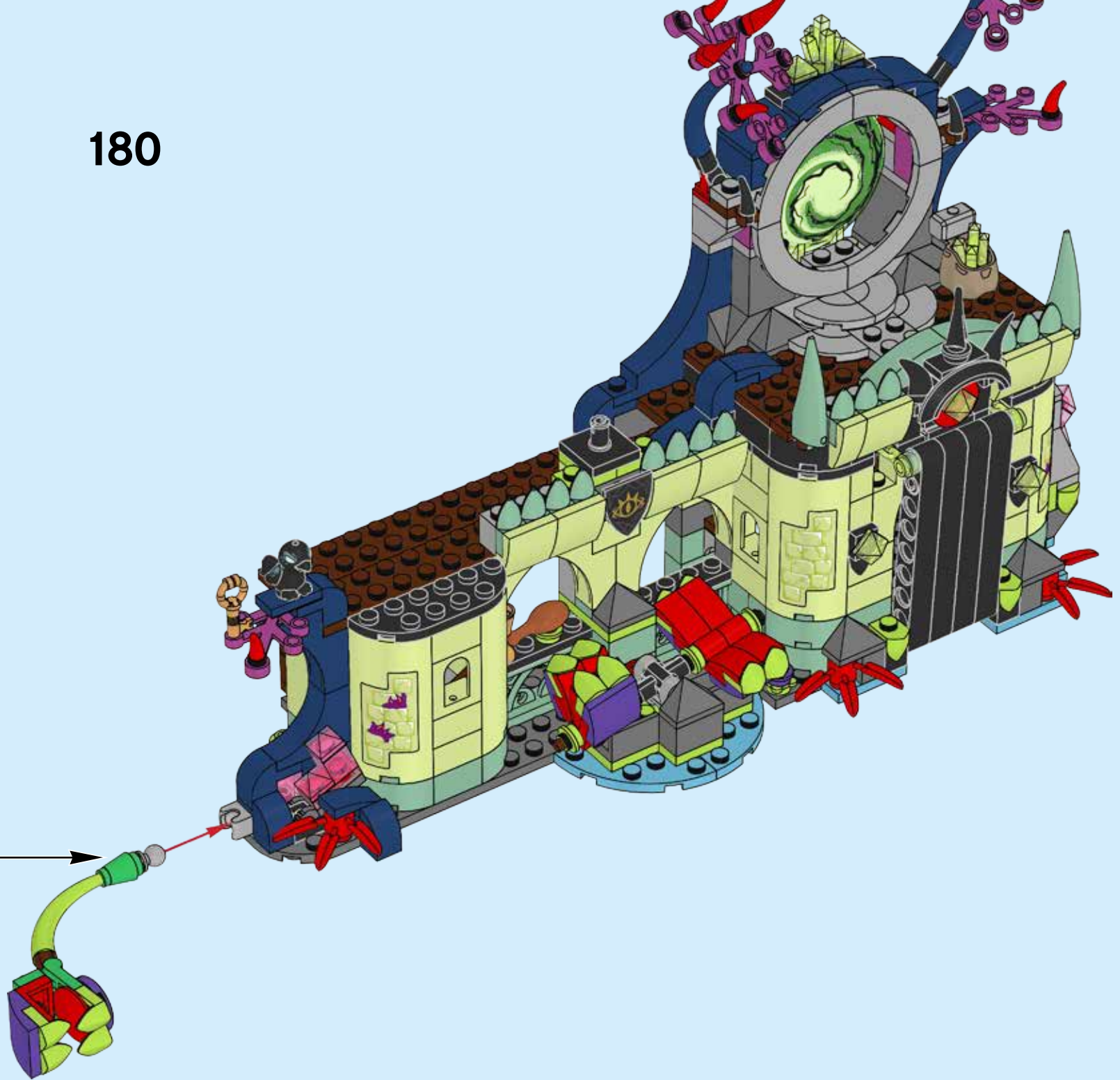



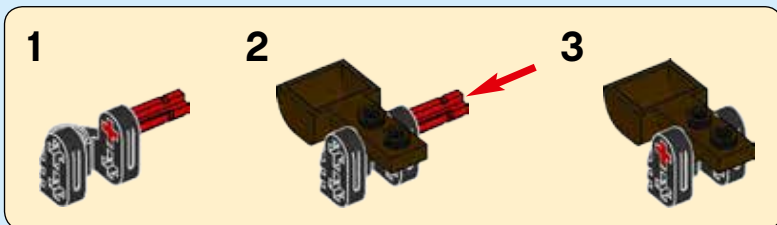

181

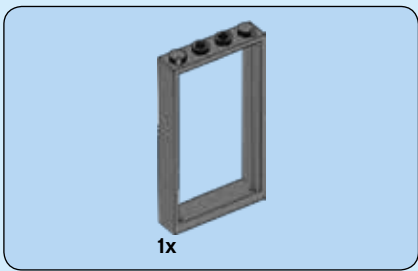



182

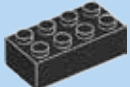

1x  1x  1x 

183



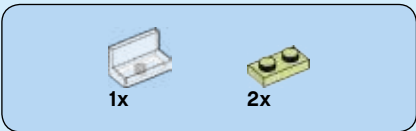

184





1x



1x



1x

185

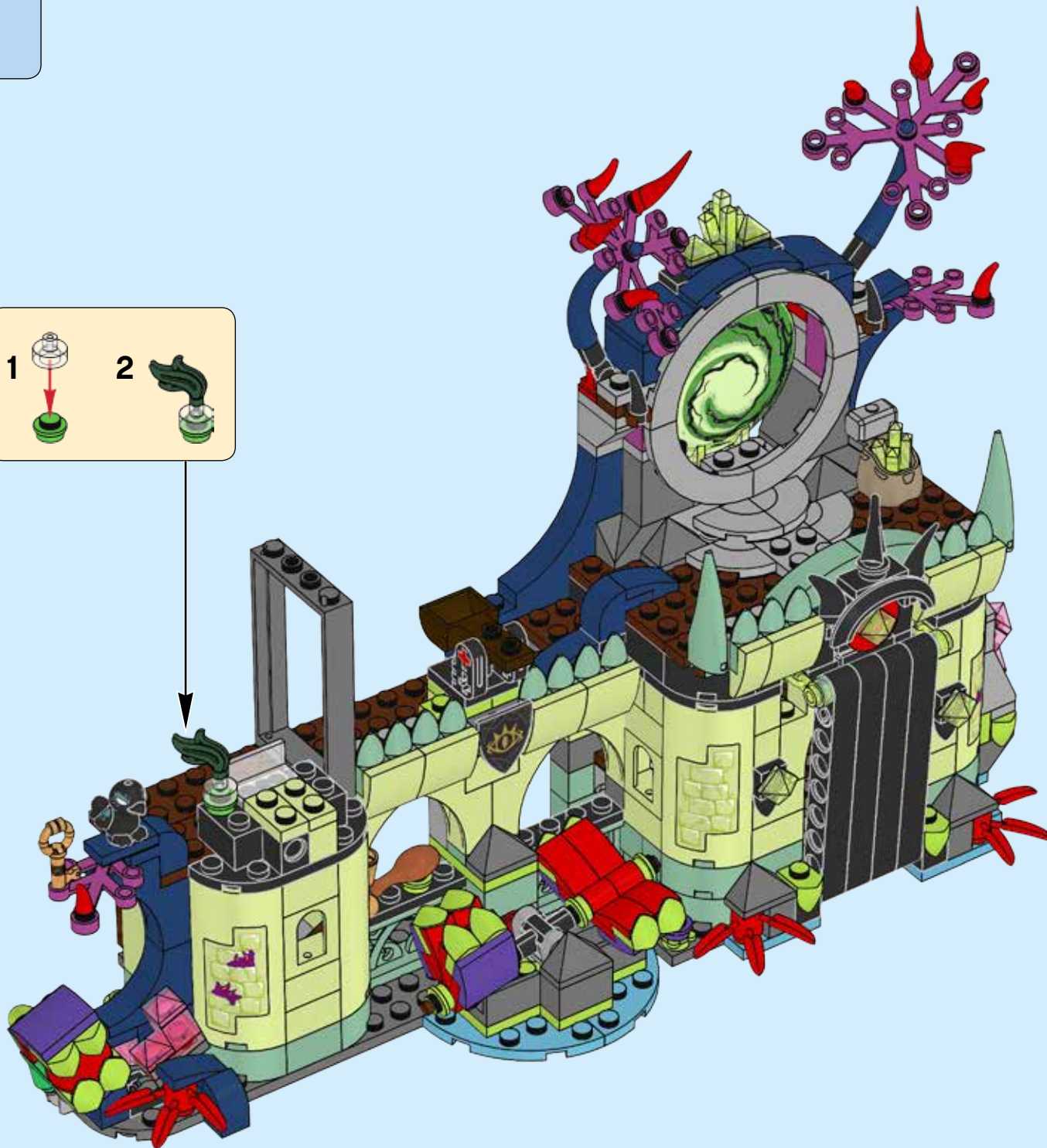

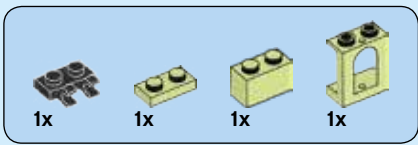

186

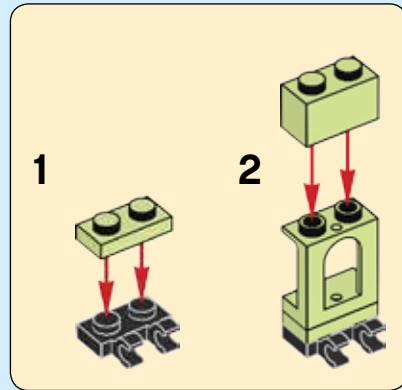

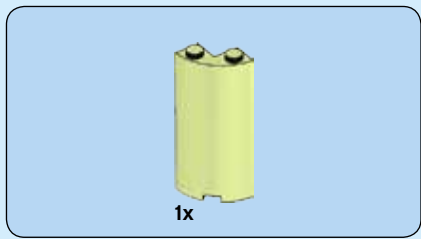

187

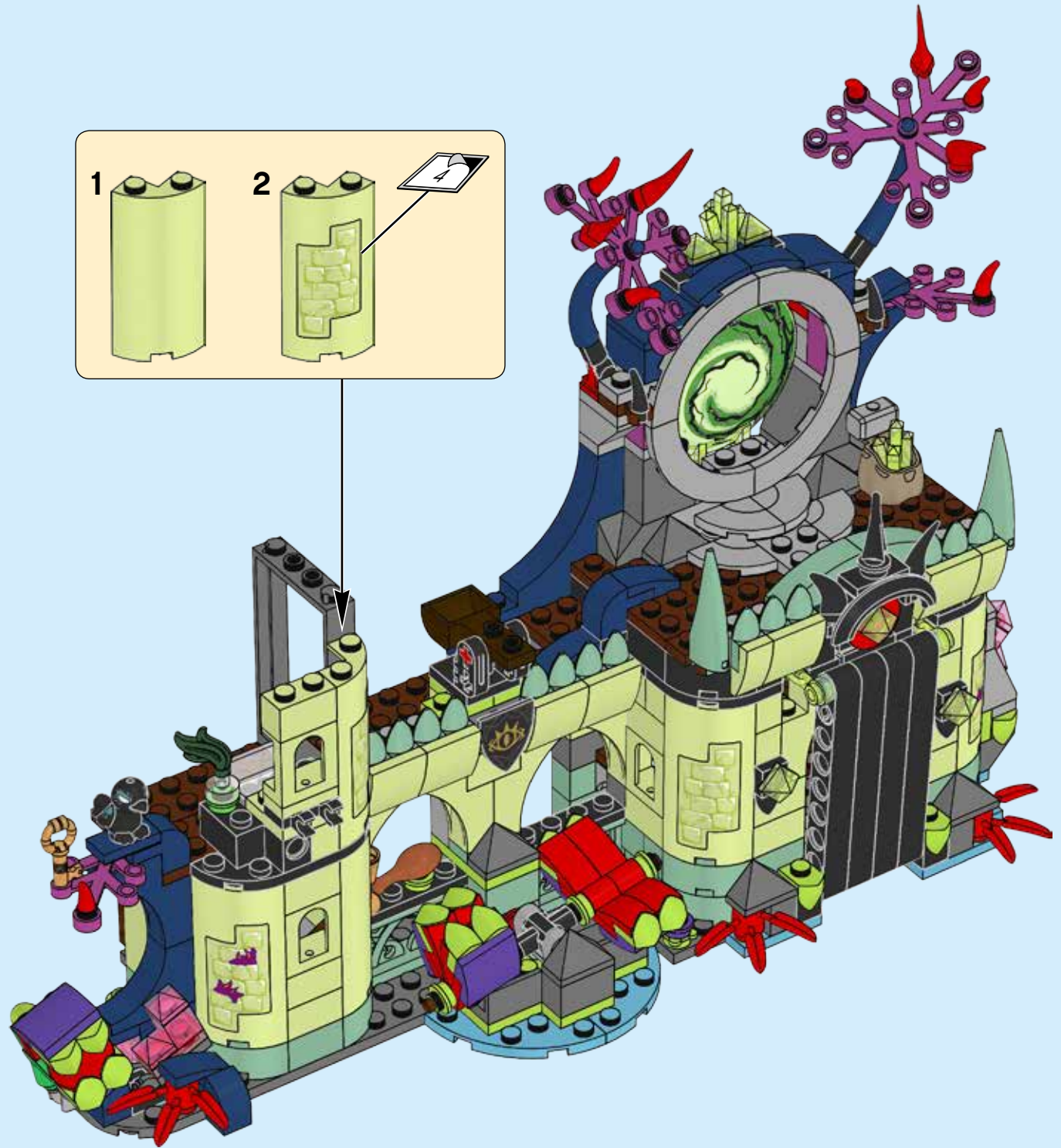
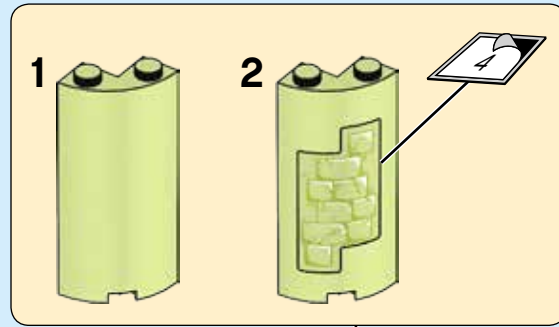

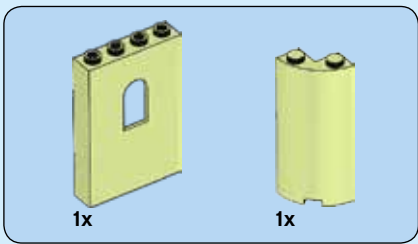

188



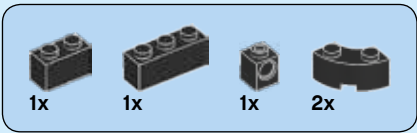

189



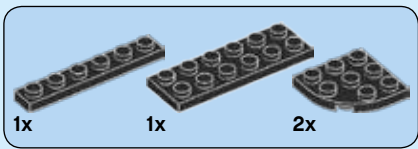

190





191

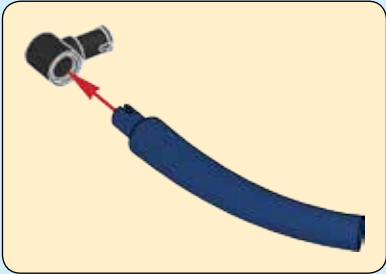



2x

192



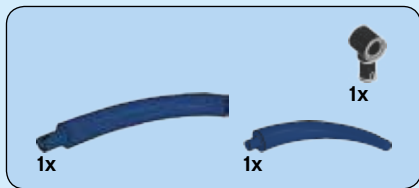

193

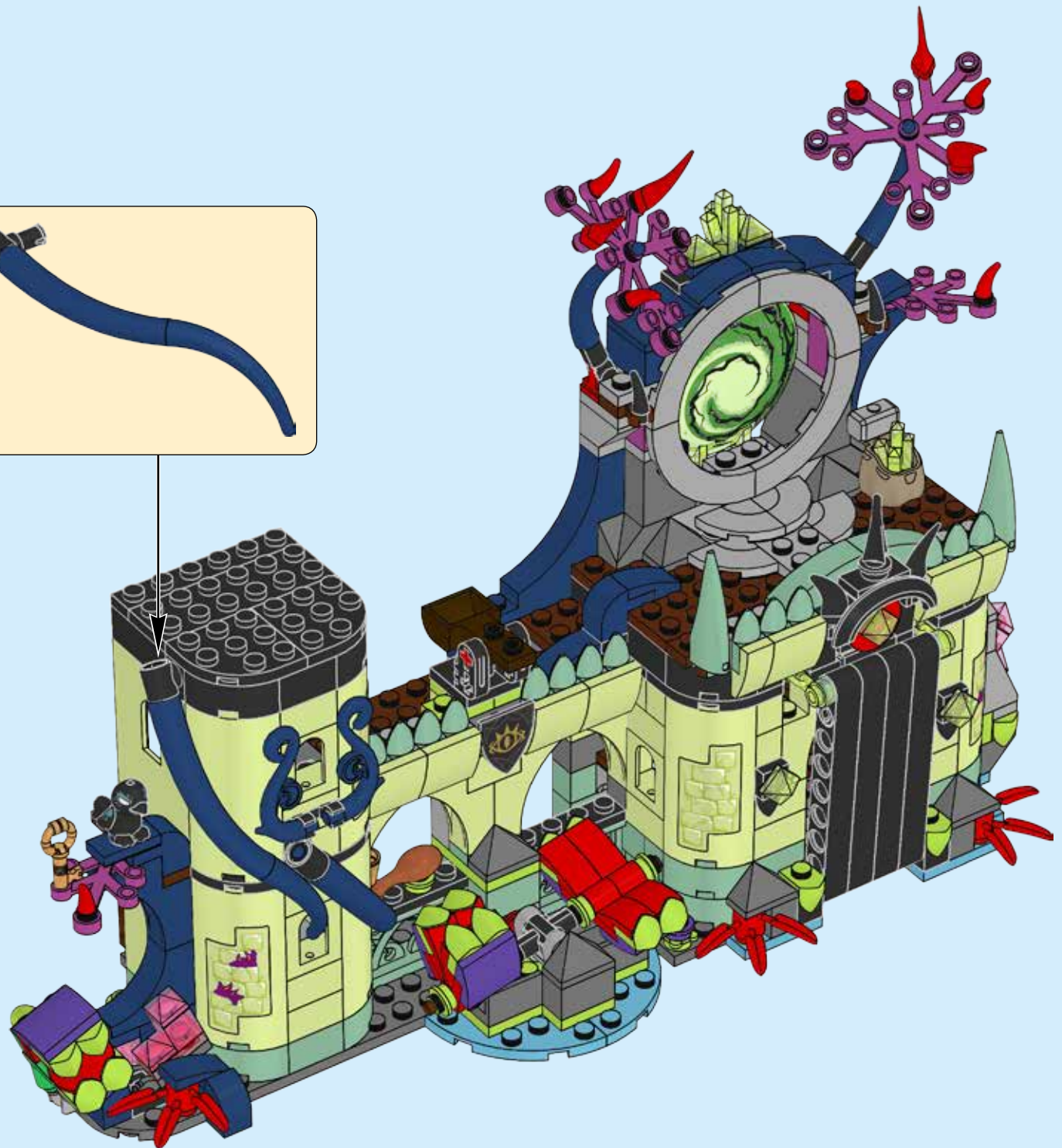
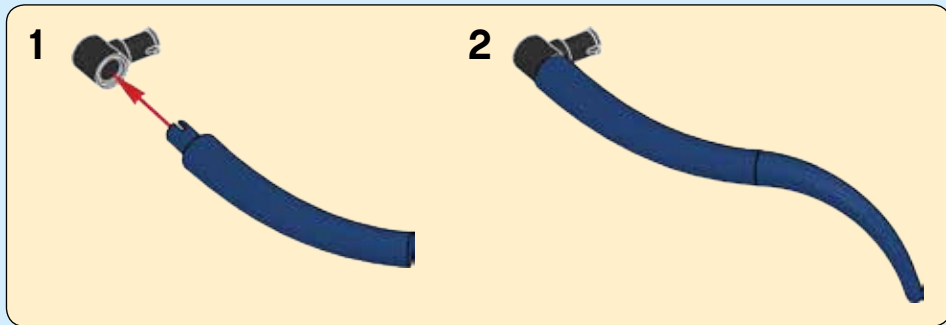

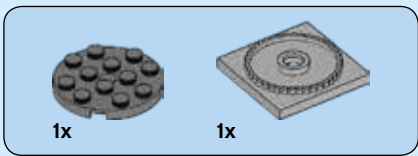

194

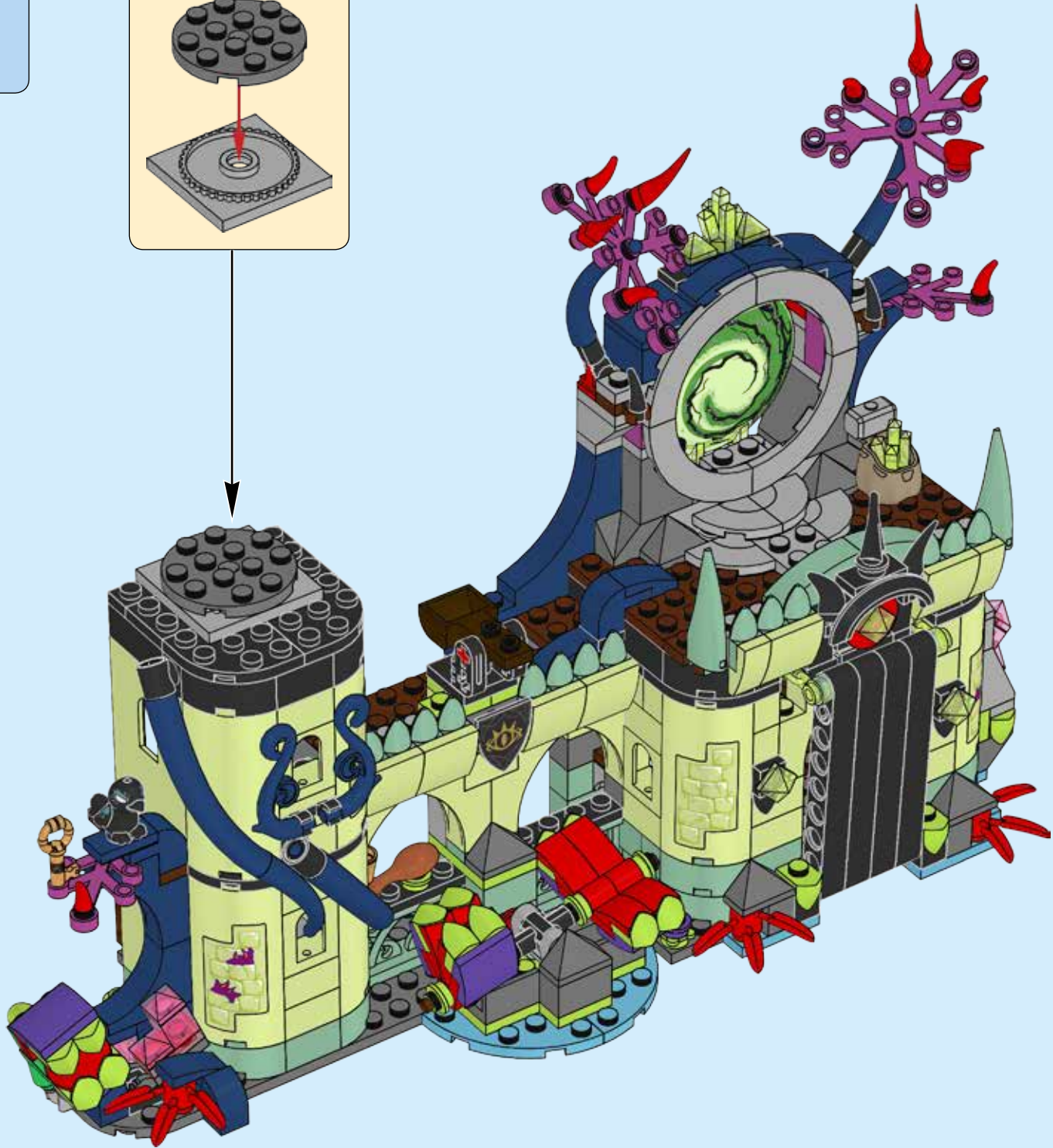
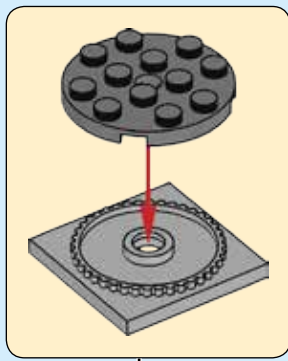



1x

195



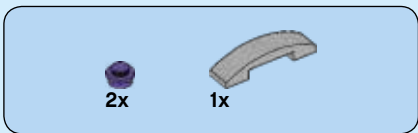

196

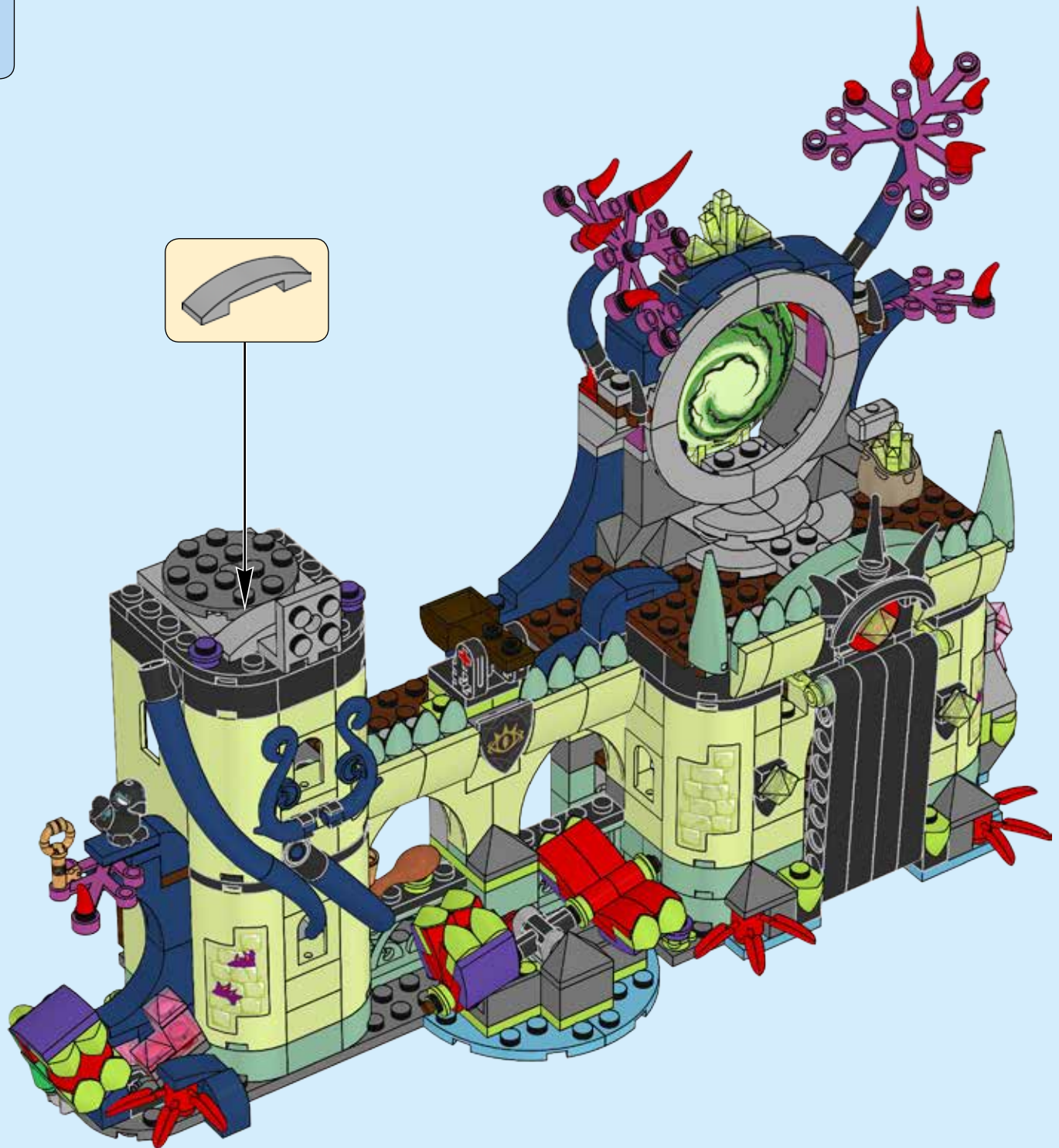



197



198



199

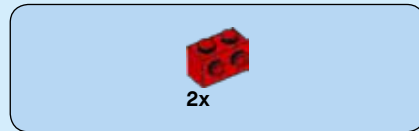

200





201

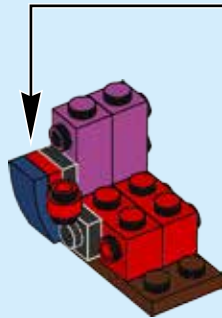
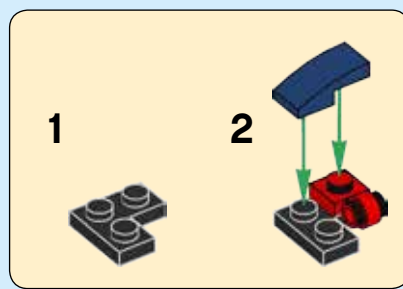

202

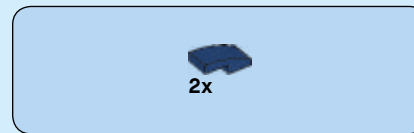
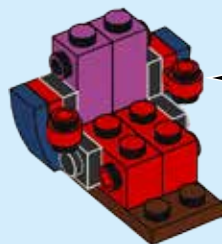
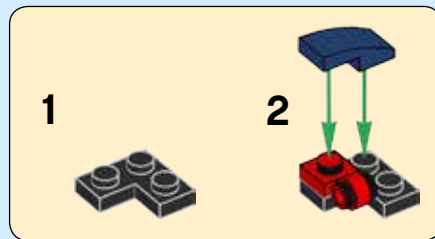

203

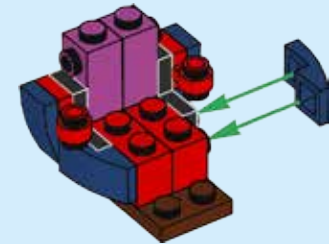

204

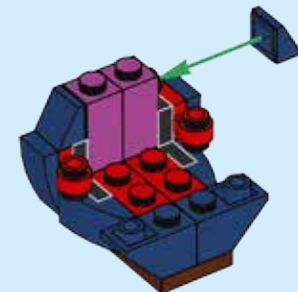

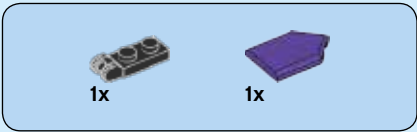

205

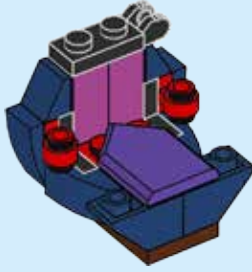

206

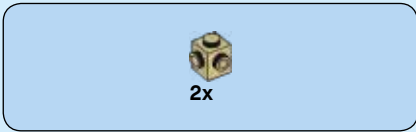
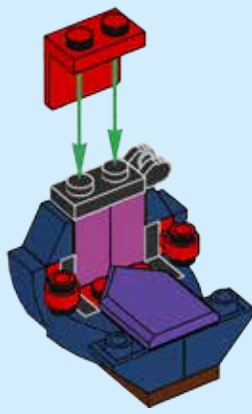

207



208

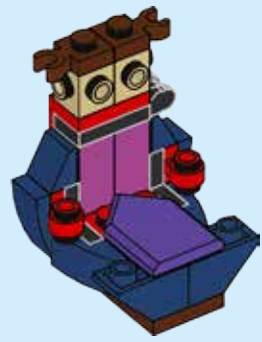



209

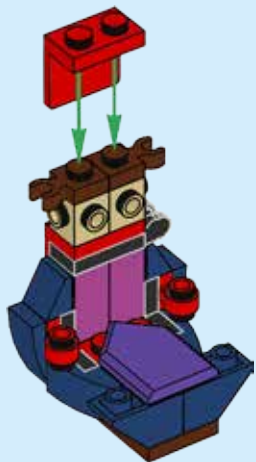

210

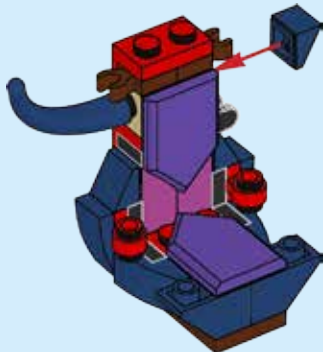

211

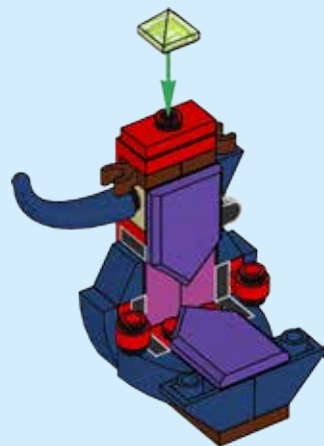

212

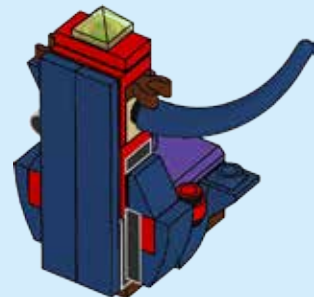
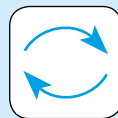

2x

4x

213

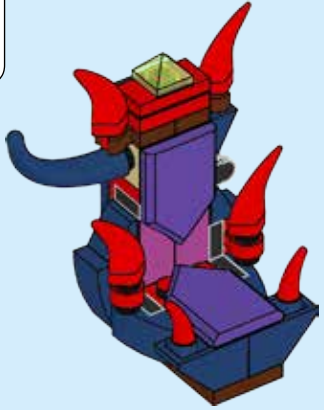
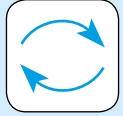

214



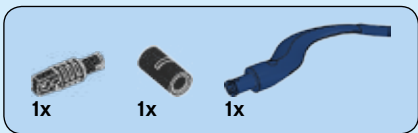

215

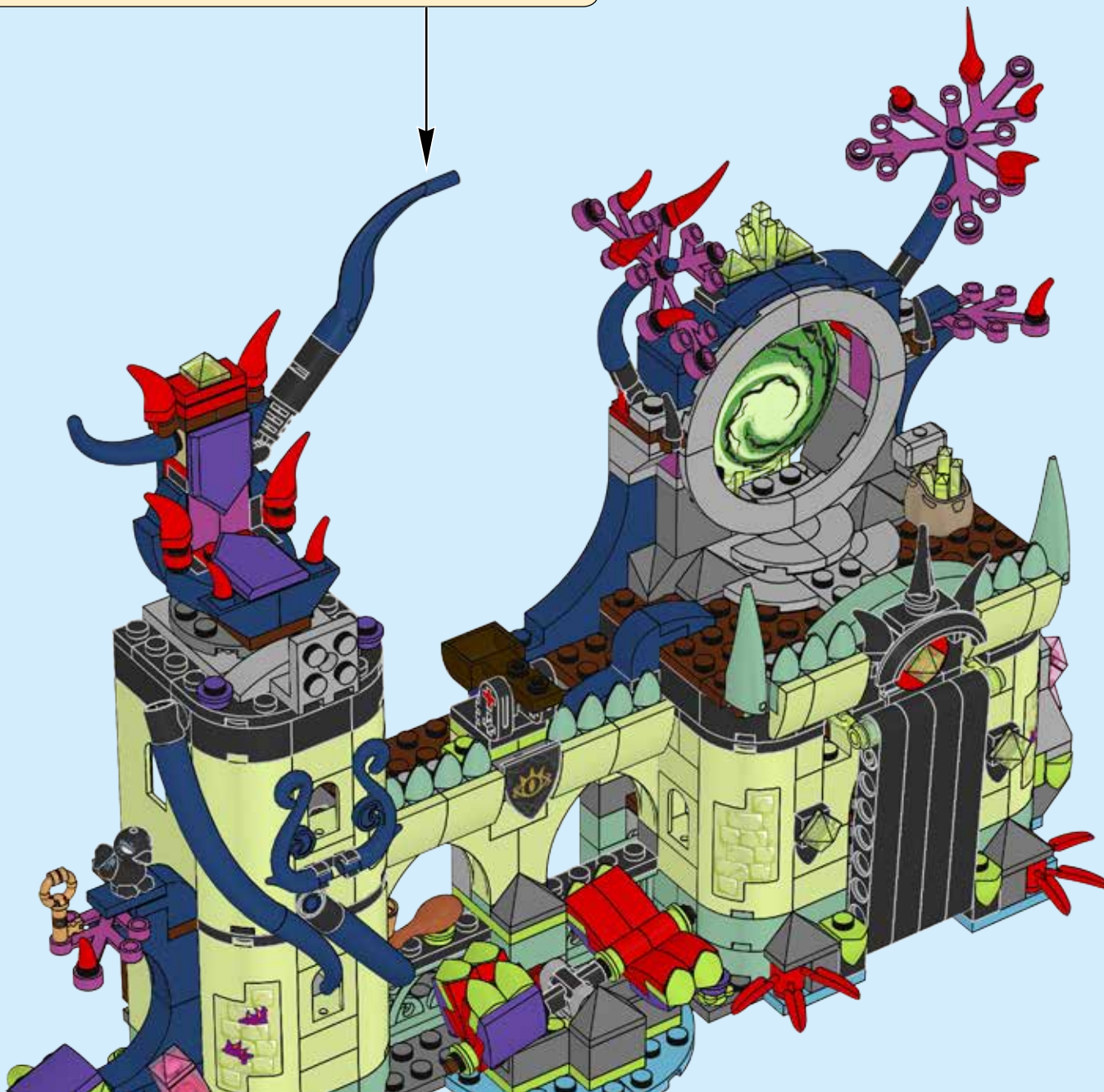
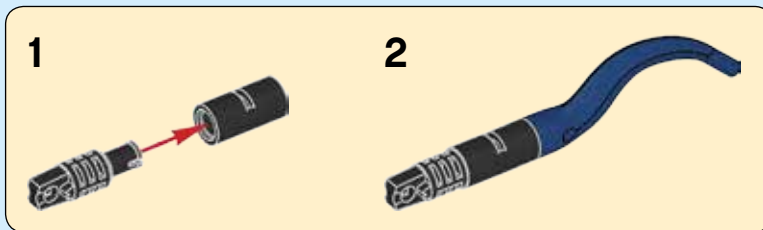

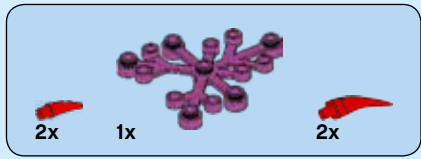

216

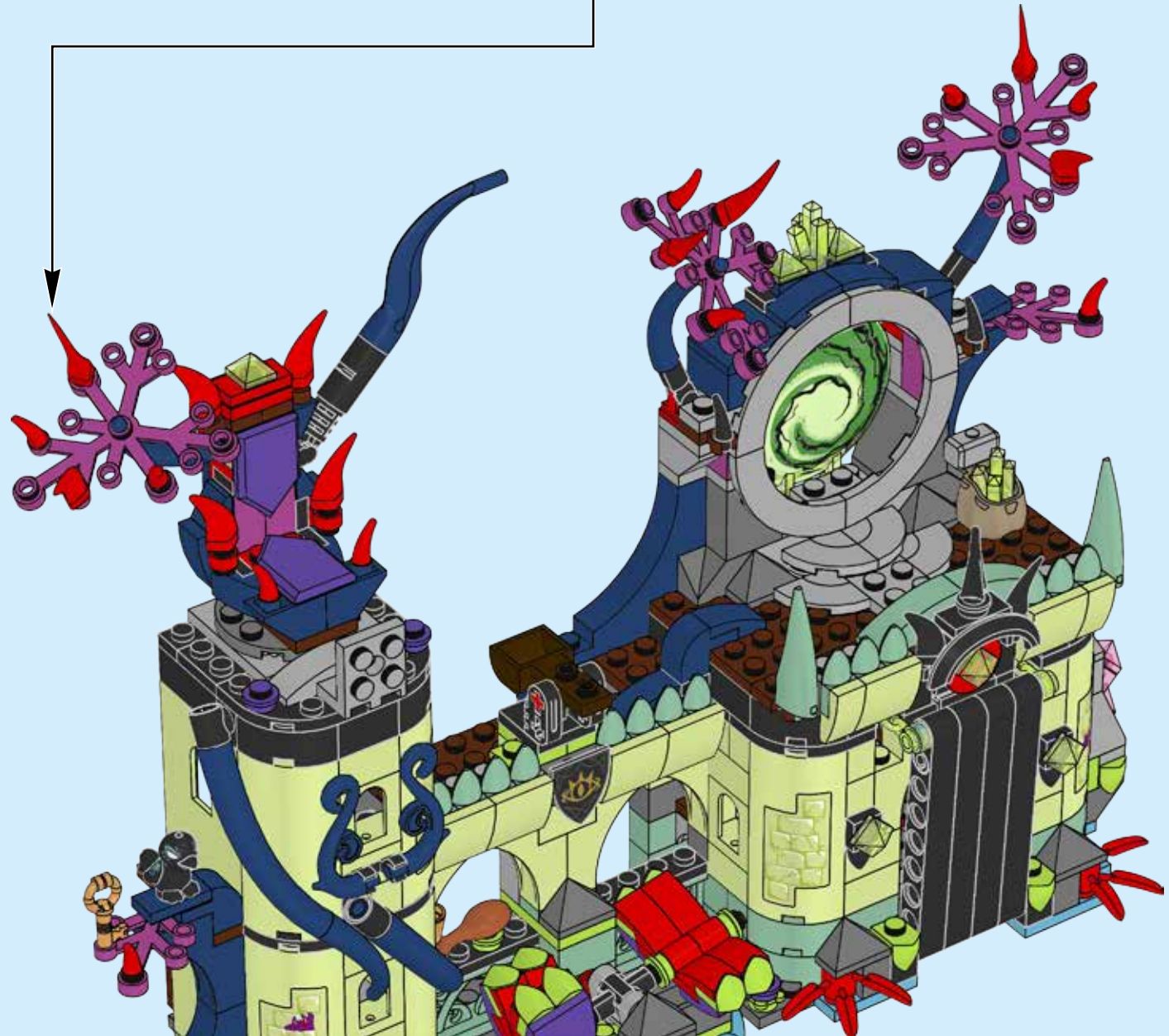
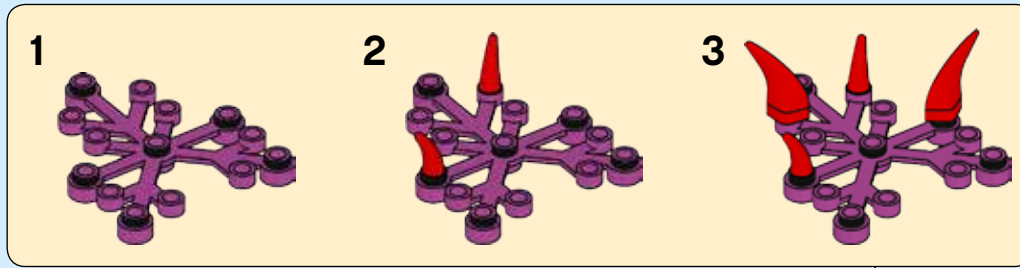

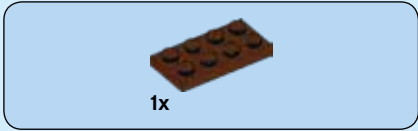
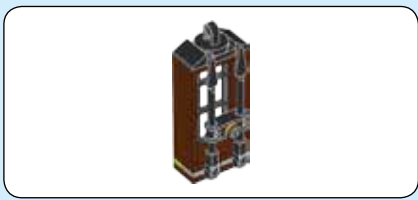

217

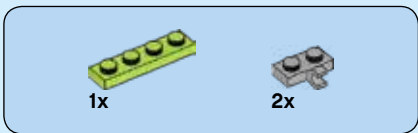

218

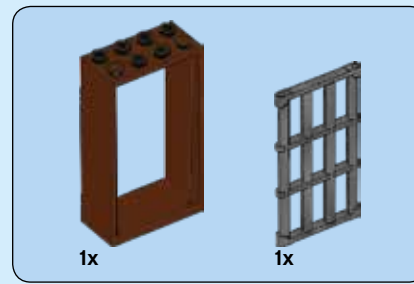
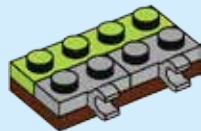

219

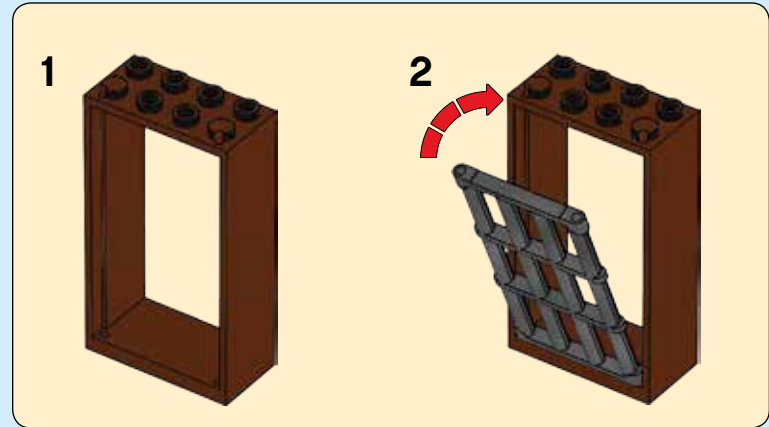



1x



2x

220



1x

221



2x



1x



2x

222

1



2



3

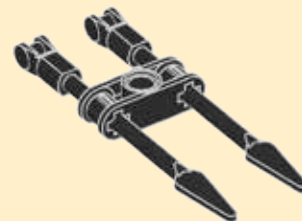

1x

1x

223

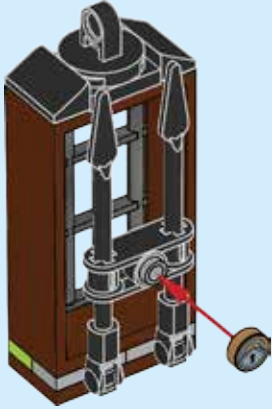

1x

224

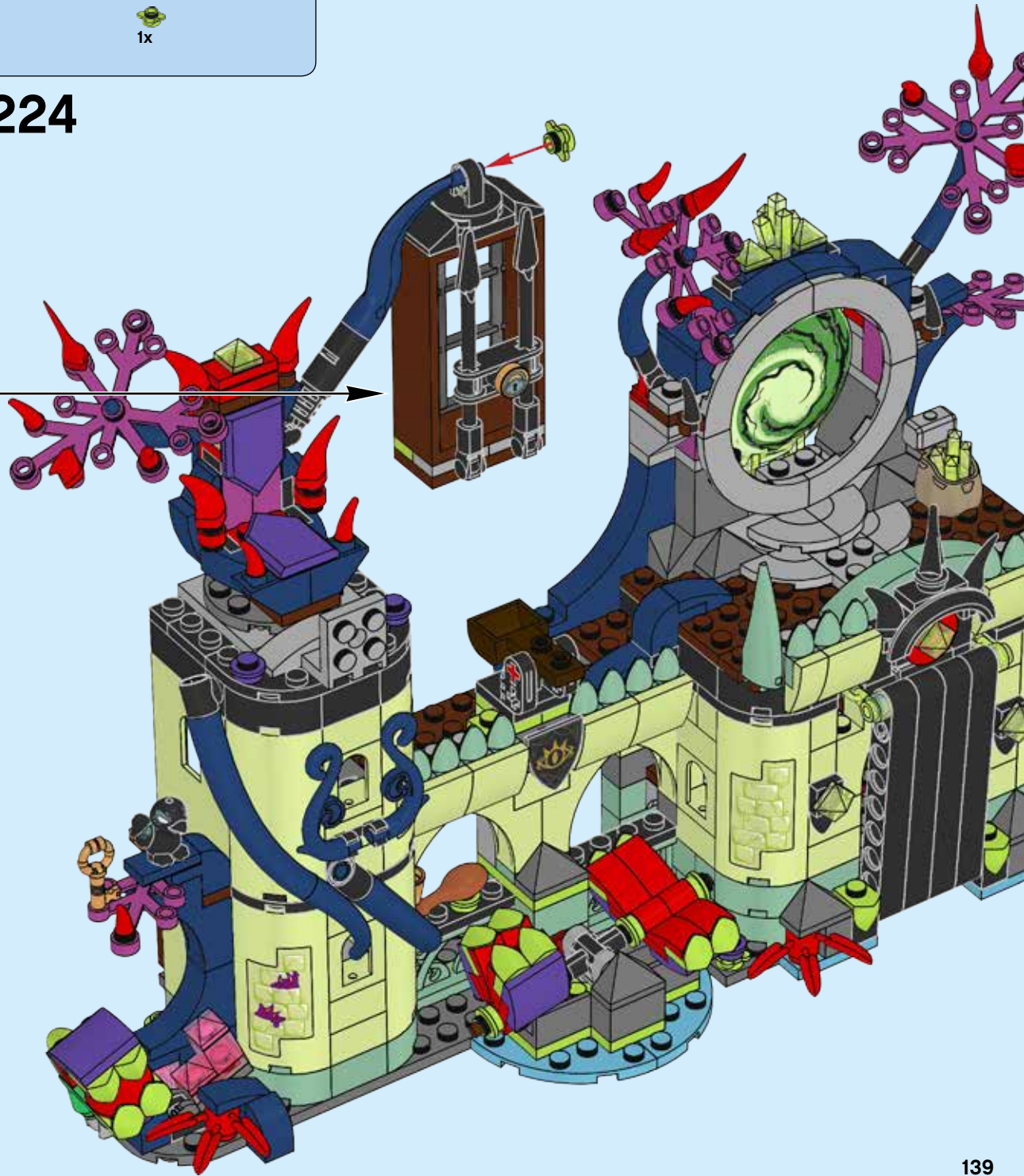

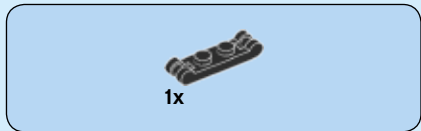

225

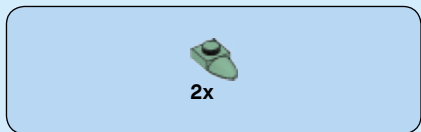

226

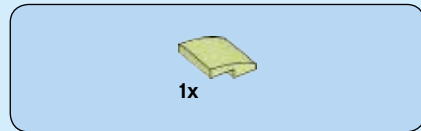

227

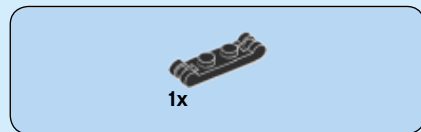

228



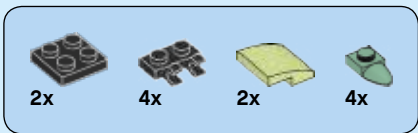

229

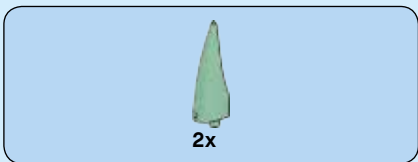
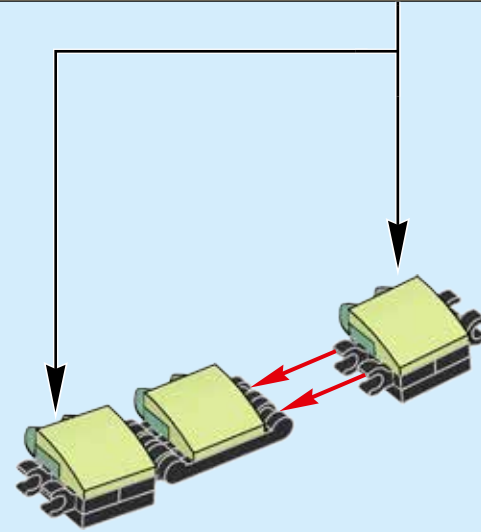
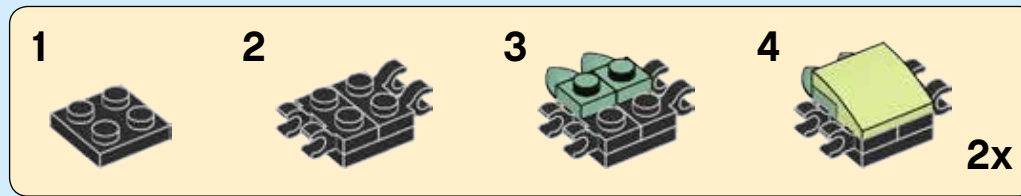

230

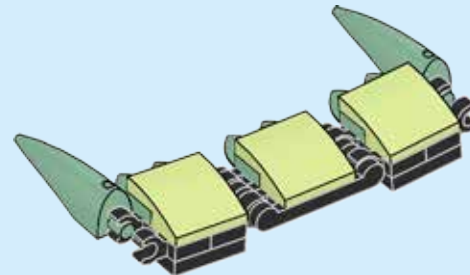

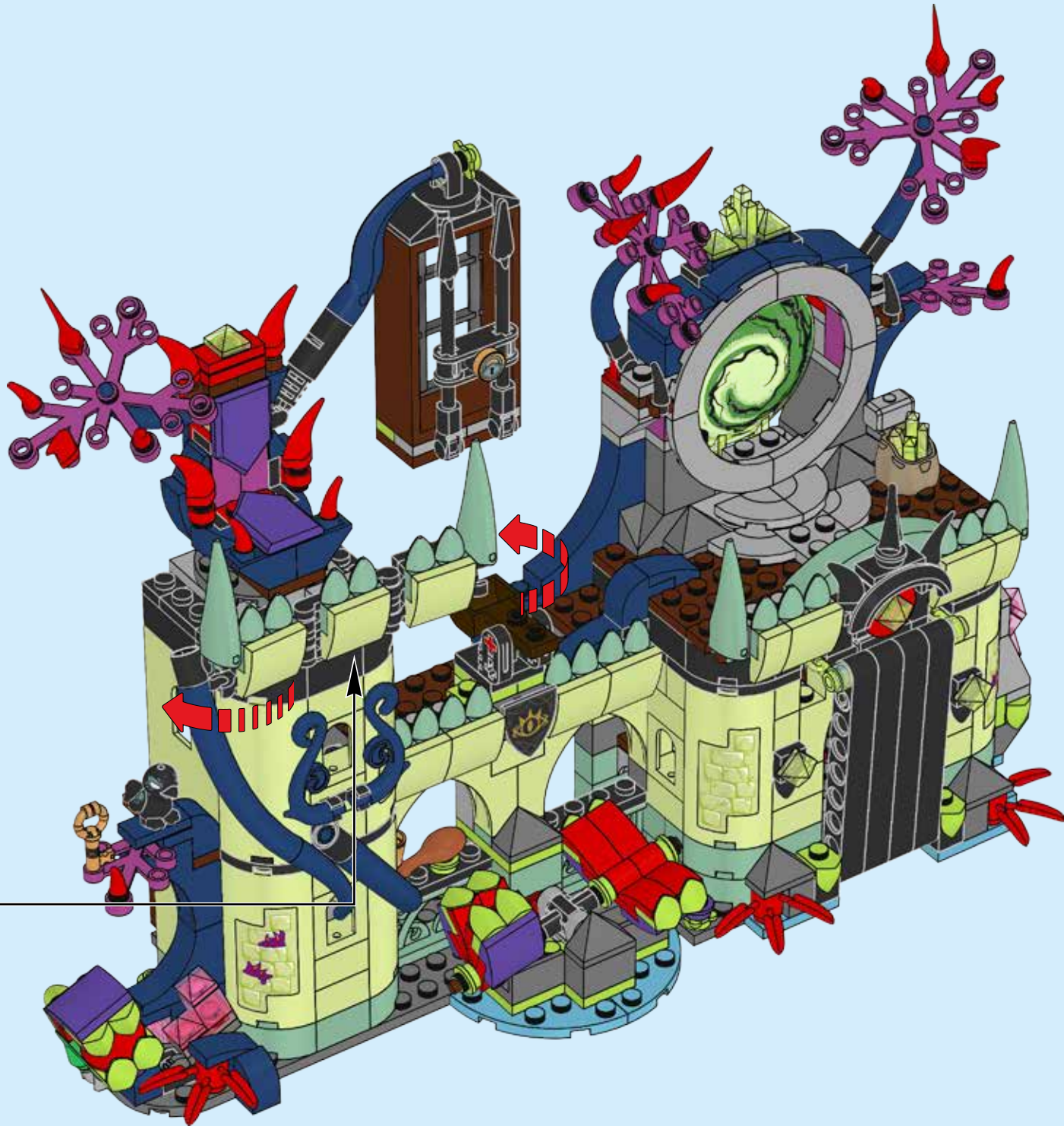

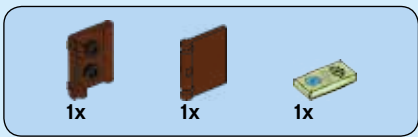

232

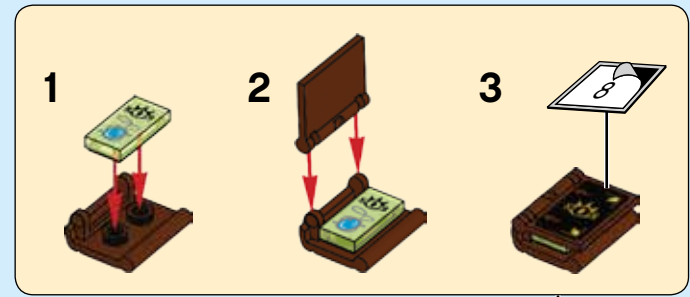
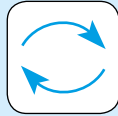



2x



2x

233



2x

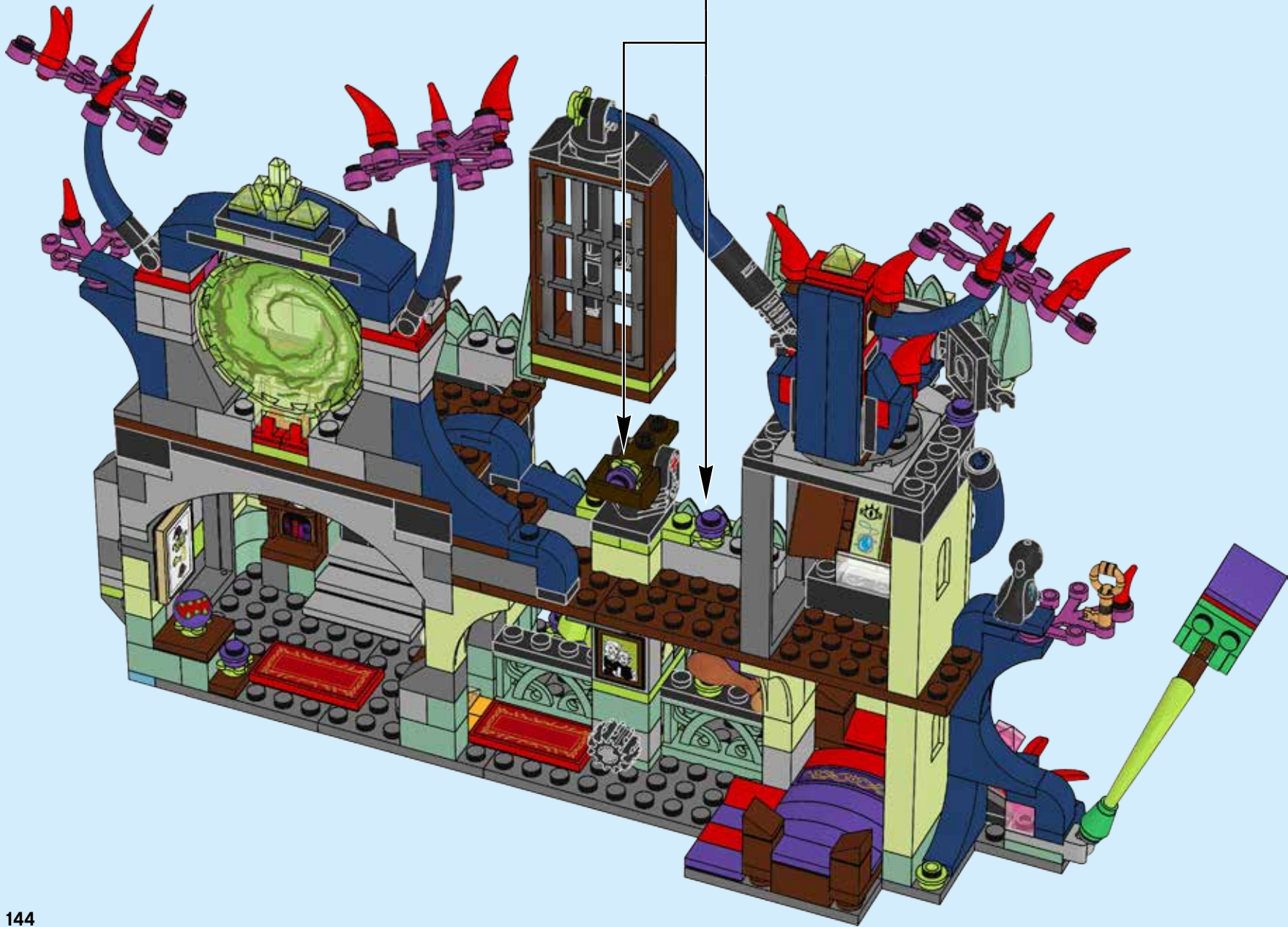

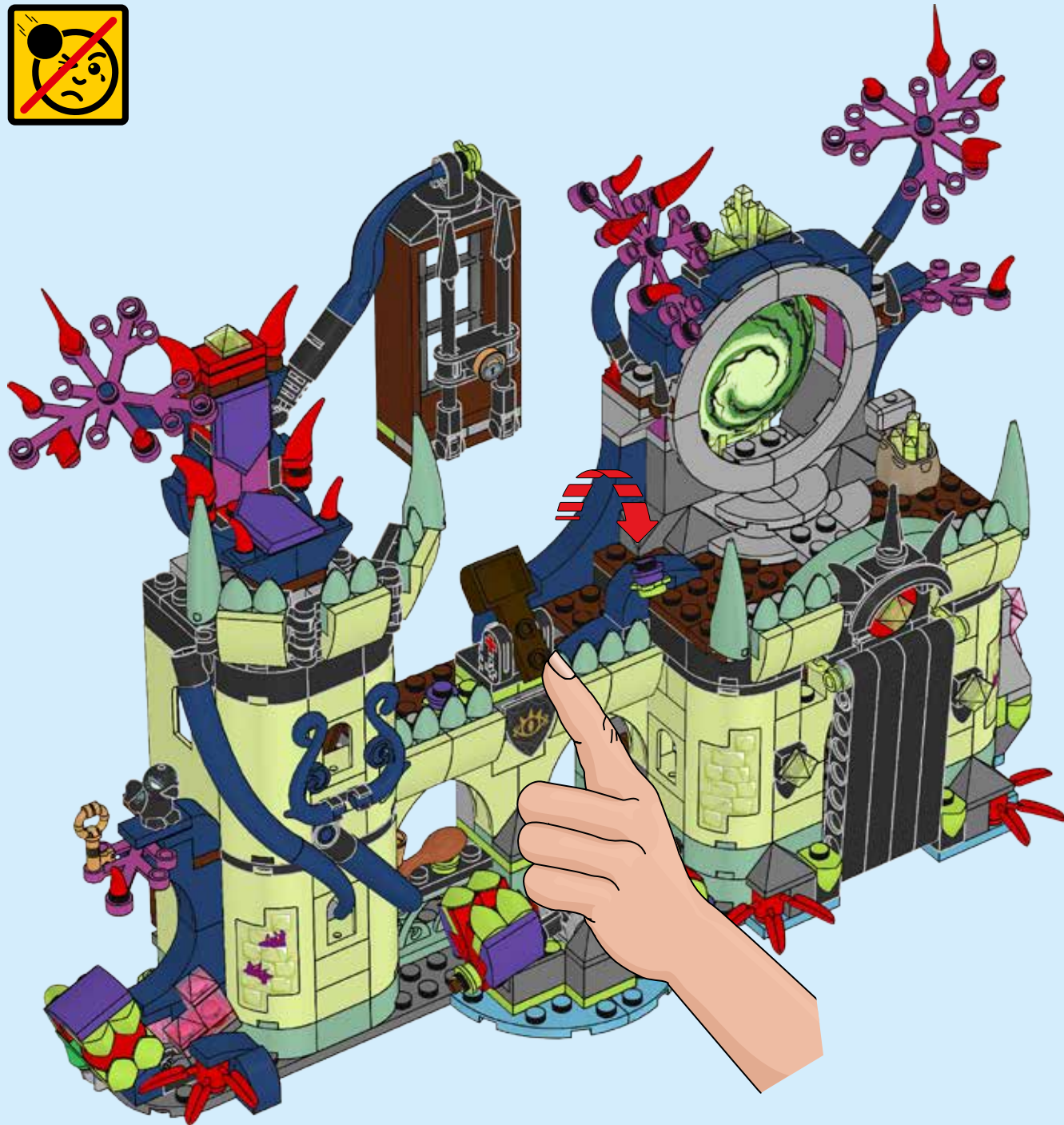



- | | | | | | | | | | |
|----------------|----------------|---------------|---------------|---------------|----------------|---------------|----------------|----------------|---------------|
| 4x
614101 | 1x
306921 | 1x
6179277 | 3x
6092585 | 1x
4296142 | 1x
4529239 | 2x
4537937 | 10x
6094143 | 2x
6009656 | 1x
6134672 |
| 2x
4558952 | 4x
4597713 | 2x
6073231 | 1x
300426 | 2x
4512727 | 1x
4556159 | 2x
4633822 | 2x
6061569 | 5x
4521948 | 1x
6134673 |
| 2x
6175968 | 1x
6092565 | 2x
302426 | 2x
6000650 | 2x
6099483 | 1x
4521931 | 1x
6013530 | 2x
6025375 | 20x
6186079 | 1x
6107282 |
| 1x
6177314 | 8x
6186398 | 4x
654126 | 5x
4556158 | 1x
370526 | 1x
6109808 | 3x
4187743 | 1x
4177735 | 8x
4616581 | 1x
6107282 |
| 1x
4655257 | 3x
6117974 | 2x
4273590 | 1x
4107761 | 1x
370526 | 1x
4278013 | 1x
6172469 | 2x
6097484 | 4x
4655080 | 1x
6184572 |
| 2x
4514554 | 10x
6172746 | 2x
4568385 | 1x
4159335 | 1x
6170505 | 1x
4248937 | 1x
4621548 | 2x
6172664 | 4x
4655080 | 1x
6066142 |
| 1x
6175367 | 3x
6186050 | 2x
6179487 | 2x
4563477 | 3x
371026 | 1x
6112751 | 4x
6188999 | 2x
6142695 | 6x
6186082 | 2x
4531751 |
| 1x
4114001 | 1x
4633914 | 2x
4177431 | 1x
4610371 | 4x
4227392 | 1x
3000840 | 1x
6054554 | 2x
6172664 | 3x
6075624 | 2x
6064188 |
| 3x
4227155 | 2x
4560179 | 1x
6178995 | 3x
302226 | 1x
395726 | 1x
6054554 | 2x
4201019 | 2x
6177019 | 2x
6100237 | 4x
6173132 |
| 5x
302421 | 8x
4143005 | 1x
6191958 | 1x
4258354 | 1x
300126 | 1x
4217436 | 1x
421019 | 3x
6133021 | 1x
4521947 | 2x
6069984 |
| 10x
4568388 | 1x
4206482 | 1x
6157554 | 2x
6061032 | 1x
6105963 | 1x
4107106 | 1x
6201769 | 1x
6103771 | 2x
6097680 | 2x
4211199 |
| 2x
4142865 | 1x
302323 | 2x
4533771 | 2x
242026 | 1x
366626 | 3x
6097448 | 1x
4598955 | 4x
6179092 | 2x
4244369 | 1x
4645103 |
| 2x
4651524 | 3x
4514553 | 1x
6173119 | 4x
4567436 | 3x
449726 | 4x
6172693 | 3x
4504374 | 2x
4252437 | 2x
6122504 | 1x
4565394 |
| 1x
4278275 | 1x
302324 | 2x
4548180 | 1x
4183060 | 2x
379526 | 6x
6190251 | 6x
6182166 | 1x
6186140 | 1x
6080355 | 1x
4216695 |
| 2x
4632572 | 1x
6135009 | 1x
6010831 | 1x
4121667 | 1x
346026 | 6x
6182166 | 4x
6172693 | 2x
6172647 | 4x
4216581 | 2x
6139449 |
| 1x
6132541 | 6x
4121715 | 1x
6155068 | 1x
362226 | 4x
4645732 | 16x
6138659 | 1x
6178911 | 1x
4587127 | 4x
4211242 | 2x
6055086 |
| 2x
6019155 | 4x
6143318 | 2x
3200026 | 2x
4181144 | 1x
447726 | 4x
4164037 | 1x
6092588 | 1x
6179174 | 4x
4504376 | 3x
6116613 |
| 5x
6109459 | 3x
6168646 | 1x
428726 | | | 1x
4164022 | 6x
6115447 | 4x
6186406 | 4x
6092590 | 1x
4658005 |

4

9

- 2x 4211190
- 4x 4211186
- 1x 4211201
- 1x 6132813
- 1x 6179636
- 2x 4221590
- 1x 4243838
- 1x 4609635
- 2x 4225700
- 1x 4264669
- 1x 4211483
- 6x 6176433
- 2x 4211399
- 4x 4211389
- 1x 4211375
- 2x 4211741
- 1x 6008364
- 2x 6004888
- 2x 6028812
- 2x 4211440
- 2x 4515374
- 4x 4211398
- 2x 4211564
- 2x 4211437
- 3x 6015344
- 1x 6004729
- 2x 6156663
- 6x 4211353
- 4x 6163990
- 2x 4211387
- 1x 6043639
- 1x 4654577
- 1x 6019212
- 1x 4645397
- 1x 4211488
- 3x 4211356
- 2x 4211636
- 1x 4622803
- 1x 4211435
- 1x 6117972
- 1x 6055312
- 8x 6076203
- 3x 4211135
- 1x 4211002
- 1x 4211639
- 1x 6045718
- 4x 6163989
- 1x 4211805
- 1x 4211452
- 1x 6096381
- 2x 4210794
- 1x 4226358
- 1x 4211088
- 4x 6146225
- 2x 4210762
- 1x 6178919
- 1x 4212075
- 1x 6000606
- 1x 4211109
- 2x 4234534
- 2x 4211000
- 2x 4210702
- 1x 4210884
- 5x 4211104
- 1x 4211064
- 2x 4210794
- 2x 4535833
- 1x 4528323
- 1x 6143247
- 6x 4566522
- 1x 6179436
- 1x 6097501
- 3x 4613192
- 5x 6182217
- 2x 6163246
- 4x 6069012
- 1x 4568951
- 1x 6178929
- 1x 6103041
- 1x 6192137
- 1x 6179015
- 1x 6178344
- 1x 6178391
- 1x 6147054
- 4x 6057034
- 6x 6138727
- 2x 6134621
- 1x 6179437
- 1x 6193891
- 1x 6190246
- 4x 6190252
- 1x 6182217
- 1x 6039771
- 1x 6071259
- 1x 6179657
- 1x 6022033
- 1x 6160341
- 2x 6100864
- 1x 6186380
- 1x 4505990
- 1x 6055383
- 1x 6173068
- 2x 6119107
- 1x 6070757
- 2x 6056271
- 1x 6074793
- 1x 6170575
- 1x 6192023
- 6x 6172766
- 6x 6186075
- 18x 6104578
- 3x 6099368
- 3x 6186072
- 2x 6109405
- 9x 6177166
- 8x 6186070
- 2x 6059149
- 1x 6170611
- 1x 6199071
- 1x 6199070
- 1x 4654448



Customer Service
Kundenservice
Service Consommateurs
Servicio Al Consumidor
LEGO.com/service or dial

00800 5346 5555 :        

1-800-422-5346 :  

The LEGO logo is positioned in the top left corner, featuring the word "LEGO" in its characteristic white, bold, sans-serif font with a black outline, set against a red square background.

ELVES





ELVES







LEGO

ELVES

Free
app game

Appli de
jeu gratuite

App de
juego gratis



LEGO® Elves
LEGO.com/apps



 LEGO.com/elves



ELVES

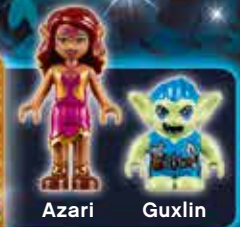

Azari Guxlin

41186



Rosalyn Naida Rimlin

41187



Emily Sophie Goblin King Tufflin

41188

Le roi des Gobelins
El rey de los duendes



41185



41184



41183



41182



41181

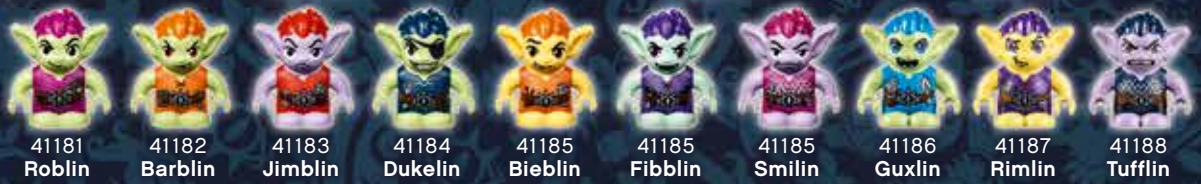

41181 Roblin 41182 Barblin 41183 Jimblin 41184 Dukelin 41185 Bieblin 41185 Fibblin 41185 Smilin 41186 Guxlin 41187 Rimlin 41188 Tufflin

LEGO

ELVES

Forest Elf
Healing
Hideout

Goblin Village

Goblin Forest

Guardian
Tree

Crystal Falls

Thorny Valley

Goblin King's Fortress

Riptide

The land of
Ejvendale

Goblin Forest

Disney

5-12



Disney PRINCESS

© Disney

Friends

5-12



7-12





ELVES

7-12



DC SUPER HERO GIRLS

 DC SUPER HERO GIRLS and all related characters and elements © & TM DC Comics and Warner Bros. Entertainment Inc. (s17)
 WB SHIELD: TM & © WBEI (s17)

WIN

GO TO WWW.LEGO.COM/PRODUCTFEEDBACK AND GIVE US YOUR SHORT **FEEDBACK** ABOUT THIS LEGO® SET FOR A CHANCE TO WIN A COOL LEGO PRIZE.

Terms & Conditions apply



LEGO.com/productfeedback

GEWINNE

Erzähle uns auf www.LEGO.com/productfeedback

etwas über die Erfahrungen, die du mit diesem LEGO® Set gemacht hast, und sichere dir die Chance auf einen coolen LEGO Preis!

Es gelten die Teilnahmebedingungen

GAGNE

Rends-toi sur www.LEGO.com/productfeedback

et donne-nous quelques commentaires sur ce produit LEGO® pour avoir une chance de gagner un prix LEGO !

Voir Conditions Générales

GANAN

Visita www.LEGO.com/productfeedback

y envíanos tu opinión acerca de este set LEGO®. ¡Participarás en el sorteo de un premio LEGO!

Términos y Condiciones aplicables

获取奖品

登录 www.LEGO.com/productfeedback

给出关于此乐高®套装的简短反馈，就有机会获得炫酷乐高奖品

《条款及条件》适用

경품 당첨 기회

www.LEGO.com/productfeedback

페이지로 이동하여 이 레고® 세트에 대한 간략한 피드백을 보내 주시고 멋진 레고 경품을 탈 수 있는 기회도 잡으십시오

약관 적용

ЗАПОЛНИ АНКЕТУ И ПОЛУЧИ ПРИЗ

Перейди по ссылке www.LEGO.com/productfeedback

ответь всего на несколько вопросов об этом наборе LEGO®, и у тебя появится шанс выиграть замечательный приз от компании LEGO.

Применяются Условия и правила участия