



41053



1



2



3



4



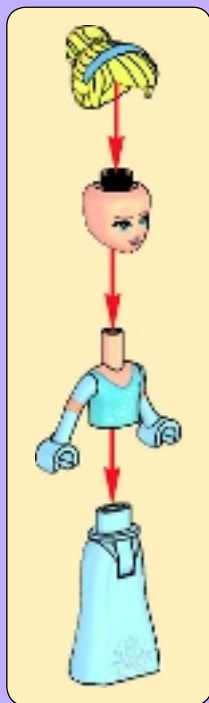



**1**



**2**



**3**



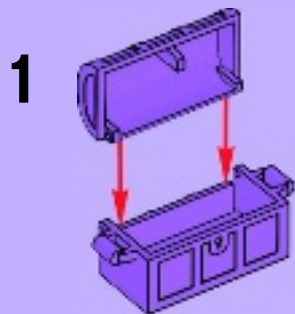
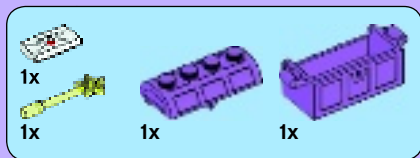

**2**





1

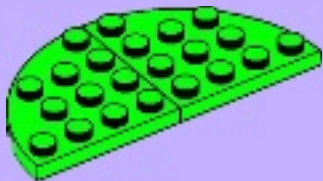

2

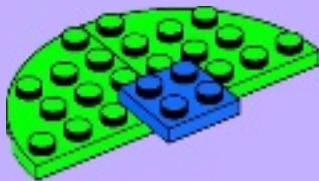



2x

3

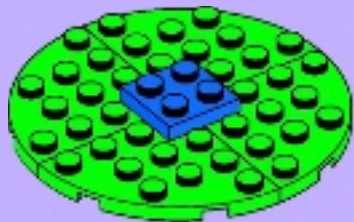

3x



2x

4







1x



2x

5

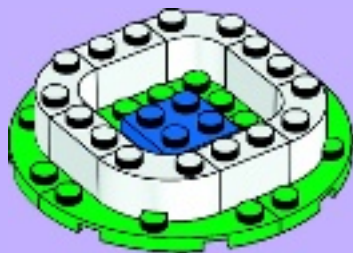

1x

6







2x



1x

7



4x

8



4x



4x



1x

# 9



1x



4x

# 10



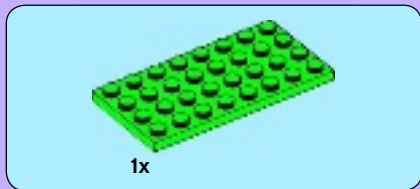

1

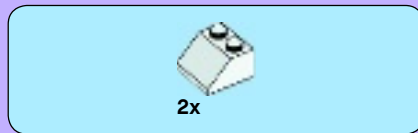
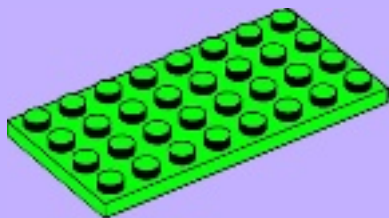

2

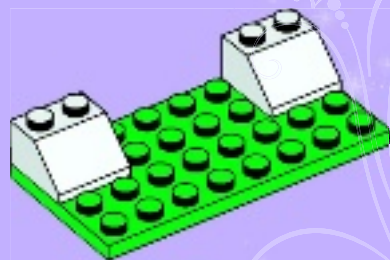



2x

3



2x



2x

4

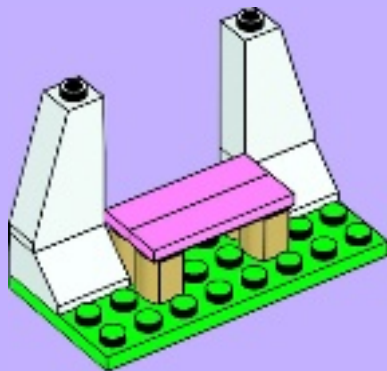

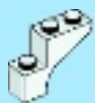

2x

5

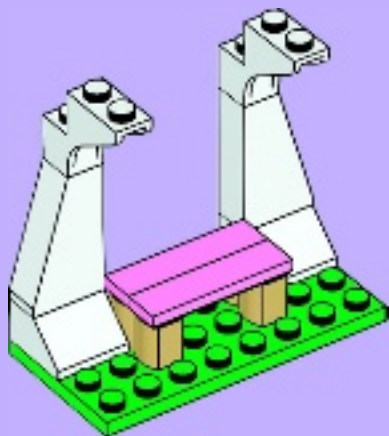

1x

6

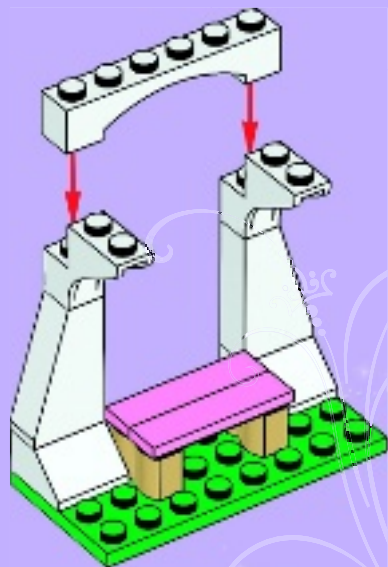

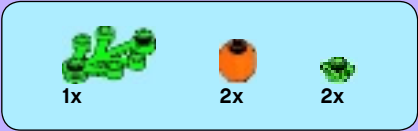

# 7

1



2

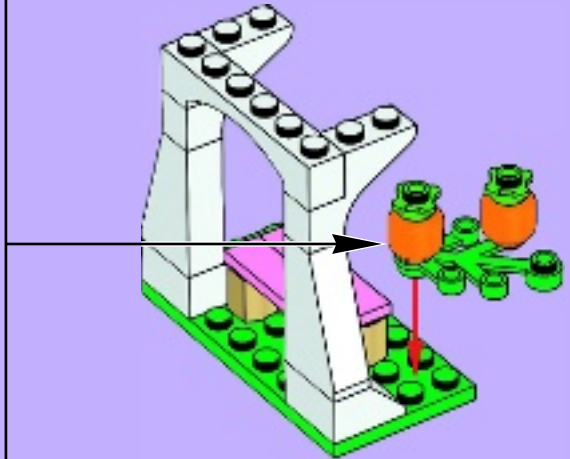
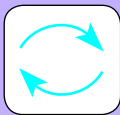
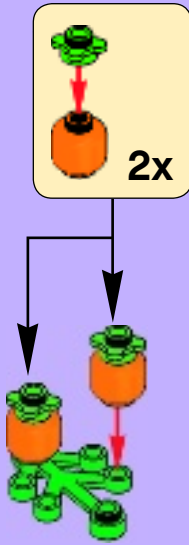



8

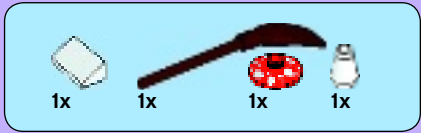
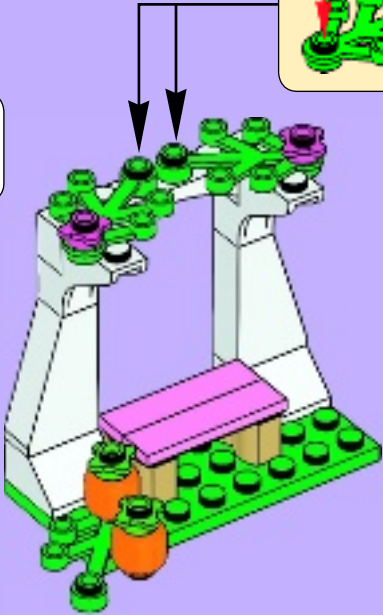
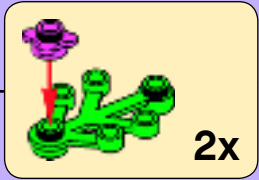

9





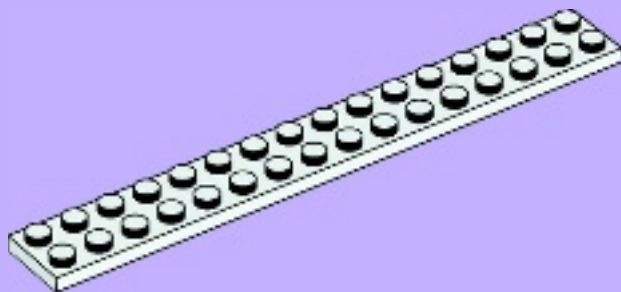
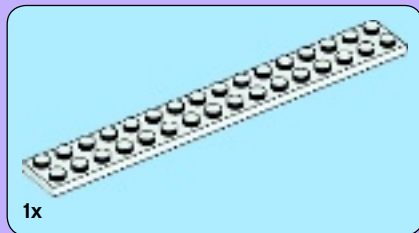
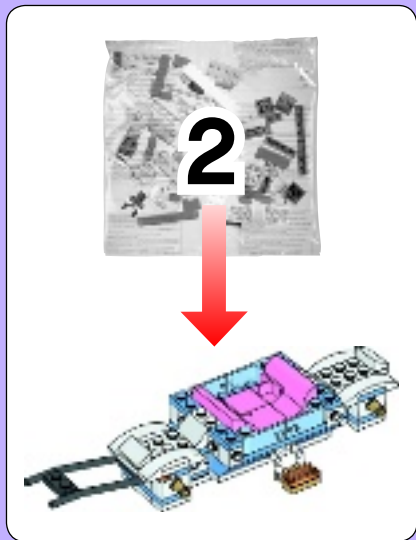



2

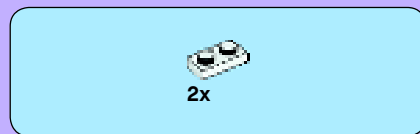
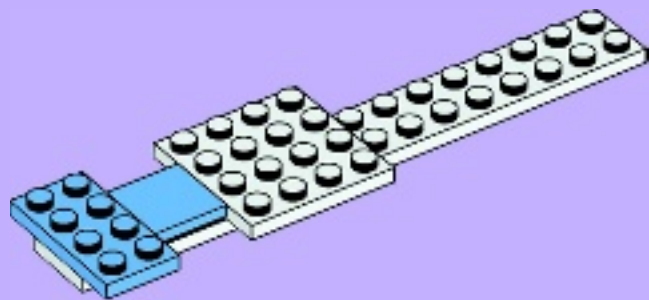

3

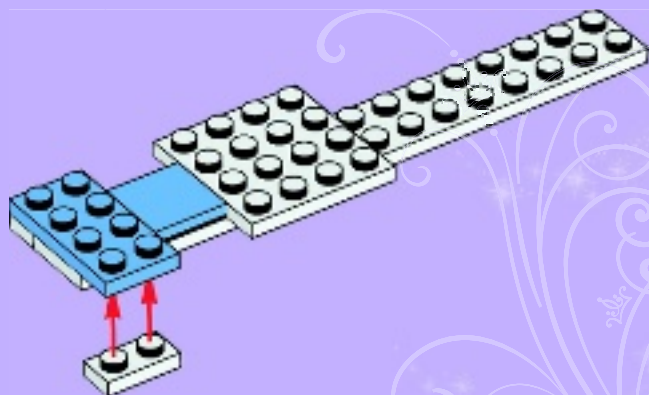



4

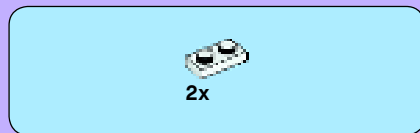
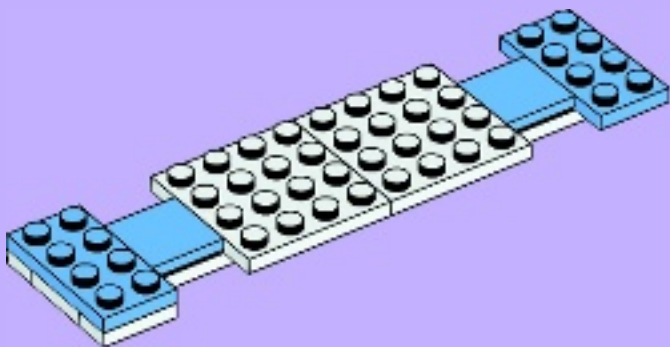

5

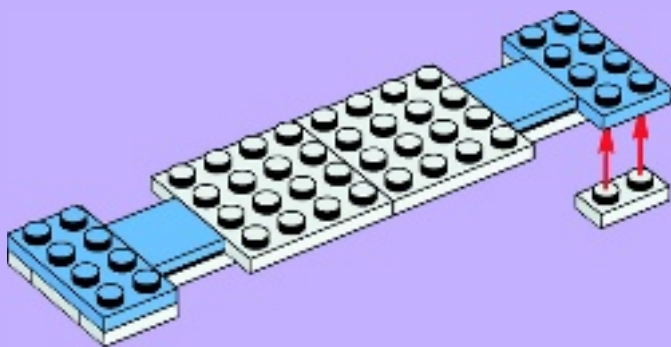



6

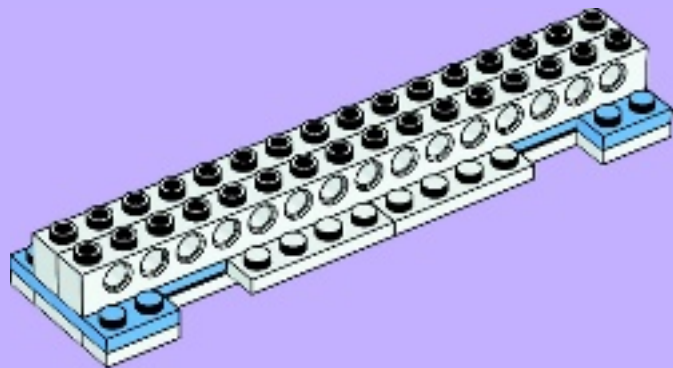

7

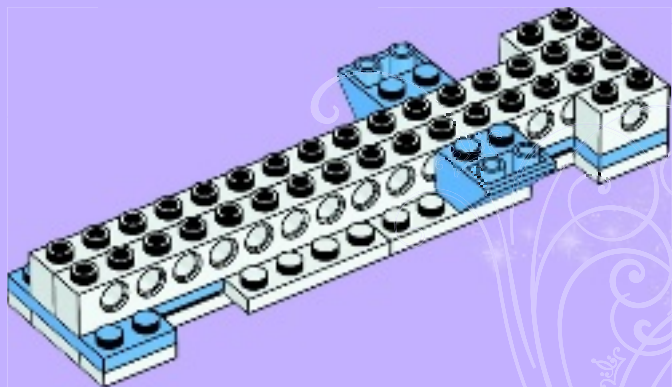



2x



4x

8

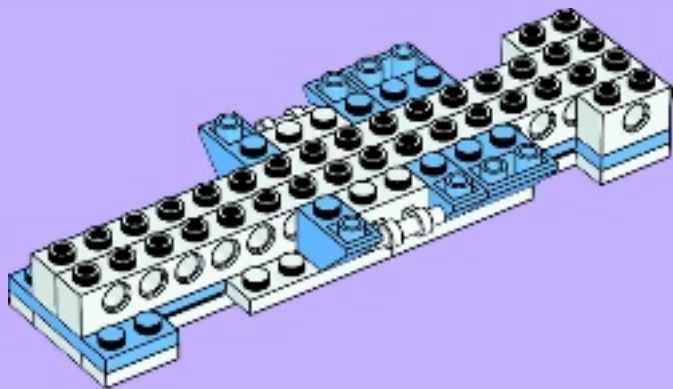

2x



2x

9

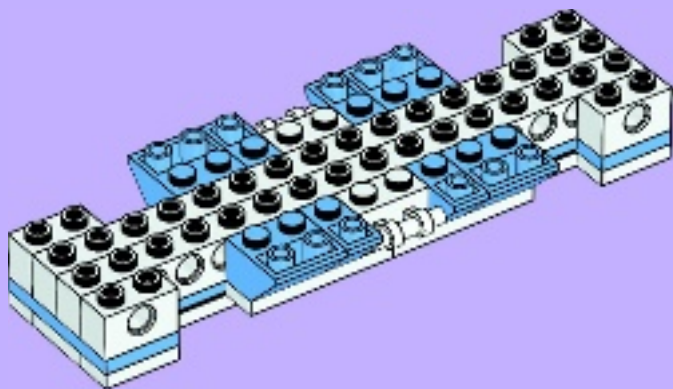



4x

# 10

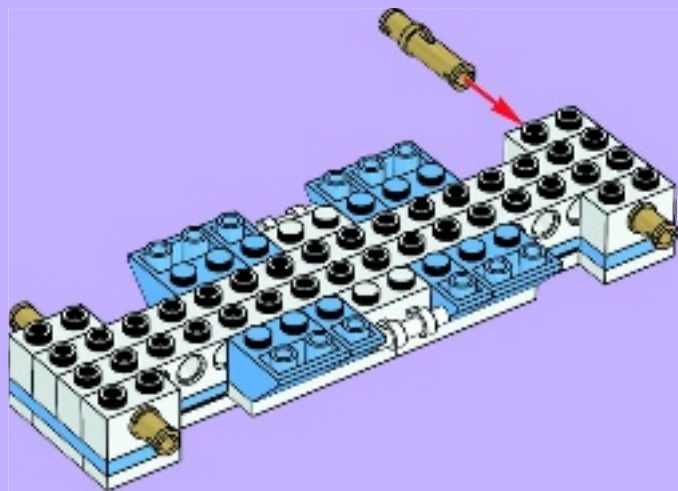

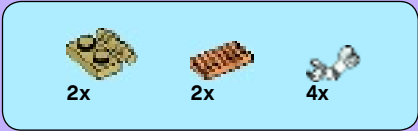

11

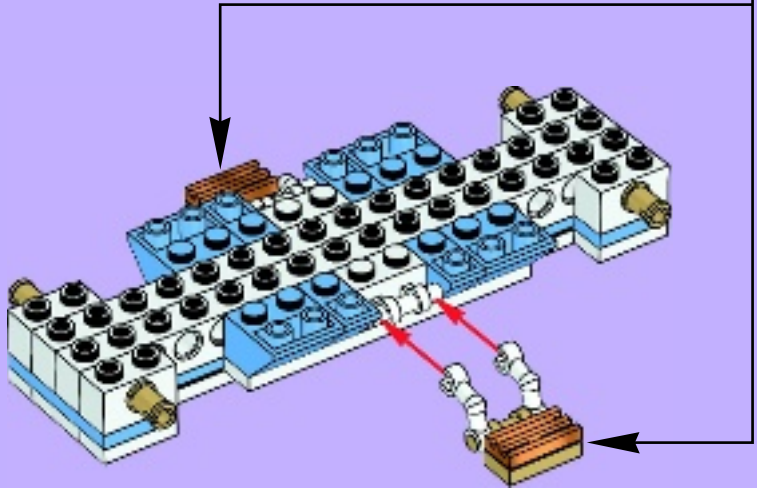
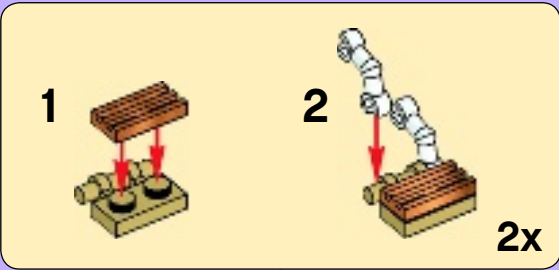





4x

# 12

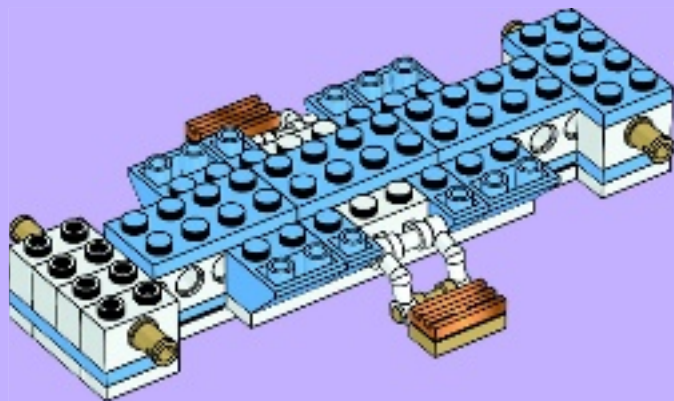

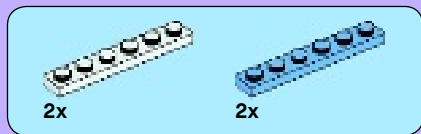

# 13

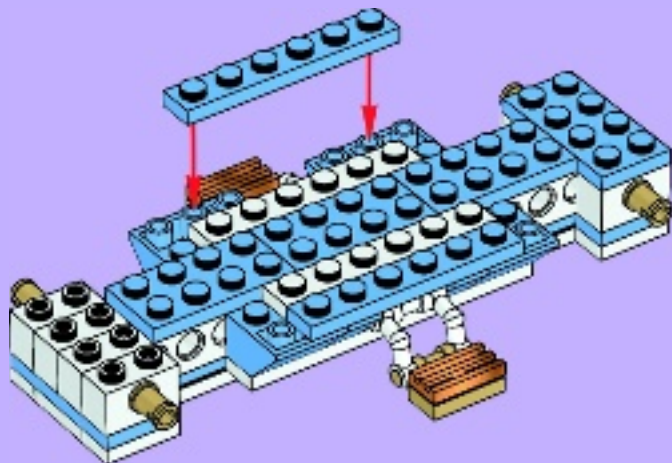



4x



1x

# 14

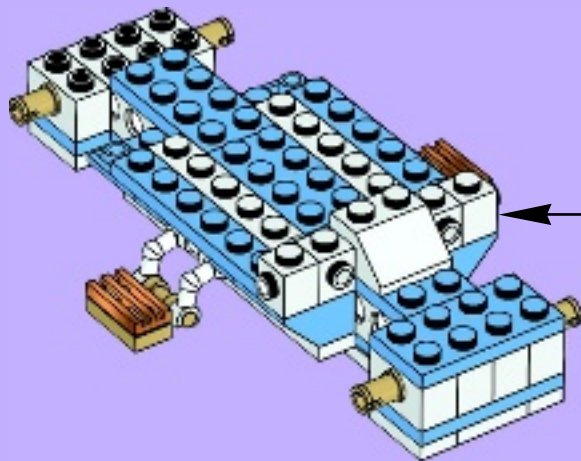
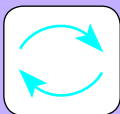



1x

# 15

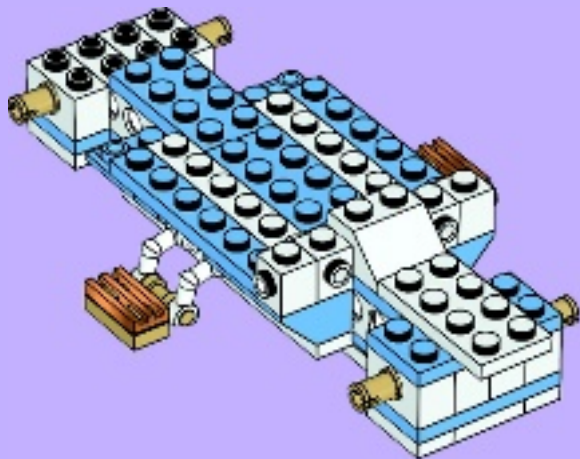



1x



2x

# 16

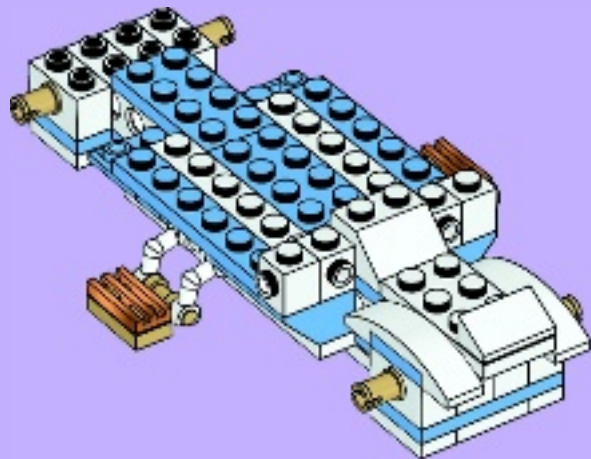



2x



1x

# 17

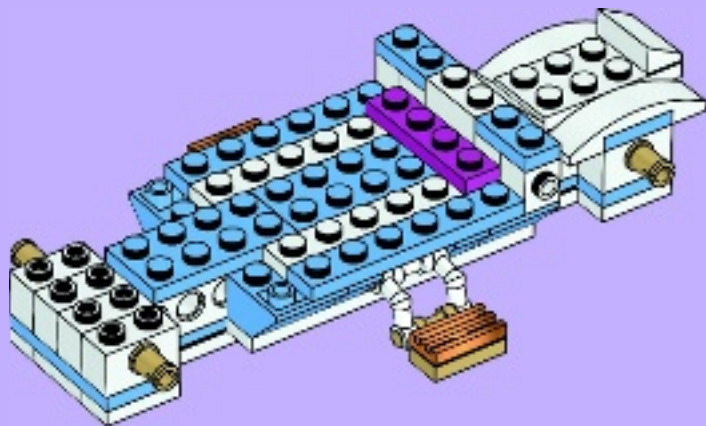
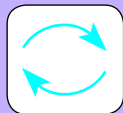



1x

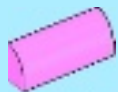

1x

# 18

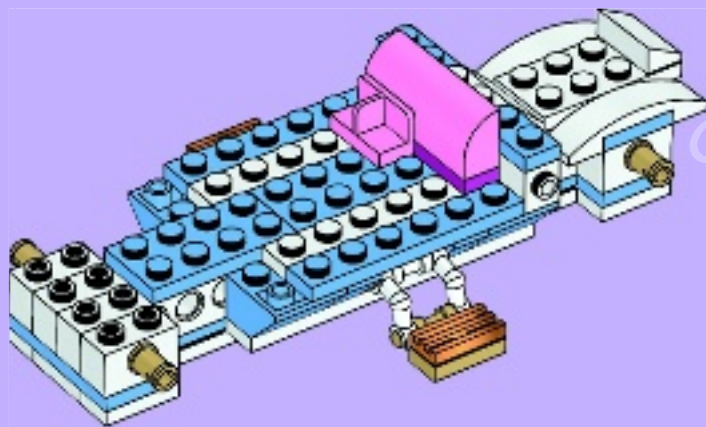





2x



1x

# 19

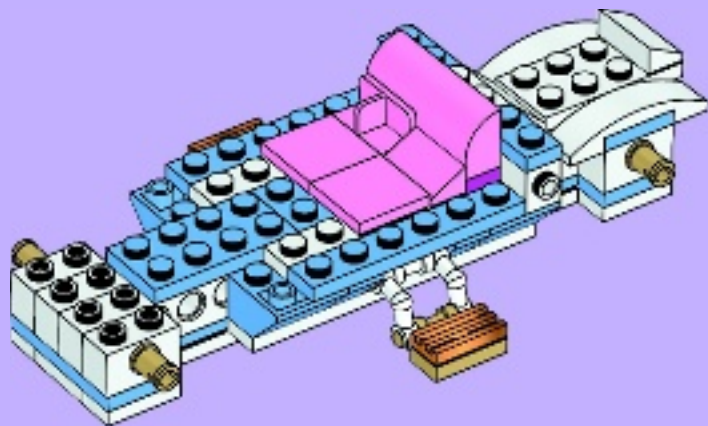



1x



1x



1x

# 20

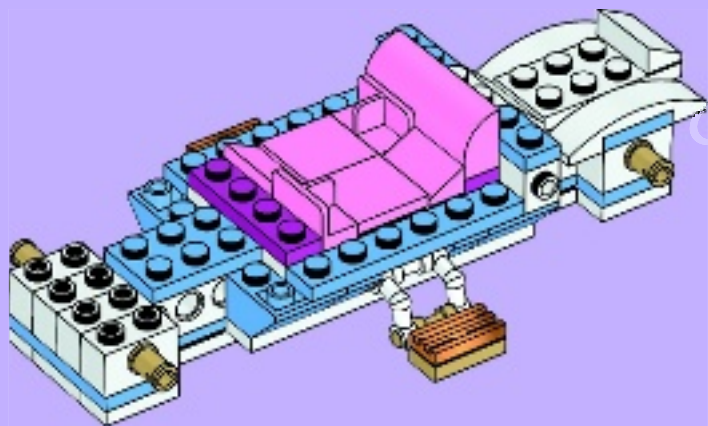

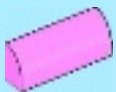

1x

# 21

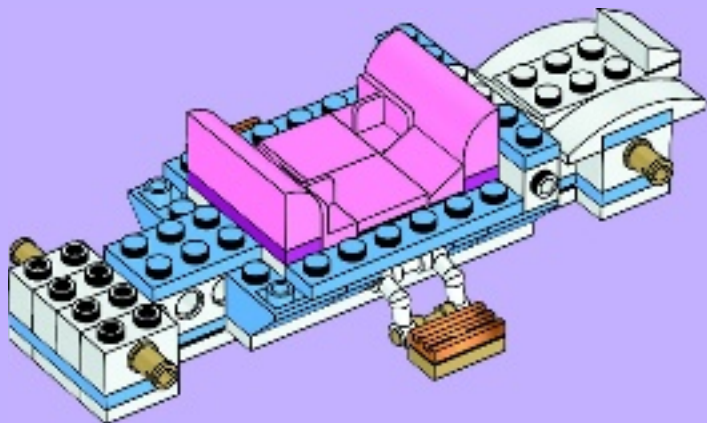



2x



2x

# 22

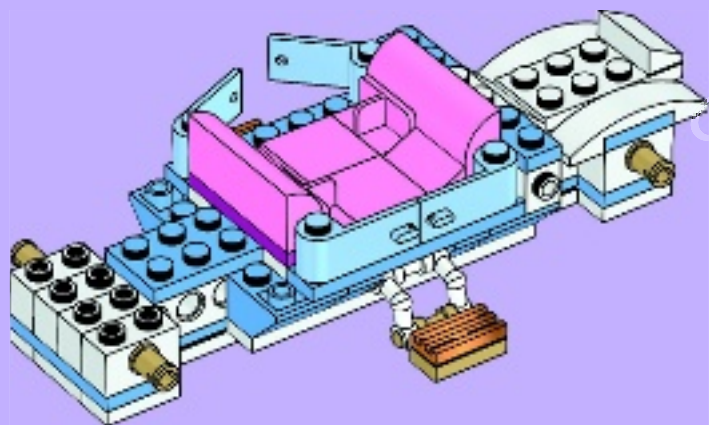



4x

# 23

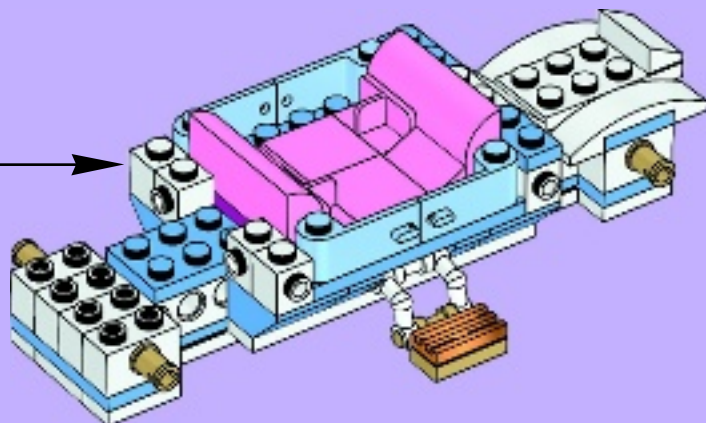



1x



2x

# 24

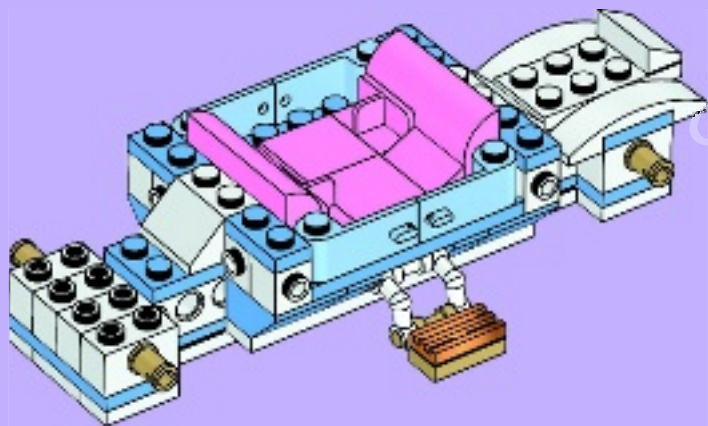

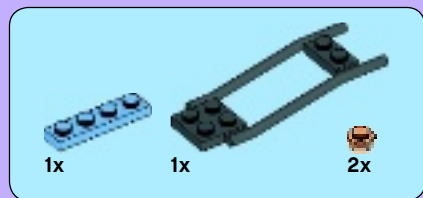

25

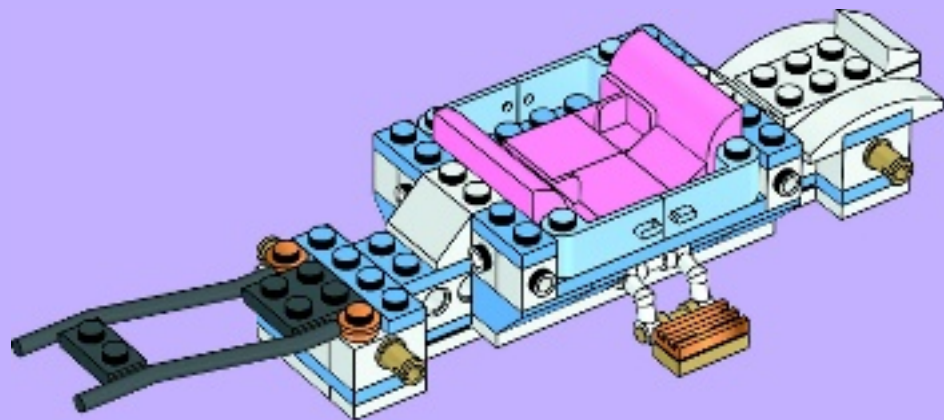



1x



2x

# 26

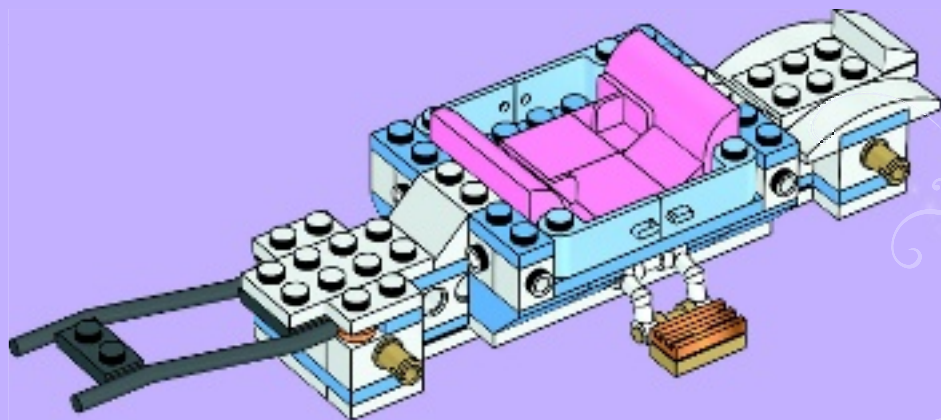





1x



2x

# 27

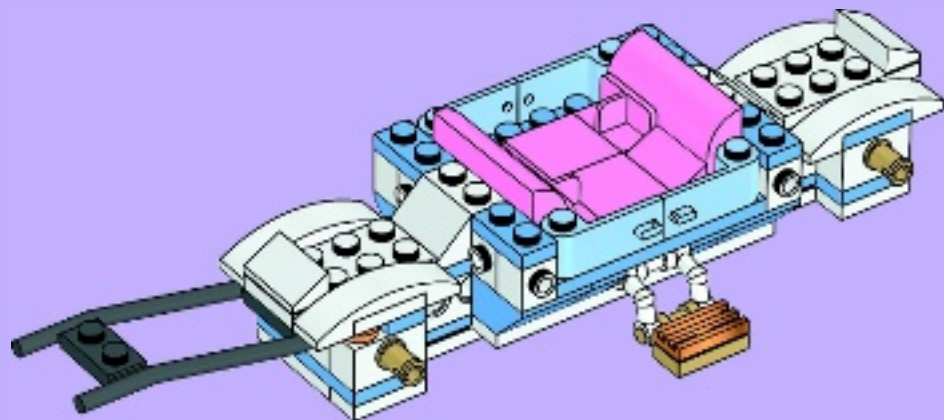

3



2x



2x



28

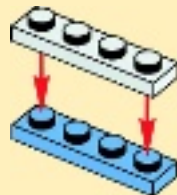

2x

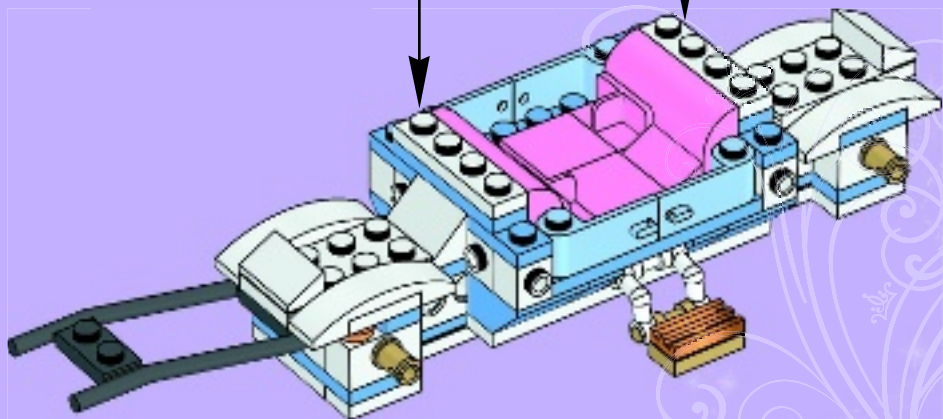

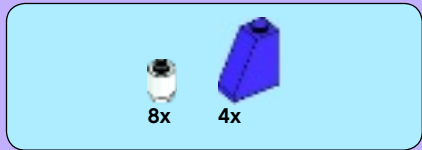

29

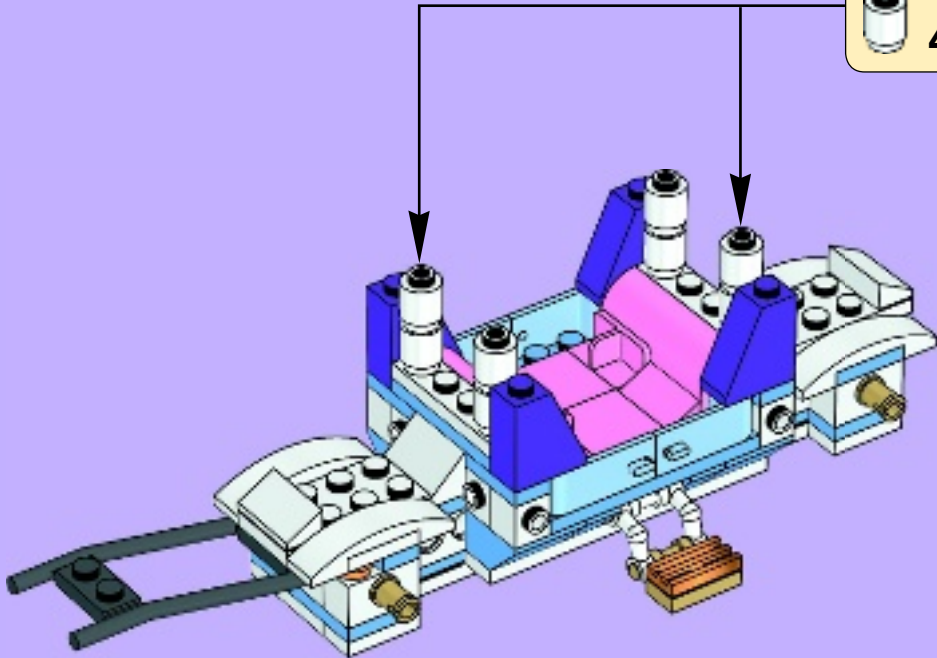
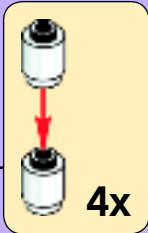



2x



2x

# 30

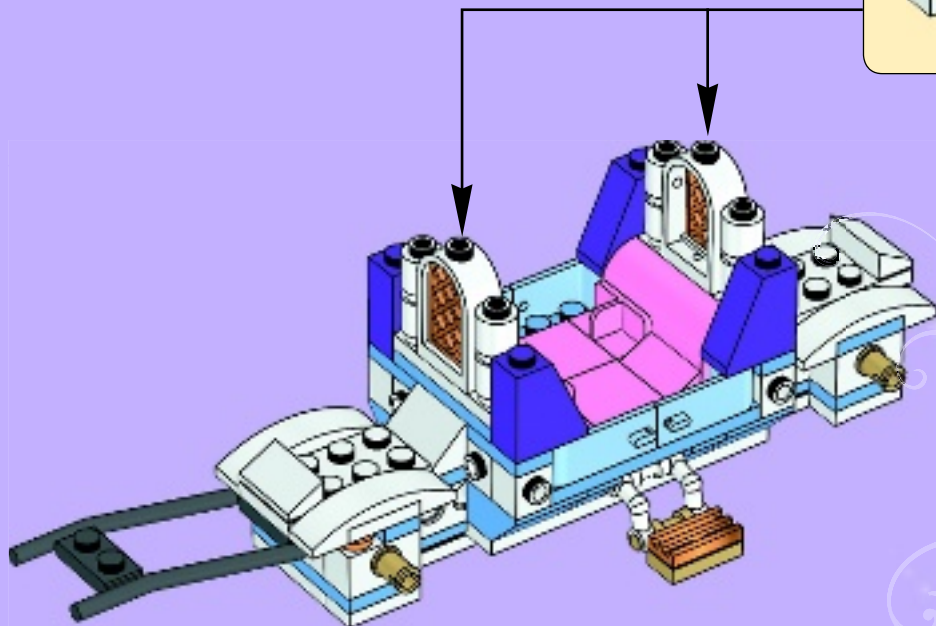



4x

# 31



4x

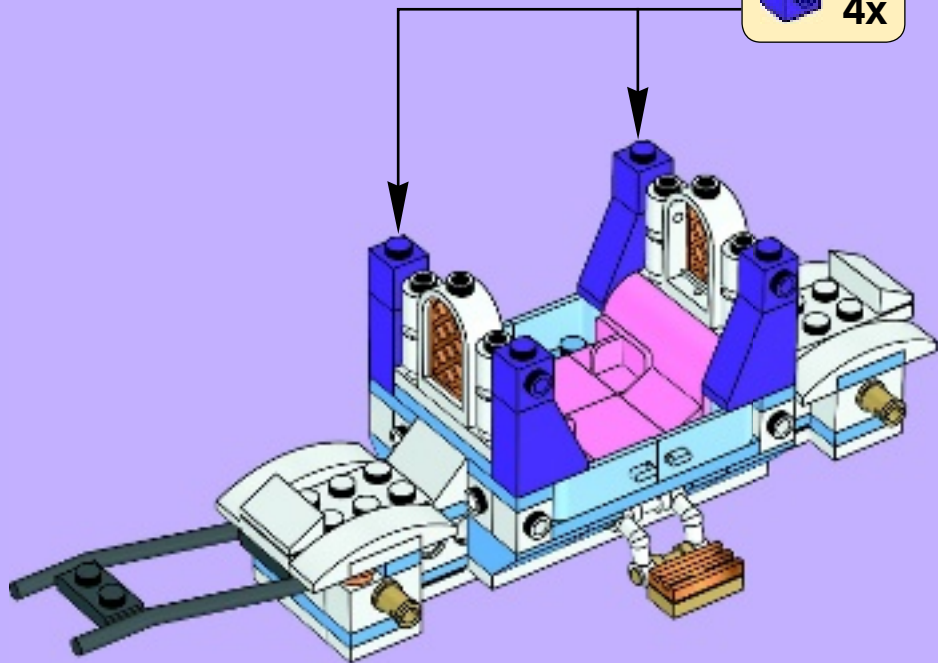



2x



4x

# 32

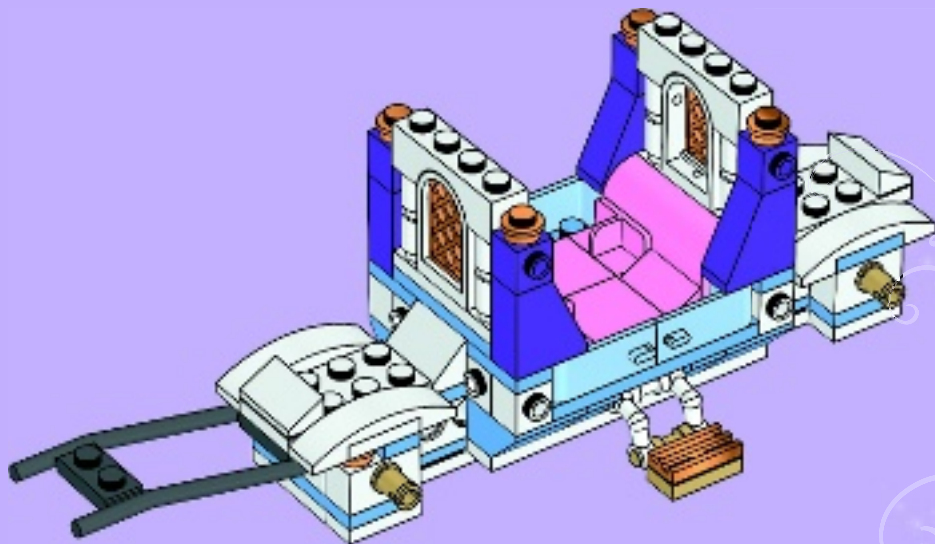



4x



4x

# 33



2x

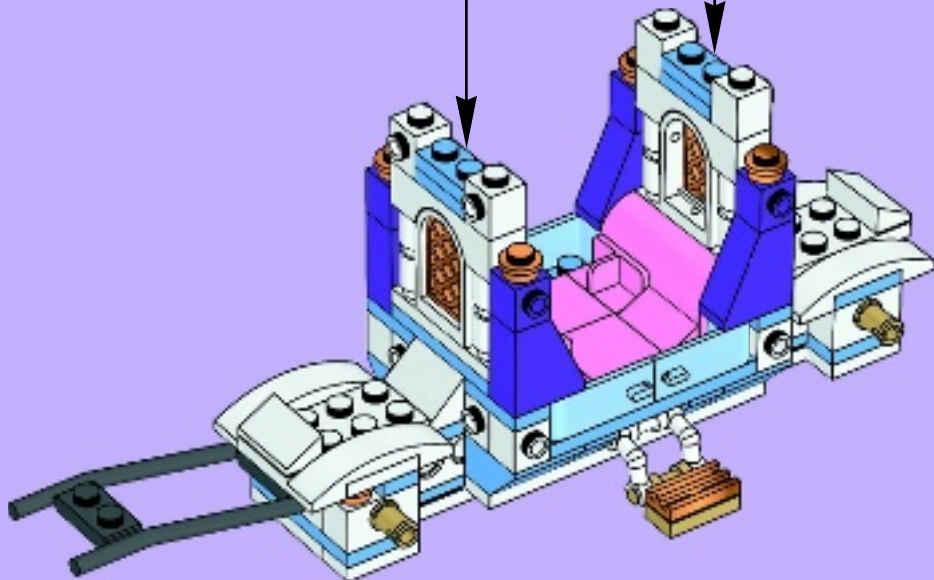



4x



4x

# 34



4x

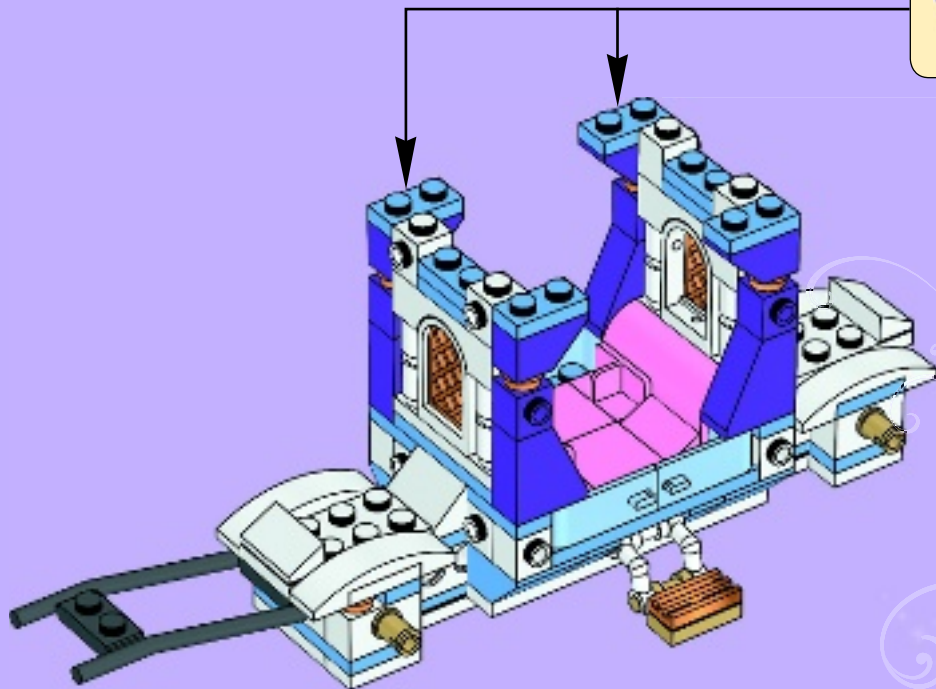



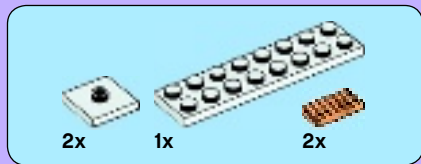

35

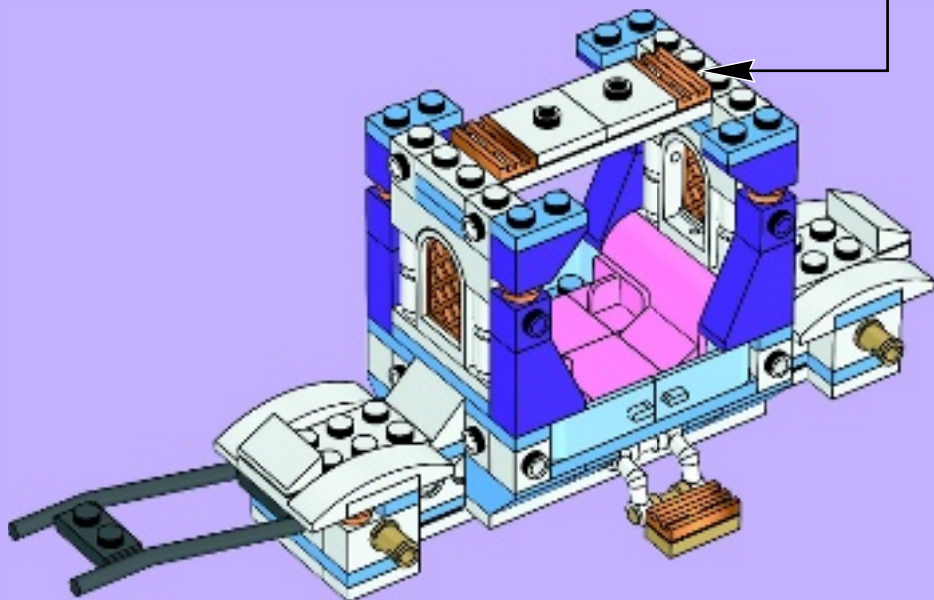



4x



4x

# 36

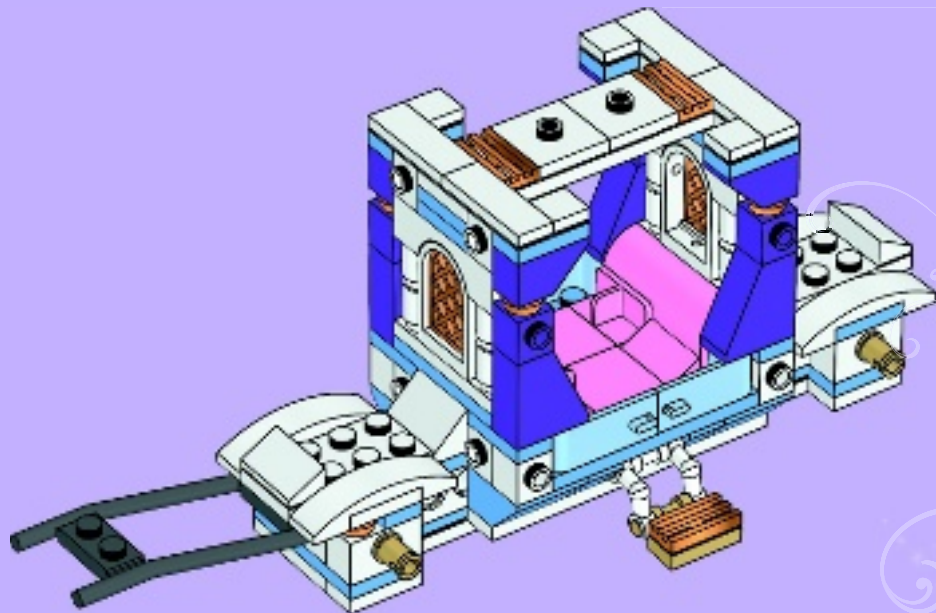

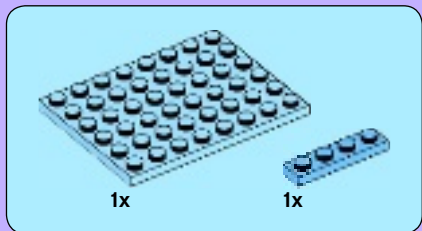

1



2

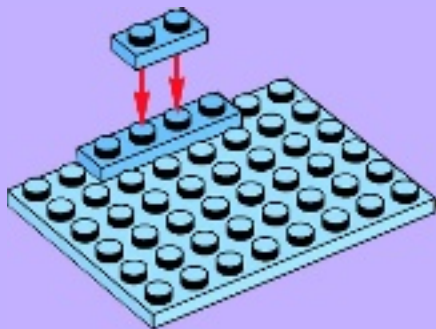



2x

3

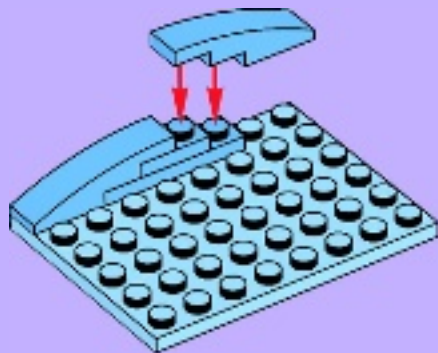

1x



1x

4





1x



1x

5

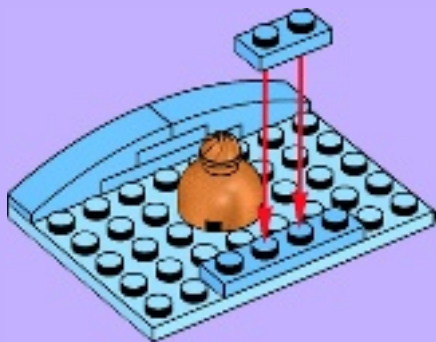

2x

6

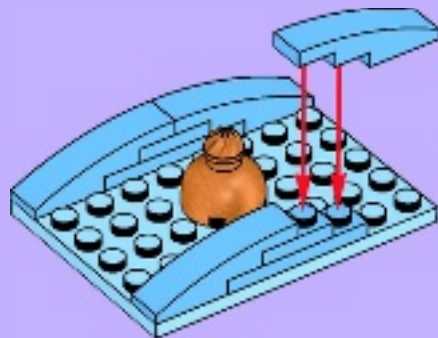

37

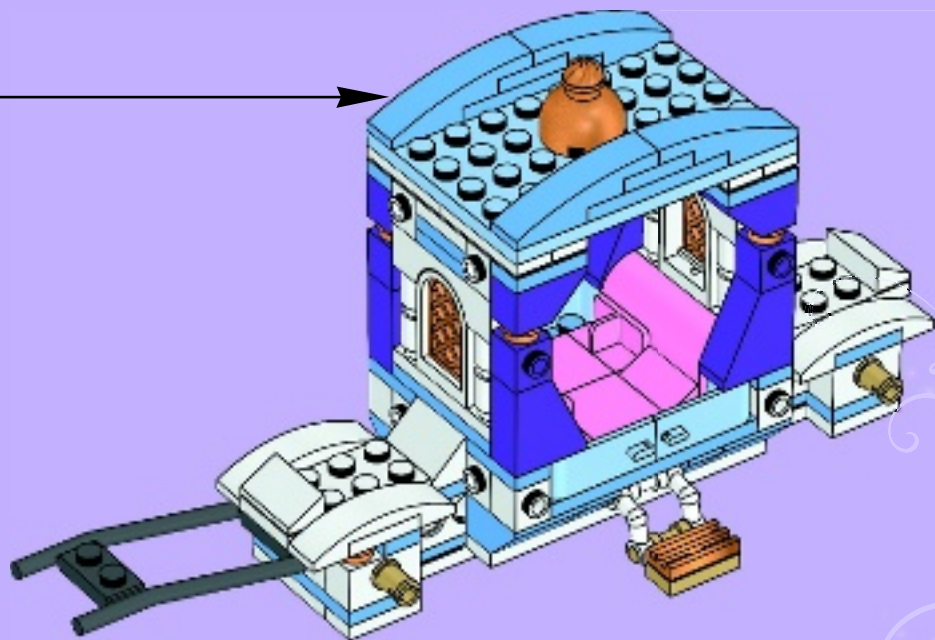



# 38

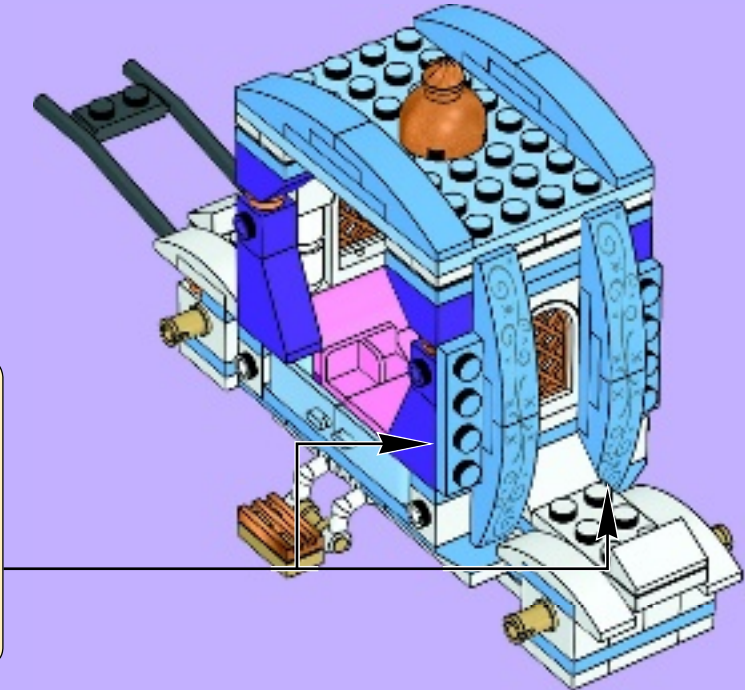
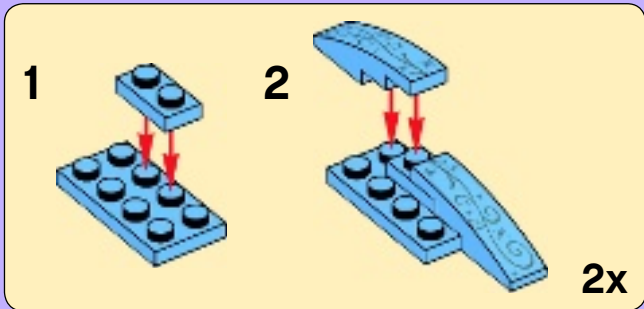
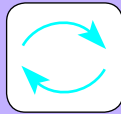





# 39

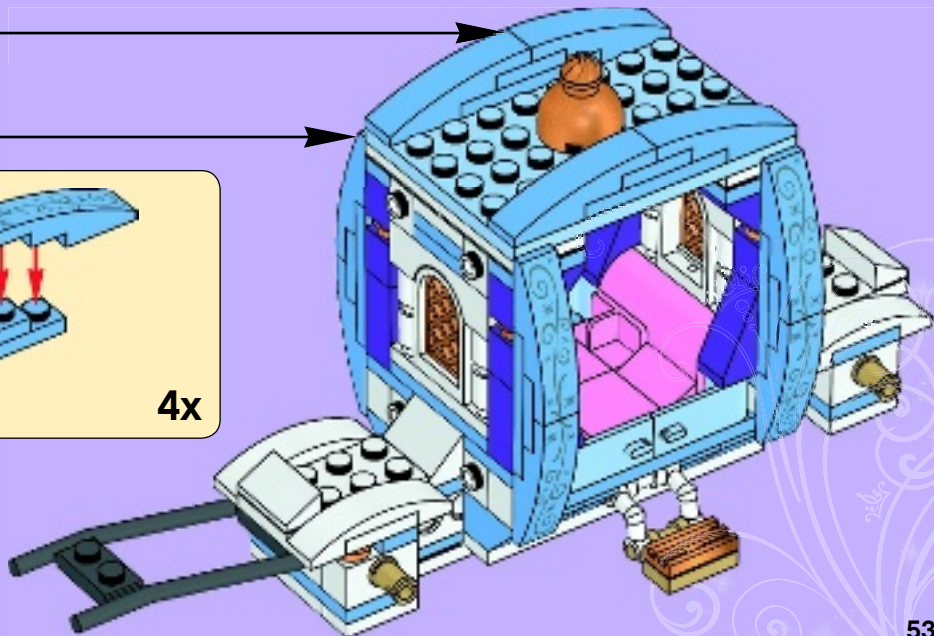
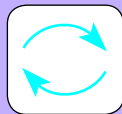
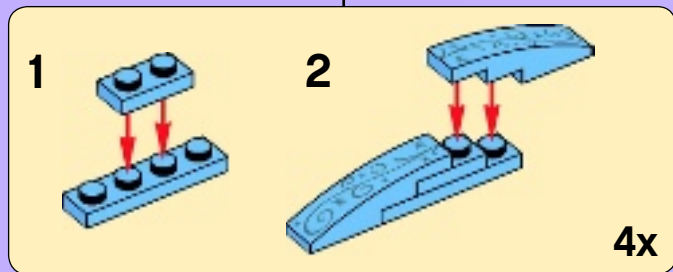





40

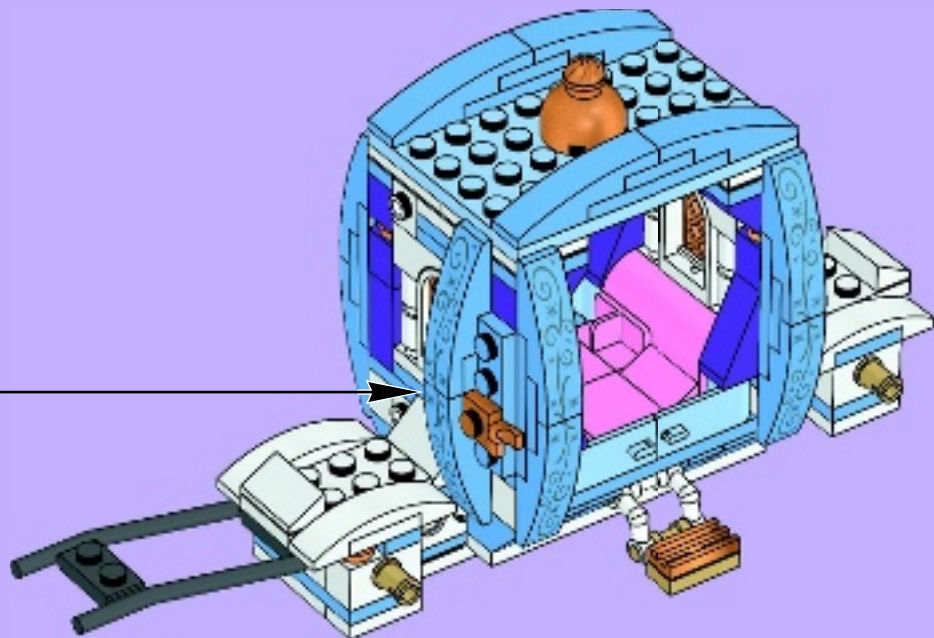
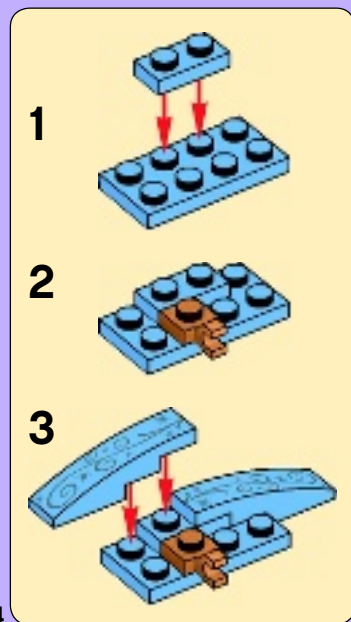



# 41

1

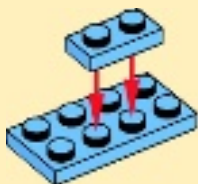

2



3

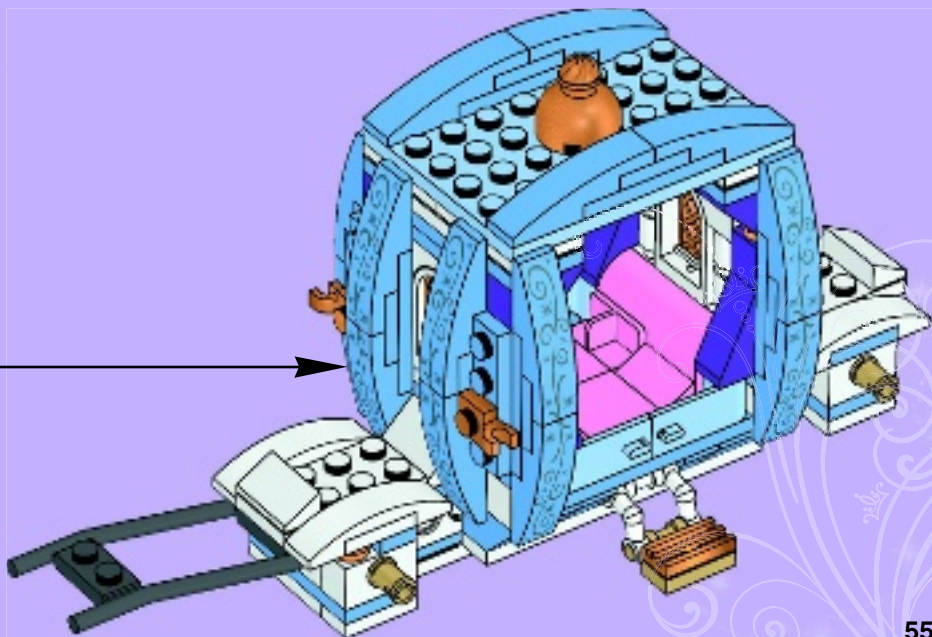
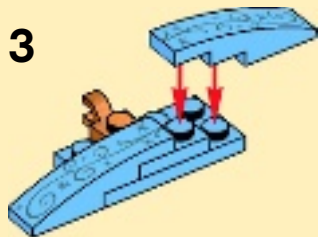



2x



2x

# 42

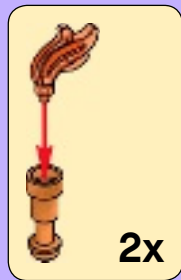

2x

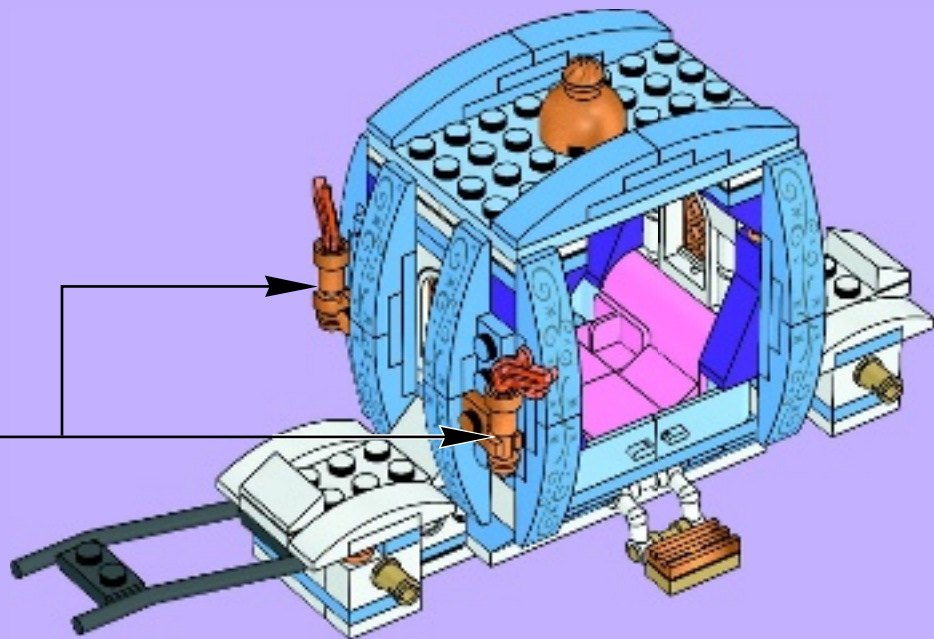



4x

43

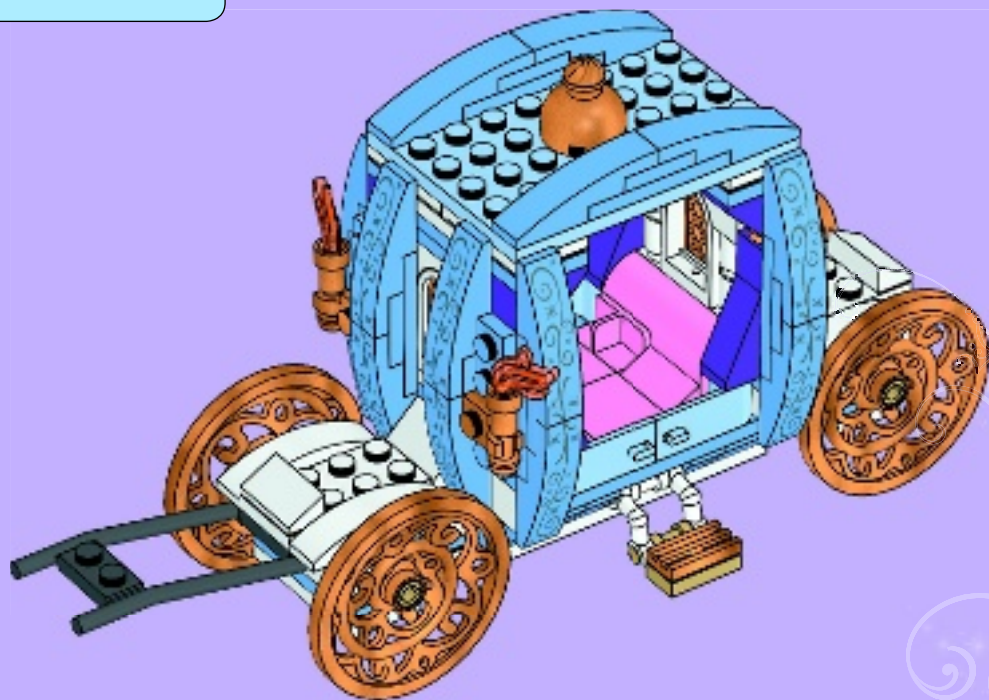



3x

# 44

1

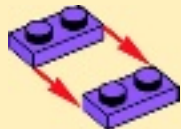

2

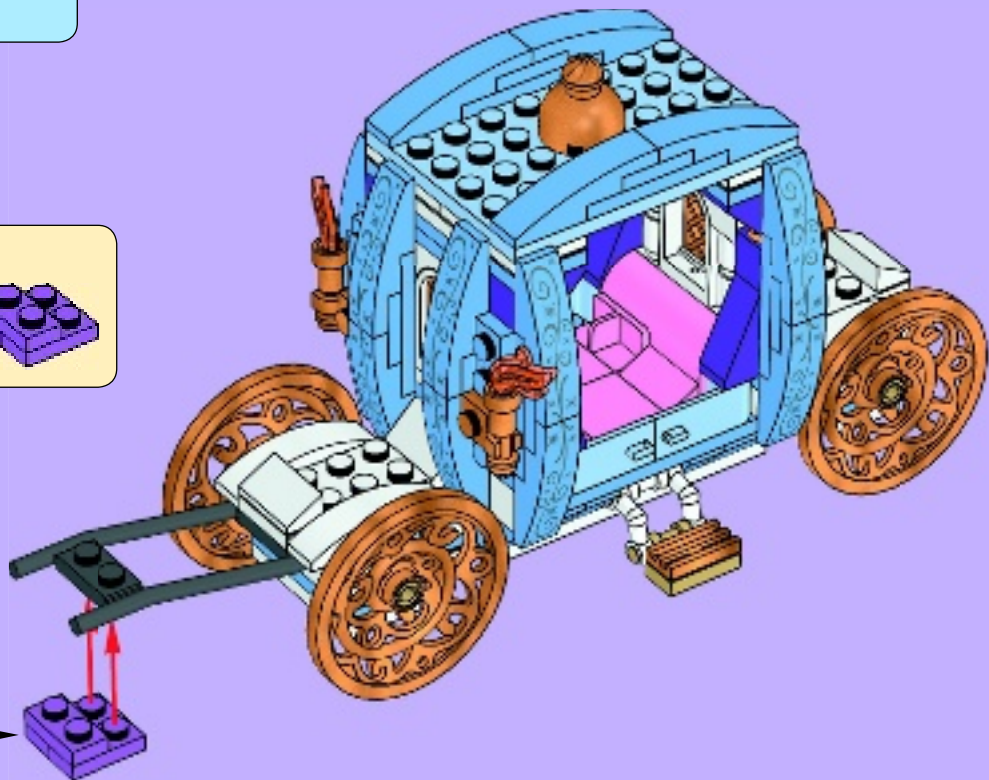





2x

45

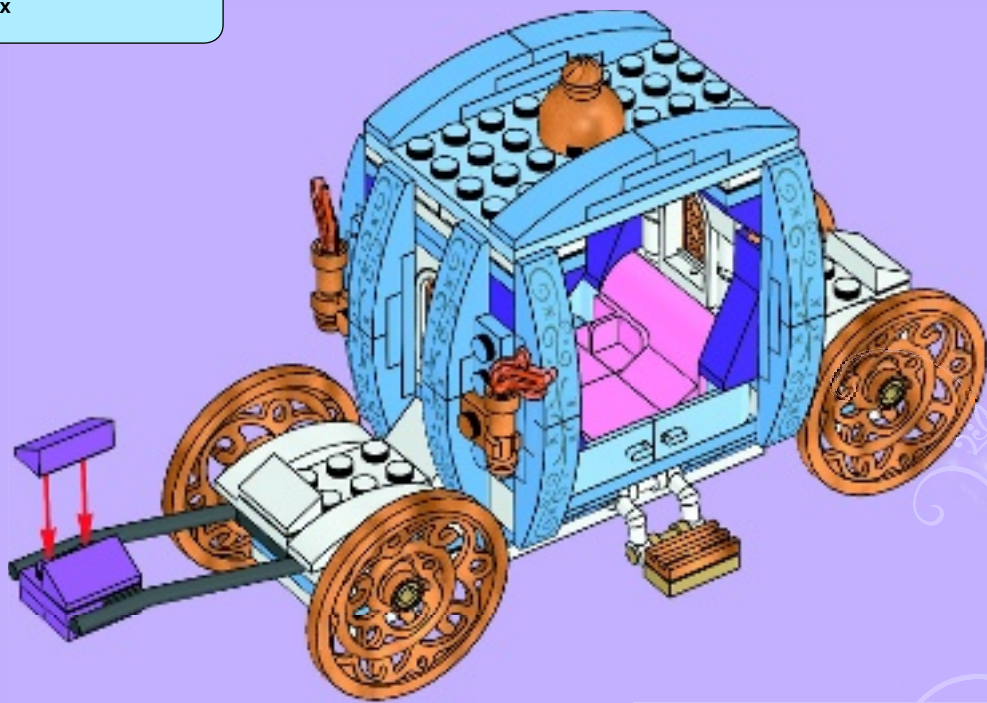

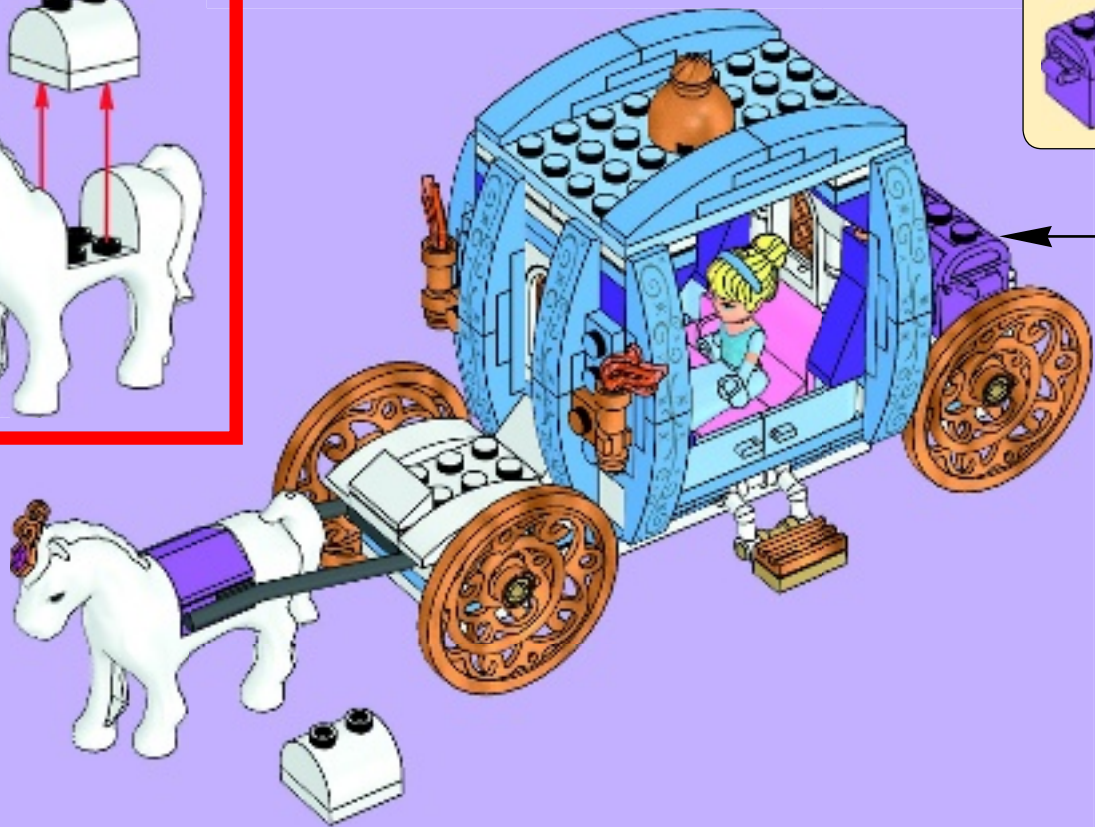
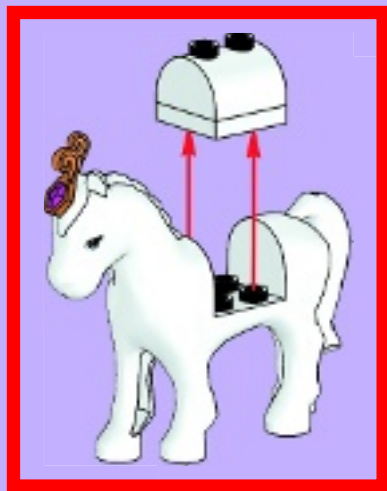







41051



41050



[LEGO.com/disneyprincess](https://LEGO.com/disneyprincess)



41054

41055

41052

41053





Friends

# Heartlake City



41035



41039



41037



[LEGO.com/friends](http://LEGO.com/friends)



Emma

Stephanie

Olivia

Andrea

Mia



[LEGO.com/disneyprincess](http://LEGO.com/disneyprincess)





22x  
4179825



2x  
4528357



9x  
4179828



10x  
4650970



2x  
4179829



2x  
4511896



4x  
6058337



2x  
6037652



1x  
4597642



1x  
4268684



1x  
6056216



2x  
6055948



2x  
6055892



1x  
6055724



4x  
4216479



2x  
4649749



2x  
4599830



2x  
4615728



2x  
4621552



2x  
4599686



1x  
6055643



4x  
6063897



4x  
4656081



4x  
6022070



1x  
6058293



1x  
6017021



1x  
4529247



1x  
4569316



4x  
4490599



4x  
4523157



2x  
4523160



6x  
4523159



2x  
4541895



1x  
6074697



2x  
4538126



1x  
6050916



4x  
6058138



2x  
4625024



3x  
4619512



1x  
6056227



1x  
6056226



2x  
4508661



1x  
4119227

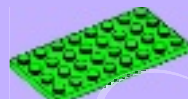

1x  
4277361

Customer Service

Kundenservice

Service Consommateurs

Servicio Al Consumidor

LEGO.com/service or dial



: 00800 5346 5555

: 1-800-422-5346





# Win!

Go to [LEGO.com/productfeedback](http://LEGO.com/productfeedback) to fill out a survey for a chance to win a cool LEGO® Product.

No purchase necessary.  
Open to all residents  
where not prohibited.



## LEGO.com/productfeedback

### Gewinne!

Nimm an der Umfrage auf [LEGO.com/productfeedback](http://LEGO.com/productfeedback) teil und hab die Chance ein cooles LEGO® Produkt zu gewinnen!

Die Teilnahme am Gewinnspiel führt zu keinerlei Kaufverpflichtungen. Teilnahme in allen nicht ausgeschlossenen Ländern möglich.

### Win!

Ga naar [LEGO.com/productfeedback](http://LEGO.com/productfeedback), vul een enquêteformulier in en maak kans op een cool LEGO® product.

Geen aankoopverplichting. Iedereen mag deelnemen, uitgezonderd ingezetenden van landen waar een enquêteverbod geldt.

### Gagne!

Visite [LEGO.com/productfeedback](http://LEGO.com/productfeedback) pour répondre à un questionnaire et avoir une chance de gagner un produit LEGO® très cool !

Aucune obligation d'achat. Ouvert à tous les résidents des pays autorisés.

### 当てよう!

[LEGO.com/productfeedback](http://LEGO.com/productfeedback)にアクセスして、アンケートにご記入ください。当選者にはレゴ製品を差し上げます。

お買い上げの必要はありません。

禁止されていない限り、すべての皆様にご利用いただけます。



[LEGO.com](http://LEGO.com)

6078353

LEGO and the LEGO logo are trademarks of the LEGO Group.  
©2014 The LEGO Group.  
© Disney