



# STAR WARS™

40658





### **Get excited about our new packaging!**

We're switching from plastic to paper-based packaging. That's why you might find a mix of paper and plastic in our boxes!

### **Nos nouveaux emballages vous emballeront !**

Nous passons des emballages en plastique aux emballages à base de papier. C'est pourquoi vous pourriez trouver un mélange de papier et de plastique dans nos boîtes !

### **¡Te presentamos nuestros nuevos empaques!**

Estamos sustituyendo las bolsas de plástico por bolsas con base de papel. ¡Por eso, puedes encontrar una mezcla de papel y de plástico en nuestras cajas!

**[LEGO.com/sustainable-packaging](https://www.lego.com/sustainable-packaging)**

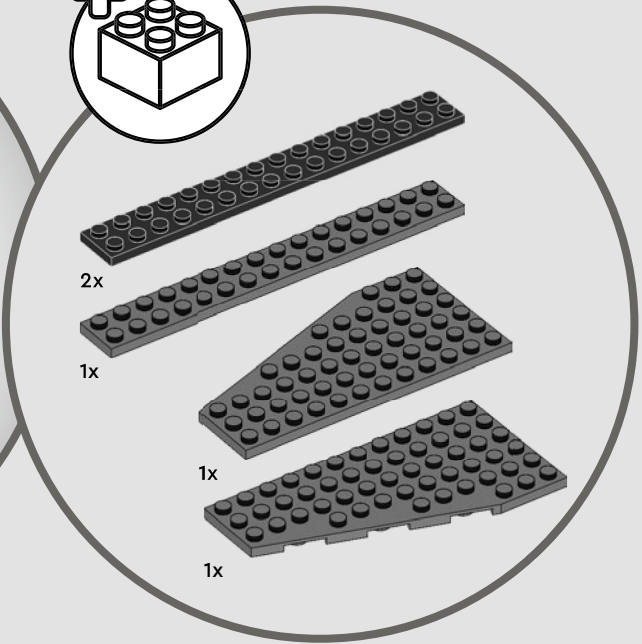
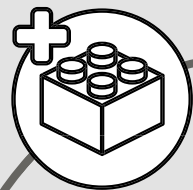

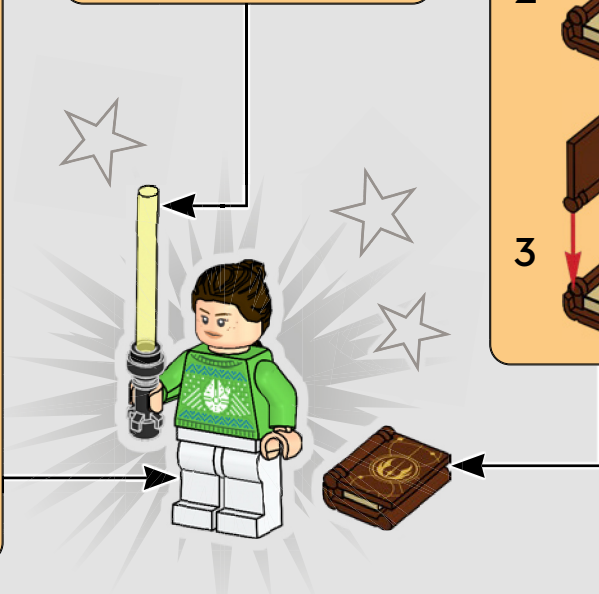
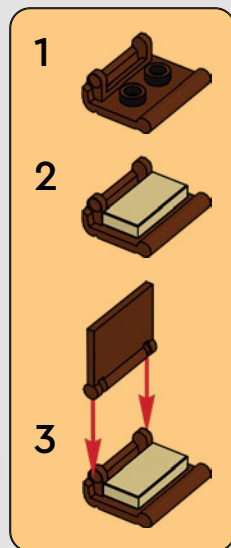
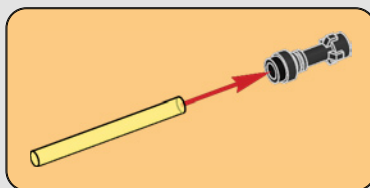
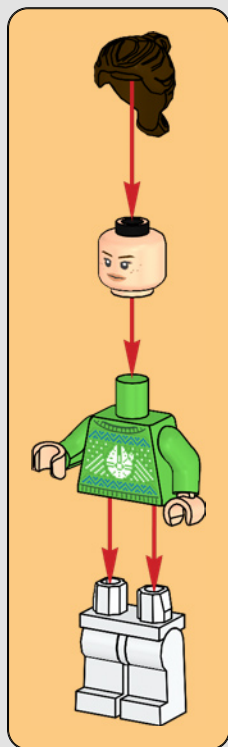

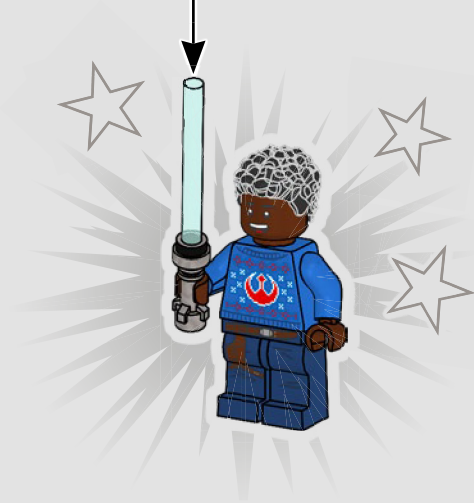
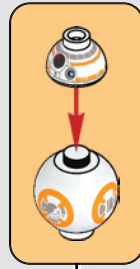
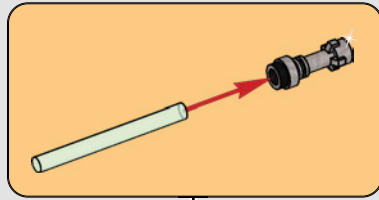

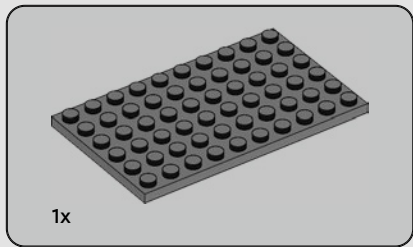

1

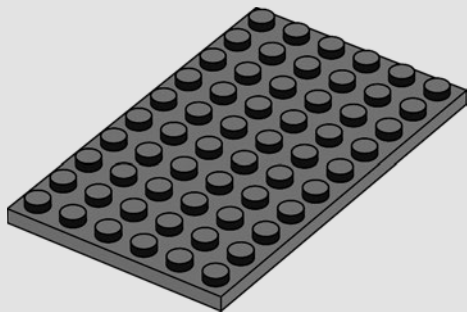

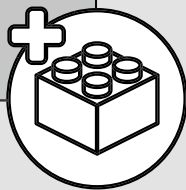
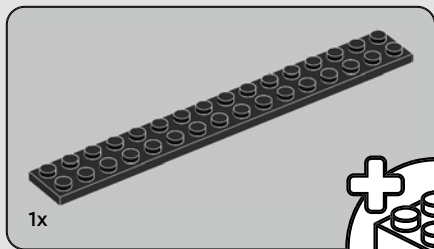

2

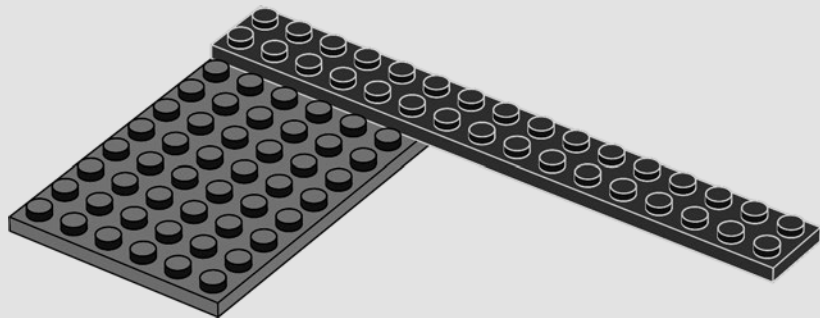

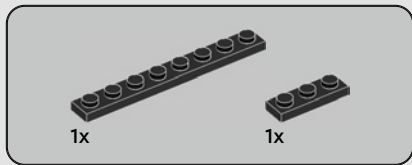

3

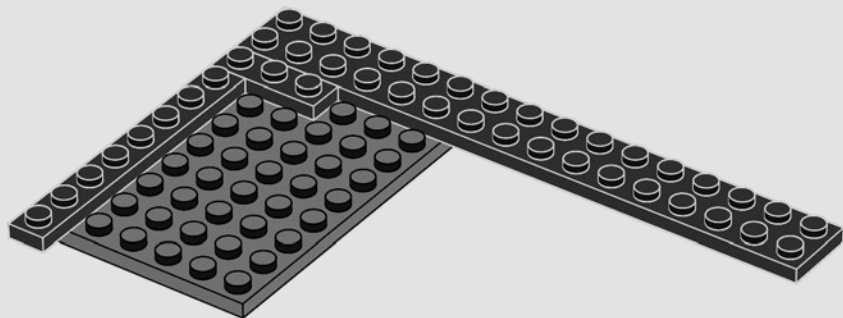



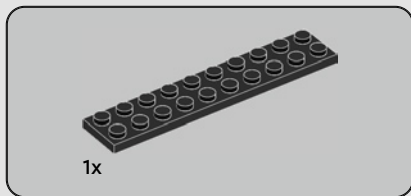

4

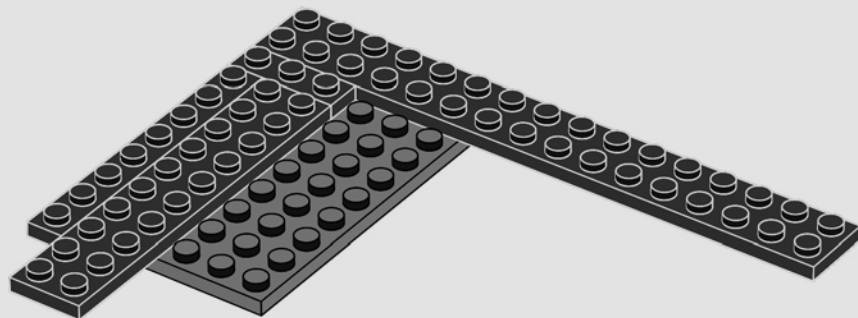

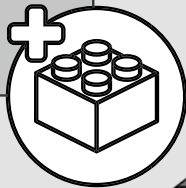
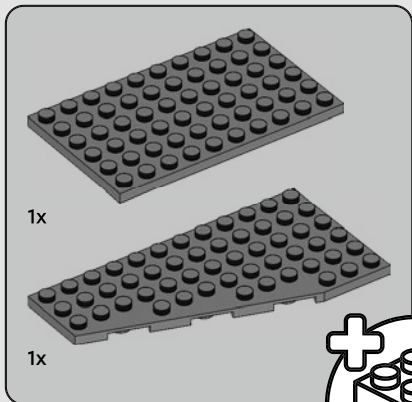

5

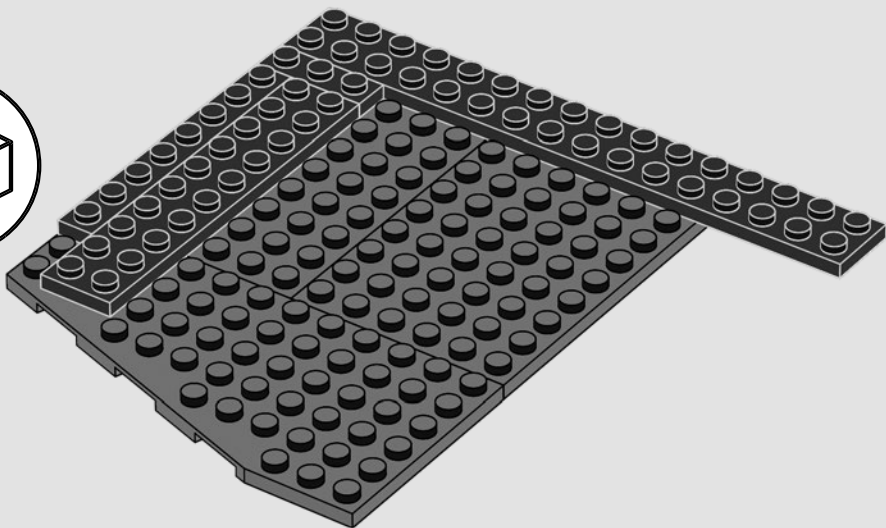

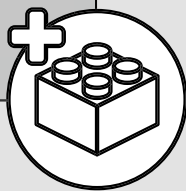
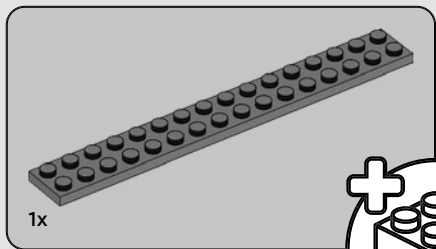

6

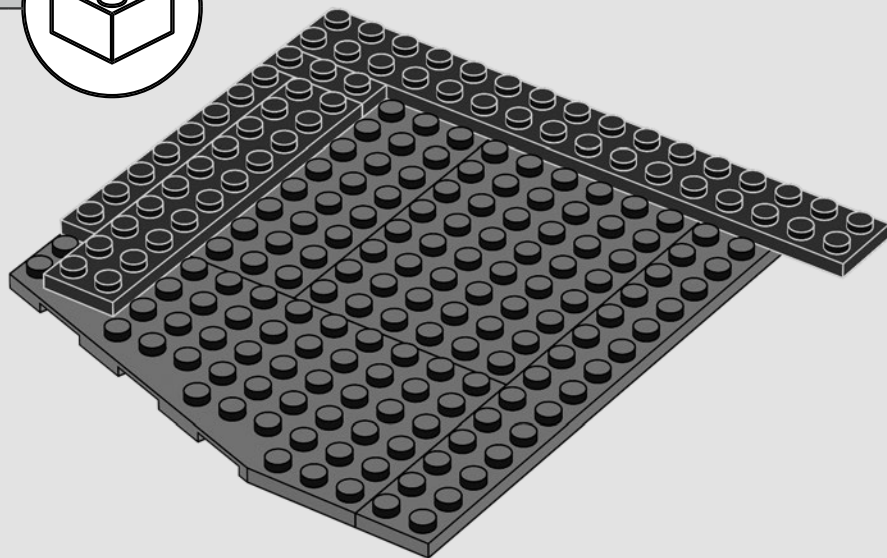

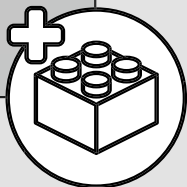
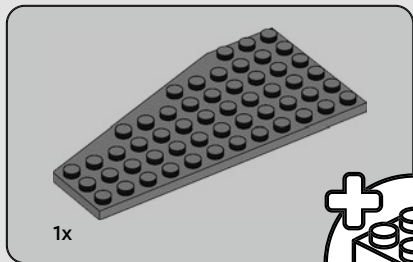

7

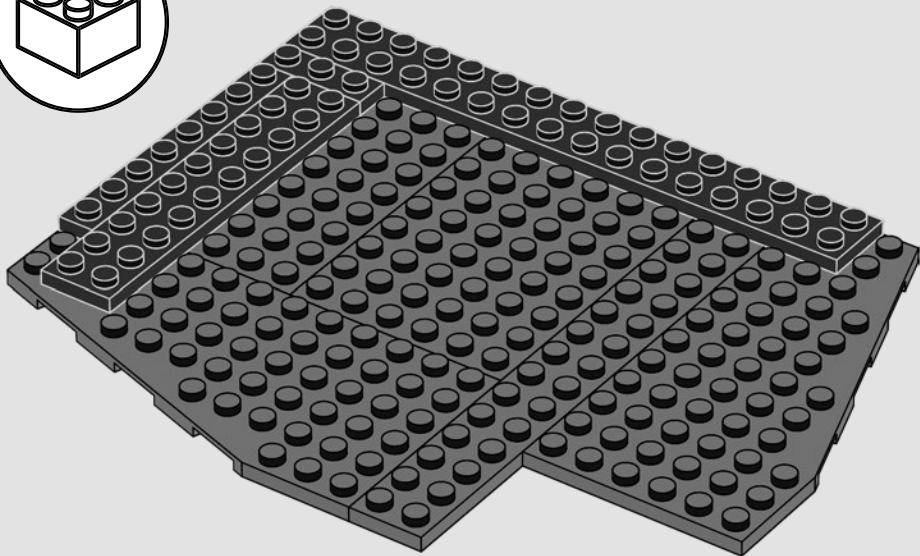

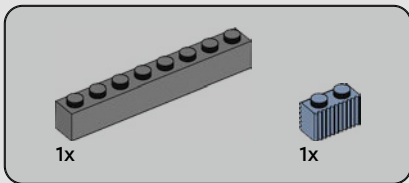

8

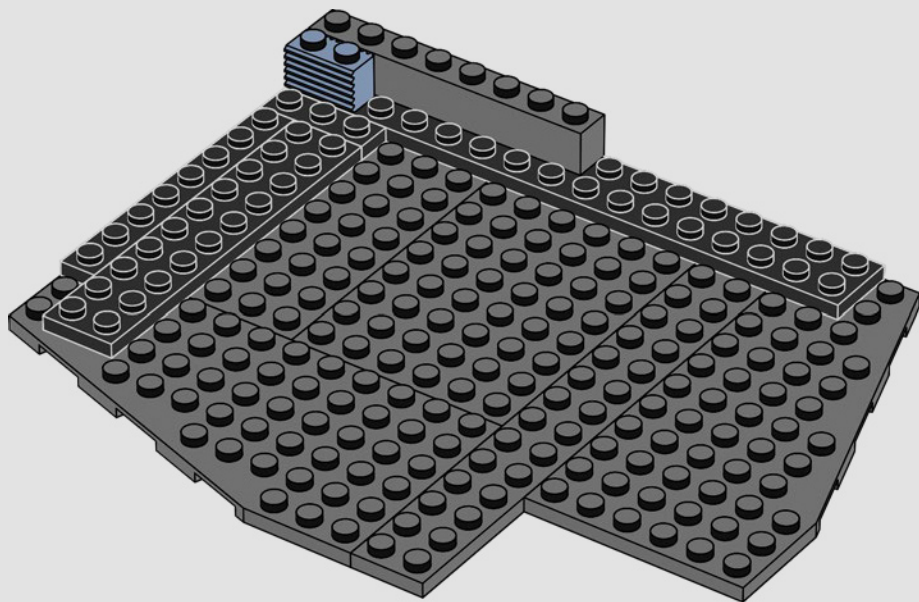

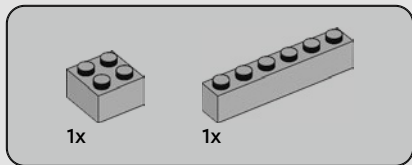

9

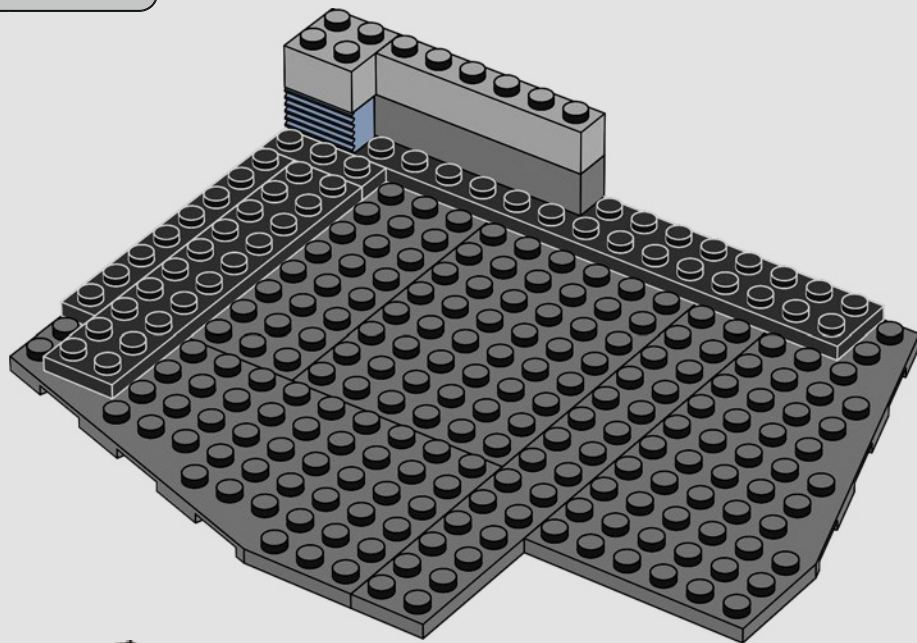

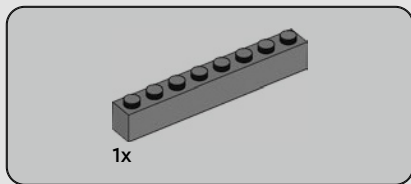

10

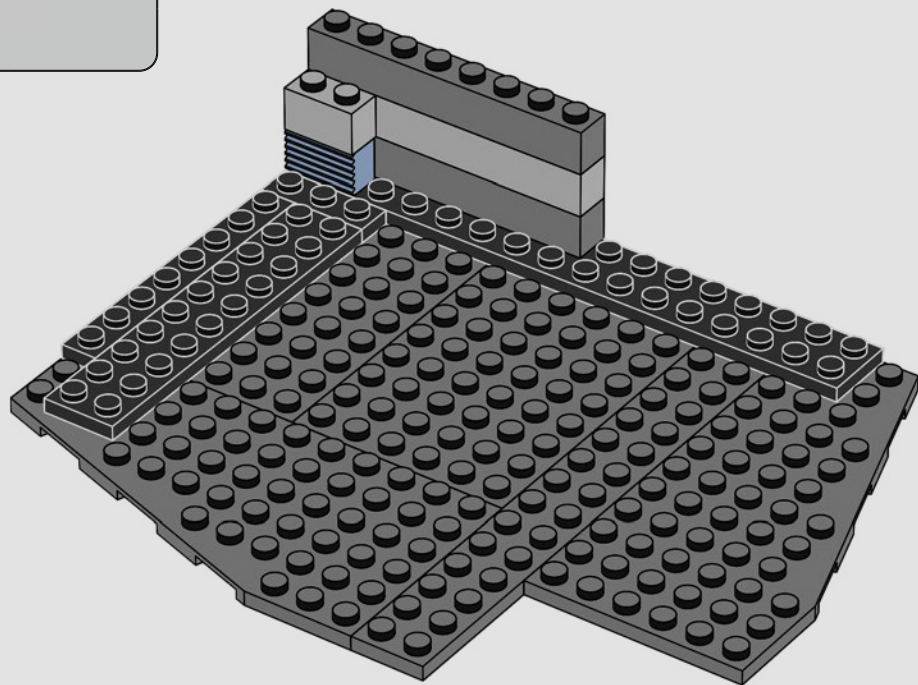

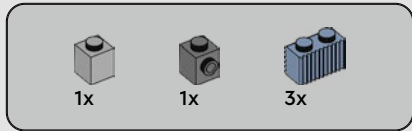

11

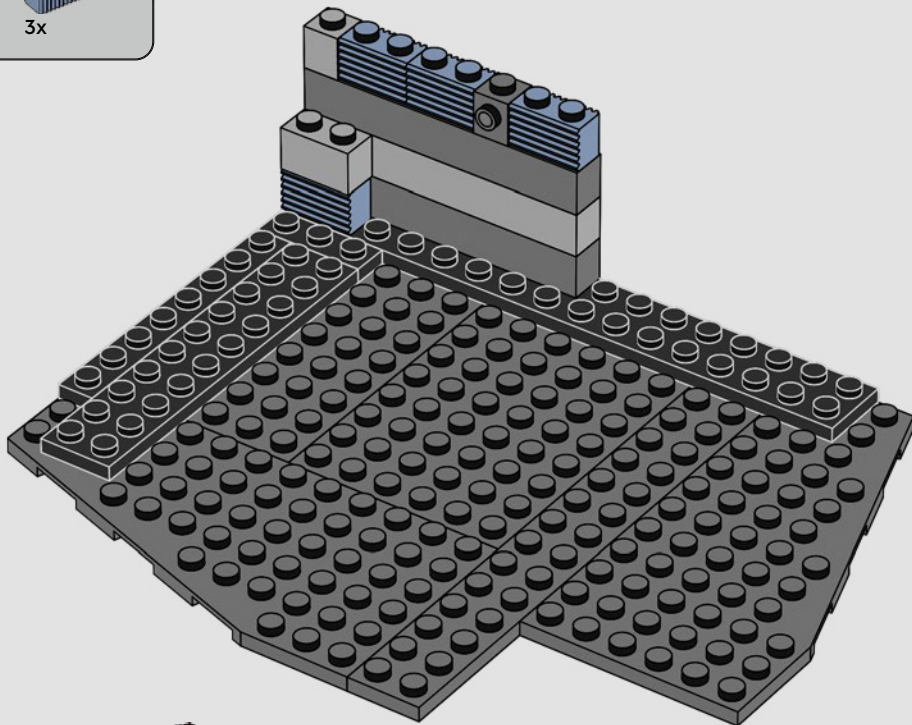



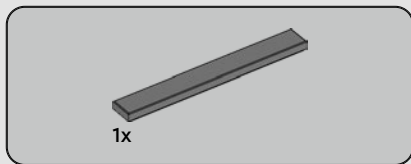

12

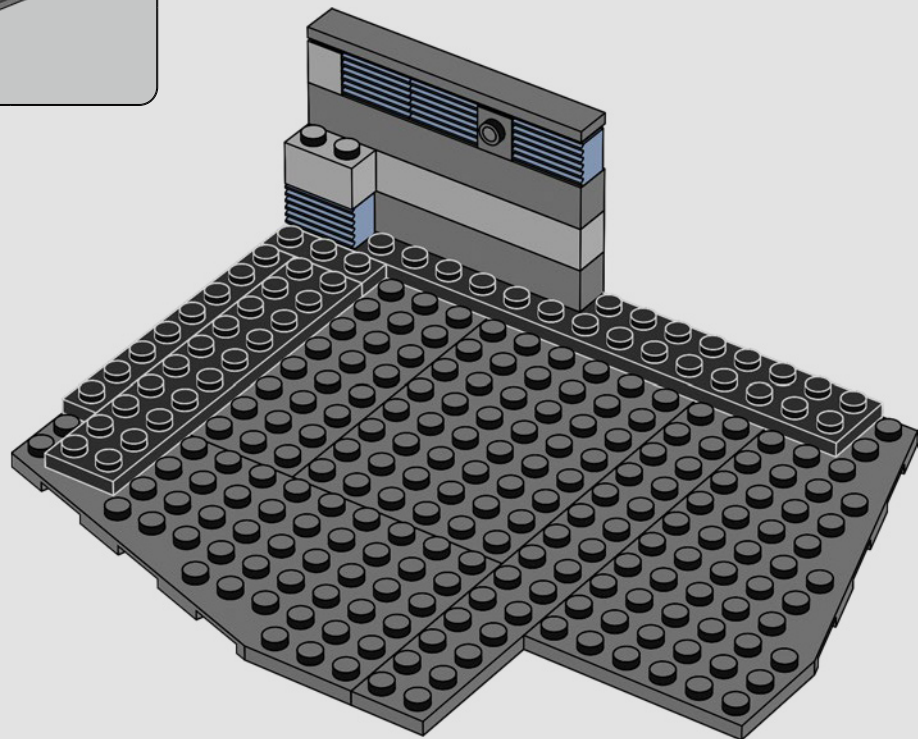



1x

13

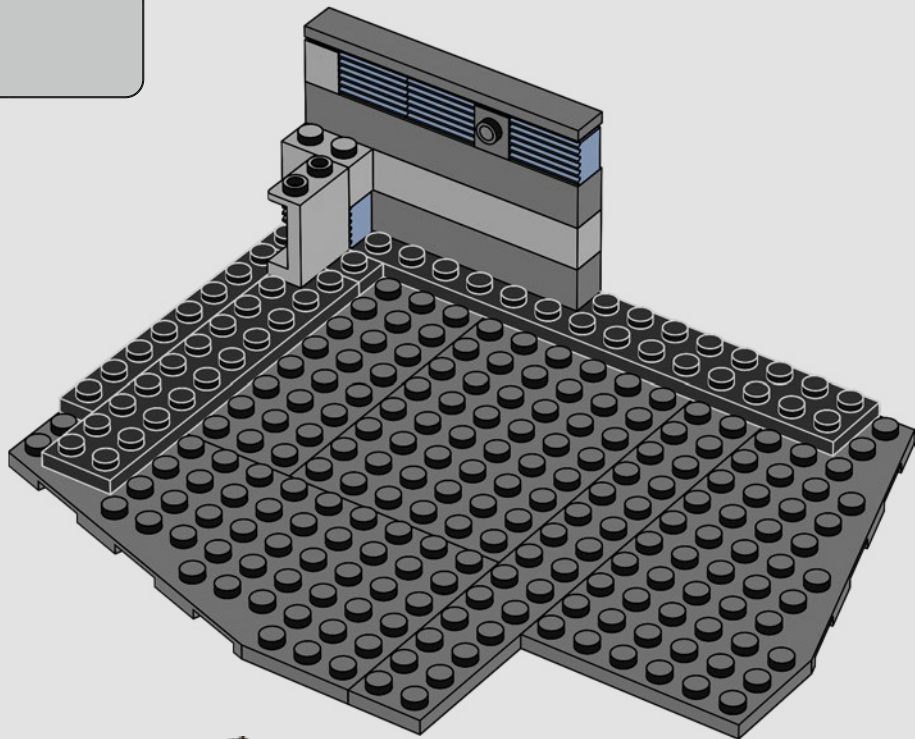



4x



2x

14

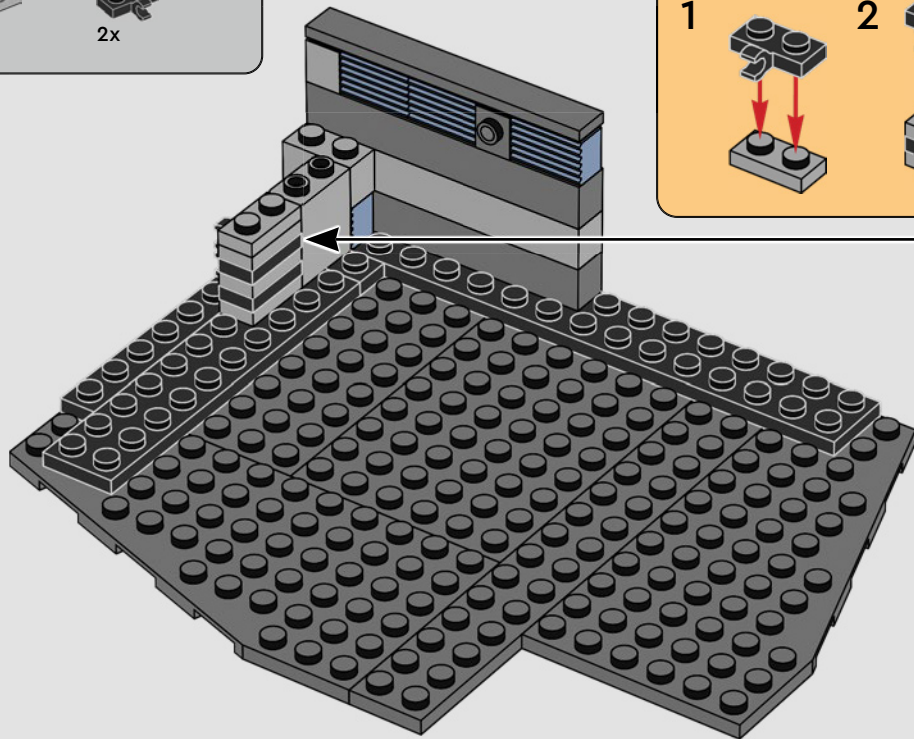

1

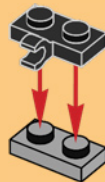

2

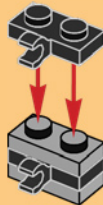

3

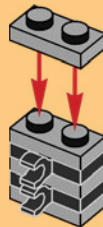



1x

15

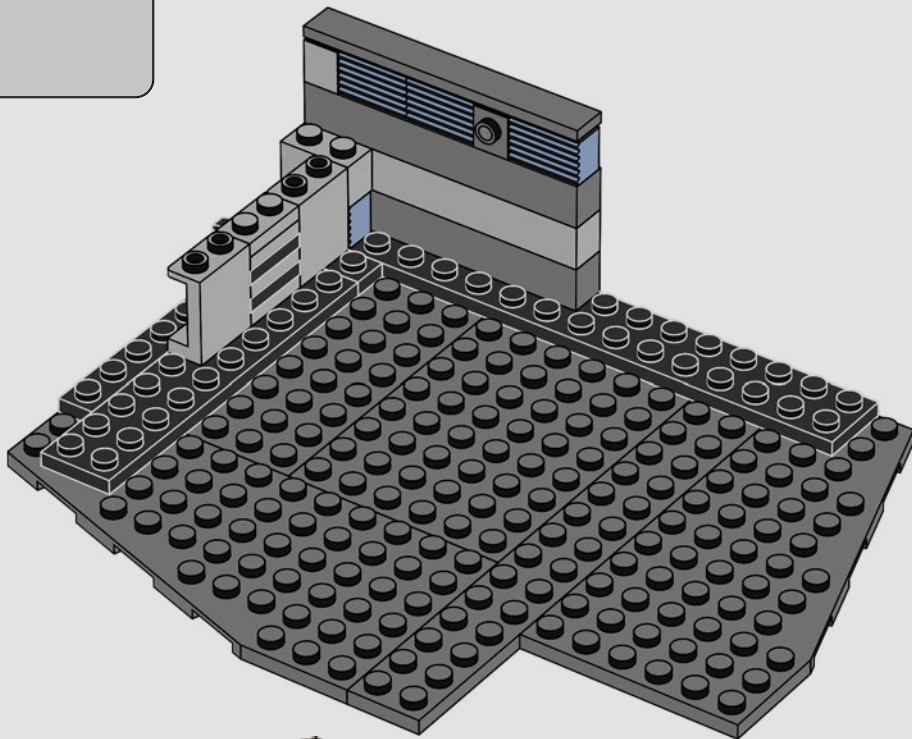

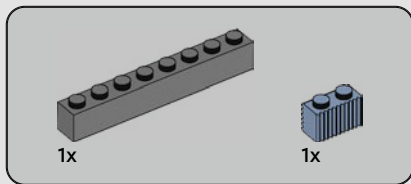

16

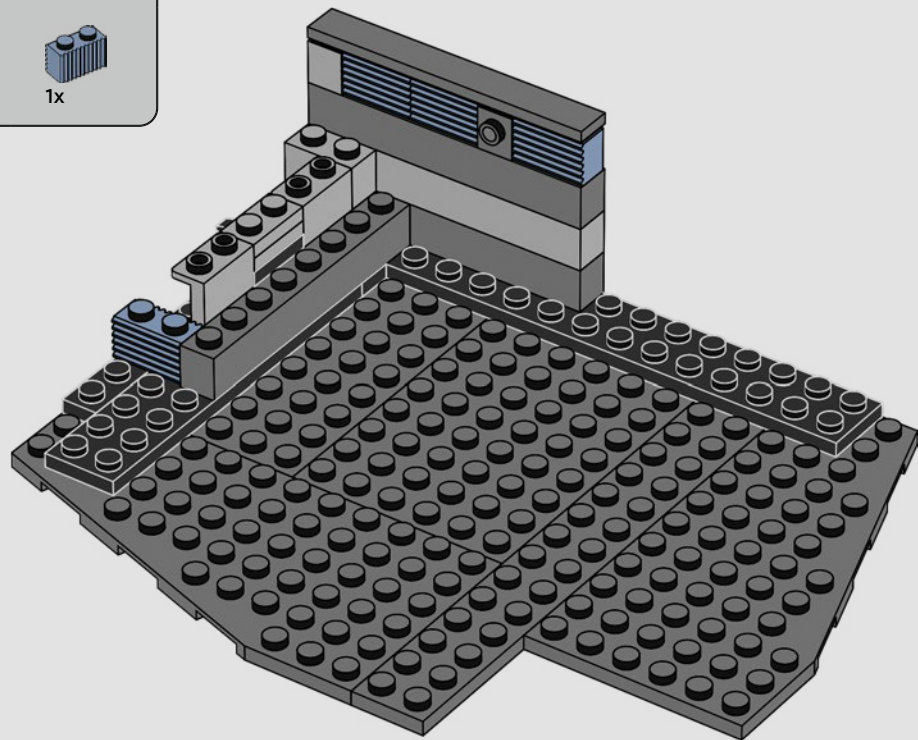

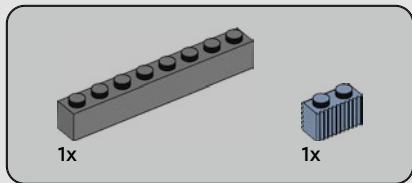

17

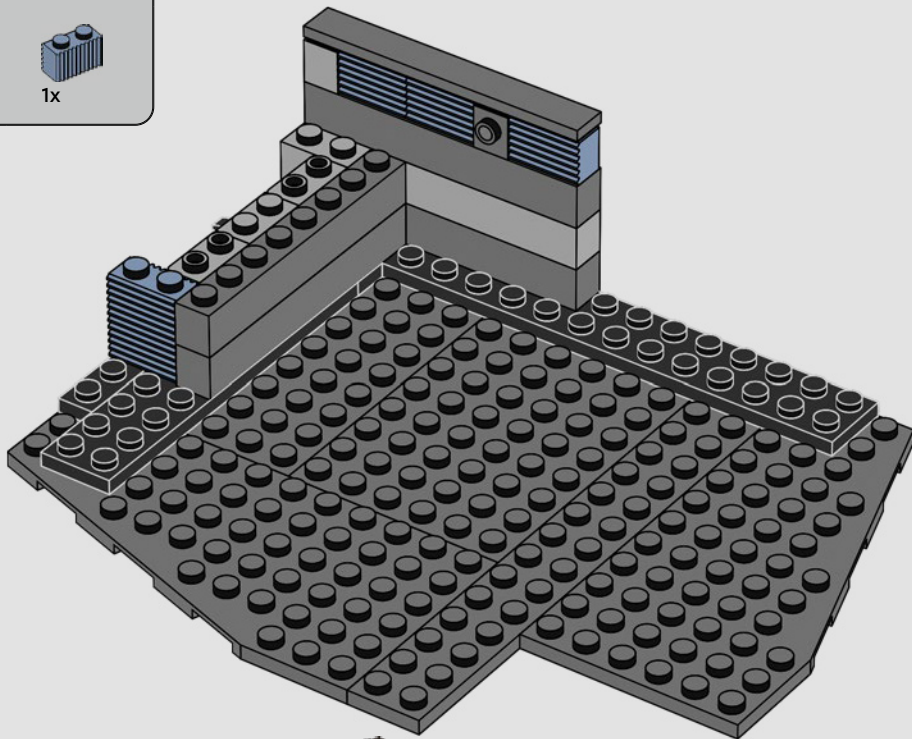

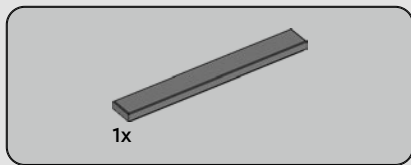

18

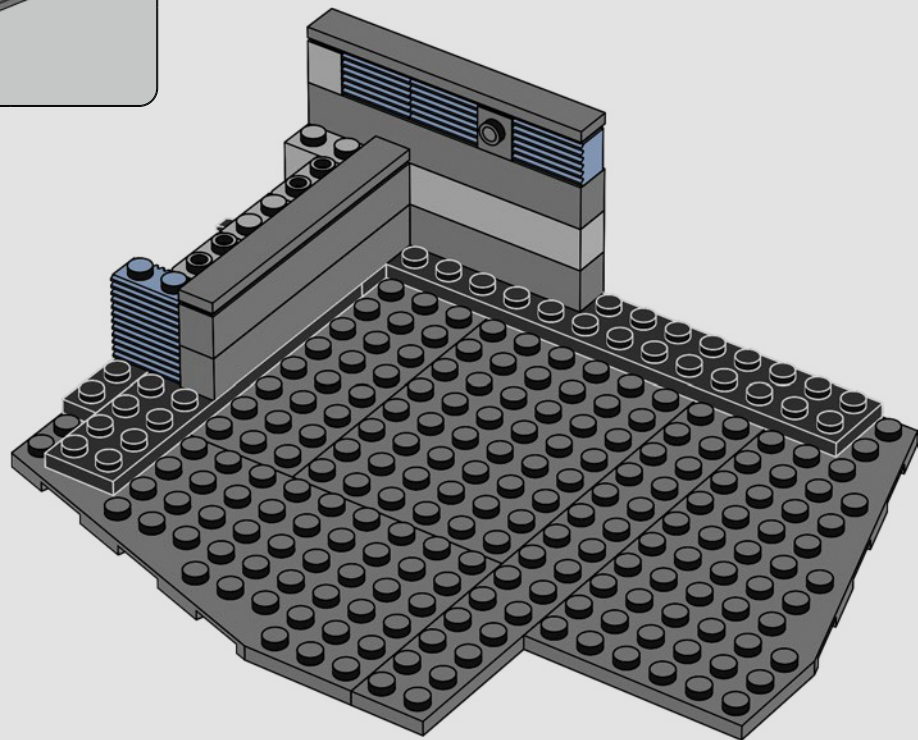



1x

19

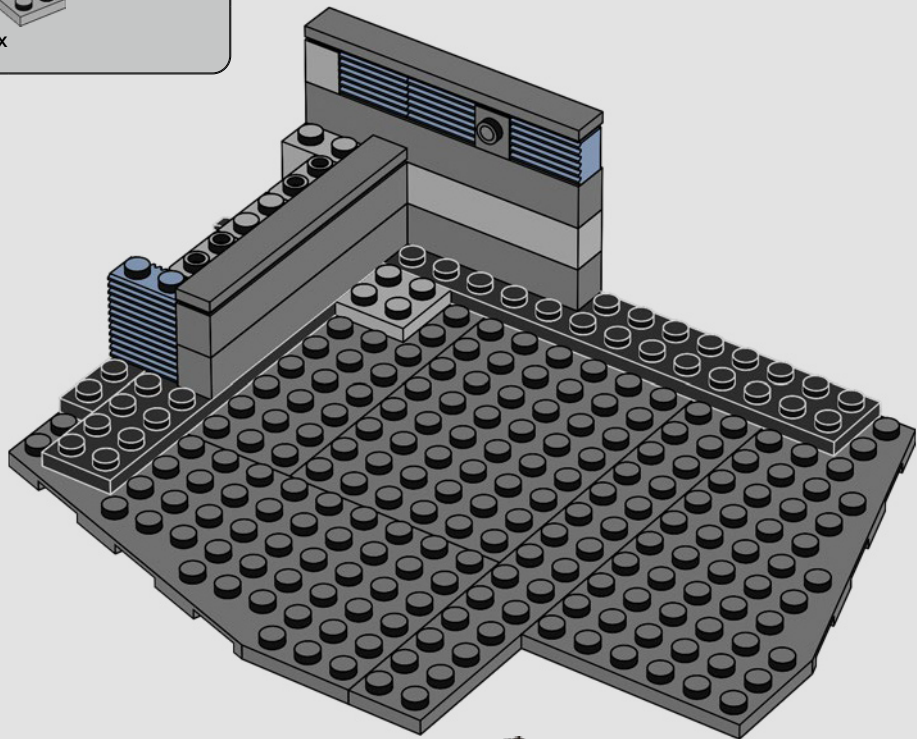







1x

21

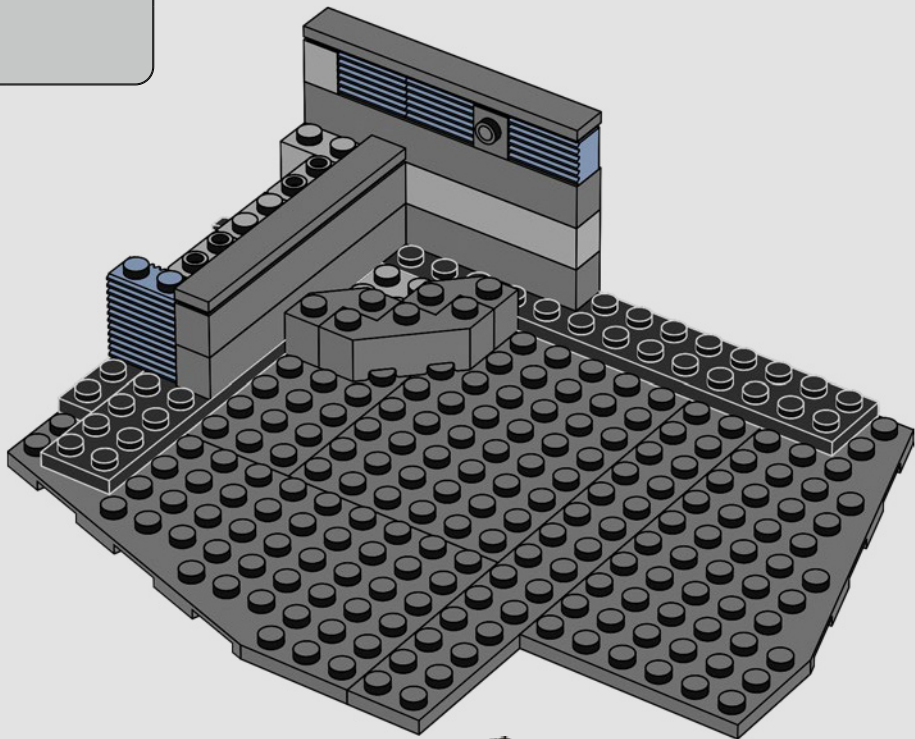

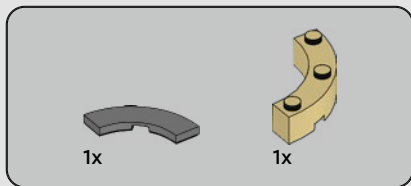

22

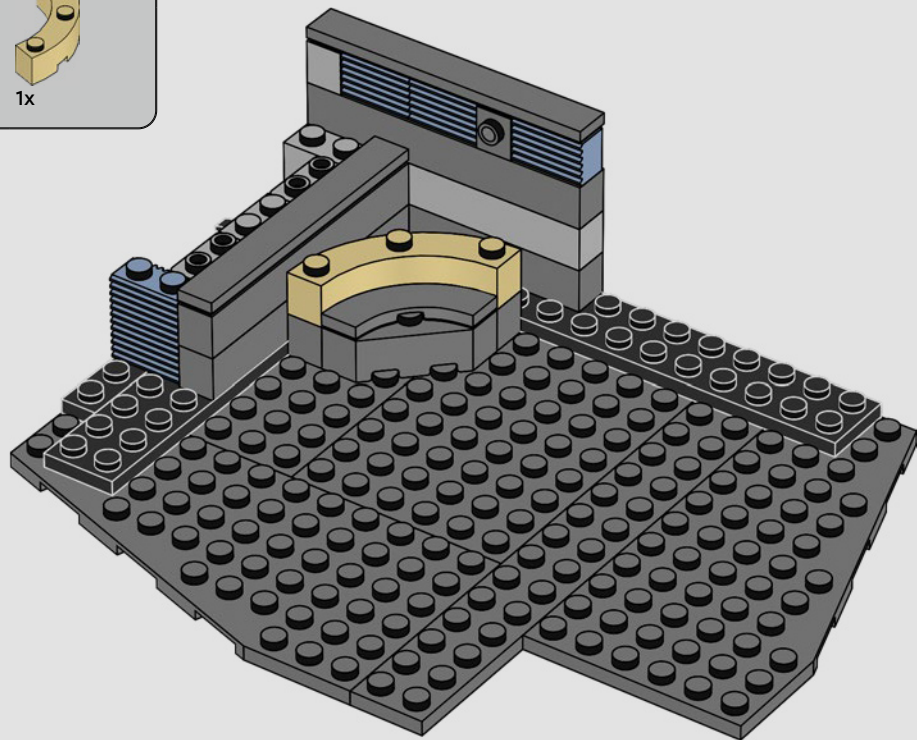



2x

23

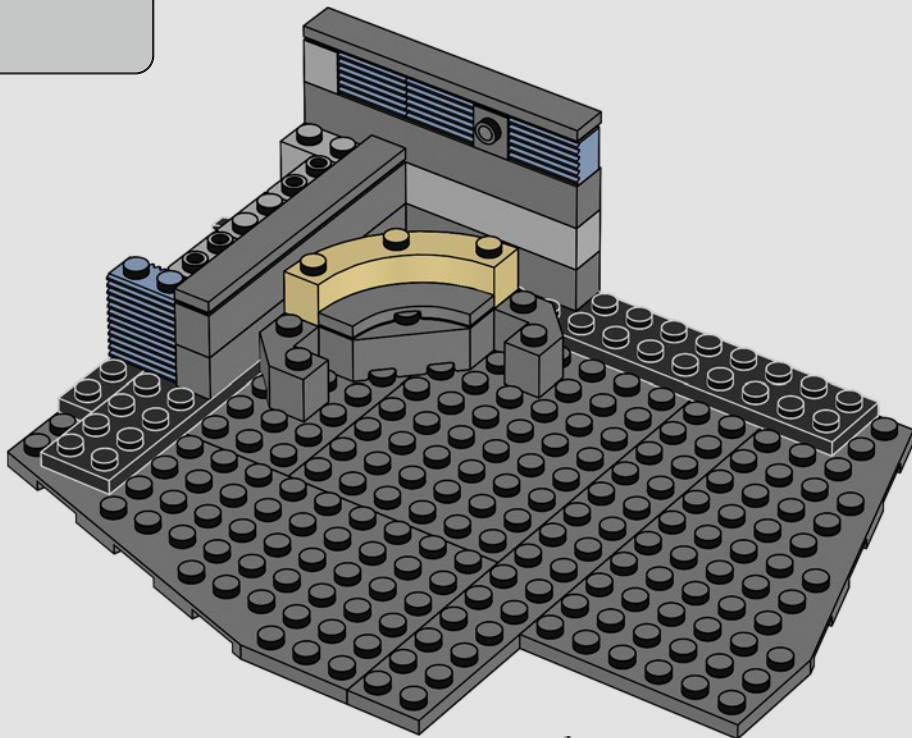



2x

24

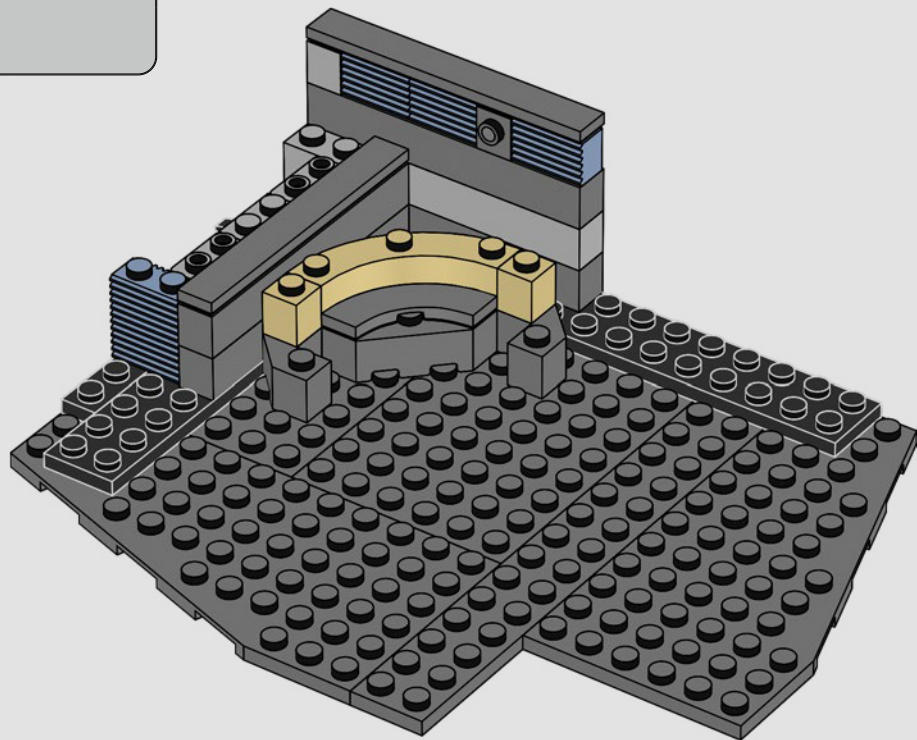

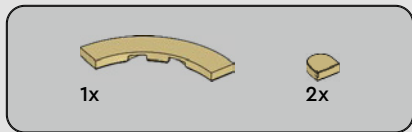

25

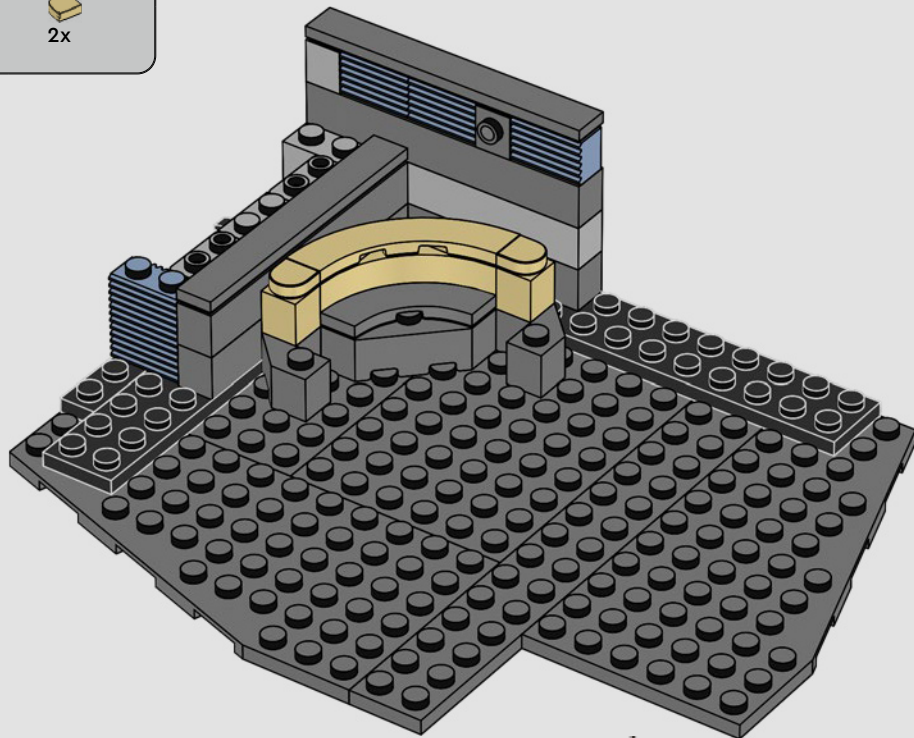



2x



2x

26

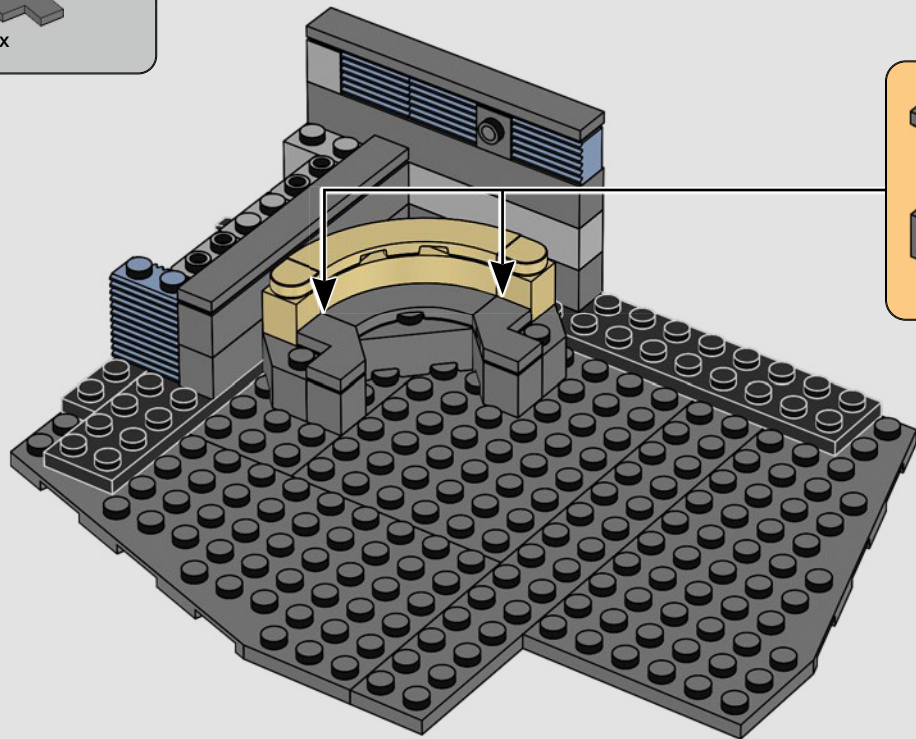

2x



2x

27



2x

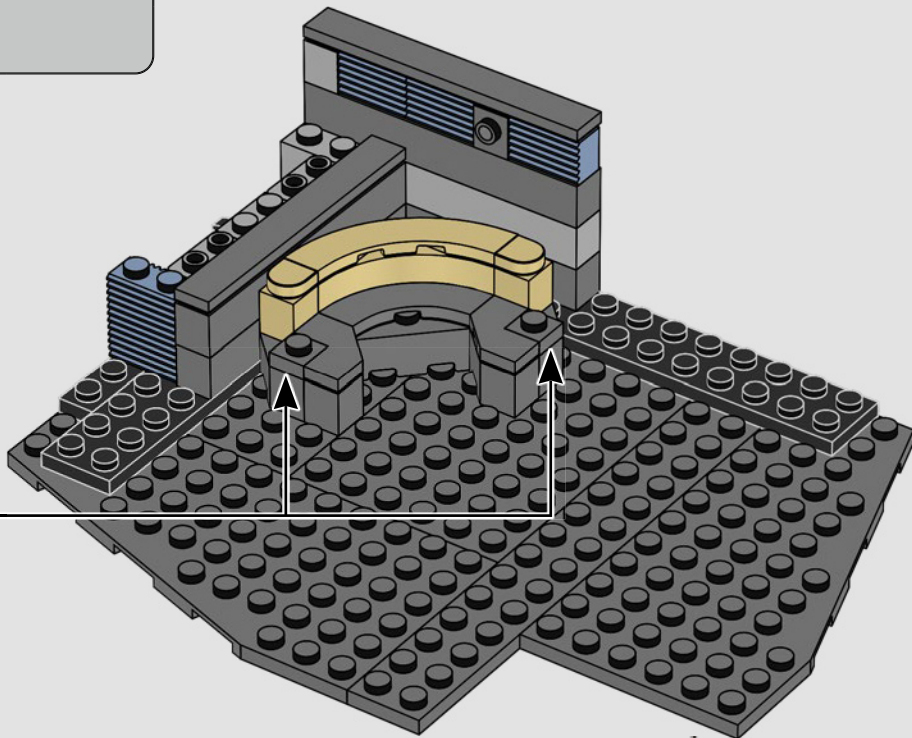





1x

28

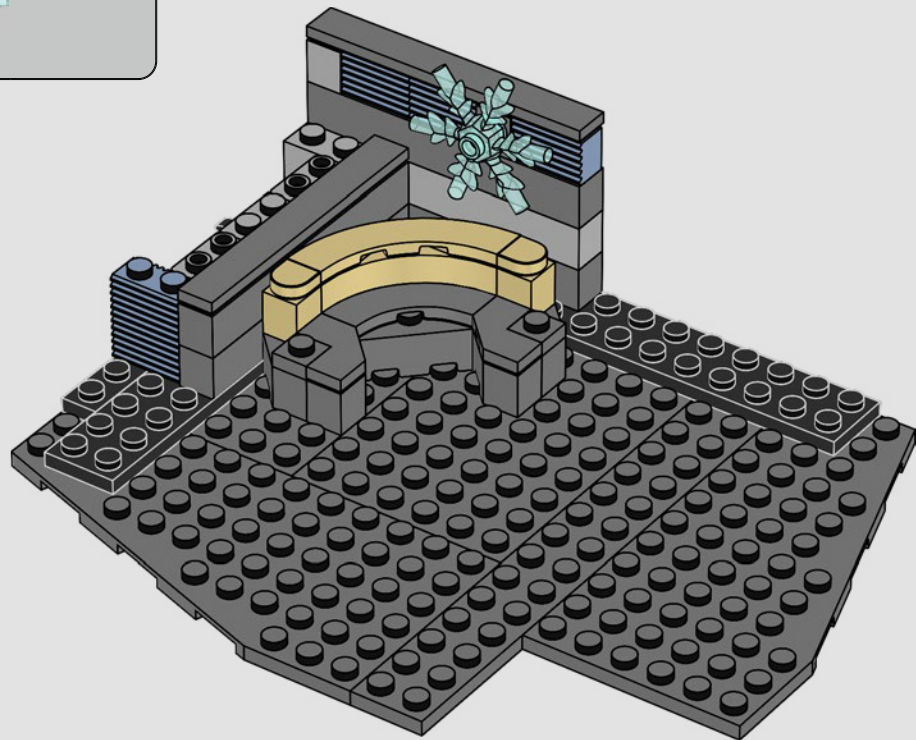

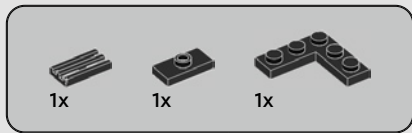

29

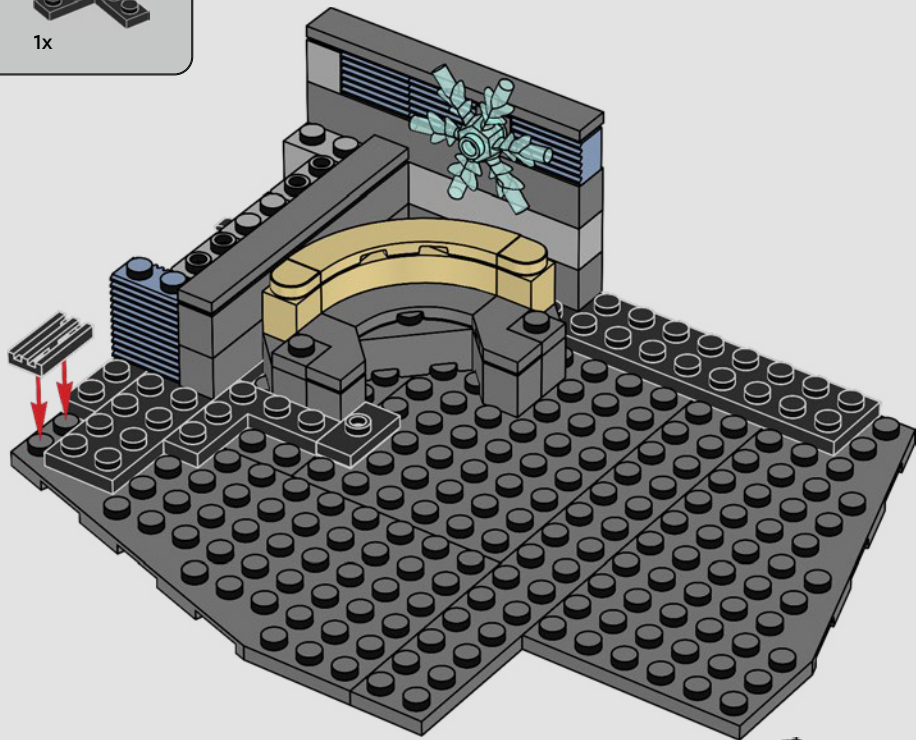



30

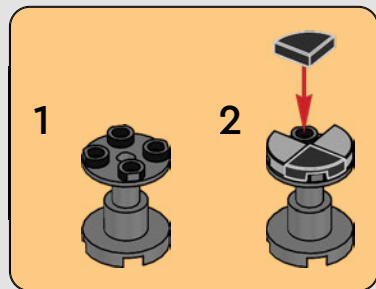
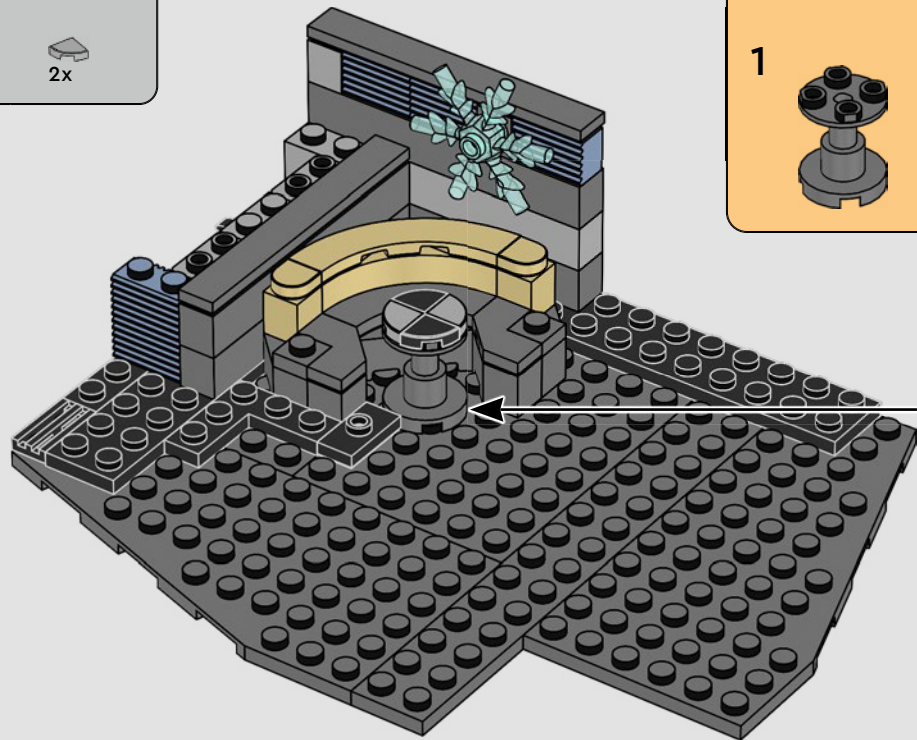

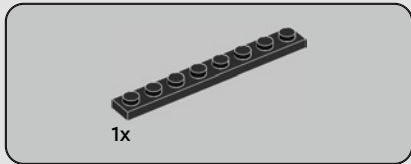

31

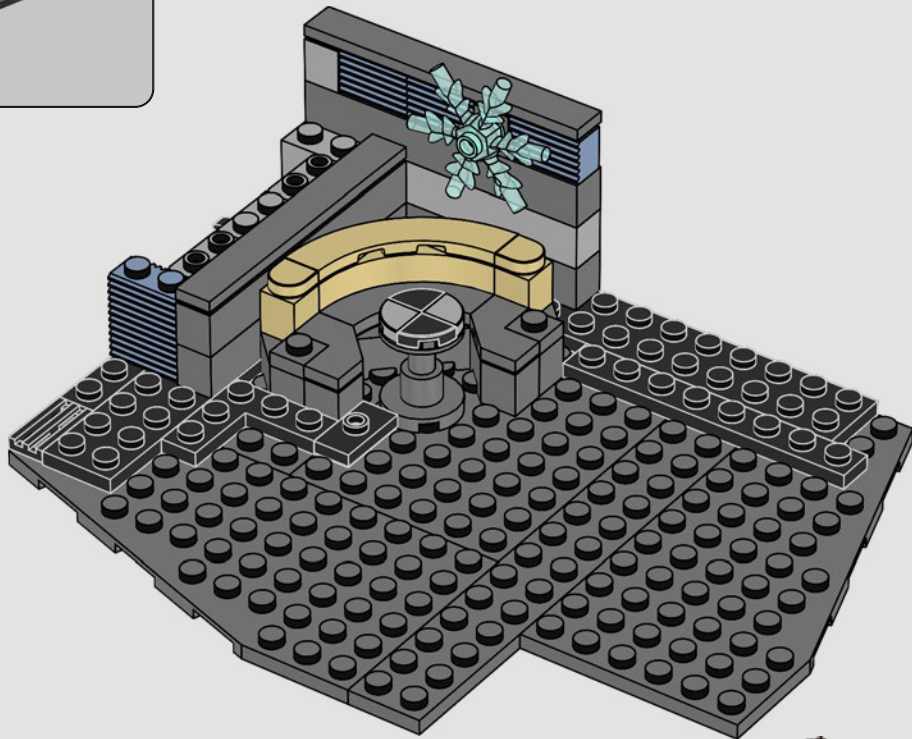



4x



2x

32

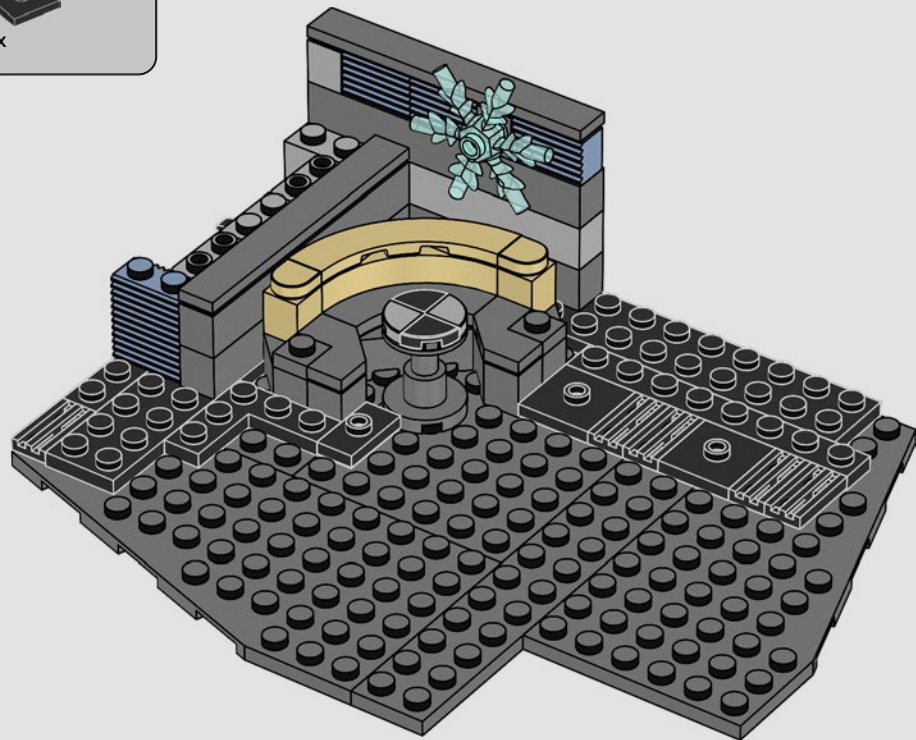

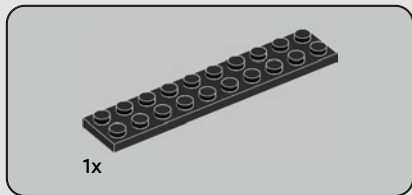

33

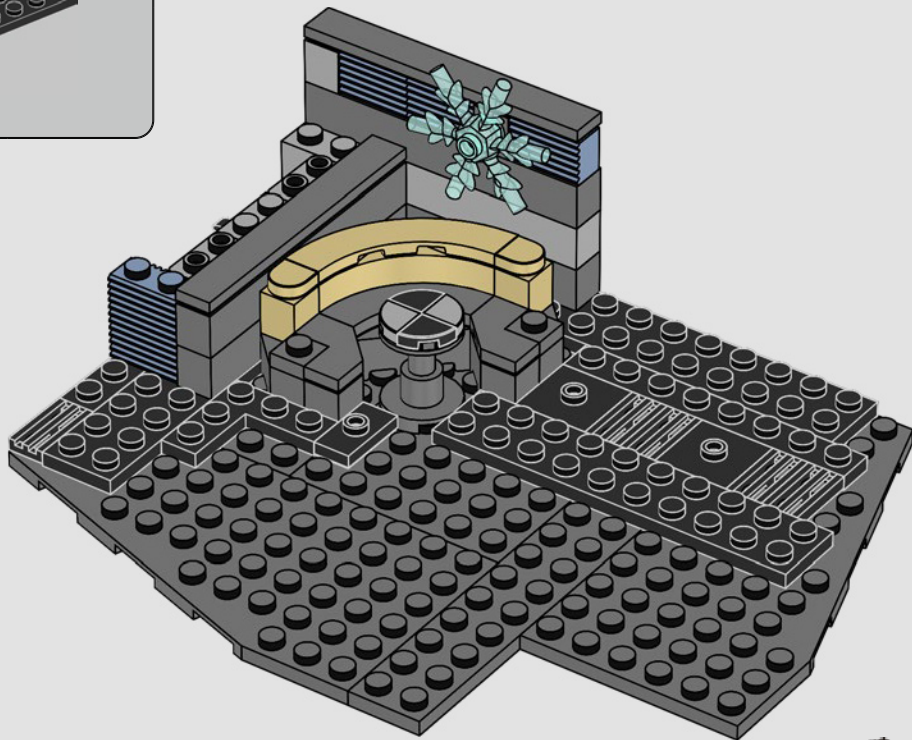



6x



3x

# 34

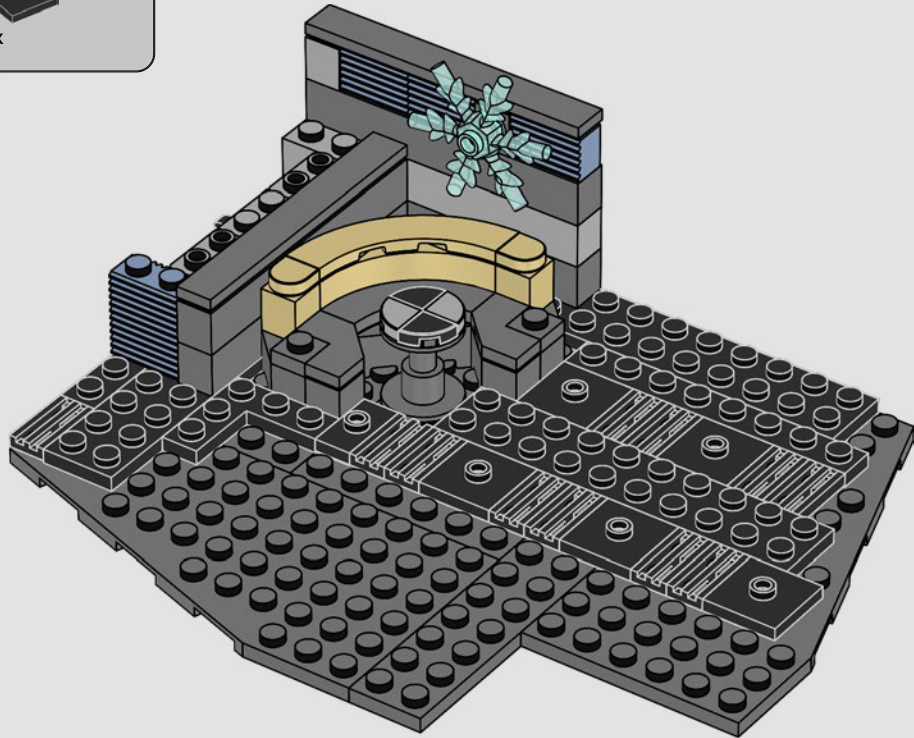

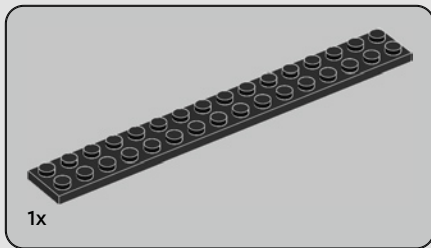

35

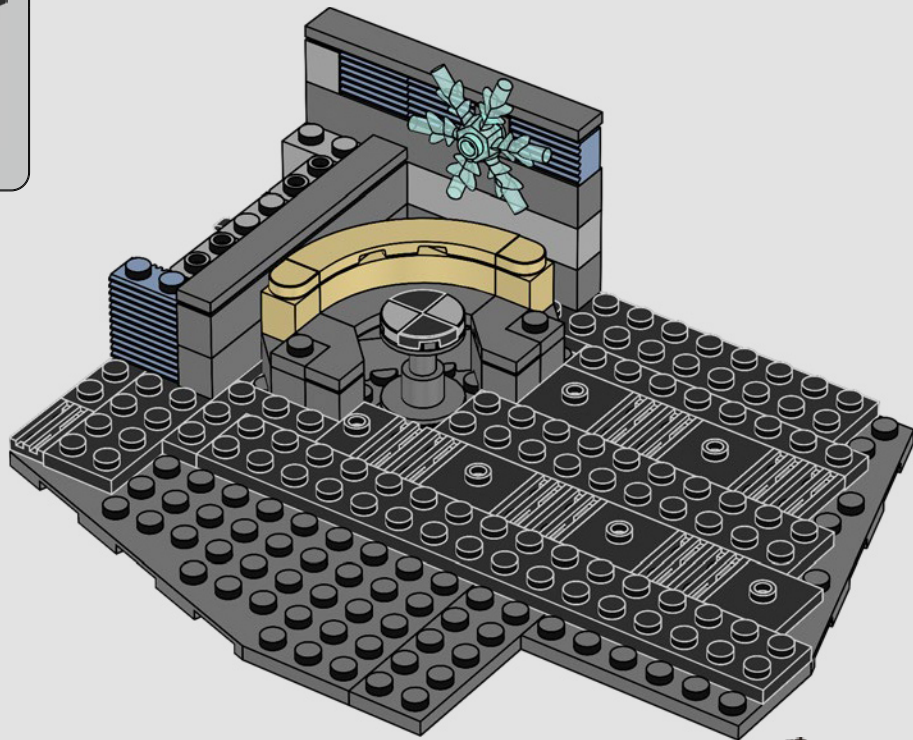





6x



3x

# 36

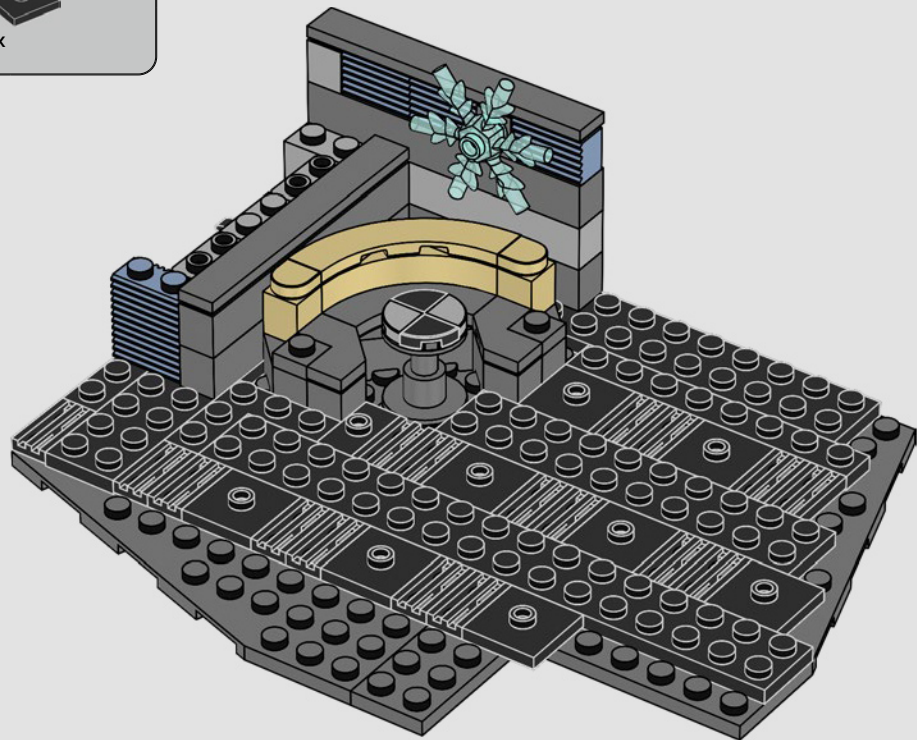

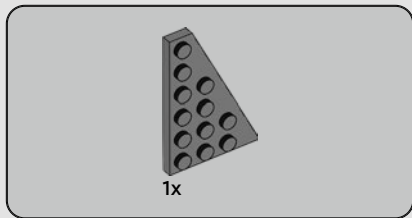

37

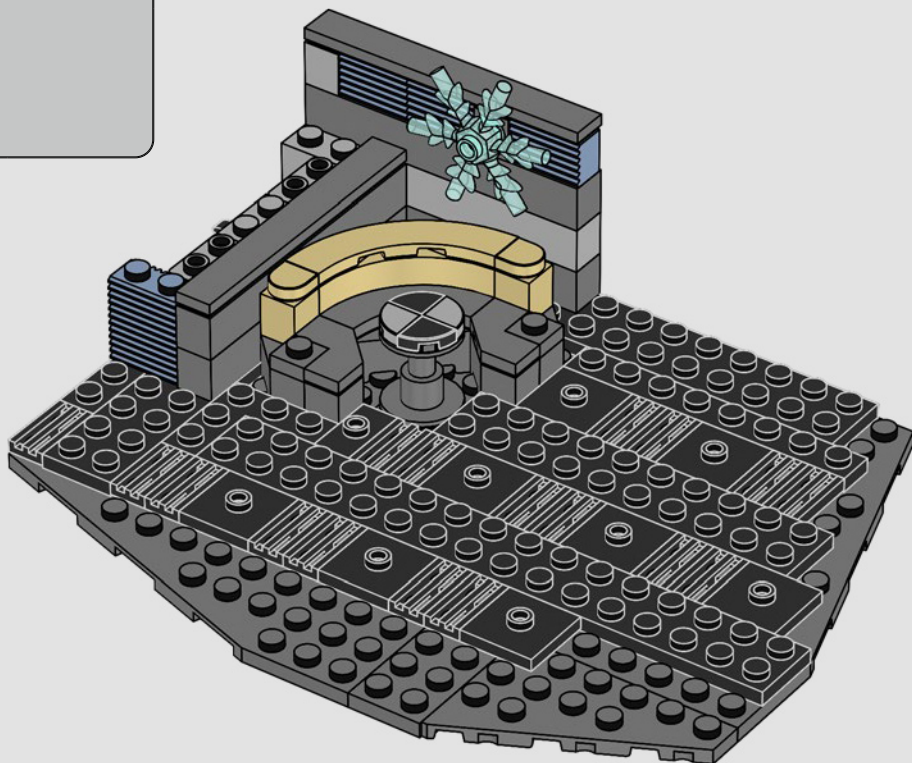

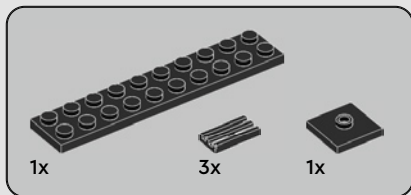

38

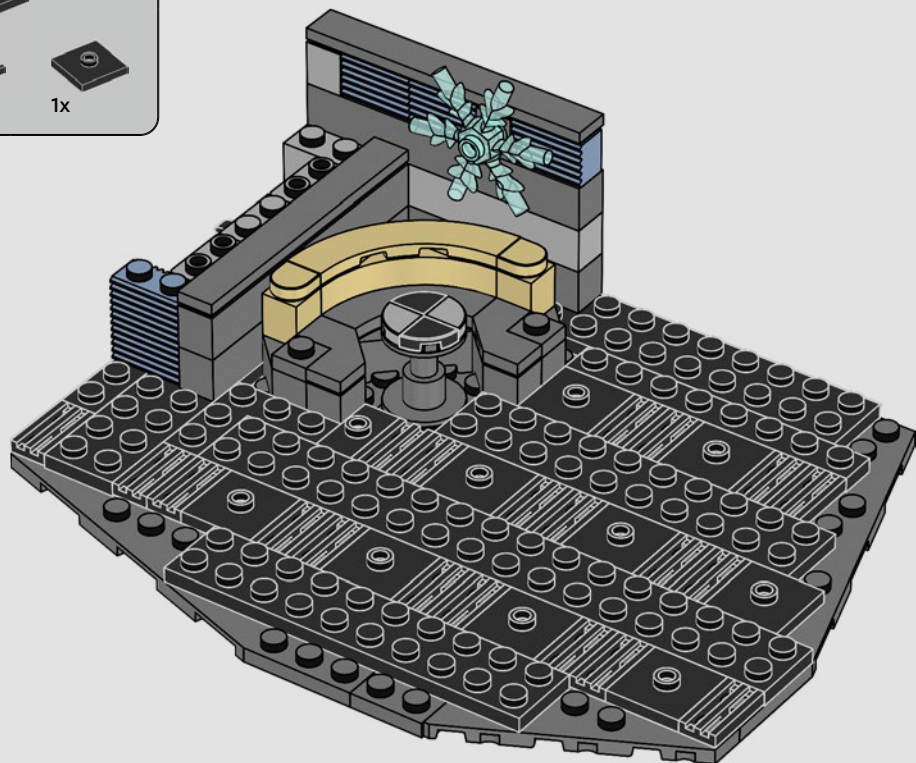

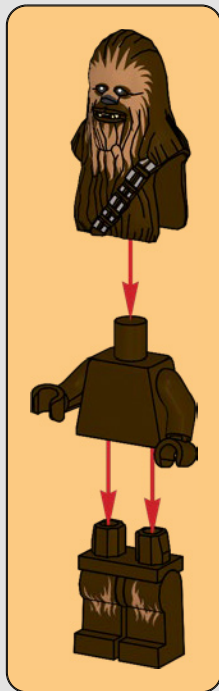

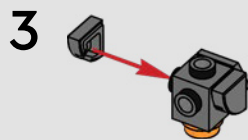
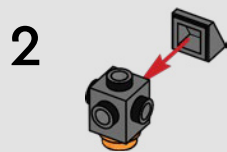
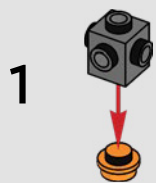
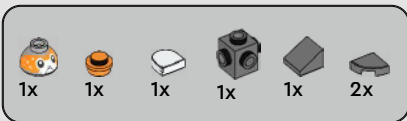

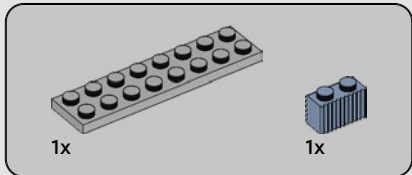
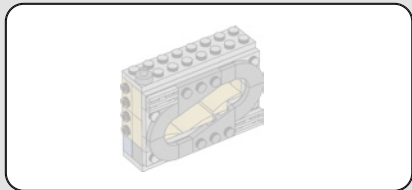

39

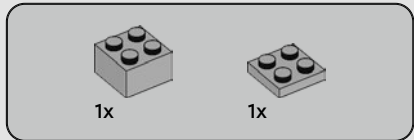
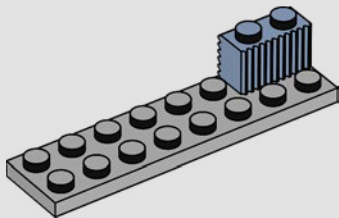

40

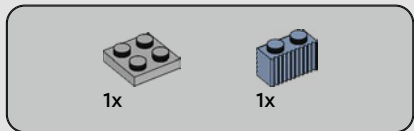
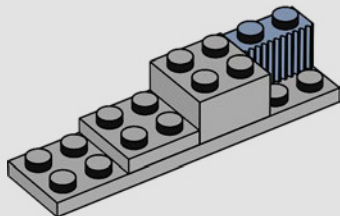

41

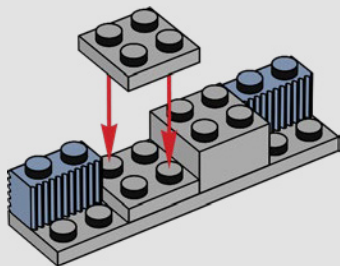



2x

42

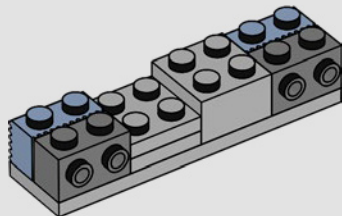

1x



1x

43

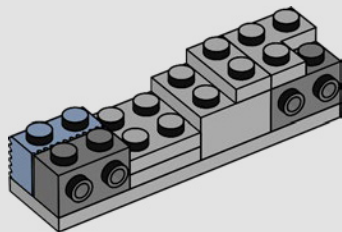

1x

44

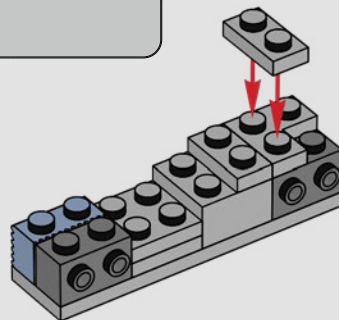

3x

45

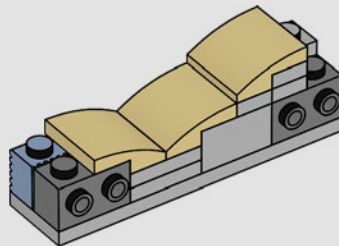



1x



1x

46

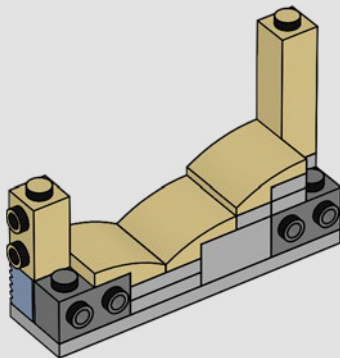

48



2x

47

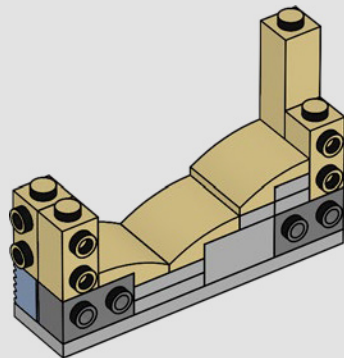





1x



2x

# 48

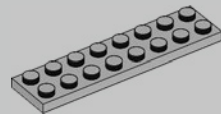
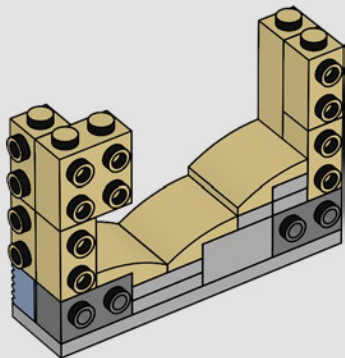

1x

# 49

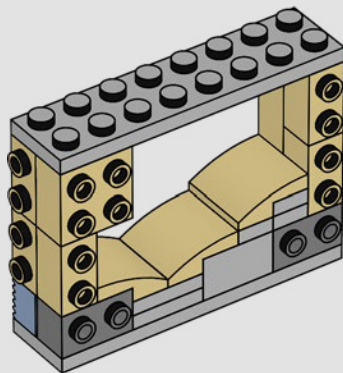



1x

50

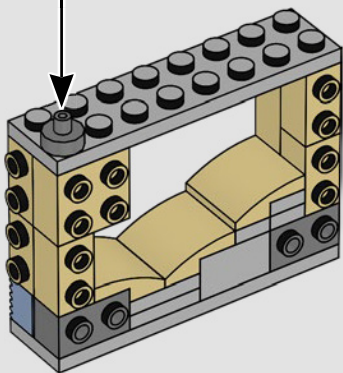

50

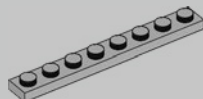

2x

51

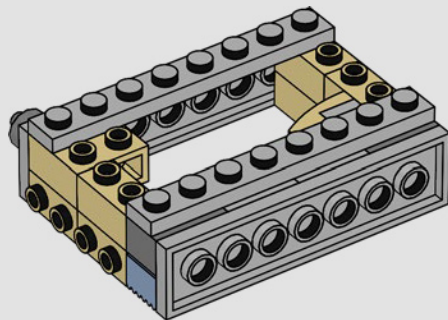
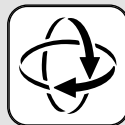



2x



2x

# 52

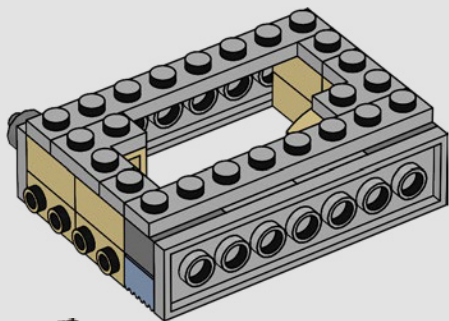

1x



2x

# 53

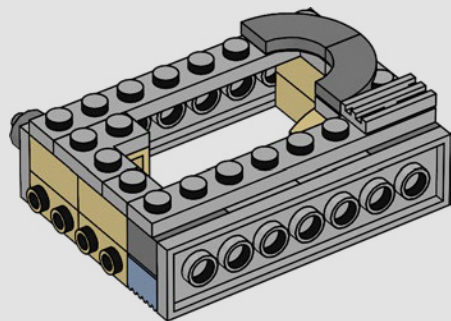

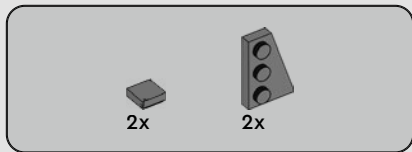

54

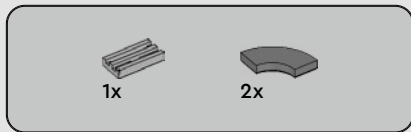
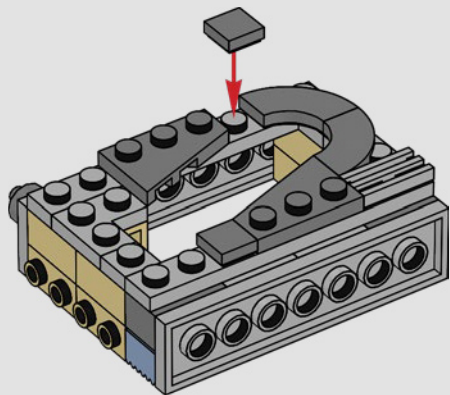

55

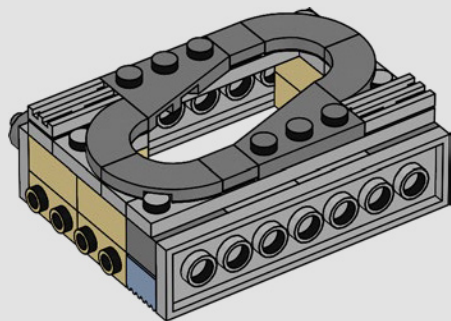

56

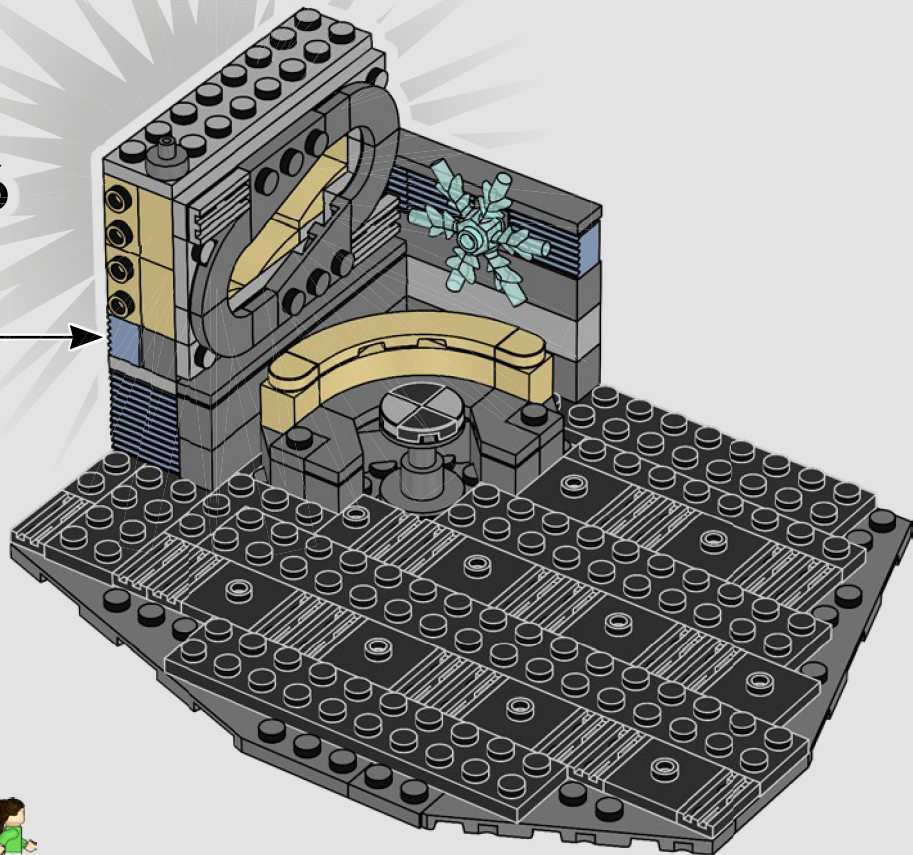

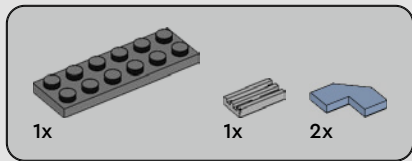

57

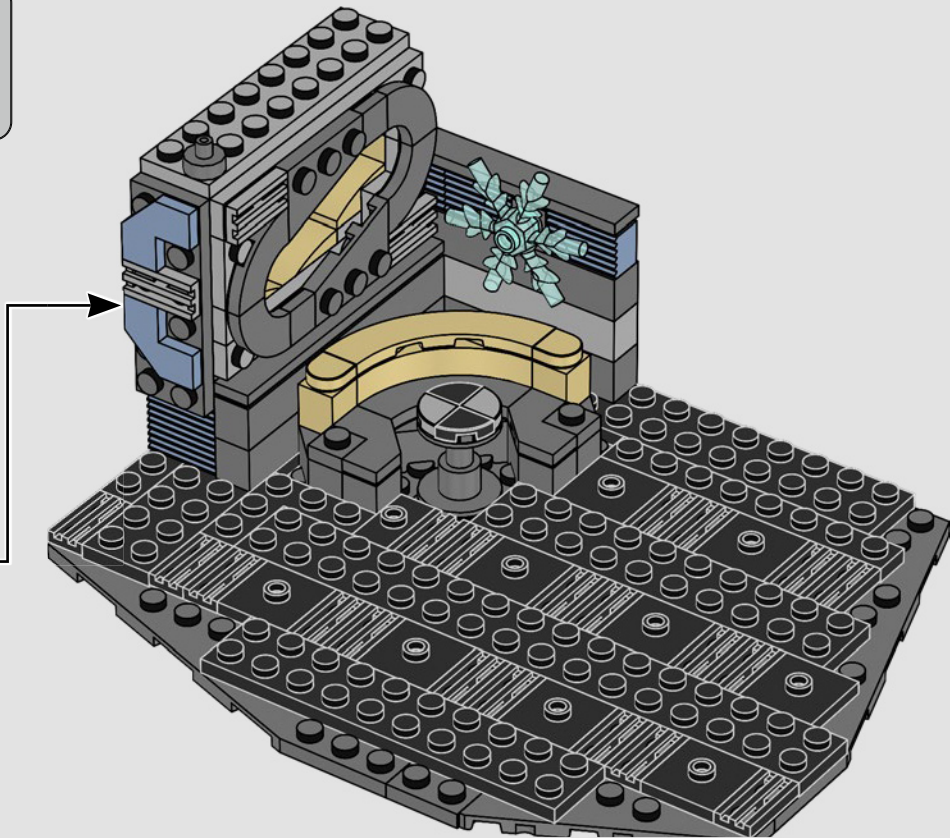
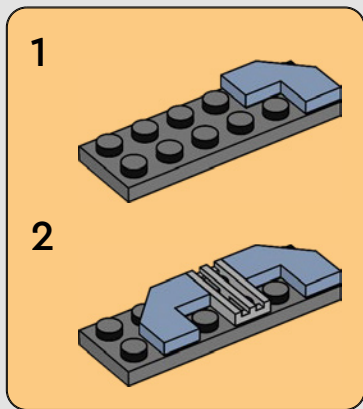



1x

58

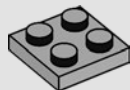

1x



1x

59

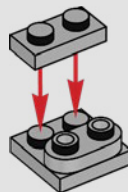

2x

60

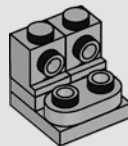

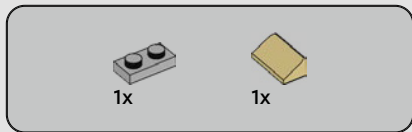

61

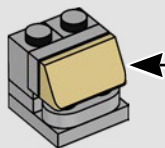
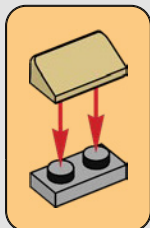

62

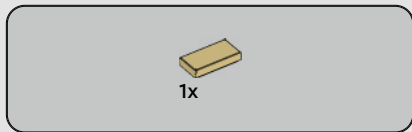
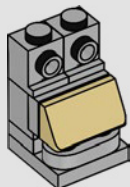

63

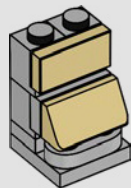

64

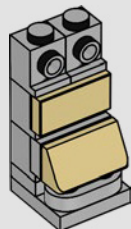





1x

65

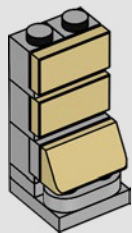

2x

66

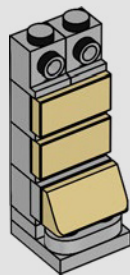



1x



1x

67

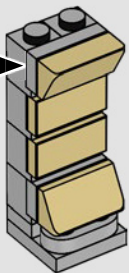
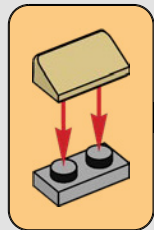

1x

68

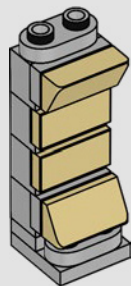

69

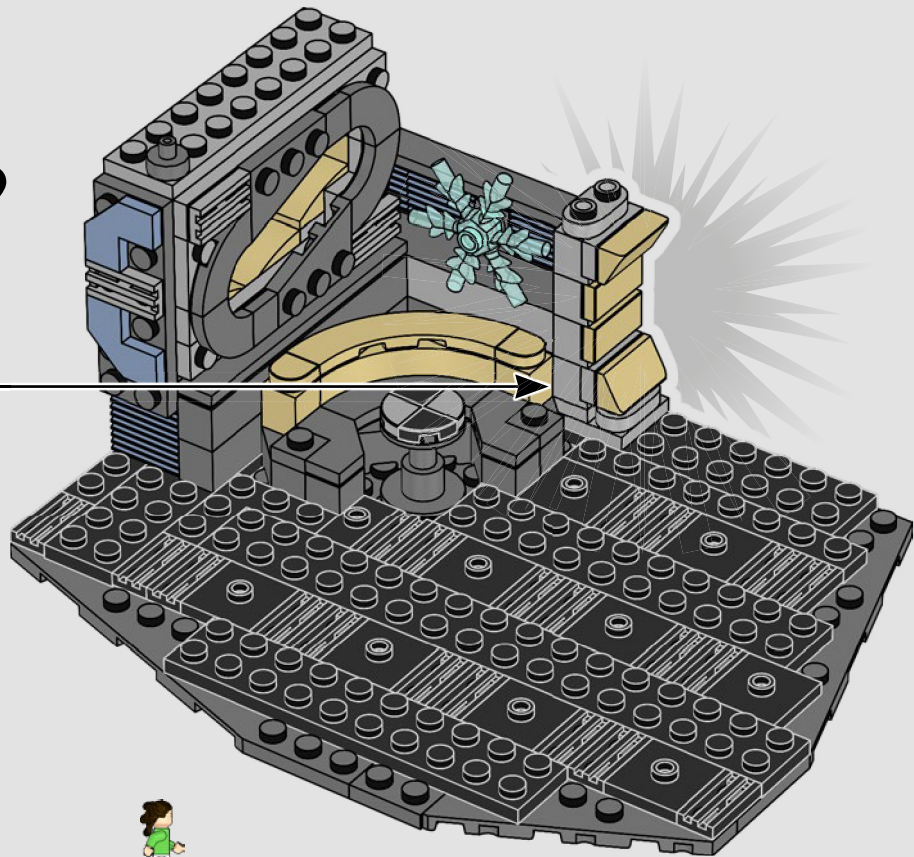



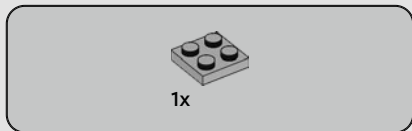

71

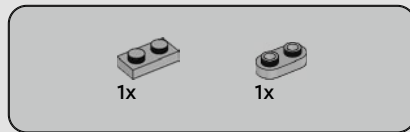
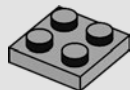

72

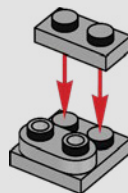

73

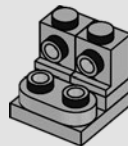

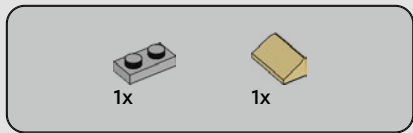

74

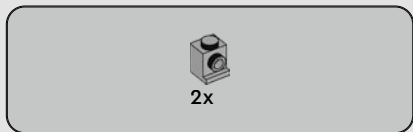
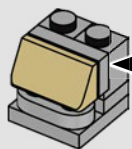
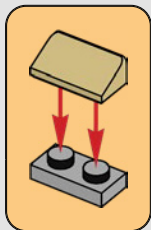

75

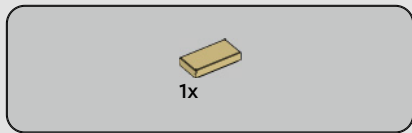
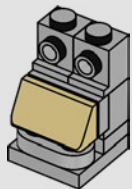

76

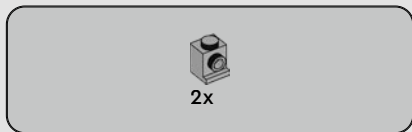
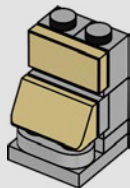

77

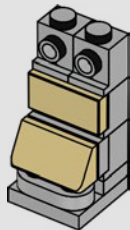



1x

78

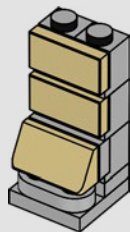

2x

79

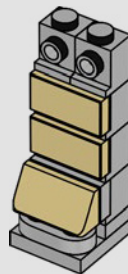



1x



1x

# 80

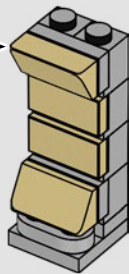
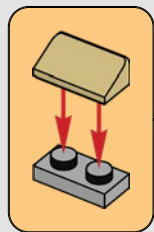

1x

# 81

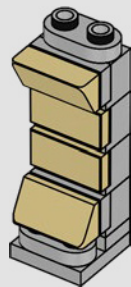



82

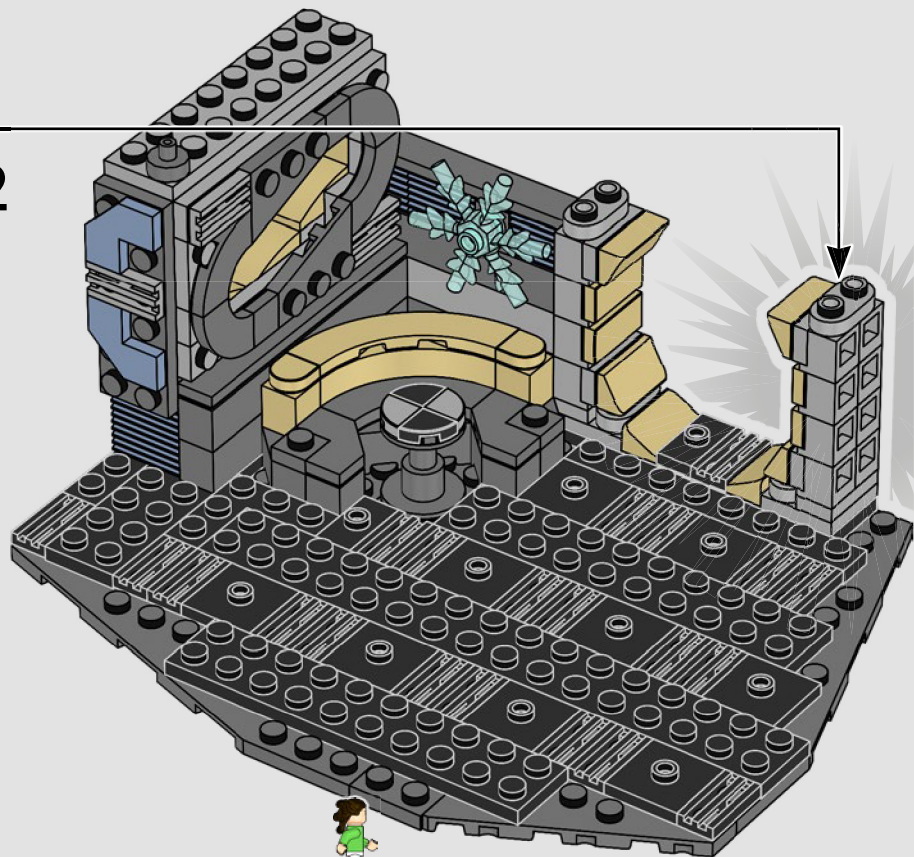

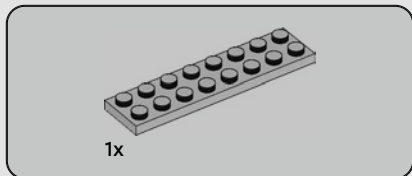

83

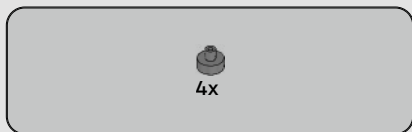
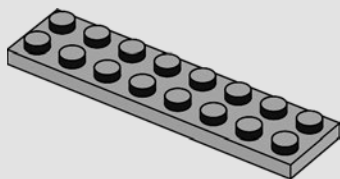

84

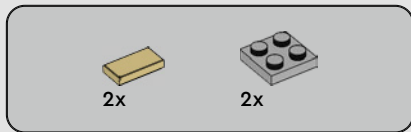
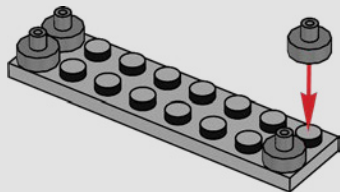

85

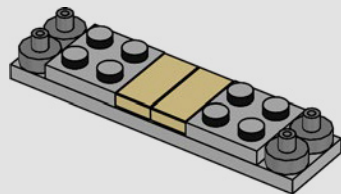

86

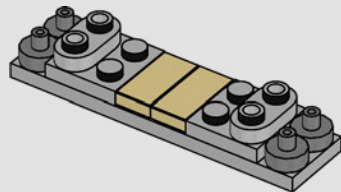



2x

87

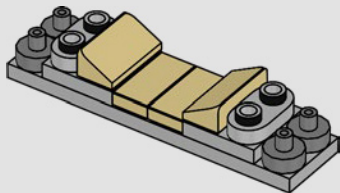

88

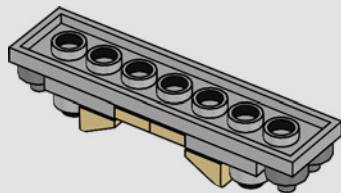

89

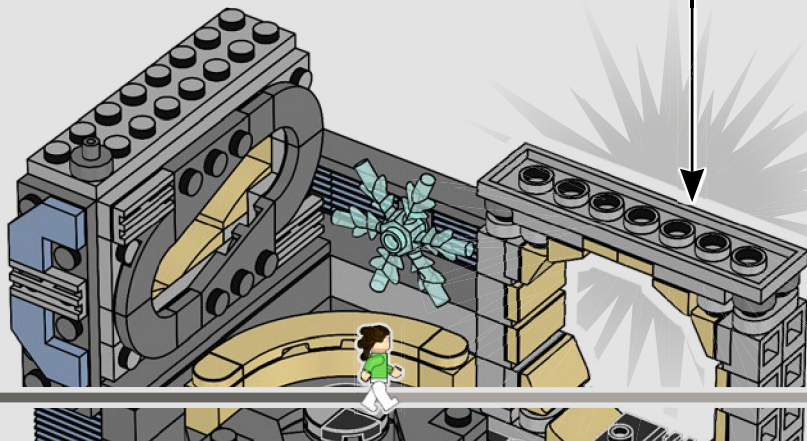



1x



2x

# 90

1



2



3

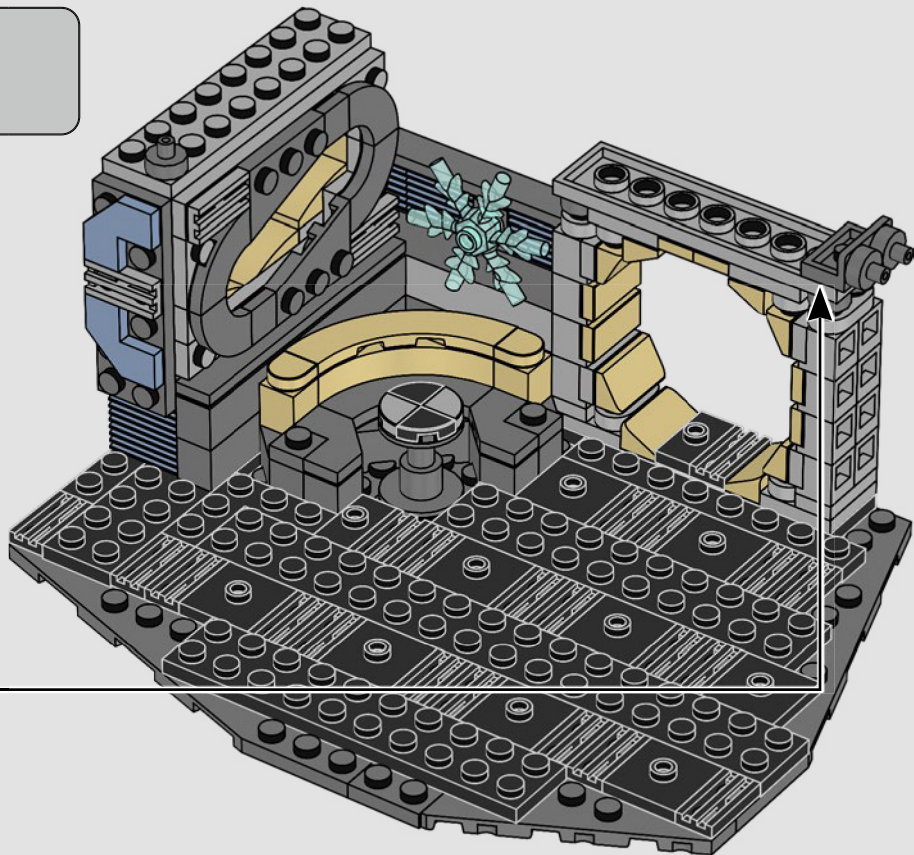
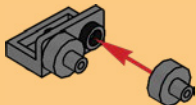



2x

91

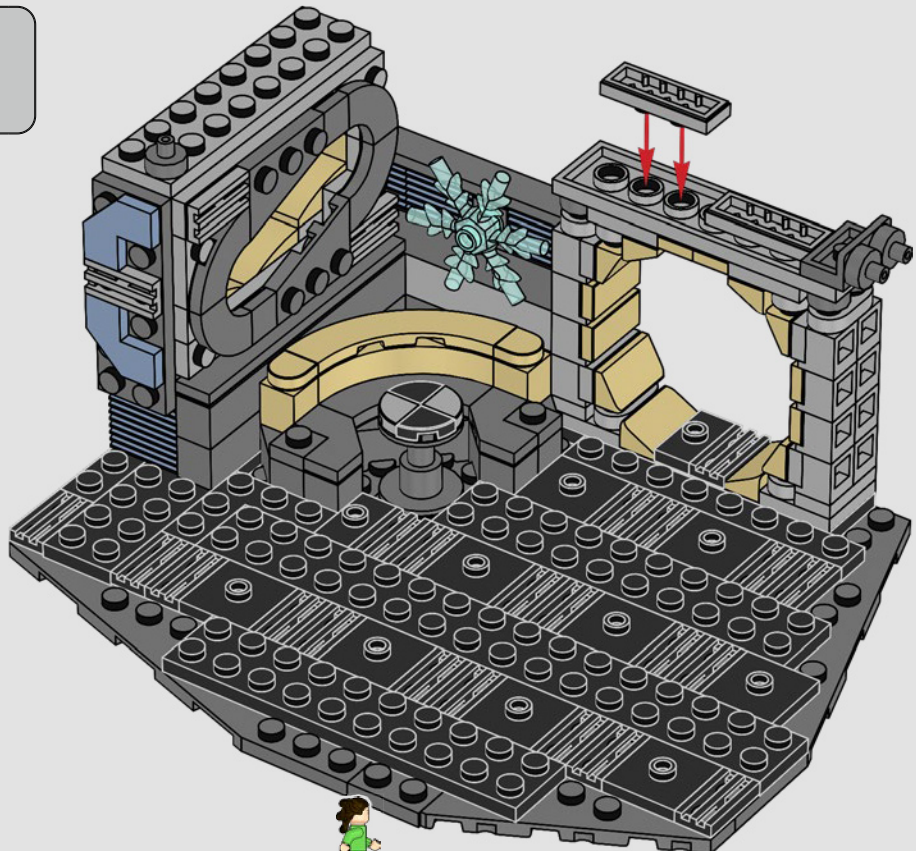

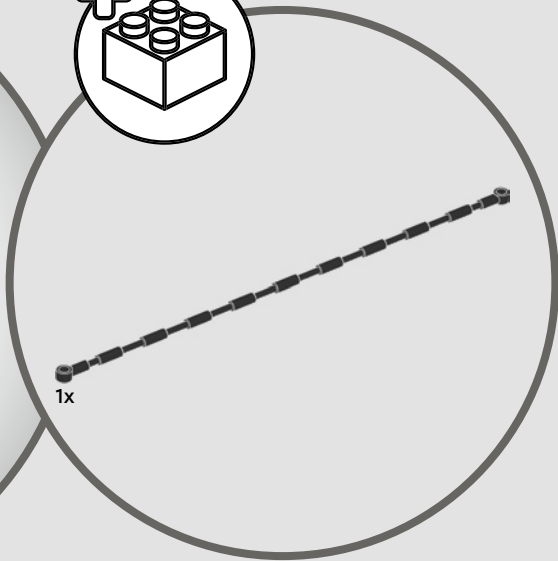
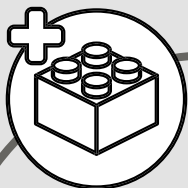

1x  2x 

92

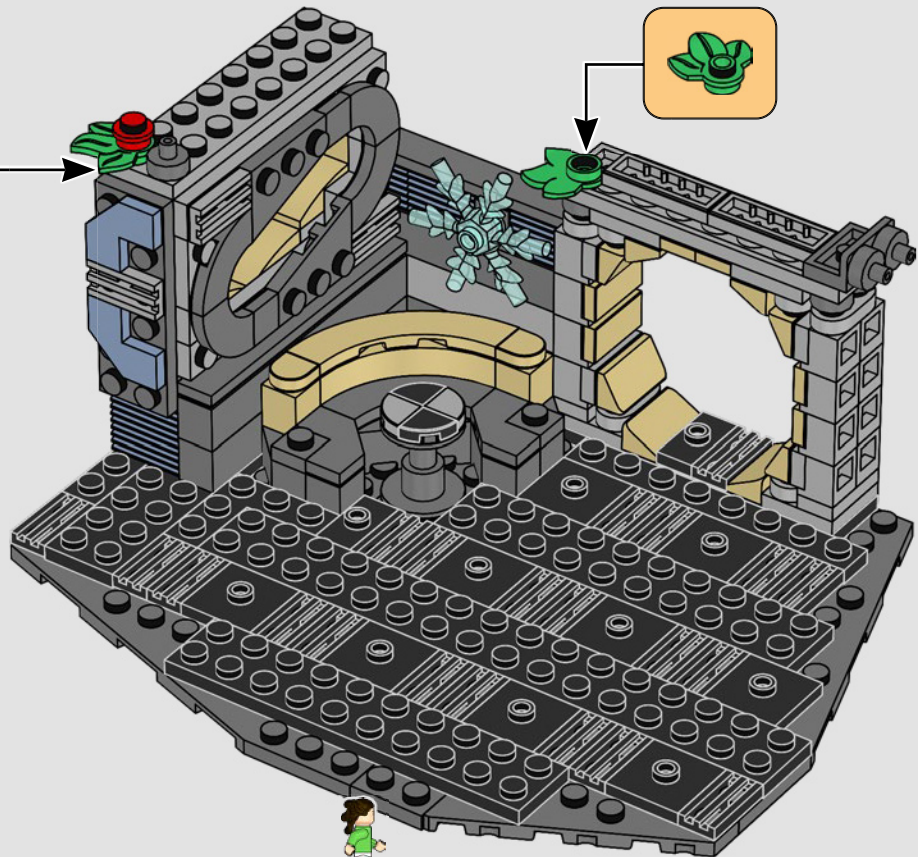
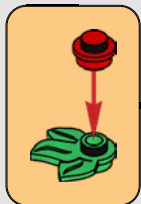



2x



2x

93

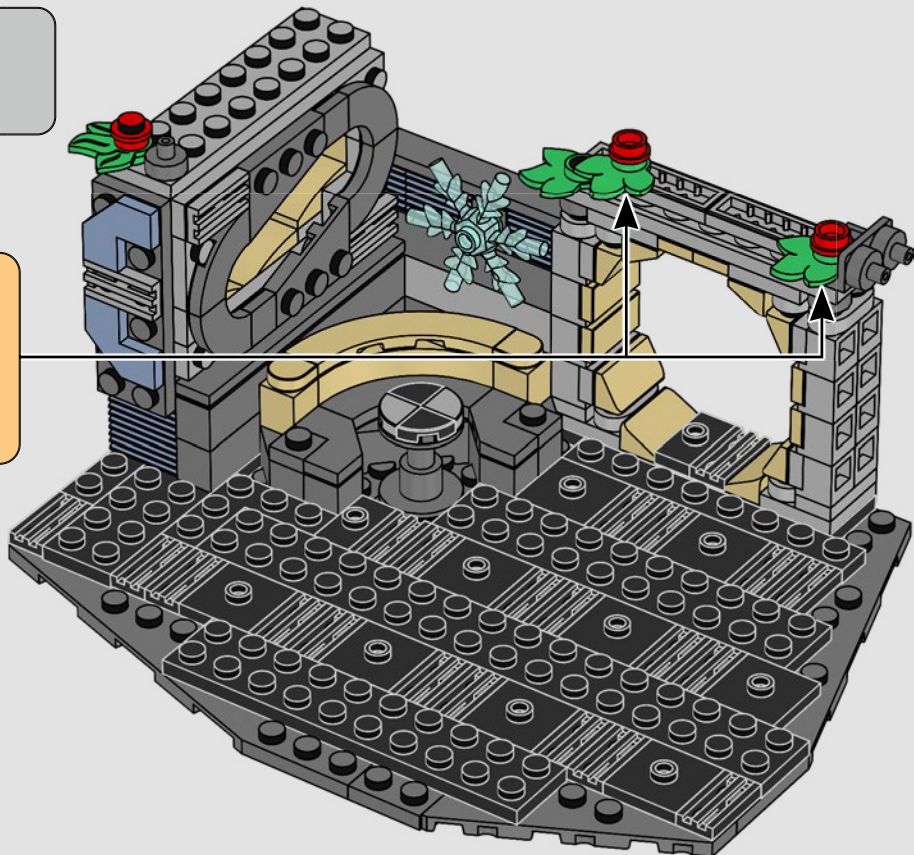
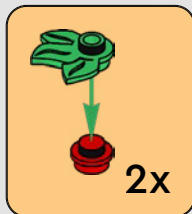



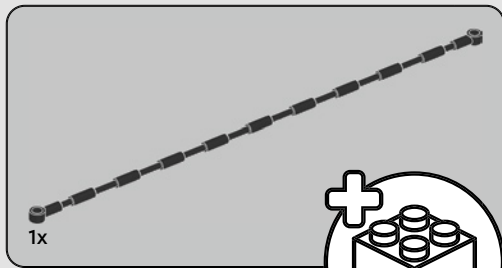

94

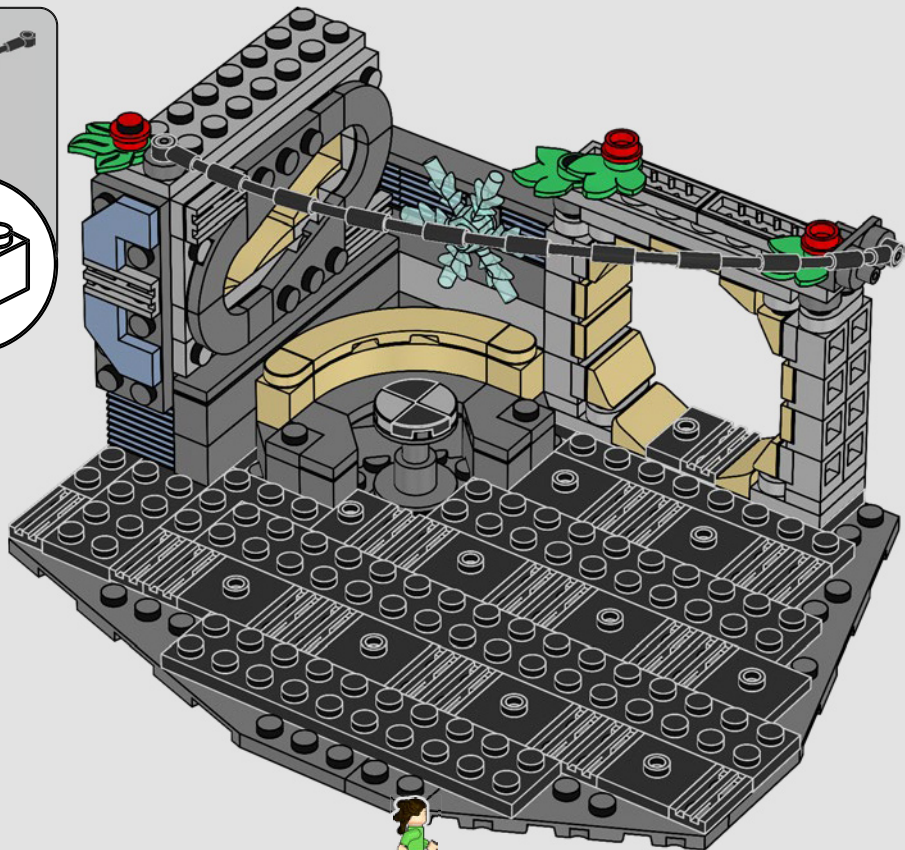
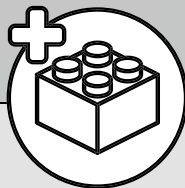

2x 3x 5x

95

3x

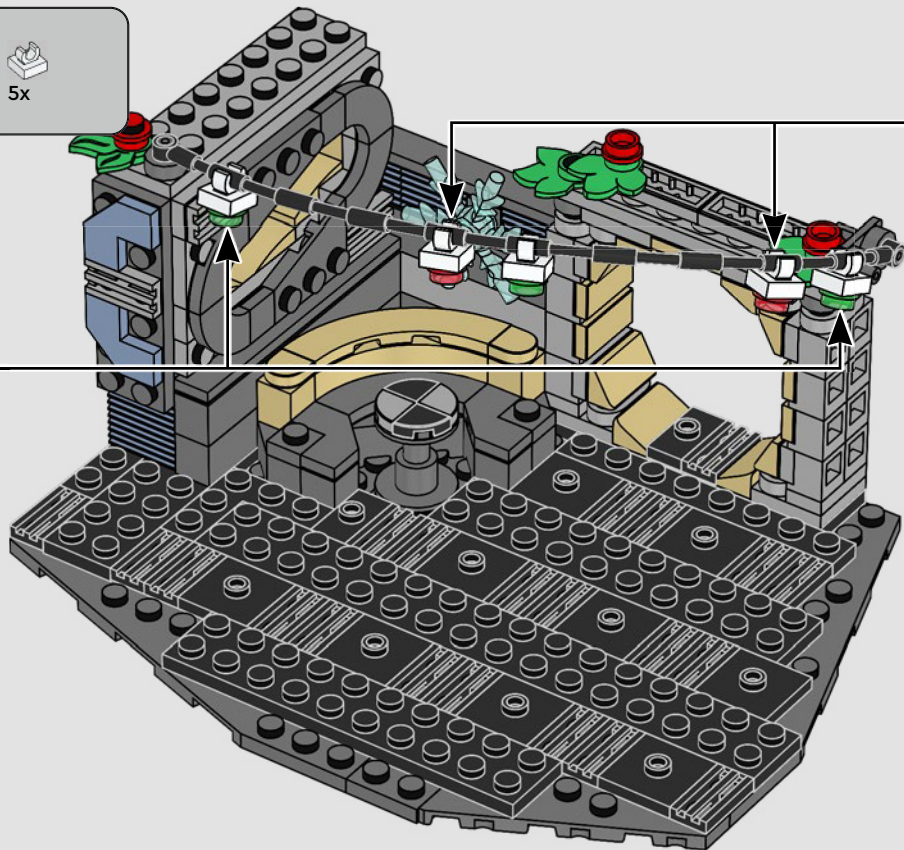

2x

2x      2x      4x

96

2x

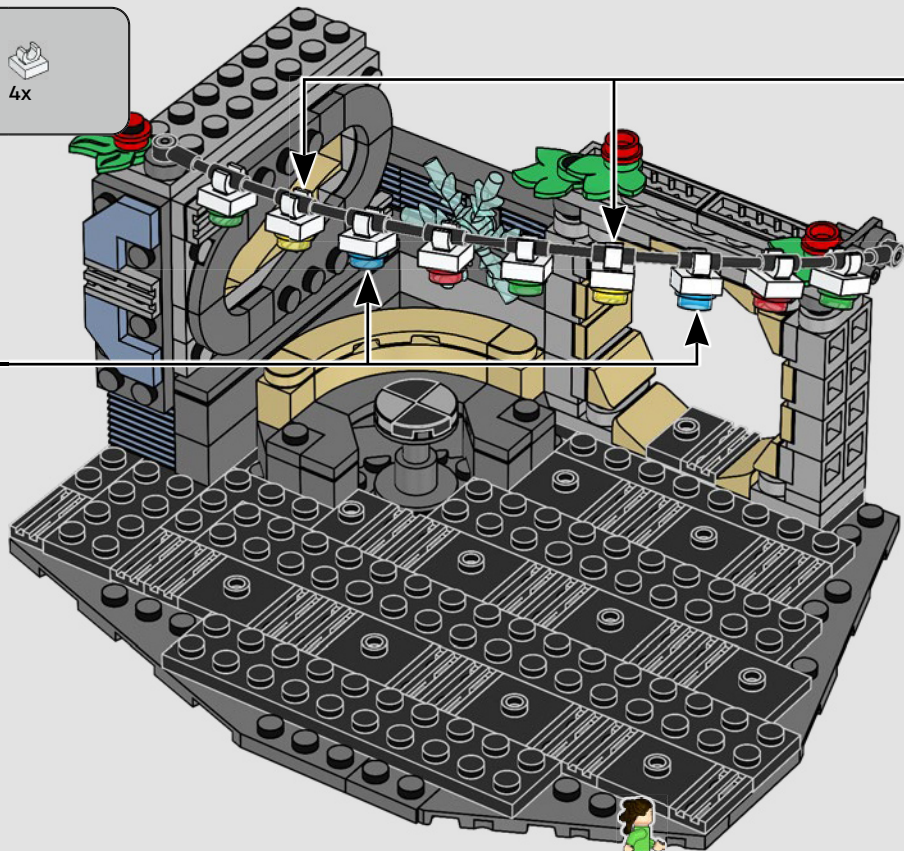

2x



1x

97

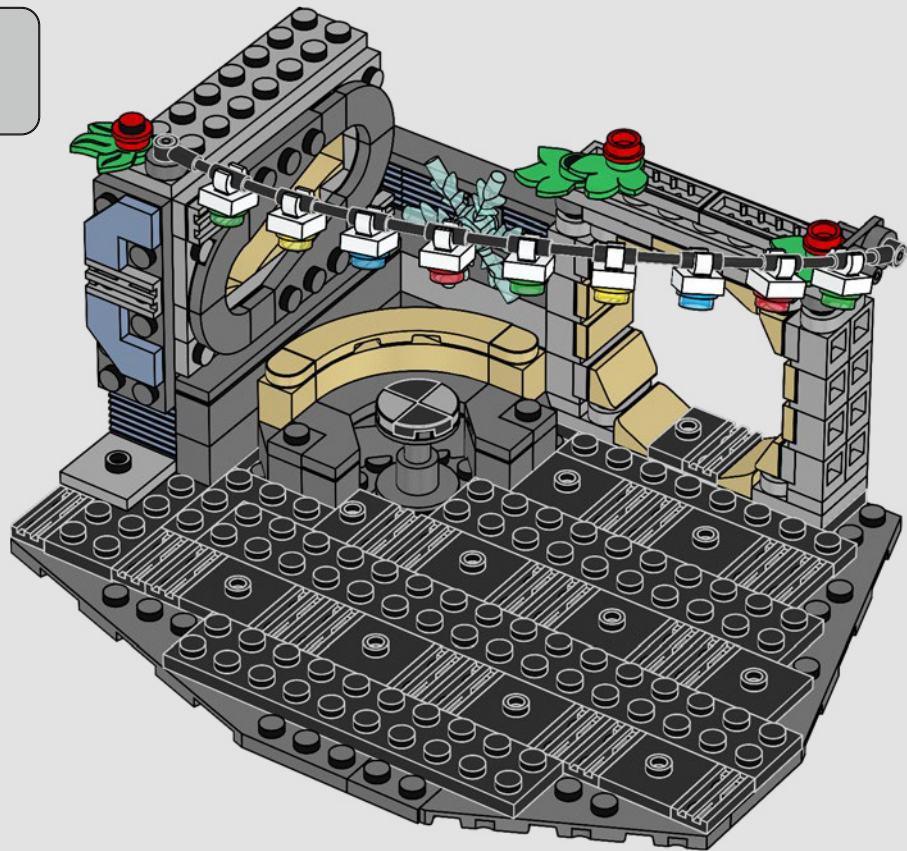

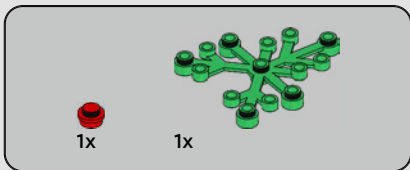

98

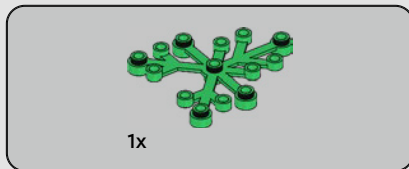
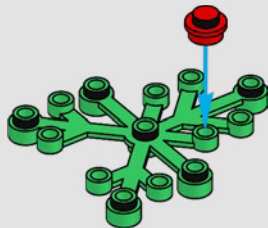

99

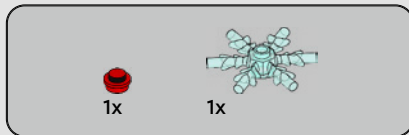
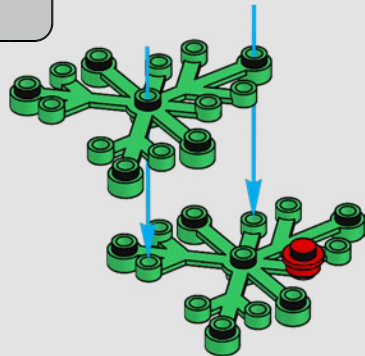

100

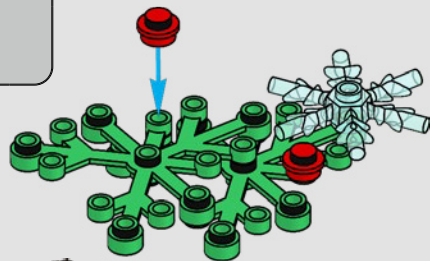

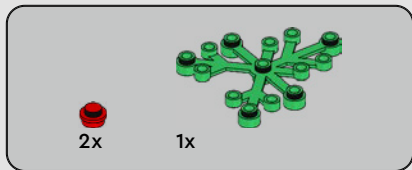

101

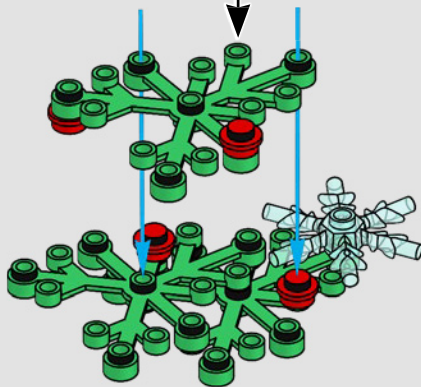
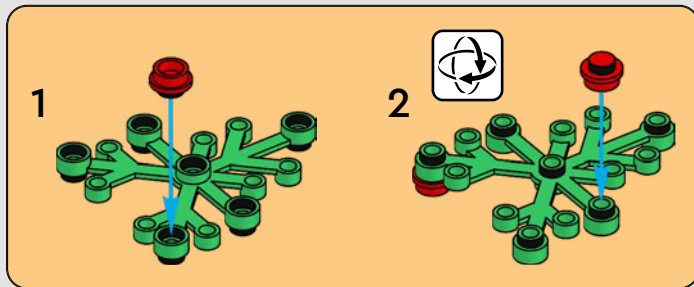



102

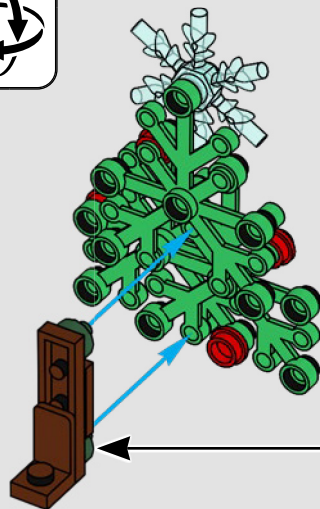
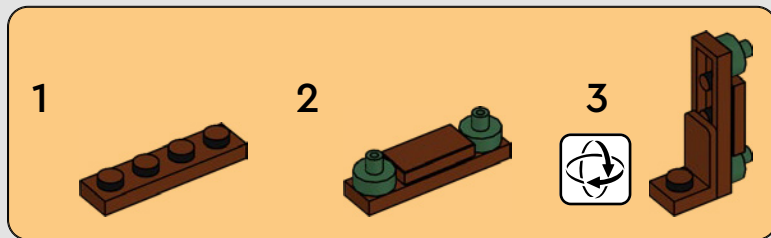

103

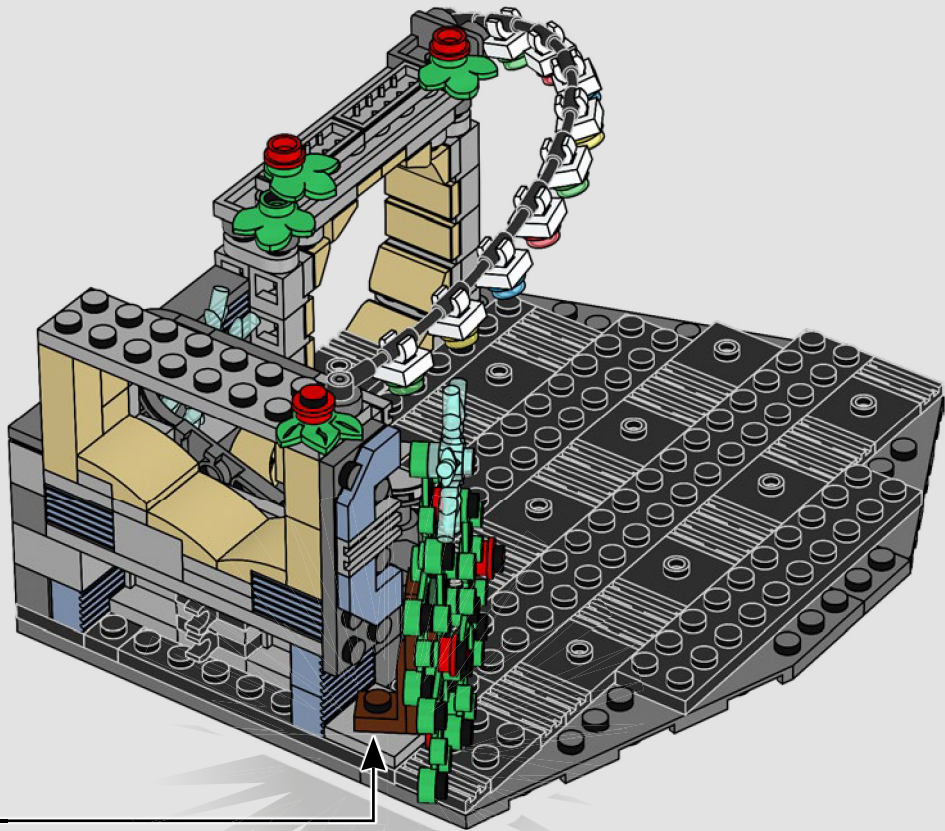





1x



1x

104

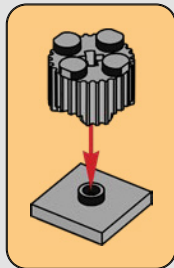
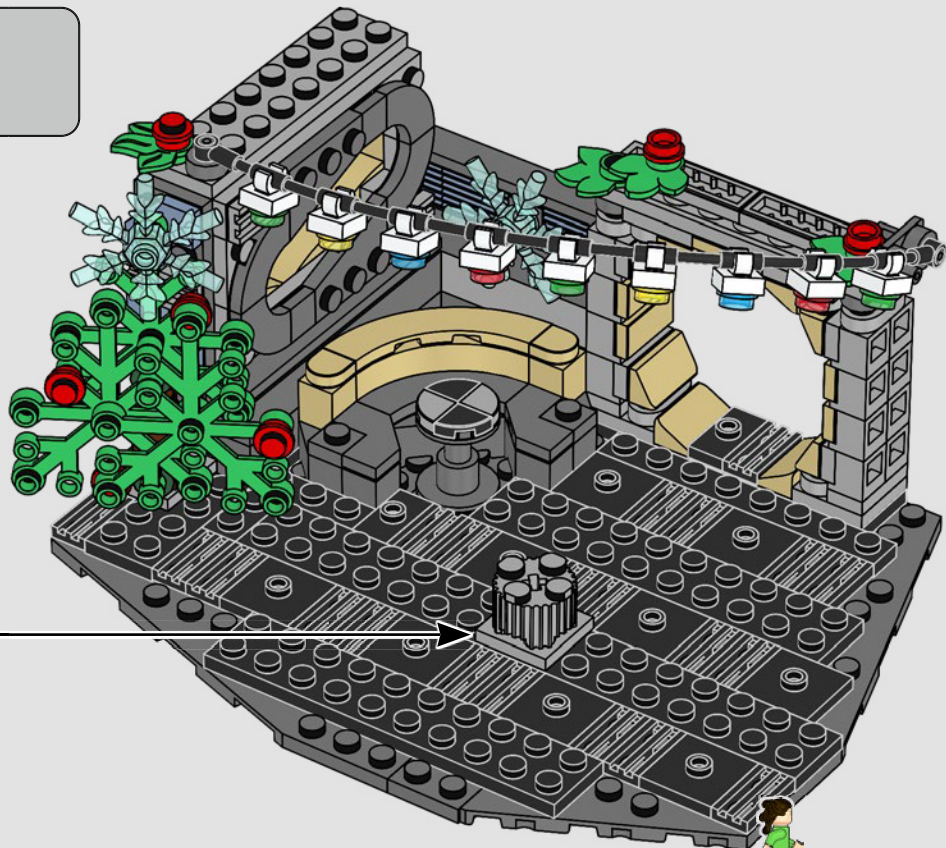
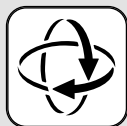

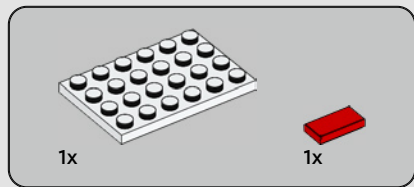

105

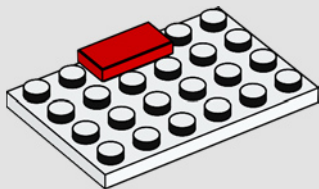

106

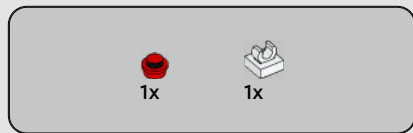
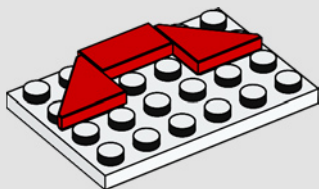

107

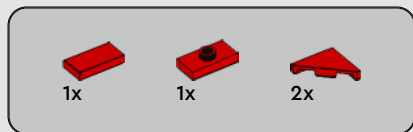
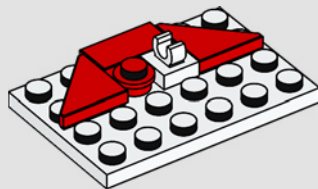

108

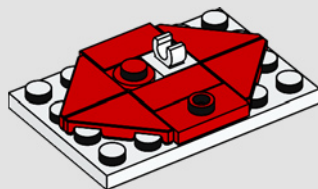



109

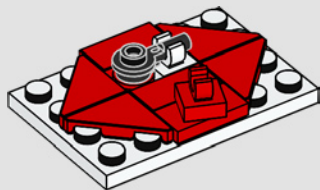

110

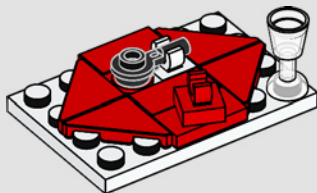

111

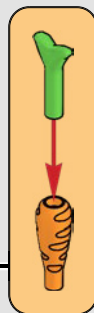
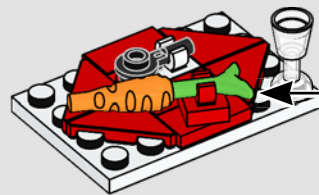

112



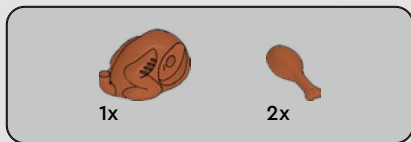

113

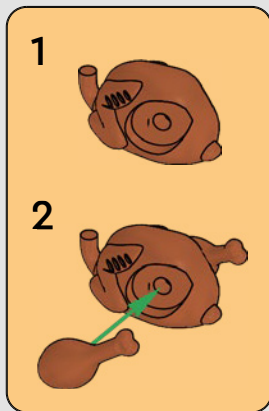

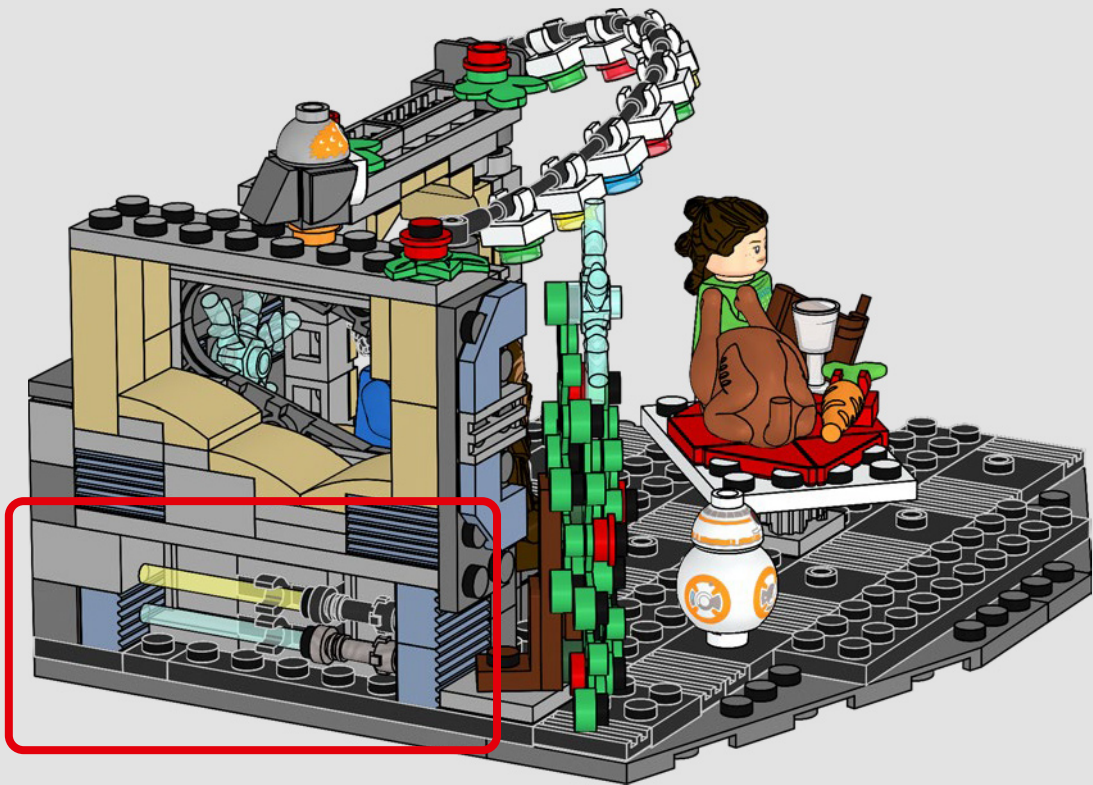





# STAR WARS



75364



75357



75354



75362







# STAR WARS™





1x  
6250591



1x  
6250308



10x  
6348055



1x  
6256089



1x  
9327



1x  
303201



2x  
6353196



2x  
4113915



5x  
6232135

90



1x  
6057517



8x  
4624086



1x  
6214334



7x  
4114026



1x  
6452537



3x  
6046924



1x  
6348203



8x  
614121



1x  
6348058



2x  
306921



1x  
6092565



4x  
6351892



1x  
6461221



1x  
4598897



2x  
6172383



1x  
6438933



1x  
6196548



21x  
241226



2x  
6313116



2x  
6092585



9x  
4565323



1x  
362326



1x  
6439175



2x  
346026



3x  
383226

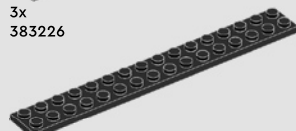

2x  
428226



1x  
6440995



4x  
6229130



3x  
6266968



1x  
4119479



1x  
6461209



2x  
6360331



1x  
6413062



1x  
6166107



2x  
6208450



1x  
6170187



2x  
6278421



2x  
6240214



2x  
6240216



3x  
6240221



1x  
6170186



1x  
4157103



1x  
6424015



8x  
6177135



2x  
6398674



1x  
6279715



2x  
6392975



1x  
6199571



1x  
6341553



1x  
6167879



1x  
4211151



1x  
6459446



1x  
4211190



1x  
6250309



2x  
4211399



1x  
4211389



16x  
4211476



2x  
6176433



6x  
6248890



1x  
4650645



12x  
4211398



3x  
4211350



2x  
4593679



2x  
6126082



3x  
4211353



2x  
4211387



7x  
4211397



2x  
6211969



1x  
4211393



2x  
4211425



3x  
4211406



7x  
6271752



2x  
4210848



1x  
4558955



2x  
4210719



1x  
4504378



2x  
6199549



1x  
4210700



2x  
4210869



1x  
6106283



2x  
6230233



1x  
6214341



4x  
6265306



2x  
6177079



6x  
4624186



1x  
6266298



1x  
6266298



1x  
4582257



1x  
6393306



1x  
4211002



4x  
4211099



2x  
4211008

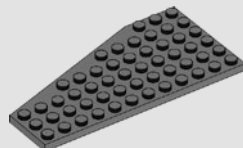

1x  
6348156



2x  
4211114



1x  
6470979

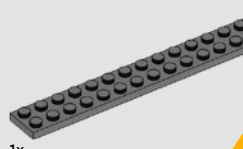

1x  
4210796



1x  
6124907



1x  
6122095



1x  
6063675



1x  
6063666



1x  
6058788



1x  
6058788



1x  
6051389

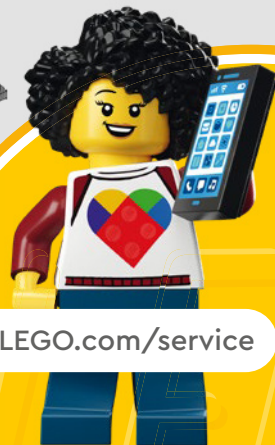

 [LEGO.com/service](https://www.LEGO.com/service)

YOU COULD  
**WIN**



Scan this QR code or go to  
**LEGO.COM/PRODUCTFEEDBACK** and give us  
your short feedback about this LEGO® set for  
a chance to win a cool LEGO prize.

Terms and Conditions apply\*



**EN: YOU COULD WIN.** Terms and Conditions apply\* **DE: Du könntest GEWINNEN.** Es gelten die Teilnahmebedingungen\* **FR: Tu pourrais GAGNER.** Des conditions s'appliquent\* **IT: Potresti VINCERE tu.** Termini e condizioni sono applicabili\* **ES: Puedes GANAR.** Aplican términos y condiciones\* **PT: Poderá GANHAR.** Aplicam-se termos e condições\* **ZH: 轻松获奖. 条款和条件适用\*** **PL: Szansa na WYGRANĄ.** Obowiązują warunki korzystania\* **CS: Máte šanci VYHRÁT.** Platí všeobecné smluvní podmínky\* **SK: Máte šancu VYHRAŤ.** Platia všeobecné zmluvné podmienky\* **HU: TE IS NYERHETSZ.** Felhasználási feltételek érvényesek\* **RO: Ai putea CÂȘTIGA.** Se aplică termeni și condiții\* **BG: Можете да СПЕЧЕЛИТЕ.** Има определени правила и условия\* **LV: Tu vari LAIMĒT.** Ir spēkā noteikumi un nosacījumi.\* **ET: Sul on võimalus VÕITA.** Kehtivad tingimused\* **LT: Jūs galite LAIMĖTI.** Taikomos sąlygos\*

\*[LEGO.com/productfeedback-terms](https://www.lego.com/productfeedback-terms)

LEGO and the LEGO logo are trademarks of the/sont des marques de commerce du/son marcas registradas de LEGO Group. ©2023 The LEGO Group.

© & ™ Lucasfilm Ltd.

6480400