



40585





### **Get excited about our new packaging!**

We're switching from plastic to paper-based packaging. That's why you might find a mix of paper and plastic in our boxes!

### **Nos nouveaux emballages vous emballeront !**

Nous passons des emballages en plastique aux emballages à base de papier. C'est pourquoi vous pourriez trouver un mélange de papier et de plastique dans nos boîtes !

### **¡Te presentamos nuestros nuevos empaques!**

Estamos sustituyendo las bolsas de plástico por bolsas con base de papel. ¡Por eso, puedes encontrar una mezcla de papel y de plástico en nuestras cajas!

**[LEGO.com/sustainable-packaging](https://www.lego.com/sustainable-packaging)**

# BUILD YOUR OWN WORLD OF WONDERS



## TAJ MAHAL

The first stop on your tour of the Wonders of the World is the Taj Mahal – a breathtaking monument to everlasting love. In 1631, the emperor Shah Jahan commissioned the stunning marble mausoleum in Agra, India, in memory of his wife, the Empress Mumtaz Mahal. An ethereal vision of perfection that took 17 years to complete, it remains a majestic symbol of divine perfection, balance and harmony.

## THE GREAT WALL OF CHINA

This astounding architectural marvel stretches more than 13,100 miles (20,000 km), or the equivalent of halfway around the Equator, through the Northern part of China. The Great Wall consists of a series of separate walls, fortresses, passes and beacon towers. Constructed between 700 BC and the 17<sup>th</sup> century AD, its historical and cultural significance throughout the millennia is unparalleled.



## THE PARTHENON

The Parthenon, part of The Acropolis of Athens, Greece, was erected in the 5<sup>th</sup> century BC. Groundbreaking architects and sculptors transformed the rocky Athenian hilltop into a lasting tribute to beloved ancient gods. The Acropolis is now mostly known as the birthplace of classical Greek culture and art, as well as philosophy, democracy and the intellectual foundation for our modern-day values.



## AL KHAZNEH

Your final stop is Al-Khazneh (The Treasury) in the ancient city of Petra, Jordan. Half-built, half-carved into a red sandstone gorge during the 4<sup>th</sup> century BC, the structure included a sophisticated watering and sewage system. Once part of the capital of the Nabataean Kingdom, and a thriving, pivotal trade center for Indian, Chinese and Arabic goods, it is now one of the largest archeological sites in the world.



# CONSTRUISEZ VOTRE PROPRE MONDE DE MERVEILLES



## LE TAJ MAHAL

Le premier arrêt de votre découverte des merveilles du monde est le Taj Mahal, un monument à couper le souffle dédié à l'amour éternel. En 1631, l'empereur Shah Jahan fait construire un étonnant mausolée en marbre à Agra, en Inde, à la mémoire de son épouse, l'impératrice Mumtaz Mahal. Vision éthérée de la perfection ayant nécessité 17 ans de travaux, le Taj Mahal reste un symbole majestueux de la perfection divine, de l'équilibre et de l'harmonie.

## LA GRANDE MURAILLE DE CHINE

Cette stupéfiante merveille architecturale s'étend sur plus de 20 000 km, soit l'équivalent de la moitié du tour de l'équateur, à travers la partie nord de la Chine. La Grande Muraille est composée d'une série de murs séparés, de forteresses, de cols et de tours de guet. Construite entre 700 avant J.-C. et le 17<sup>e</sup> siècle après J.-C., elle revêt une importance historique et culturelle inégalée au fil des millénaires.



## LE PARTHÉNON

Le Parthénon, qui fait partie de l'Acropole d'Athènes, en Grèce, a été érigé au 5<sup>e</sup> siècle avant Jésus-Christ. Des architectes et des sculpteurs révolutionnaires ont transformé le sommet rocheux de la colline athénienne en un hommage durable aux dieux antiques vénérés. L'Acropole est aujourd'hui surtout connue comme le berceau de la culture et de l'art grecs classiques, ainsi que de la philosophie, de la démocratie et du fondement intellectuel de nos valeurs modernes.



## LA KHAZNEH

Le dernier arrêt est la Khazneh (« le trésor ») dans l'ancienne ville de Petra, en Jordanie. Mi-construite, mi-taillée dans une gorge de grès rouge au 4<sup>e</sup> siècle avant J.-C., la structure comprend un système sophistiqué de canalisation et d'évacuation des eaux usées. Autrefois partie intégrante de la capitale du royaume nabatéen et centre de commerce essentiel pour les marchandises indiennes, chinoises et arabes, c'est aujourd'hui l'un des plus grands sites archéologiques du monde.

# CONSTRUYE TU PROPIO MUNDO DE MARAVILLAS



## EL TAJ MAHAL

La primera parada de tu itinerario por las Maravillas del Mundo es el Taj Mahal: un impresionante monumento al amor eterno. En 1631, el emperador Shah Jahan encargó la construcción de este impresionante mausoleo de mármol en Agra (India) para honrar la memoria de su esposa, la emperatriz Mumtaz Mahal. Una visión etérea de la perfección para cuya ejecución se necesitaron 17 años, sigue siendo un majestuoso símbolo del carácter perfecto, equilibrado y armonioso de lo divino.

## LA GRAN MURALLA CHINA

Esta impresionante maravilla arquitectónica se extiende más de 20.000 km (el equivalente a la mitad del ecuador de la Tierra) por la parte norte de China. La Gran Muralla se compone de una serie de murallas, fortalezas, pasos y torres almenara independientes. Construida entre 700 a. C. y el siglo XVII d. C., su importancia histórica y cultural a lo largo de milenios no tiene comparación.



## EL PARTENÓN

El Partenón, parte de la acrópolis de Atenas (Grecia), se erigió en el siglo V a. C. Revolucionarios arquitectos y escultores transformaron la rocosa cima de la colina ateniense en un homenaje perdurable a los reverenciados dioses antiguos. La Acrópolis es hoy principalmente conocida por ser la cuna de la cultura y el arte griegos clásicos, la filosofía, la democracia y los fundamentos intelectuales de los valores modernos.



## AL-KHAZNEH

La última parada es Al-Khazneh (El Tesoro), en la antigua ciudad de Petra (Jordania). Mitad edificada y mitad tallada en un desfiladero de arenisca roja durante el siglo IV a. C., la estructura incluía un sofisticado sistema de riego y alcantarillado. La que fuera parte de la capital del reino nabateo y un próspero y fundamental centro de comercio de productos procedentes de India, China y Arabia, es hoy uno de los yacimientos arqueológicos más grandes del mundo.





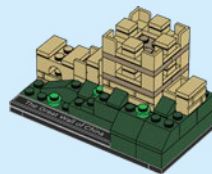
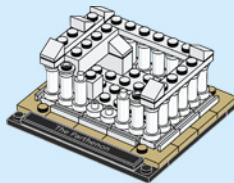
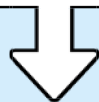
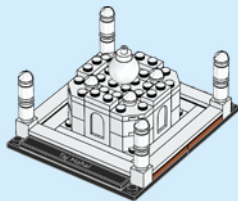
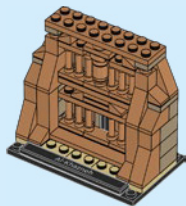
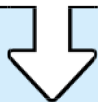

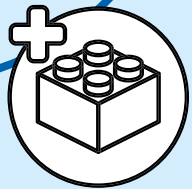
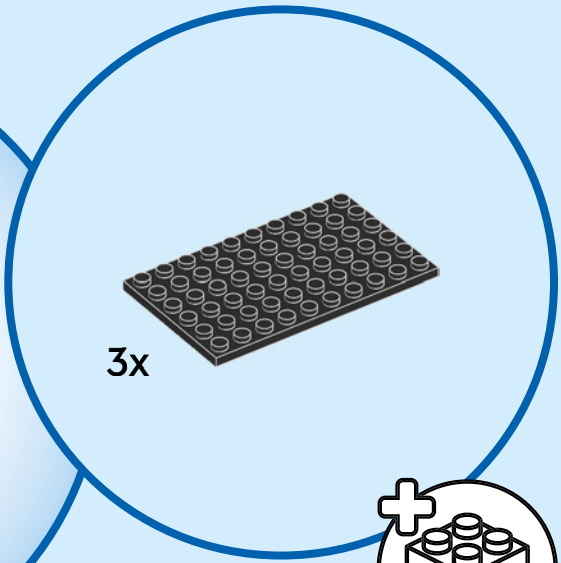

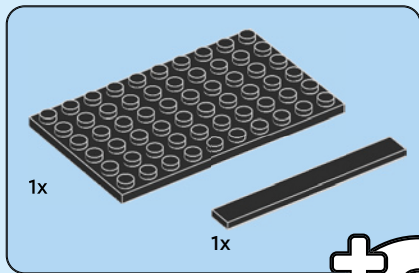
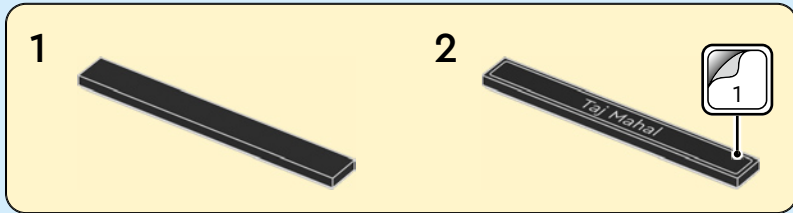
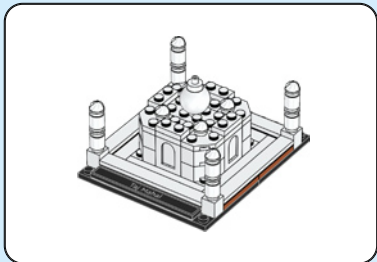

1

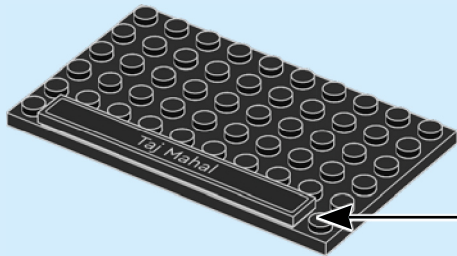
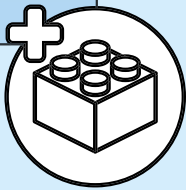



2x



2x

2

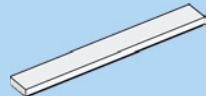
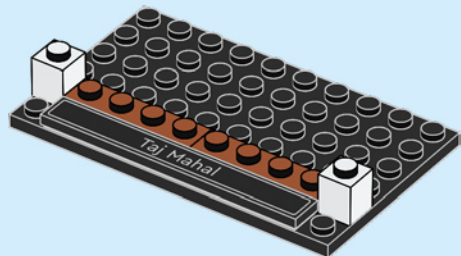

1x

3

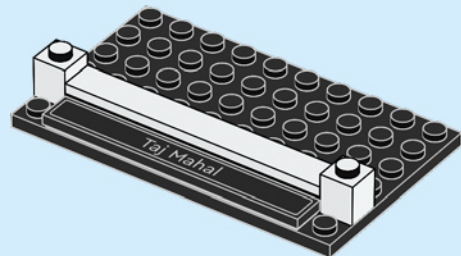

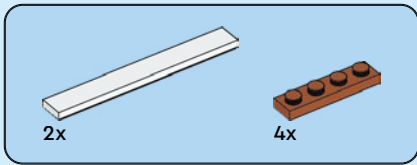

4

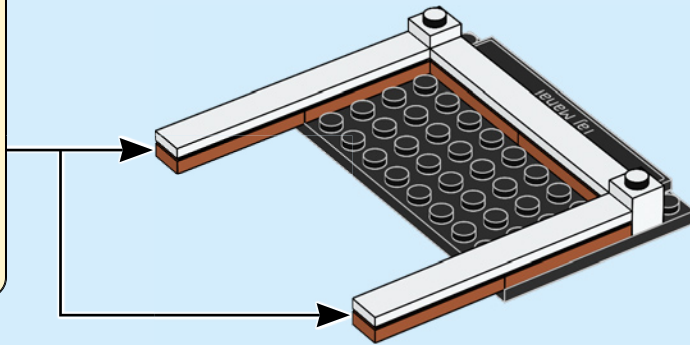
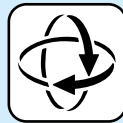
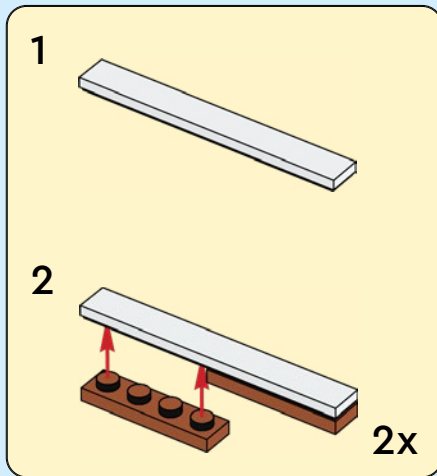

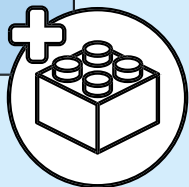
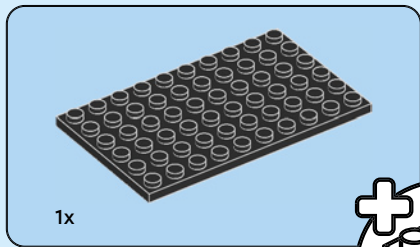

5

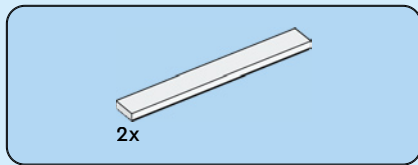
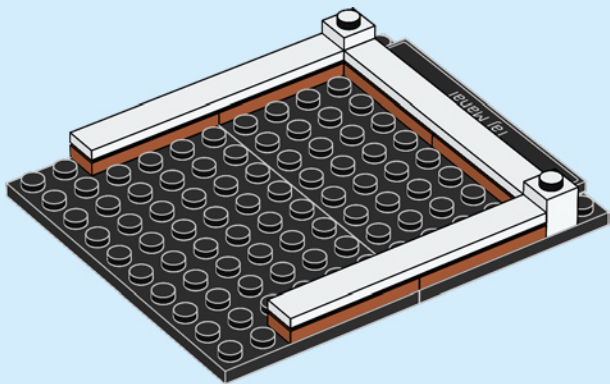

6

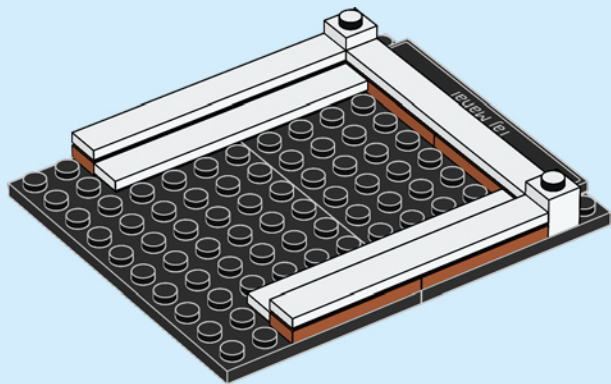

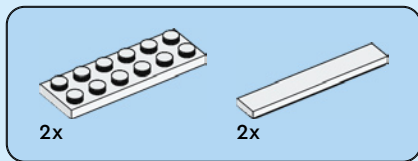

7

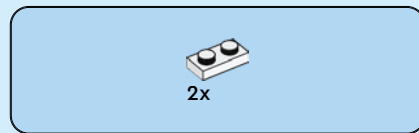
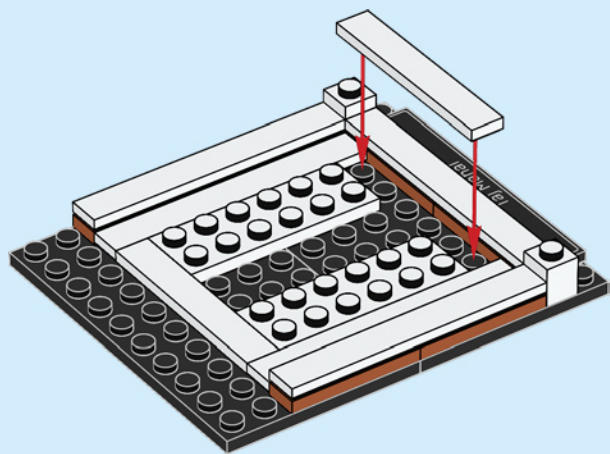

8

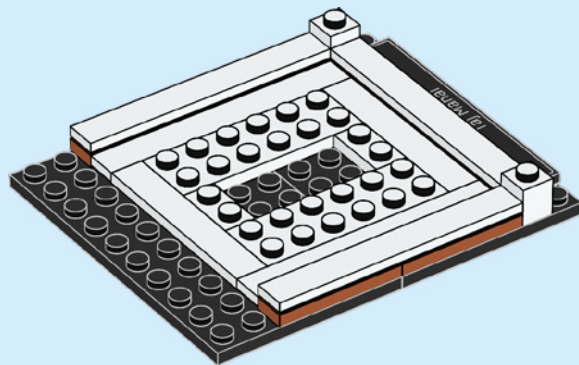

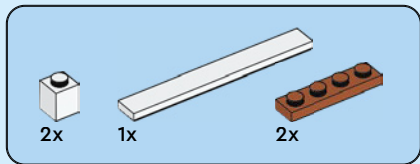

9

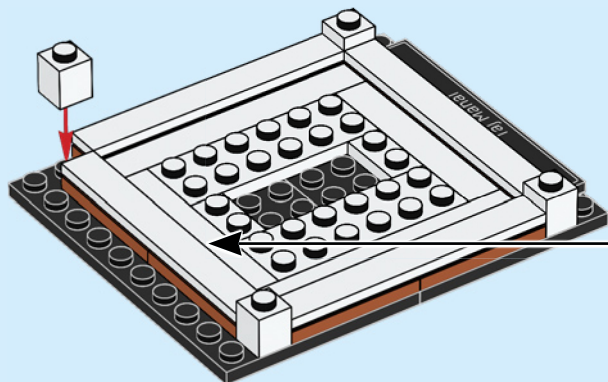
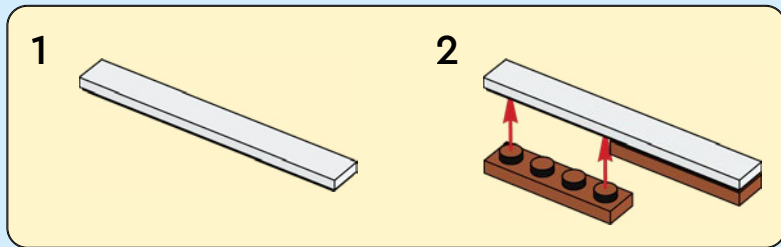



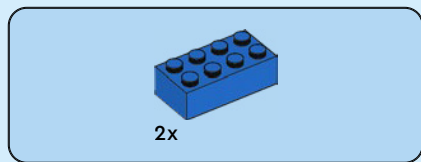

10

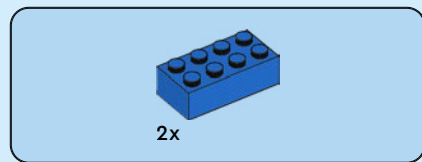
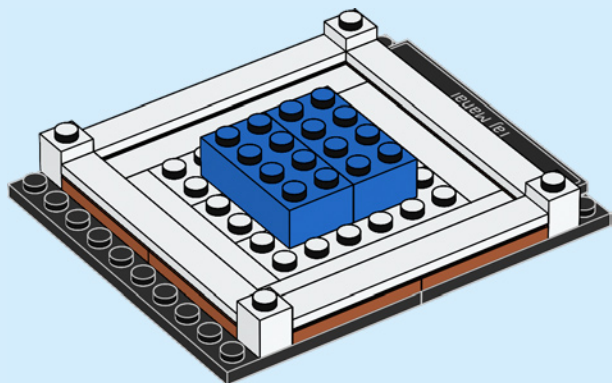

11

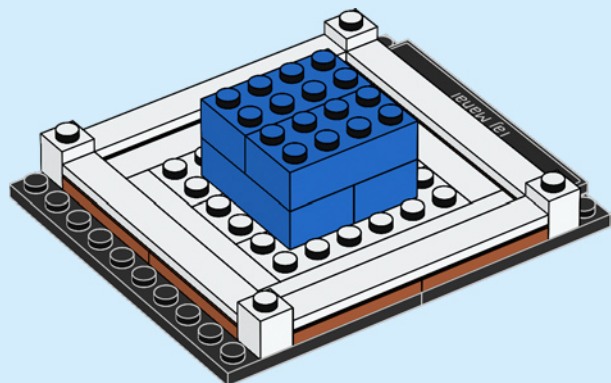



8x

12

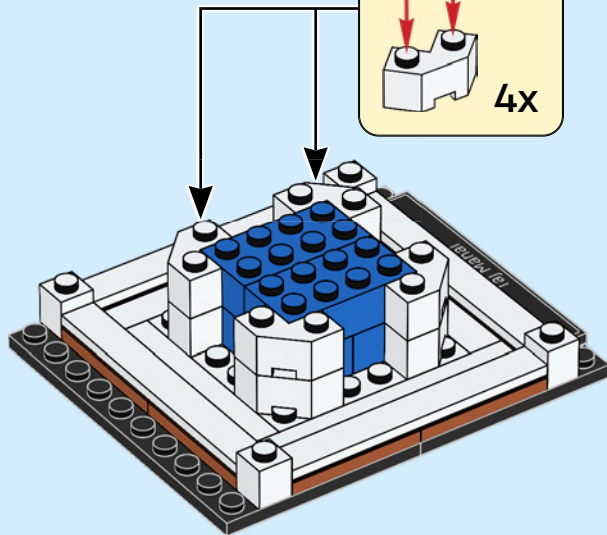
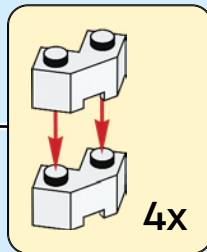

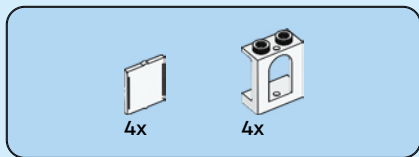

13

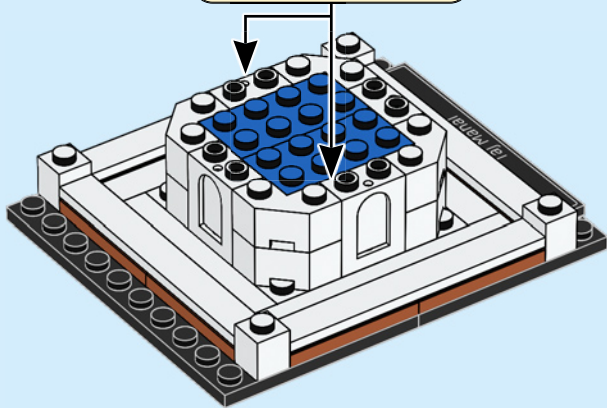
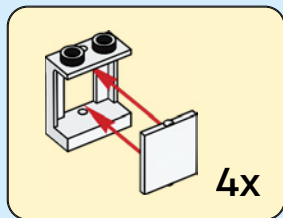

14

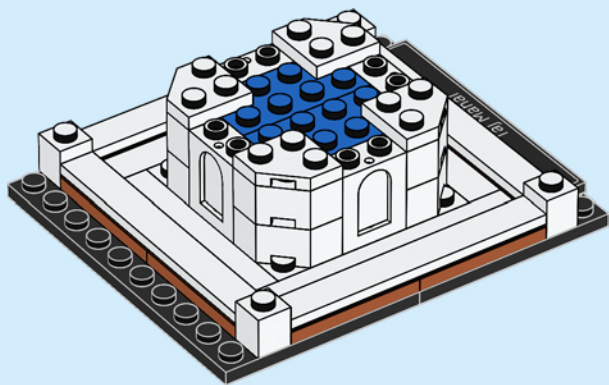

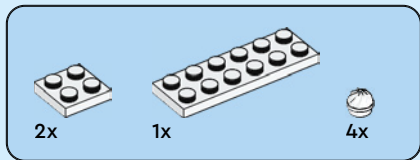

15

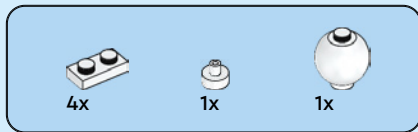
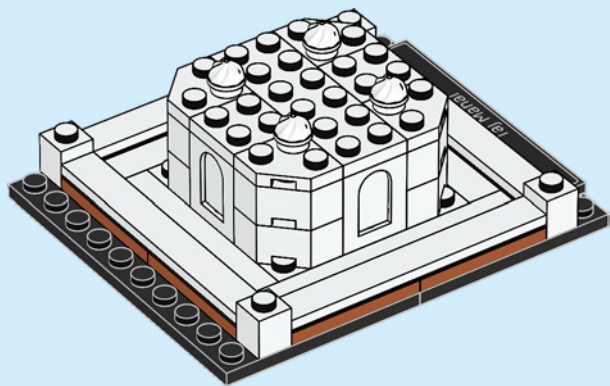

16

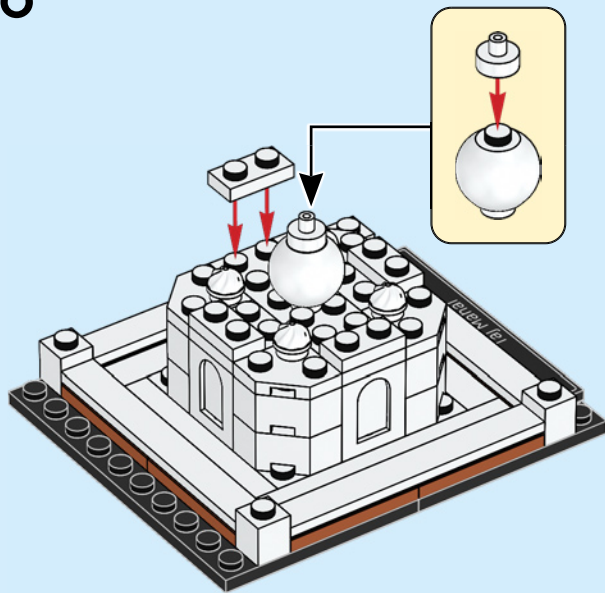



8x



4x



4x

17

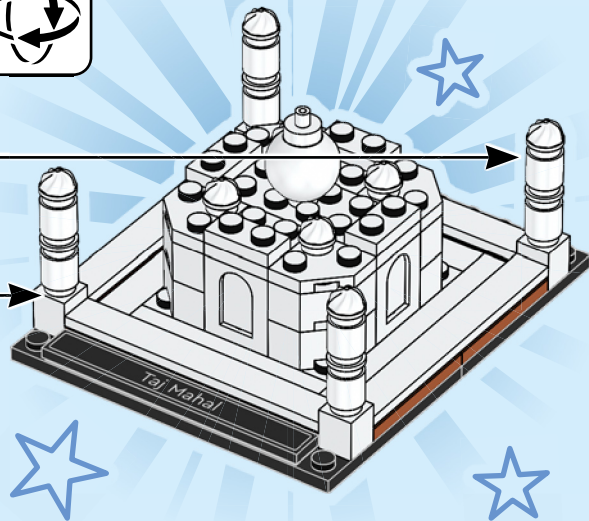
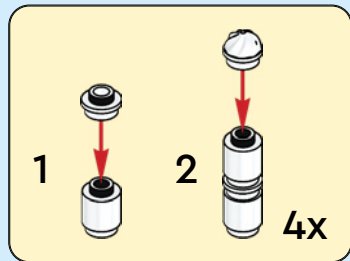
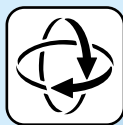

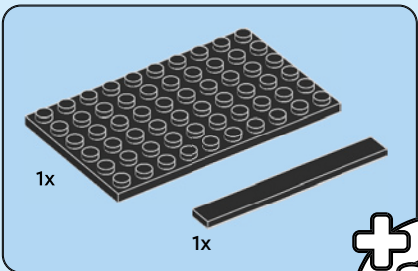
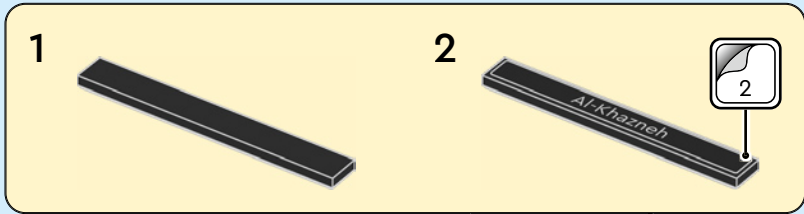

1

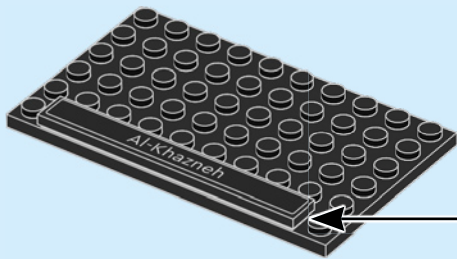
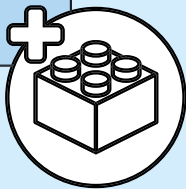

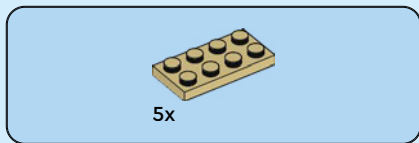

2

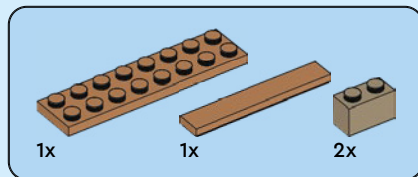
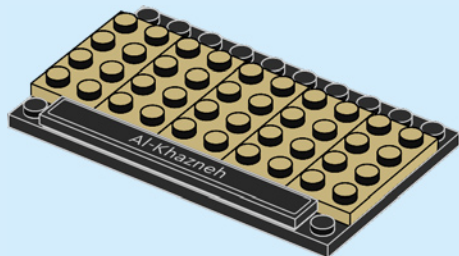

3

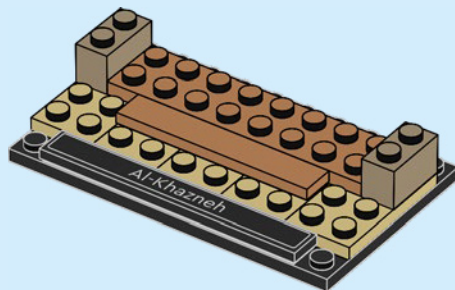



2x



3x

4

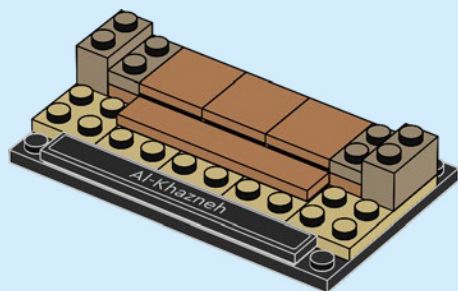





1x



3x



1x



3x

5

1

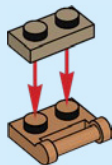

2

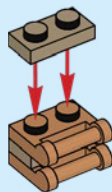

3

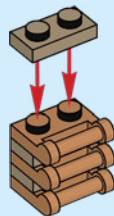

4





5

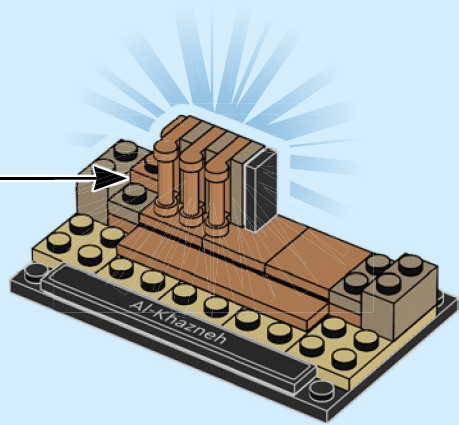
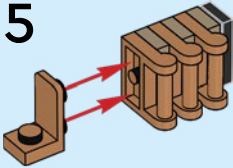

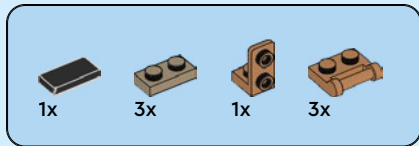

6

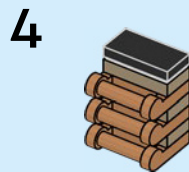
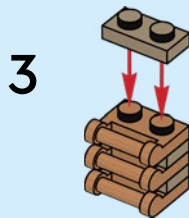
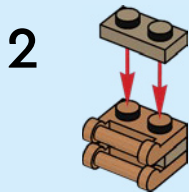
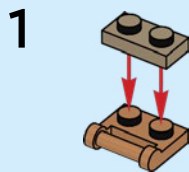

5

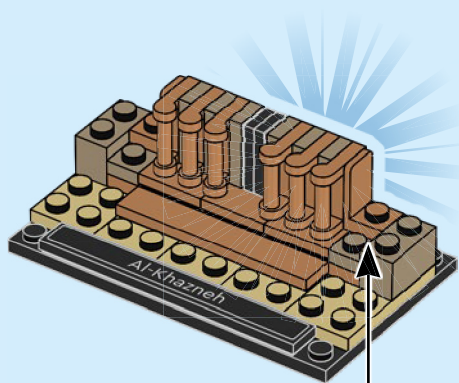
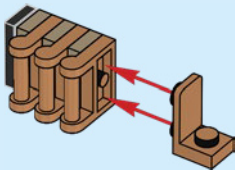



2x

7

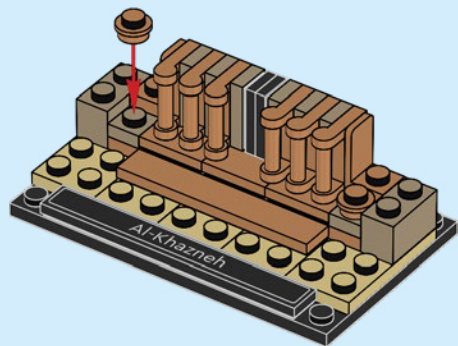

2x

8

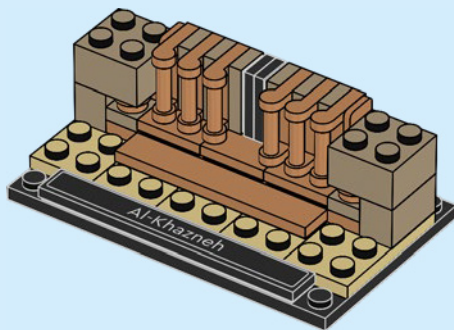



2x

9

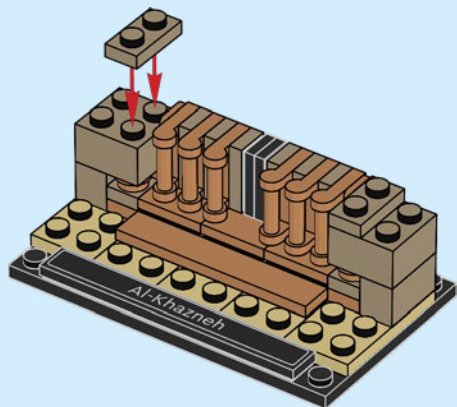

2x

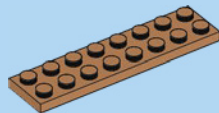

1x

10

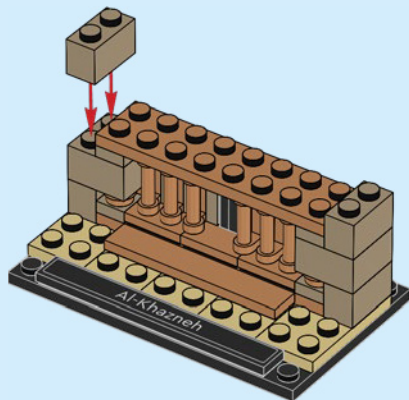

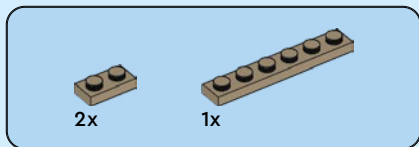

11

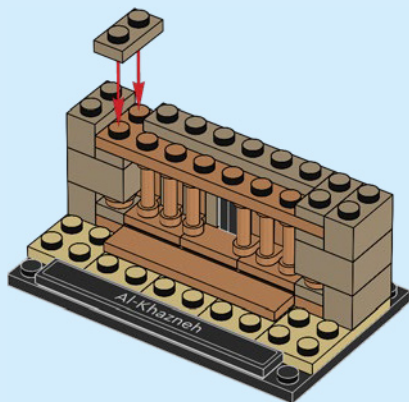

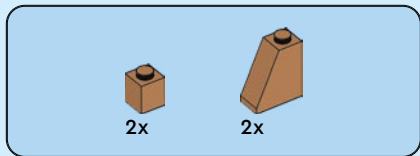

12

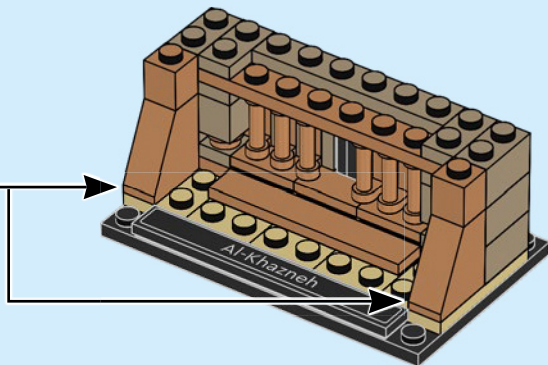
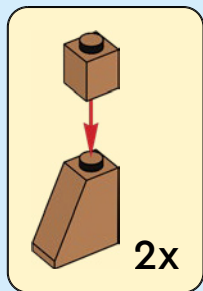



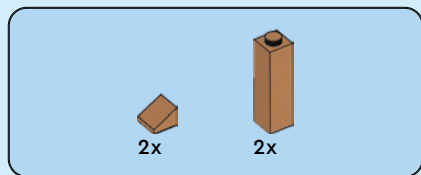

13

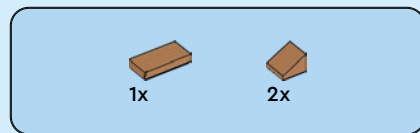
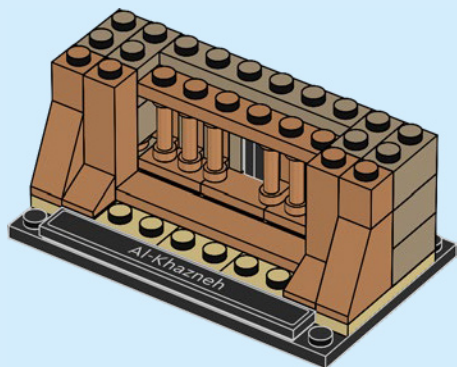

14

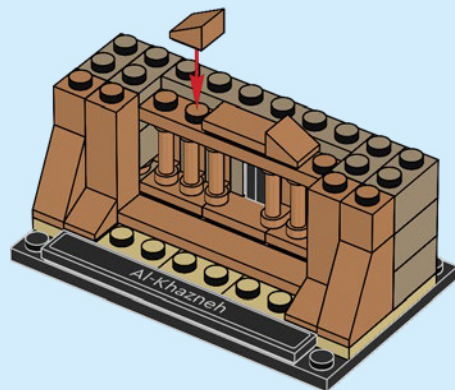



2x



1x

# 15

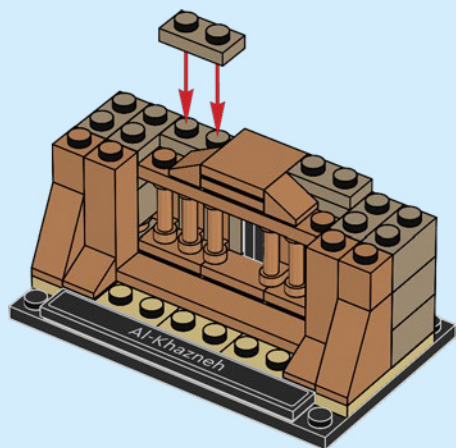

2x



2x

# 16

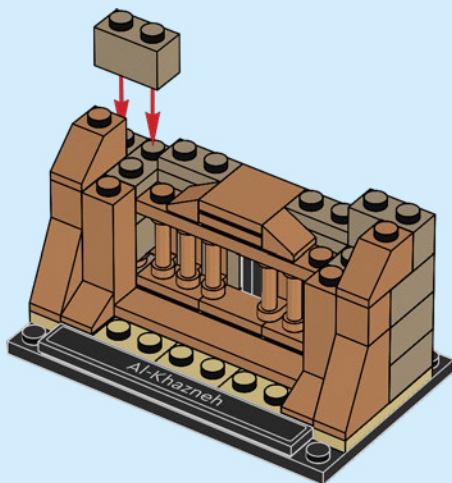

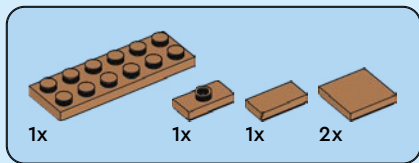

17

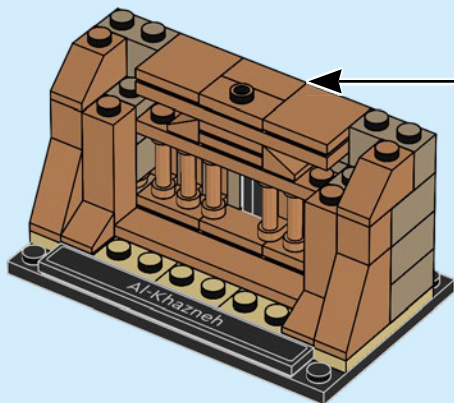
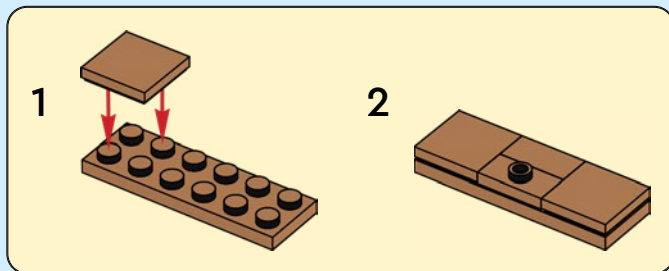



2x

18

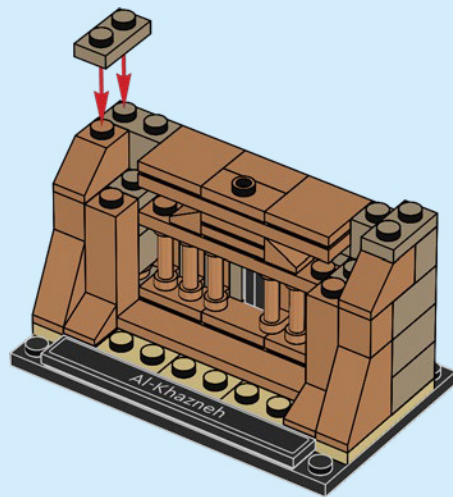

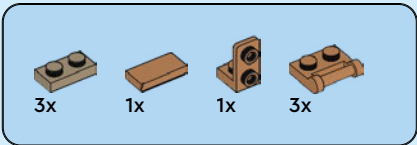

# 19

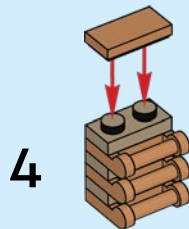
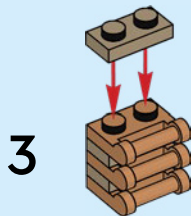
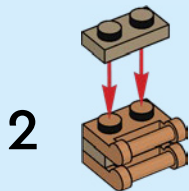
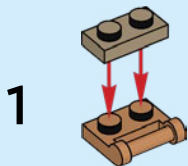

5

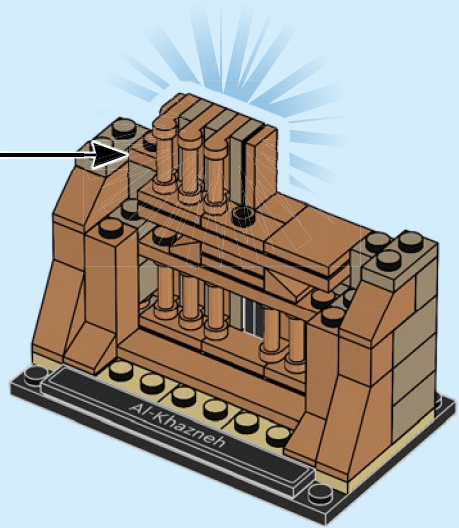
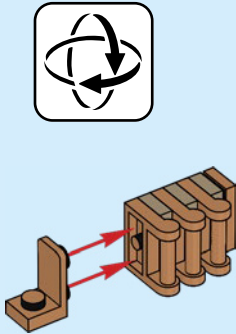

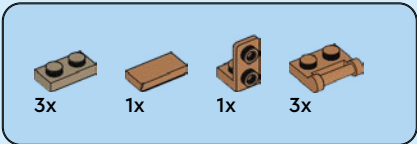

# 20

1

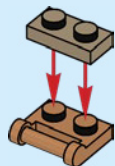

2

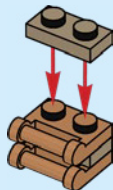

3

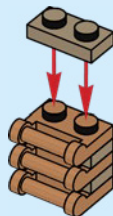

4

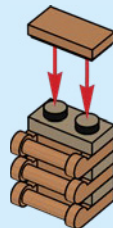



5

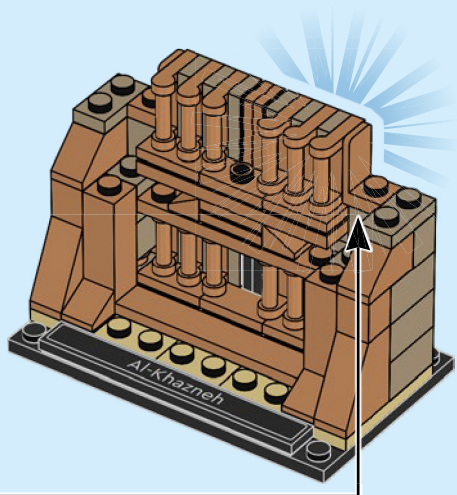
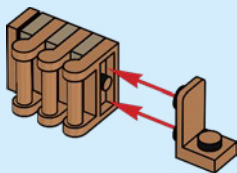



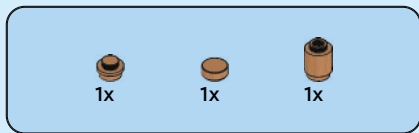

21

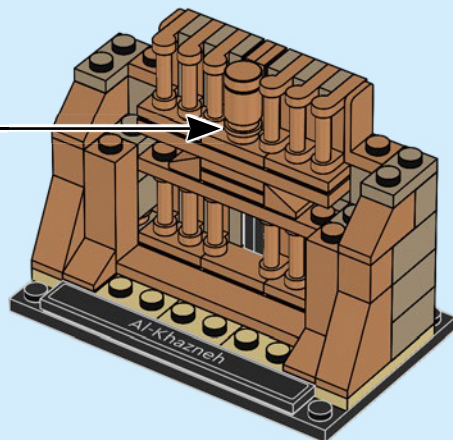
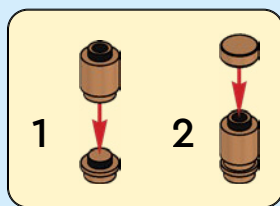

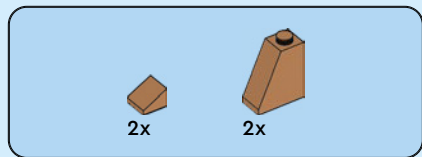

22

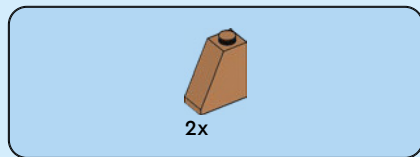
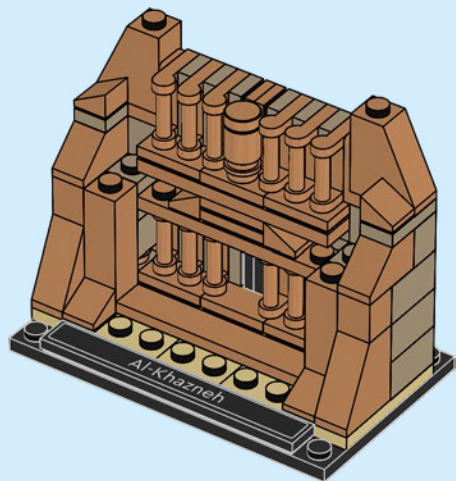

23

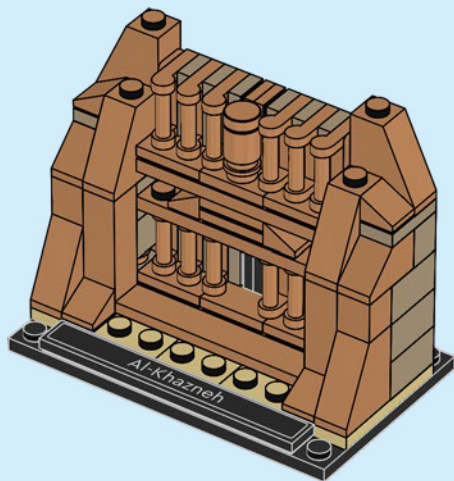



2x



2x

# 24

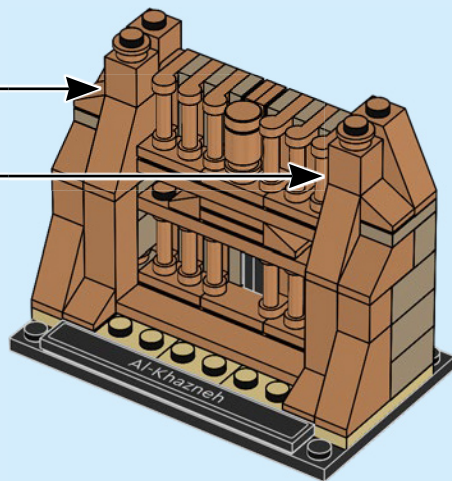
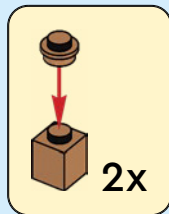

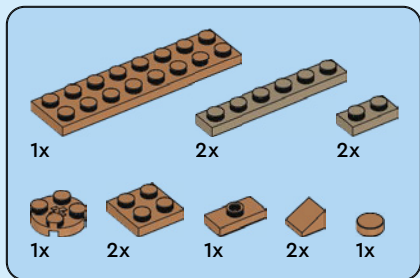

25

1

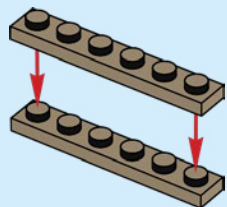

2

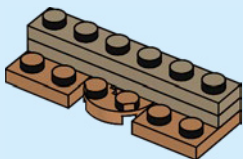

3

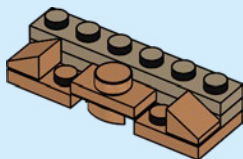

4

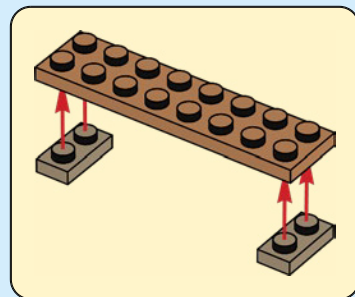
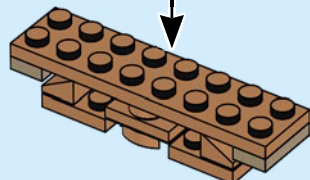

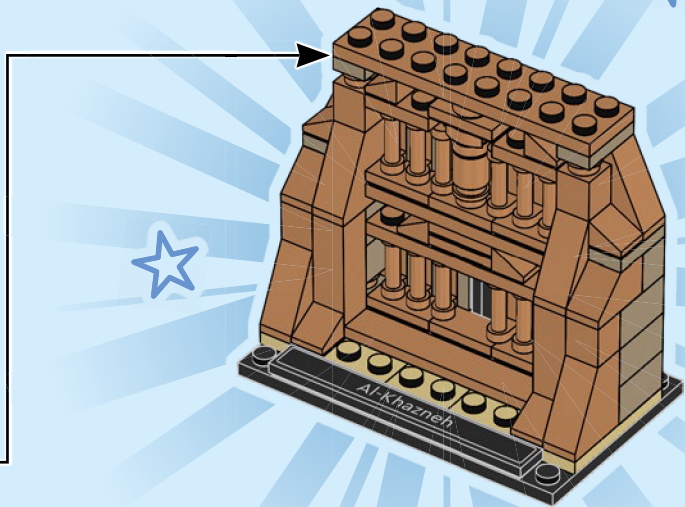

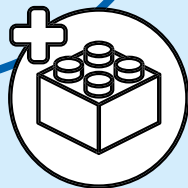
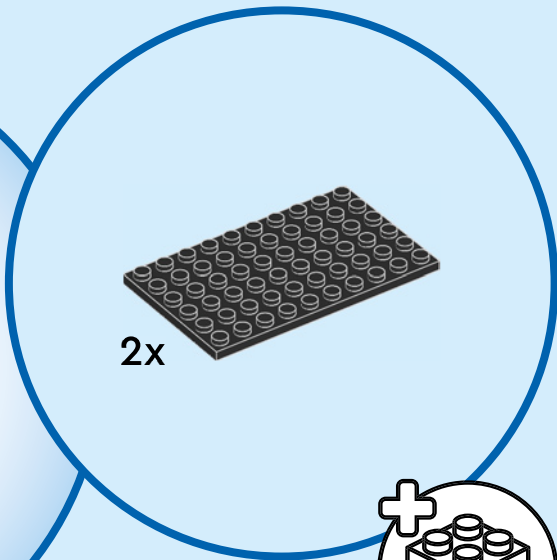
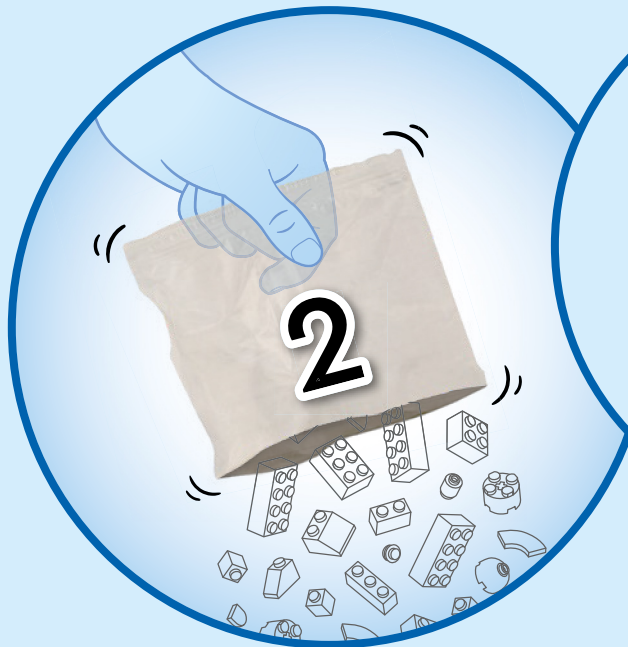

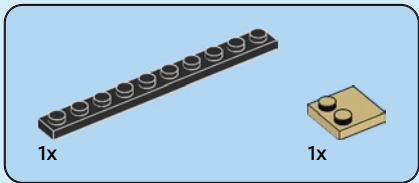
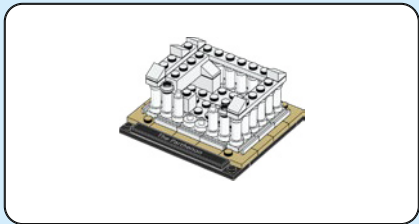

1

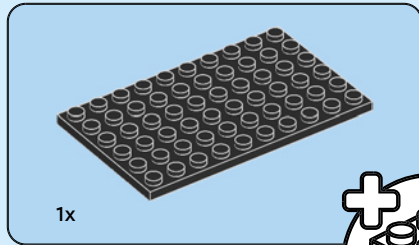
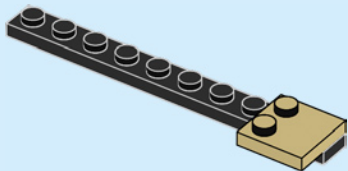

2

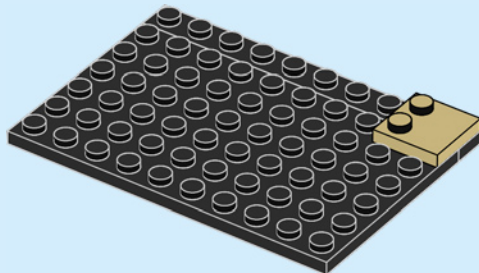
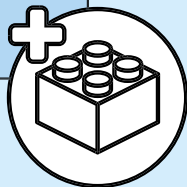



4x

3

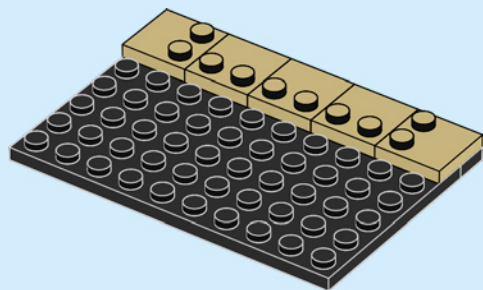

6x

4

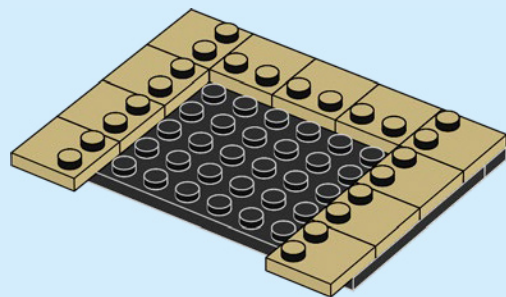



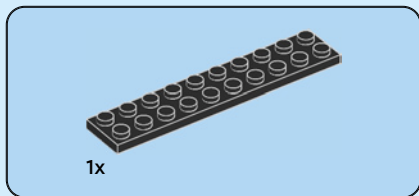

5

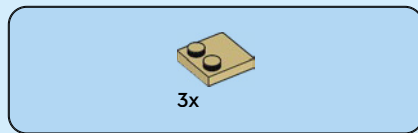
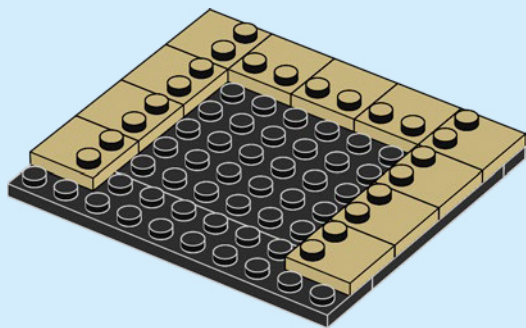

6

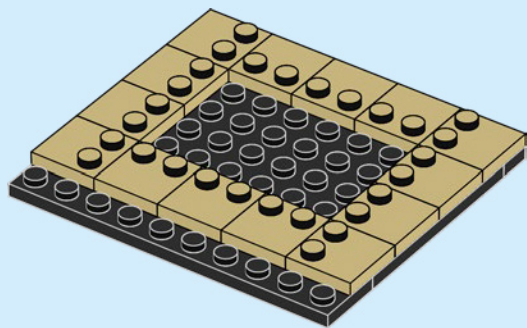

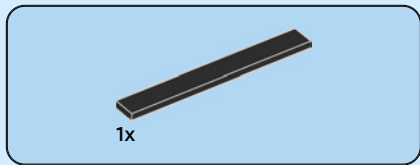

7

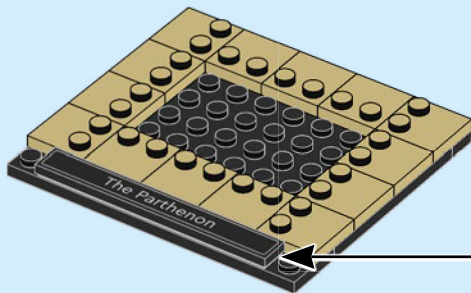
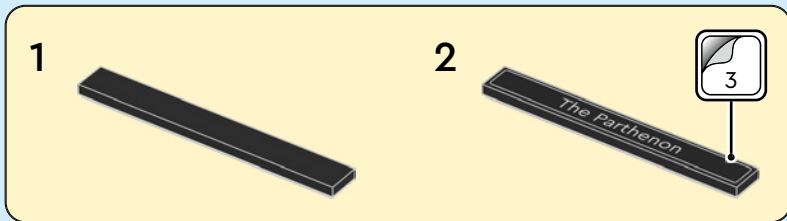



12x

8

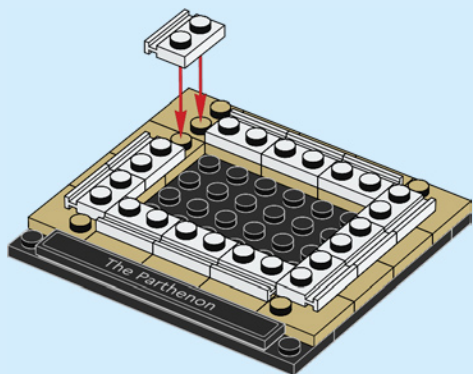

2x

9

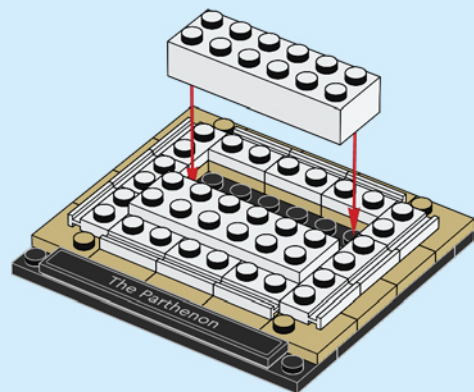



18x



18x

10

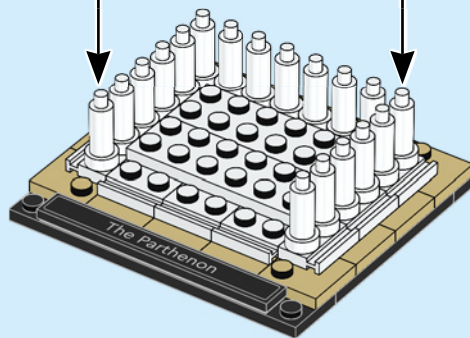
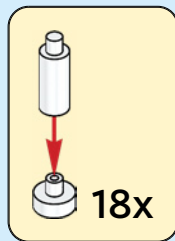

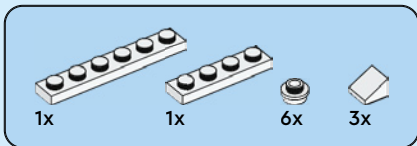

11

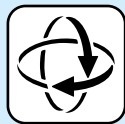

1

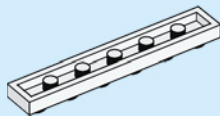

2

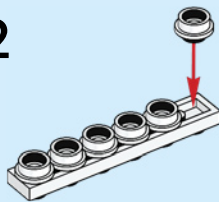

3

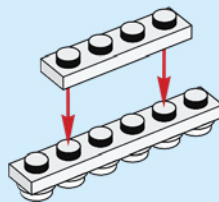

4

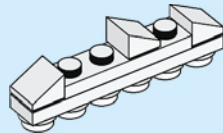

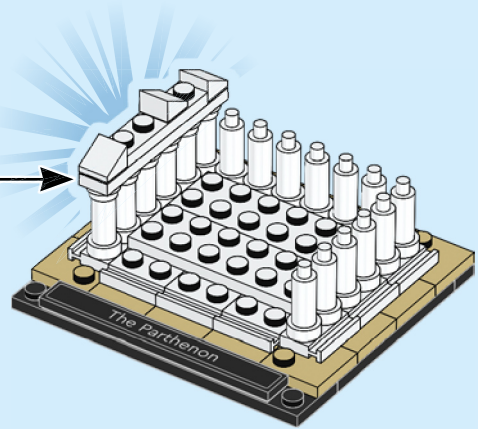

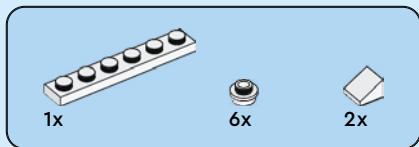

12

1

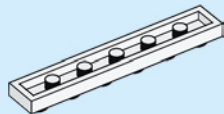

2

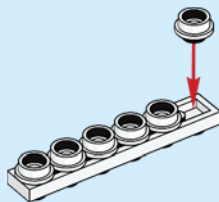

3

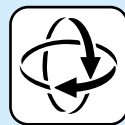
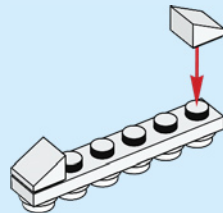

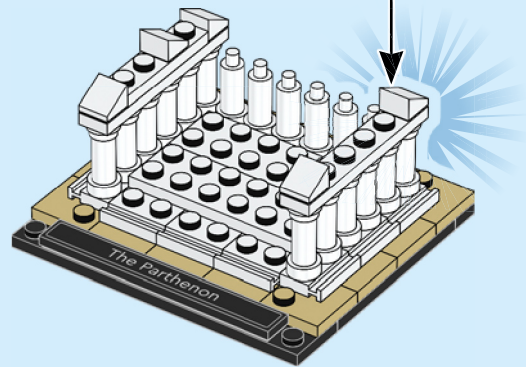



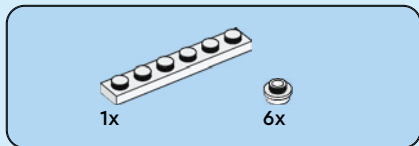

13

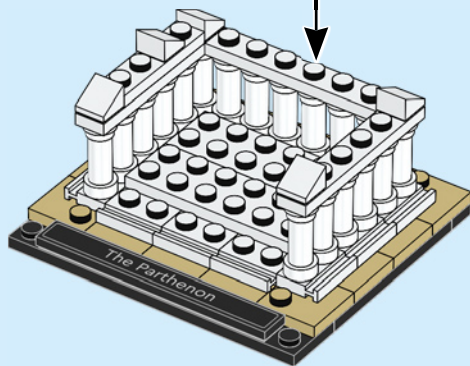
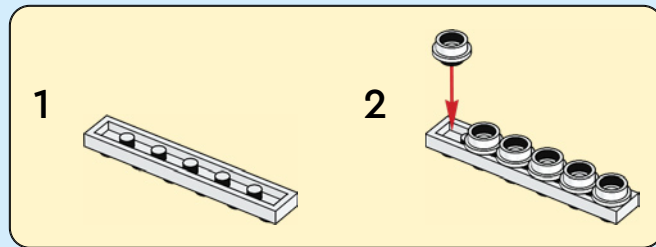



2x

14

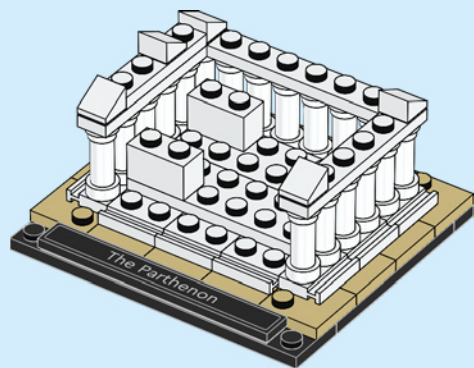

1x



1x

15

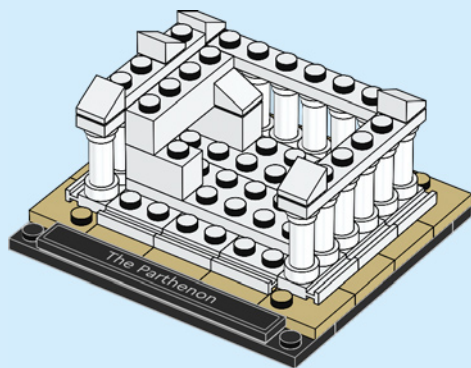



2x



2x



2x

# 16

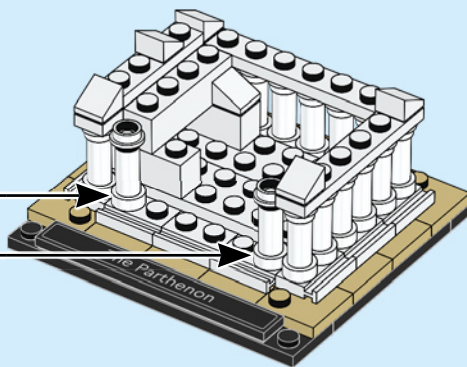
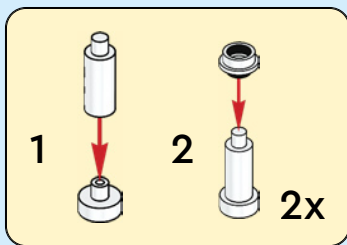



4x



2x

17

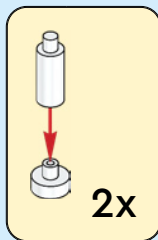
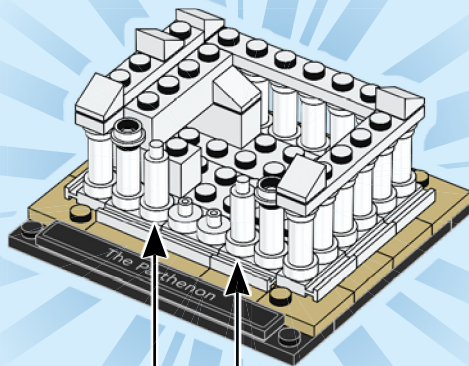

2x

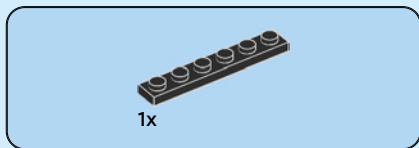
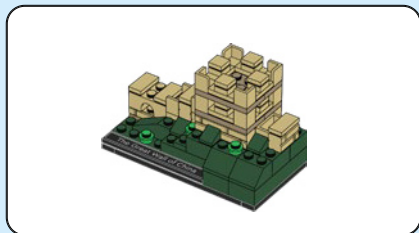

1

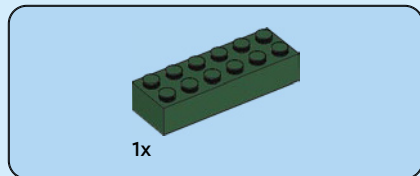
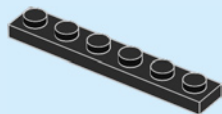

2

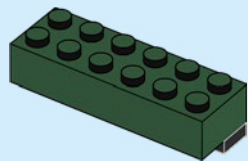

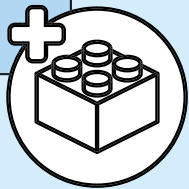
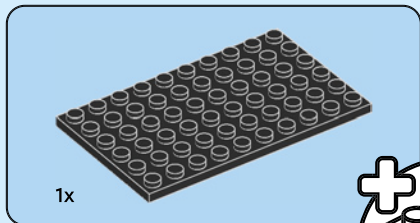

3

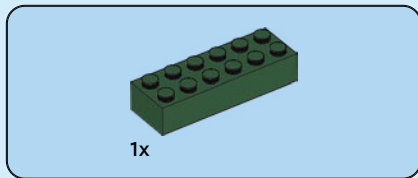
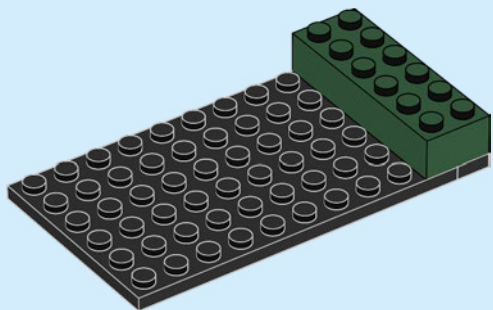

4

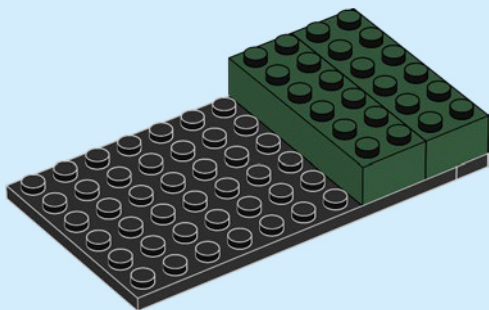

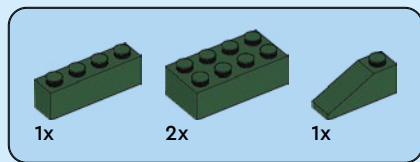

5

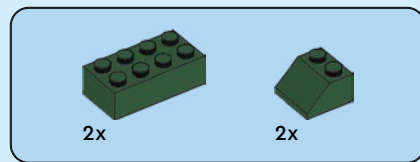
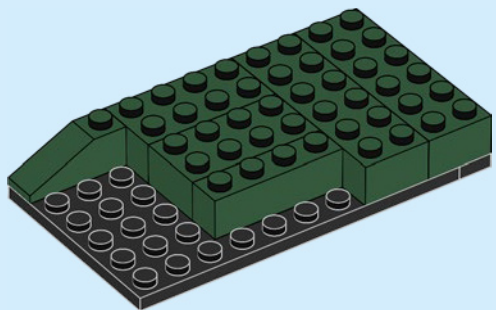

6

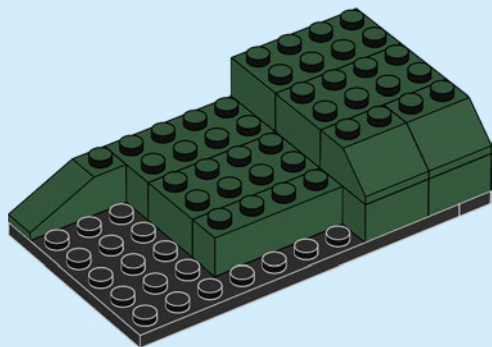

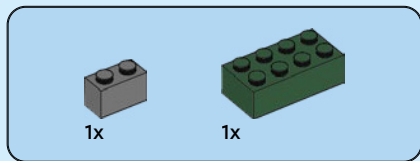

7

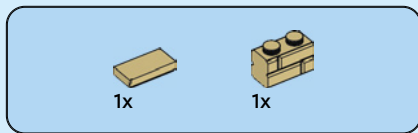
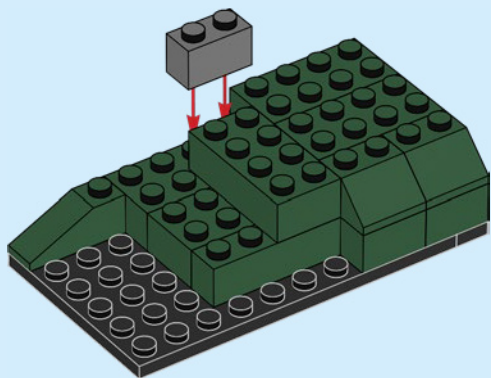

8

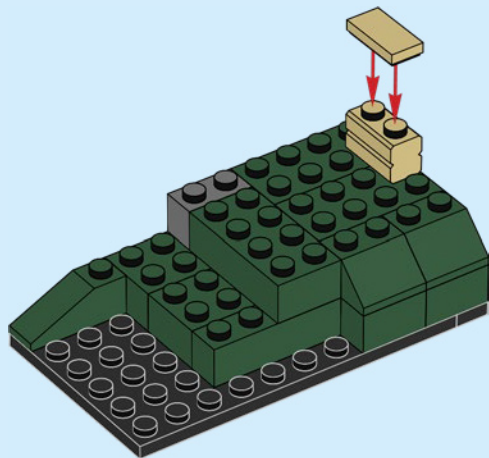



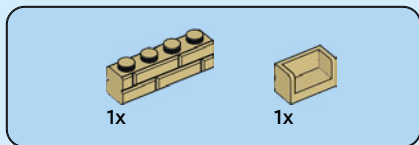

9

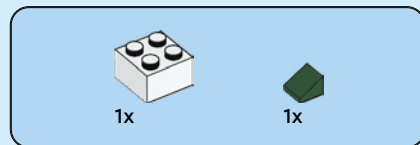
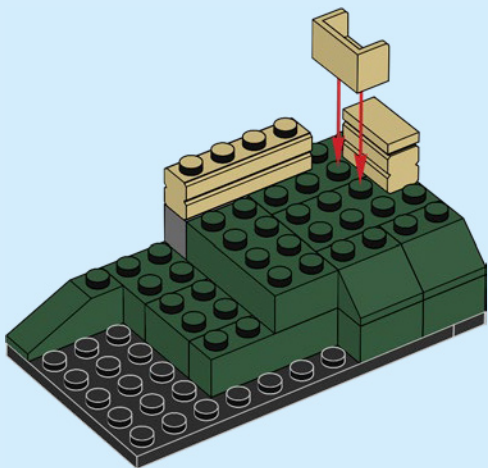

10

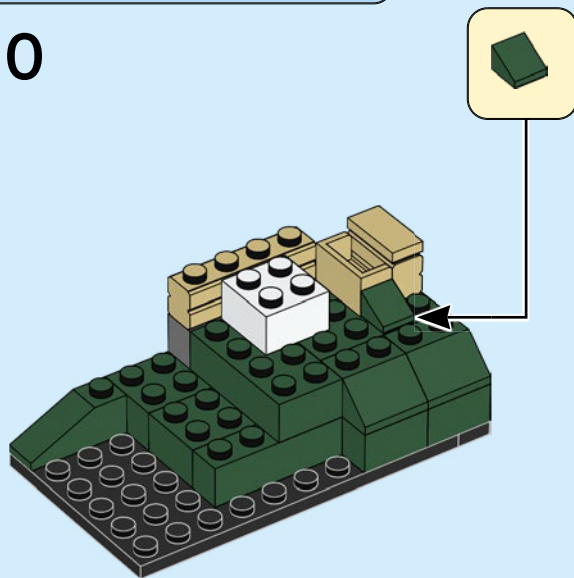

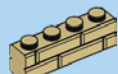

1x

11

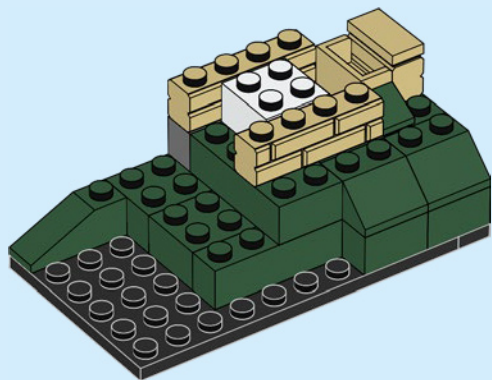

2x

12

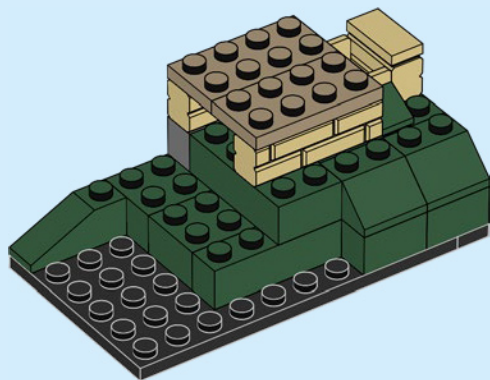



4x

13

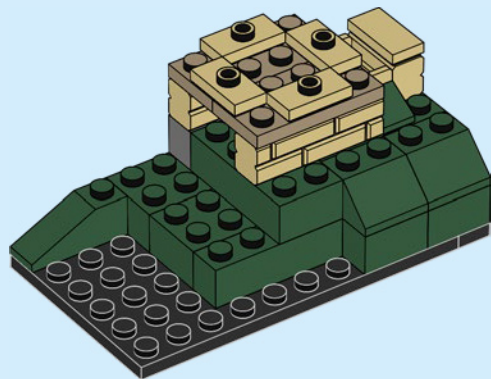

4x

14

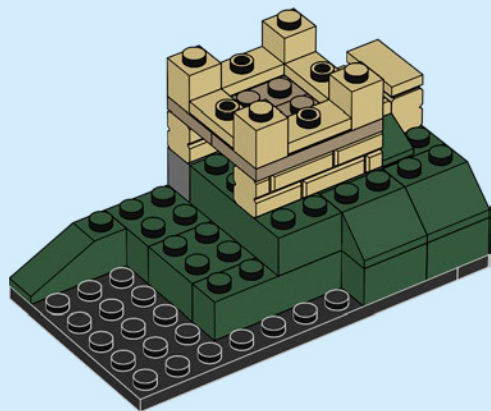



4x



4x

15

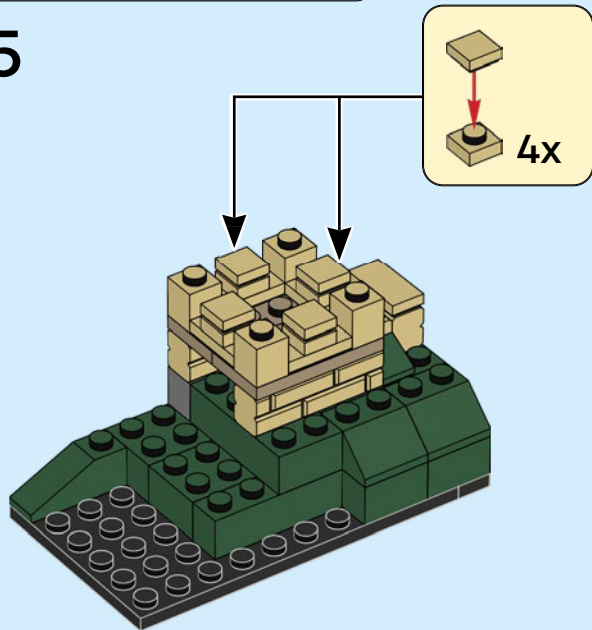

2x

16

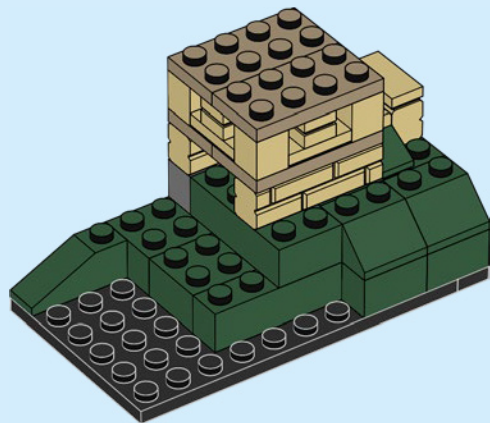



4x

17

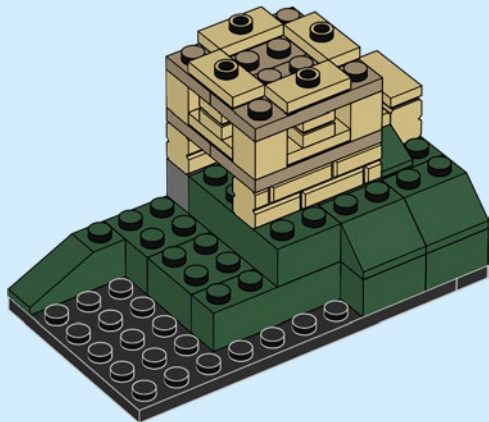

4x

18

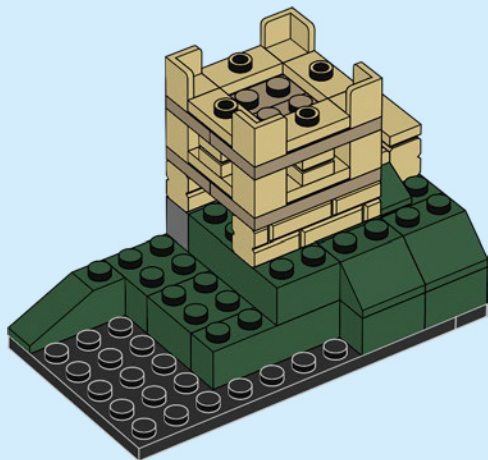



4x

4x

19

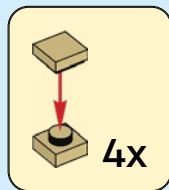

4x

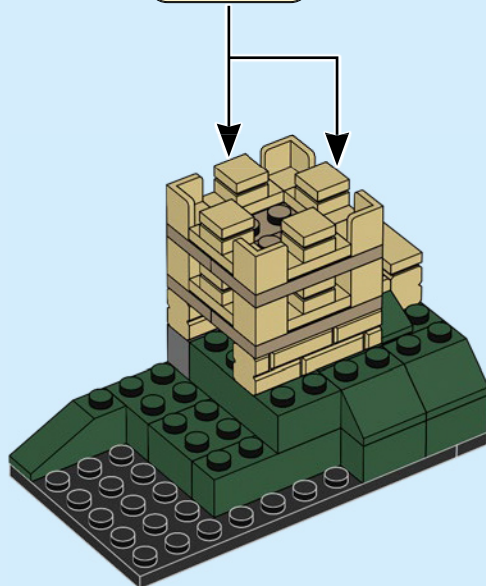

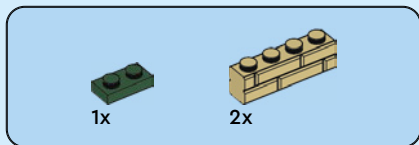

20

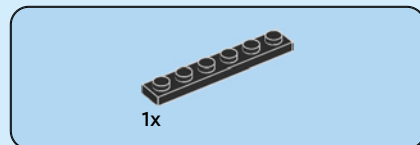
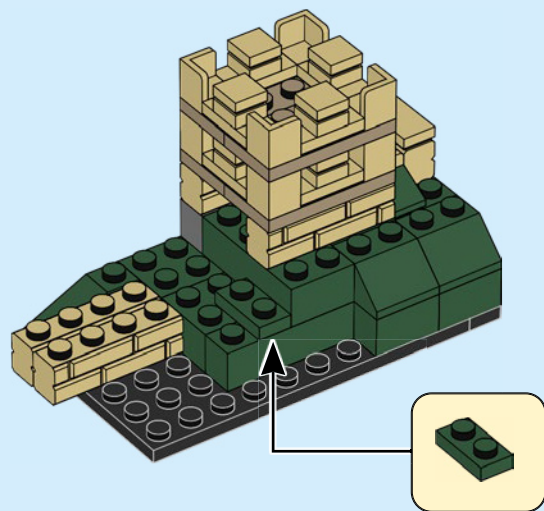

21

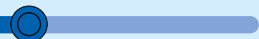
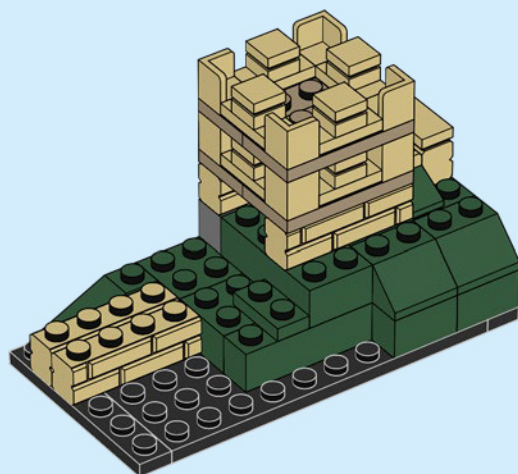

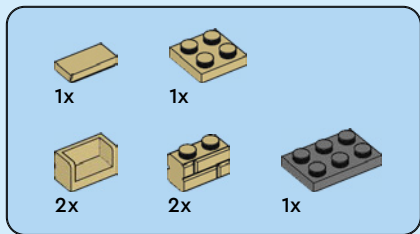

# 22

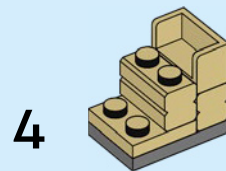
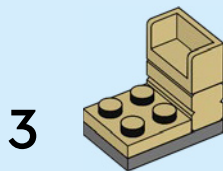
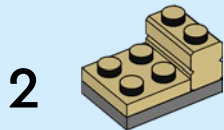
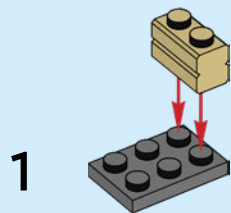



5

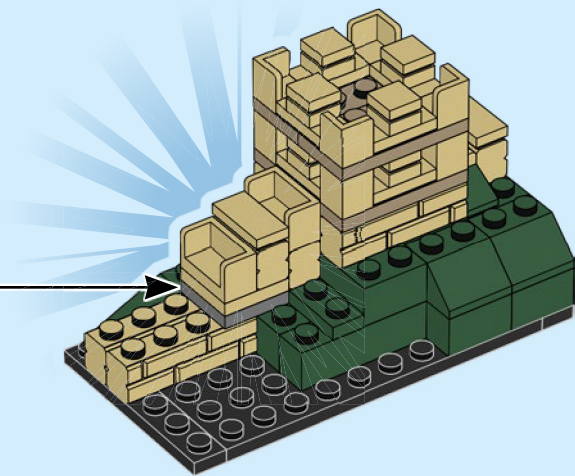
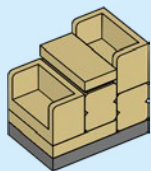

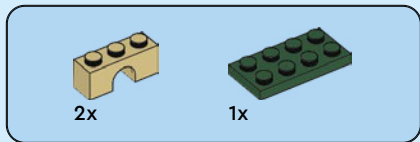

23

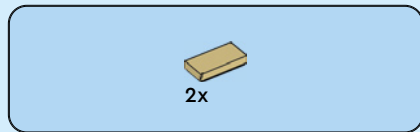
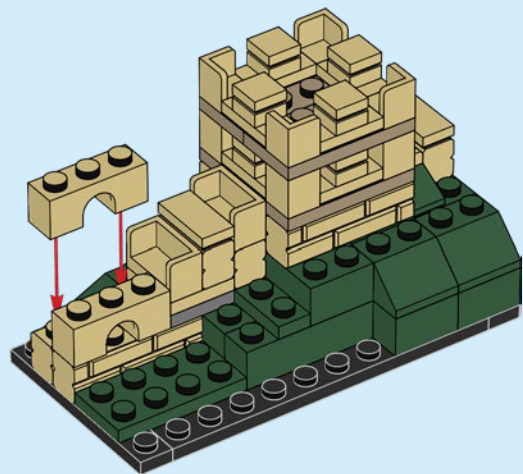

24

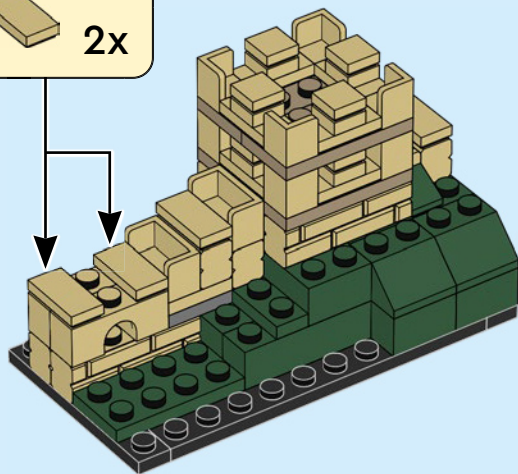

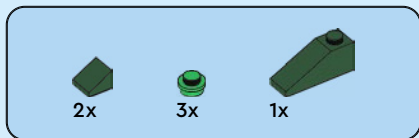

25

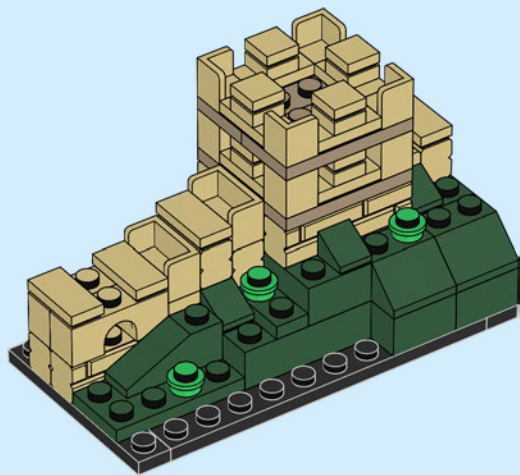

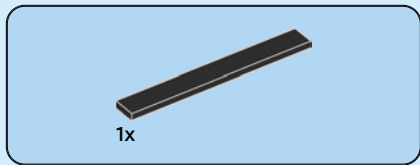

26

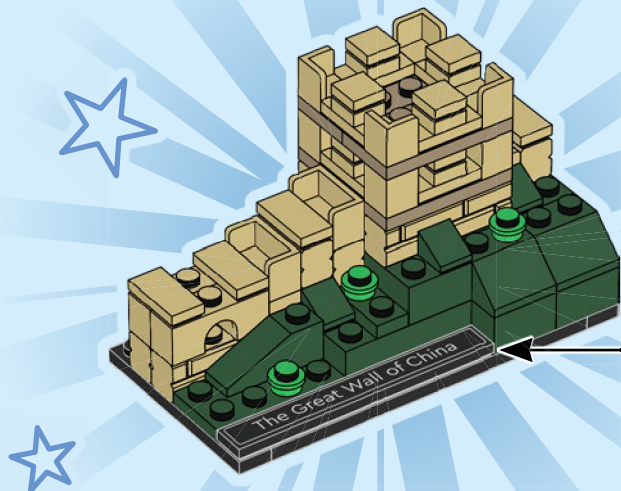
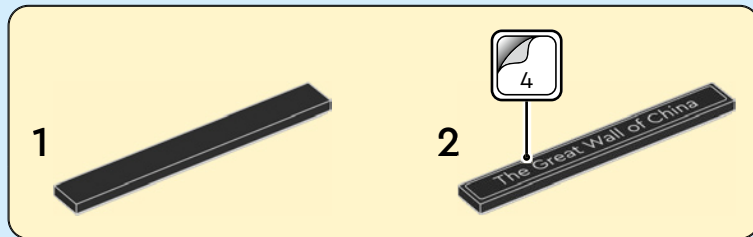

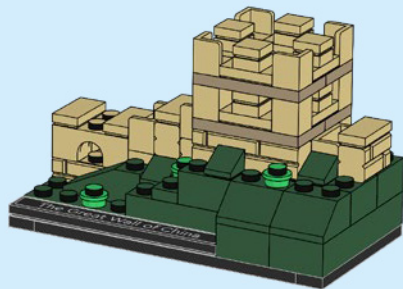
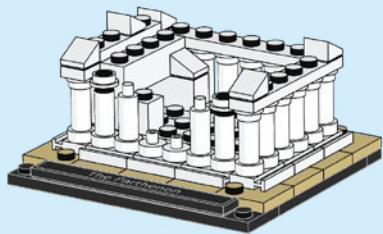
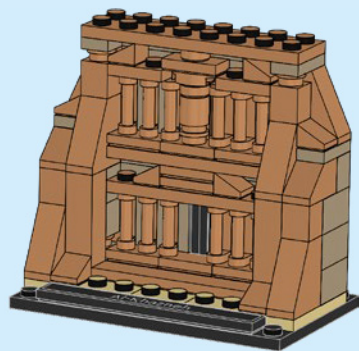
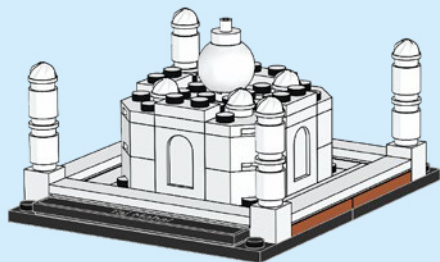

 22x 6234807	 4x 6256077	 12x 4249563	 2x 663601	 8x 4125253	 14x 6221467	 3x 4569058
 8x 306201	 1x 6221773	 2x 302201	 2x 4181142	 4x 4612603	 2x 4618651	 8x 6074892
 8x 6102794	 4x 6322480	 1x 300301	 3x 379501	 3x 6148262	 4x 6232136	 24x 4528604
 25x 6186681	 6x 302301	 1x 301001	 6x 416201	 4x 4114026	 5x 4114309	 6x 4521914
 24x 6168642	 4x 6176240	 1x 371001	 8x 4159553	 8x 6092587	 4x 300123	 2x 4255416
 6x 4504369	 2x 300401	 3x 366601	 4x 4113915	 1x 4114084	 2x 306926	 4x 4267874

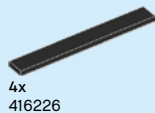

4x  
416226



2x  
6168573



1x  
4211043



2x  
6284589



6x  
6357260

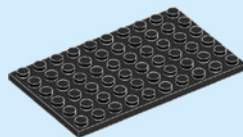

5x  
303326



1x  
447726



1x  
4245571



1x  
6300103



5x  
6167641



4x  
6021997



2x  
366626



3x  
6015424



1x  
4586057



12x  
6424277



4x  
6057986



2x  
6292154



1x  
383226



3x  
4504375



5x  
4260493



1x  
6102995



8x  
6167690



2x  
6058135



1x  
6013102

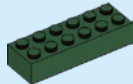

2x  
6215657



1x  
6313600



2x  
6378362



6x  
6102990



2x  
6223304



1x  
4211088



3x  
6226644



4x  
6380634



2x  
6056383



1x  
6167643



 [LEGO.com/service](https://www.LEGO.com/service)

YOU COULD **WIN**



Scan this QR code or go to **LEGO.COM/PRODUCTFEEDBACK** and give us your short feedback about this LEGO® set for a chance to win a cool LEGO prize.

Terms and Conditions apply\*



**DE: Du könntest GEWINNEN.** Es gelten die Teilnahmebedingungen\* **FR: Tu pourrais GAGNER.** Des conditions s'appliquent\* **IT: Potresti VINCERE tu.** Termini e condizioni sono applicabili\* **ES: Puedes GANAR.** Aplican términos y condiciones\* **PT: Poderá GANHAR.** Aplicam-se termos e condições\* **JA: プレゼント付き! 利用規約が適用されます\*** **ZH: 轻松获奖. 条款和条件适用\*** **KO: 상품의 주인이 되어보세요. 소정의 약관이 적용됩니다\*** **RU: Вы можете ВЫИГРАТЬ.** Действуют положения и условия\* **PL: Szansa na WYGRANĄ.** Obowiązują warunki korzystania\* **CS: Máte šanci VYHRÁT.** Platí všeobecné smluvní podmínky\* **SK: Máte šancu VYHRAŤ.** Platia všeobecné zmluvné podmienky\* **HU: TE IS NYERHETSZ.** Felhasználási feltételek érvényesek\* **RO: Ai putea CÂȘTIGA.** Se aplică termenii și condițiile\* **BG: Можете да СПЕЧЕЛИТЕ.** Има определени правила и условия\* **LV: Tu vari LAIMĒT.** Ir spēkā noteikumi un nosacījumi.\* **ET: Sul on võimalus VÕITA.** Kehtivad tingimused\* **LT: Jūs galite LAIMĖTI.** Taikomos sąlygos\*  
\*LEGO.com/productfeedback-terms

LEGO and the LEGO logo are trademarks of the/son des marques de commerce du/son marcas registradas de LEGO Group. ©2023 The LEGO Group.

6452040