



40585



Booklet available in English on  
Heft in deutscher Sprache erhältlich auf  
Livret disponible en français sur  
Libretto disponibile in italiano su  
Folleto disponible en español en  
如需中文版手册, 请访问  
[LEGO.com/service/buildinginstructions](http://LEGO.com/service/buildinginstructions)



[LEGO.com/sustainable-packaging](https://LEGO.com/sustainable-packaging)

# BUILD YOUR OWN WORLD OF WONDERS



## TAJ MAHAL

The first stop on your tour of the Wonders of the World is the Taj Mahal – a breath-taking monument to everlasting love. In 1631, the emperor Shah Jahan commissioned the stunning marble mausoleum in Agra, India, in memory of his wife, the Empress Mumtaz Mahal. An ethereal vision of perfection that took 17 years to complete, it remains a majestic symbol of divine perfection, balance and harmony.

## THE GREAT WALL OF CHINA

This astounding architectural marvel stretches more than 20,000 km (13,100 miles), or the equivalent of halfway around the Equator, through the Northern part of China. The Great Wall consists of a series of separate walls, fortresses, passes and beacon towers. Constructed between 700 BC and the 17<sup>th</sup> century AD, its historical and cultural significance throughout the millennia is unparalleled.



## THE PARTHENON

The Parthenon, part of The Acropolis of Athens, Greece, was erected in the 5<sup>th</sup> century BC. Ground-breaking architects and sculptors transformed the rocky Athenian hilltop into a lasting tribute to beloved ancient gods. The Acropolis is now mostly known as the birthplace of classical Greek culture and art, as well as philosophy, democracy and the intellectual foundation for our modern-day values.

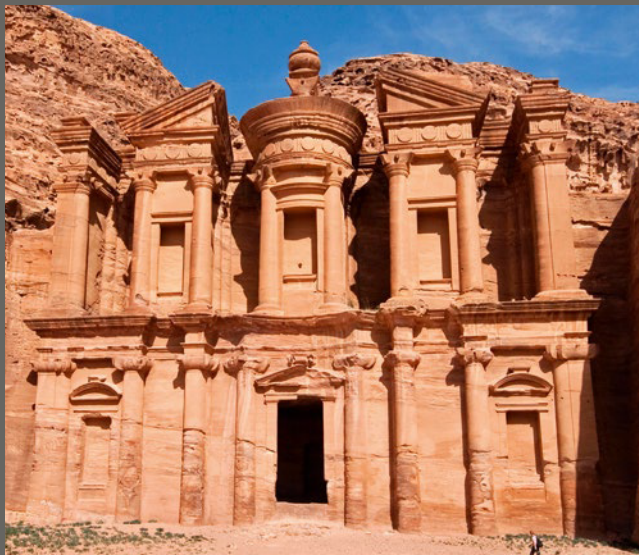

## AL KHAZNEH

Your final stop is Al-Khazneh (The Treasury) in the ancient city of Petra, Jordan. Half-built, half-carved into a red sandstone gorge during the 4<sup>th</sup> century BC, the structure included a sophisticated watering and sewage system. Once part of the capital of the Nabataean Kingdom, and a thriving, pivotal trade centre for Indian, Chinese and Arabic goods, it is now one of the largest archaeological sites in the world.



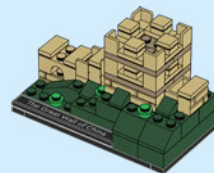
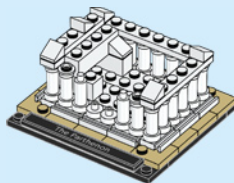
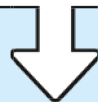
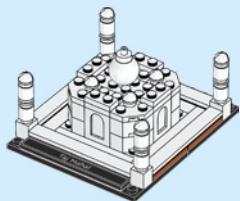
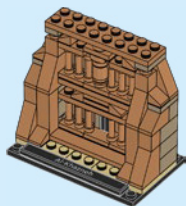

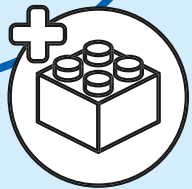
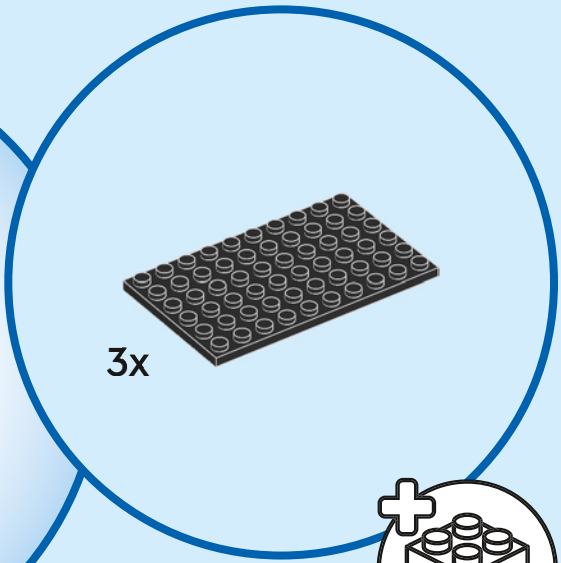

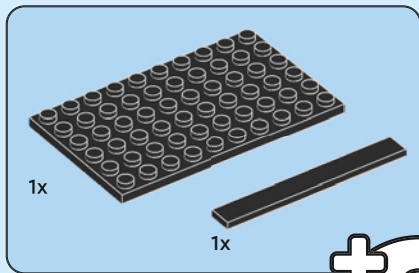
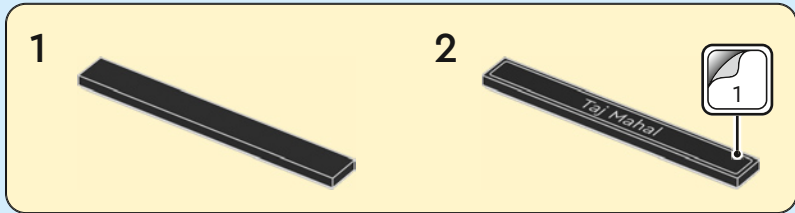
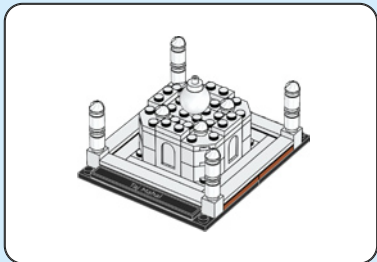

1

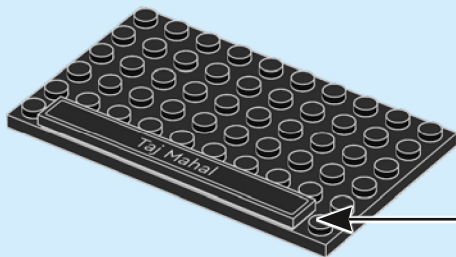
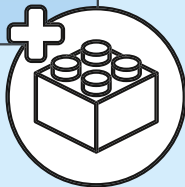



2x



2x

2

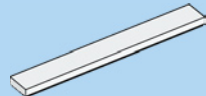
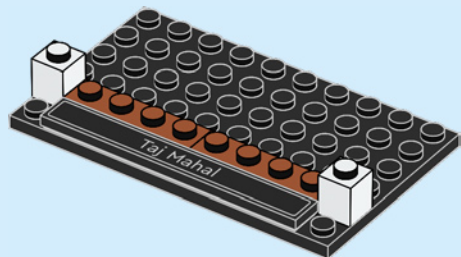

1x

3

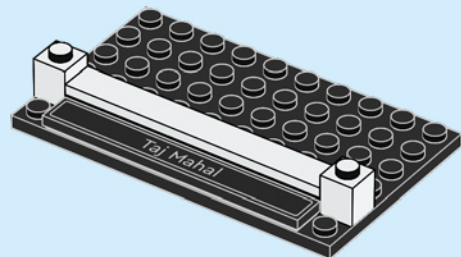



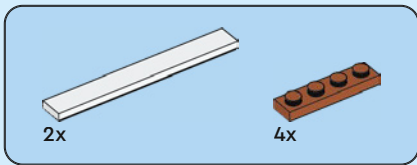

4

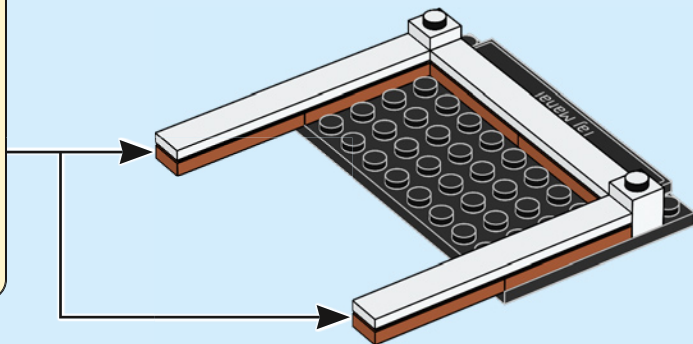
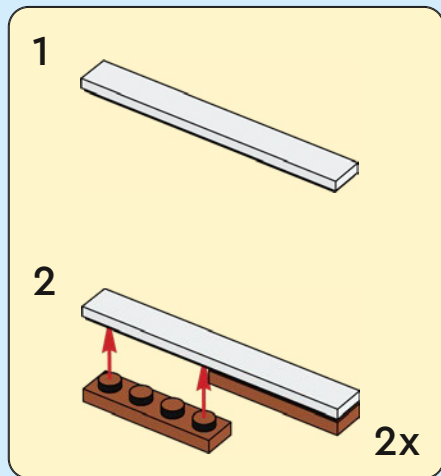

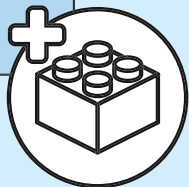
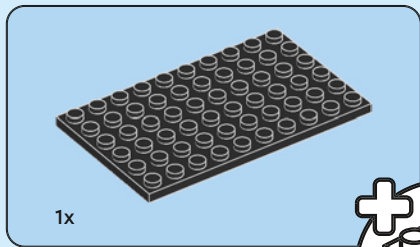

5

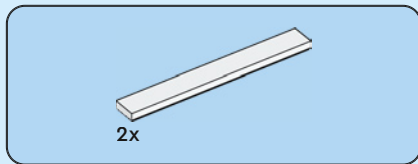
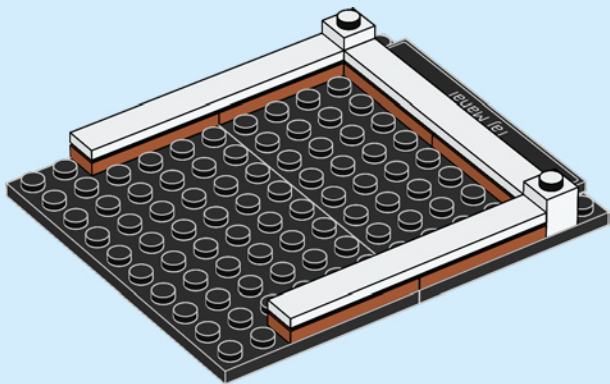

6

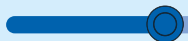
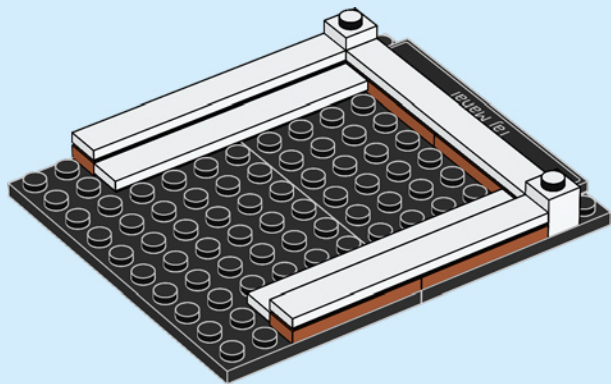

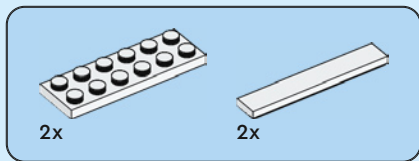

7

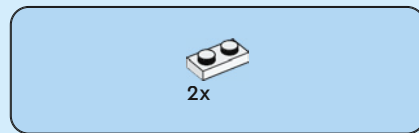
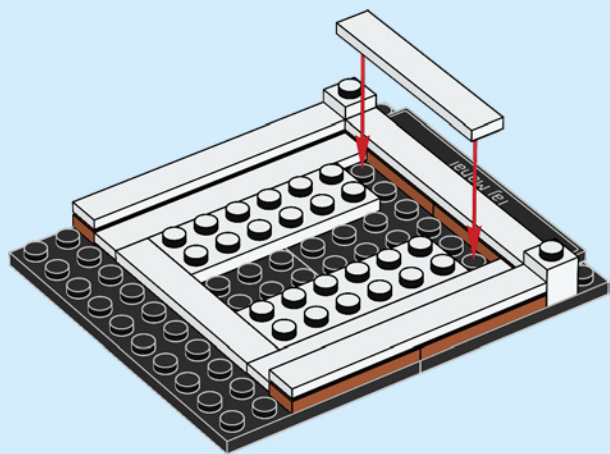

8

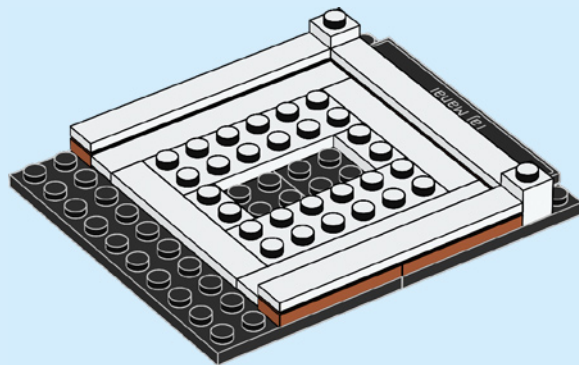

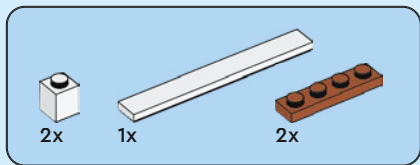

9

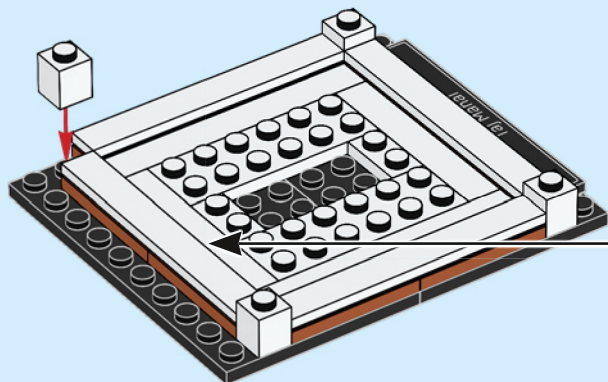
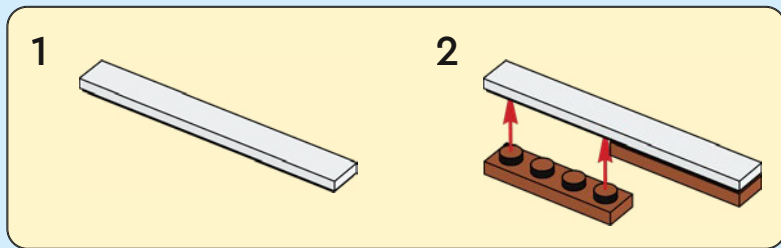



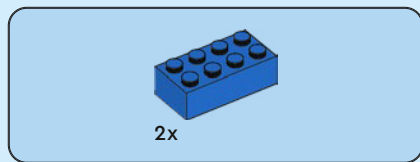

10

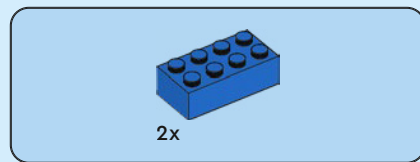
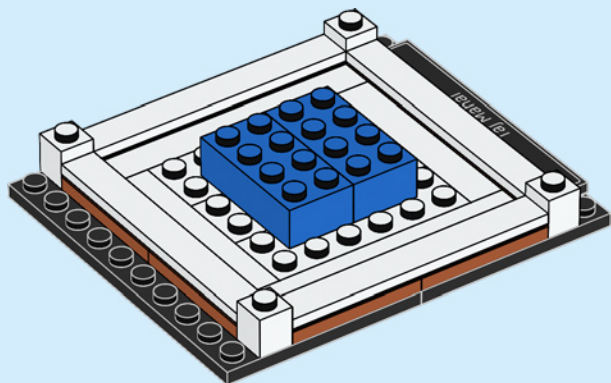

11

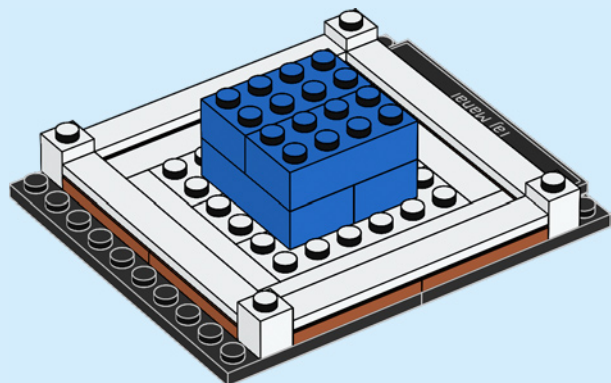



8x

12

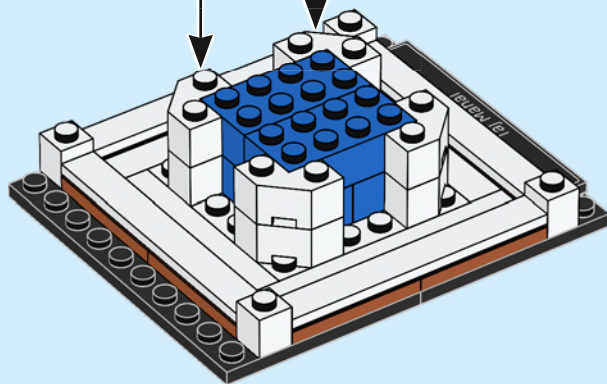
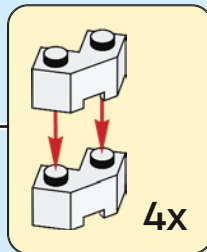



4x



4x

13

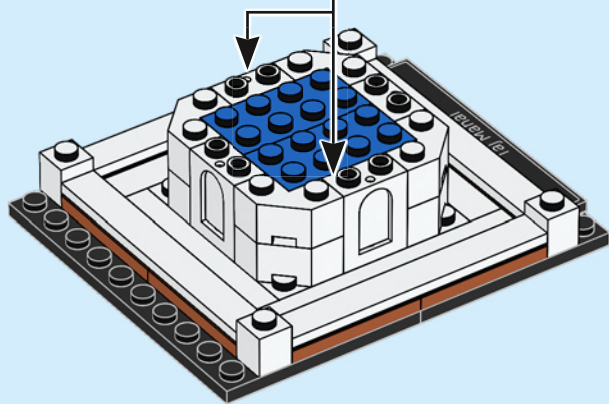
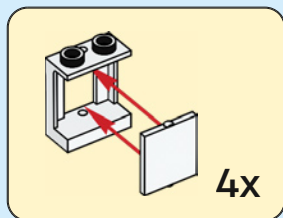

4x

14

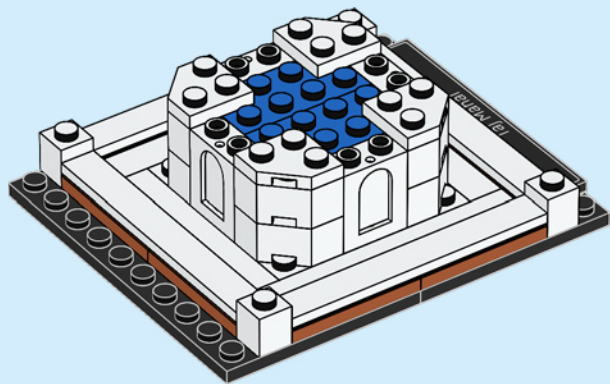

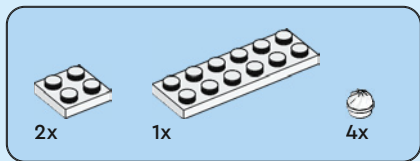

15

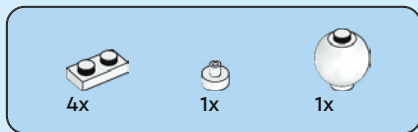
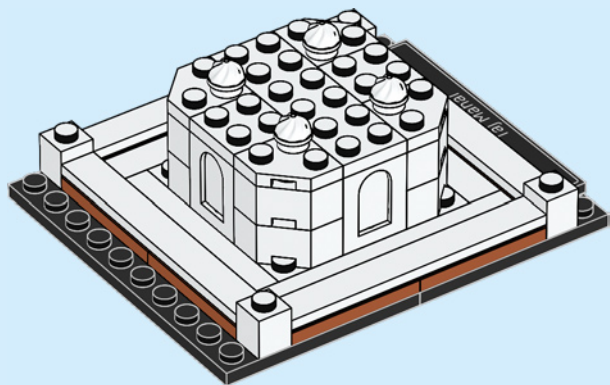

16

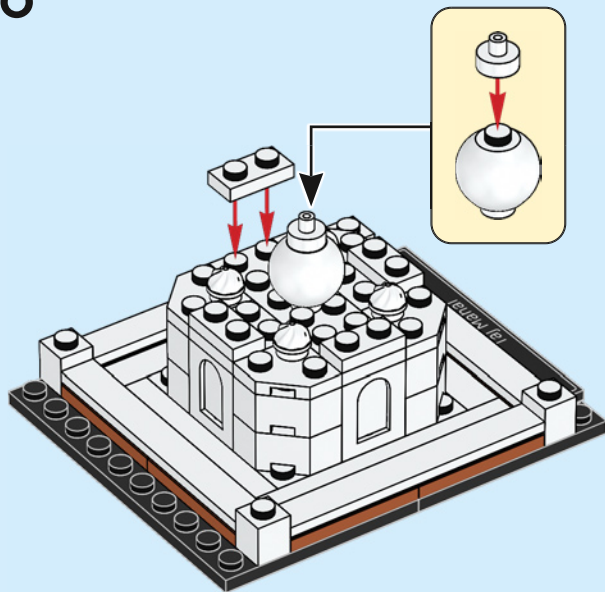





8x



4x



4x

# 17

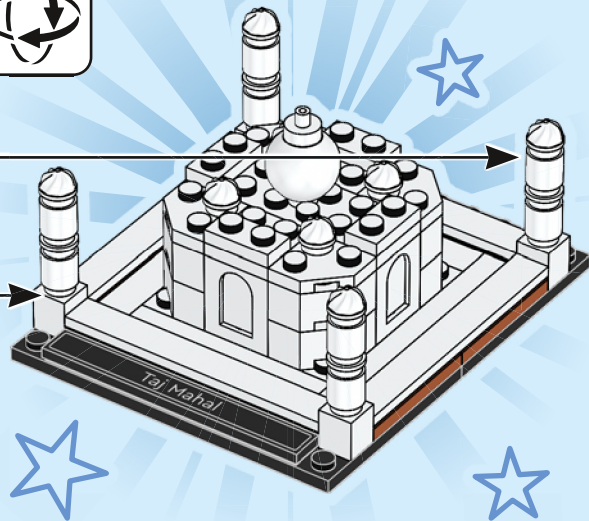
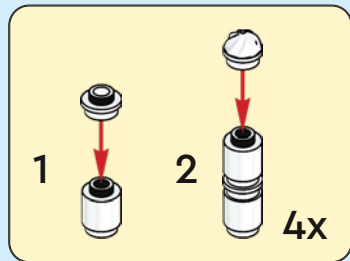

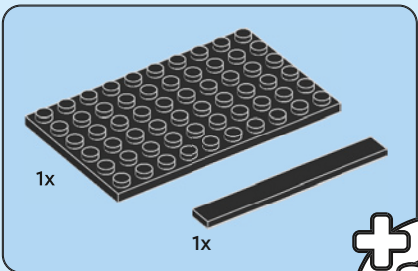
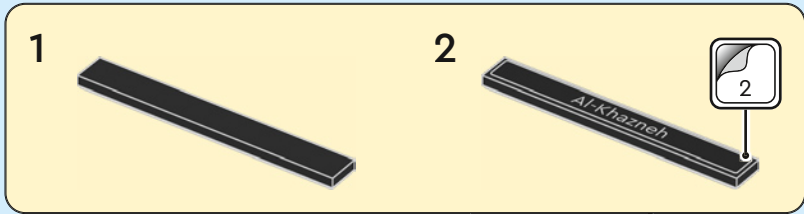

1

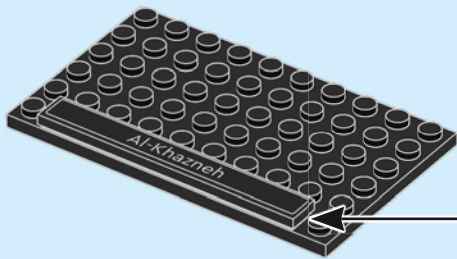
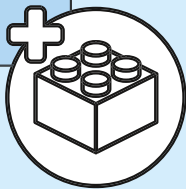

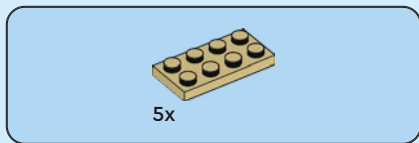

2

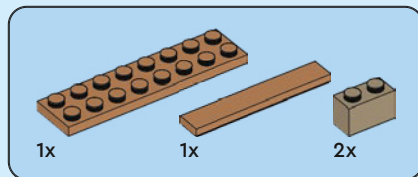
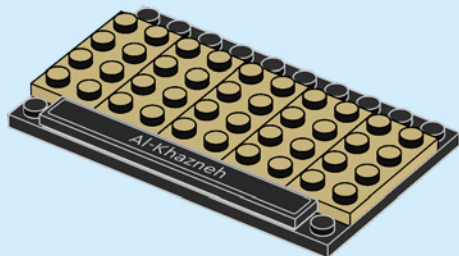

3

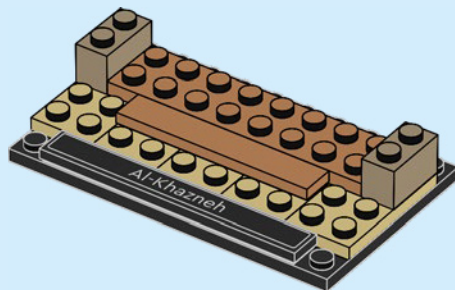



2x



3x

4

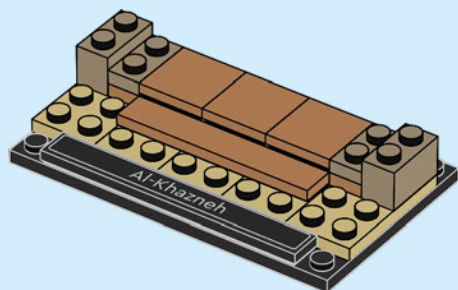





1x



3x



1x



3x

5

1

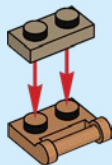

2

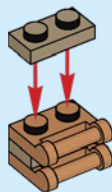

3

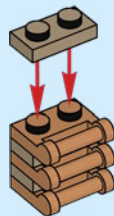

4





5

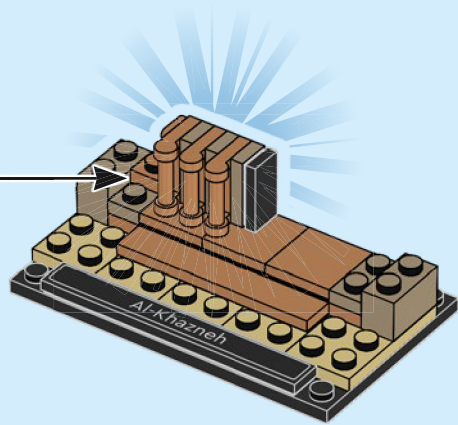
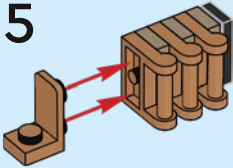

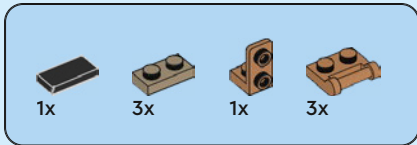

6

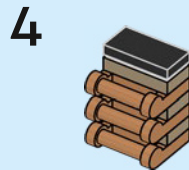
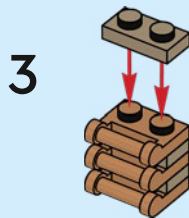
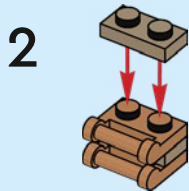
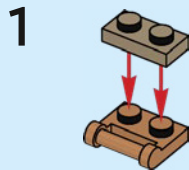

5

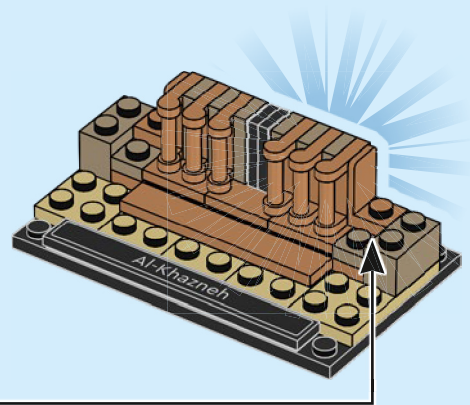
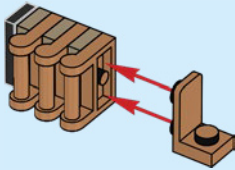



2x

7

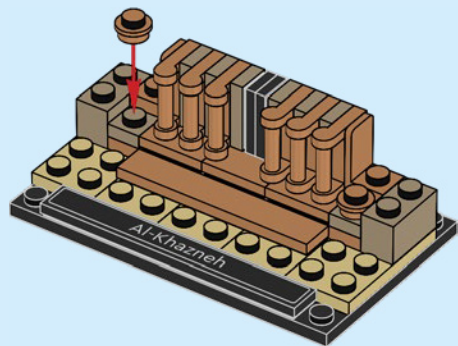

2x

8

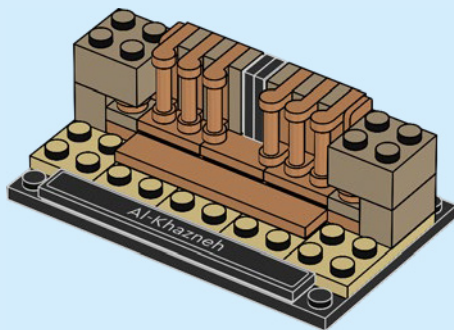



2x

9

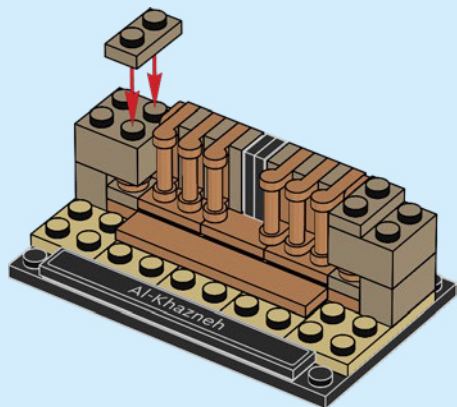

2x

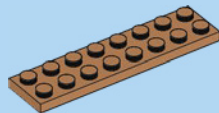

1x

10

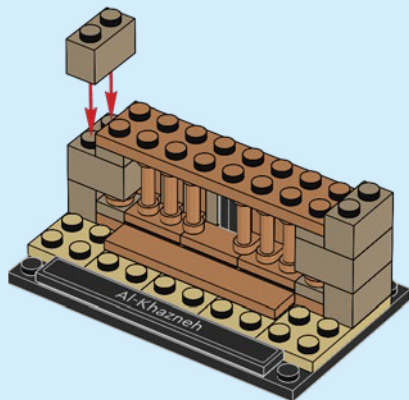

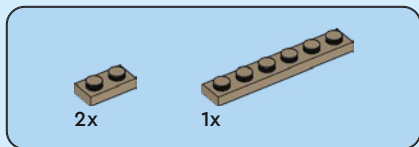

11

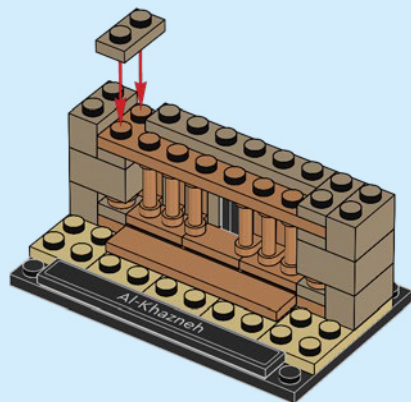





2x



2x

# 12

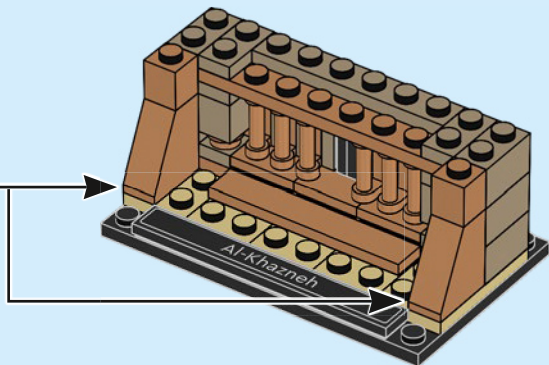
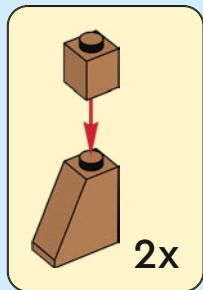

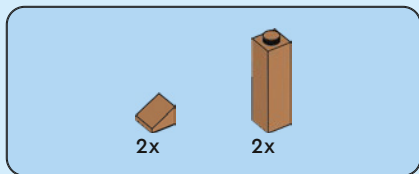

13

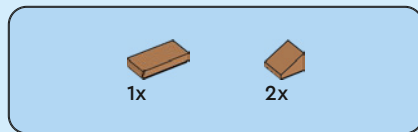
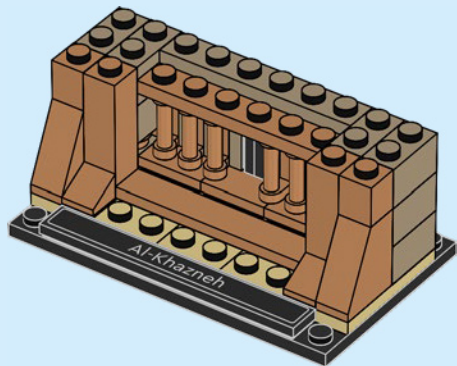

14

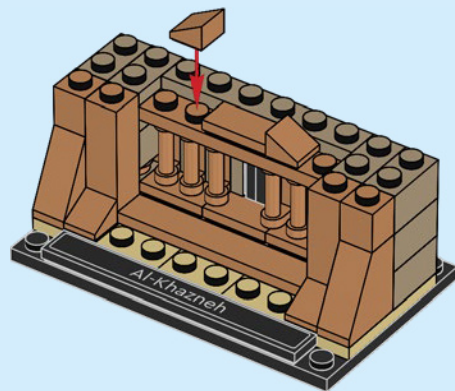



2x



1x

# 15

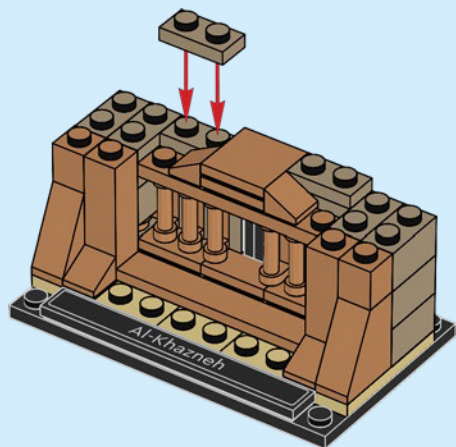

2x



2x

# 16

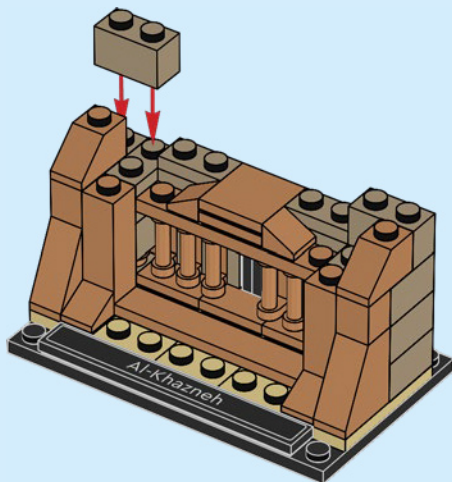

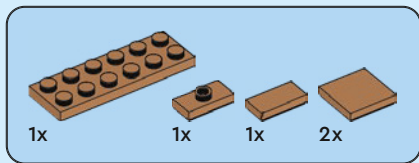

17

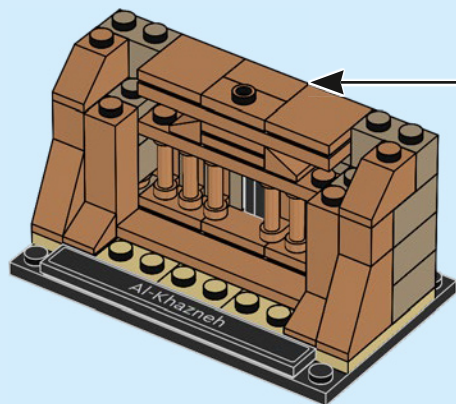
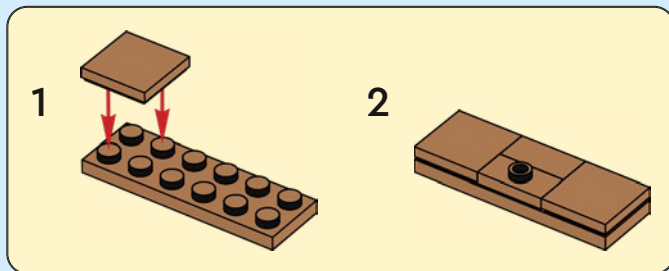



2x

18

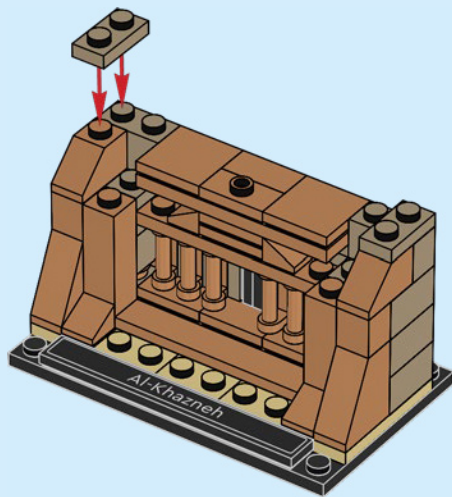

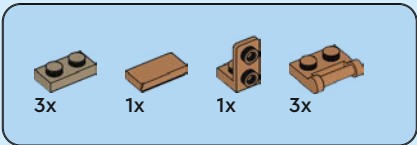

19

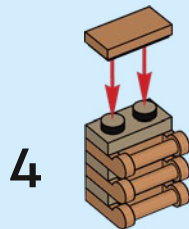
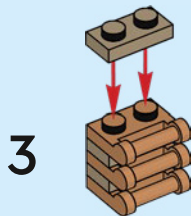
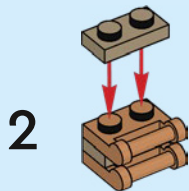
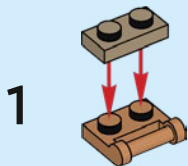



5

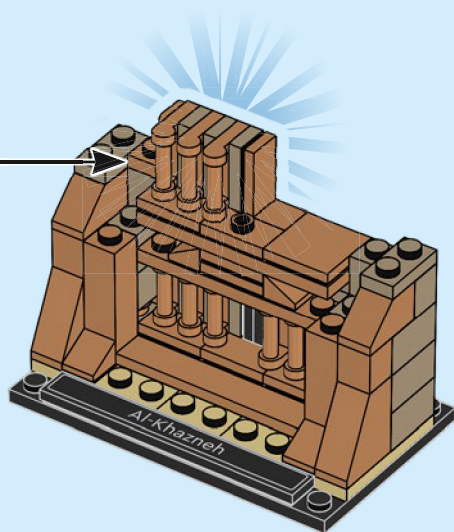
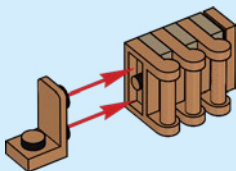



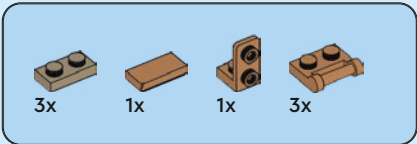

# 20

1

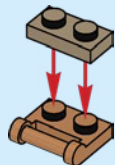

2

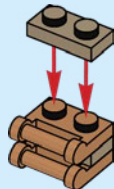

3

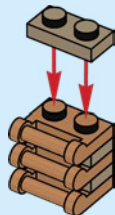

4

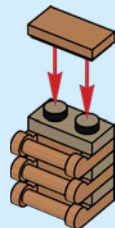



5

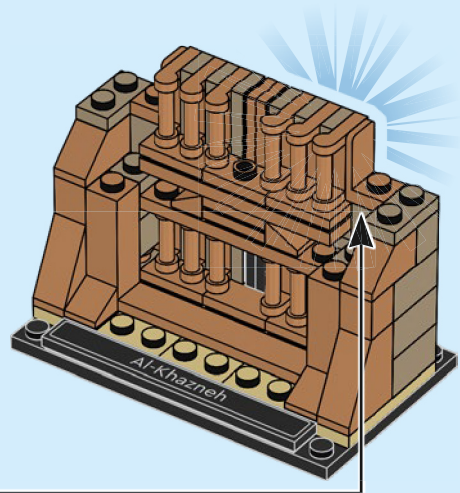
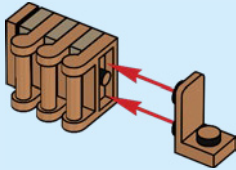



1x



1x



1x

# 21

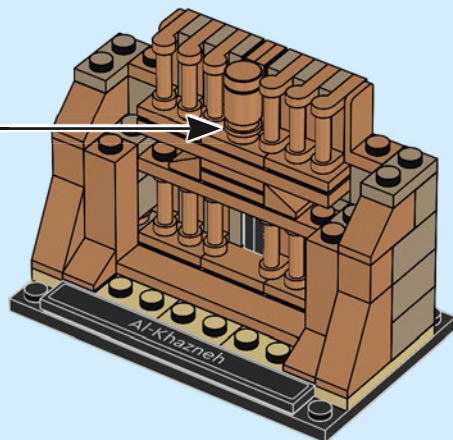
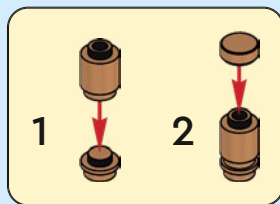

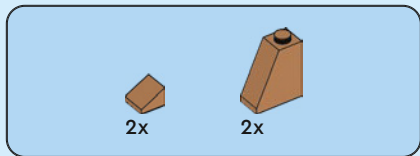

22

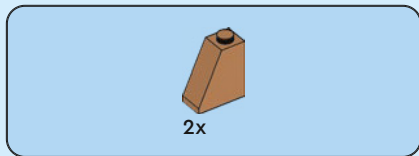
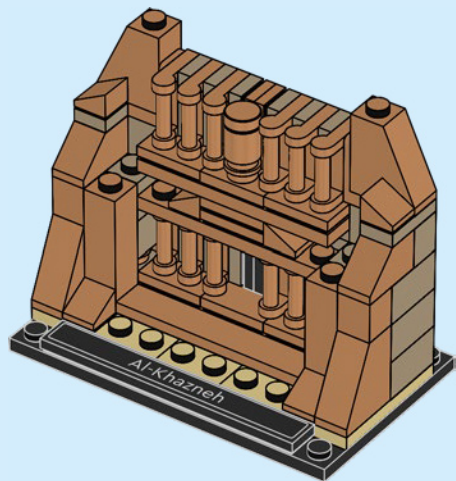

23

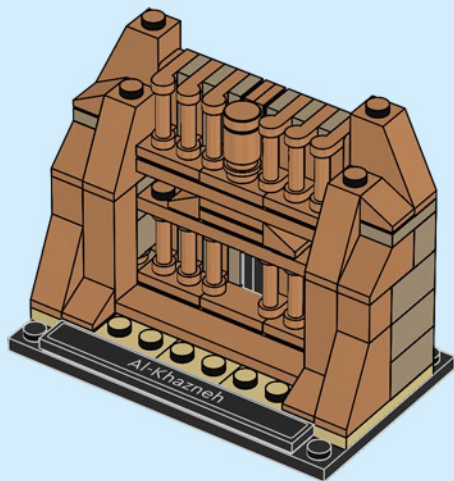



2x



2x

# 24

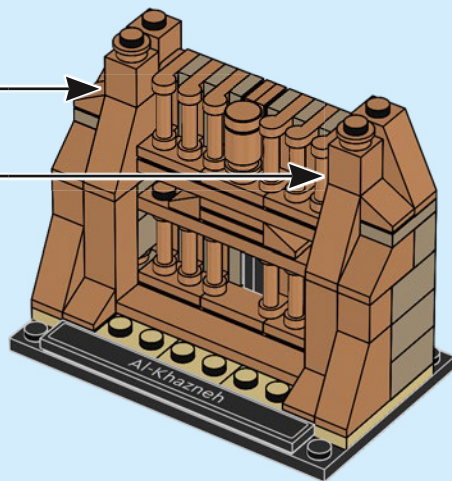
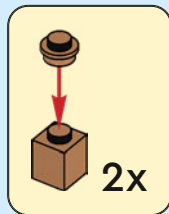

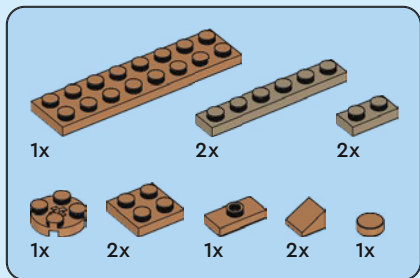

25

1

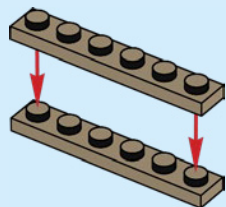

2

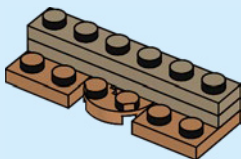

3

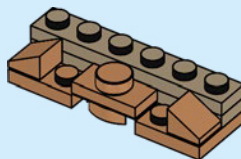

4

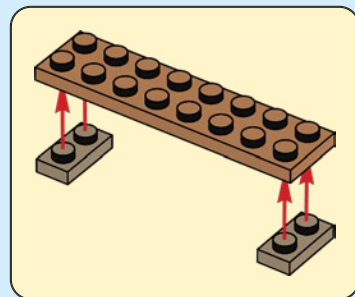
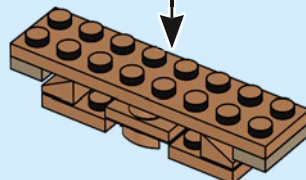

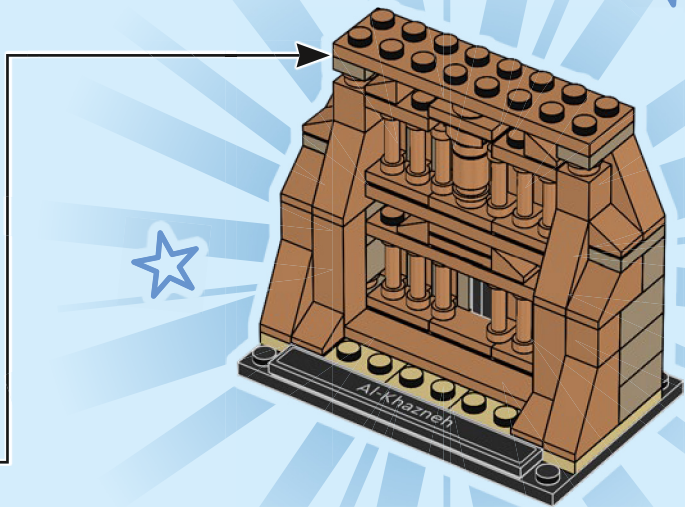



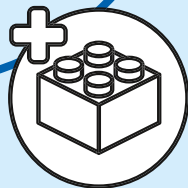
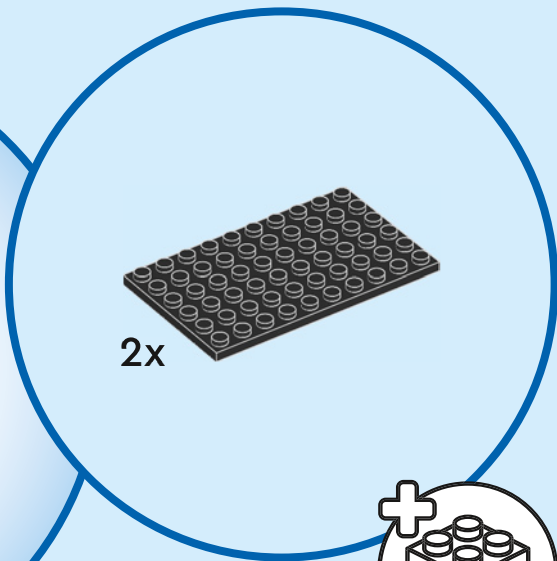
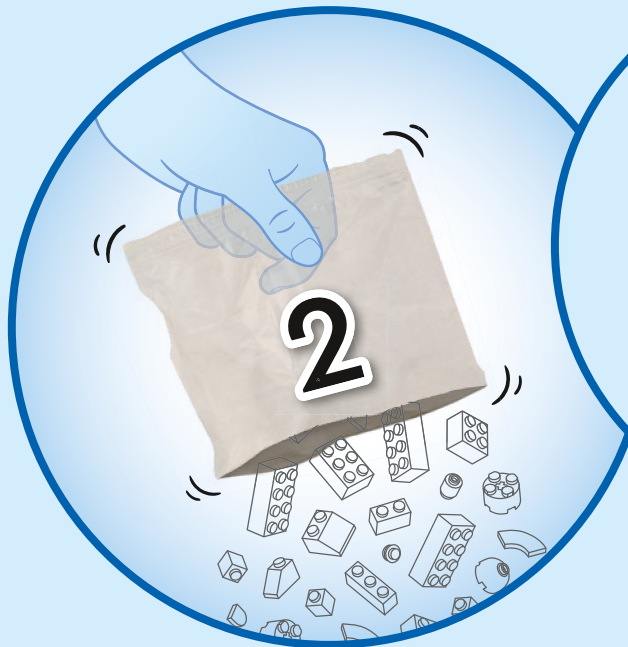

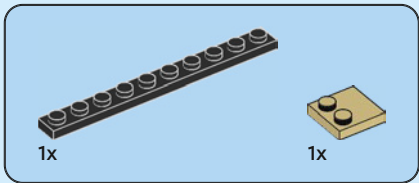
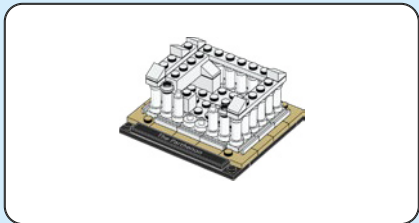

1

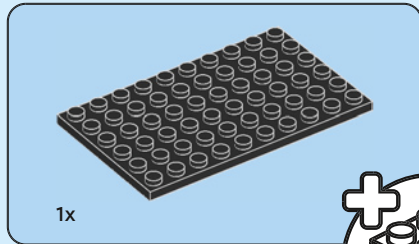
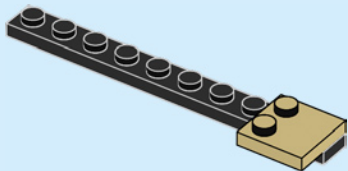

2

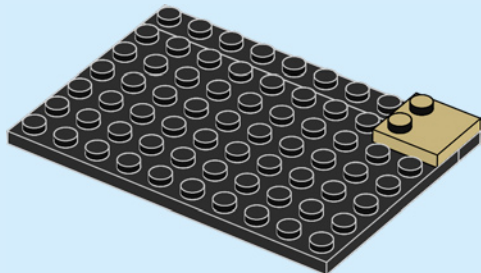
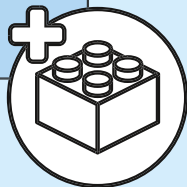



4x

3

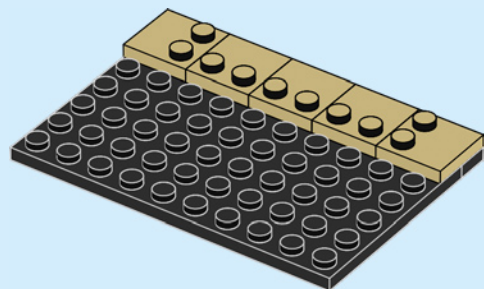

6x

4

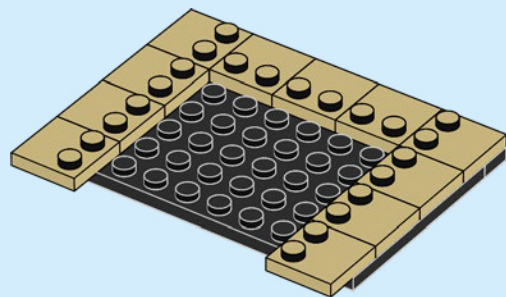

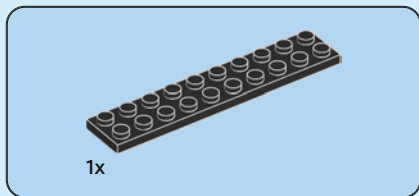

5

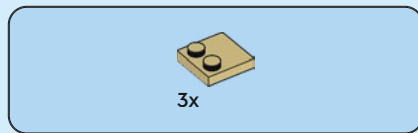
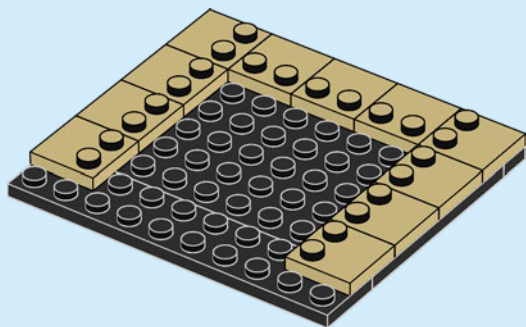

6

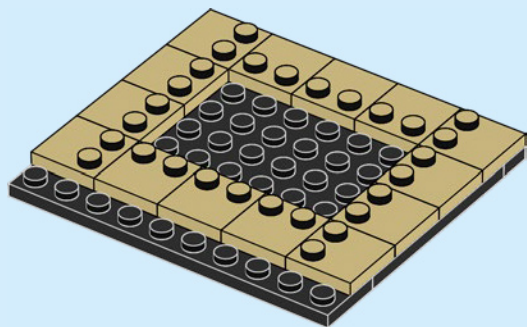

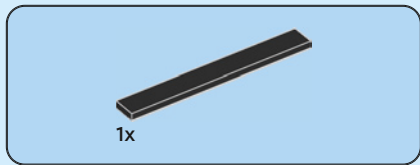

7

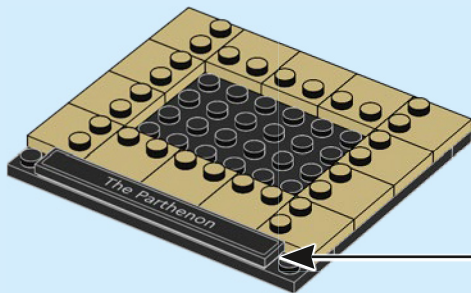
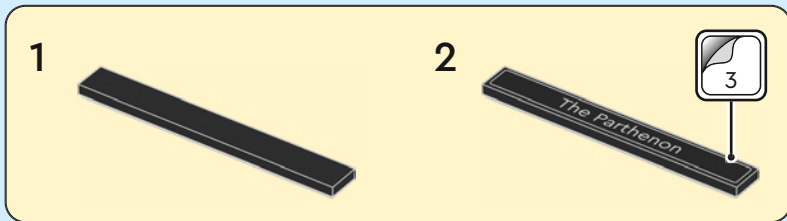



12x

8

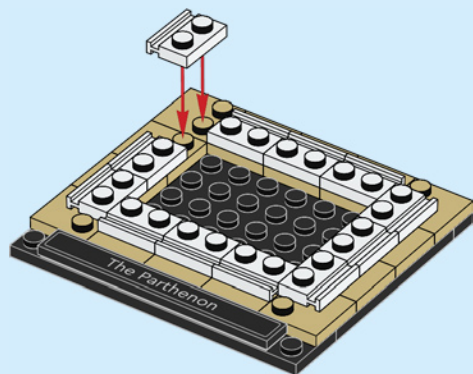

2x

9

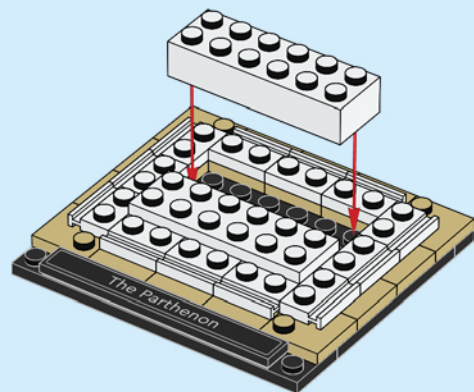



18x



18x

10

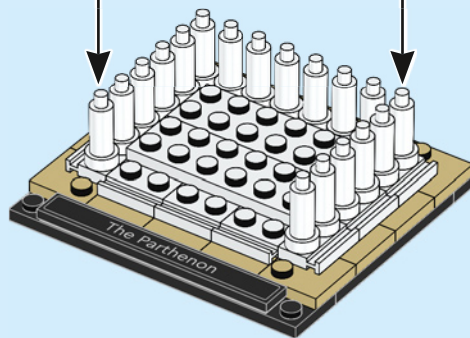
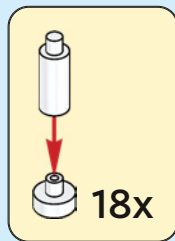



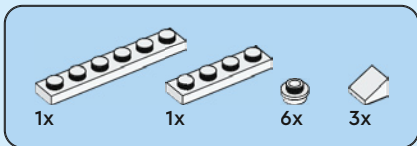

# 11



1

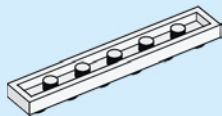

2

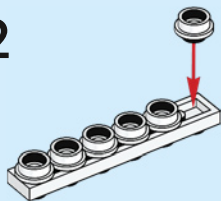

3

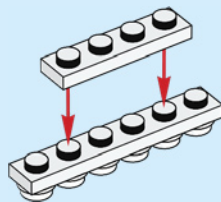

4

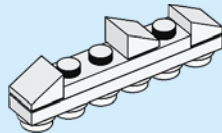

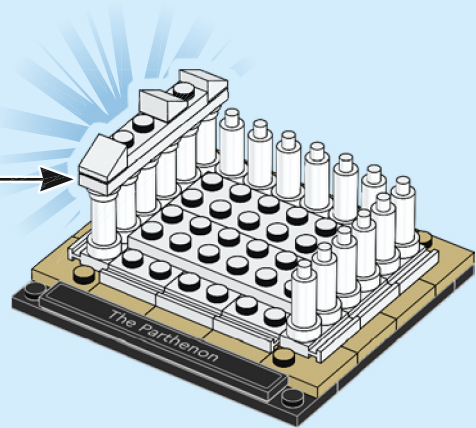

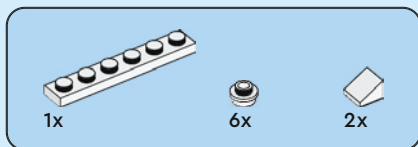

12

1

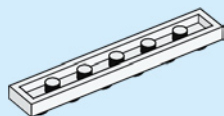

2

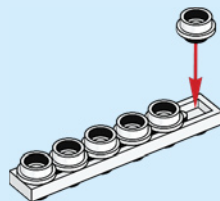

3

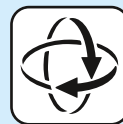
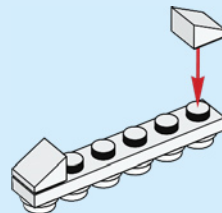

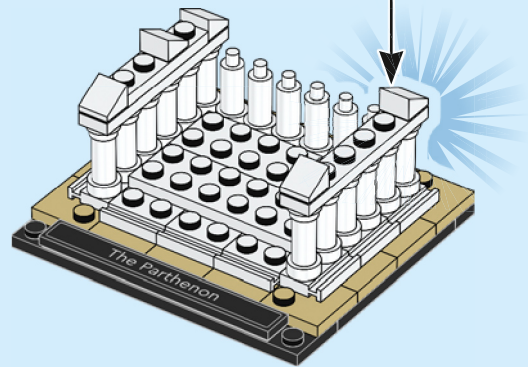

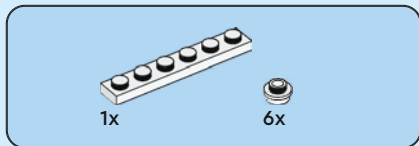

13

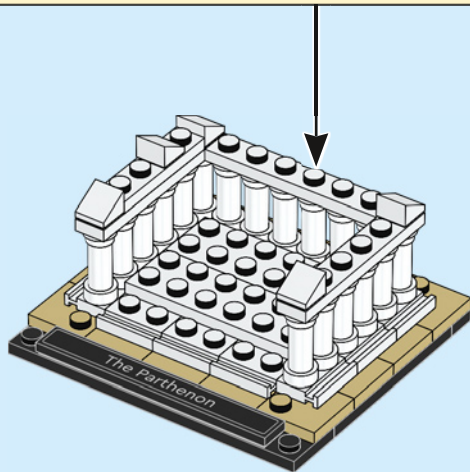
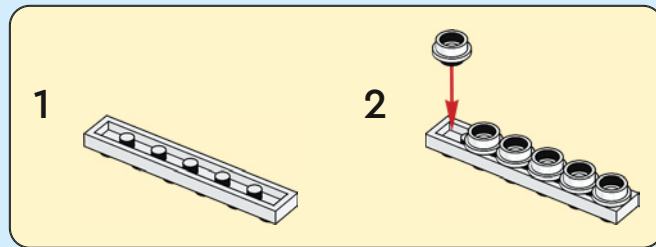



2x

14

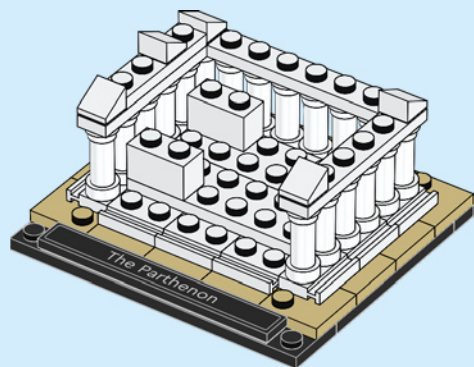

1x



1x

15

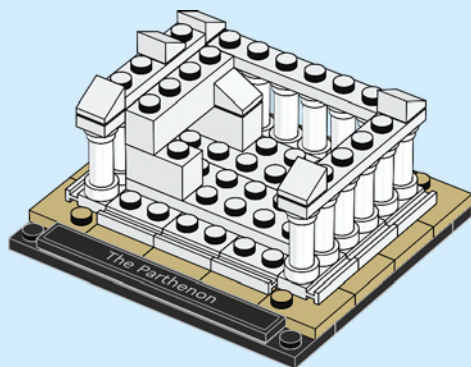



2x



2x



2x

# 16

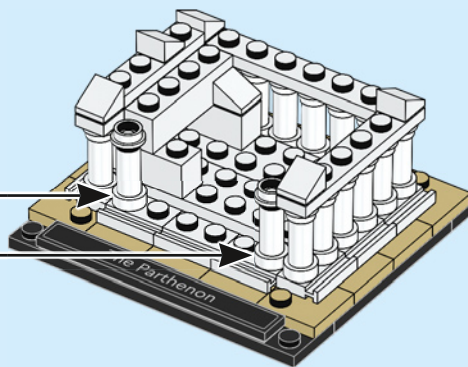
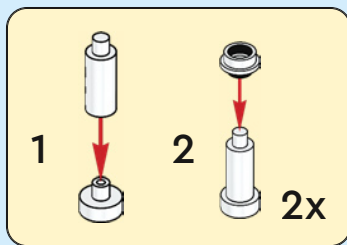



4x



2x

17

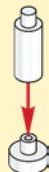
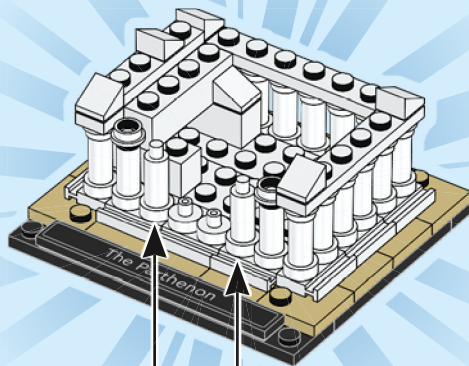

2x



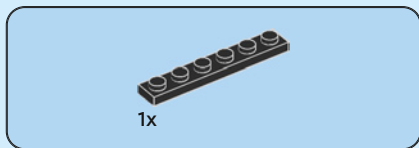
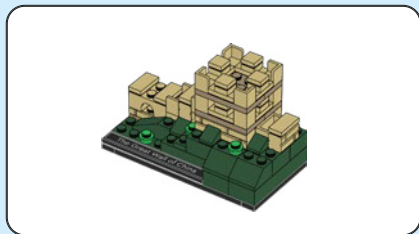

1

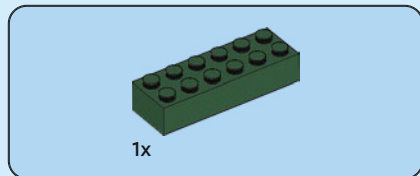
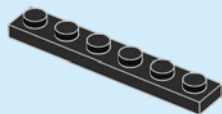

2

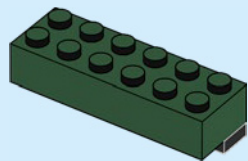

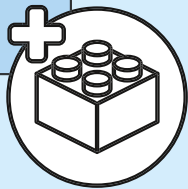
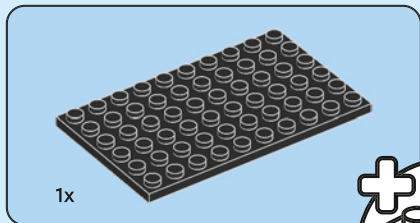

3

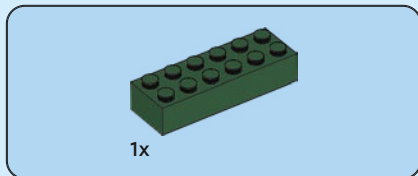
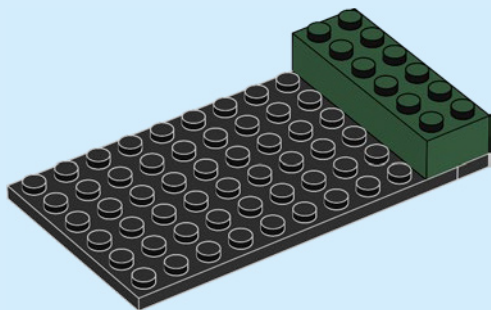

4

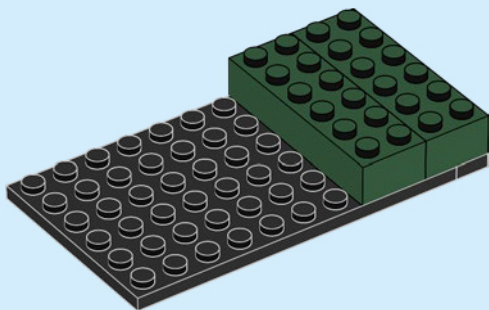

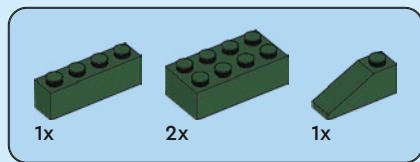

5

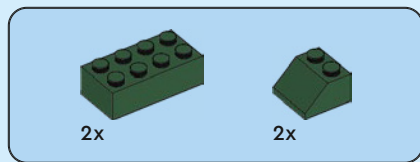
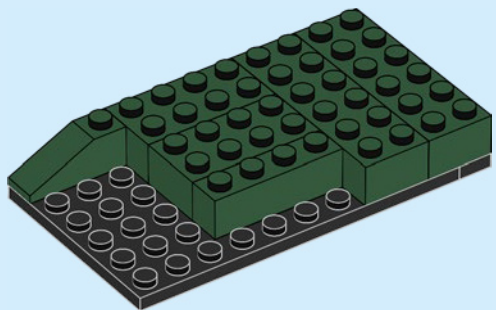

6

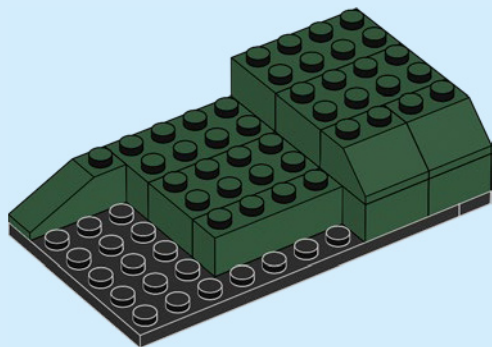

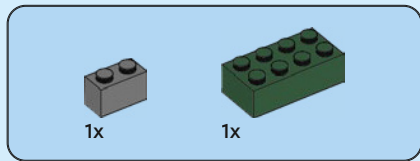

7

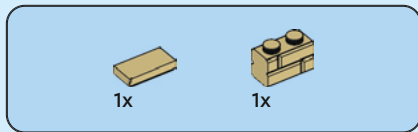
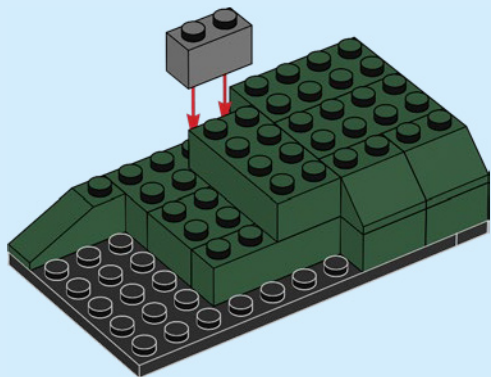

8

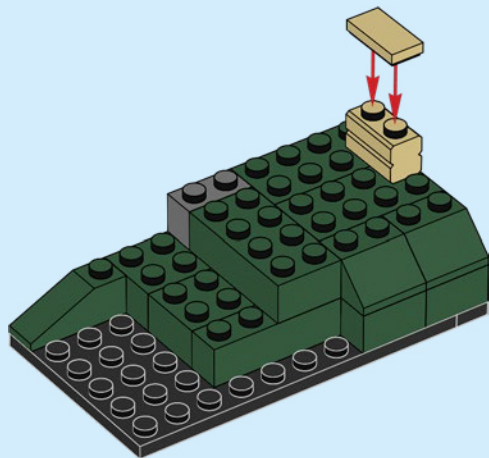

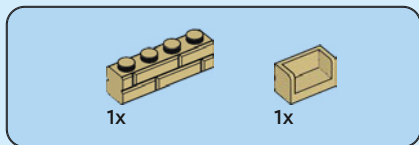

9

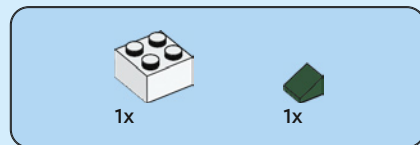
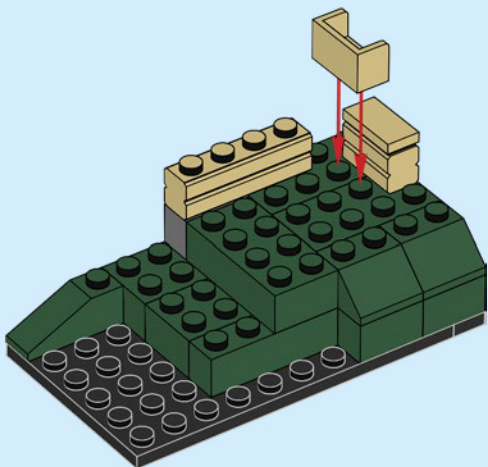

10

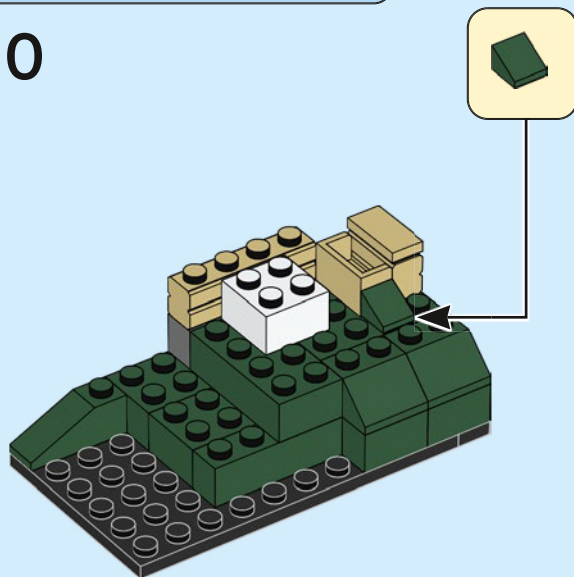

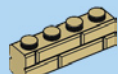

1x

11

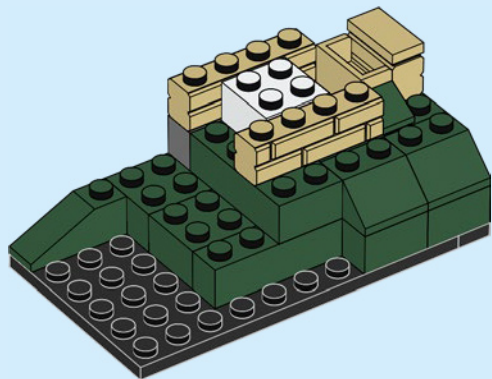

2x

12

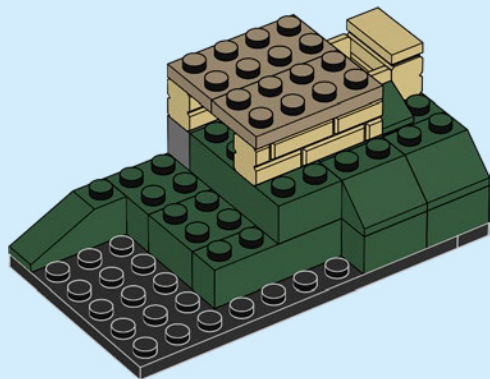



4x

13

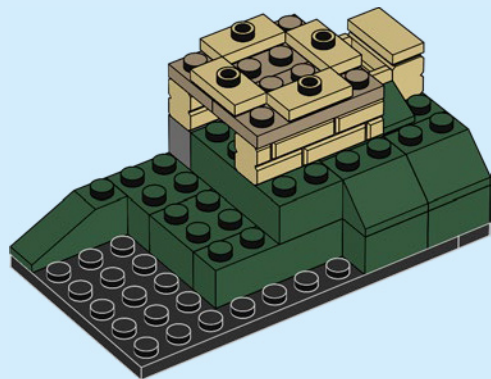

4x

14

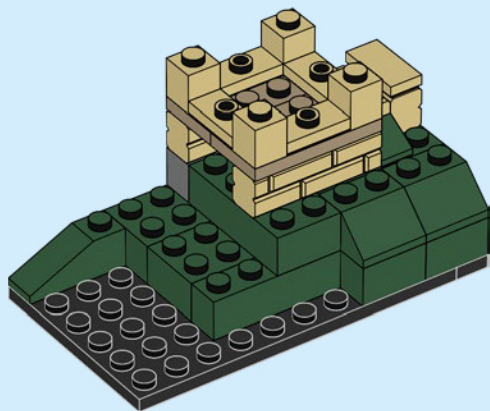



4x



4x

15

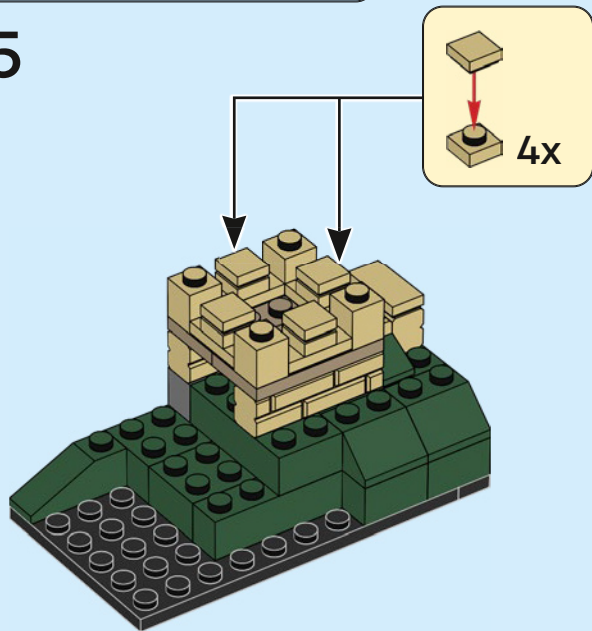

2x

16

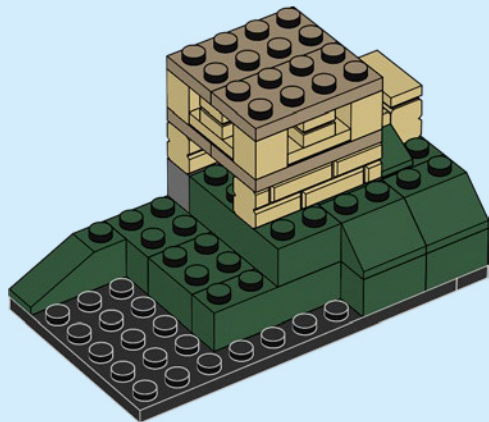





4x

17

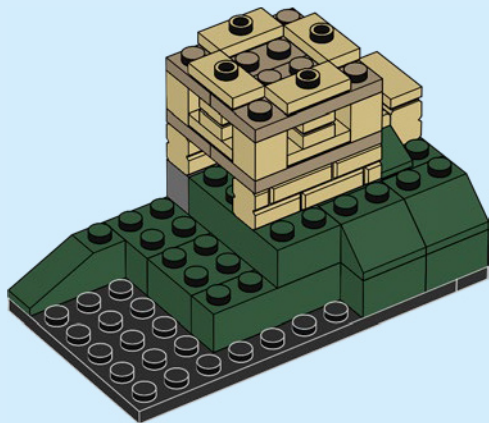

4x

18

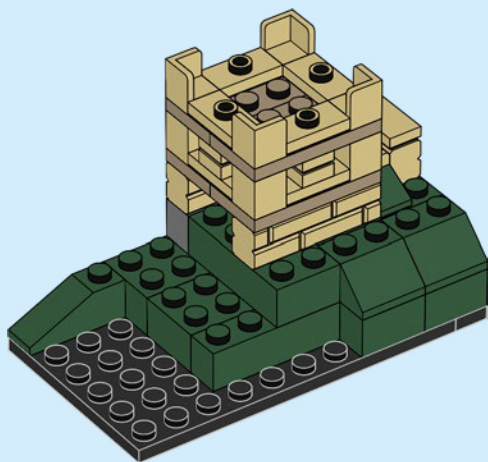



19

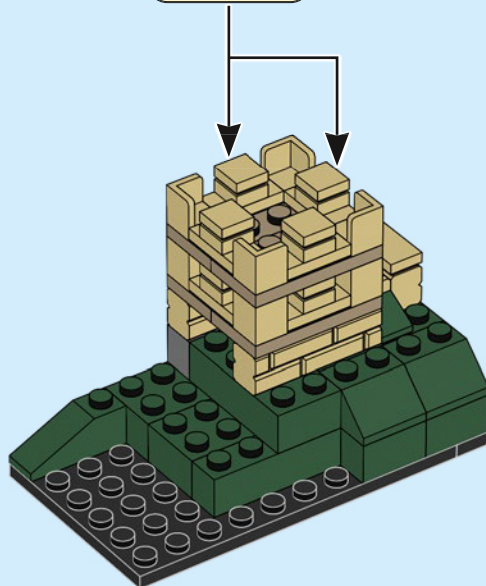
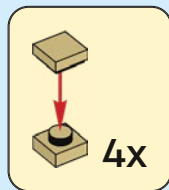

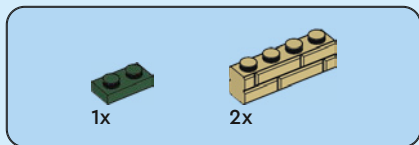

20

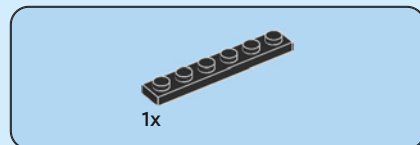
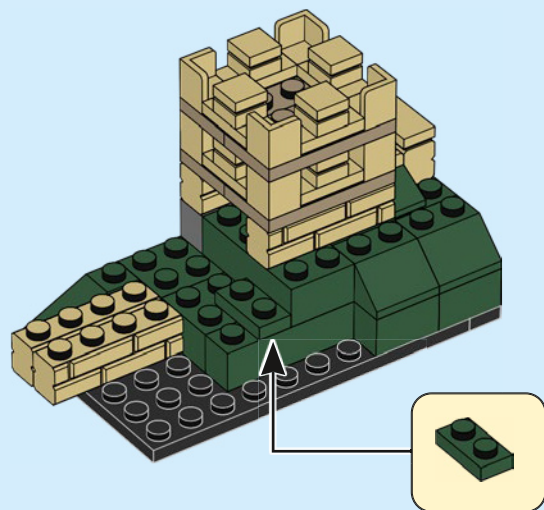

21

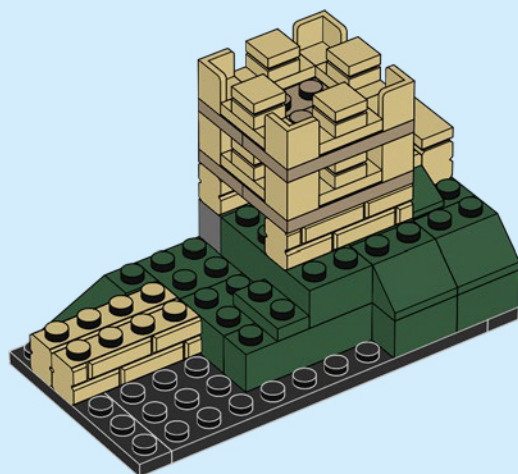

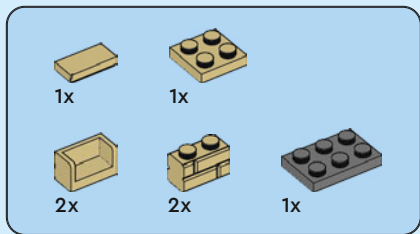

# 22

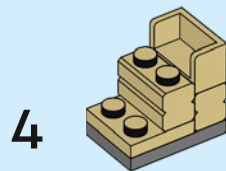
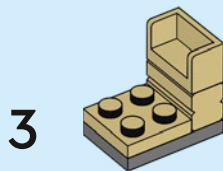
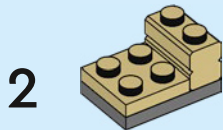
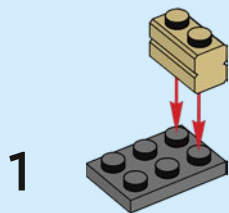

5

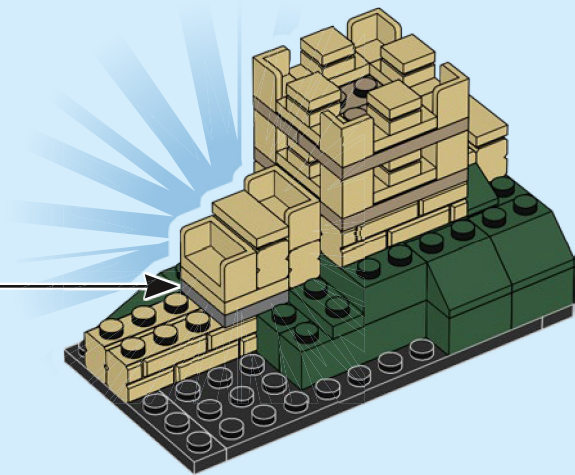
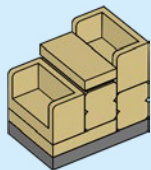

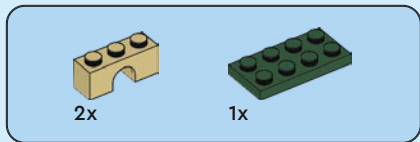

23

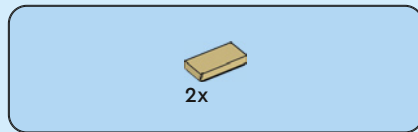
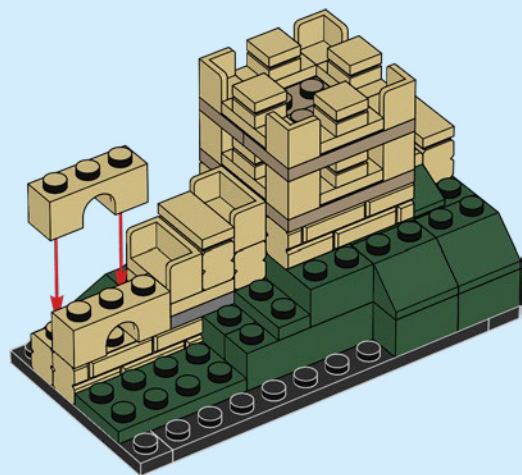

24

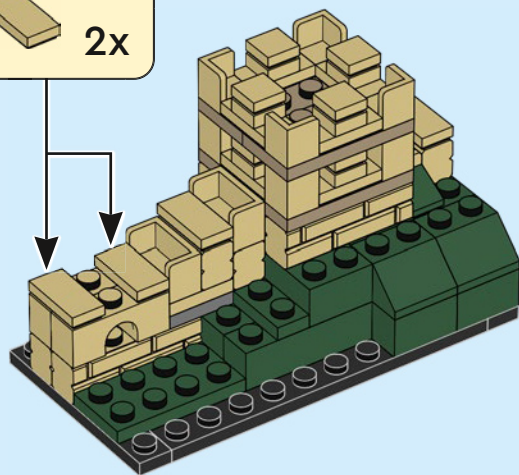

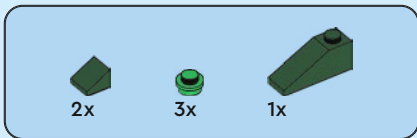

25

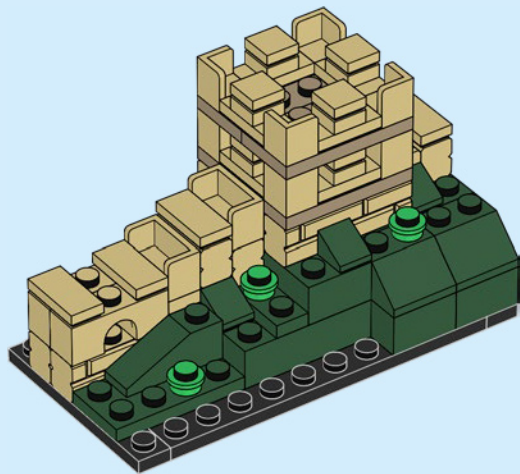

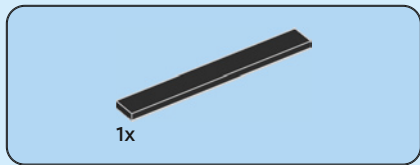

26

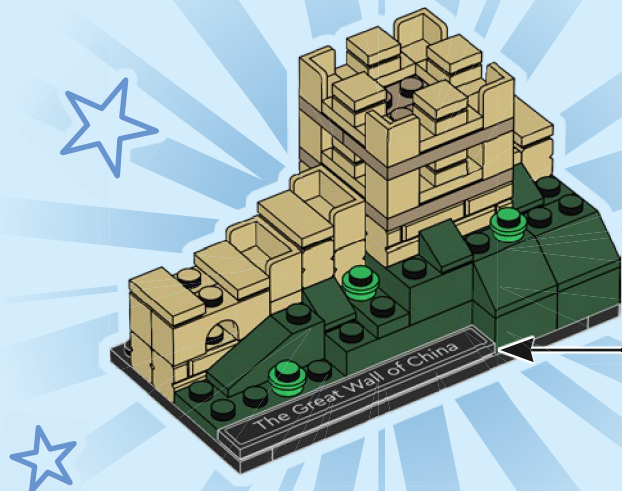
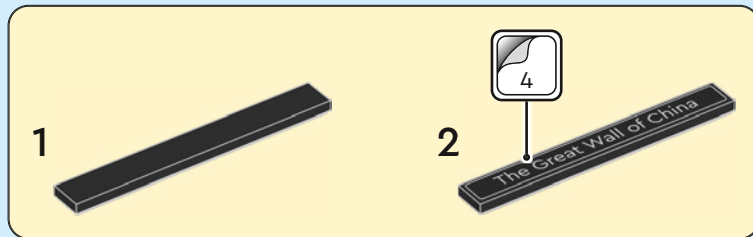



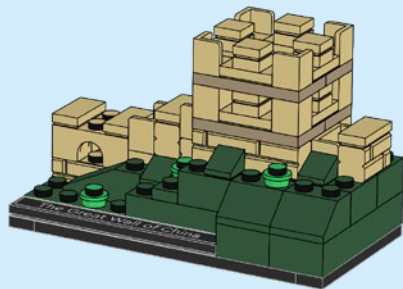
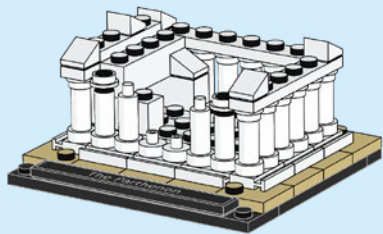
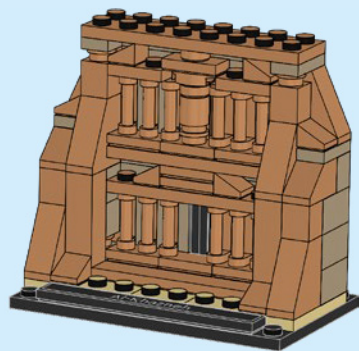
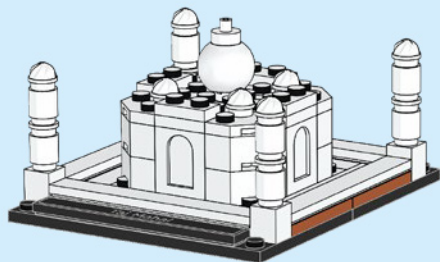

 22x 6234807	 4x 6256077	 12x 4249563	 2x 663601	 8x 4125253	 14x 6221467	 3x 4569058
 8x 306201	 1x 6221773	 2x 302201	 2x 4181142	 4x 4612603	 2x 4618651	 8x 6074892
 8x 6102794	 4x 6322480	 1x 300301	 3x 379501	 3x 6148262	 4x 6232136	 24x 4528604
 25x 6186681	 6x 302301	 1x 301001	 6x 416201	 4x 4114026	 5x 4114309	 6x 4521914
 24x 6168642	 4x 6176240	 1x 371001	 8x 4159553	 8x 6092587	 4x 300123	 2x 4255416
 6x 4504369	 2x 300401	 3x 366601	 4x 4113915	 3x 6248495	 2x 306926	 4x 4267874
 4x 300501	 8x 6137926			 1x 4114084		



4x  
416226



2x  
6168573



1x  
4211043



2x  
6284589



6x  
6357260

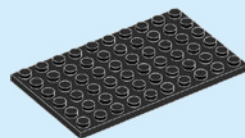

5x  
303326

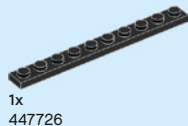

1x  
447726



1x  
4245571



1x  
6300103



5x  
6167641



4x  
6021997



2x  
366626



3x  
6015424



1x  
4586057



12x  
6424277



4x  
6057986



2x  
6292154

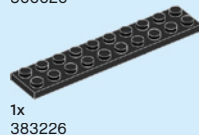

1x  
383226



3x  
4504375



5x  
4260493



1x  
6102995



8x  
6167690



2x  
6058135



1x  
6013102

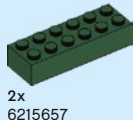

2x  
6215657



1x  
6313600



2x  
6378362



6x  
6102990



2x  
6223304



1x  
4211088



3x  
6226644



4x  
6380634



1x  
6167643



2x  
6056383



 [LEGO.com/service](https://www.LEGO.com/service)

YOU COULD **WIN**



Scan this QR code or go to **LEGO.COM/PRODUCTFEEDBACK** and give us your short feedback about this LEGO® set for a chance to win a cool LEGO prize.

Terms and Conditions apply\*



**DE: Du könntest GEWINNEN.** Es gelten die Teilnahmebedingungen\* **FR: Tu pourrais GAGNER.** Des conditions s'appliquent\* **IT: Potresti VINCERE tu.** Termini e condizioni sono applicabili\* **ES: Puedes GANAR.** Aplican términos y condiciones\* **PT: Poderá GANHAR.** Aplicam-se termos e condições\* **JA: プレゼント付き! 利用規約が適用されます\*** **ZH: 轻松获奖. 条款和条件适用\*** **KO: 상품의 주인이 되어보세요. 소정의 약관이 적용됩니다\*** **RU: Вы можете ВЫИГРАТЬ.** Действуют положения и условия\* **PL: Szansa na WYGRANĄ.** Obowiązują warunki korzystania\* **CS: Máte šanci VYHRÁT.** Platí všeobecné smluvní podmínky\* **SK: Máte šancu VYHRAŤ.** Platia všeobecné zmluvné podmienky\* **HU: TE IS NYERHETSZ.** Felhasználási feltételek érvényesek\* **RO: Ai putea CÂȘTIGA.** Se aplică termeni și condiții\* **BG: Можете да СПЕЧЕЛИТЕ.** Има определени правила и условия\* **LV: Tu vari LAIMĒT.** Ir spēkā noteikumi un nosacījumi.\* **ET: Sul on võimalus VÕITA.** Kehtivad tingimused\* **LT: Jūs galite LAIMĖTI.** Taikomos sąlygos\*  
\*LEGO.com/productfeedback-terms