



BRICK 'HEADZ

40560

Harry Potter



 [LEGO.com/brickheadz](https://www.lego.com/brickheadz)

SYBILL TRELAWNEY

173

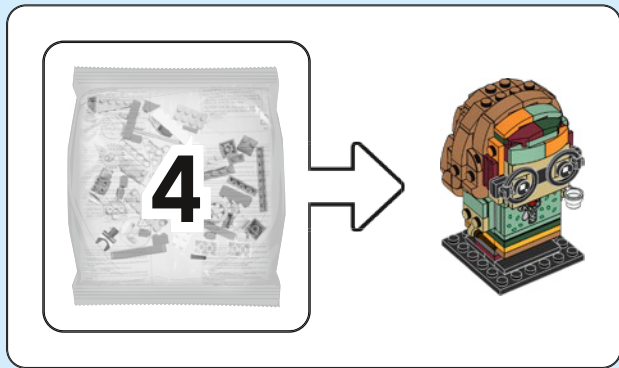

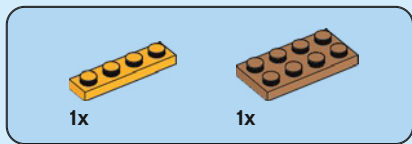

1

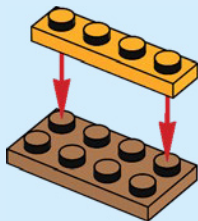



2x

2

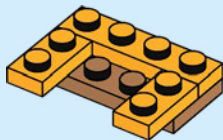



1x

3

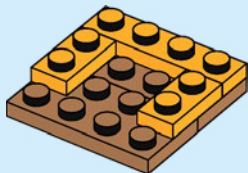



1x

4

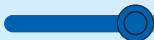
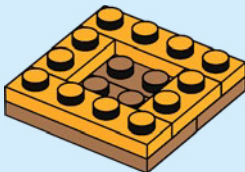

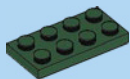

2x

5

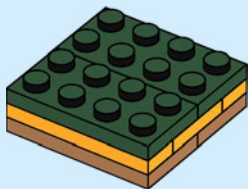

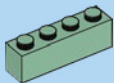

2x

6

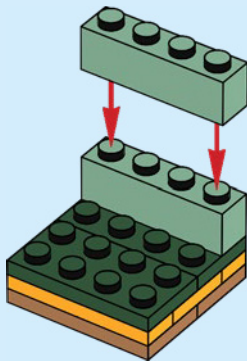



2x

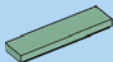

1x

7

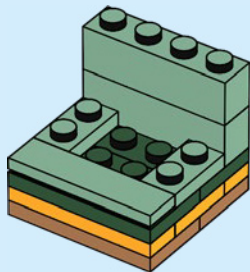



2x



1x

8

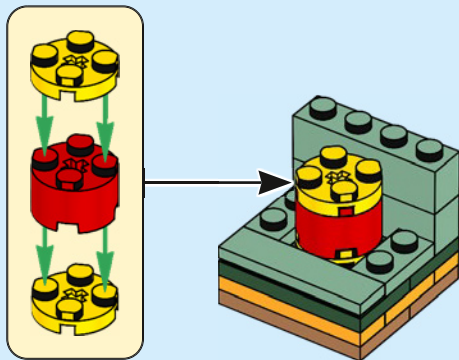

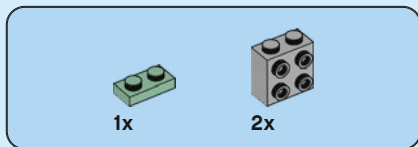

9

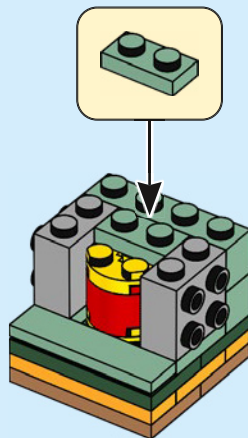

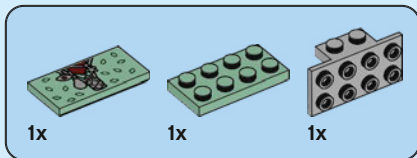

10

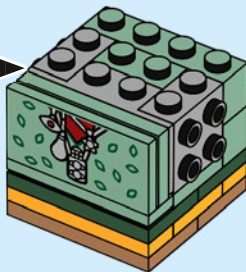
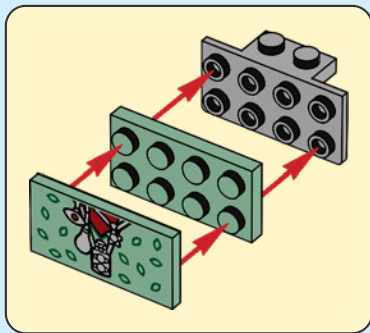

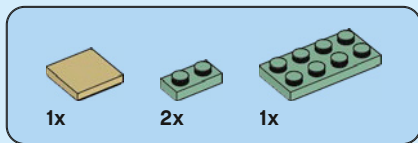

11

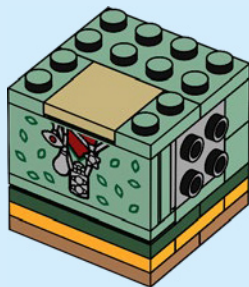

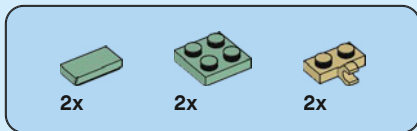

12

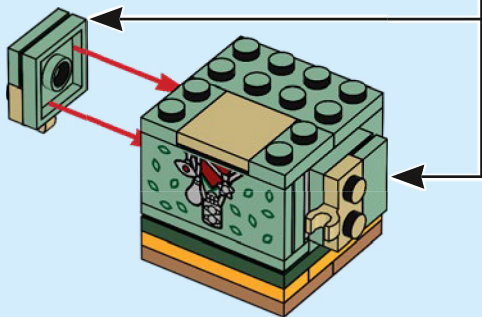
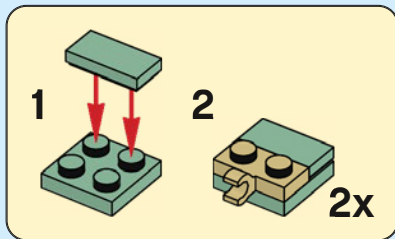



5x

13

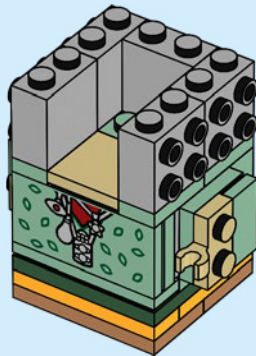

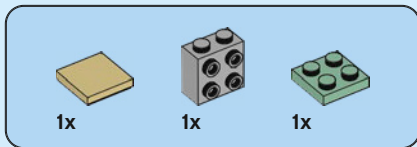

14

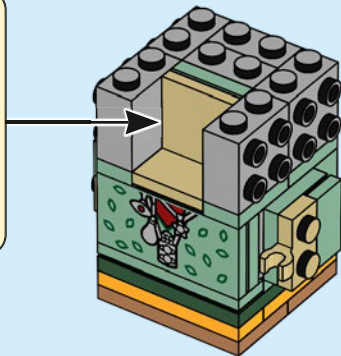
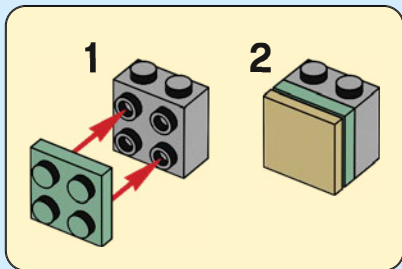



6x

15

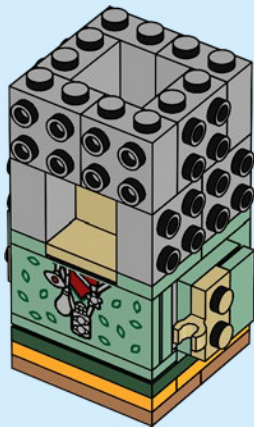



1x



1x



1x

16

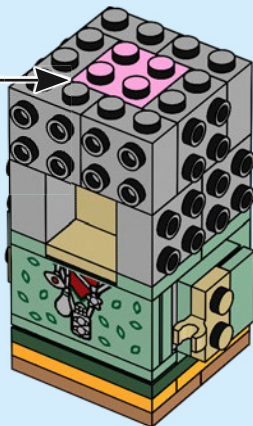
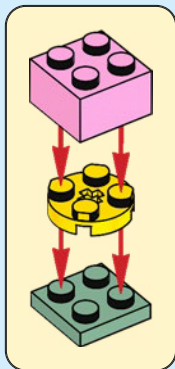



1x

17

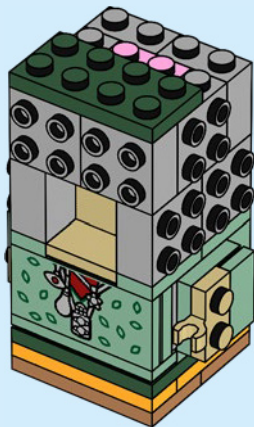



2x



2x



1x

18

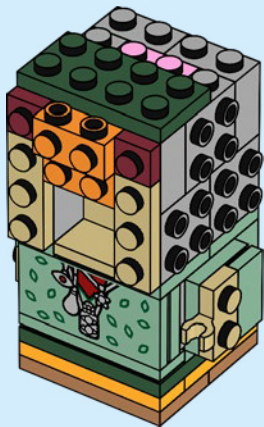

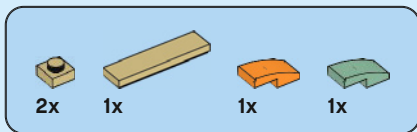

19

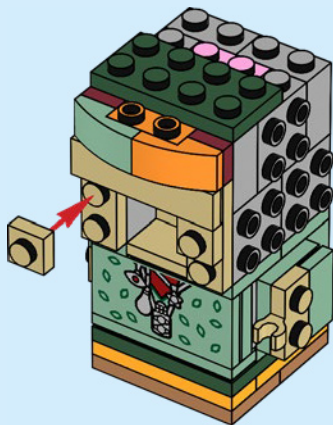

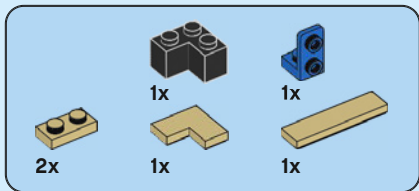

20

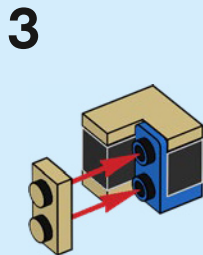
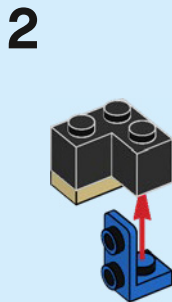
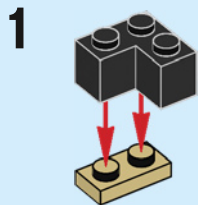



4

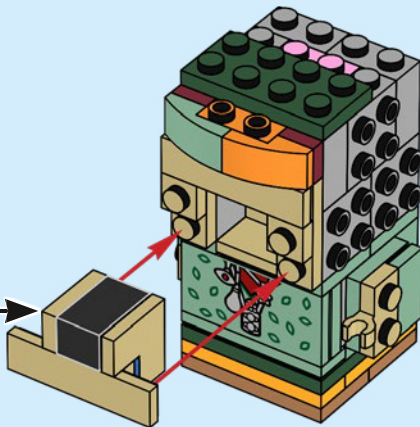
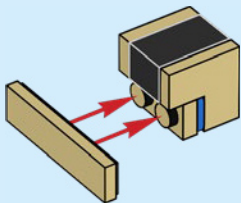



2x

21

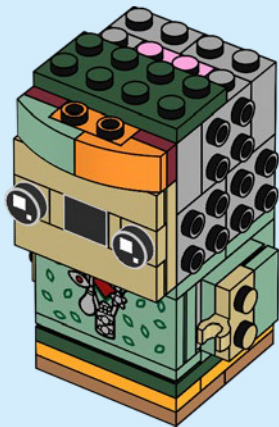



2x



2x

22

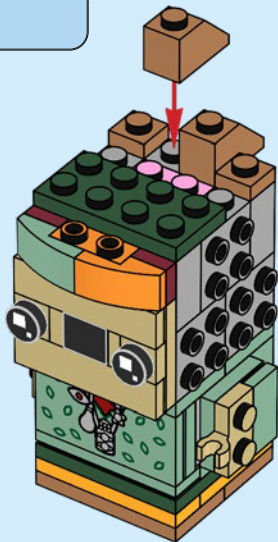



1x



2x

23

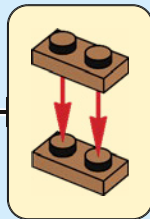
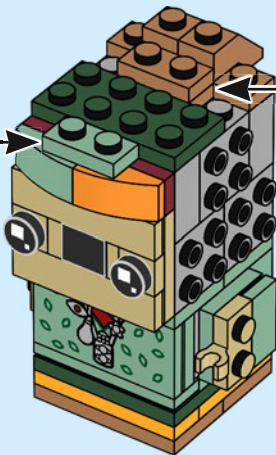
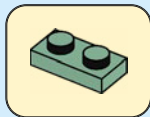



1x



2x

24

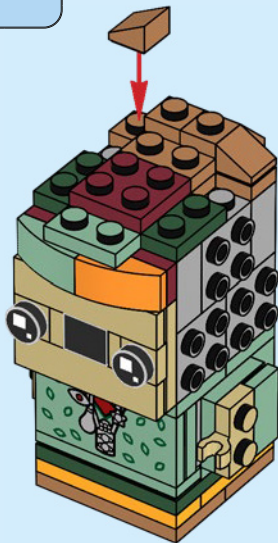



1x



2x

25

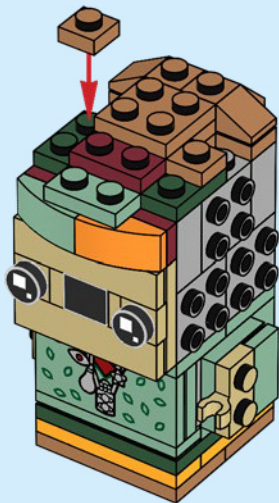



1x



1x



1x



1x



2x

26

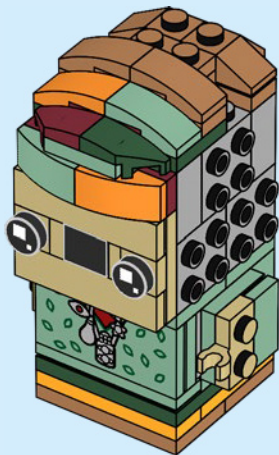



1x

27



1x

28

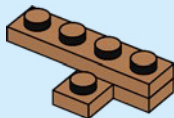



1x

29

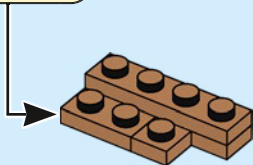

1x



1x

30

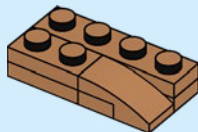



1x



1x

31

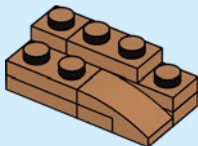

1x



1x

32

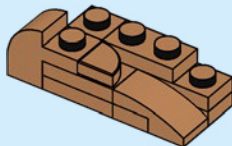



1x



2x



1x

33

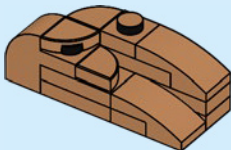

34

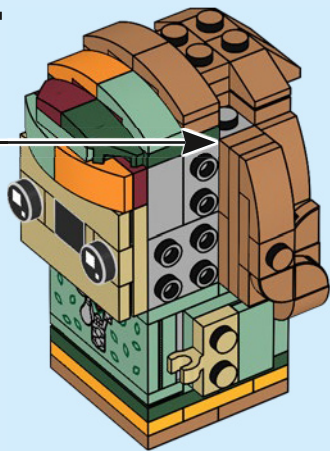

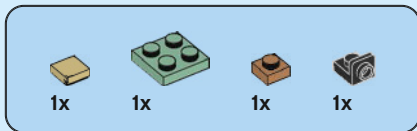

35

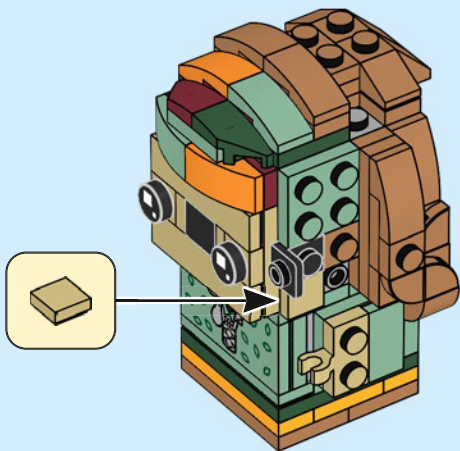



1x



1x



1x

36

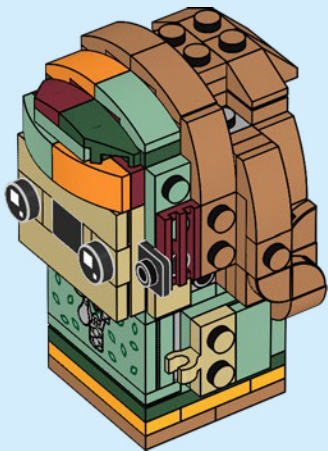



1x



1x

37

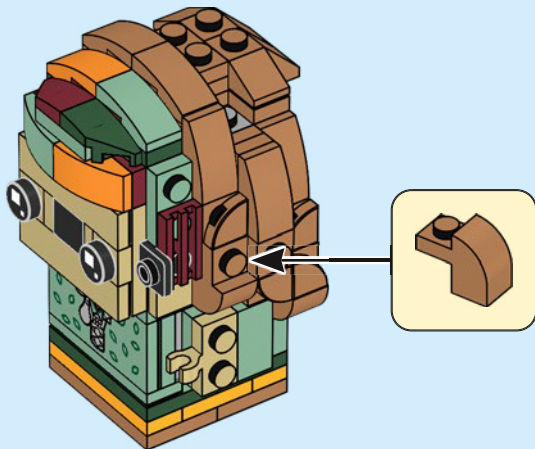



1x

38



1x

39





4x

40

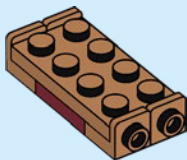

2x

41

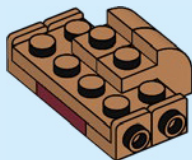

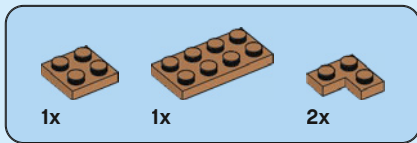

42

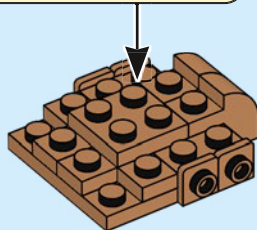
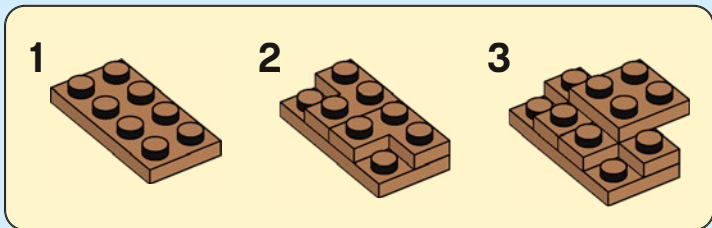



4x

43

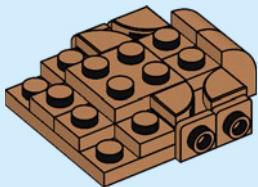



4x

44

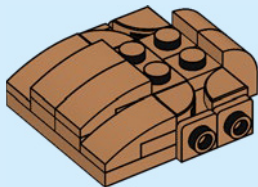

1x



3x

45

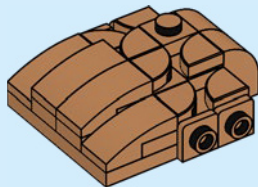



46

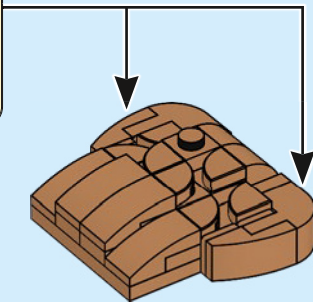
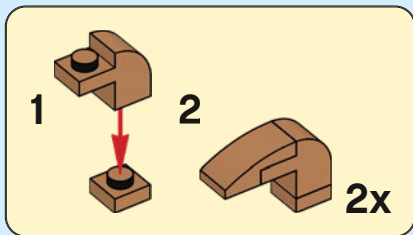

47

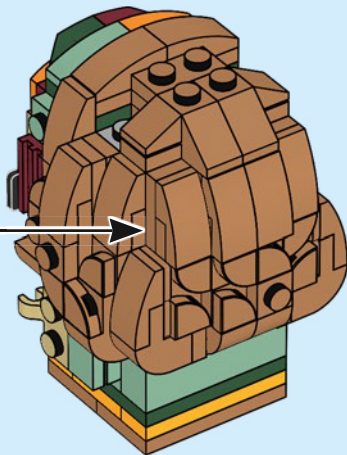



1x

48



1x

49

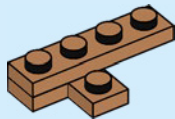



1x

50

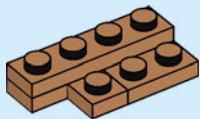

1x



1x

51

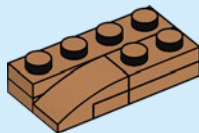



1x



1x

52

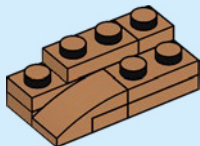

1x



1x

53

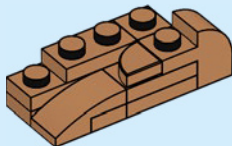



1x



2x



1x

54

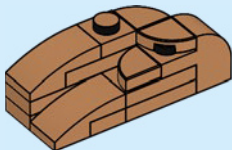

55

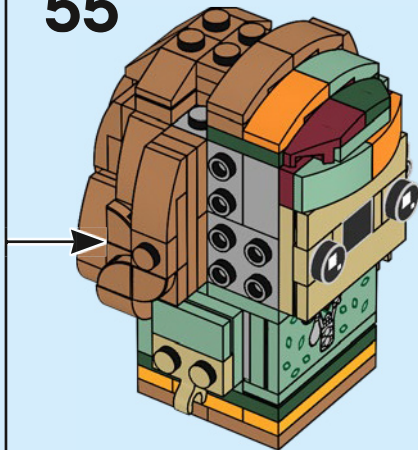

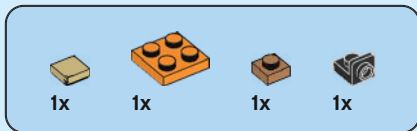

56

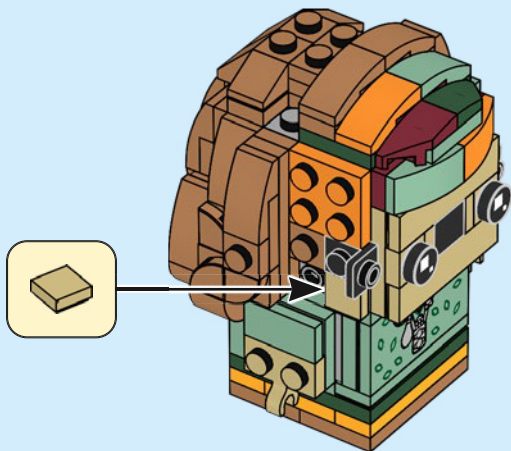



1x



1x



1x

57

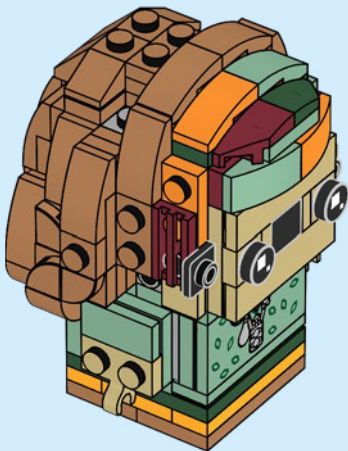



1x



1x

58

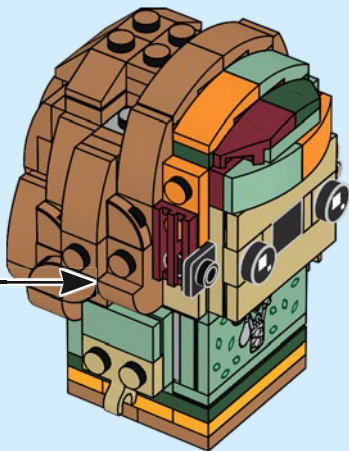



59

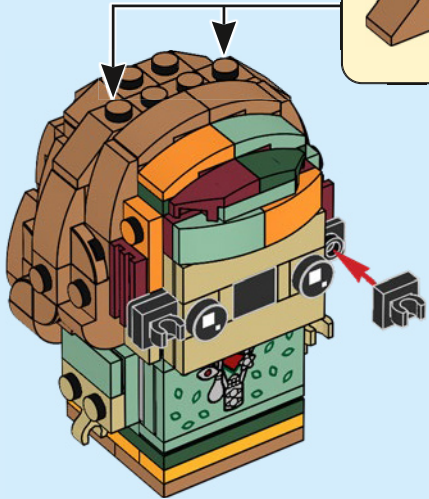
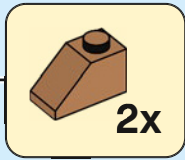



2x

60

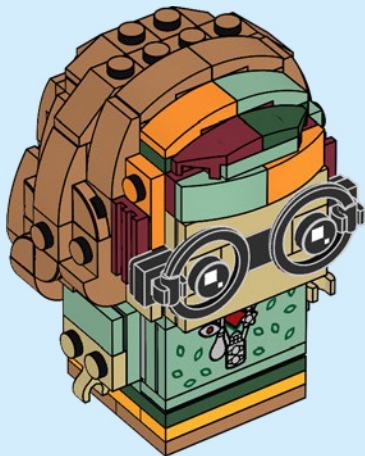



61

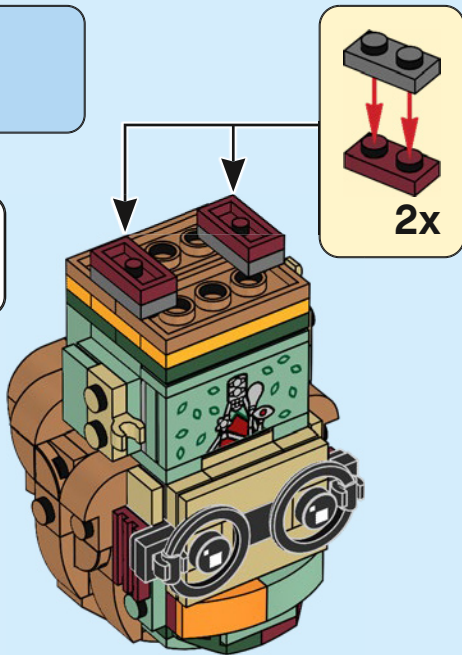



1x



1x

62

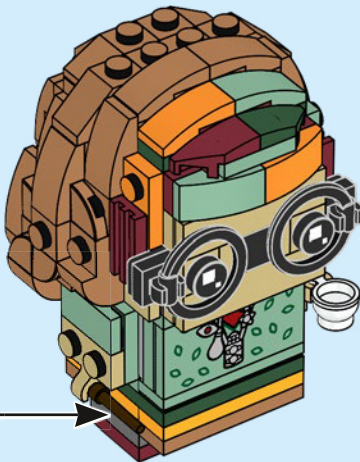

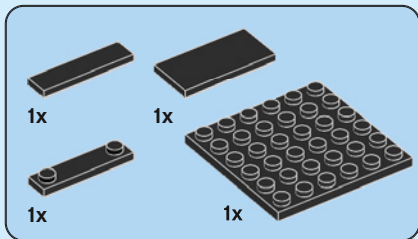

63

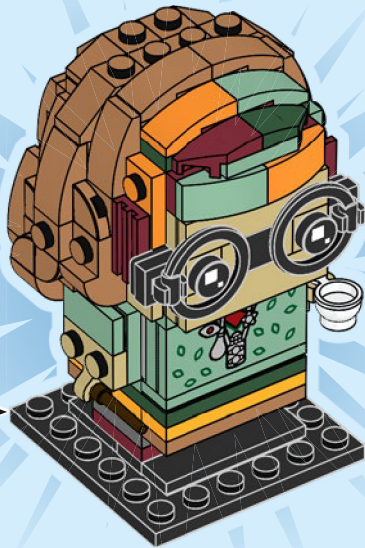
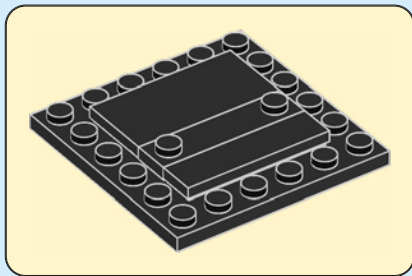



2x
6186681



1x
6235083



2x
6046979



6x
4159553



2x
4125253



2x
4516055



2x
4624086



2x
4114026

56



2x
6024495



9x
4113917



8x
6313119



1x
4114084



3x
4185177



2x
4114077



5x
6173057



2x
6132769



2x
4121921



2x
6211966



1x
4118790



2x
6257600



3x
4113233



6x
4550324



1x
6122047



5x
614321



1x
6344218



9x
403224



7x
6284077



1x
6270027



1x
407026



2x
6335388



12x
4504382



2x
307026



5x
302426



11x
6172383



2x
6187572



4x
6234695



2x
6196548



1x
6051508



3x
4548180



2x
6391688



4x
6047276



4x
6174243



1x
6092585



1x
6267487



1x
393826



4x
306926



10x
302326



1x
393726



2x
6016172



3x
4584274



3x
4107761



5x
302226



6x
6053077



5x
6176768



1x
303926



2x
242026



1x
235726



4x
362326



2x
362226



1x
6118829



1x
6386817



1x
6162892



5x
302126



4x
4613153



6x
243126



4x
6254045



2x
301026



4x
4560182



4x
302026



4x
302428



2x
306928

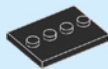

1x
6076678

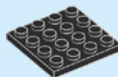

1x
4243819



2x
6133200

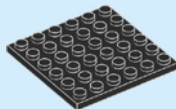

4x
395826



5x
302328



1x
4107736



4x
6117971



3x
302228



4x
300328



1x
303928



2x
4109679



2x
302128



2x
6386818



2x
4112838



3x
302028



2x
6055069



1x
4159007



1x
6289113



4x
6248962



1x
6270031



7x
4549436



1x
6001824



22x
6362967



1x
6015449



8x
6335228

58



6x
6101254



1x
6360295



2x
4528604



3x
6250168



2x
6047415



3x
6035540



6x
4267874



1x
6214813



3x
4586057



2x
4616578



6x
4655080



2x
6196591



5x
6186823



1x
6192923



2x
4521947



1x
6386816



2x
6249817



2x
4539114



1x
6219658



2x
4539097



2x
4541506



2x
4585479



1x
6245206



2x
6020073



2x
6028736



4x
4225469



1x
6117976



1x
6226436



2x
4211257



1x
6168623



1x
4211190



1x
4538252



1x
6386815



6x
4558953



1x
4211398



39x
6123809



1x
4211881



1x
6118827



1x
6118827



1x
4210788



1x
4210782



2x
4567887



5x
4211063



2x
4540386



1x
4211066



4x
6029948



2x
6344820



8x
4210635



2x
4211043



2x
4648256



1x
4211001



1x
4211065



1x
6047422



1x
6096589



3x
4550359



1x
6230082



1x
6009771



2x
6252838



1x
4505990



1x
6386819



2x
6324841



2x
6270032



3x
6058221



13x
6215606



2x
6167690



15x
6248536



4x
6324205



4x
6380634



2x
4569382



8x
6360296



14x
6356566



2x
6021997



12x
6218360



4x
6058135



6x
6056383



6x
6056383



4x
6177535



2x
6102998



2x
6343854



2x
6223183



4x
6167700



4x
6167700



8x
6093494

LEGO and the LEGO logo are trademarks of the/son des marques de commerce du /son marcas registradas de LEGO Group. ©2022 The LEGO Group.



WIZARDING WORLD characters, names and related indicia are © & ™ Warner Bros. Entertainment Inc. WB SHIELD: © & ™ WB Entertainment Publishing Rights © JKR. (s22)

Customer Service
Kundenservice
Service Client
Asistencia clienti
Atención al cliente
Serviço de Apoio ao Consumidor
Ügyfélszolgálat
Klientu apkalpošanas dienests
Serviciul pentru clienți
客户服务
コンシューマーサービス
고객 서비스

[LEGO.com/service](https://www.lego.com/service)

WIN

Terms & Conditions apply

Scan this QR code or go to **LEGO.COM/PRODUCTFEEDBACK** and give us your short feedback about this LEGO® set for a chance to win a cool LEGO prize.



GEWINNE

Scanne diesen QR-Code oder geh auf **LEGO.COM/PRODUCTFEEDBACK**

und gib uns dein kurzes Feedback zu diesem LEGO® Set. Dann hast du die Chance, einen coolen LEGO Preis zu gewinnen.

Es gelten die Teilnahmebedingungen

GAGNE

Scannez ce code QR ou rendez-vous sur **LEGO.COM/PRODUCTFEEDBACK**

pour donner votre avis sur ce produit LEGO® et avoir une chance de gagner un prix LEGO.

Voir Conditions Générales

GANAN

Escanea este código QR o visita **LEGO.COM/PRODUCTFEEDBACK**

y comparte con nosotros tu opinión sobre este set LEGO® para tener la oportunidad de ganar un fantástico premio LEGO.

Términos y Condiciones aplicables

获取奖品

只需扫描此二维码或访问 **LEGO.COM/PRODUCTFEEDBACK**,

就这款乐高®套装提供简短反馈, 就有机会赢得很酷的乐高奖品。

《条款及条件》适用

6417983/6417984