



BRICK SKETCHES™

40456



Disney
MICKEY
AND FRIENDS

Mickey Mouse

Some time ago I was a part of an artists' group on a popular social media platform. Many of the artists were doing marker sketches on small cardstock as a way to engage with their fans. I thought this was a fantastic idea, but I wanted to put my own spin on it using LEGO® bricks. This led to the creation of the very first Brick Sketch. I posted it to my social media channels with some apprehension, not entirely sure how my fans would react. Thankfully, they loved the concept and wanted to see more!

After some experimenting, I nailed down the basics: Brick Sketches would be plate-based artwork that featured a front-facing character on a 12x16 canvas. Given that Brick Sketches are somewhat three-dimensional, it was also important that they have correct relief wherever possible; for example, the character's chin shouldn't extend further out than the nose. The challenge was to use LEGO pieces creatively to build detailed character artwork on a relatively small canvas.

Brick Sketches became far more popular than I ever expected. Fans loved suggesting new characters and often asked me to create instructions so that they could build their favorites. It was difficult to set aside the concept when I started working at the LEGO Group, but through an amazing series of events, Brick Sketches are now available from the LEGO Group itself. It's a dream come true.



LEGO® designer Chris McVeigh

Mickey Mouse

Il y a quelque temps, je faisais partie d'un groupe d'artistes sur la plate-forme d'un média social très connu. De nombreux artistes réalisaient des croquis au marqueur sur de petits cartons pour interagir avec leurs fans. Cette idée me plaisait beaucoup, mais je voulais y apporter ma touche personnelle à l'aide de briques LEGO®. J'ai donc eu l'idée de créer le tout premier croquis en briques. Je l'ai publié sur mes réseaux sociaux avec une certaine appréhension, car je ne savais pas comment mes fans allaient réagir. Heureusement, ils ont adoré le concept et en ont redemandé !

Après quelques expérimentations, je me suis fixé des règles : les croquis en briques devaient être des œuvres montées sur une plaque et ils devaient représenter un personnage de face sur une toile de 12 x 16 tenons. Comme les croquis en briques sont tridimensionnels, il était également important qu'ils soient correctement proportionnés dans la mesure du possible. Le menton du personnage ne devait pas être plus long que le nez, par exemple. Le défi consistait à utiliser des pièces LEGO de manière créative pour construire des représentations détaillées de personnages sur une toile relativement petite.

Les croquis en briques ont eu beaucoup plus de succès que je ne l'aurais imaginé. Les fans adoraient me suggérer de nouveaux personnages et me demandaient souvent de créer des instructions pour pouvoir les construire eux-mêmes. Lorsque j'ai commencé à travailler pour le Groupe LEGO, j'ai eu du mal à mettre ce concept de côté, mais suite à un concours de circonstances incroyable, le Groupe LEGO a fini par proposer lui-même les croquis en briques. Un rêve est devenu réalité.



Le designer LEGO® Chris McVeigh

Mickey Mouse

Hace tiempo, fui miembro de un grupo de artistas en una popular red social. Muchos de ellos hacían dibujos con marcadores en pequeños lienzos de cartulina para interactuar con sus fans. Me pareció una idea fantástica, pero quise darle mi propio toque personal usando bricks LEGO®. Eso fue lo que condujo a la creación del primer Brick Sketch. Lo publiqué en mis canales de las redes sociales con cierta desconfianza, sin estar del todo seguro de cómo reaccionarían mis fans. ¡Afortunadamente, les encantó el concepto y querían ver más!

Luego de experimentar un poco, definí lo básico: un Brick Sketch sería un diseño a base de placas que representaría a un personaje, de frente, sobre un lienzo de 12x16. Dado que los Brick Sketches son, en cierto modo, tridimensionales, también era importante recrear el relieve correcto donde fuera posible; por ejemplo, la barba de un personaje no debía sobresalir más que su nariz. El desafío consistía en usar piezas LEGO con creatividad para construir retratos detallados de personajes sobre un lienzo relativamente pequeño.

Los Brick Sketches acabaron haciéndose mucho más populares de lo que esperaba. A los fans les encantaba sugerir nuevos personajes y, a menudo, me pedían que creara las instrucciones necesarias para construir a sus favoritos. Fue difícil apartarme de la idea cuando empecé a trabajar en The LEGO Group. Sin embargo, luego de una sorprendente serie de acontecimientos, los Brick Sketches vuelven a estar disponibles, ahora oficialmente, como productos LEGO. Es un sueño hecho realidad.



El diseñador de LEGO® Chris McVeigh



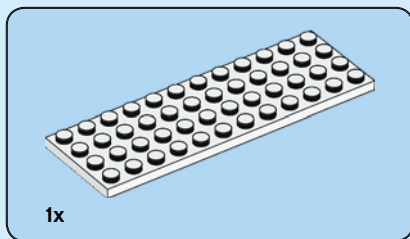

1

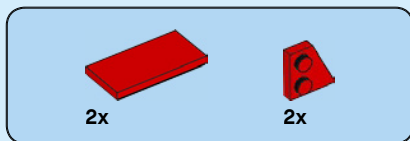
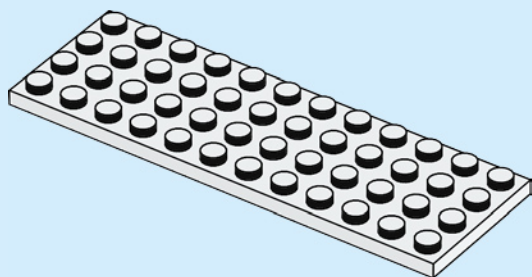

2

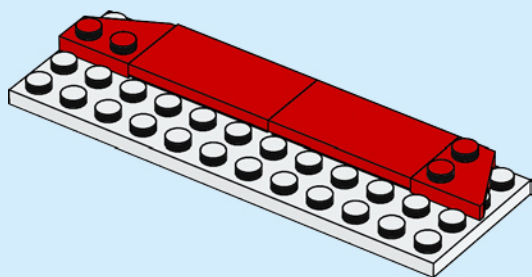

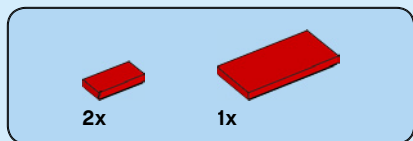

3

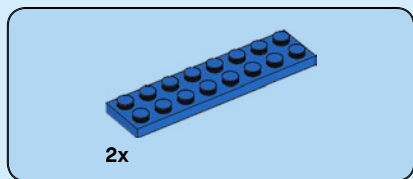
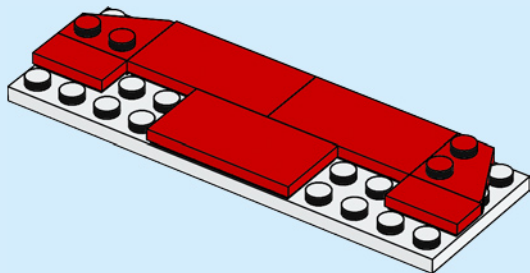

4

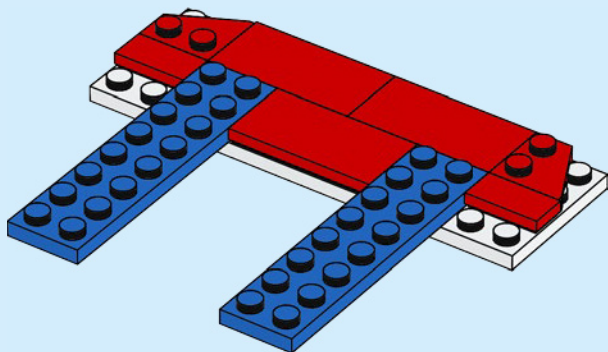

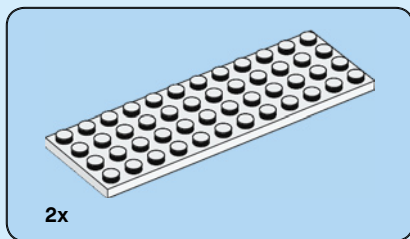

5

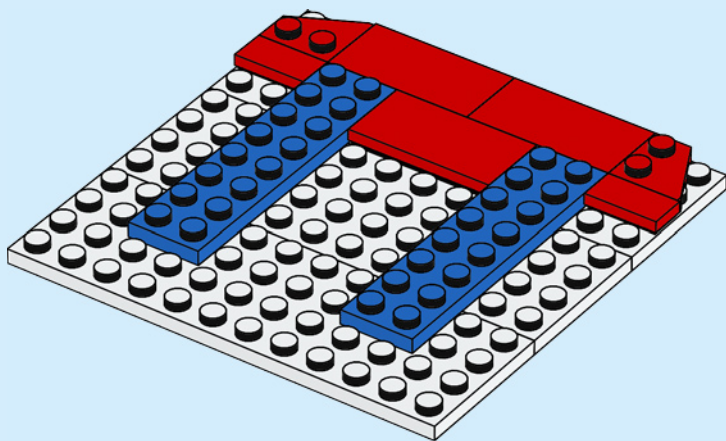

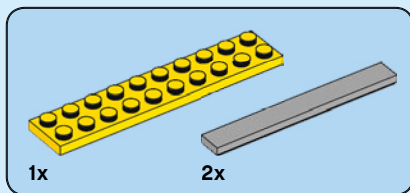

7

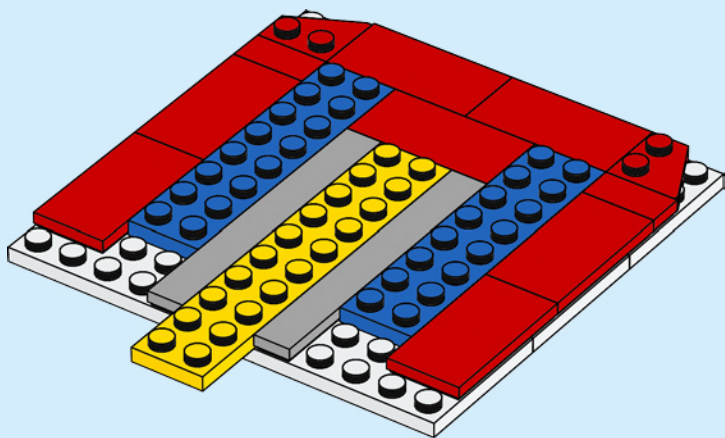

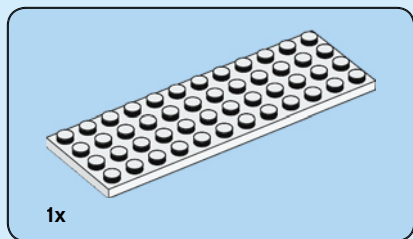

8

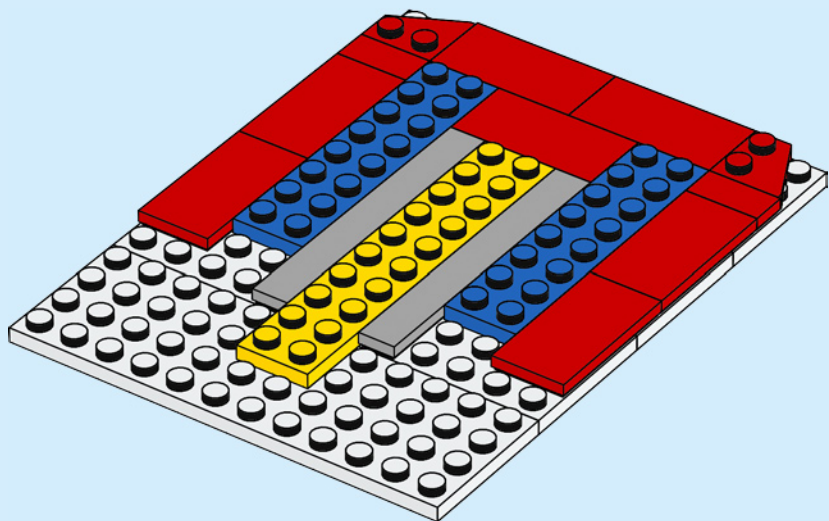

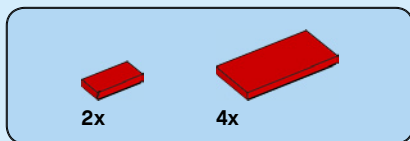

9

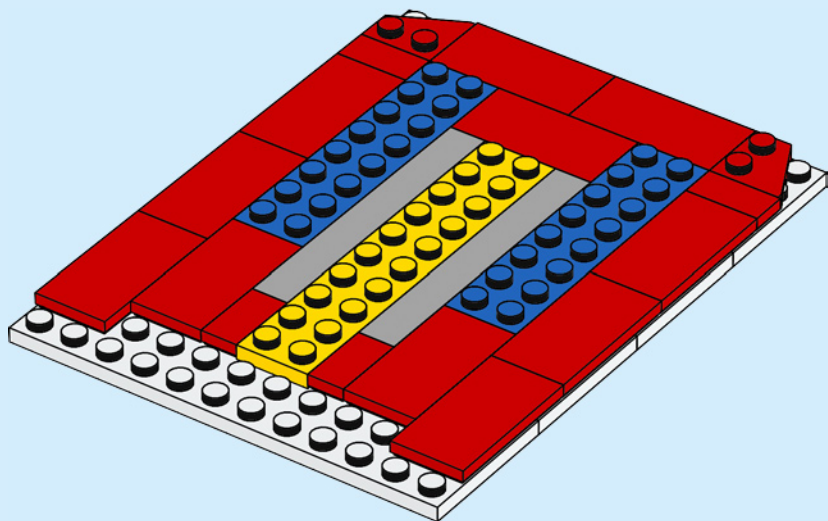

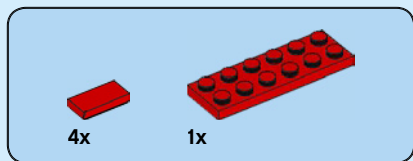

10

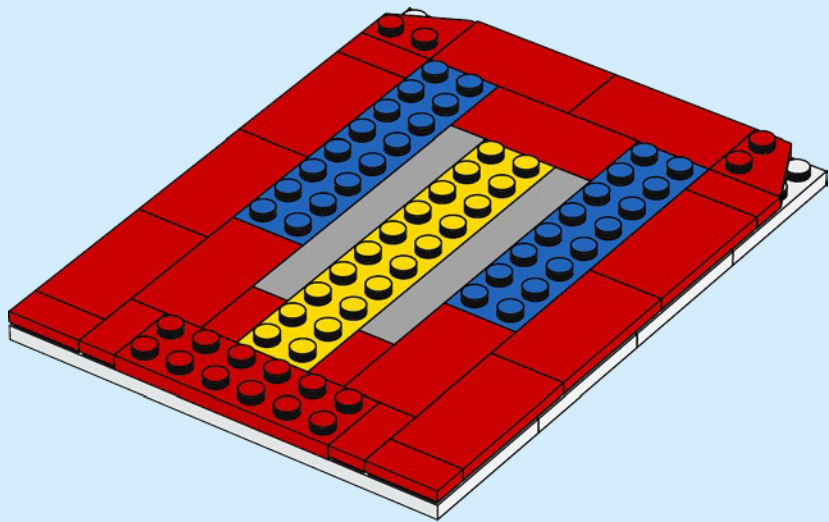

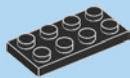

2x

11

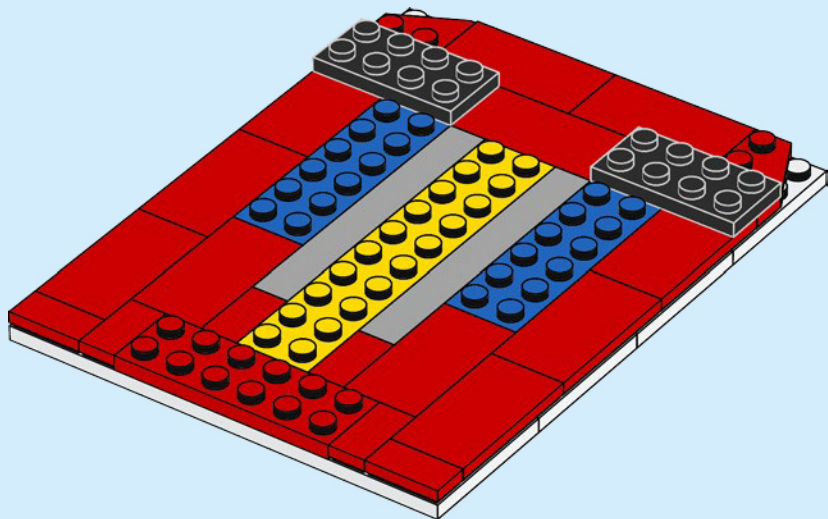

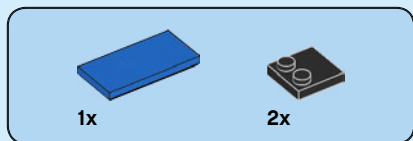

12

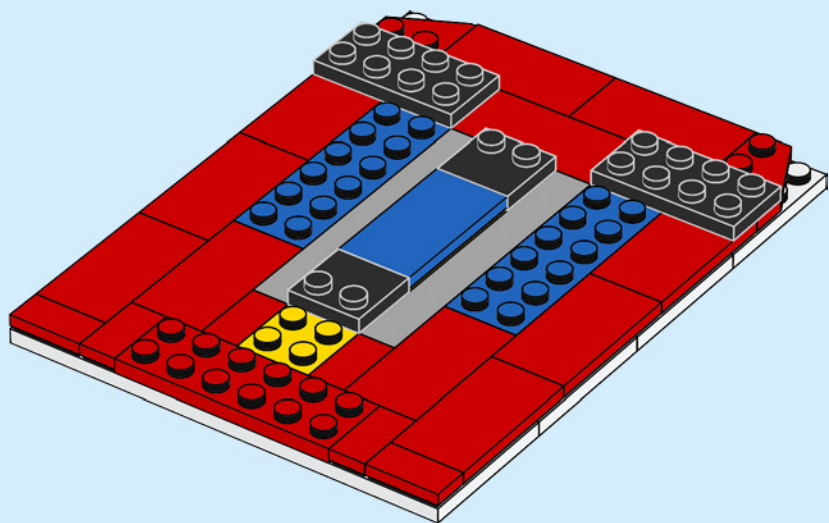

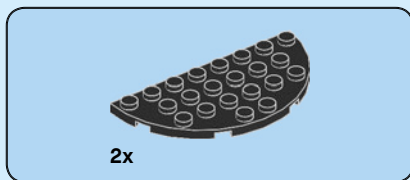

13

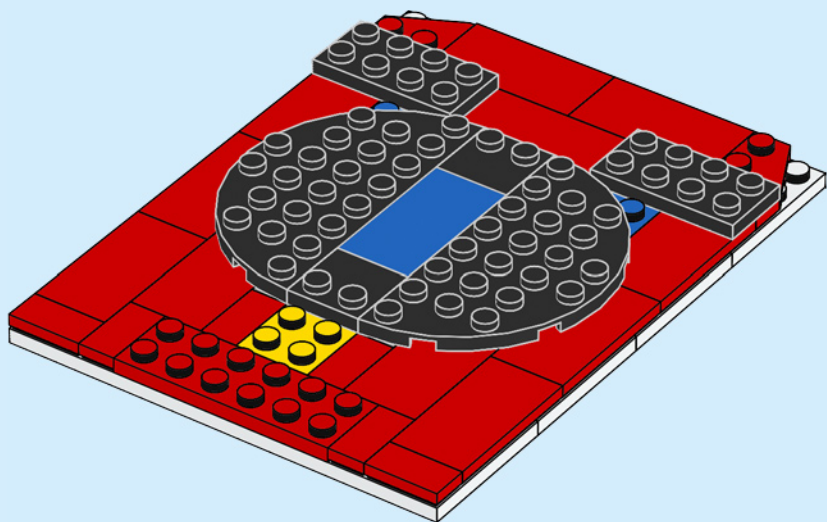

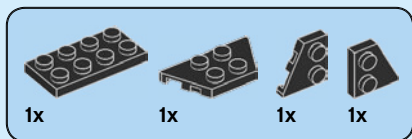

14

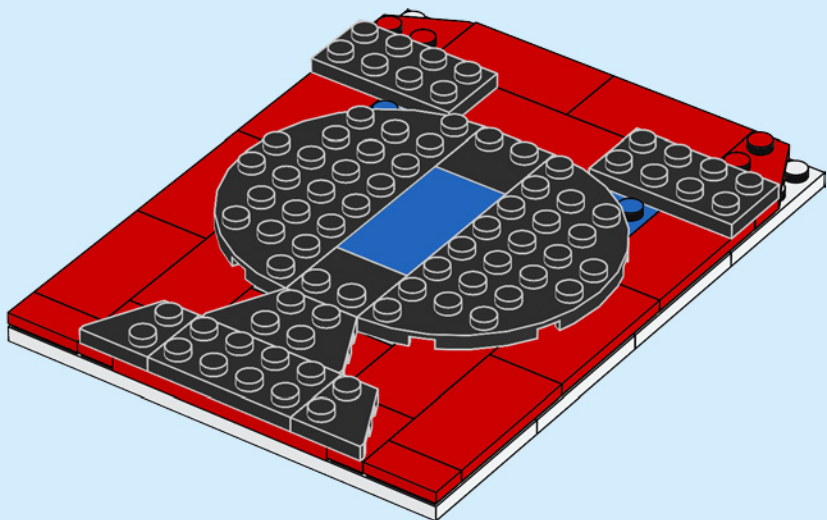

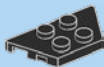

1x

15

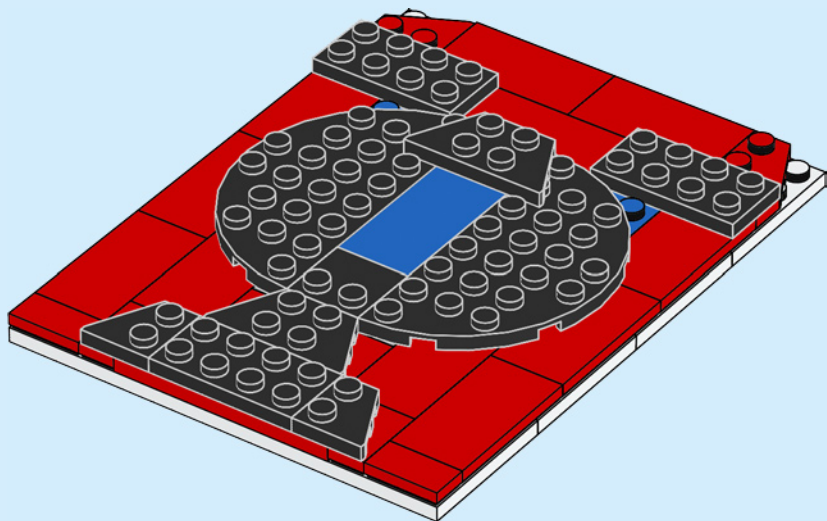

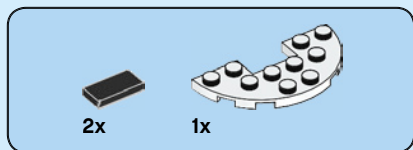

16

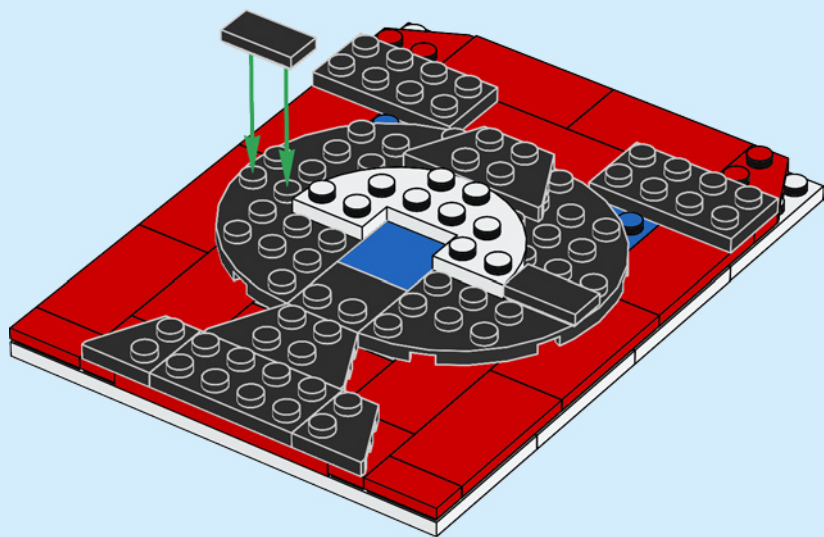



1x



1x

17

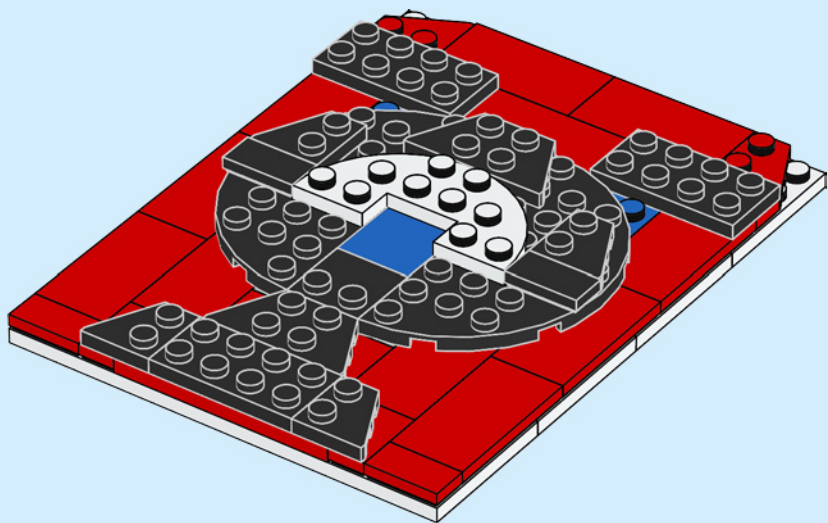

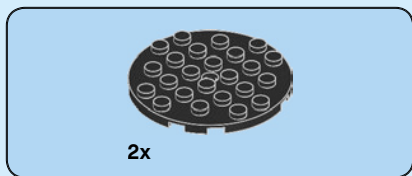

18

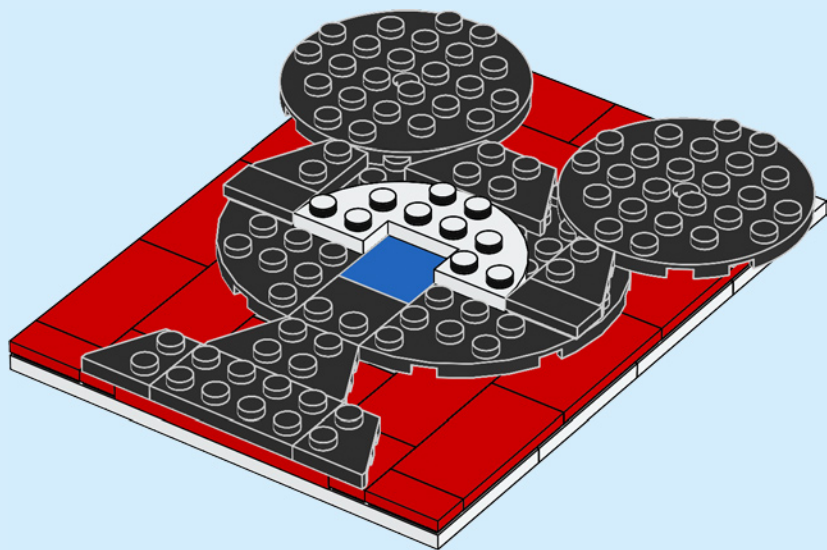

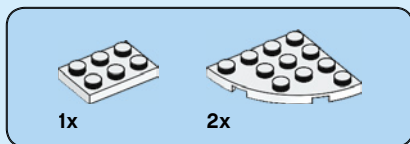

19

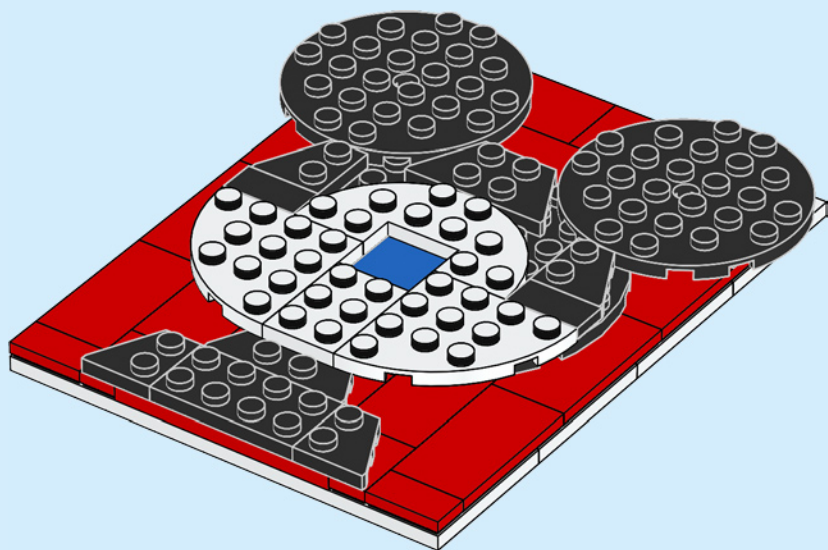

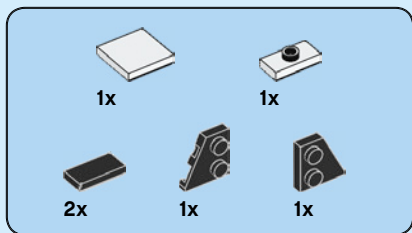

20

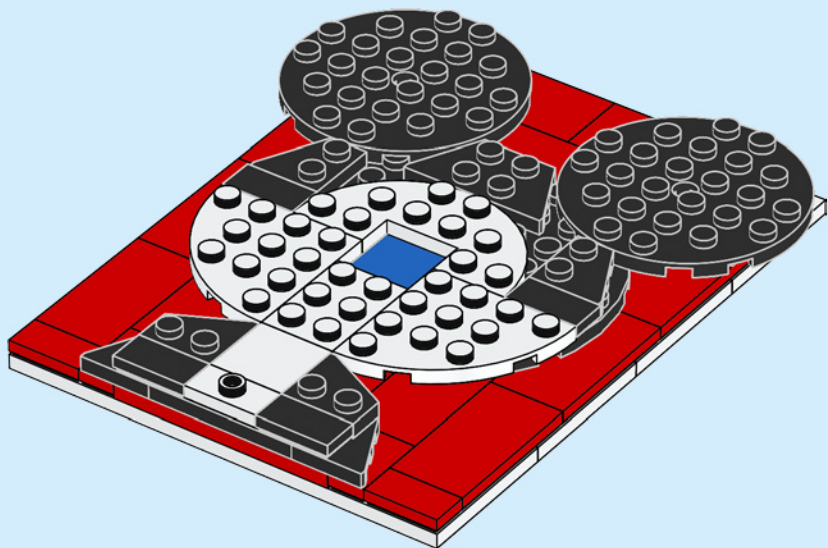

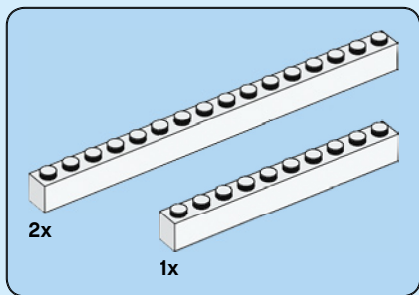

21

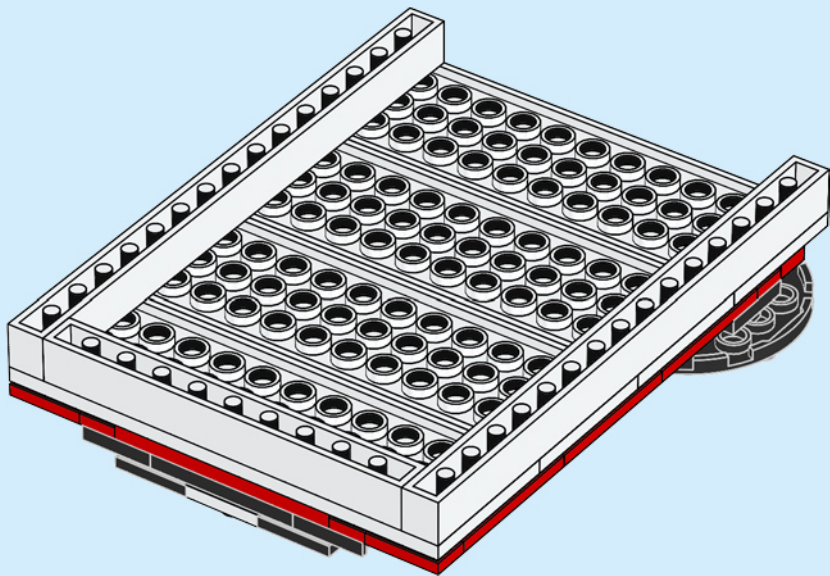

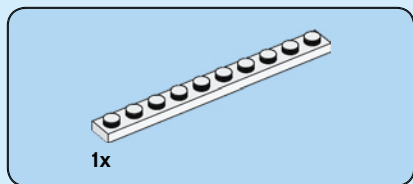

22

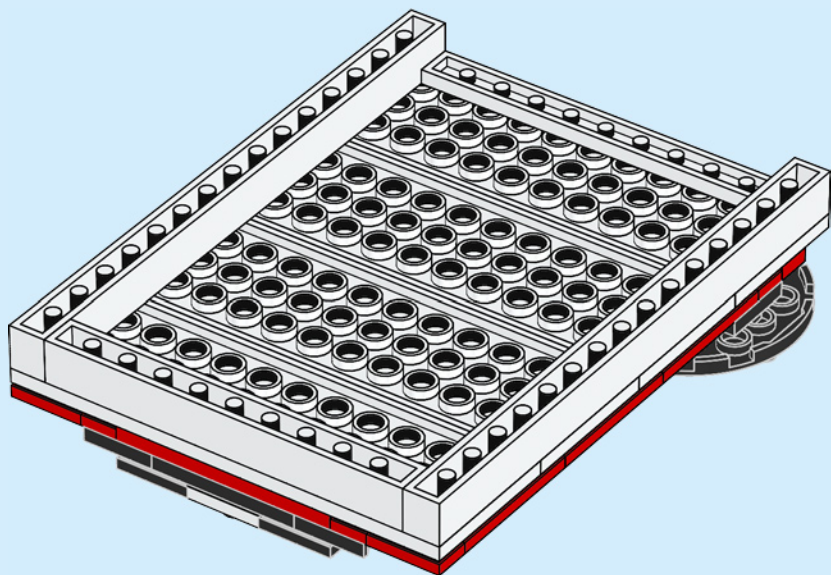



2x



1x

23

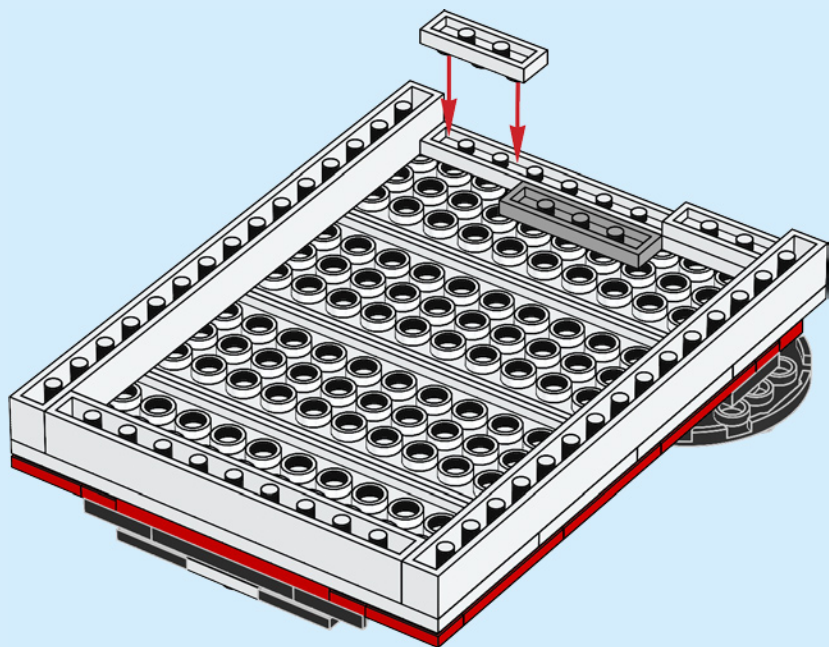



1x



2x

24

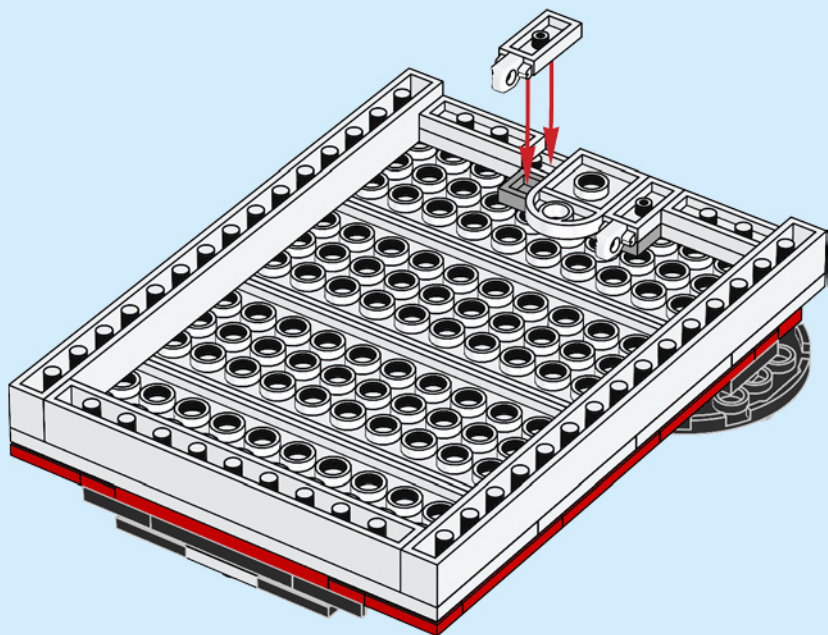

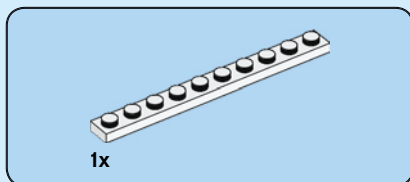

25

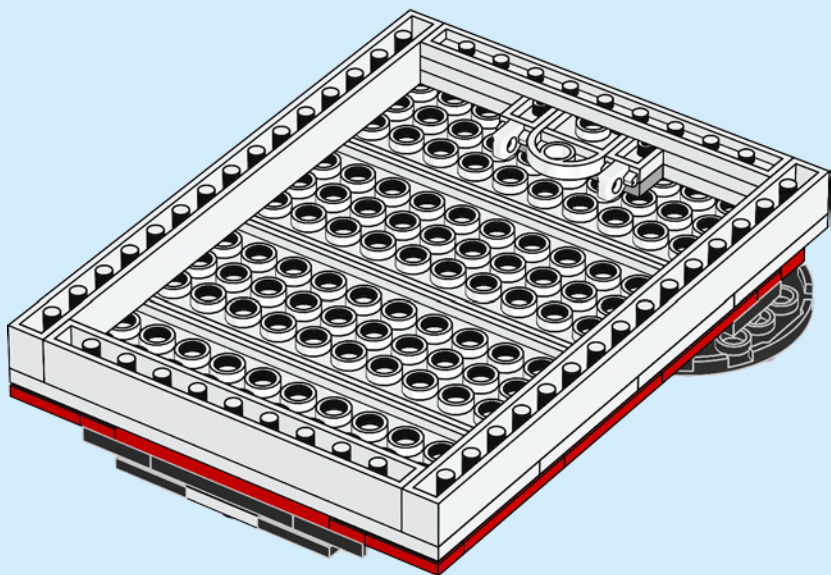

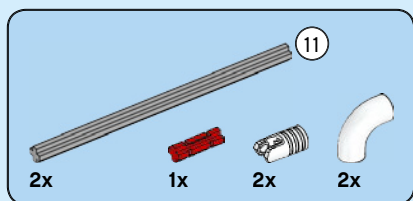

26

1

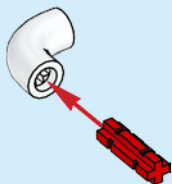

2



3

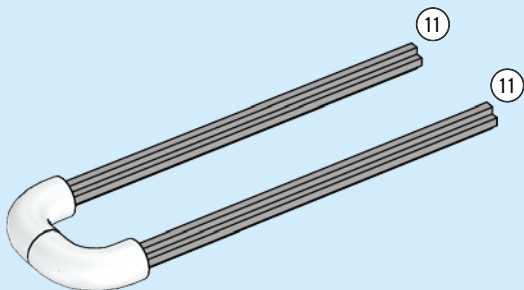



11

1:1

4

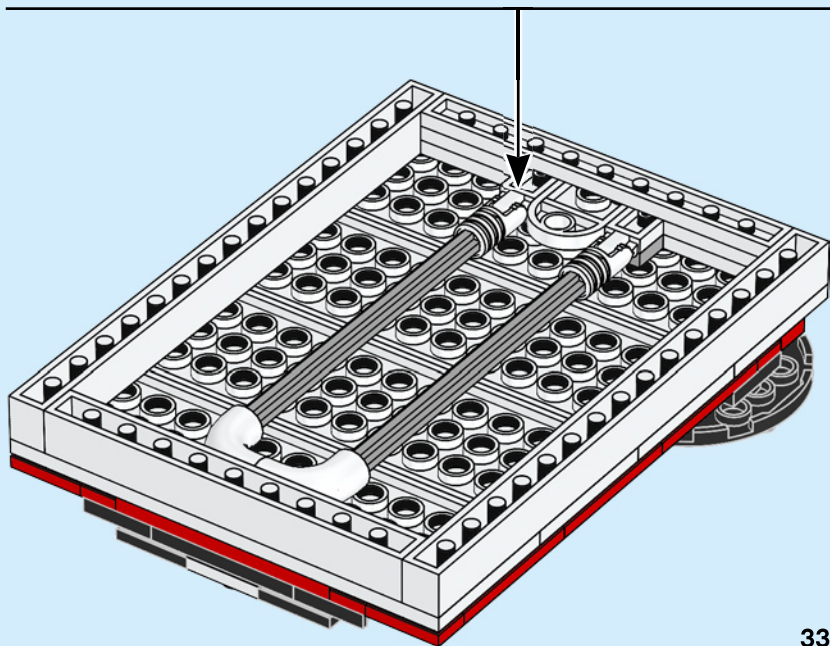
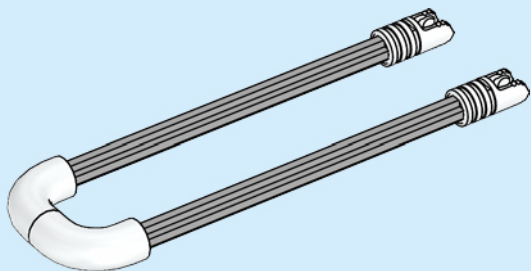



4x

27

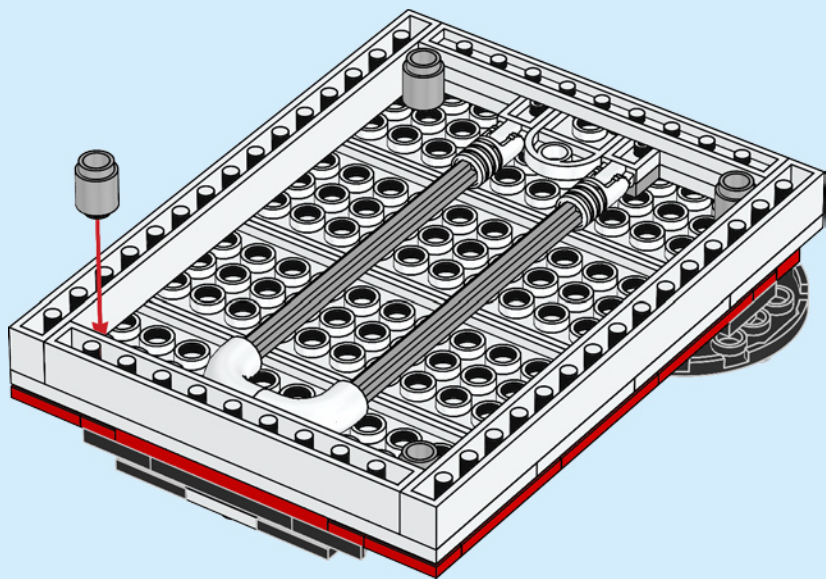



4x

28

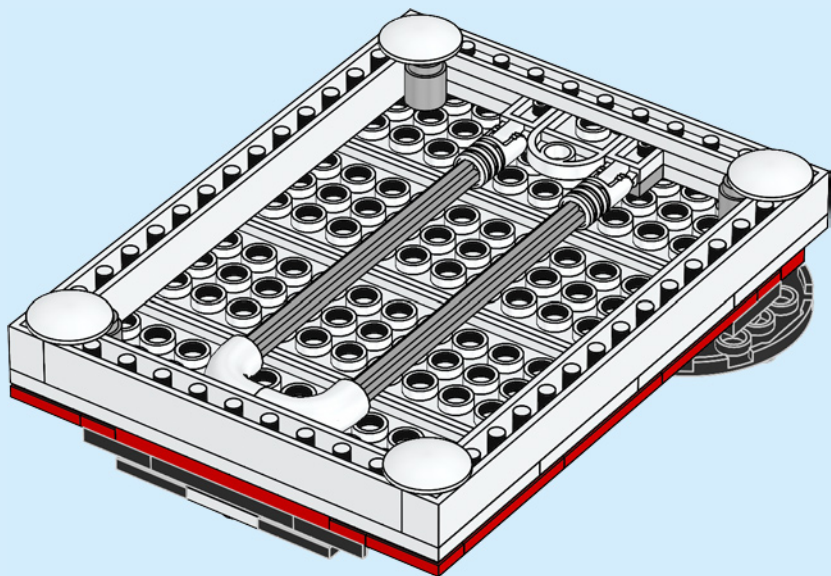

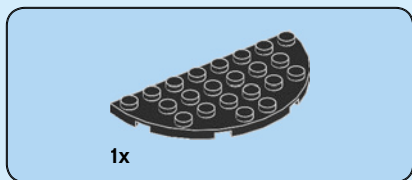

29

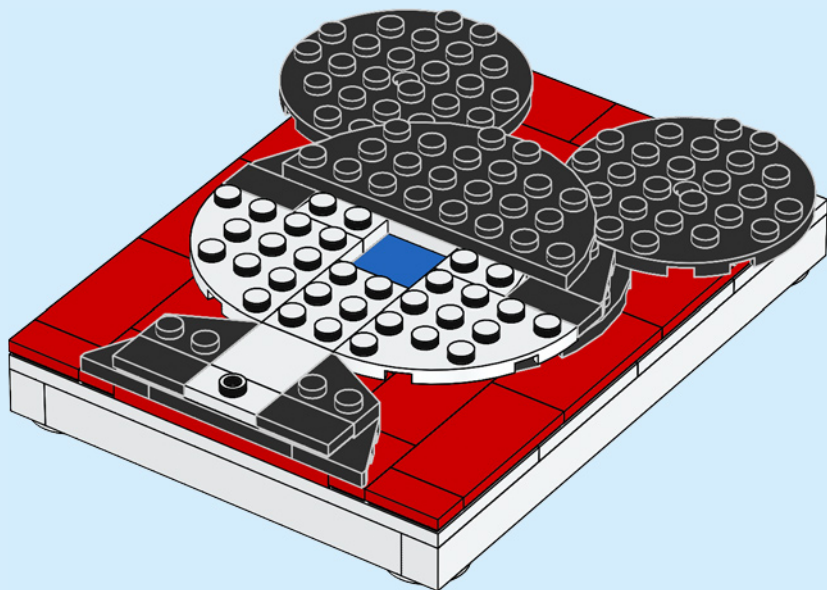

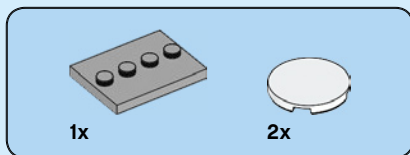

30

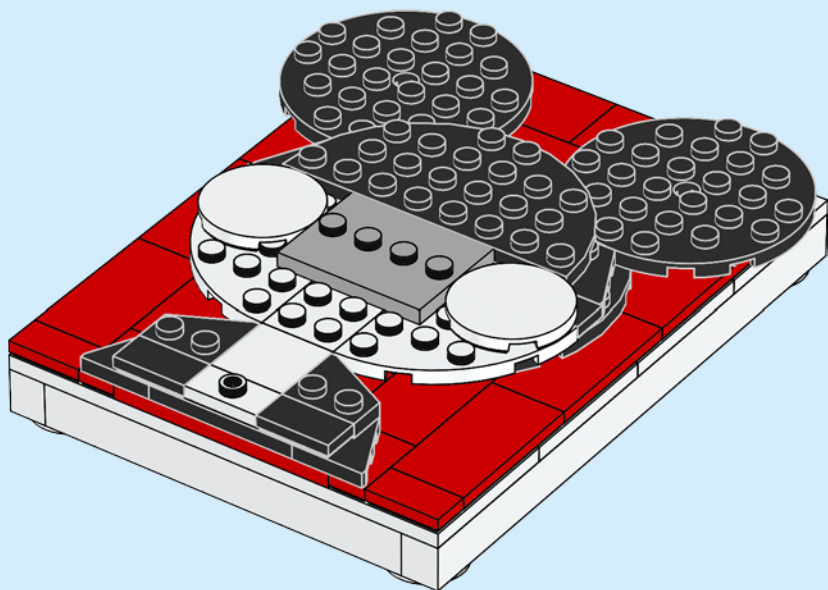

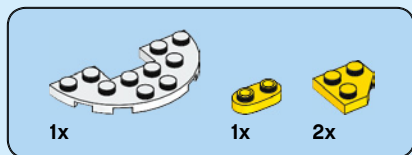

31

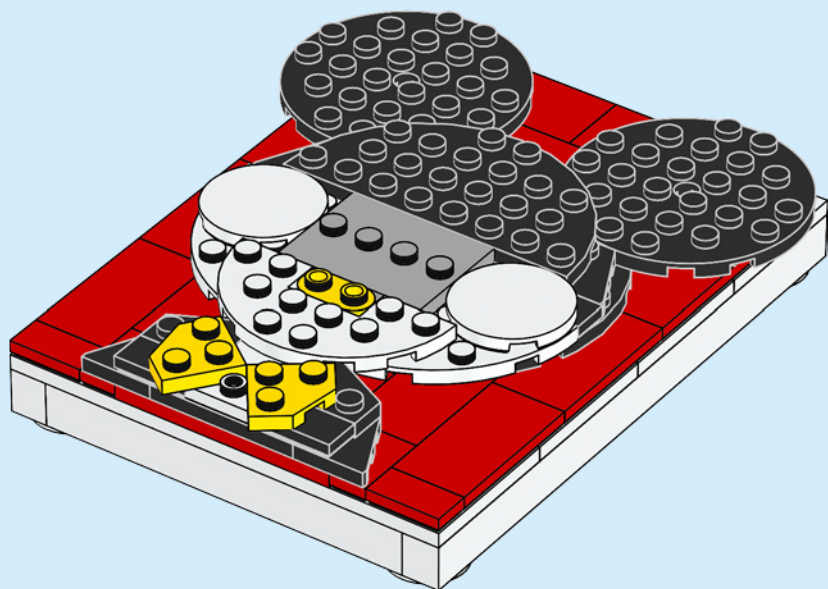

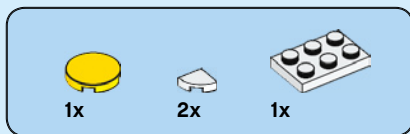

32



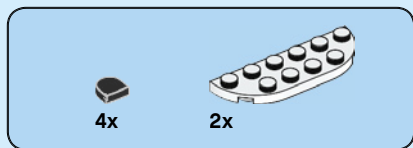

33

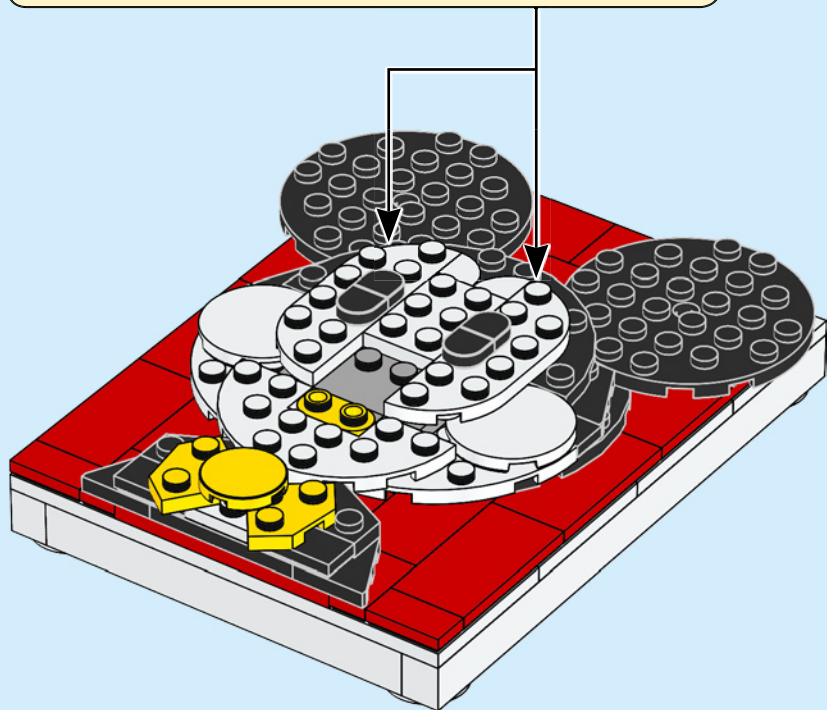
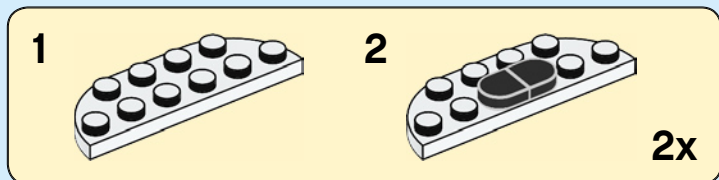

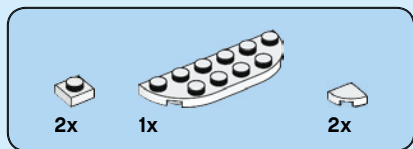

35

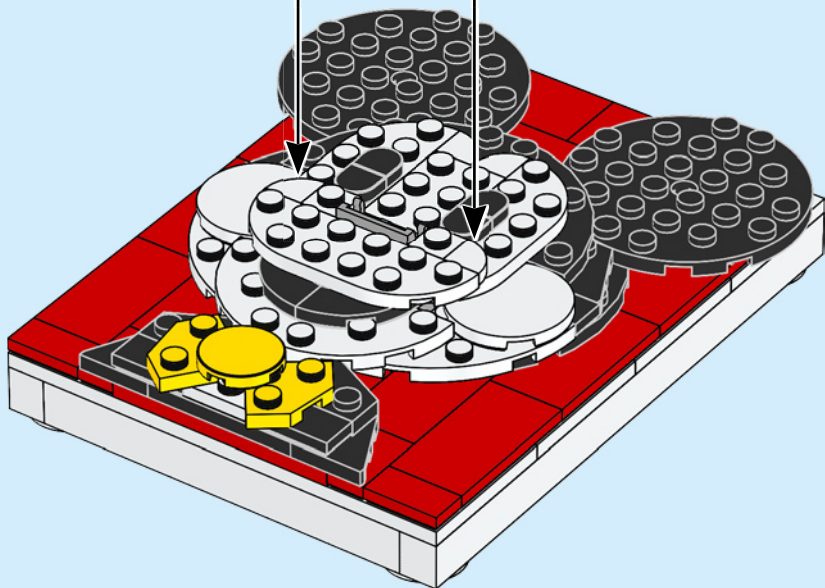

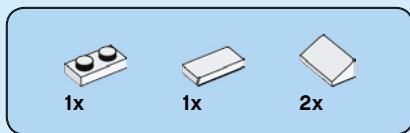

36

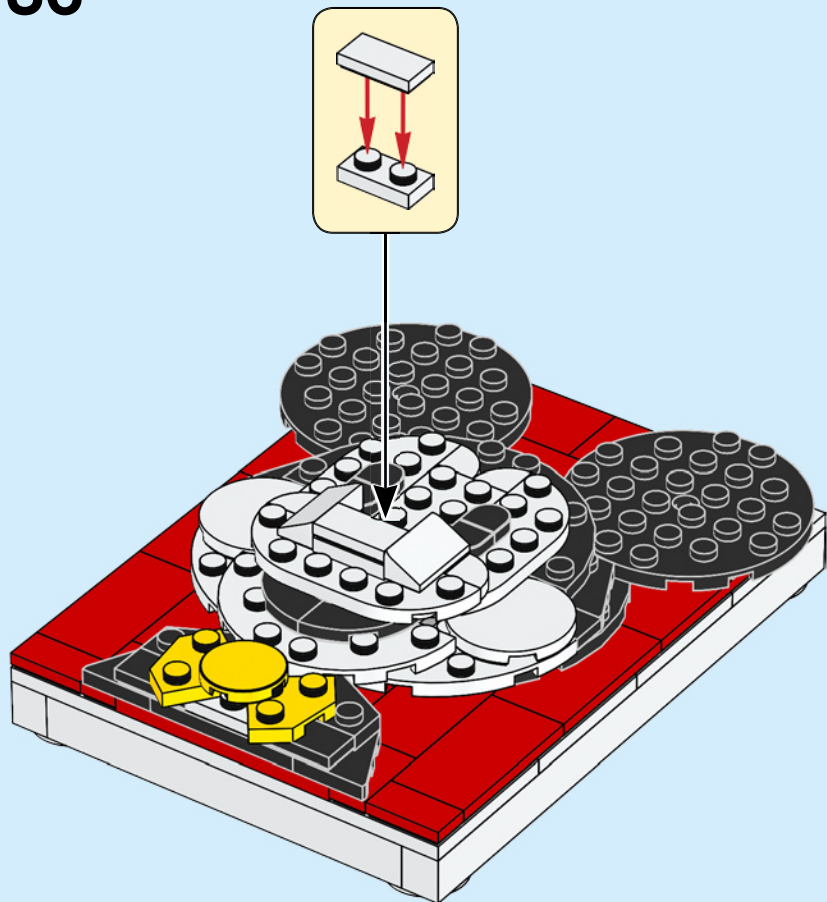

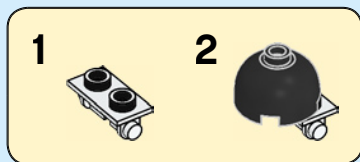
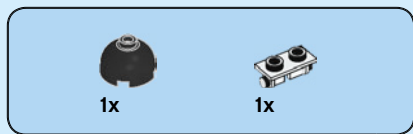

37

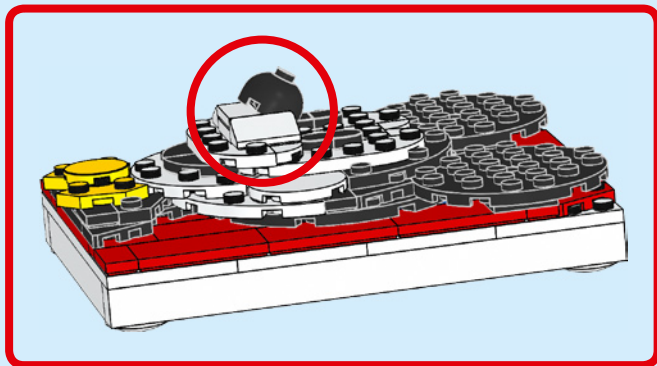
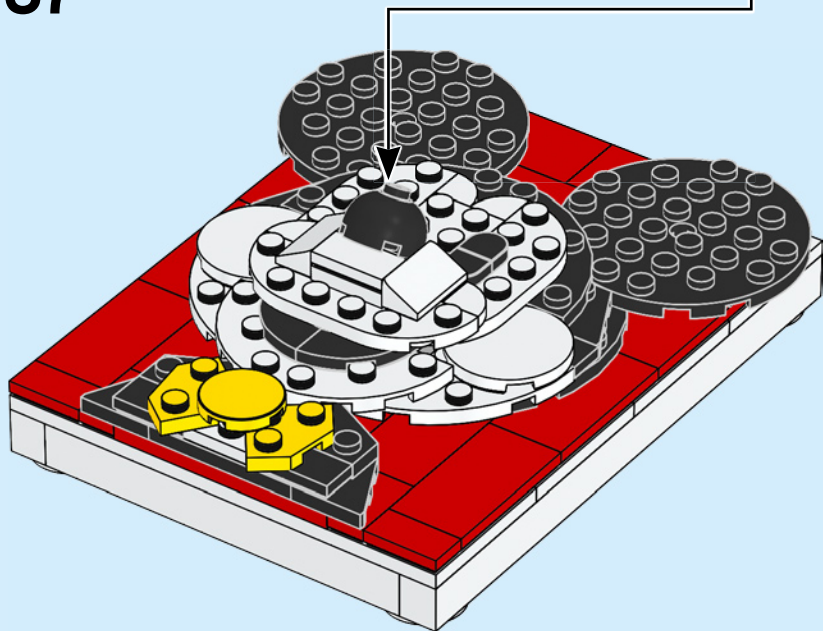

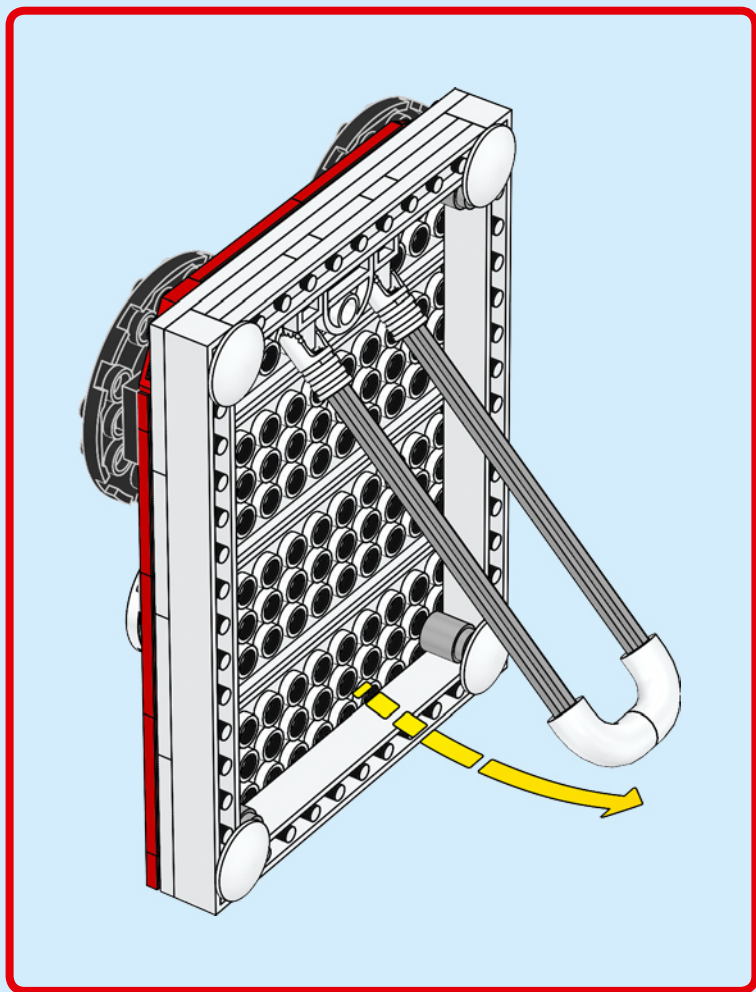

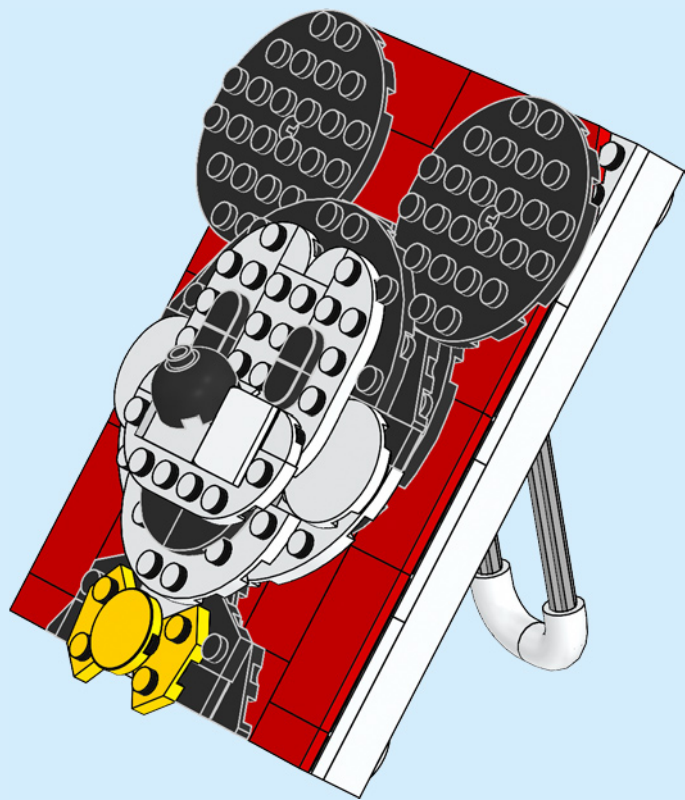

2x 302401
 4x 6172366
 2x 4547489
 4x 4278271
 2x 6194851
 2x 6271540
 1x 6051511
 1x 393801
 1x 302301
 1x 306901
 2x 6266219
 1x 306801
 2x 6300017
 2x 362301
 1x 6089696

2x 302101
 3x 6147792
 2x 6192352
 2x 4178429
 1x 611101
 2x 447701
 4x 4168072
 2x 246501
 2x 6178172
 1x 383224
 2x 303423

11

2x 6141553
 1x 4142865
 8x 306921
 11x 4560179
 1x 379521
 1x 6248971
 1x 6078279
 2x 6195184
 2x 6187587
 3x 6133200

2x 6192346
 2x 6191630
 2x 4531412
 3x 302026
 1x 403223
 1x 4560180
 1x 4211445
 1x 6079461
 2x 4211481

4x 6256435
 3x 6141554
 3x 6141556
 1x 4216660
 4x 306926
 4x 4211412
 1x 4211469



Customer Service
Kundenservice
Service Consommateurs
Servicio Al Consumidor
LEGO.com/service or dial

: 00800 5346 5555
 : 1-800-422-5346

WIN

GO TO WWW.LEGO.COM/PRODUCTFEEDBACK
AND GIVE US YOUR SHORT **FEEDBACK**
ABOUT THIS LEGO® SET FOR A CHANCE
TO WIN A COOL LEGO PRIZE.

Terms & Conditions apply



LEGO.com/productfeedback

GEWINNE

Erzähle uns auf
www.LEGO.com/productfeedback

etwas über die Erfahrungen, die du mit
diesem LEGO® Set gemacht hast, und
sichere dir die Chance auf einen coolen
LEGO Preis!

Es gelten die Teilnahmebedingungen

GAGNE

Rends-toi sur
www.LEGO.com/productfeedback

et donne-nous quelques commentaires
sur ce produit LEGO® pour avoir une
chance de gagner un prix LEGO !

Voir Conditions Générales

GANA

Visita
www.LEGO.com/productfeedback

y envíanos tu opinión acerca de este
set LEGO®. ¡Participarás en el sorteo
de un premio LEGO!

Términos y Condiciones aplicables

获取奖品

登录
www.LEGO.com/productfeedback

给出关于此乐高®套装的简短反馈，
就有机会获得炫酷乐高奖品

《条款及条件》适用

경품 당첨 기회

www.LEGO.com/productfeedback

페이지로 이동하여 이 레고® 세트에 대한
간략한 피드백을 보내 주시고 멋진 레고
경품을 탈 수 있는 기회도 잡으십시오

약관 적용

ЗАПОЛНИ АНКЕТУ И ПОЛУЧИ ПРИЗ

Перейди по ссылке
www.LEGO.com/productfeedback

ответь всего на несколько во-
просов об этом наборе LEGO®,
и у тебя появится шанс выиграть за-
мечательный приз от компании LEGO.

Применяются Условия и правила
участия

LEGO and the LEGO logo are trademarks of the/son des marques de commerce du/
son marcas registradas de LEGO Group. ©2021 The LEGO Group.



©Disney
www.disney.com

6355621