



BRICK HEADZ

40379



 [LEGO.com/brickheadz](https://www.LEGO.com/brickheadz)

OSO OURS BEAR

97



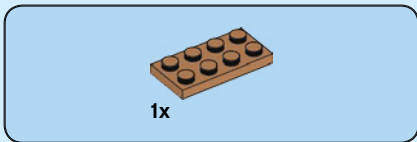
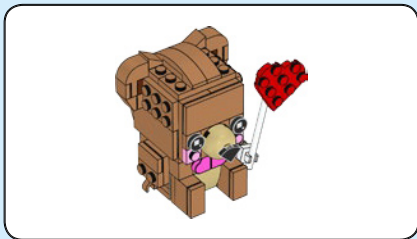

1

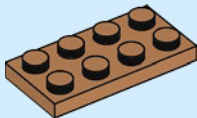

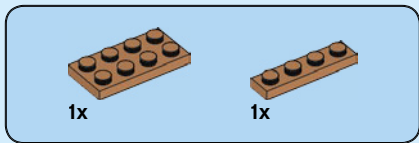

2

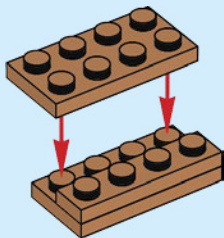

4

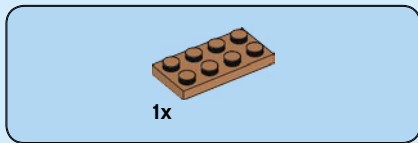

3

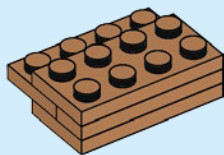



4

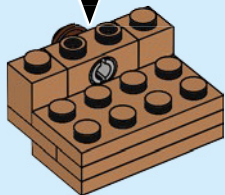
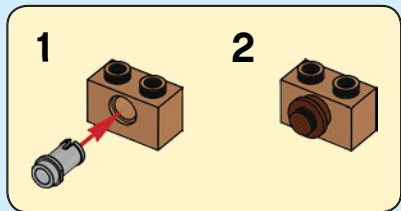



1x



2x

5

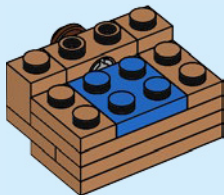

6



1x



2x



2x

6

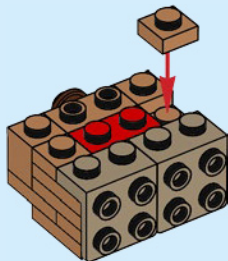



2x

7

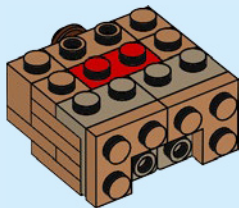

1x

8

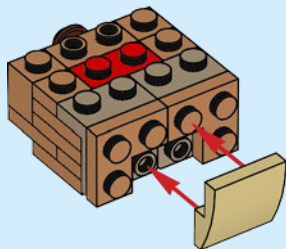



2x



2x

9

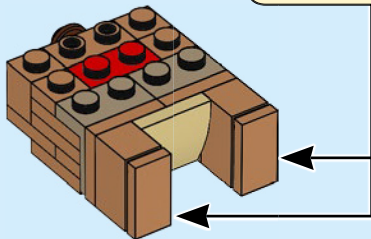
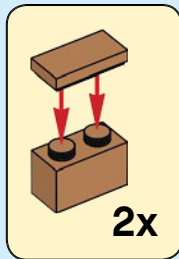

8



1x



2x



2x

10

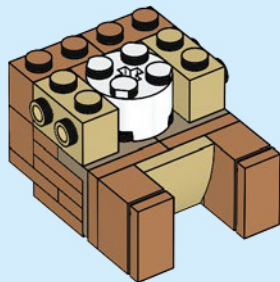



1x



2x



1x

11

1



2

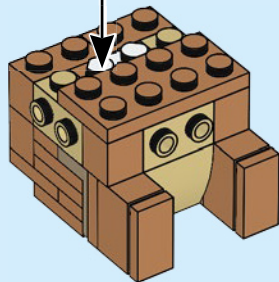
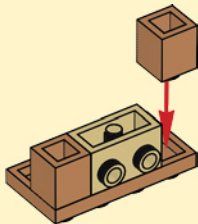



1x



2x

12

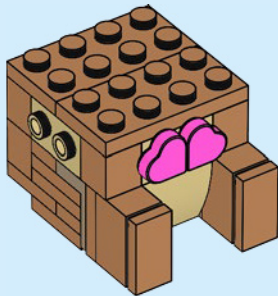



2x



2x



2x

13

1



2



2x

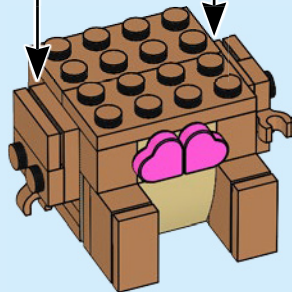



6x

14

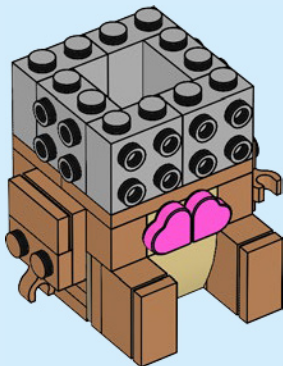

12

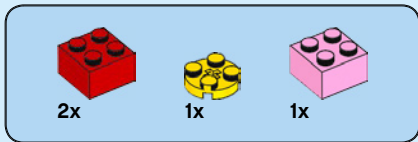

15

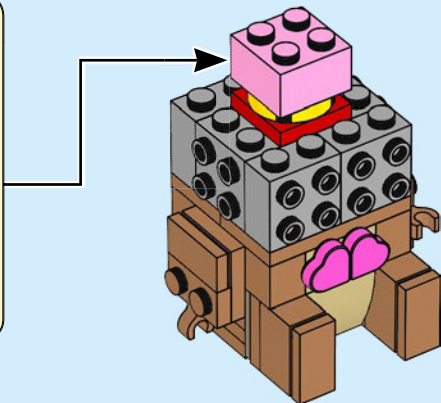
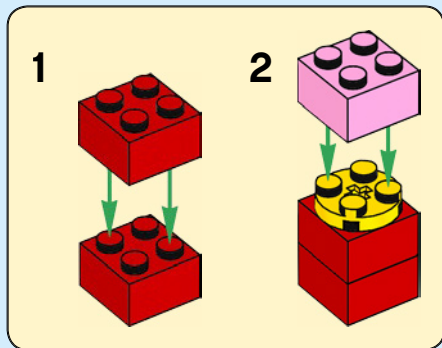



5x



1x

16

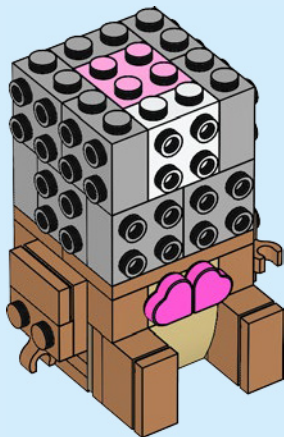



2x

17

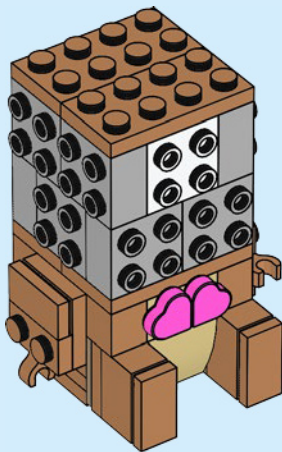



1x

18

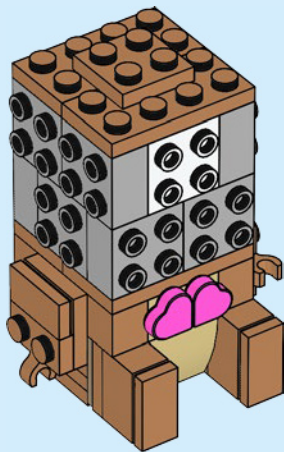

16

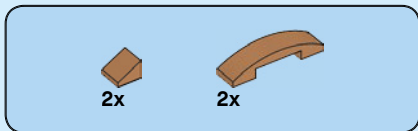

19

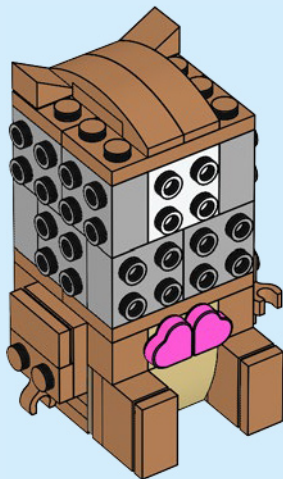

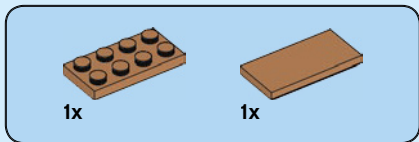

20

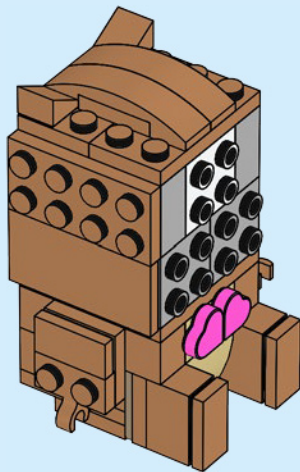

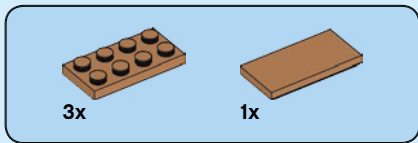

21

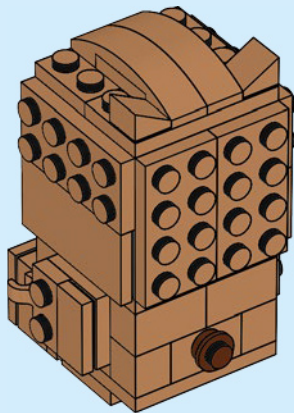



22

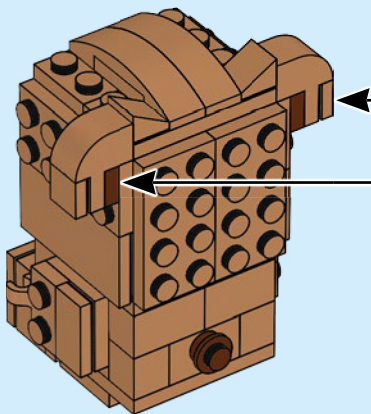
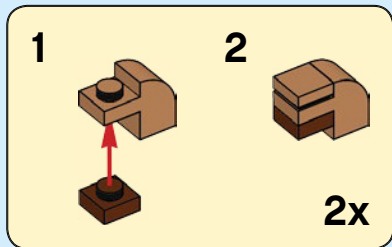



2x



2x

23



2x

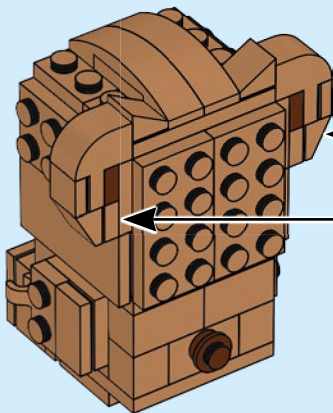



1x

24

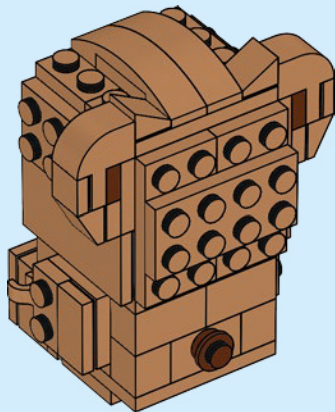

22



4x

25

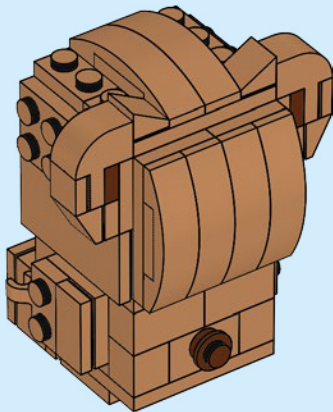



2x

26

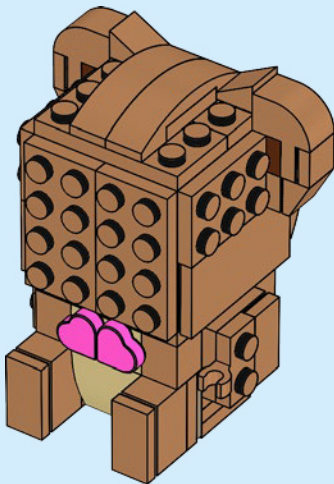
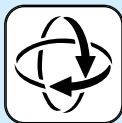

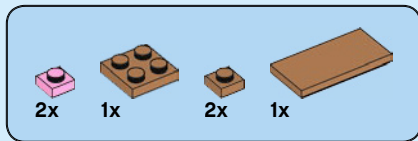

27

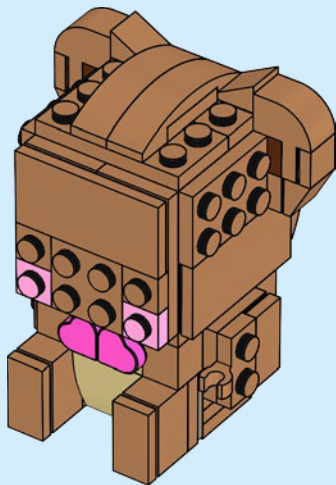



1x



2x

28

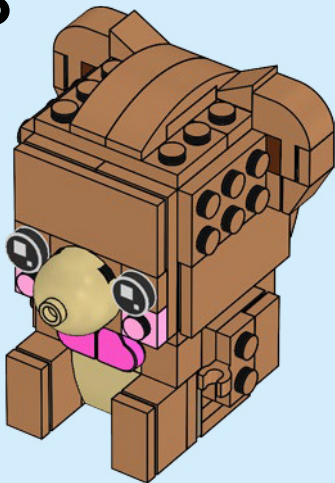

1x

29

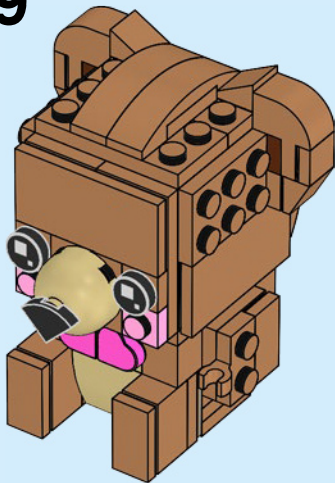



1x



1x

30

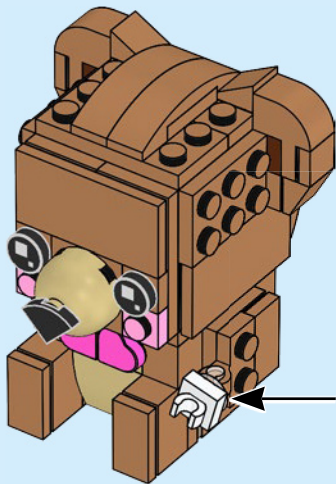

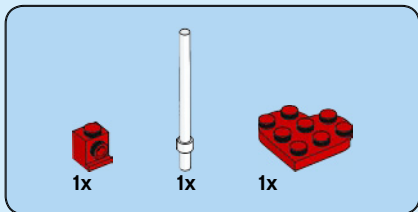

31

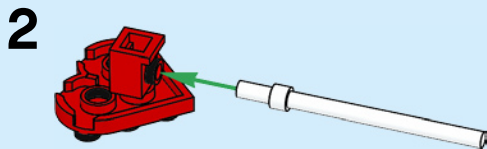
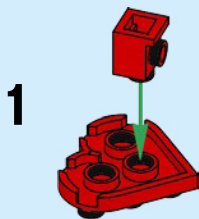

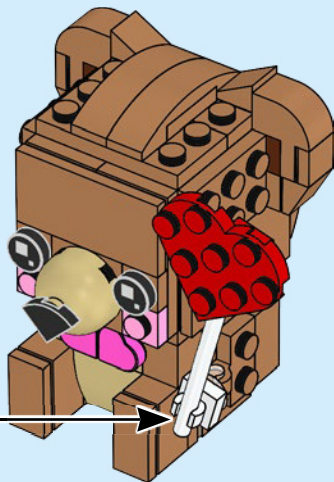

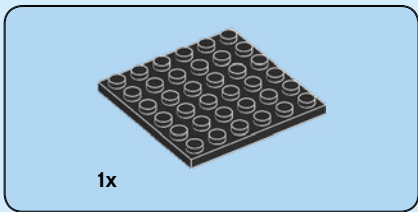
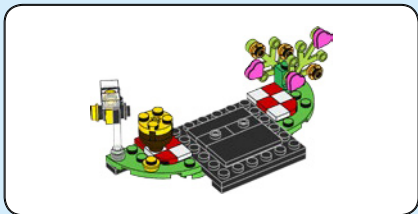

1x

32

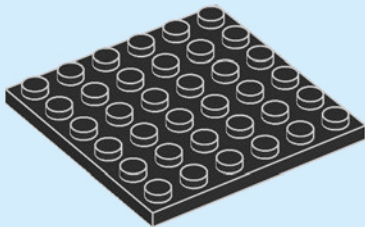

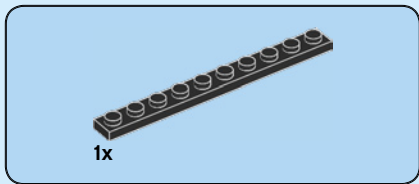

33

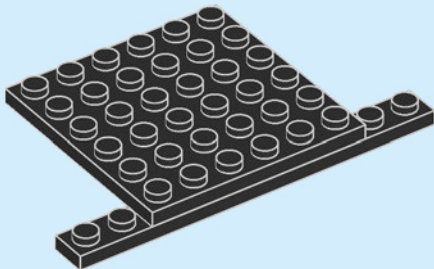

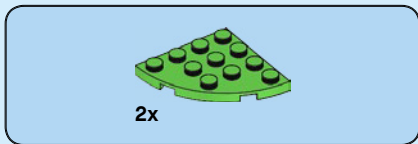

34

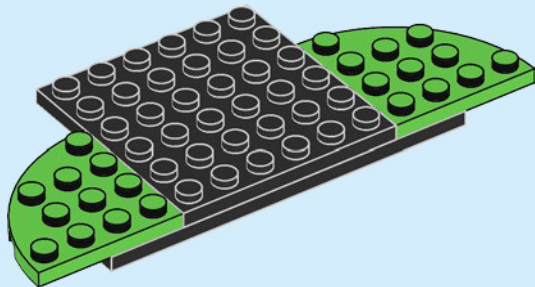

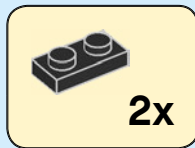
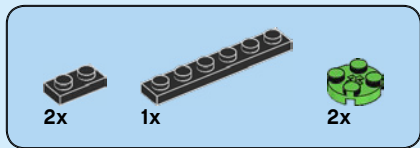

35

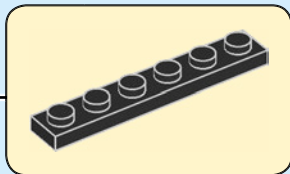
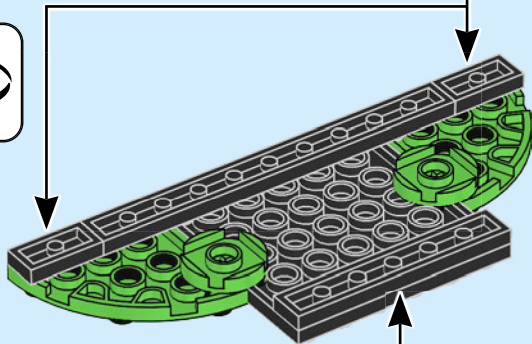
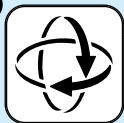

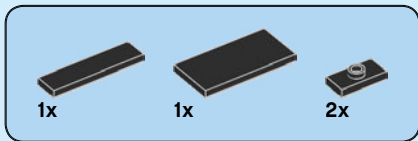

36

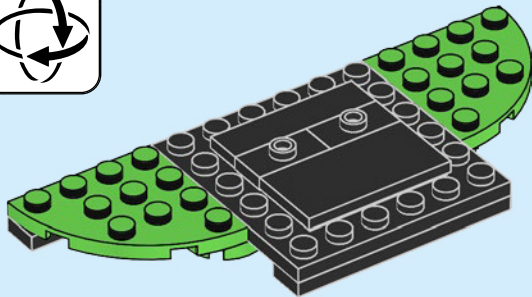

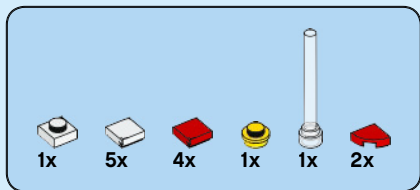

37

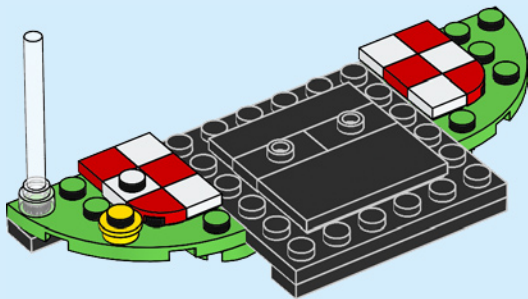

34



1x



1x



1x

38

1

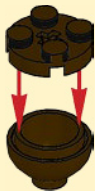

2

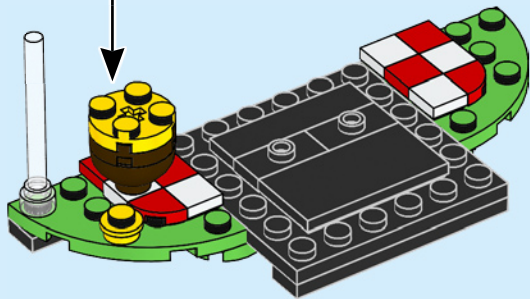



39

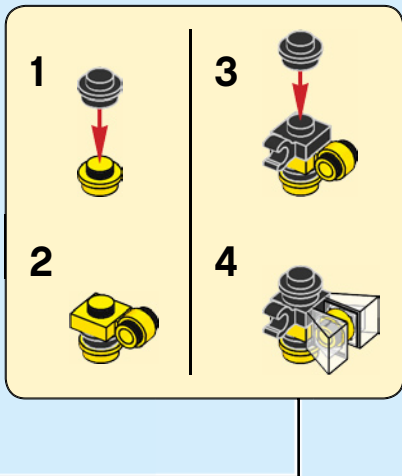
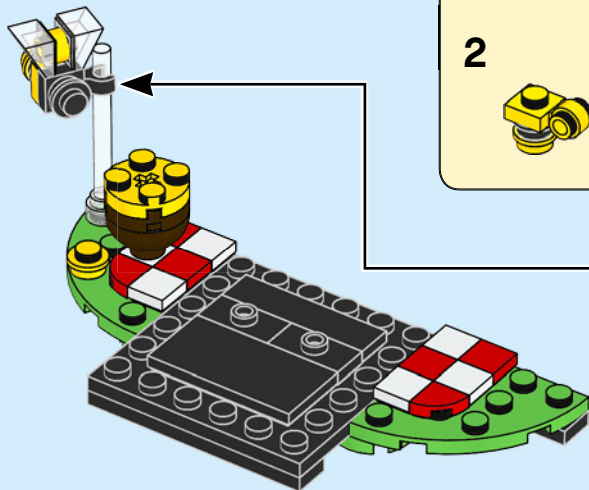



1x



1x

40

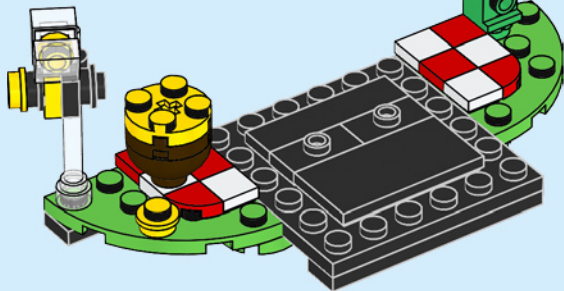

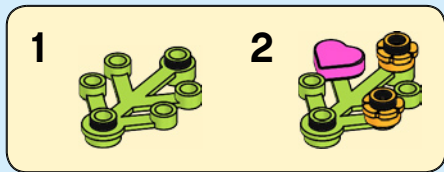
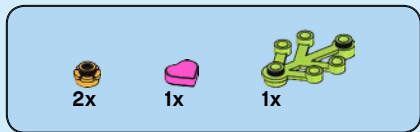

41

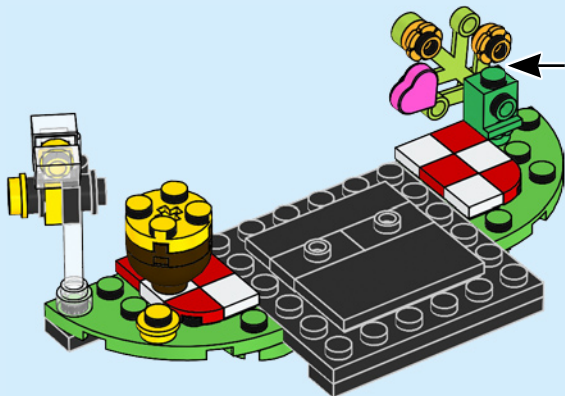

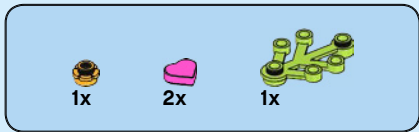

42

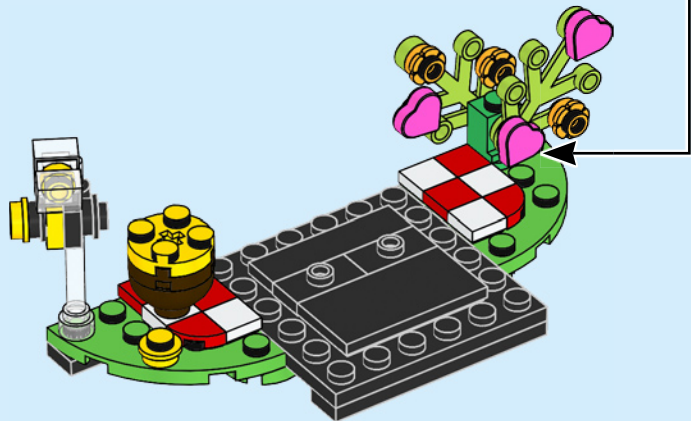
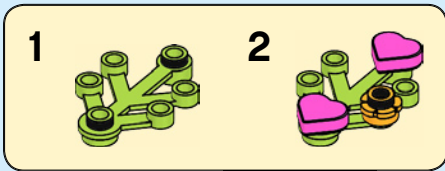

43

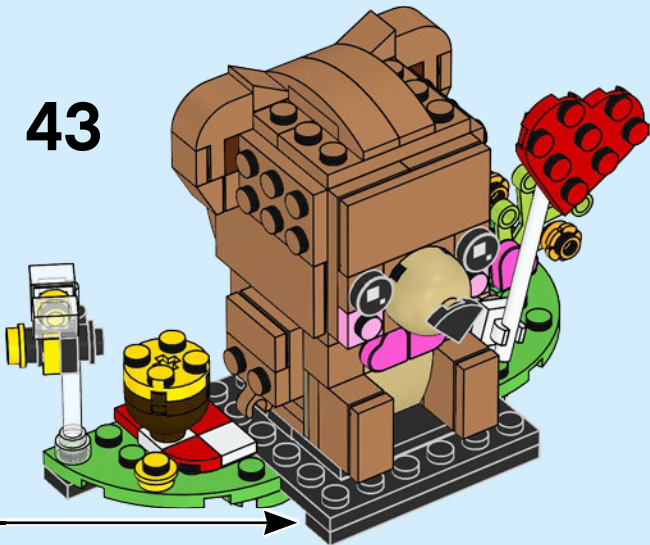



BRICK HEADZ

COMING IN
JANUARY
AND **FEBRUARY**

DISPONIBLE EN
ENERO
Y **FEBRERO**

LANCEMENT EN
JANVIER
ET **FÉVRIER**



OVEJA MOUTON SHEEP

100

GATO DE LA SUERTE CHAT PORTE-BONHEUR LUCKY CAT

96



1x
6170419



1x
302401



1x
6054551



5x
307001



1x
614301



1x
6218823



1x
6191654



3x
6024495



1x
6046924



1x
407021



4x
307021



2x
6170390



1x
302321



2x
300321



1x
6276193



1x
302223



2x
614124



2x
403224



1x
4632569



2x
6092585



1x
447726

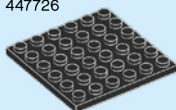

1x
395826



1x
366626



1x
4560182



1x
243126



2x
6070506



2x
6284077



2x
614126



1x
6172383



1x
4517925



2x
302326



1x
6135287



1x
4187334



2x
6138624



1x
6166111



1x
6153264



2x
6245250



2x
6268818



2x
6275485



3x
6209681



1x
4216581



2x
4221744



1x
4211483



11x
6123809



5x
6256130



2x
6031883



1x
4550359



1x
4623298



1x
6174246



4x
6057986



2x
6177535



4x
4569382



4x
6021997



2x
6218360



2x
6293458



2x
6177146



4x
6167690



3x
6218359



2x
6167645



4x
6056383



14x
6093494



1x
6192920



1x
6167700



6x
6273854



6x
6215606



Customer Service

Kundenservice

Service Consommateurs

Servicio Al Consumidor

LEGO.com/service or dial



: 00800 5346 5555

: 1-800-422-5346

WIN

GO TO WWW.LEGO.COM/PRODUCTFEEDBACK AND
GIVE US YOUR SHORT **FEEDBACK** ABOUT THIS
LEGO® SET FOR A CHANCE TO WIN
A COOL LEGO PRIZE.

Terms & Conditions apply



LEGO.com/productfeedback

GEWINNE

Erzähle uns auf
www.LEGO.com/productfeedback

etwas über die Erfahrungen, die du
mit diesem LEGO® Set gemacht hast,
und sichere dir die Chance auf einen
coolen LEGO Preis!

Es gelten die Teilnahmebedingungen

GAGNE

Rends-toi sur
www.LEGO.com/productfeedback

et donne-nous quelques commen-
taires sur ce produit LEGO® pour
avoir une chance de gagner un
prix LEGO !

Voir Conditions Générales

GANAN

Visita
www.LEGO.com/productfeedback

y envíanos tu opinión acerca de este
set LEGO®, ¡Participarás en el sorteo
de un premio LEGO!

Términos y Condiciones aplicables

获取奖品

登录
www.LEGO.com/productfeedback

给出关于此乐高®套装的简短反
馈，就有机会获得炫酷乐高奖品

《条款及条件》适用

LEGO and the LEGO logo are trademarks of the/sont des marques de commerce du/
son marcas registradas de LEGO Group. ©2020 The LEGO Group.

6309015