

HEROICA™



ILRION

3874

LEGO



1



2

2

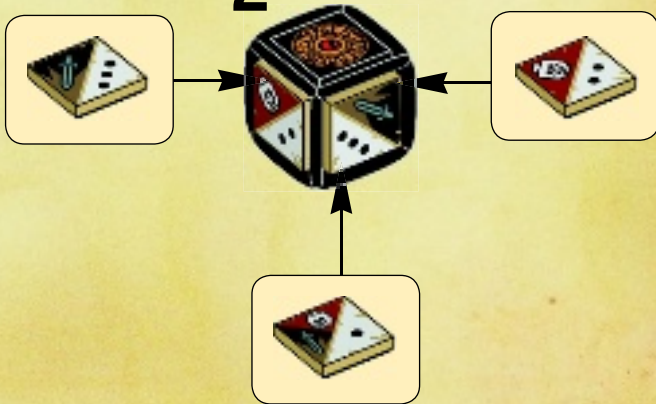



1

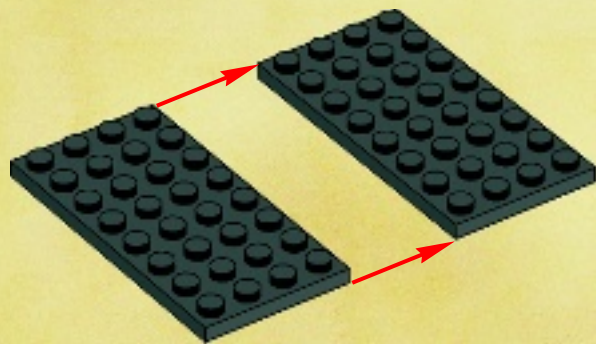



2

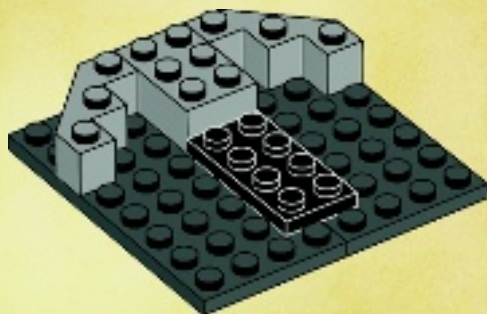

3

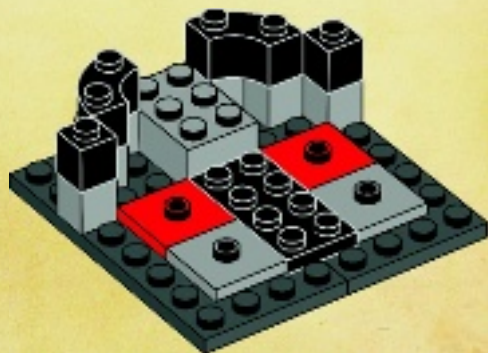



4x



2x

6

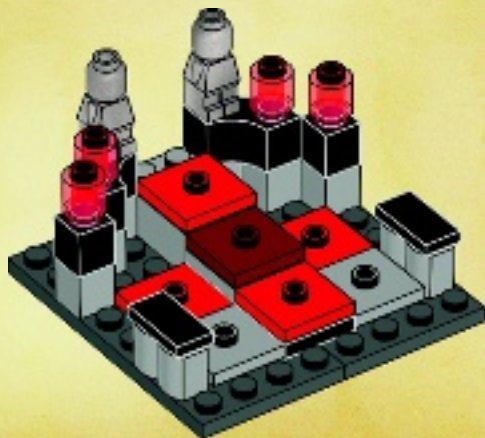

6



2x



2x



1x



1x

7

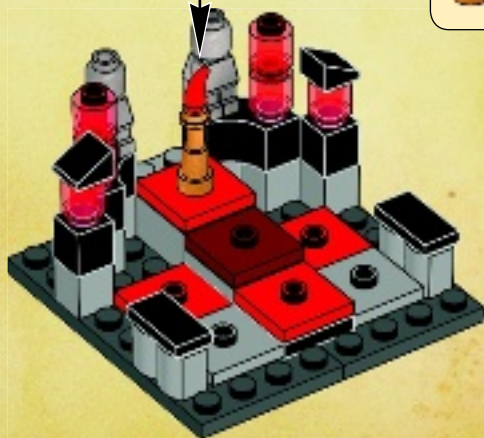



2x

8

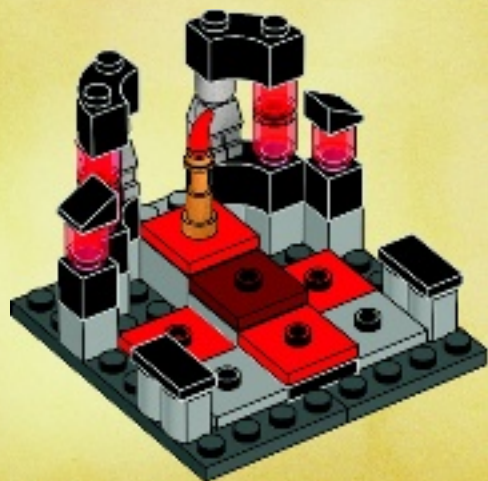

1x



1x

9

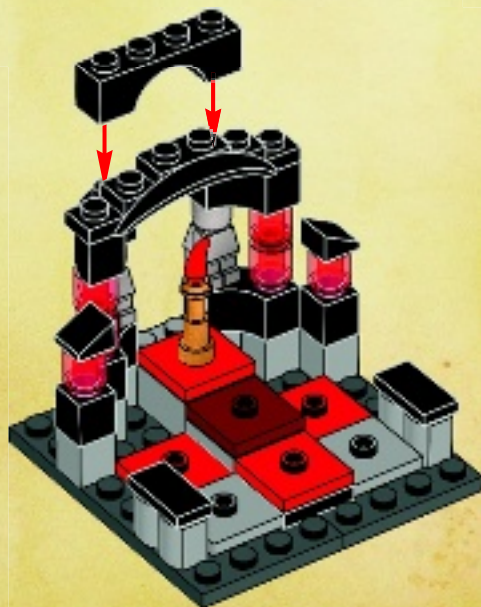

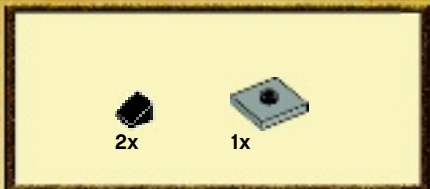

10

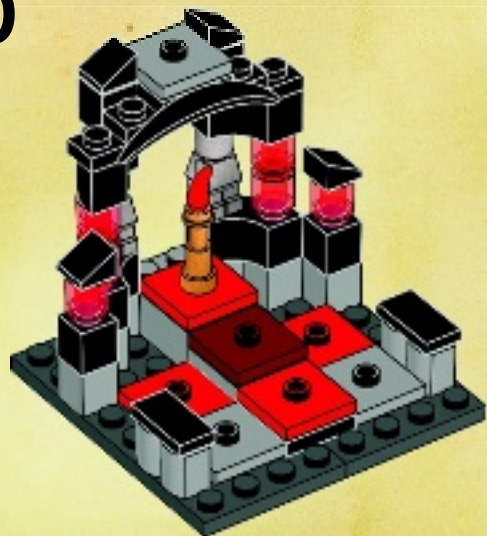

11

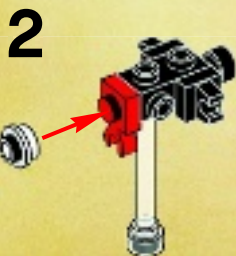
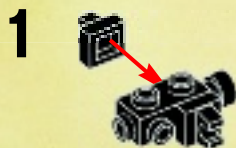

3



4

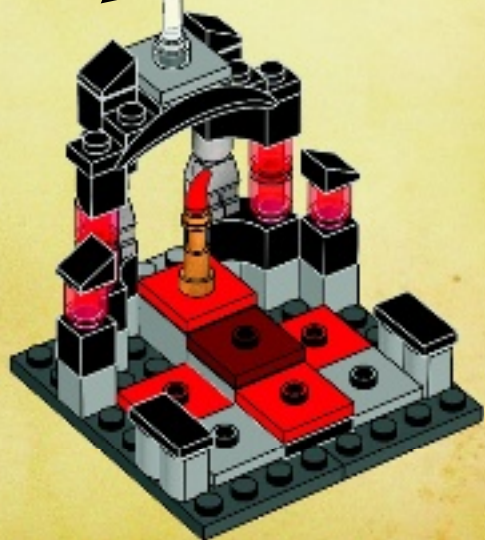



1x

1



1x



2x



1x

2

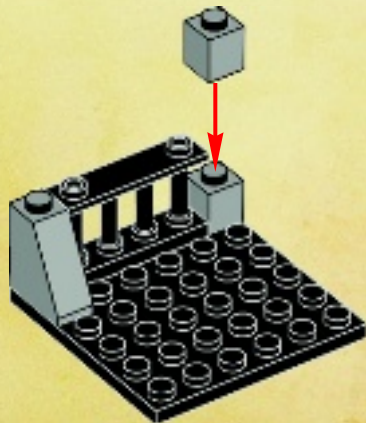



3

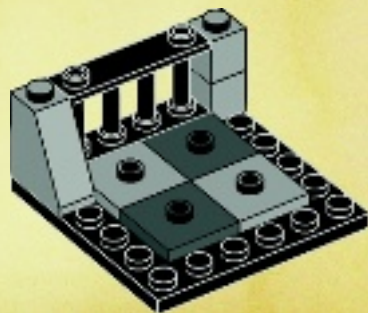

4

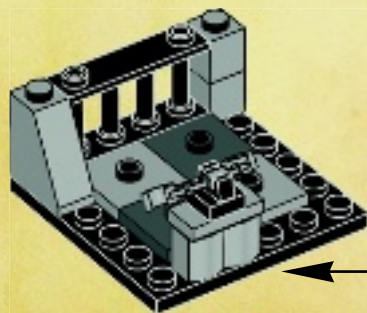
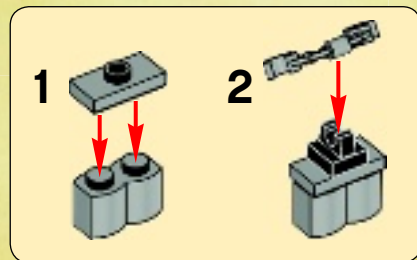



2

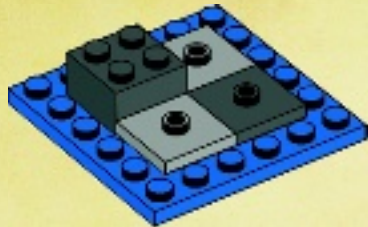

3



2x

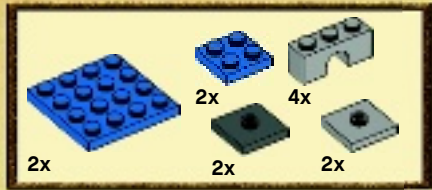

1

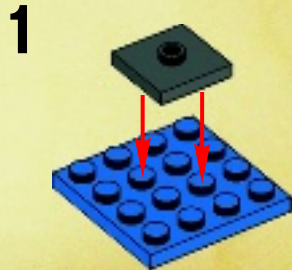

2

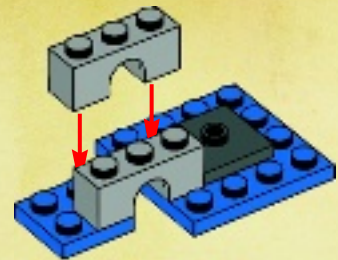

3

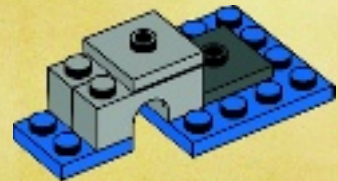

2x

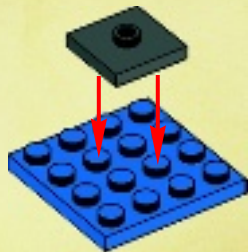

3x

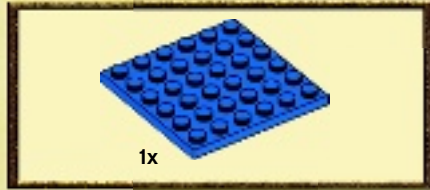

1





2

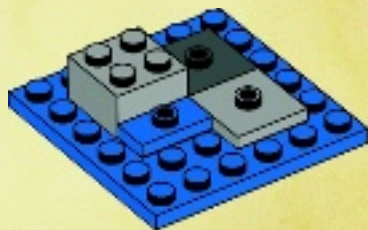

3





2x



2x

4

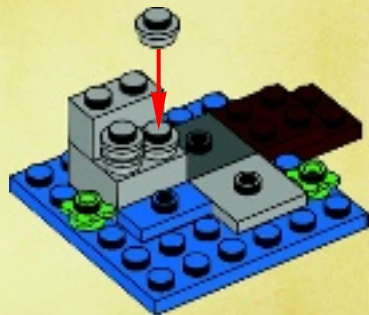

1x



1x



1x



1x



1x

5

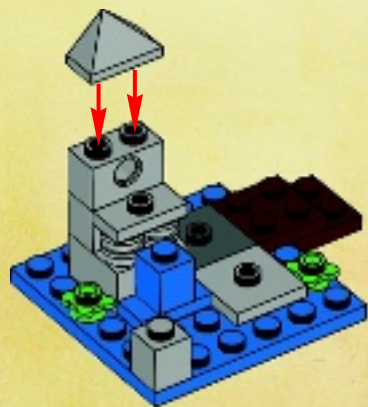



6

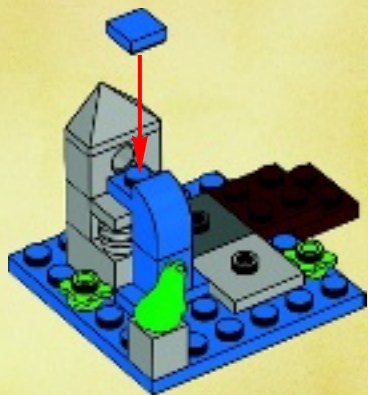

1

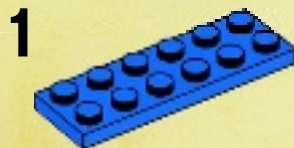

2

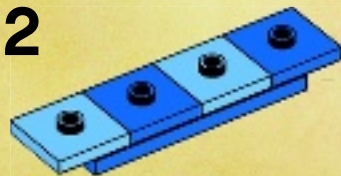

3x

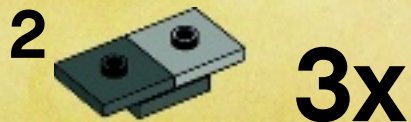



1



2



3

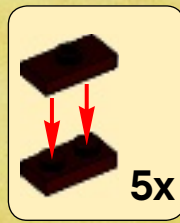

5x



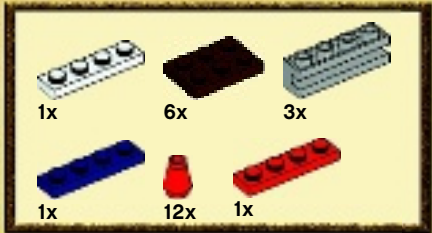

1

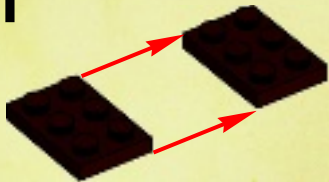

2



3

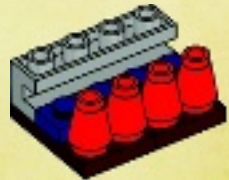

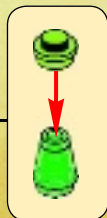
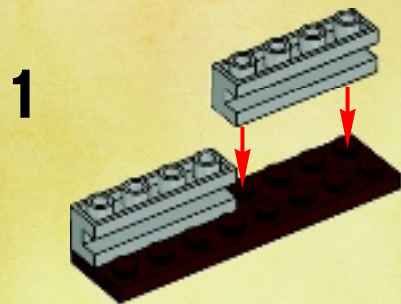

3





Customer Service

Kundenservice

Service Consommateurs

Servicio Al Consumidor

www.lego.com/service or dial



00800 5346 5555 :



1-800-422-5346 :

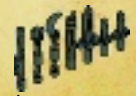

LEGO GAMES

HEROICA™



WWW.LEGO.COM/HEROICA



WIN!

Go to www.LEGOsurvey.com/product to fill out a survey for a chance to win a cool LEGO® Product.

No purchase necessary.

Open to all residents where not prohibited.



www.LEGOsurvey.com/product

GEWINNE!

Nimm an der Umfrage auf www.LEGOsurvey.com/product teil und hab die Chance ein cooles LEGO® Produkt zu gewinnen!

Die Teilnahme am Gewinnspiel führt zu keinerlei Kaufverpflichtungen. Teilnahme in allen nicht ausgeschlossenen Ländern möglich.

WIN!

Ga naar www.LEGOsurvey.com/product, vul een enquêteformulier in en maak kans op een cool LEGO® product.

Geen aankoopverplichting. Iedereen mag deelnemen, uitgezonderd ingezetenden van landen waar een enquêteverbod geldt.

GAGNE!

Visite www.LEGOsurvey.com/product pour répondre à un questionnaire et avoir une chance de gagner un produit LEGO® très cool!

Aucune obligation d'achat. Ouvert à tous les résidents des pays autorisés.

当てよう!

www.LEGOsurvey.com/product にアクセスして、アンケートにご記入ください。当選者にはレゴ®製品を差し上げます。

お買い上げの必要はありません。禁止されていない限り、すべての皆様にご利用いただけます。



www.LEGO.com

6010546

LEGO, the LEGO logo and HEROICA are trademarks of the LEGO Group. ©2012 The LEGO Group.