

Harry Potter HOGWARTS™

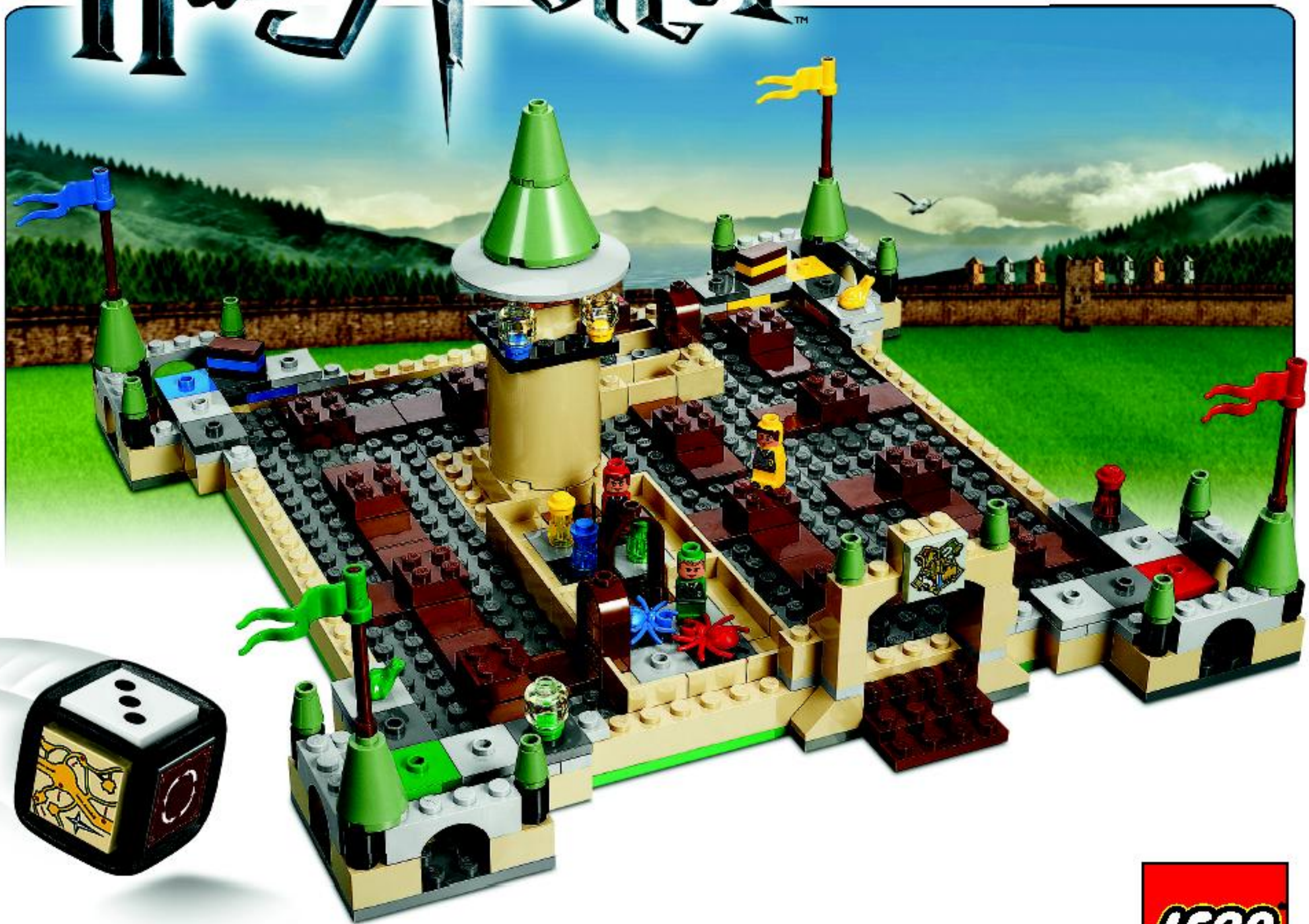

3862



1



2

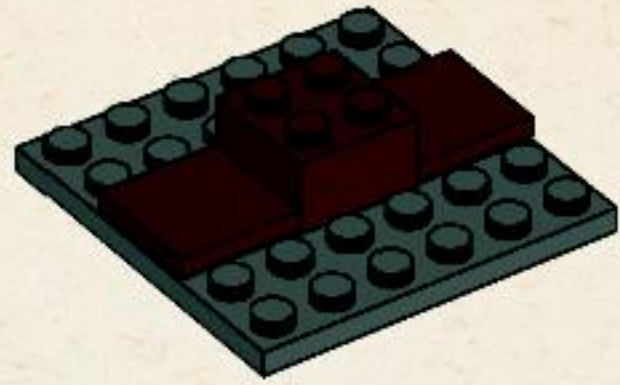

4x

1



2

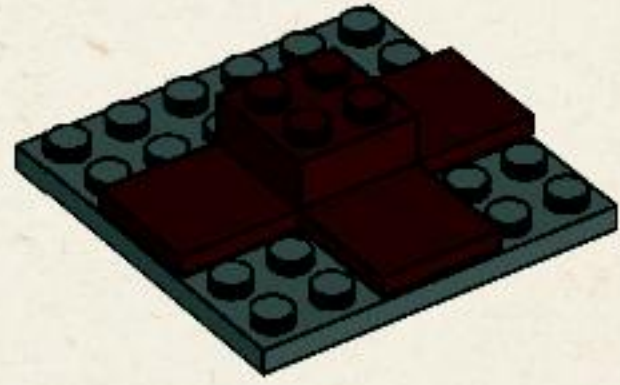

4x

1



2

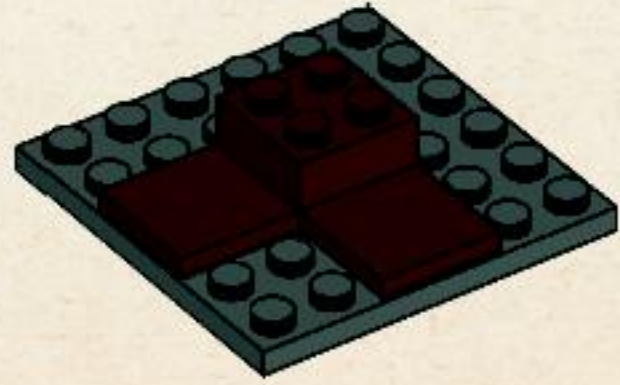

4x

1

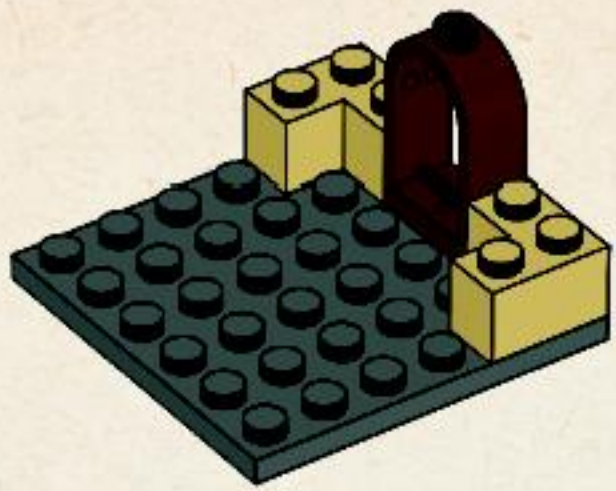

2

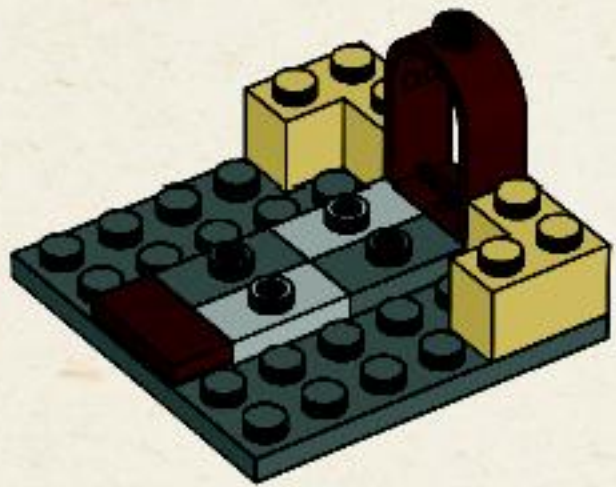

3

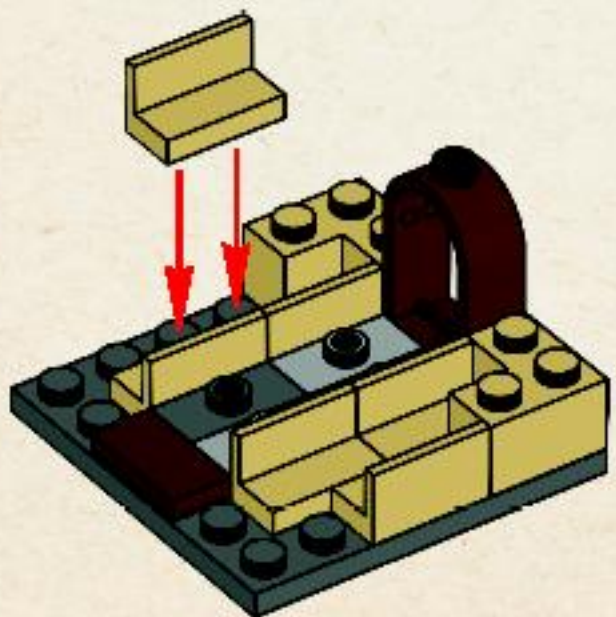

4

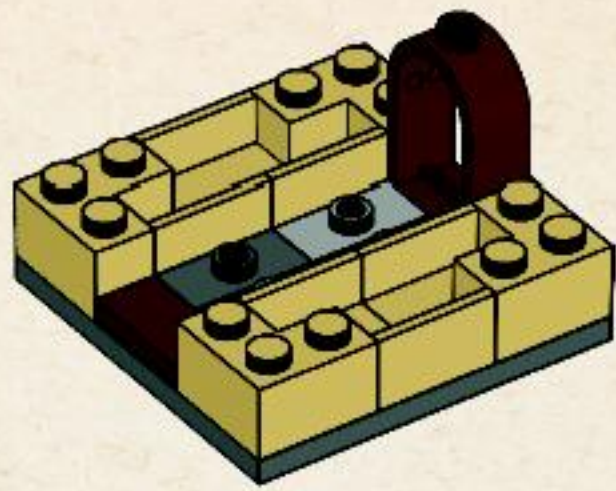

5

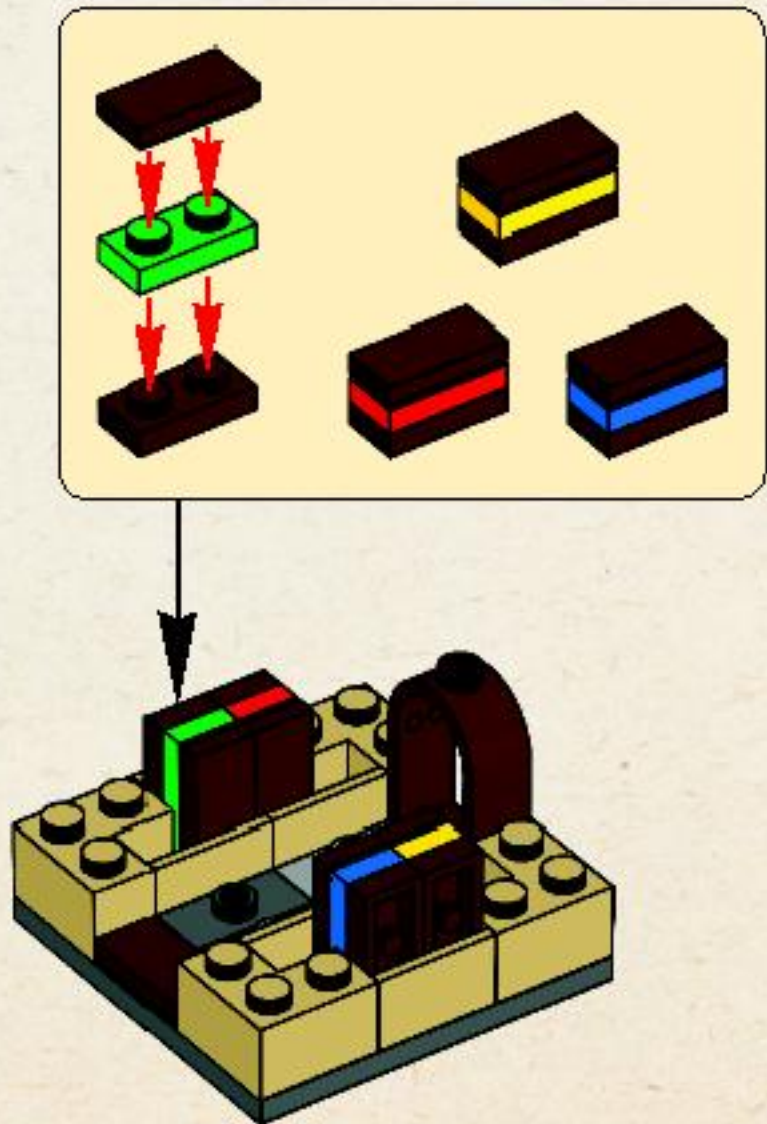

1

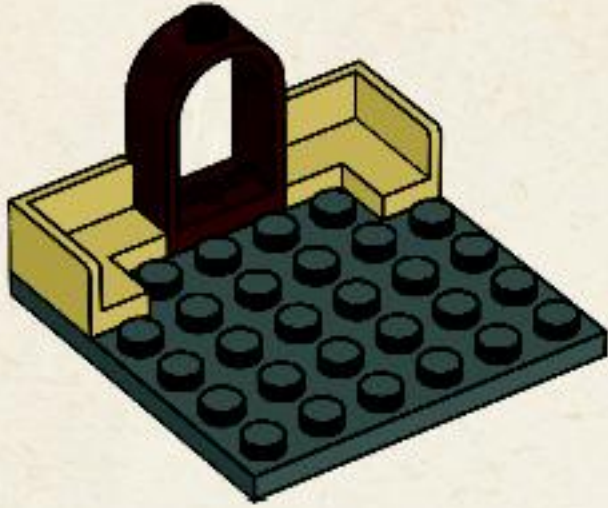

3

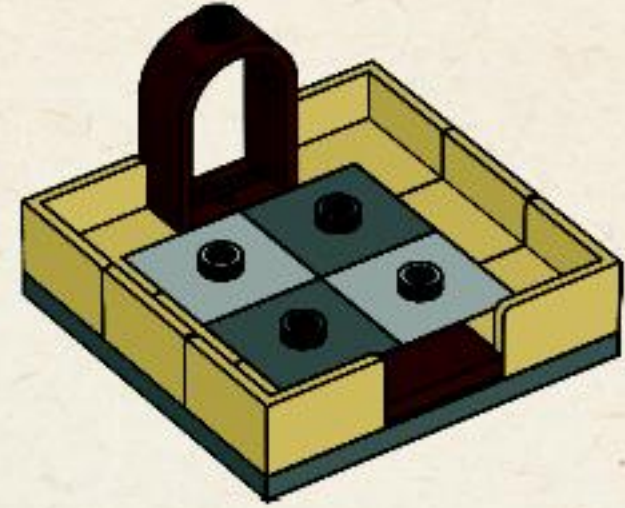

2

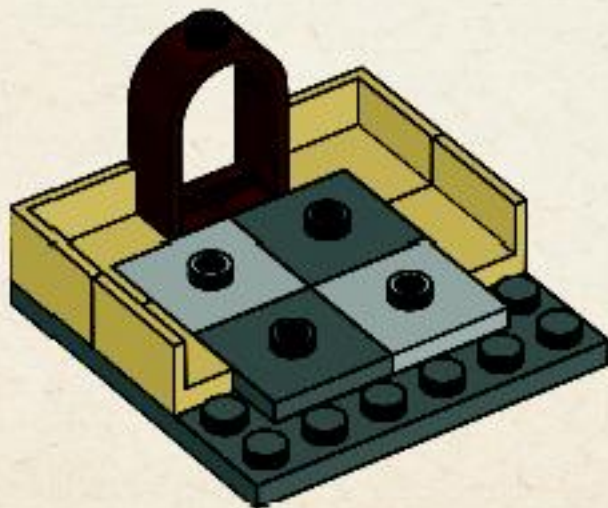

4

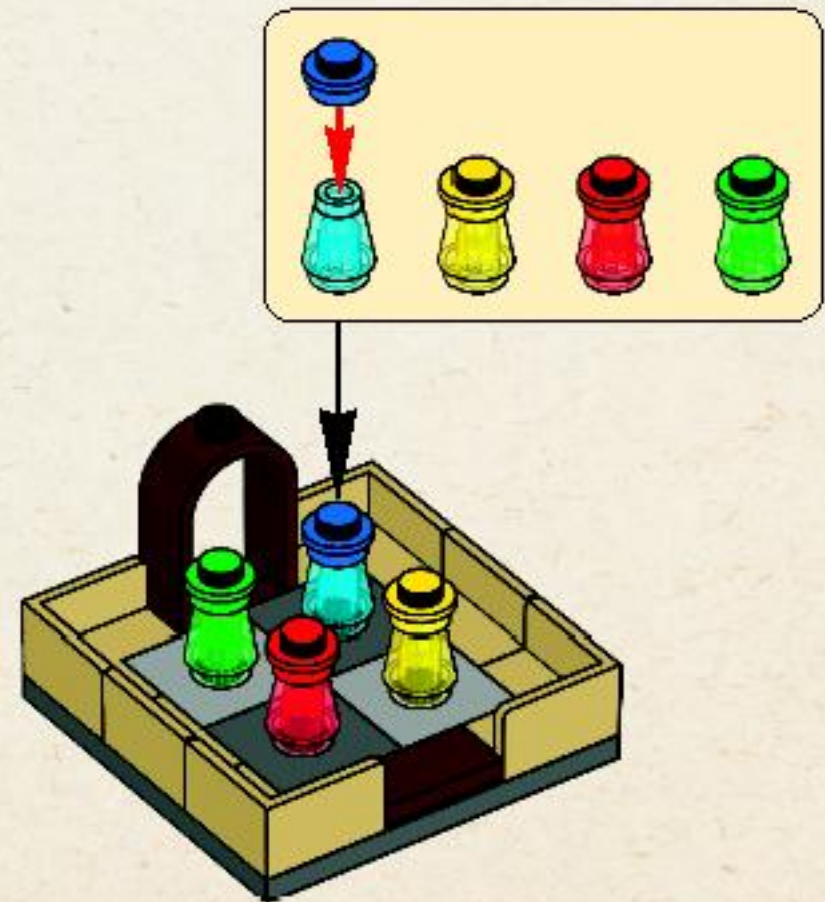

1

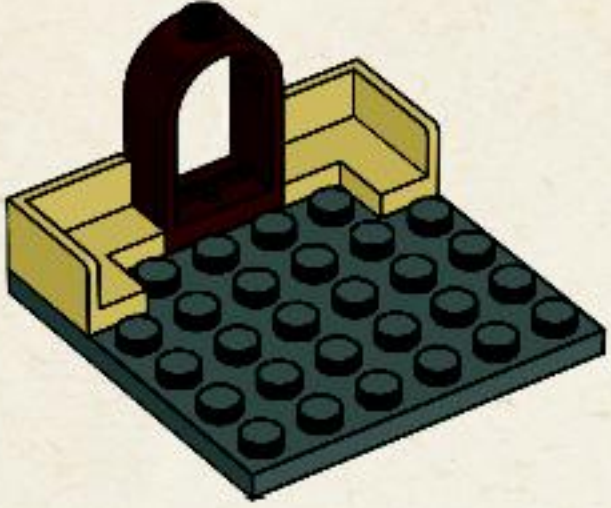

3

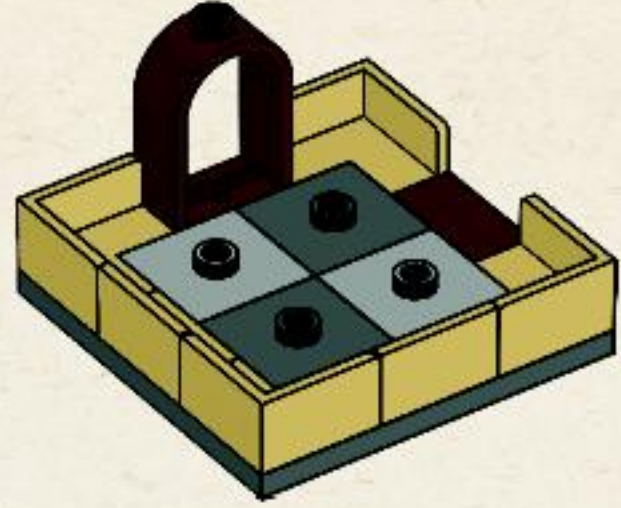

2

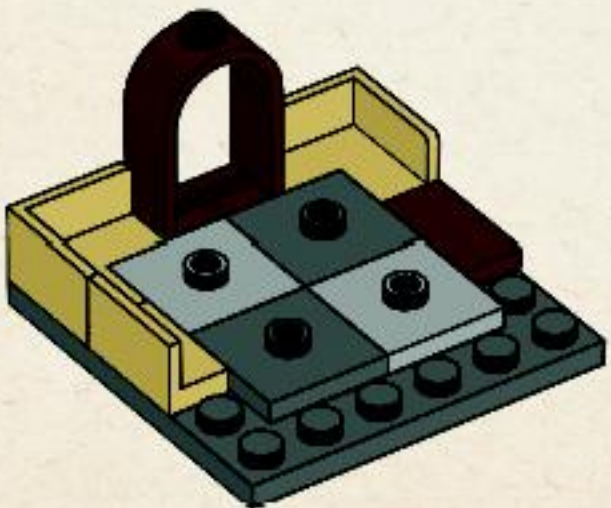

4

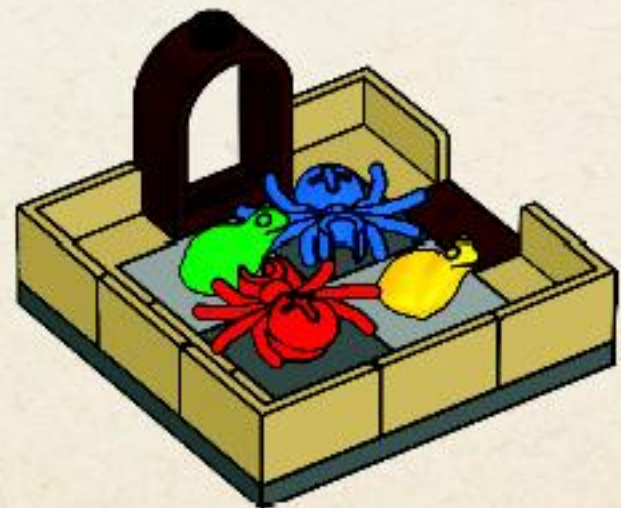

1

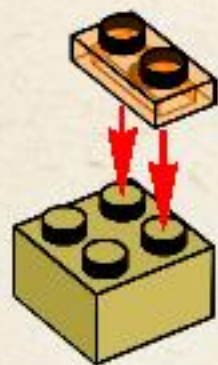

2



3

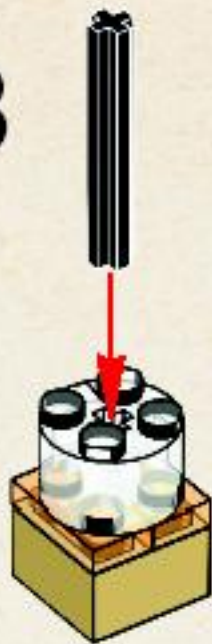

4

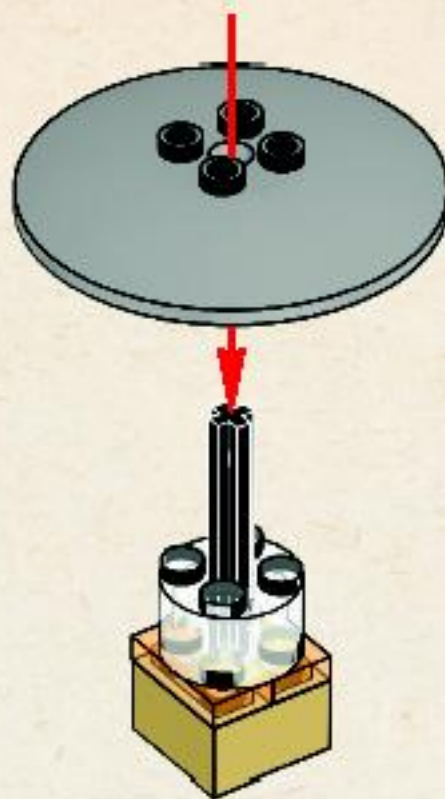

5

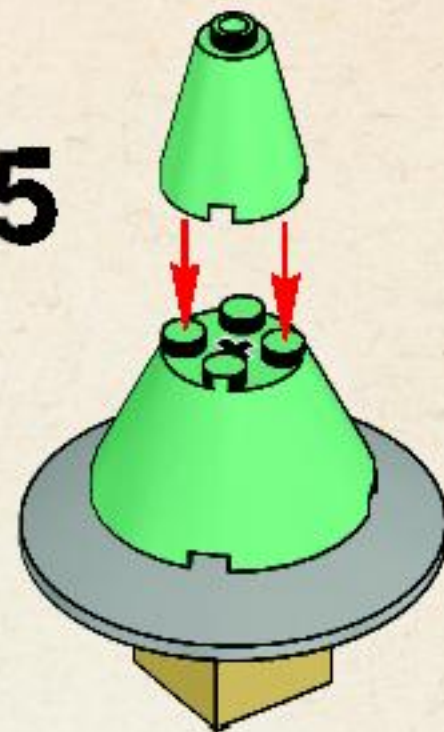

5

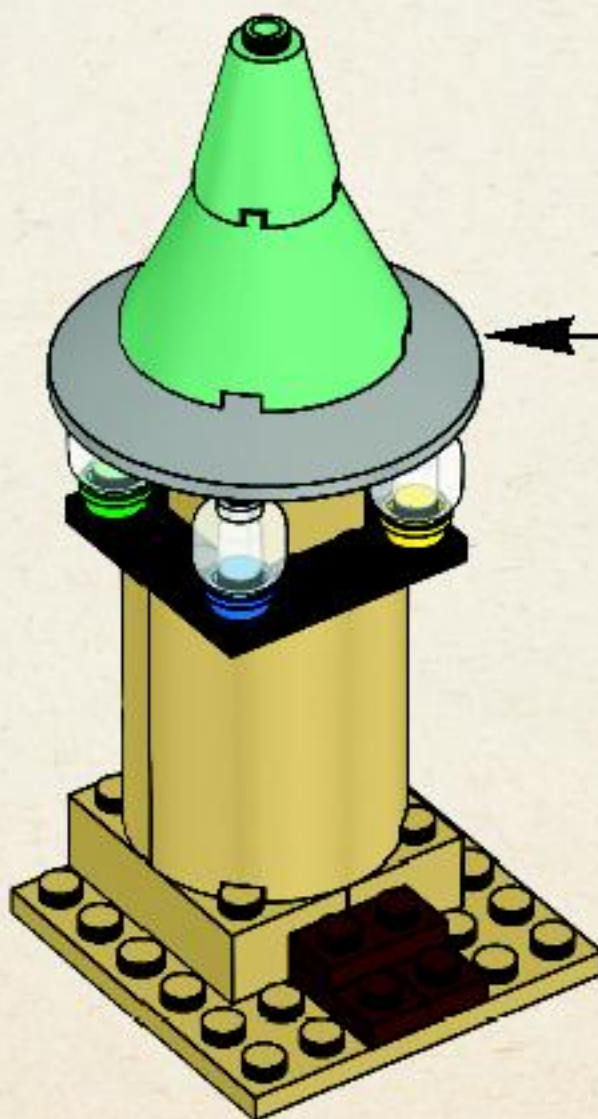

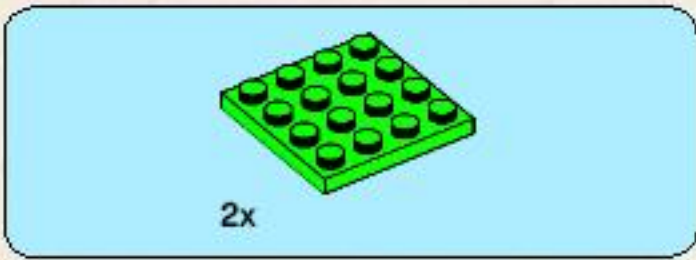
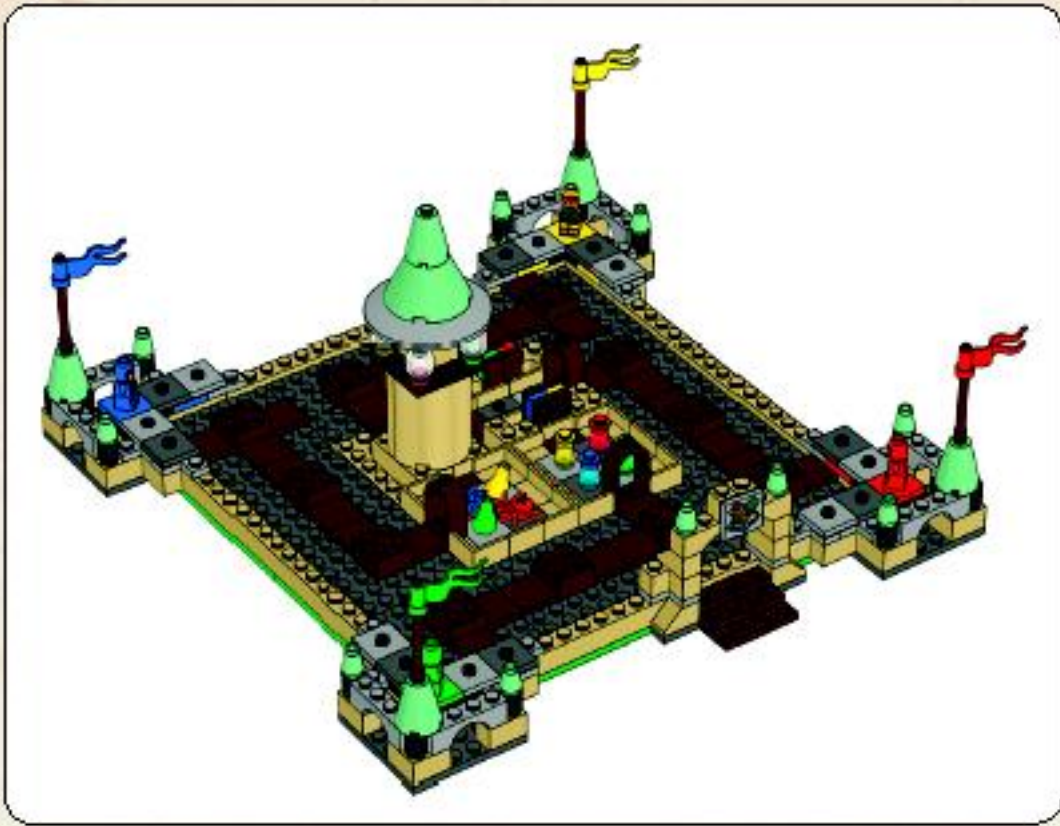

1

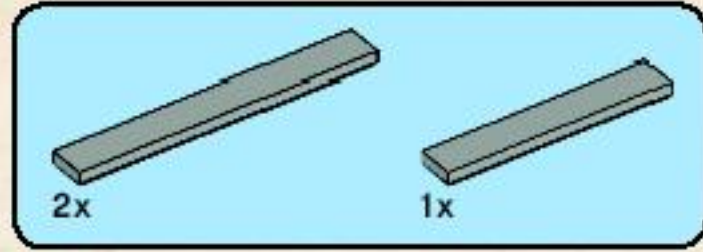
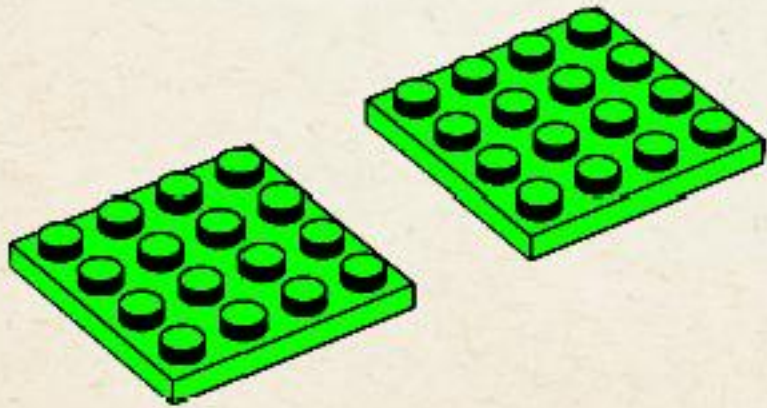

2

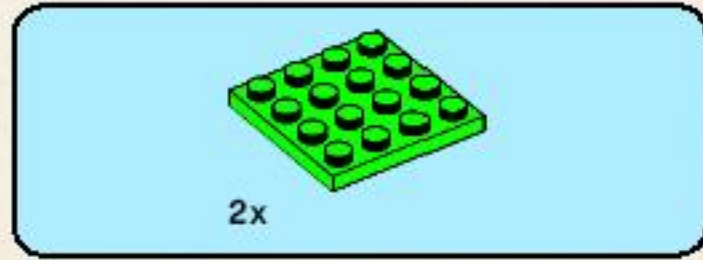
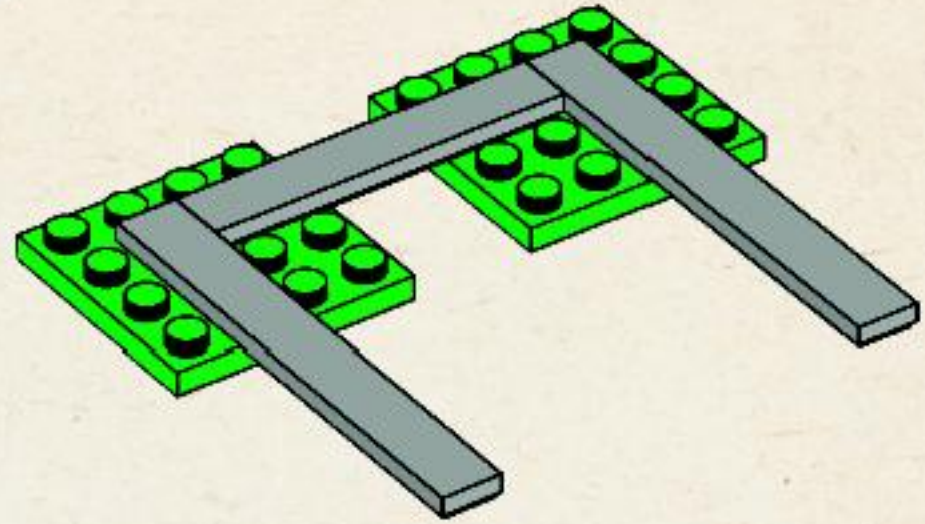

3

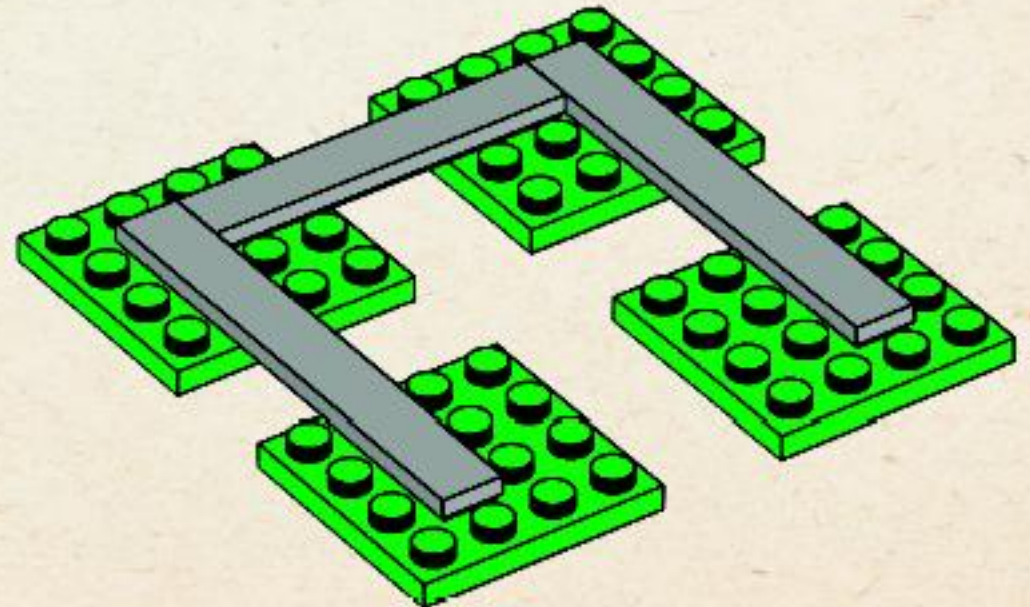

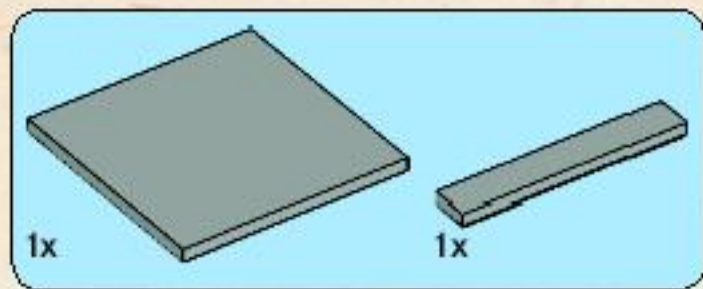

4

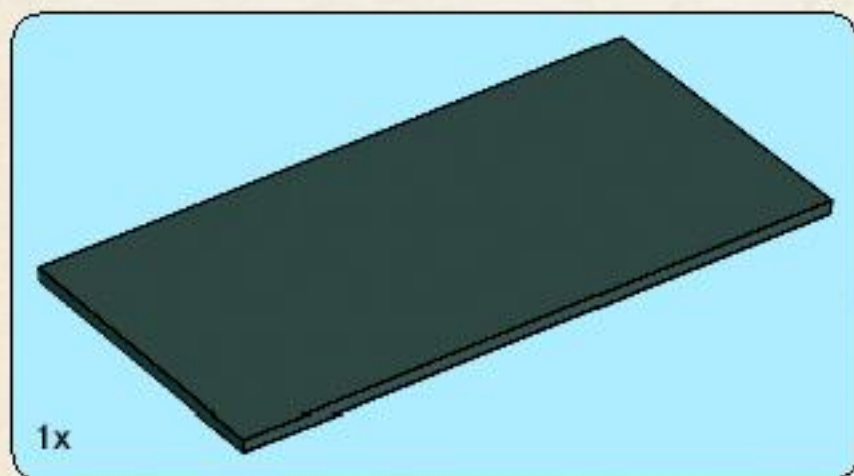
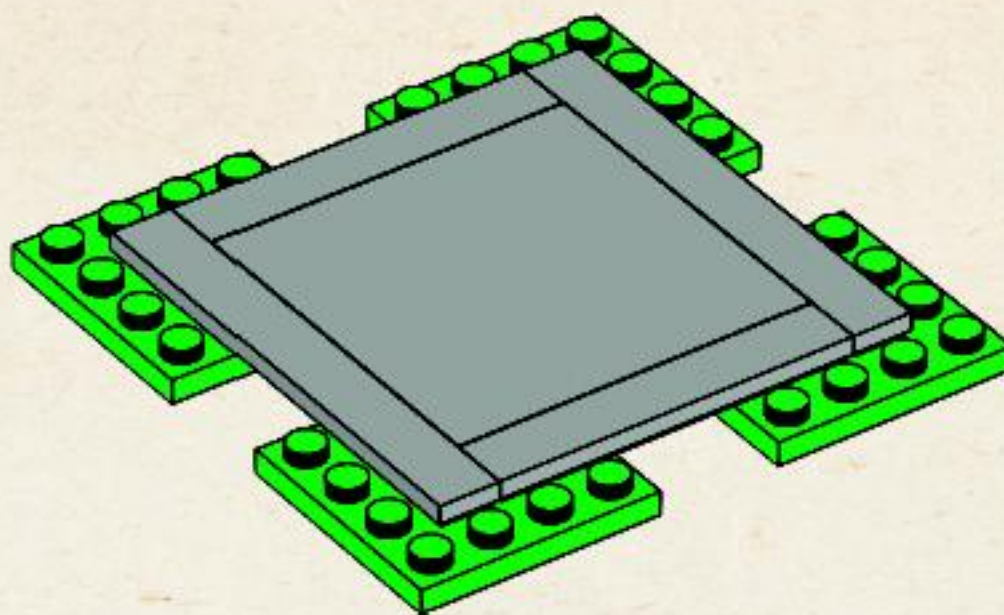

5

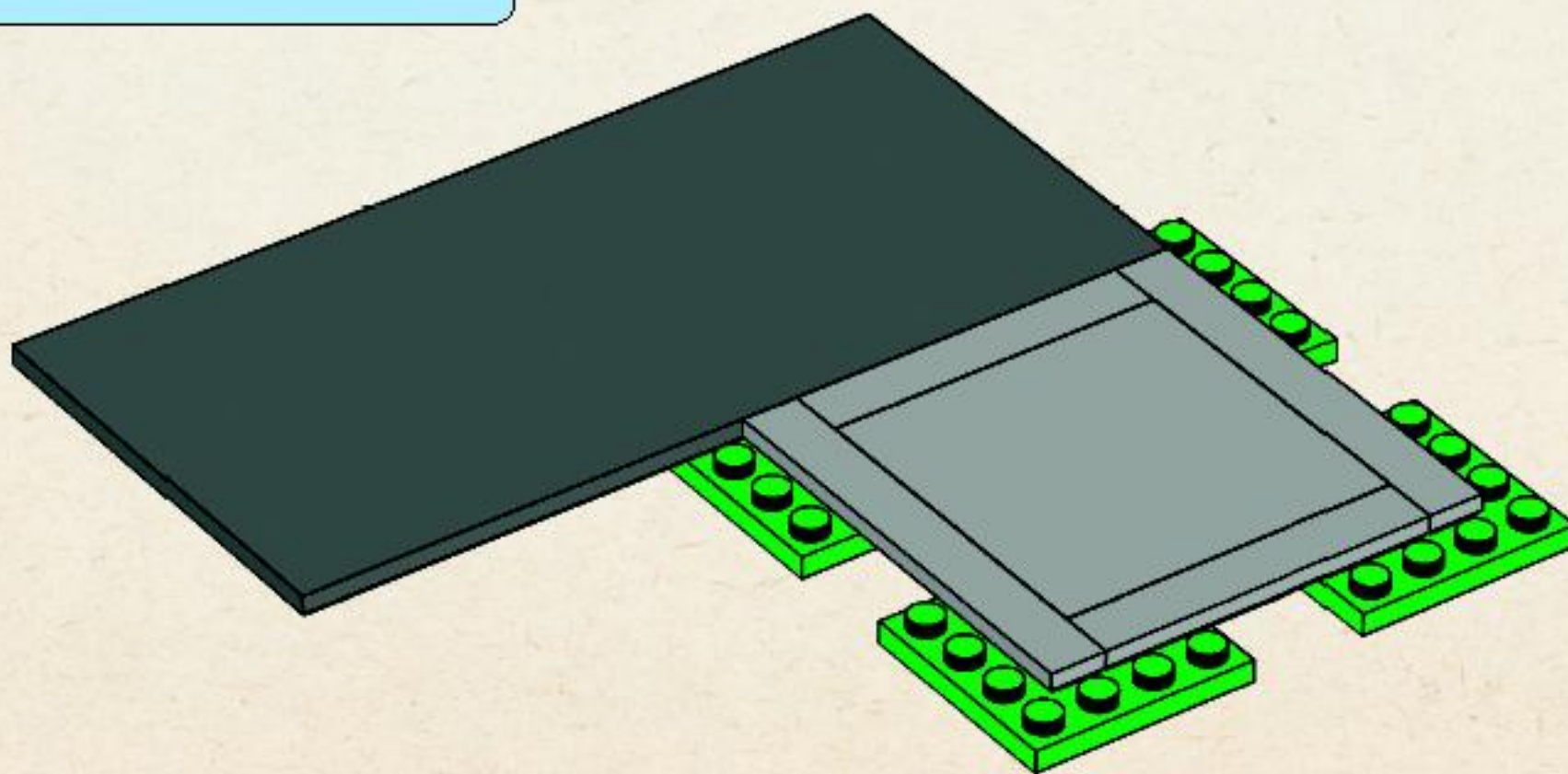

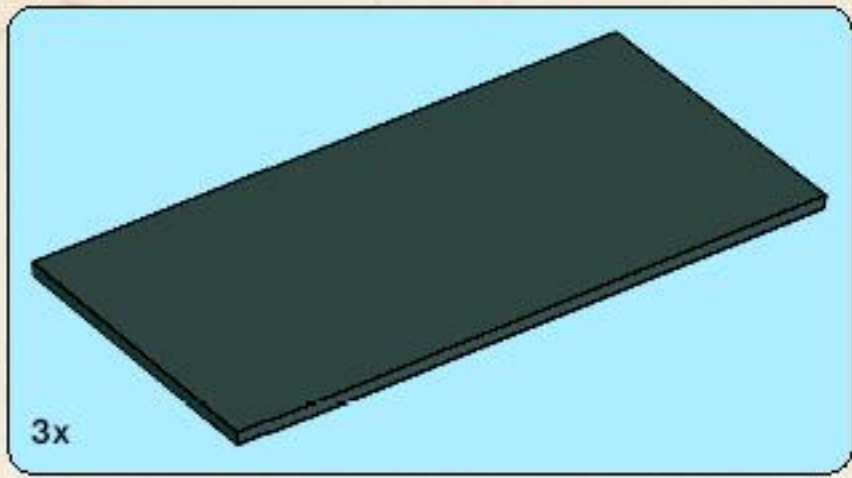

6

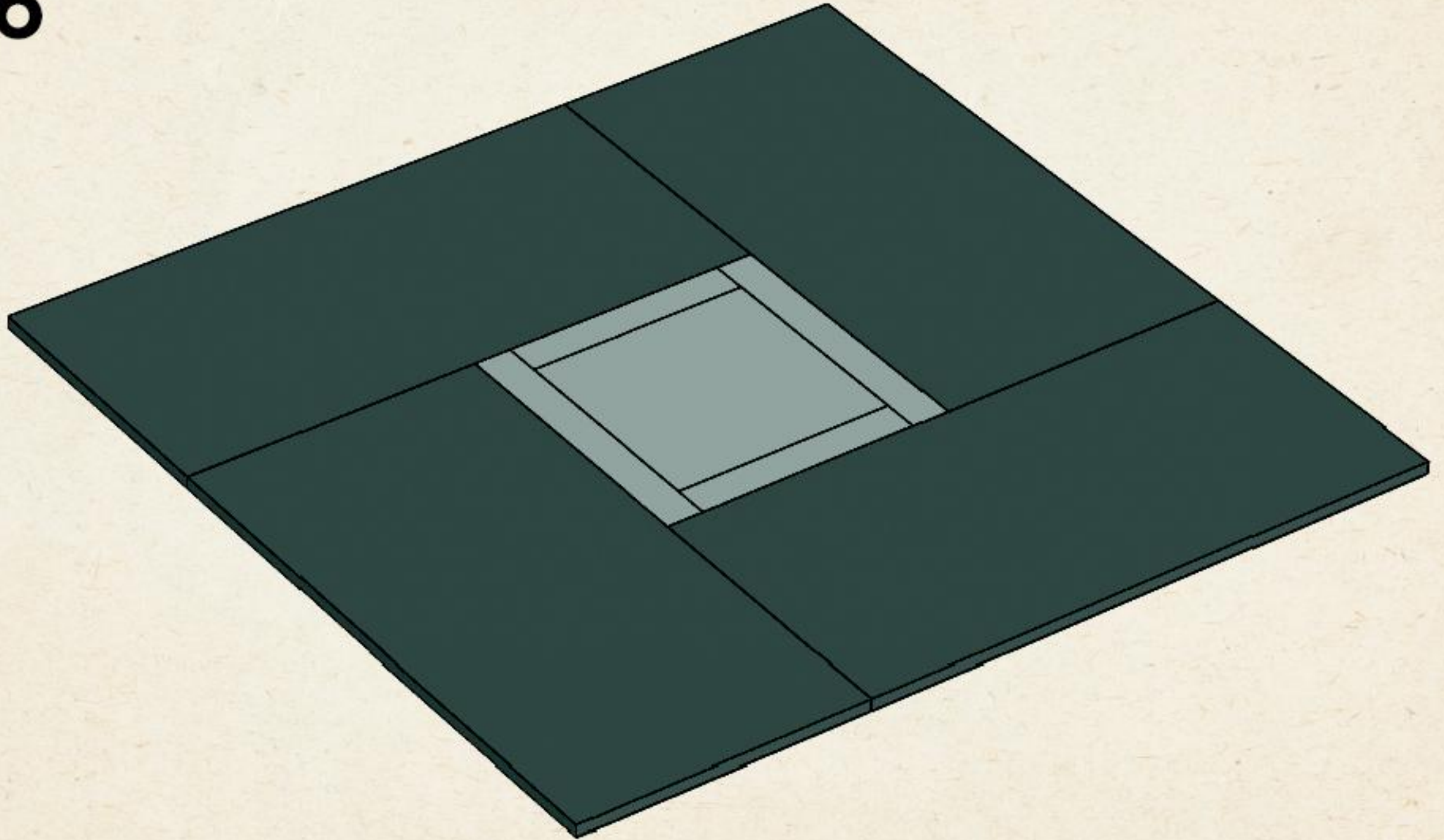

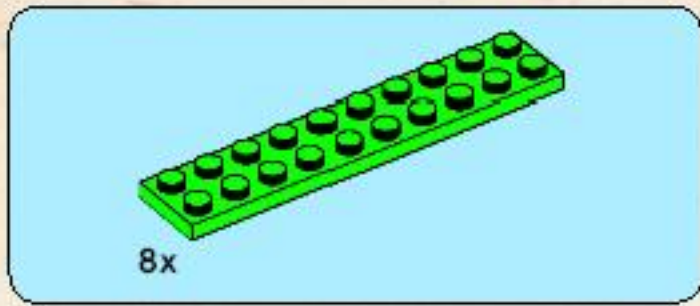

7

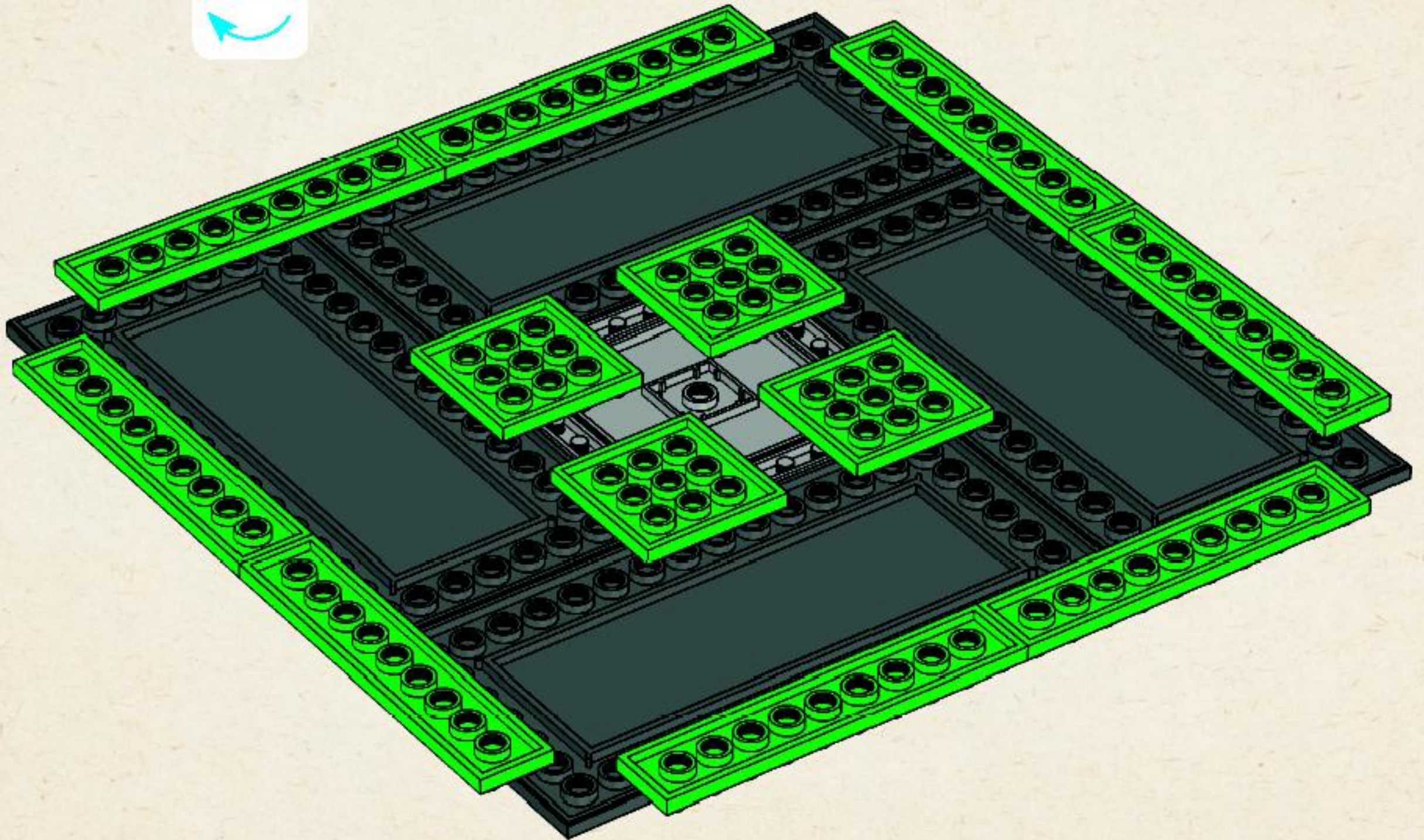

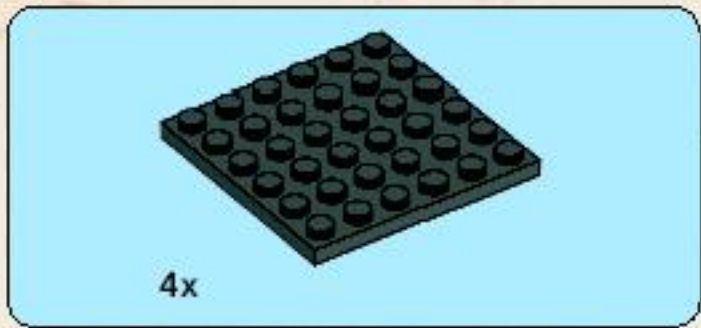

8

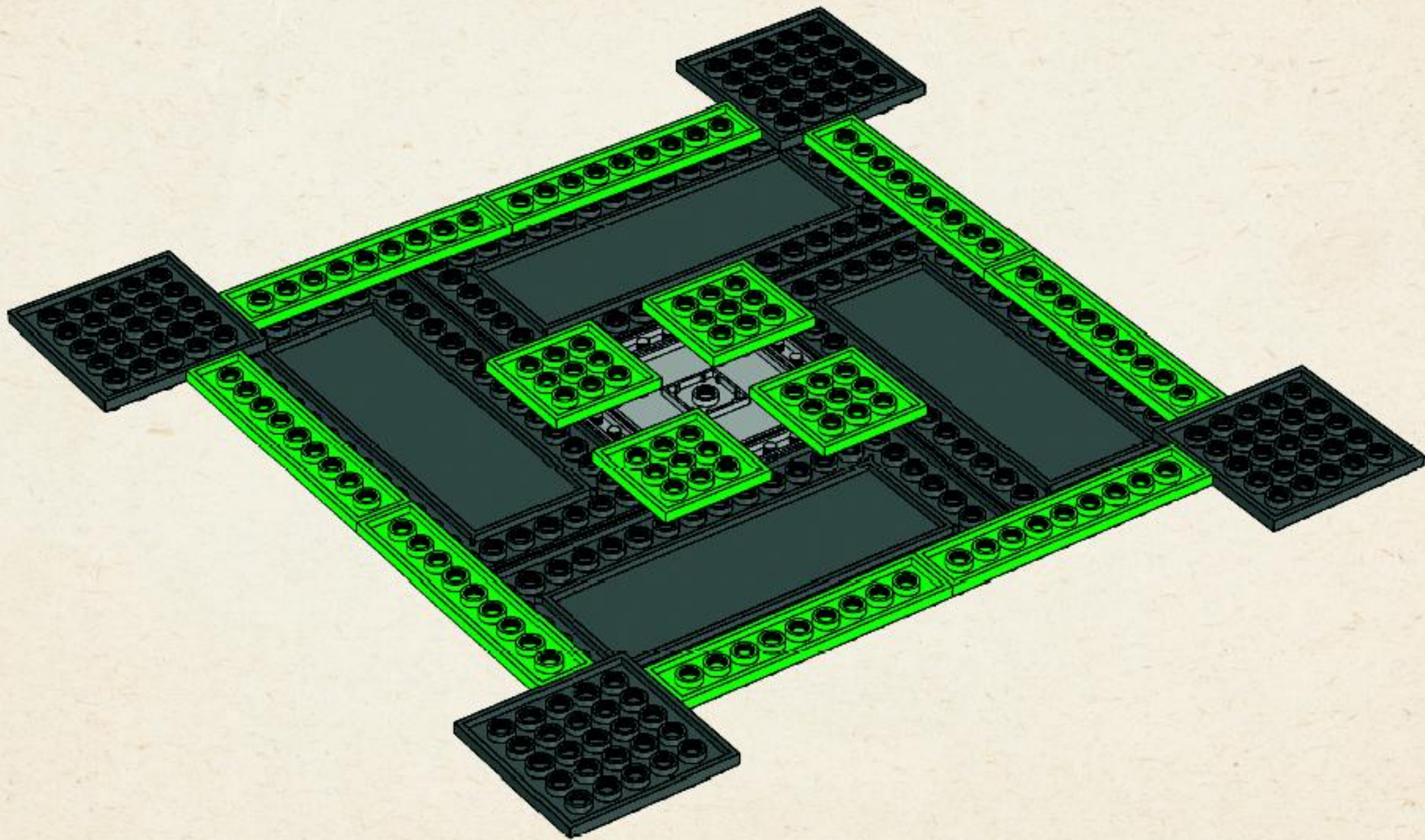

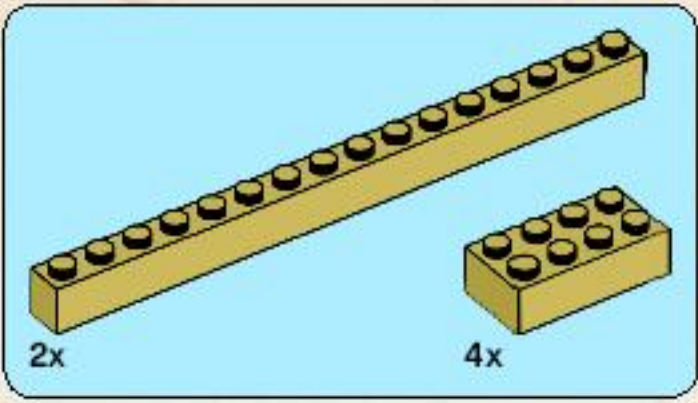

9

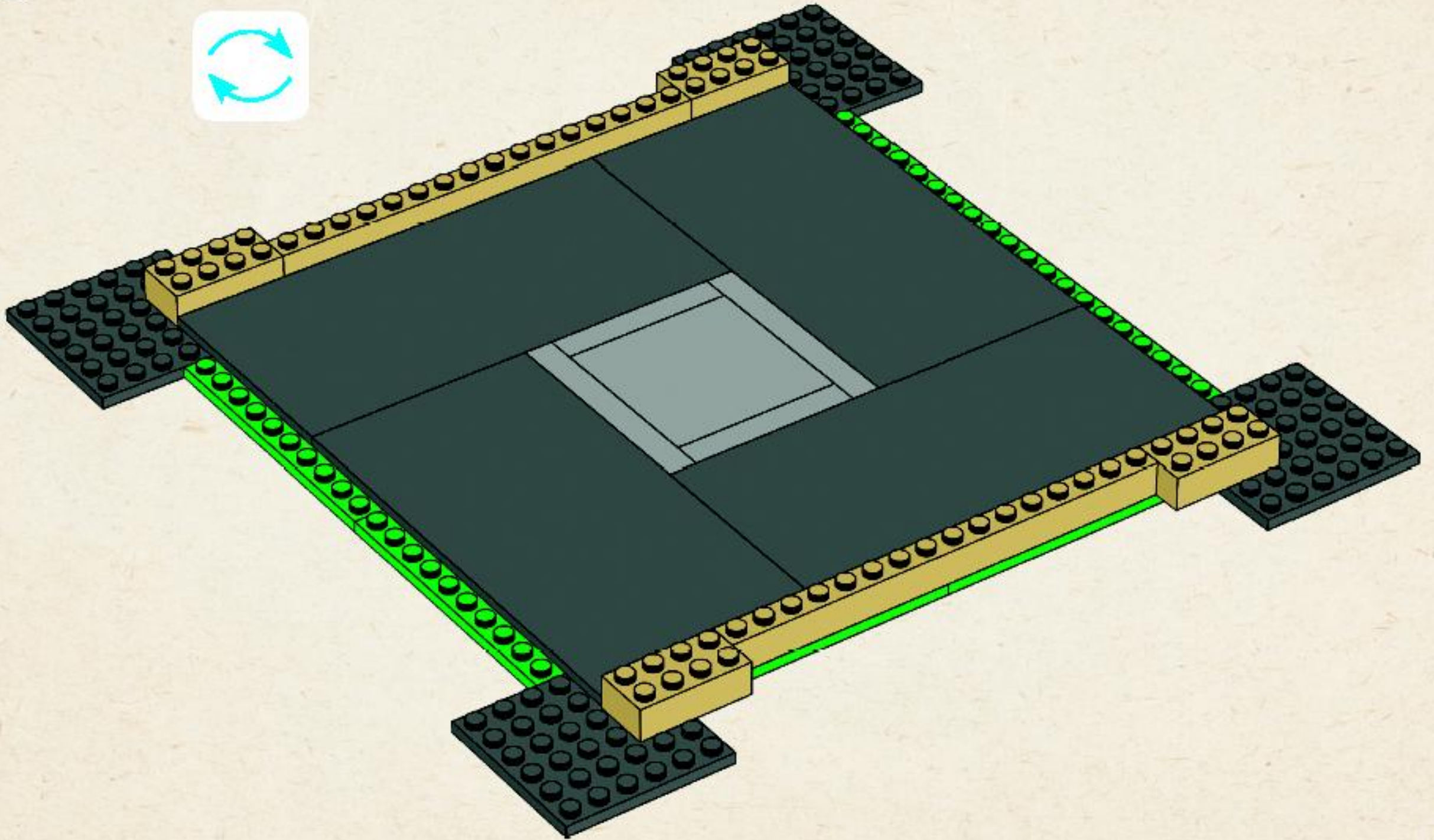

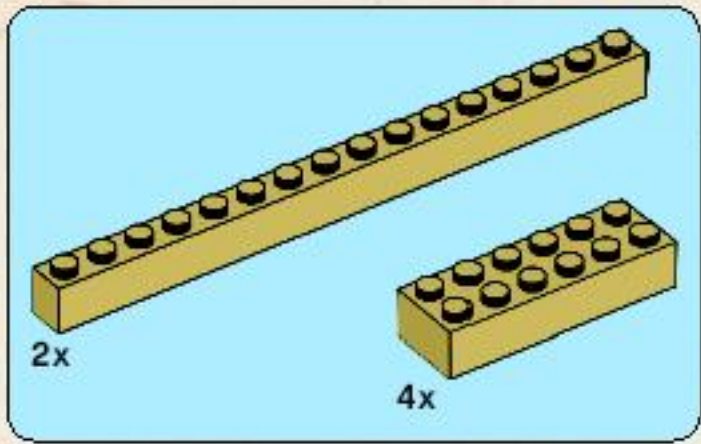

10

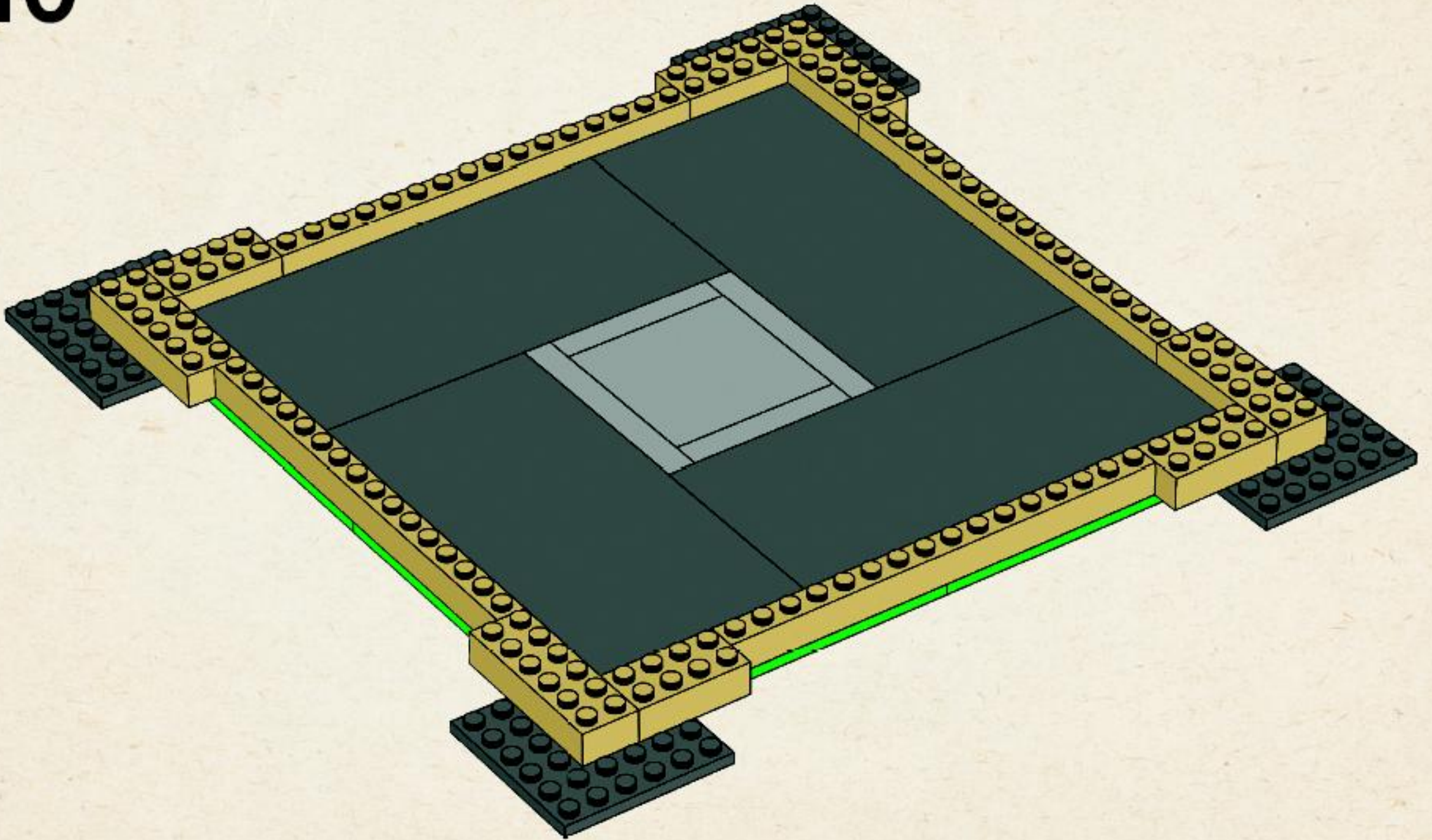

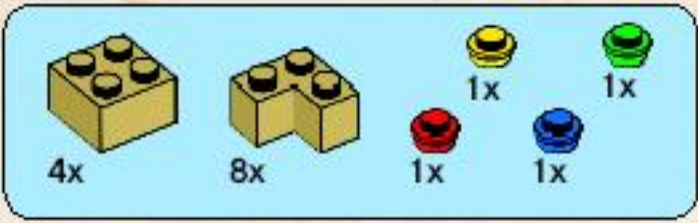

11

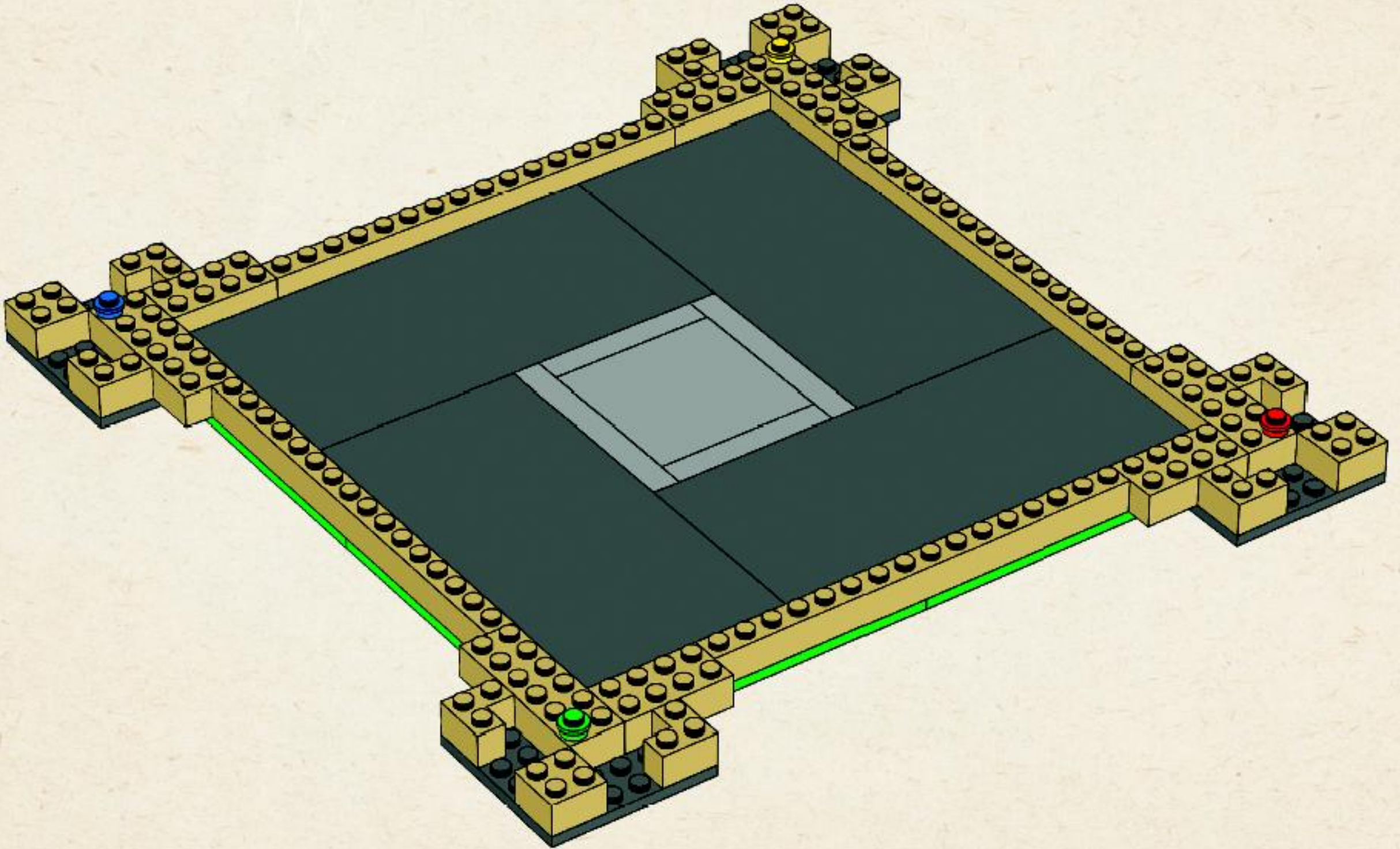

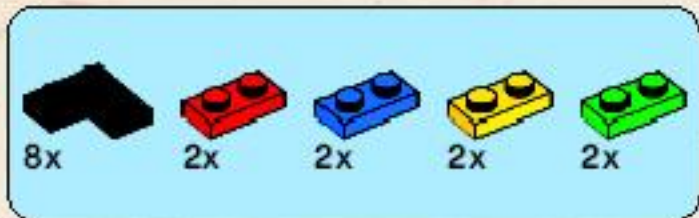

12

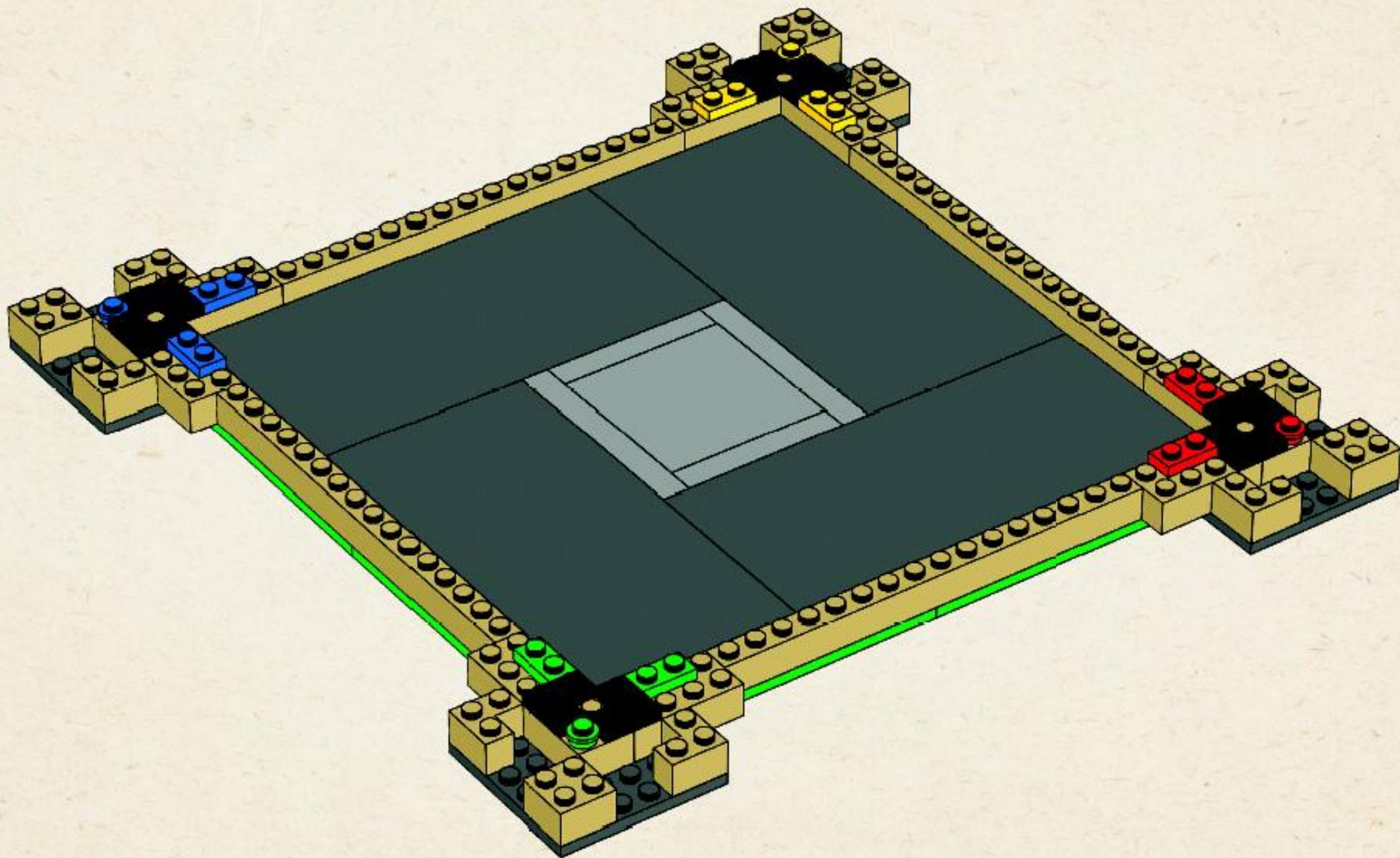



16x

13

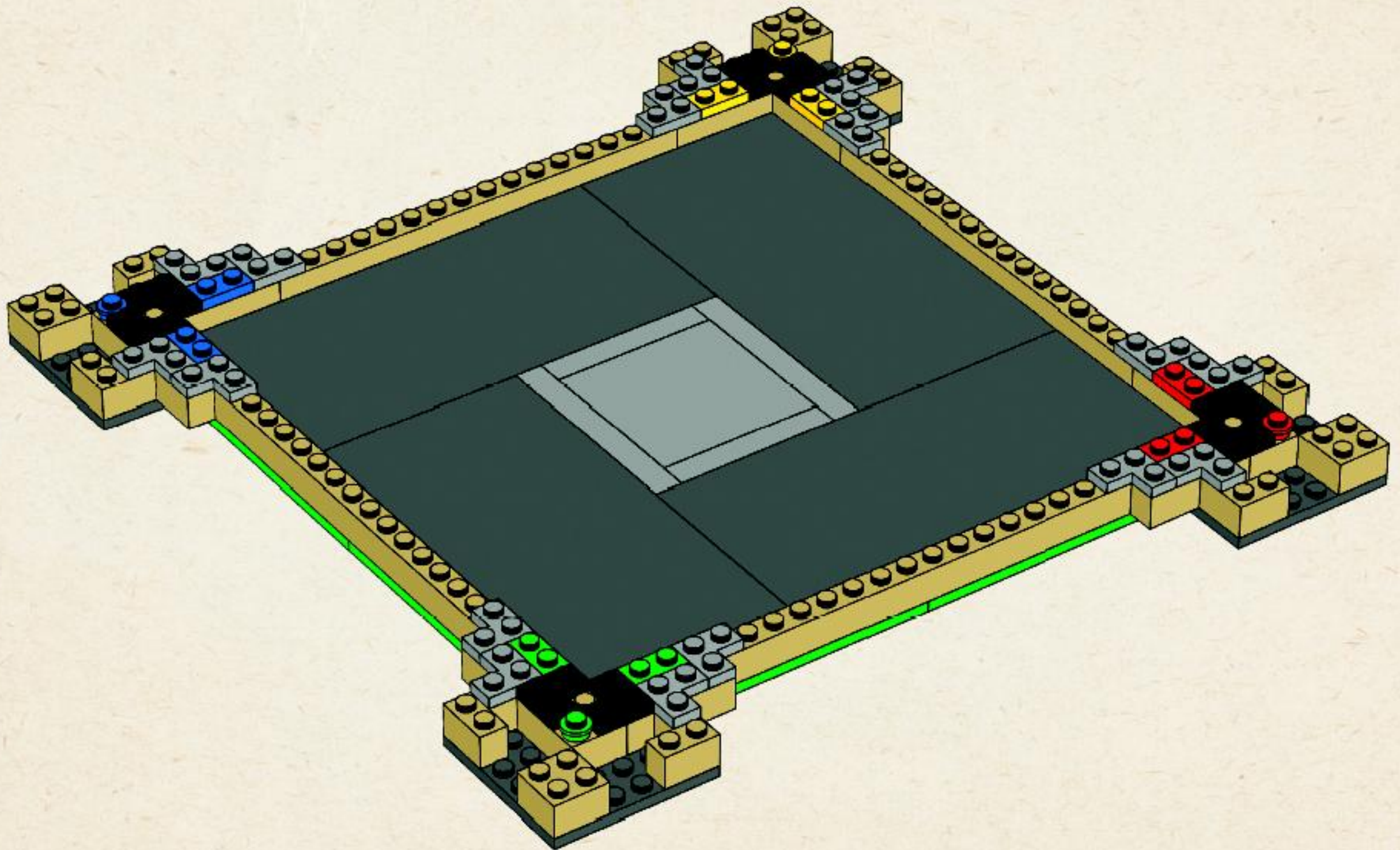

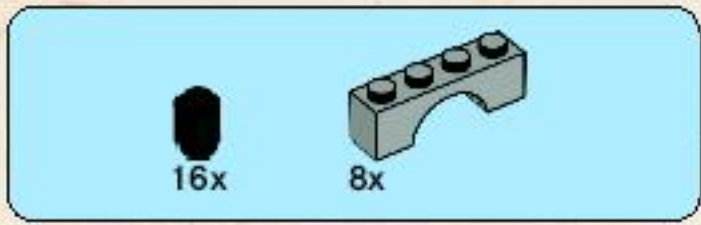

14

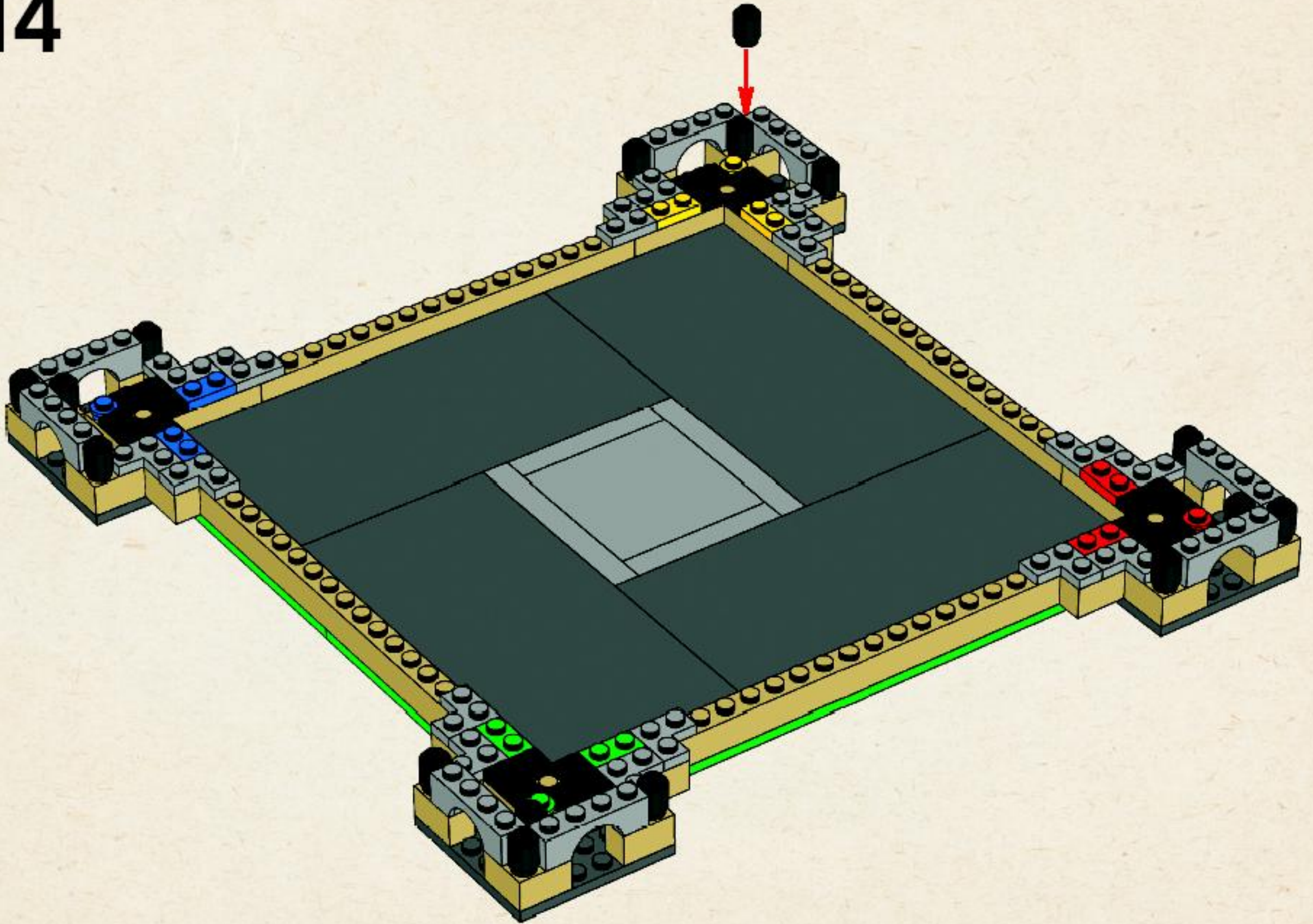

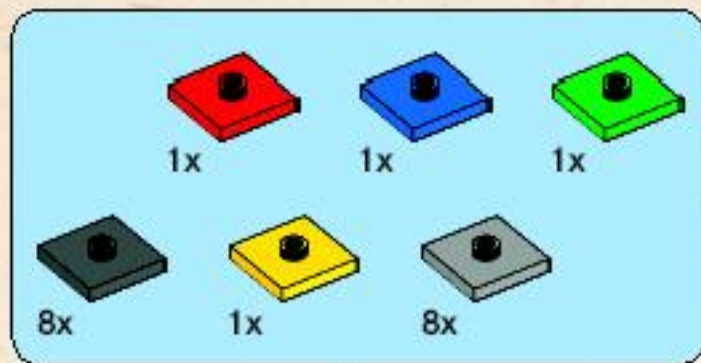

15

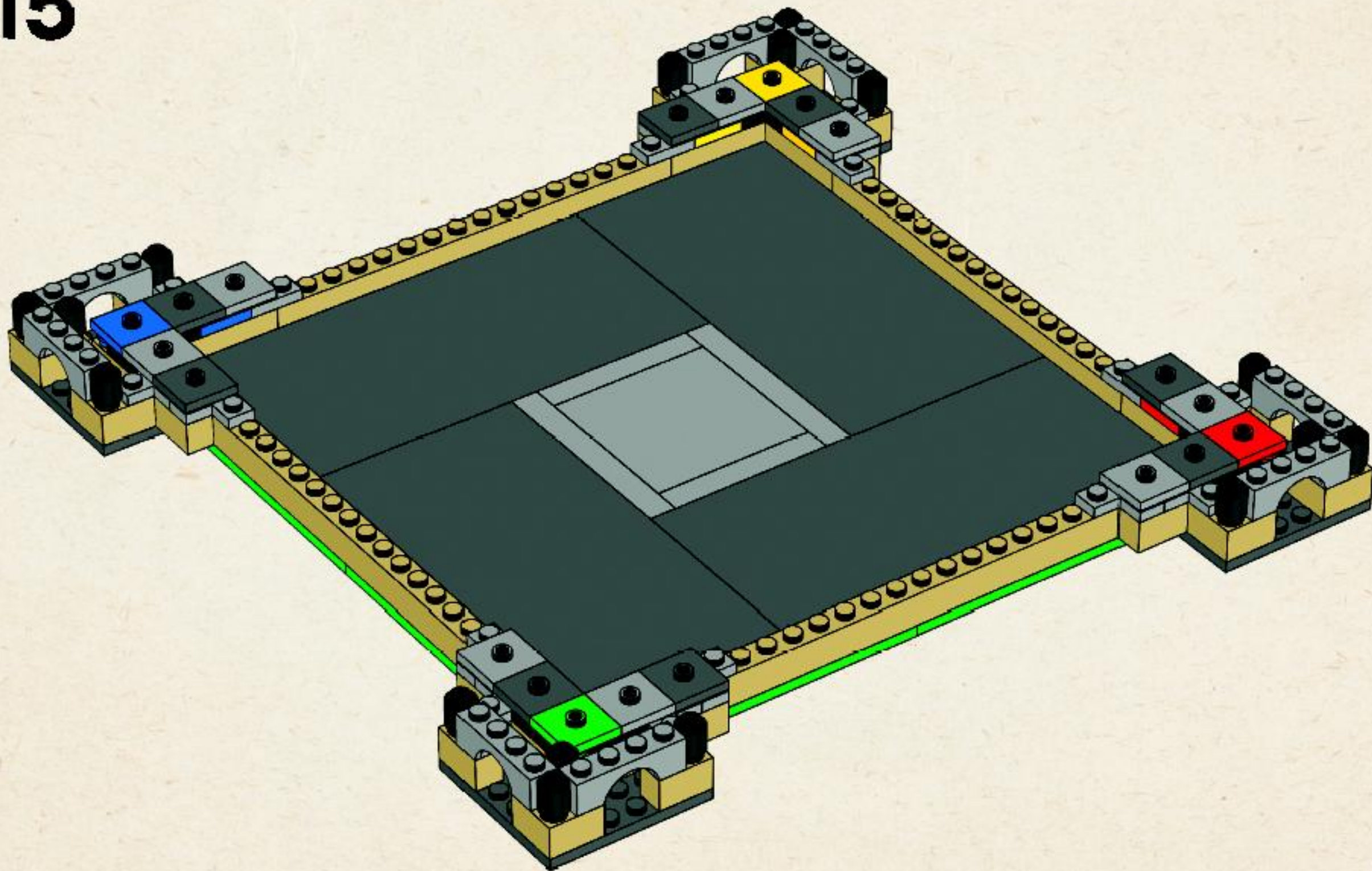

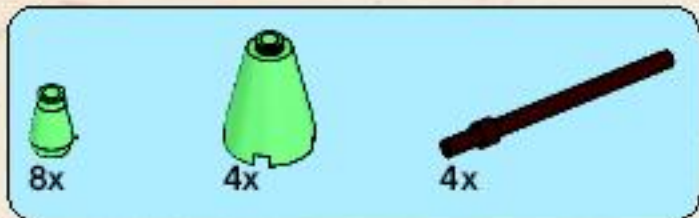

16

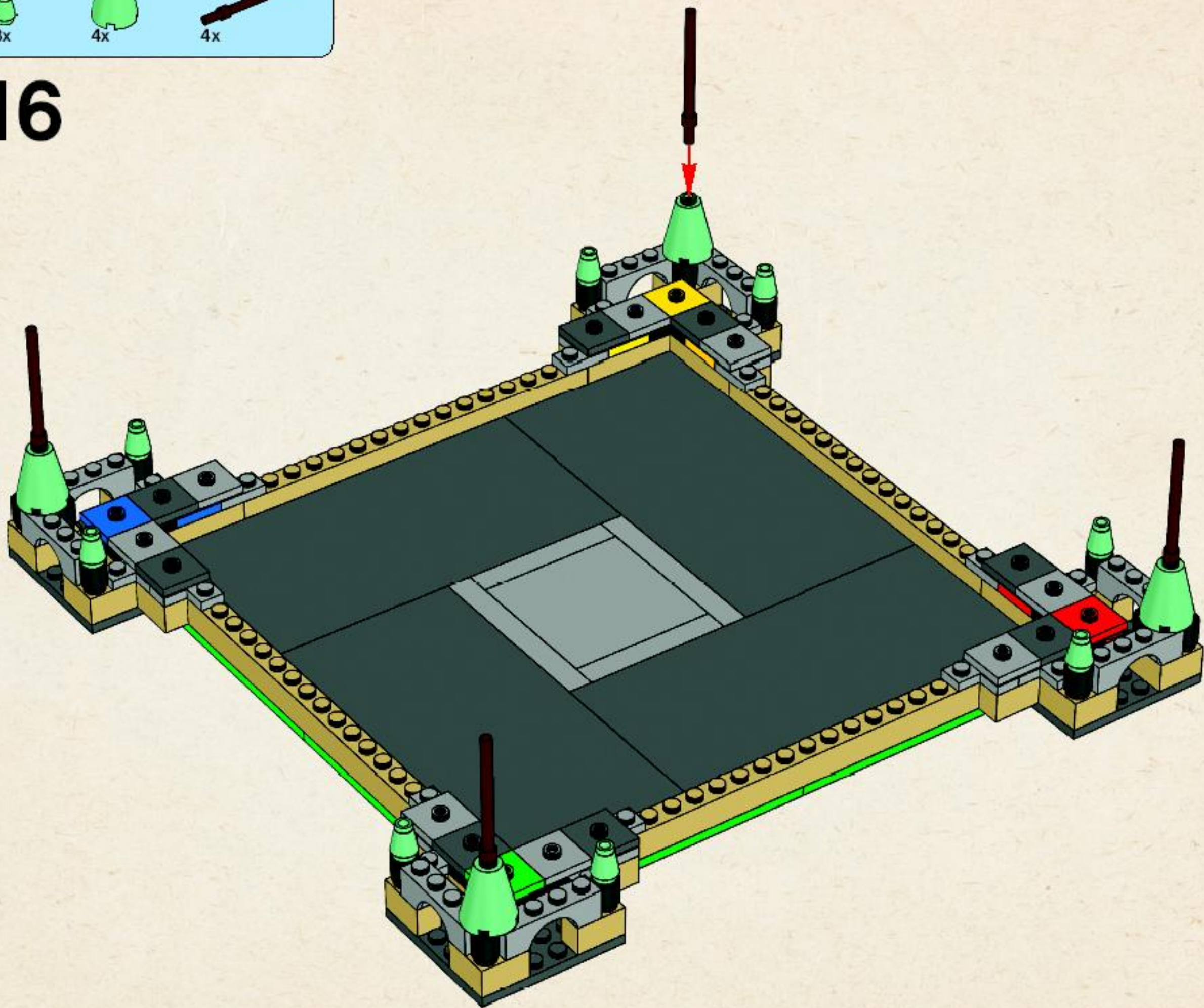

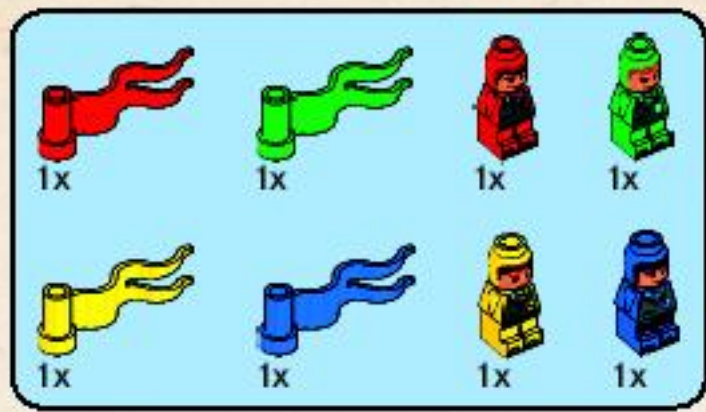

17

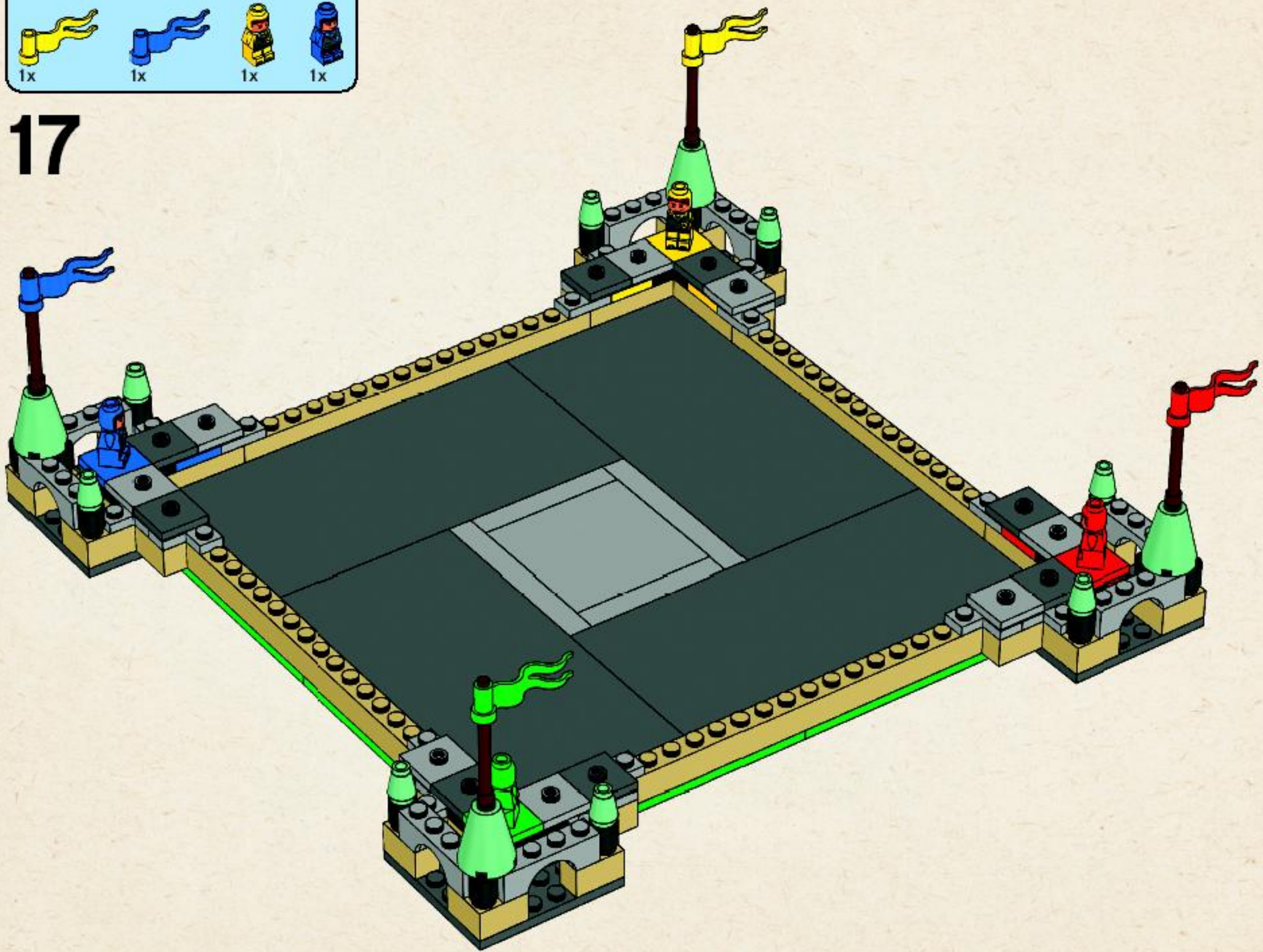

18

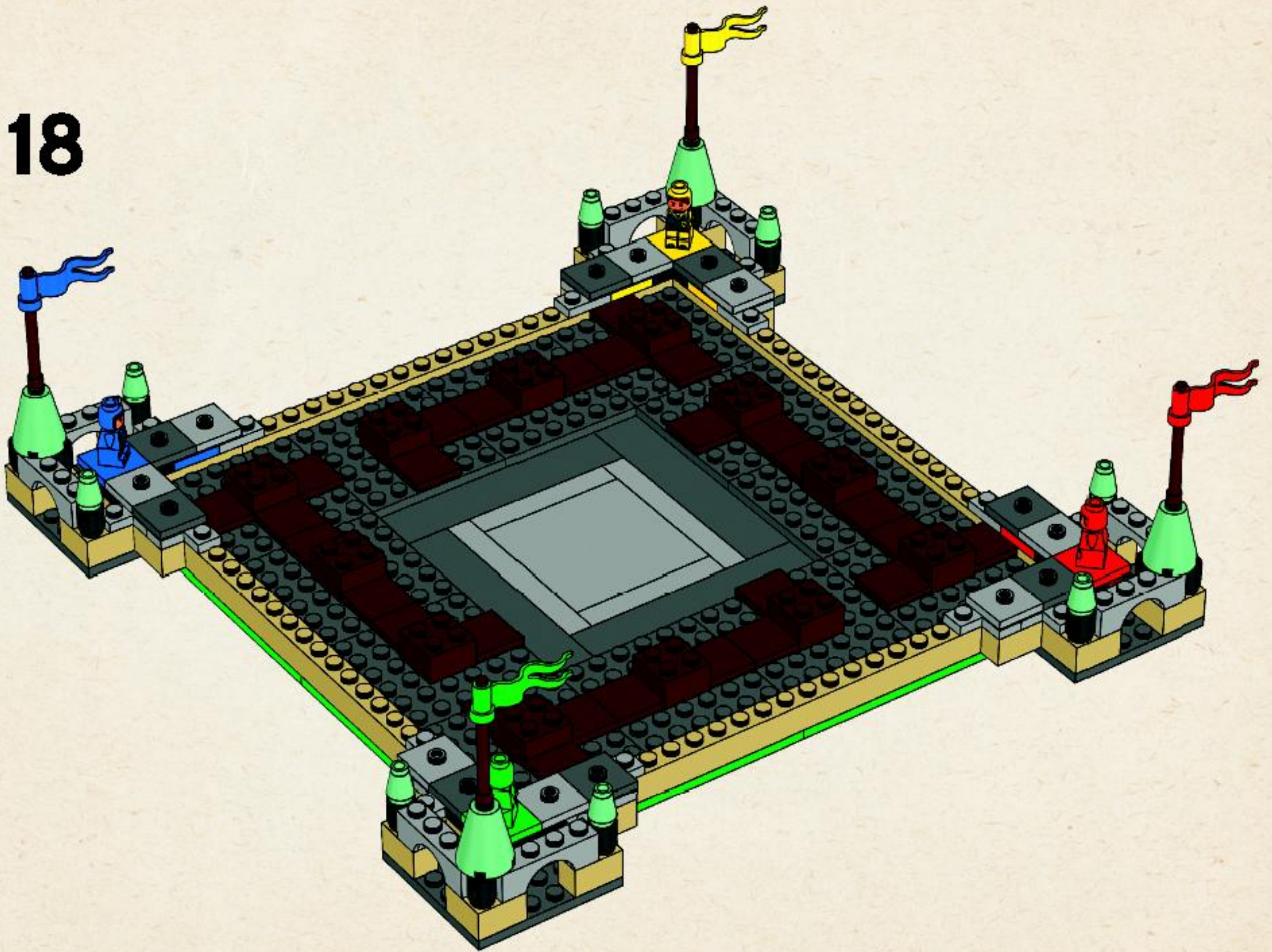

19

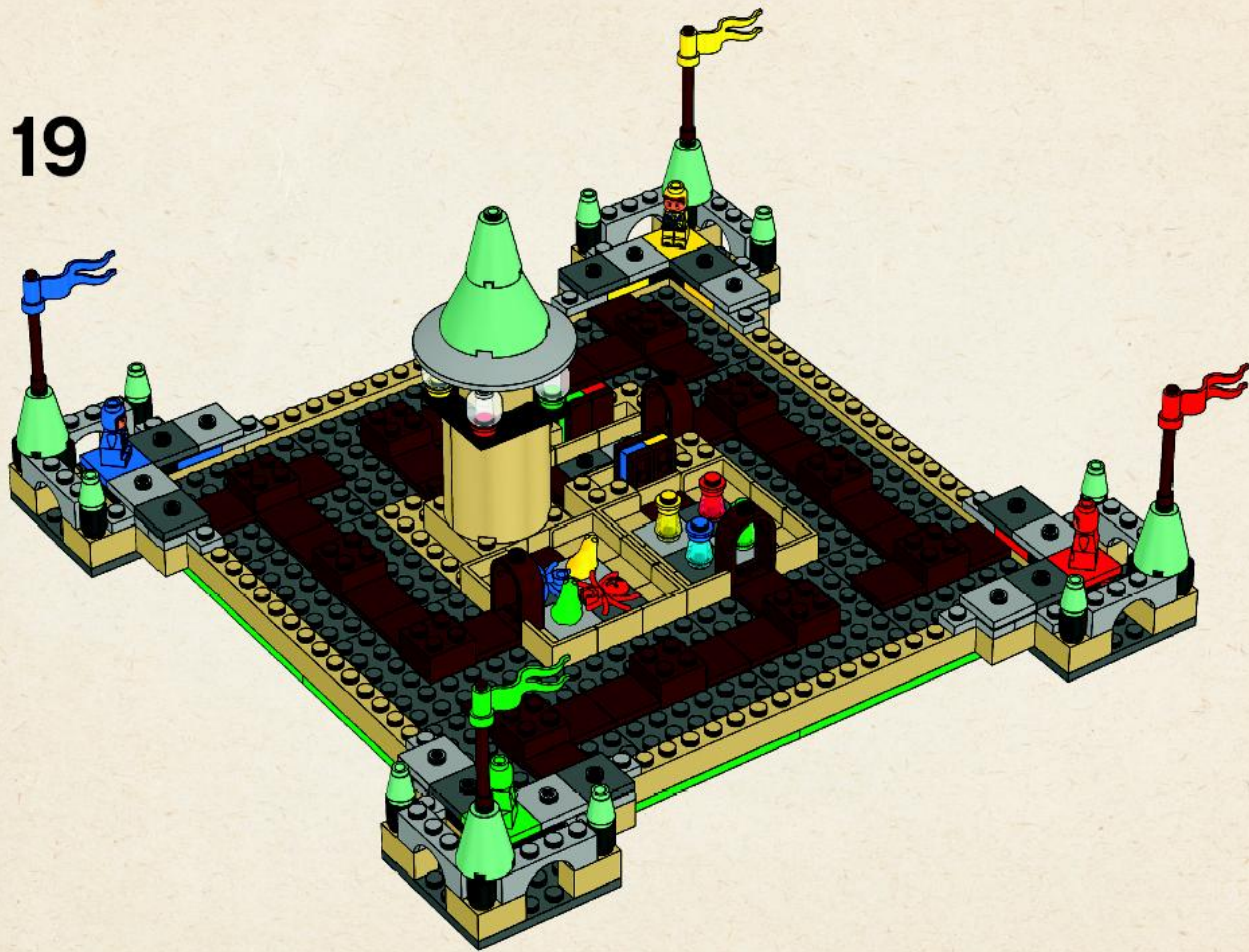

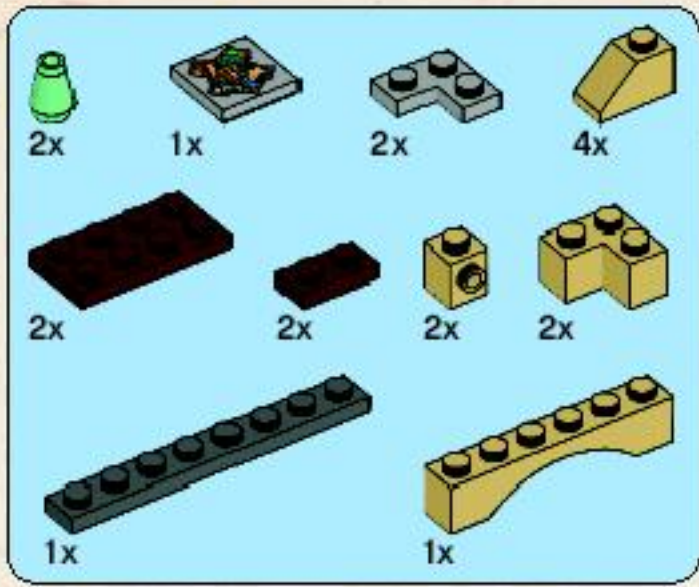

20

1

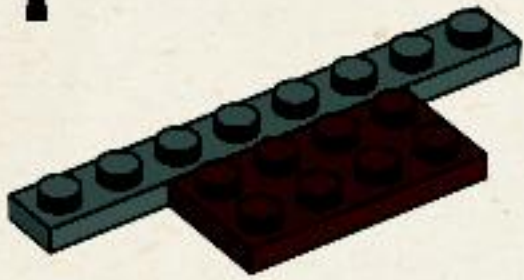

2

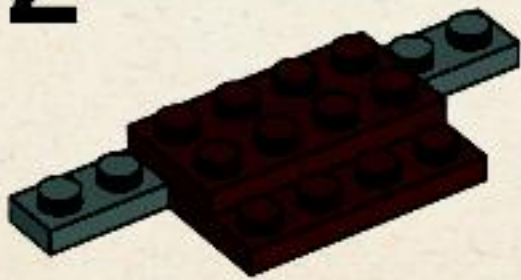

3

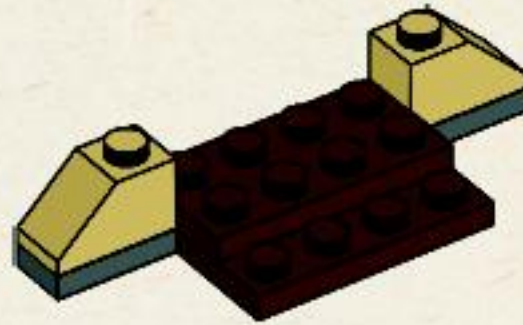

4

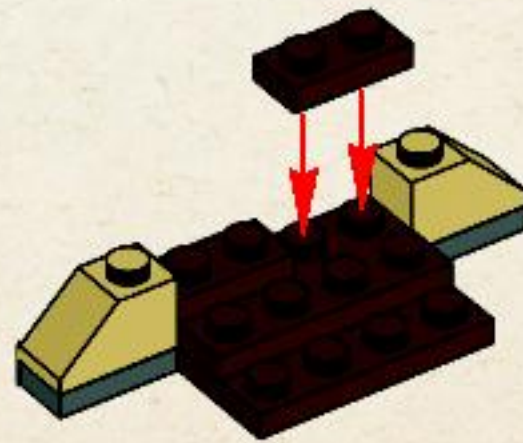

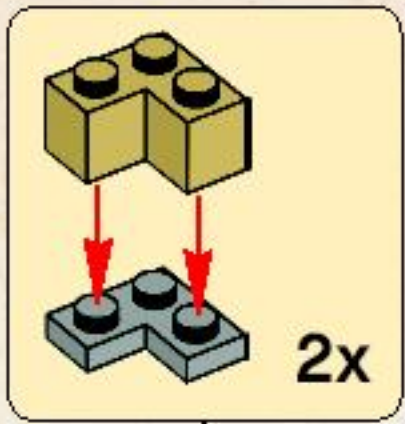

5

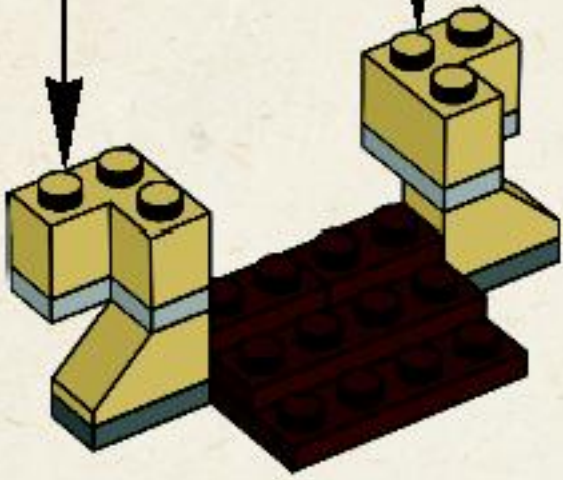

7

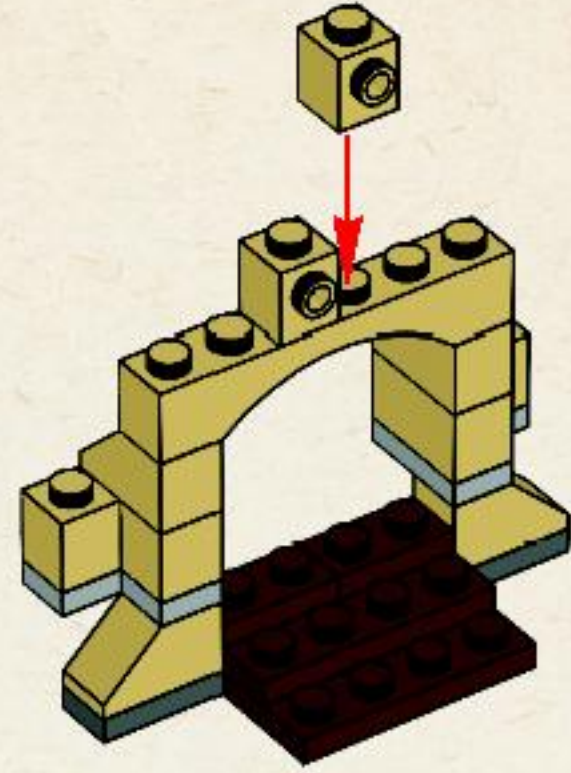

6

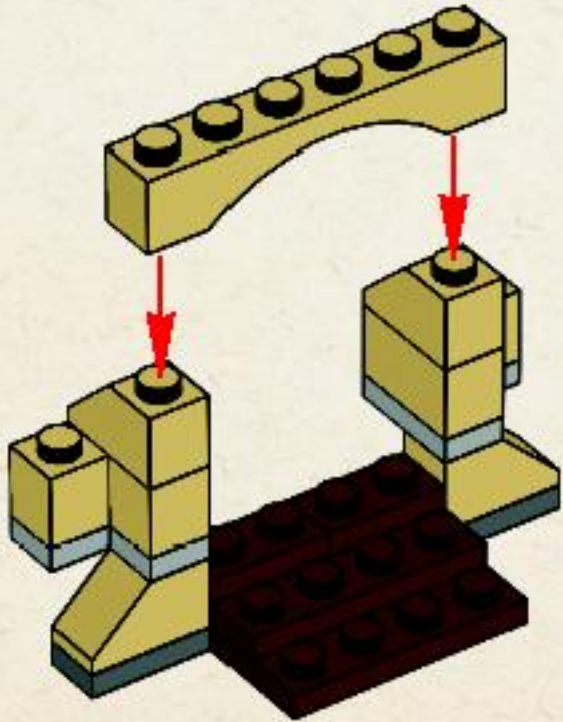

8



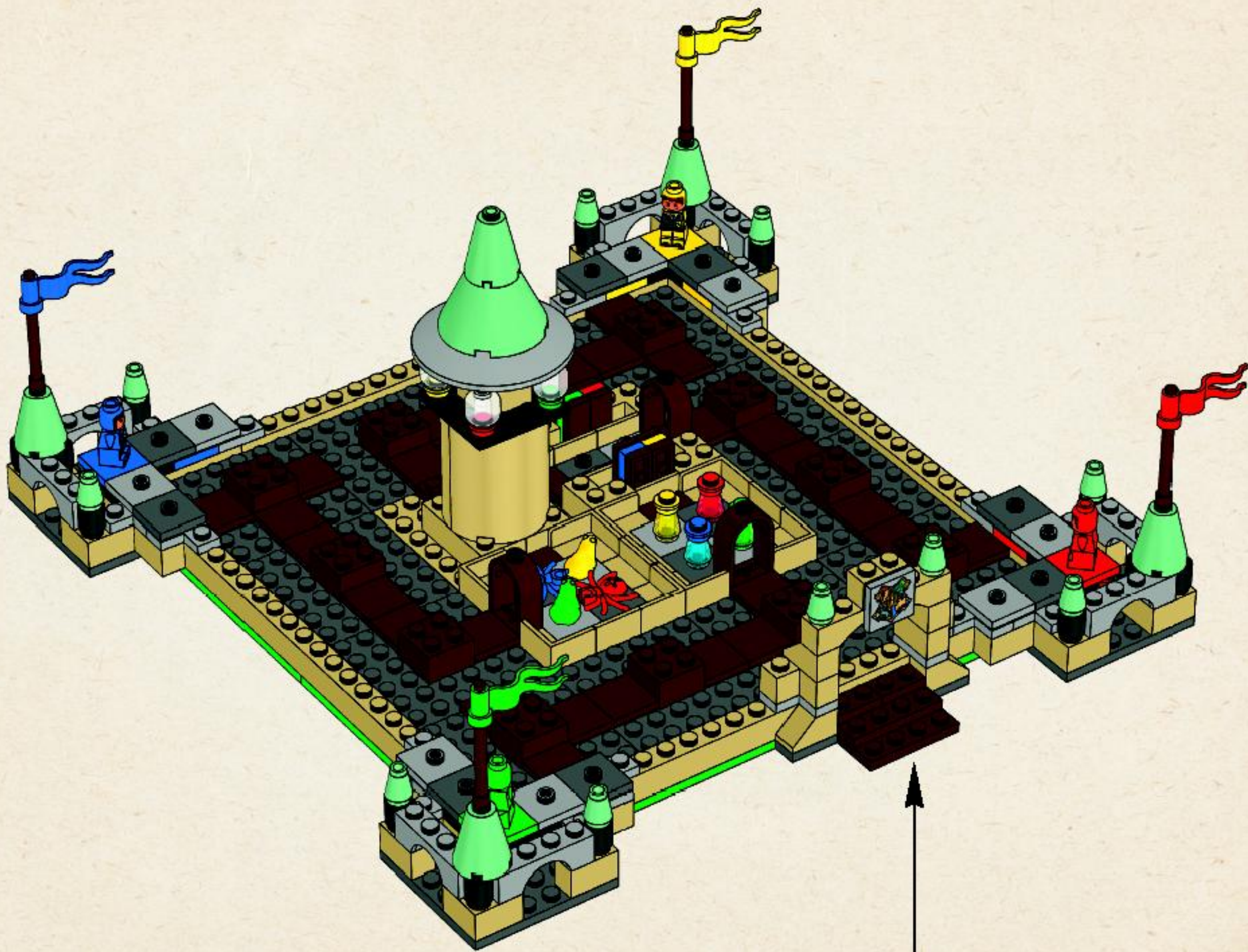

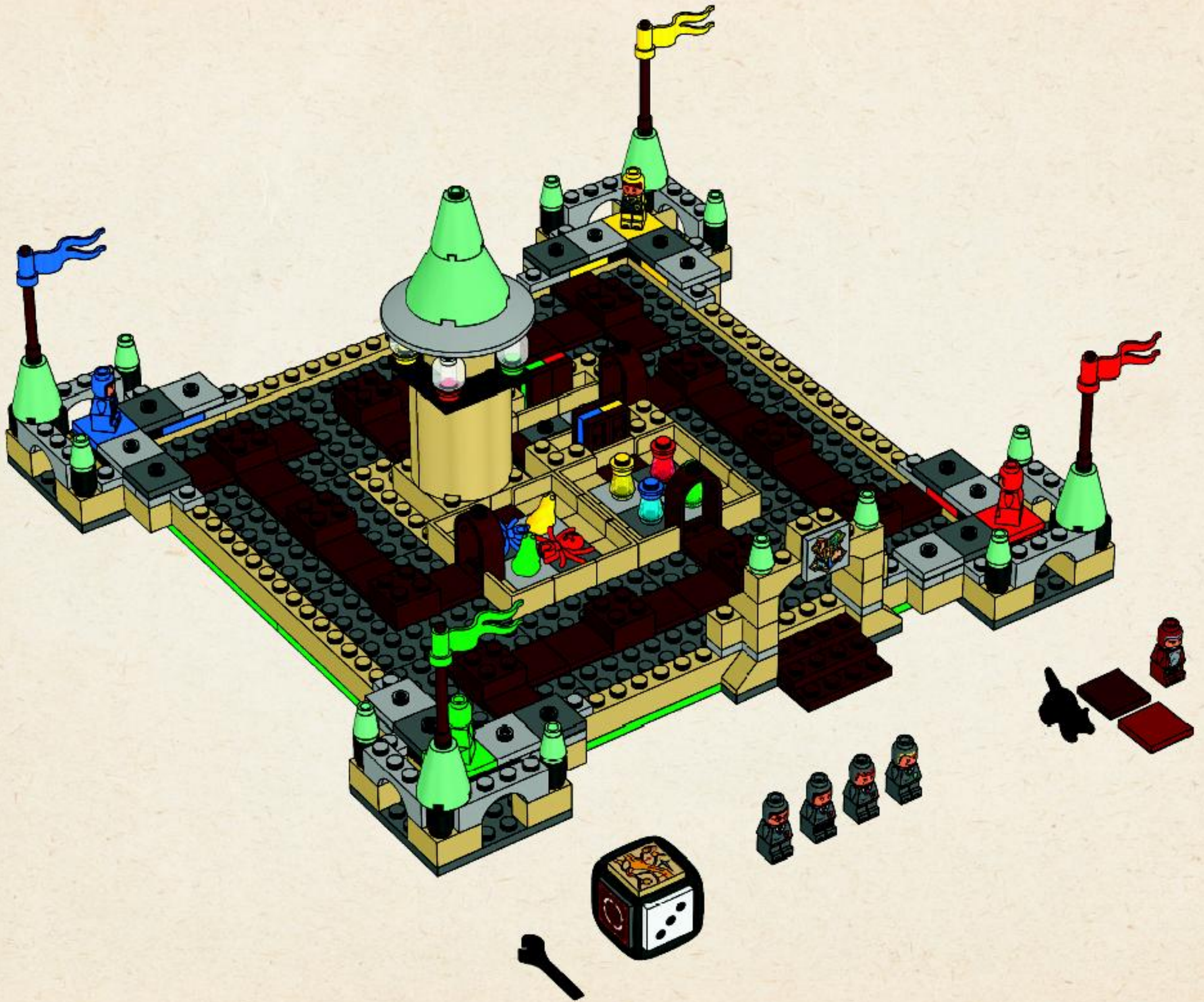



Customer Service
Kundenservice
Service Consommateurs
Servicio Al Consumidor
www.lego.com/service or dial

00800 5346 5555 :     

1-800-422-5346 :  

OUT NOW

Harry Potter

YEARS 1-4



THE MAGIC IS BUILDING

WWW.MAGICISBUILDING.COM

Wii

NINTENDO DS



PlayStation



Games for Windows



XBOX 360

XBOX LIVE



Visit www.esrb.org
for rating information

LEGO HARRY POTTER: YEARS 1-4 software © 2010 TT Games Publishing Ltd. Produced by TT Games under license from the LEGO Group. LEGO, the LEGO logo, the Brick and the Knob configurations and the Minifigure are trademarks of the LEGO Group. © 2010 The LEGO Group. "PlayStation" and the "PS" Family logo are registered trademarks of Sony Computer Entertainment Inc. The PlayStation Network Logo is a service mark of Sony Computer Entertainment Inc. Wii and Nintendo DS are trademarks of Nintendo. © 2006 Nintendo. Microsoft, Xbox, Xbox 360, Xbox LIVE, and the Xbox logos are trademarks of the Microsoft group of companies and are used under license from Microsoft. Windows and the Windows Vista Start button are trademarks of the Microsoft group of companies, and "Games for Windows" and the Windows Vista Start button logo are used under license from Microsoft. All other trademarks and copyrights are the property of their respective owners. All rights reserved.



HARRY POTTER characters, names and related indicia are trademarks of and © Warner Bros. Entertainment Inc. Harry Potter Publishing Rights © JKR. WB E-LOGO, WB SHIELD, TM & © Warner Bros. Entertainment Inc. (310)



LEGO Harry Potter

THE
MAGIC CONTINUES
OCTOBER 2010!



HarryPotter.LEGO.com

LEGO, the LEGO logo and DUPLO are trademarks of the LEGO Group. ©2010 The LEGO Group.
TM & © Warner Bros. Entertainment Inc. Harry Potter Publishing Rights © JKR. (s10)



3835
Robo Champ
2-3 6+ 10-15



3836
Magikus
2-4 6+ 10-20



3837
Monster 4
2-4 7+ 15-20



3838
Lava Dragon
2-4 7+ 15-25



3839
Race 3000
2-4 7+ 20-30



3840
Pirate Code
2-4 8+ 15-25



3841
Minotaurus
2-4 7+ 20-30



3843
Ramses Pyramid
2-4 8+ 20-40

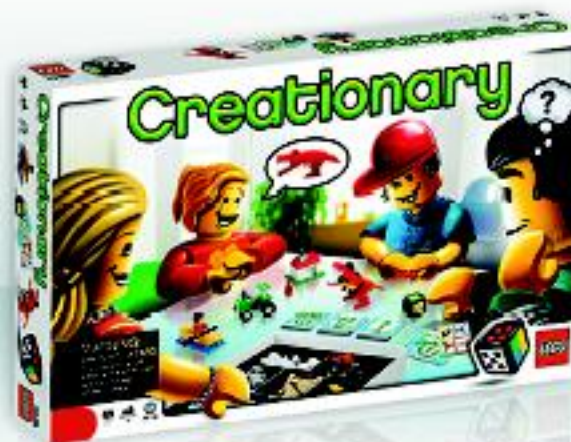

3844
Creationary
3-8 7+ 30-60

games.LEGO.com





WIN!

Go to www.nielsen.com/LEGO
to fill out a survey for a chance
to win a cool LEGO® Product.
No purchase necessary.
Open to all residents where not prohibited.



www.nielsen.com/LEGO

GEWINNE! WIN!

Nimm an der Umfrage auf
www.nielsen.com/
LEGO teil und hab die Chance ein cooles
LEGO® Produkt zu gewinnen!

Die Teilnahme am Gewinnspiel führt zu keinerlei
Kaufverpflichtungen. Teilnahme in allen nicht
ausgeschlossenen Ländern möglich.

Ga naar www.nielsen.com/LEGO,
vul een enquêteformulier in en
maak kans op een
cool LEGO® product.

Geen aankoopverplichting.
Iedereen mag deelnemen, uitzonderd
Ingezetenden
van landen waar een enquêteverbod geldt.

GAGNE! 当てよう!

Visite www.nielsen.com/LEGO
pour répondre à un questionnaire
et avoir une chance de gagner
un produit LEGO® très cool!

Aucune obligation d'achat.
Ouvert à tous les résidents des pays
autorisés.

www.nielsen.com/LEGOにアクセスして、アンケ
ートにご記入ください。当選者にはレゴ製品を
差し上げます。

お買い上げの必要はありません。

禁止されていない限り、すべての皆様にご活用いただけます。

LEGO and the LEGO logo are trademarks of the LEGO Group. ©2010 Lucasfilm Ltd. & TM. All rights reserved. Used under authorization.
TM & © Warner Bros. Entertainment Inc.