

**LEGO**

NICKELODEON

**SpongeBob  
SquarePants**

7+

3825

THE  
KRUSTY  
KRAB

ENTER



4494587

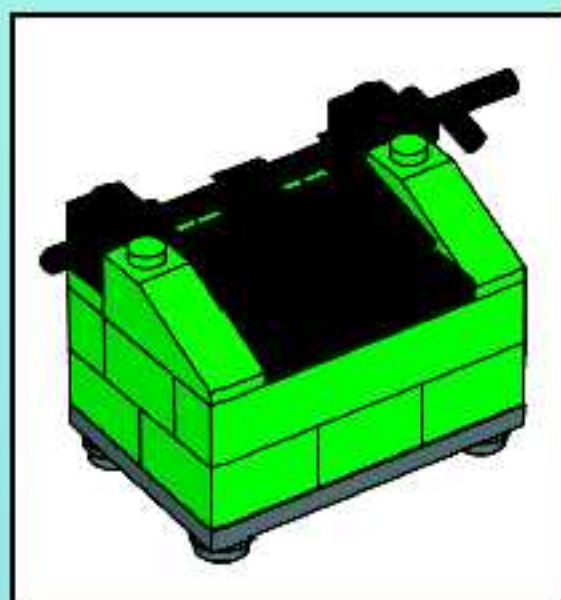
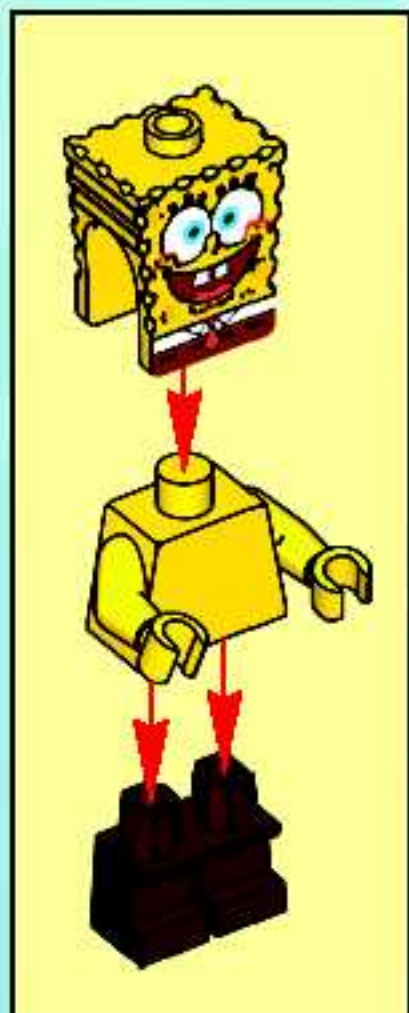

1

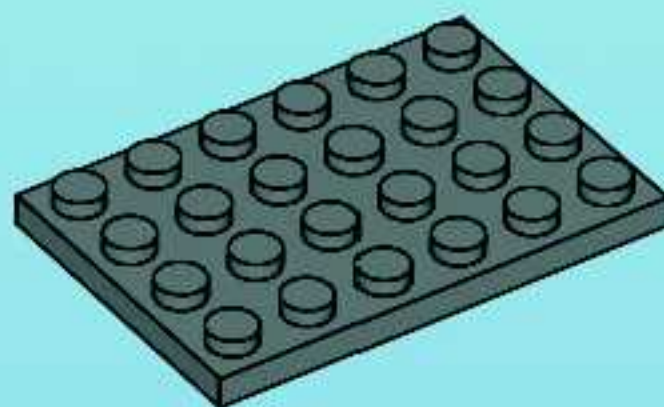

2

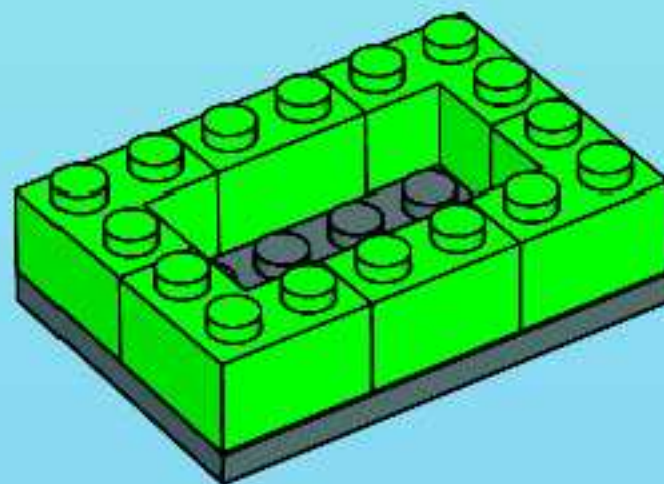

3

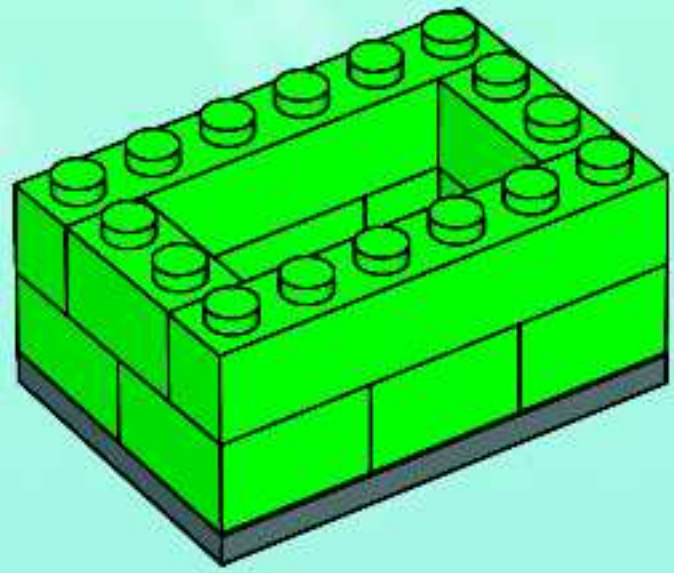

4

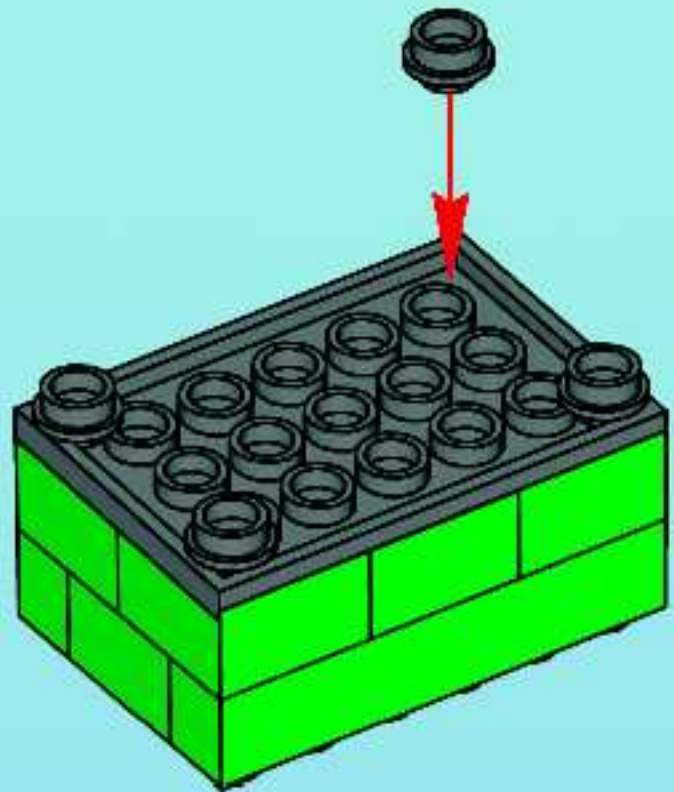

5

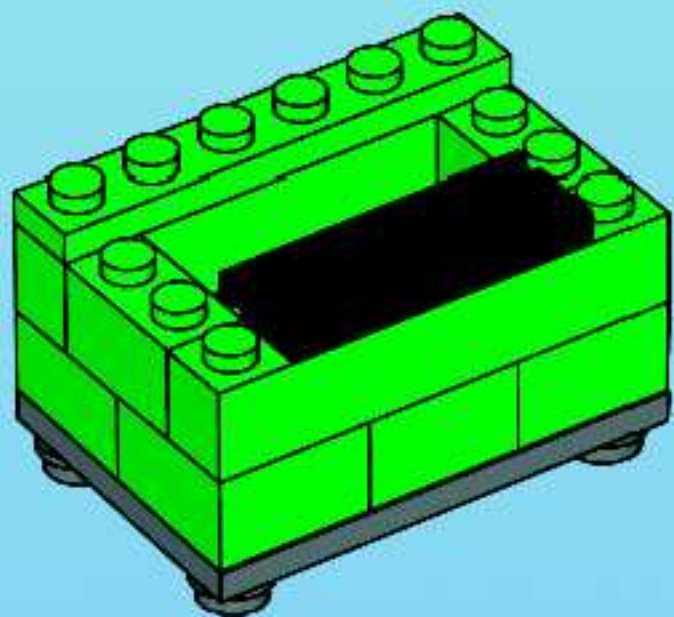

6

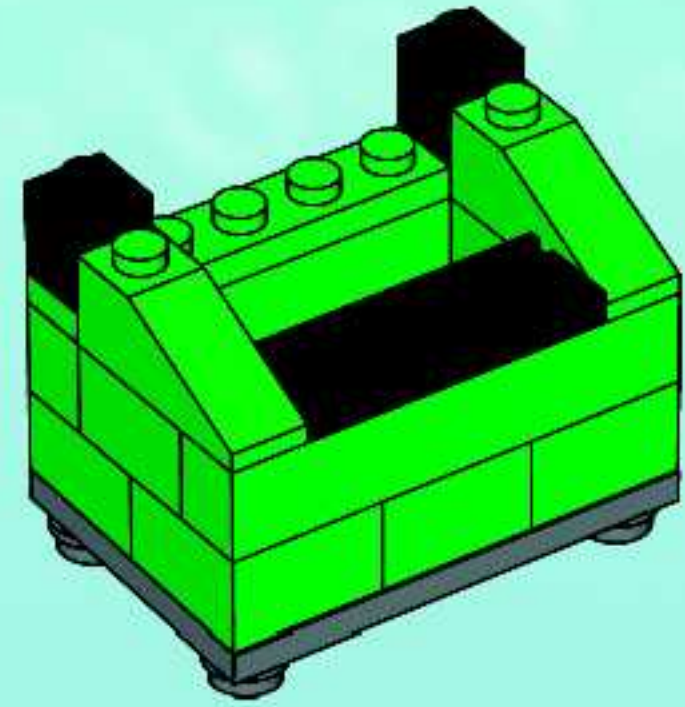

7

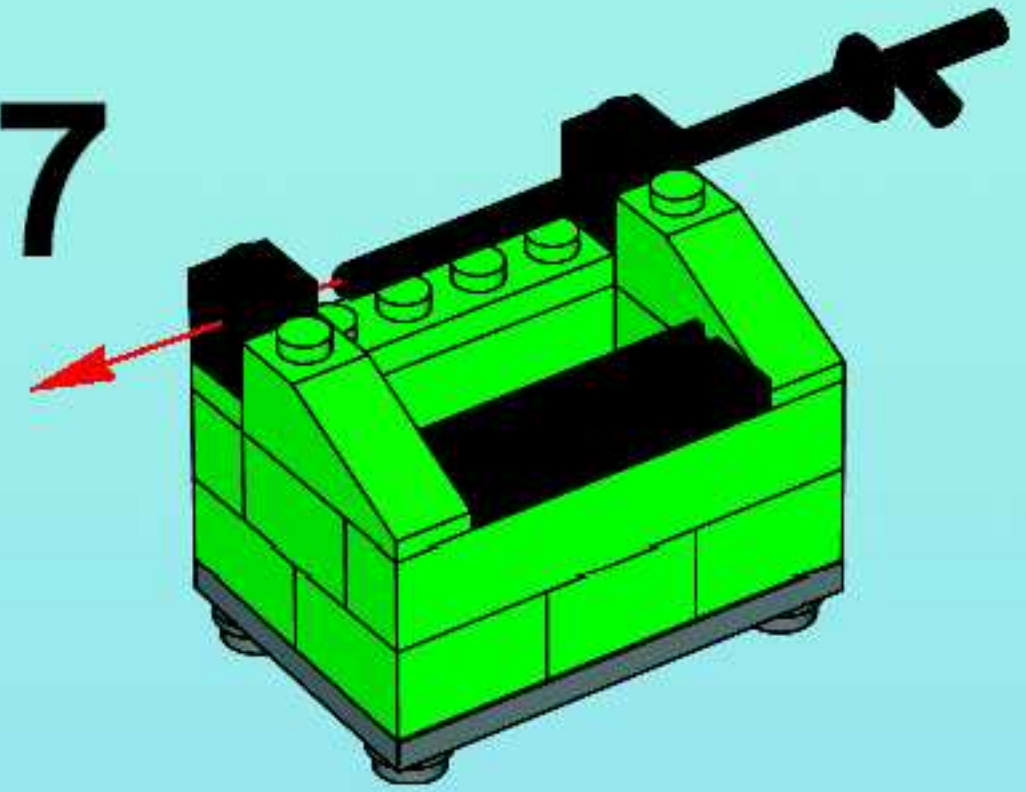

8

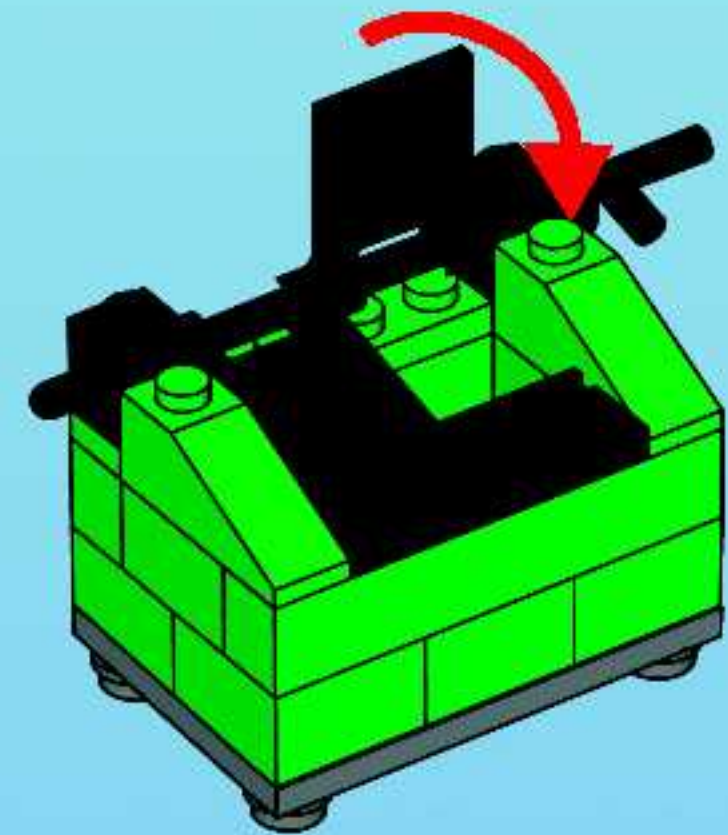

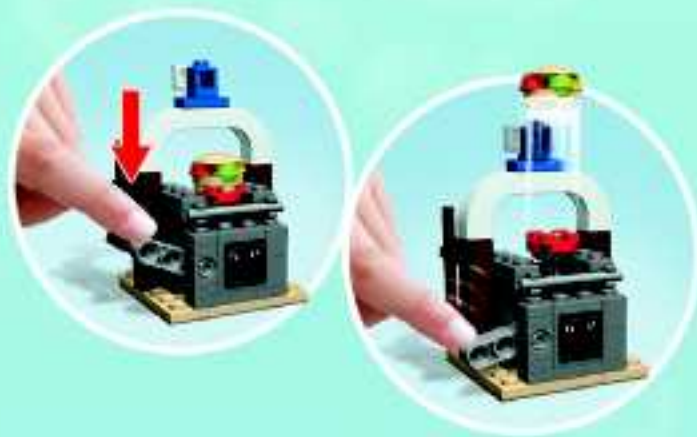
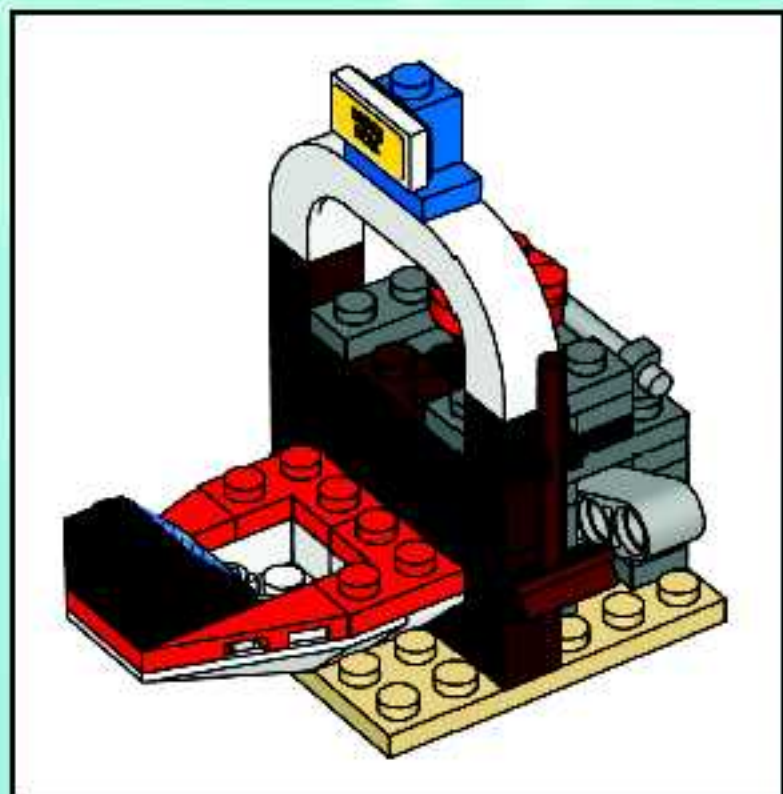

**1**

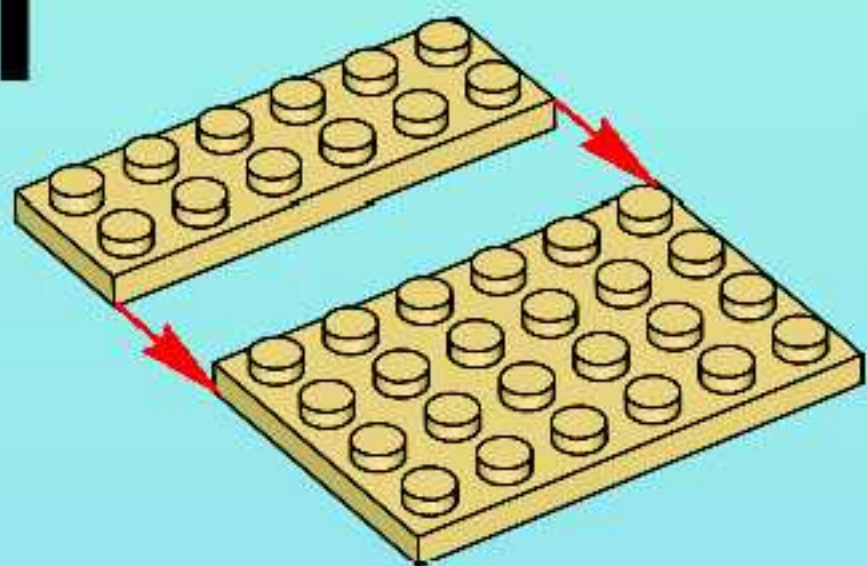

**2**

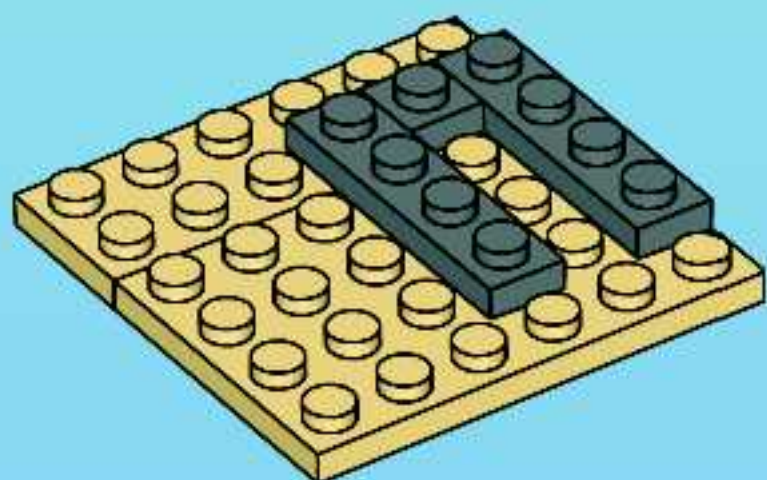

**3**

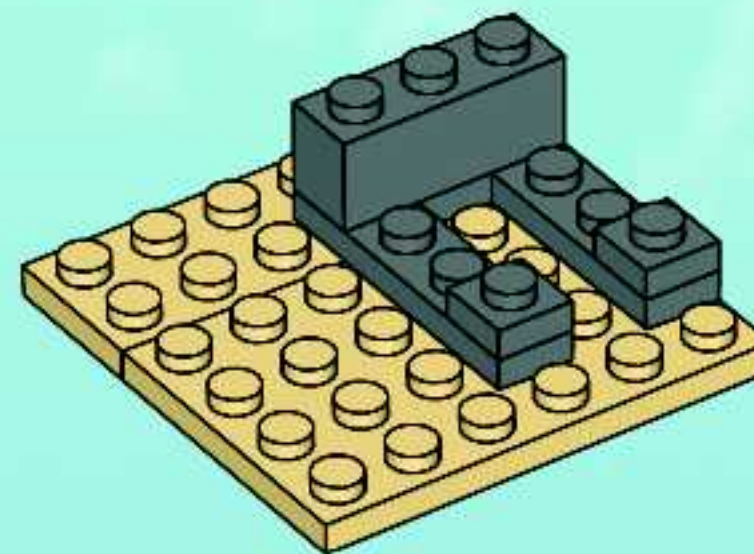

**1**

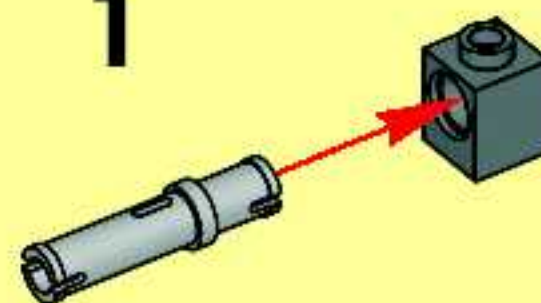

**2**

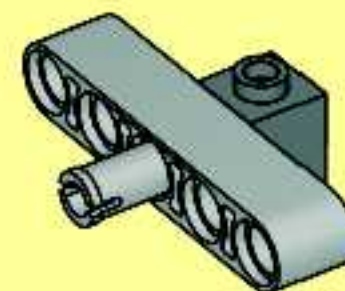

**3**

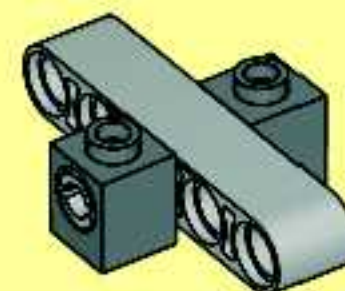

**4**

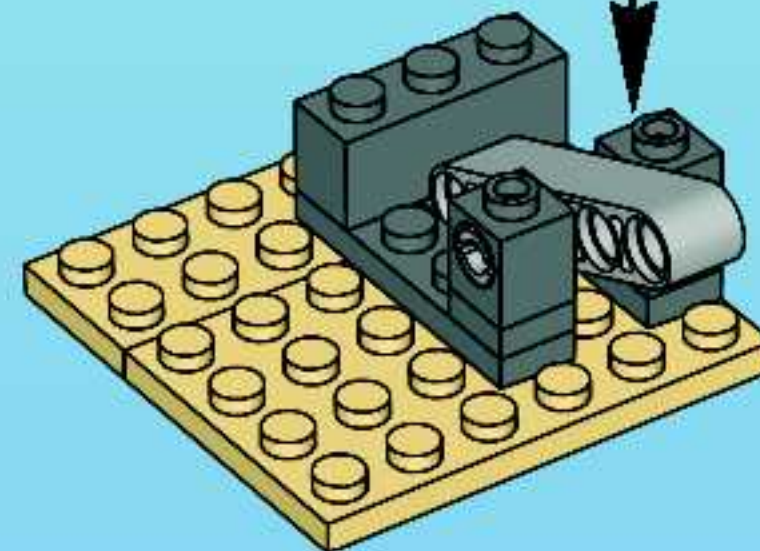

5

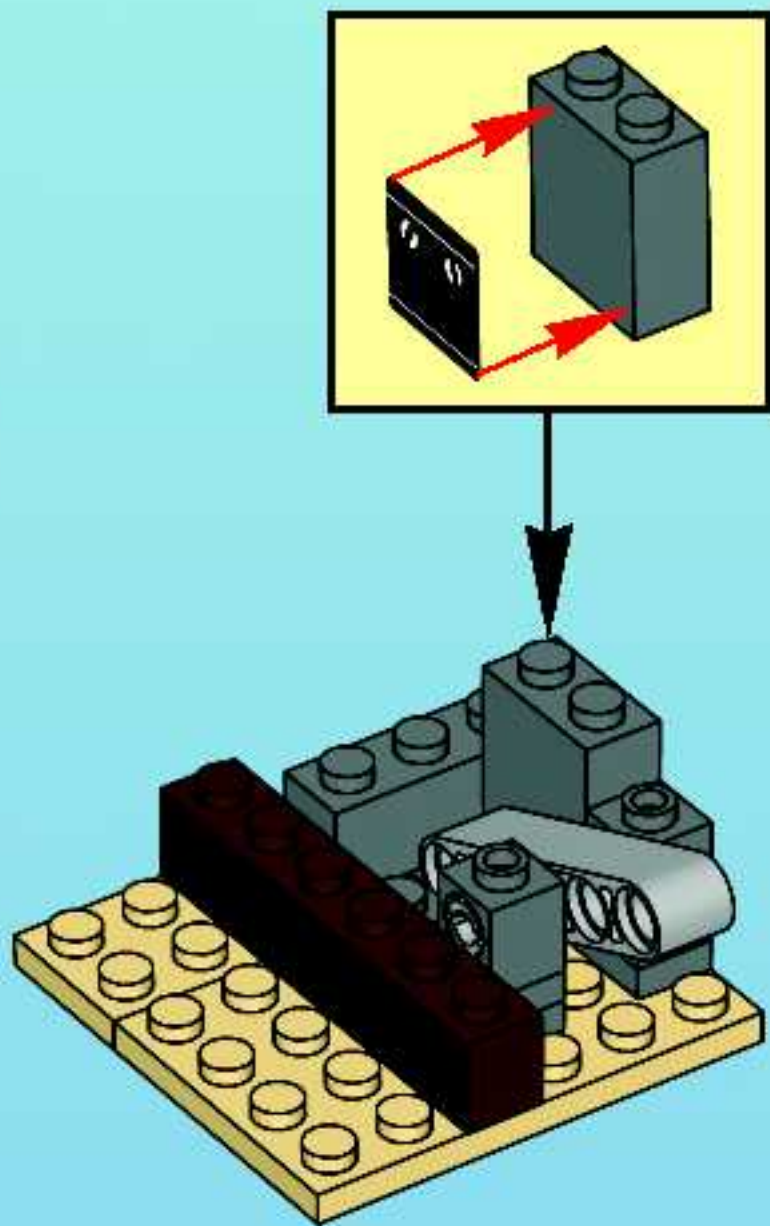

6

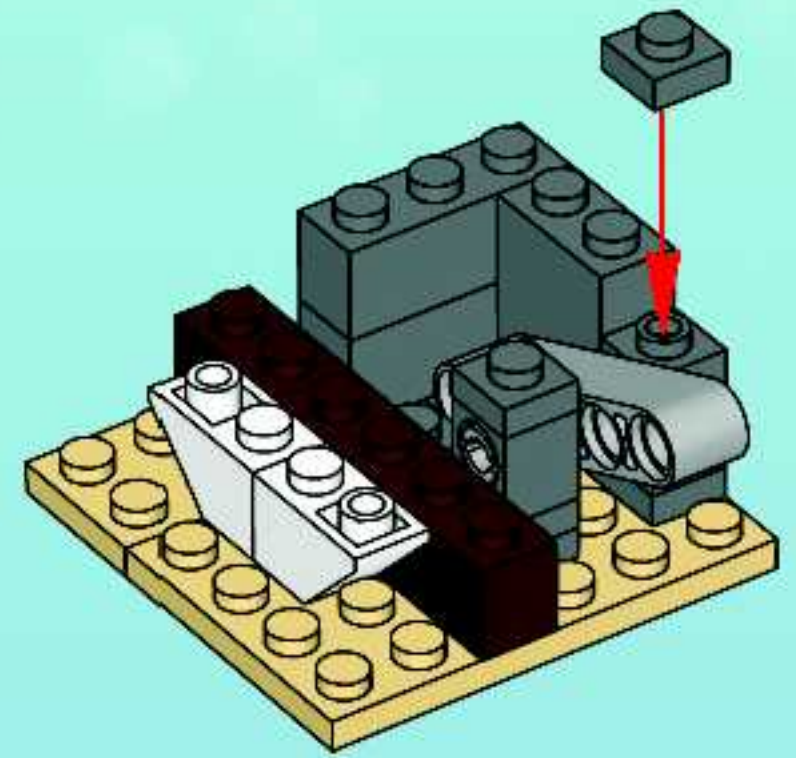

7

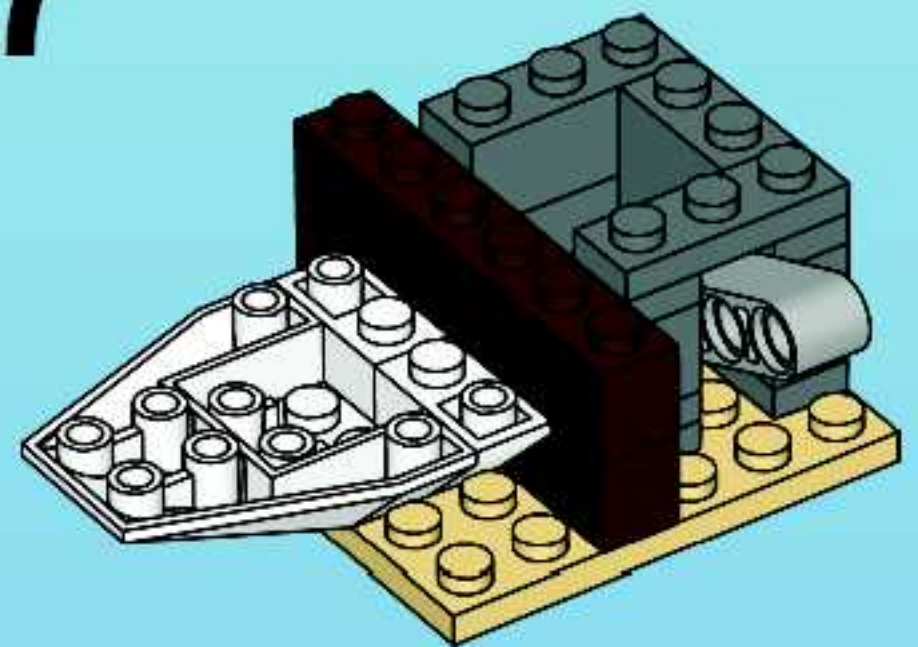

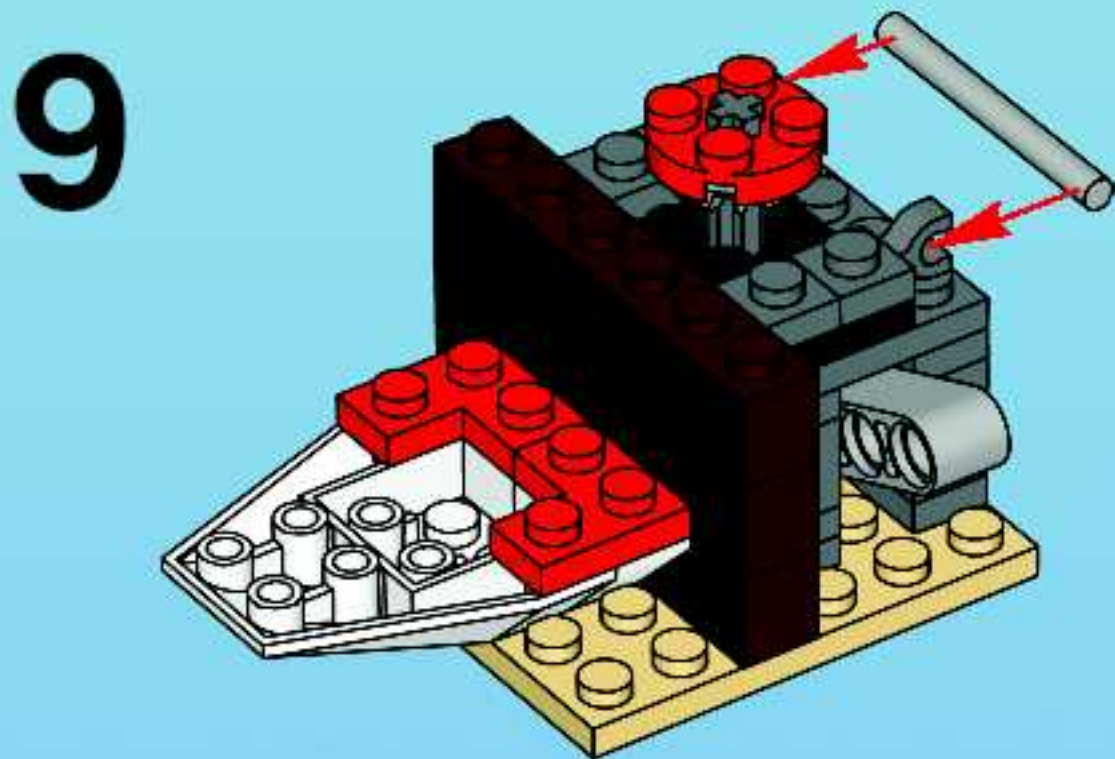
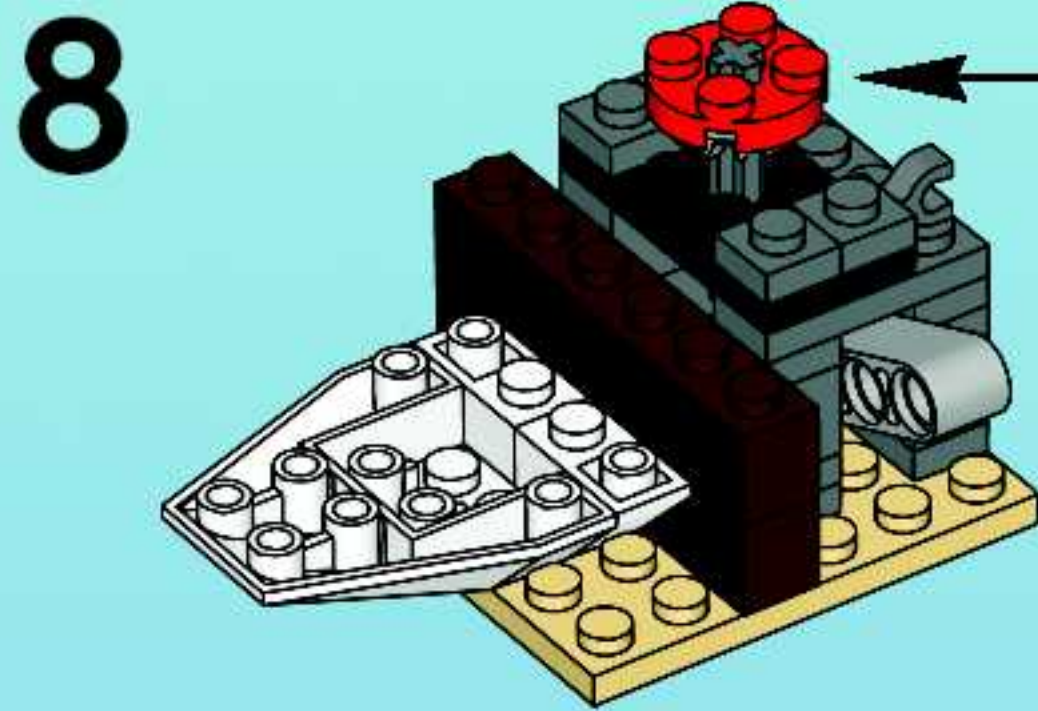
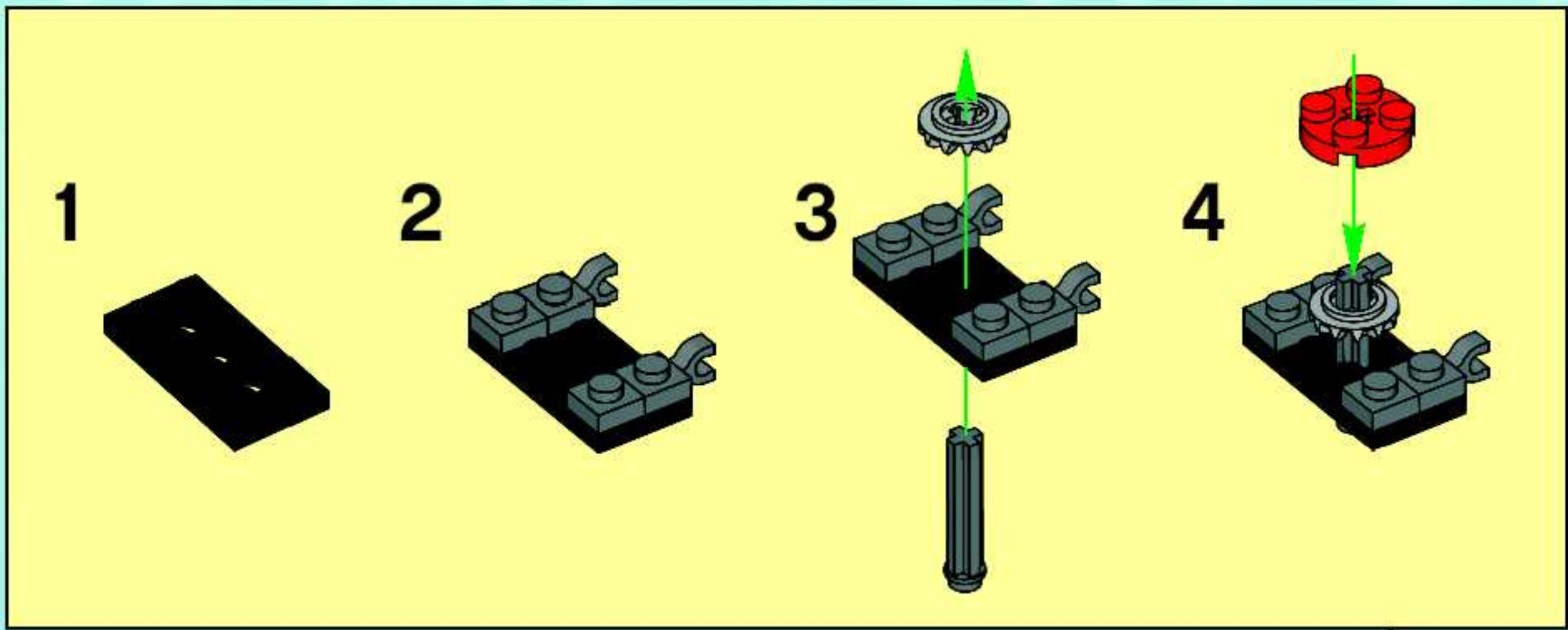

10

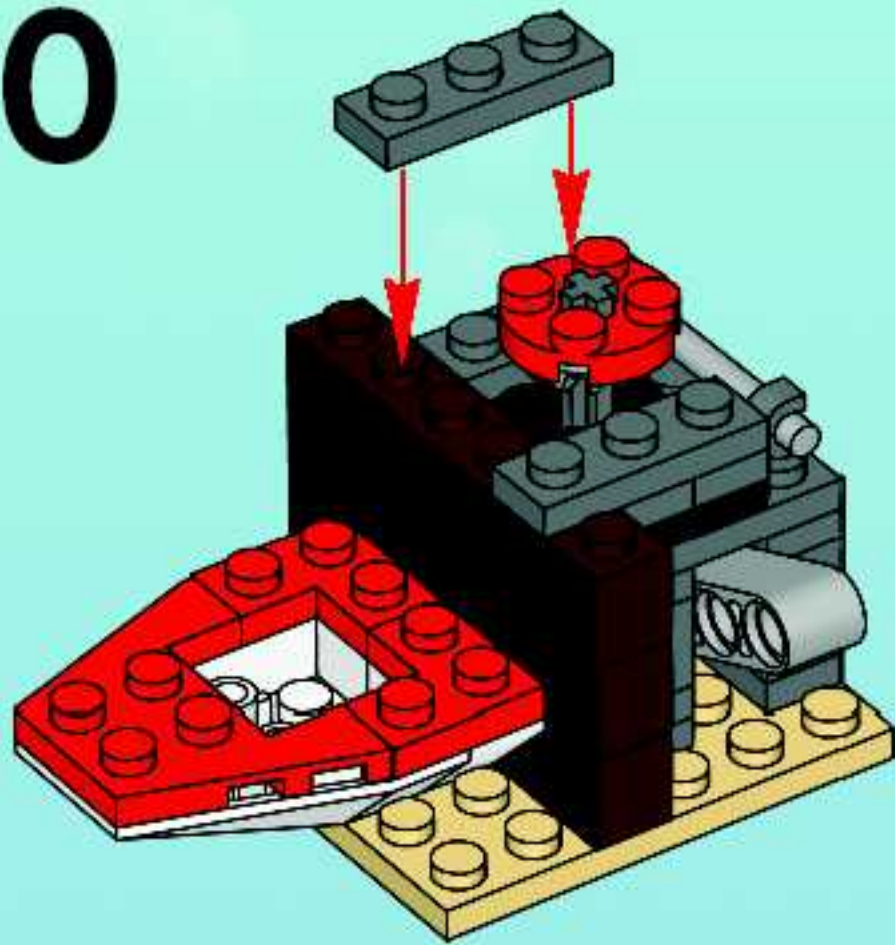

12

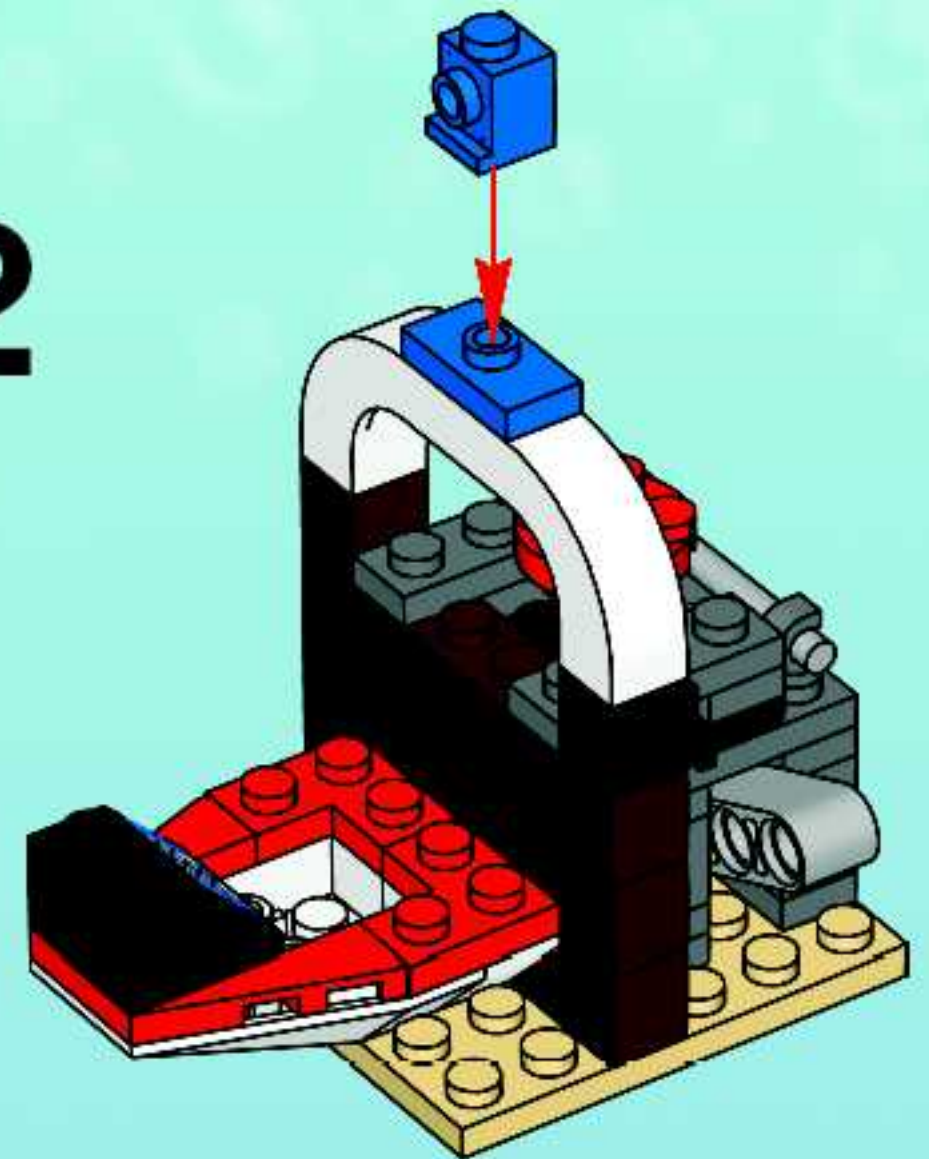

11

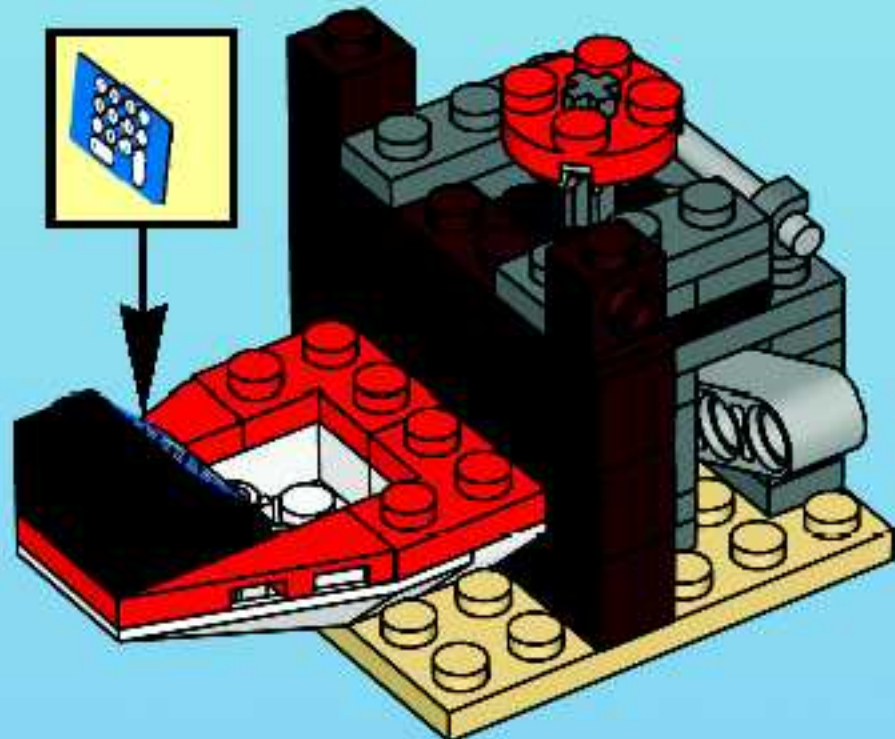

13

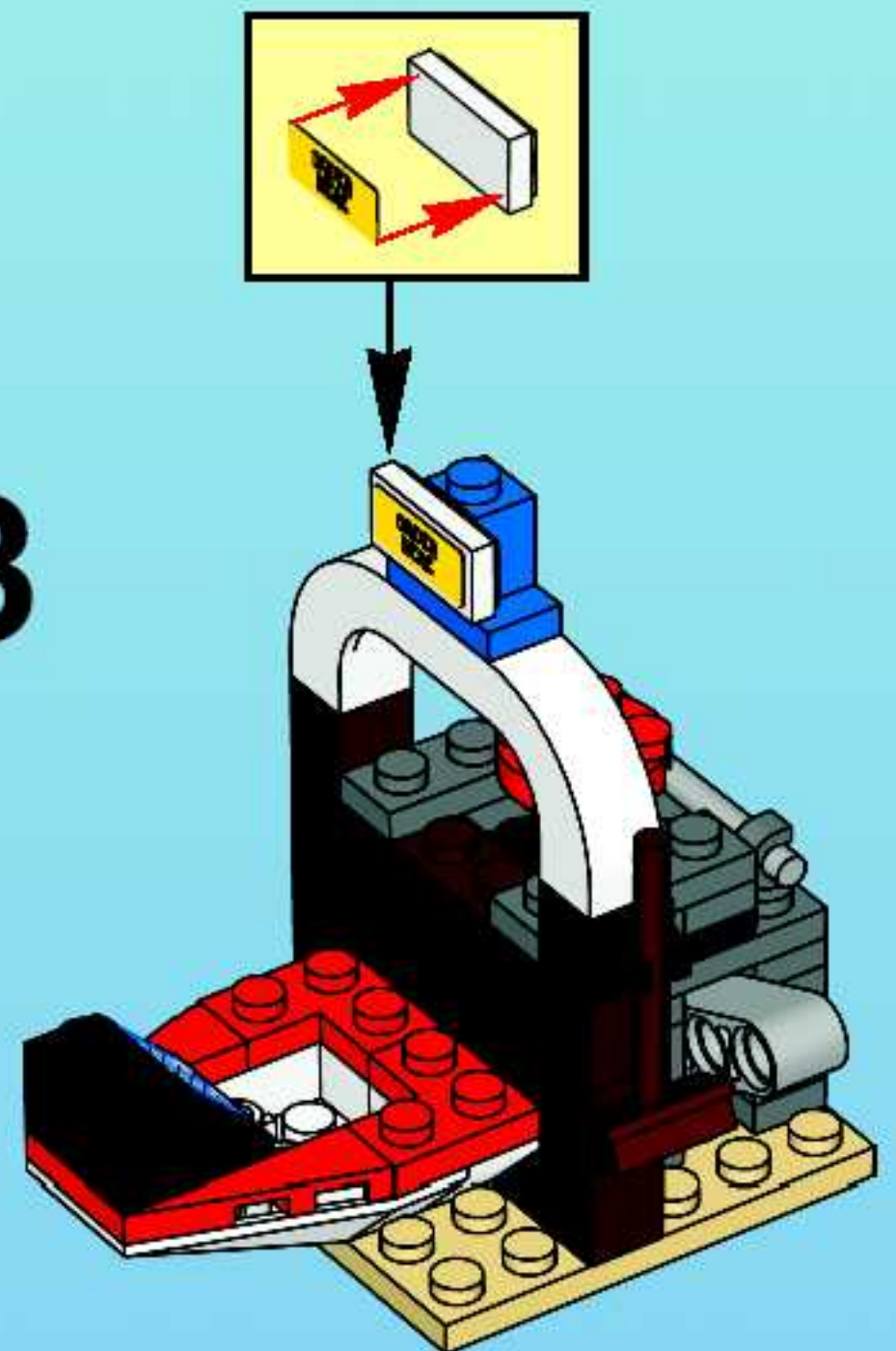



1

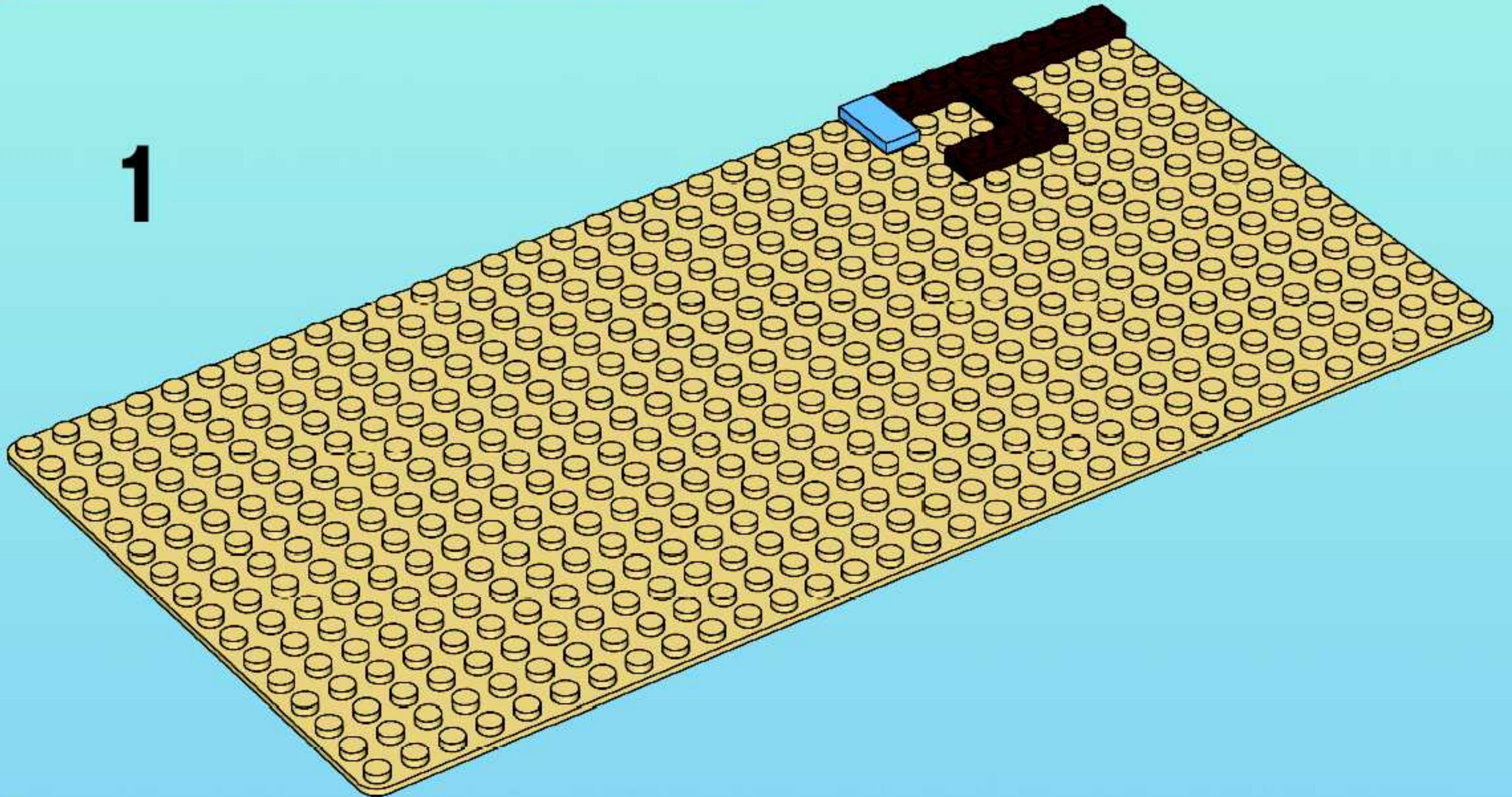



2

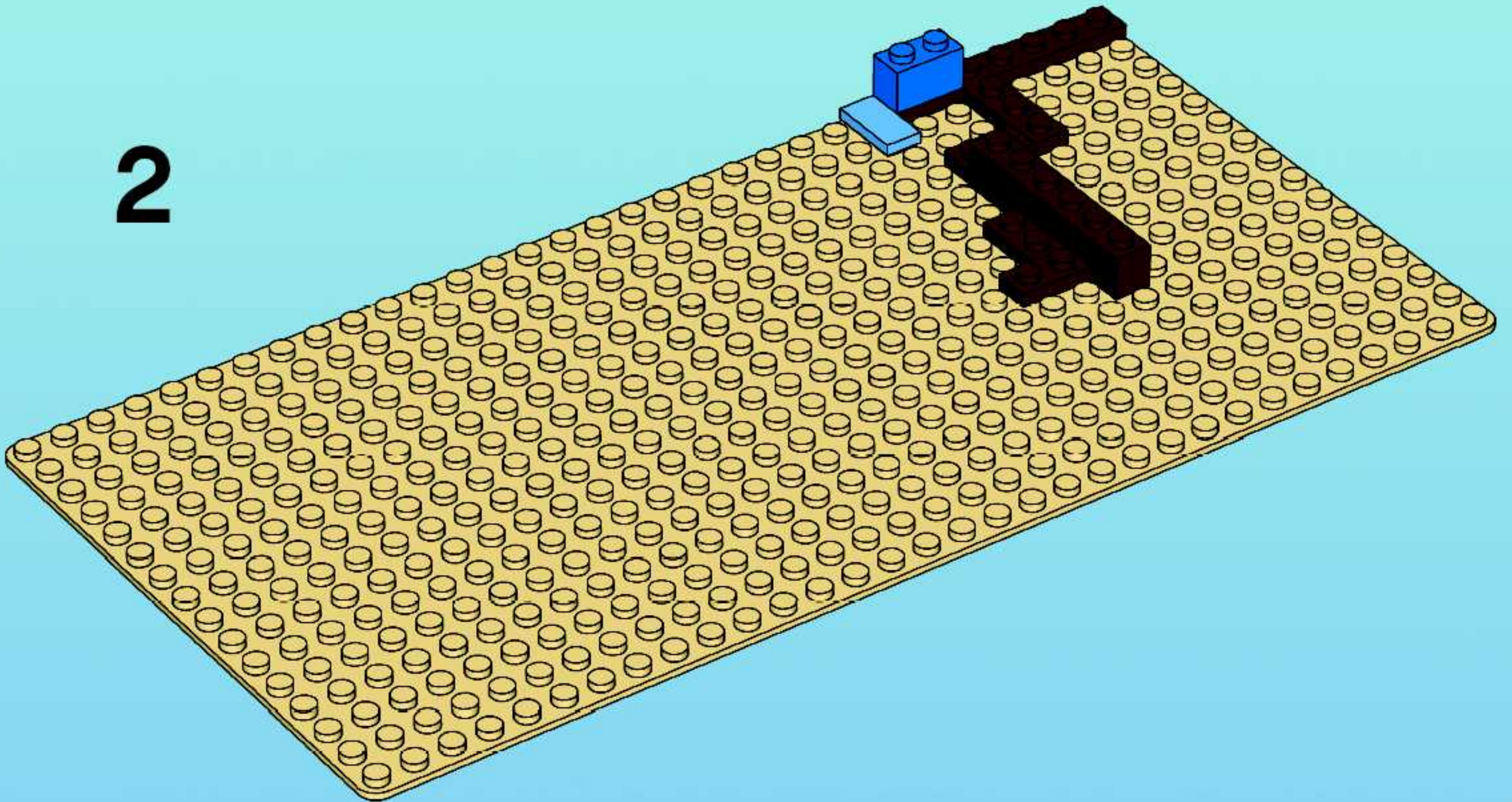

3

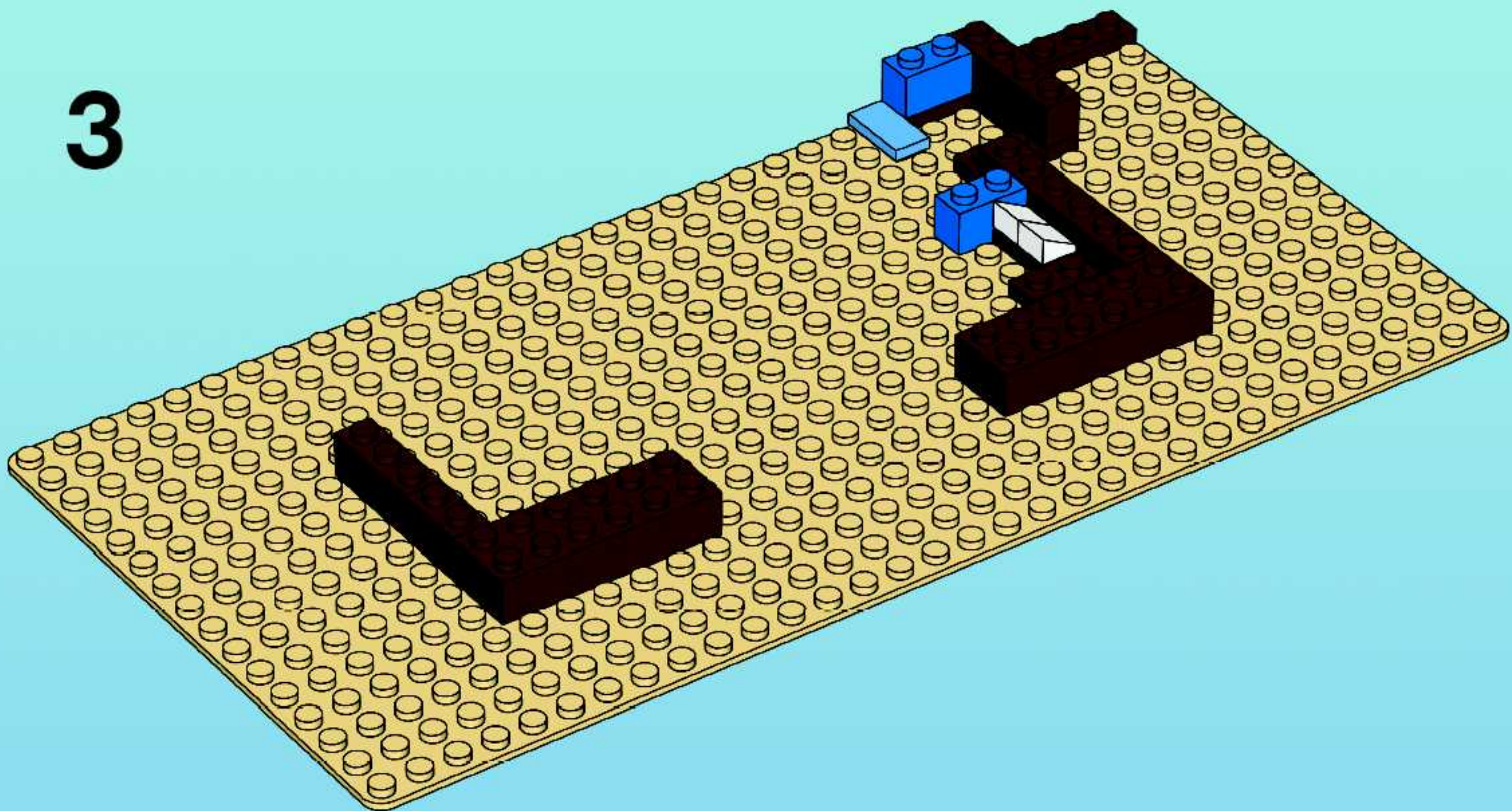

4

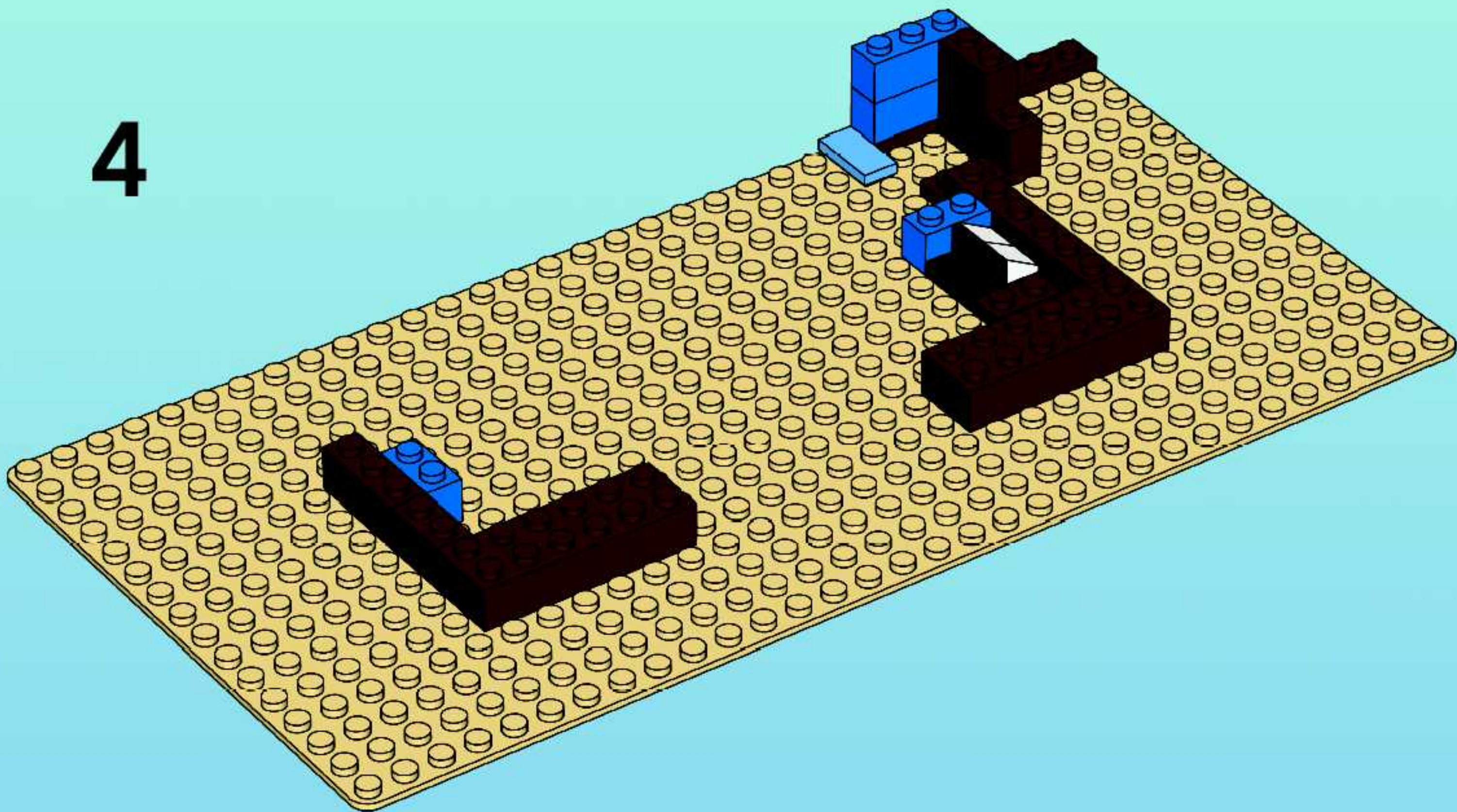





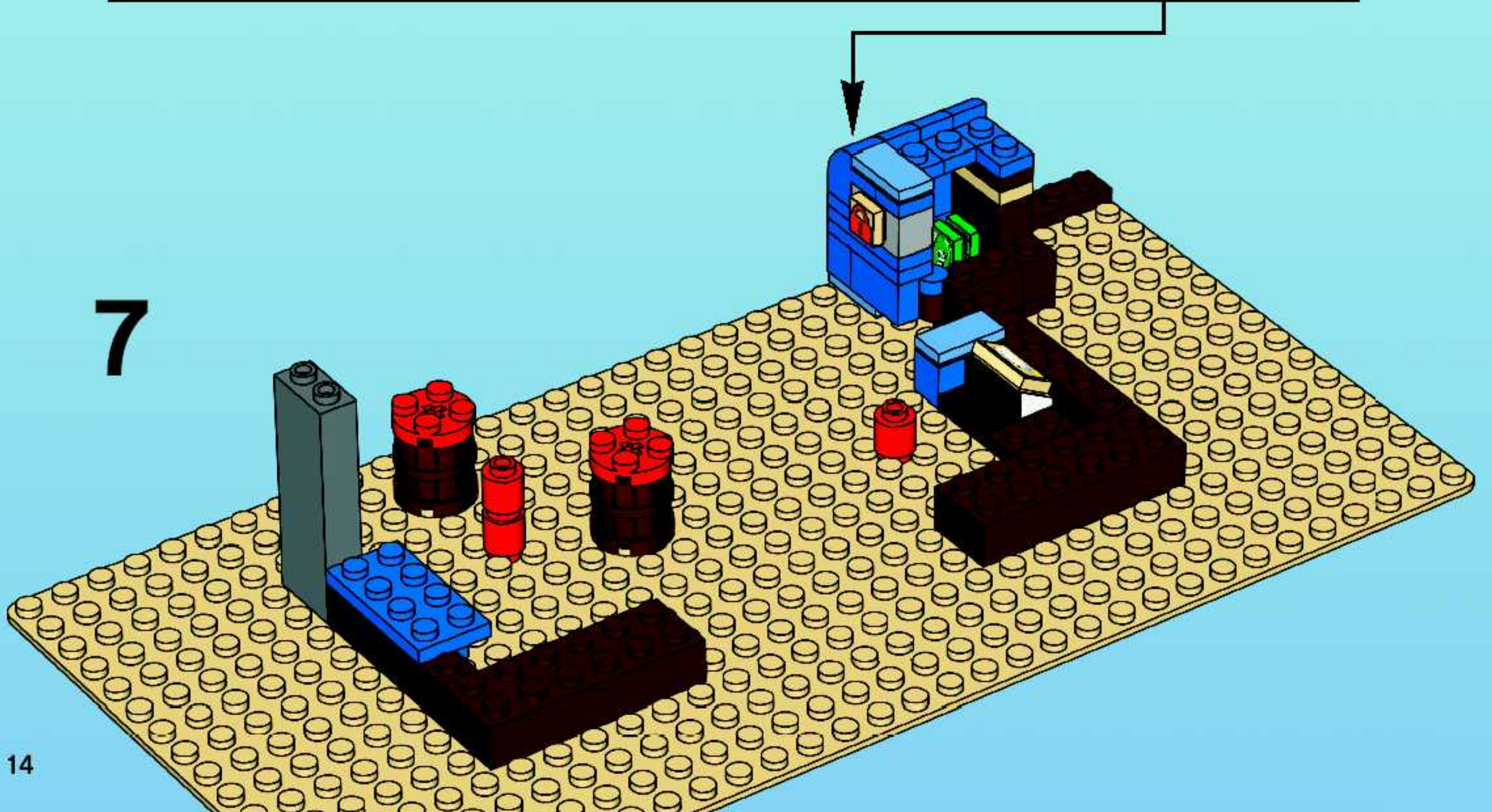
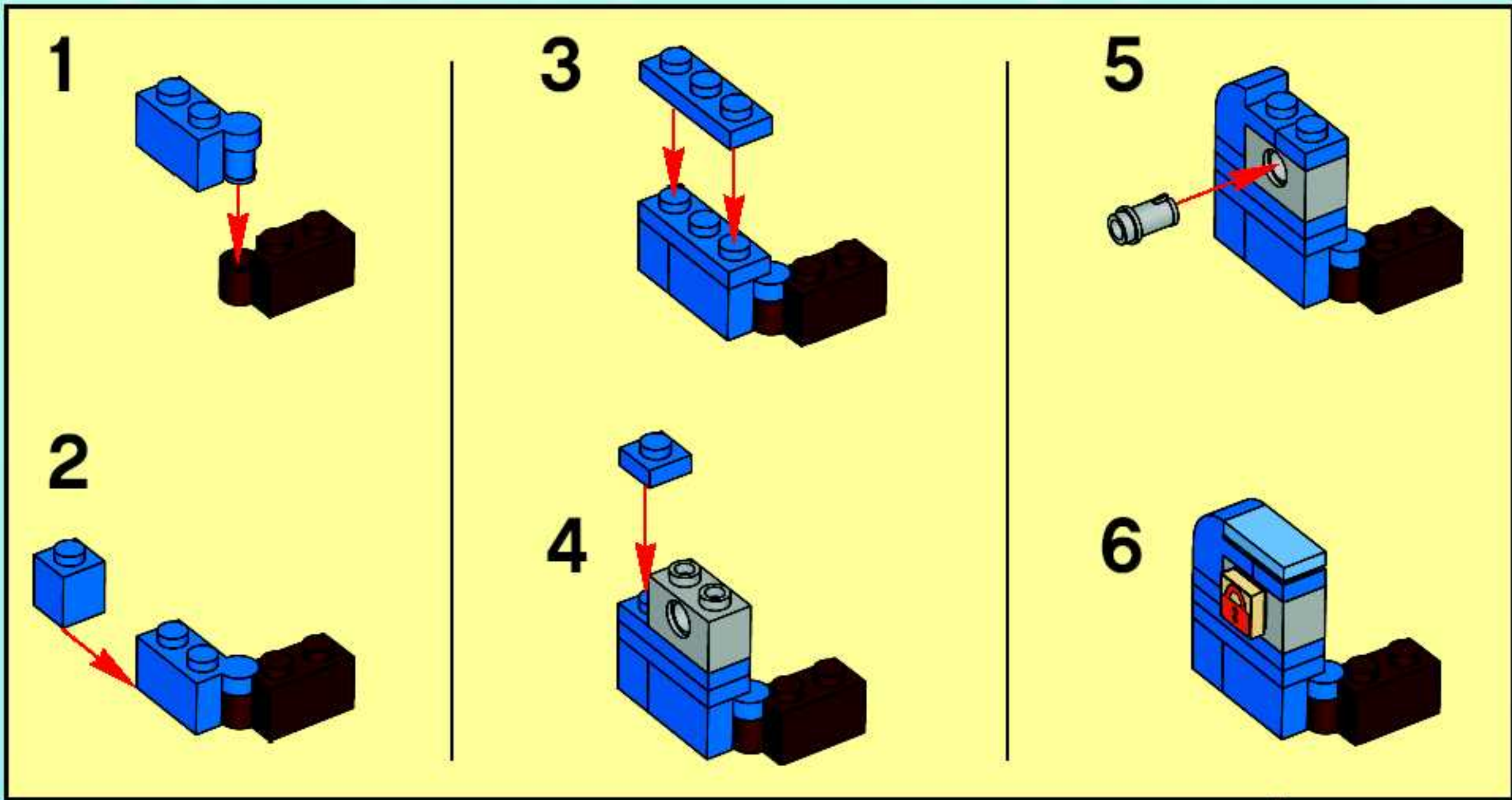

8

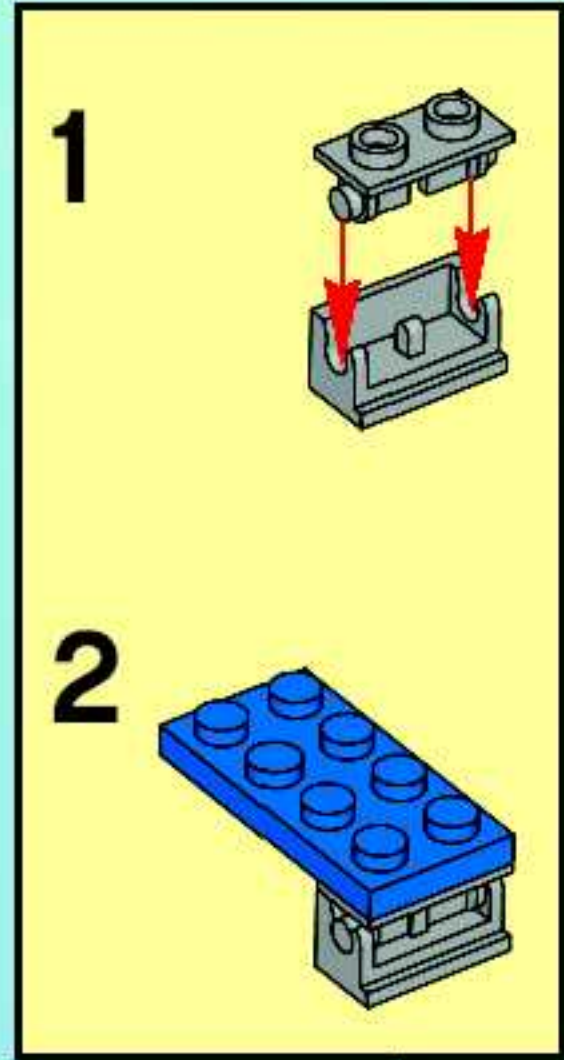
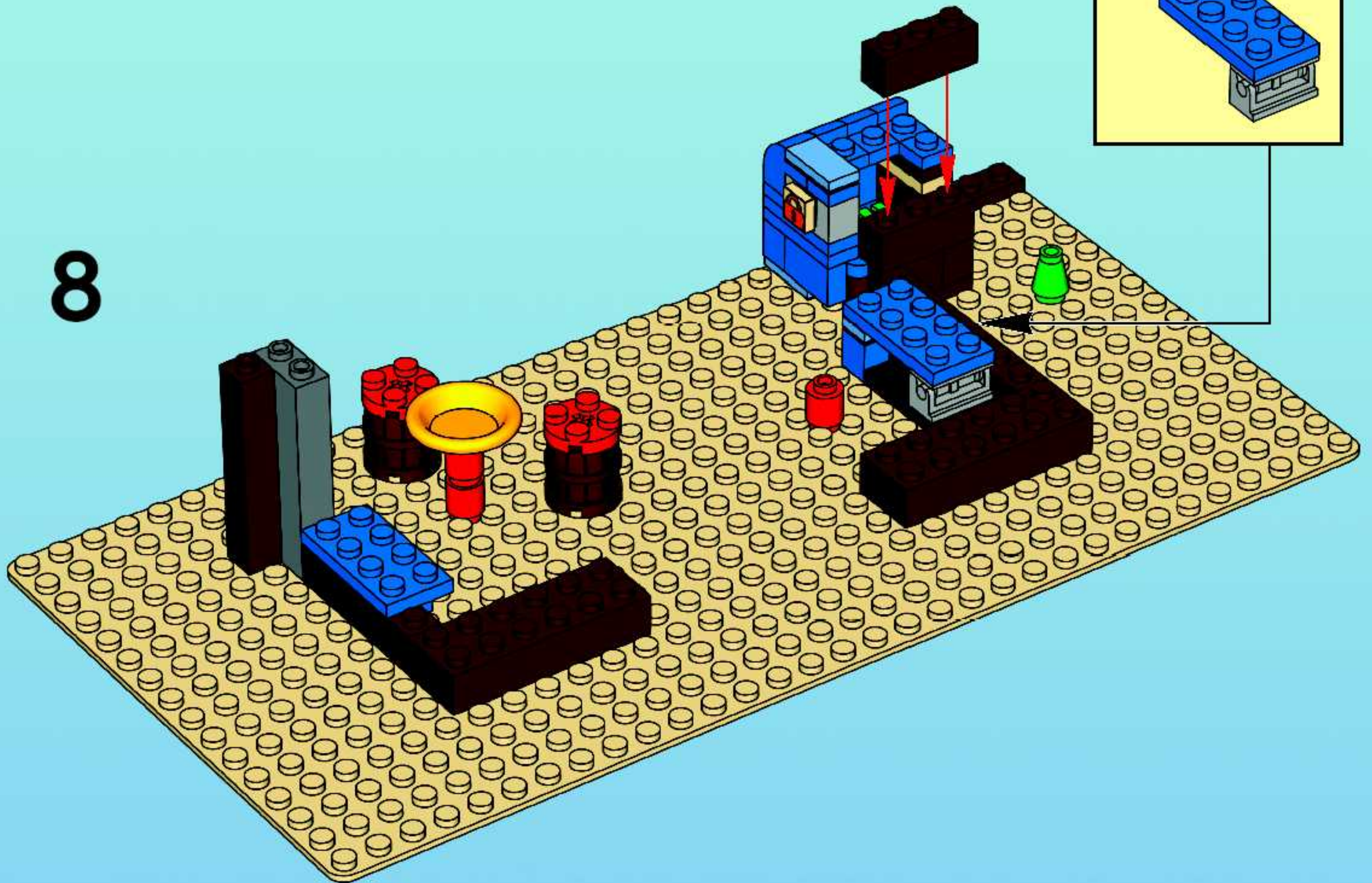





10

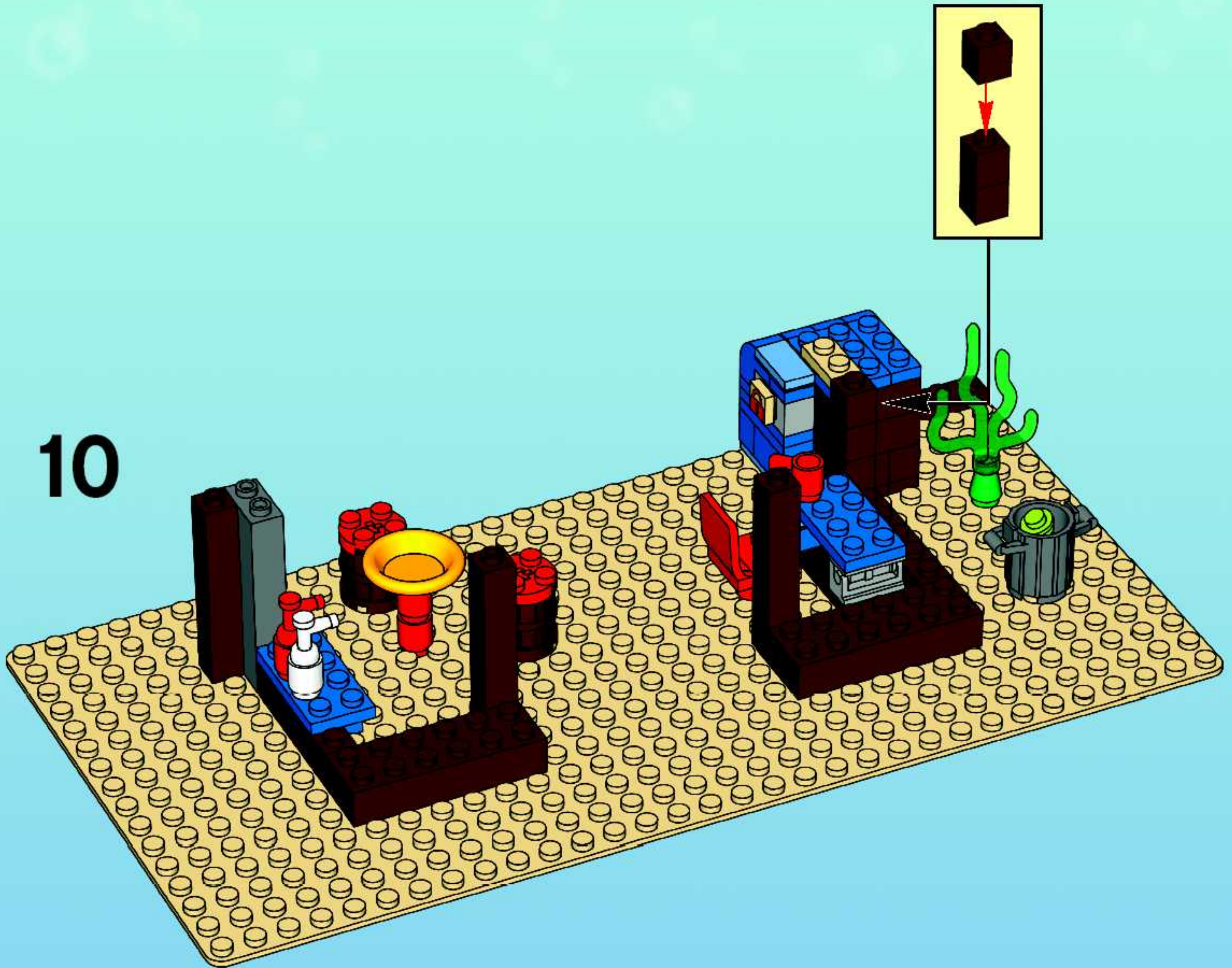

11

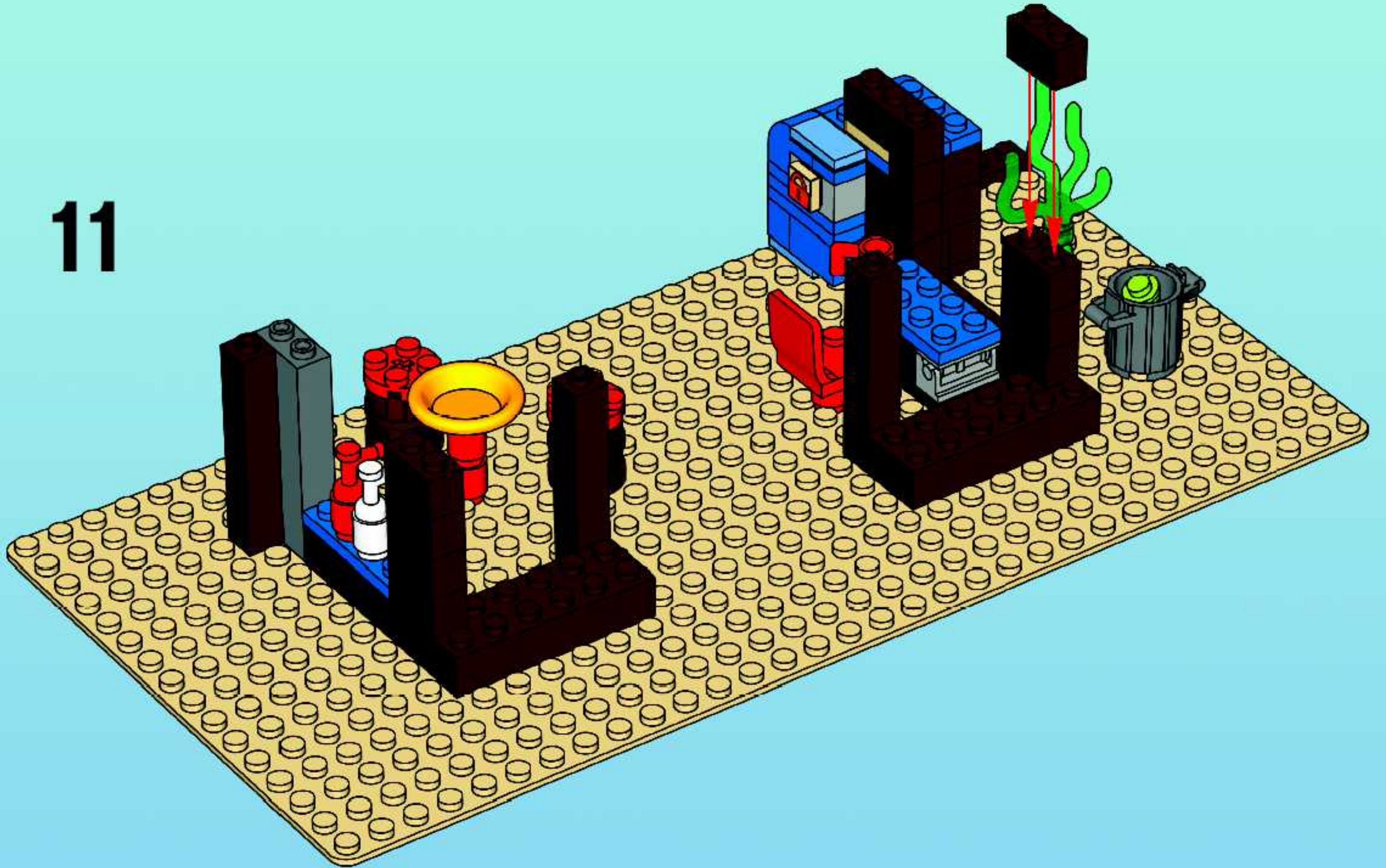

12

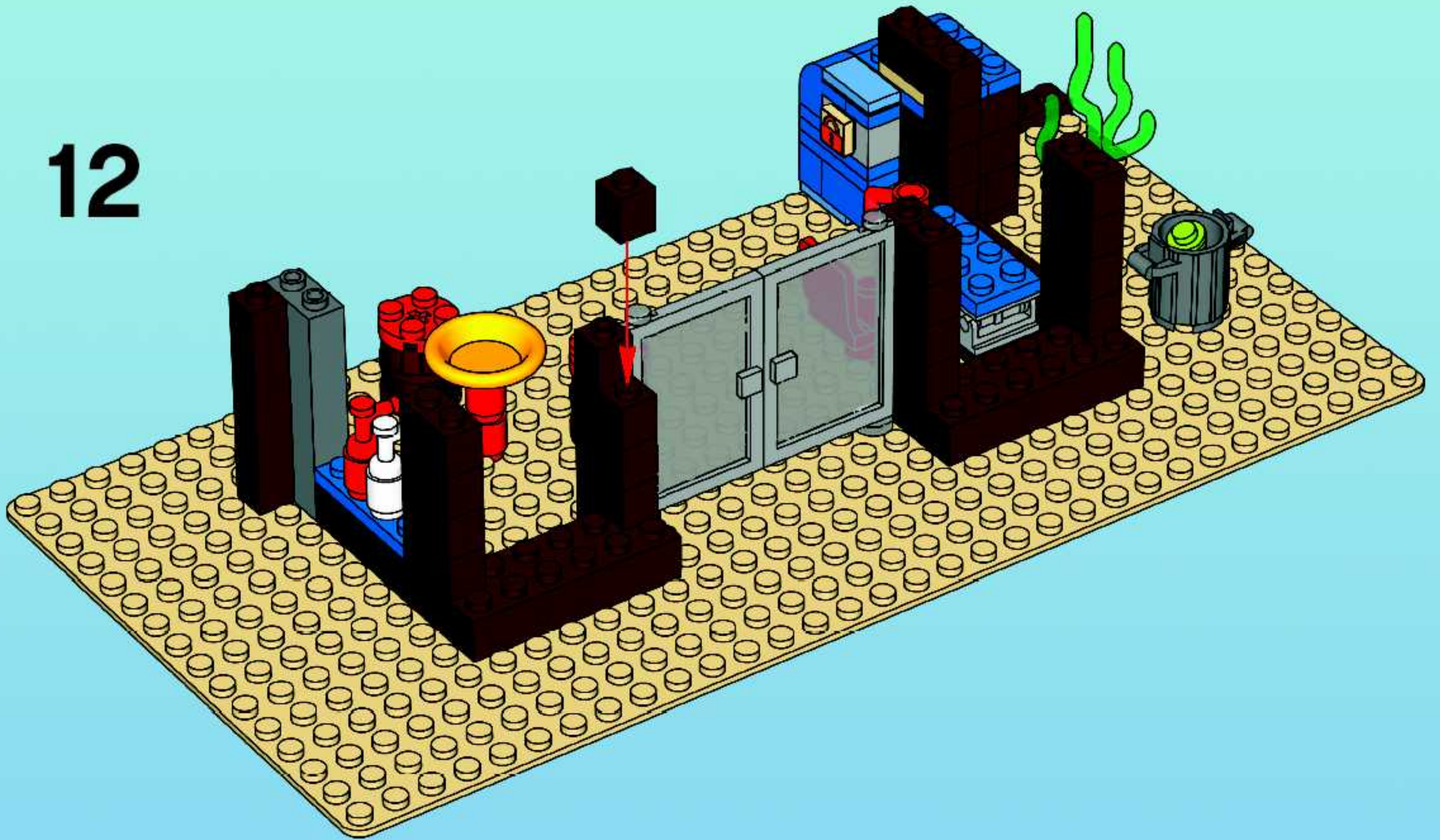

13

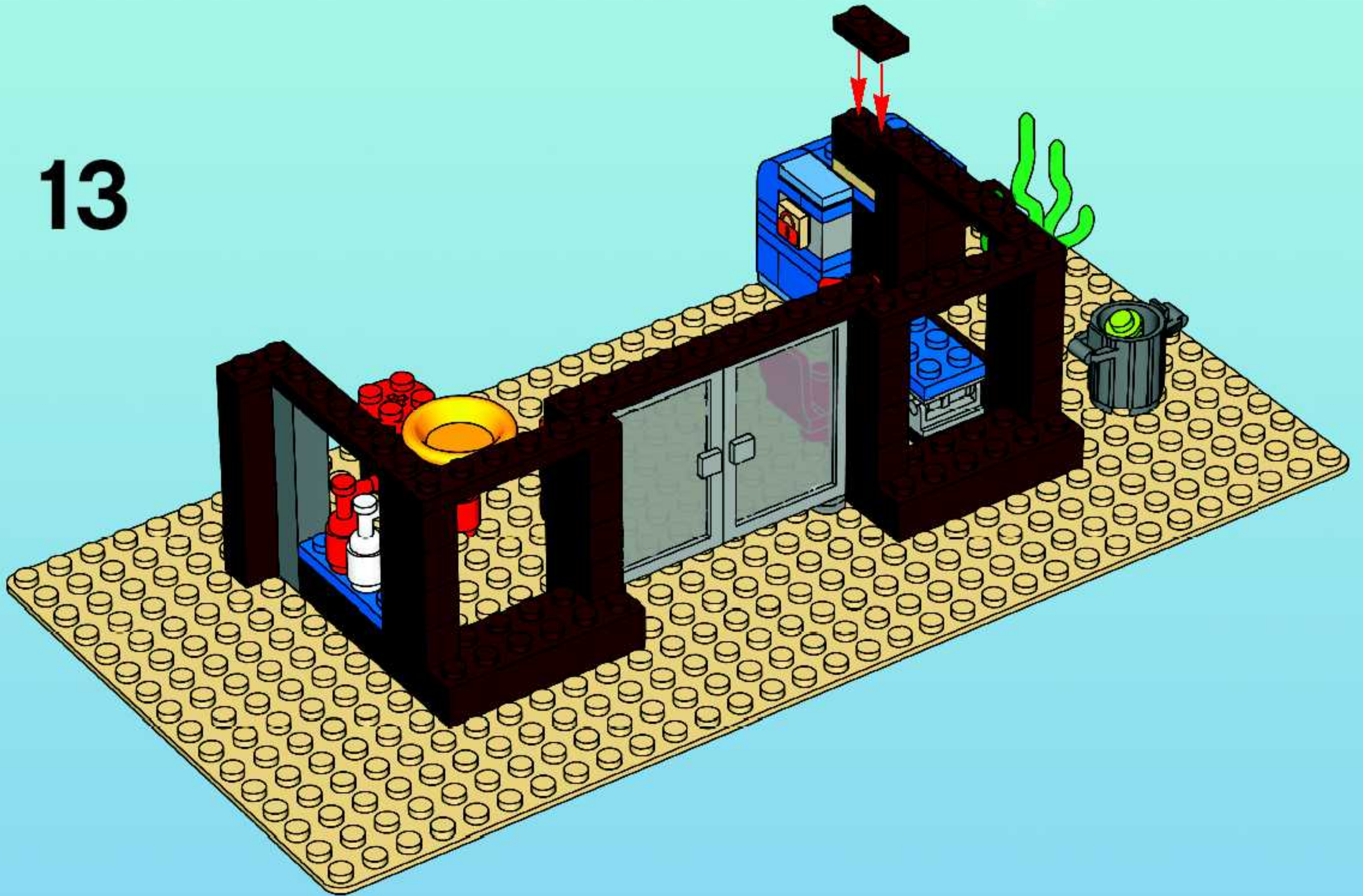

14

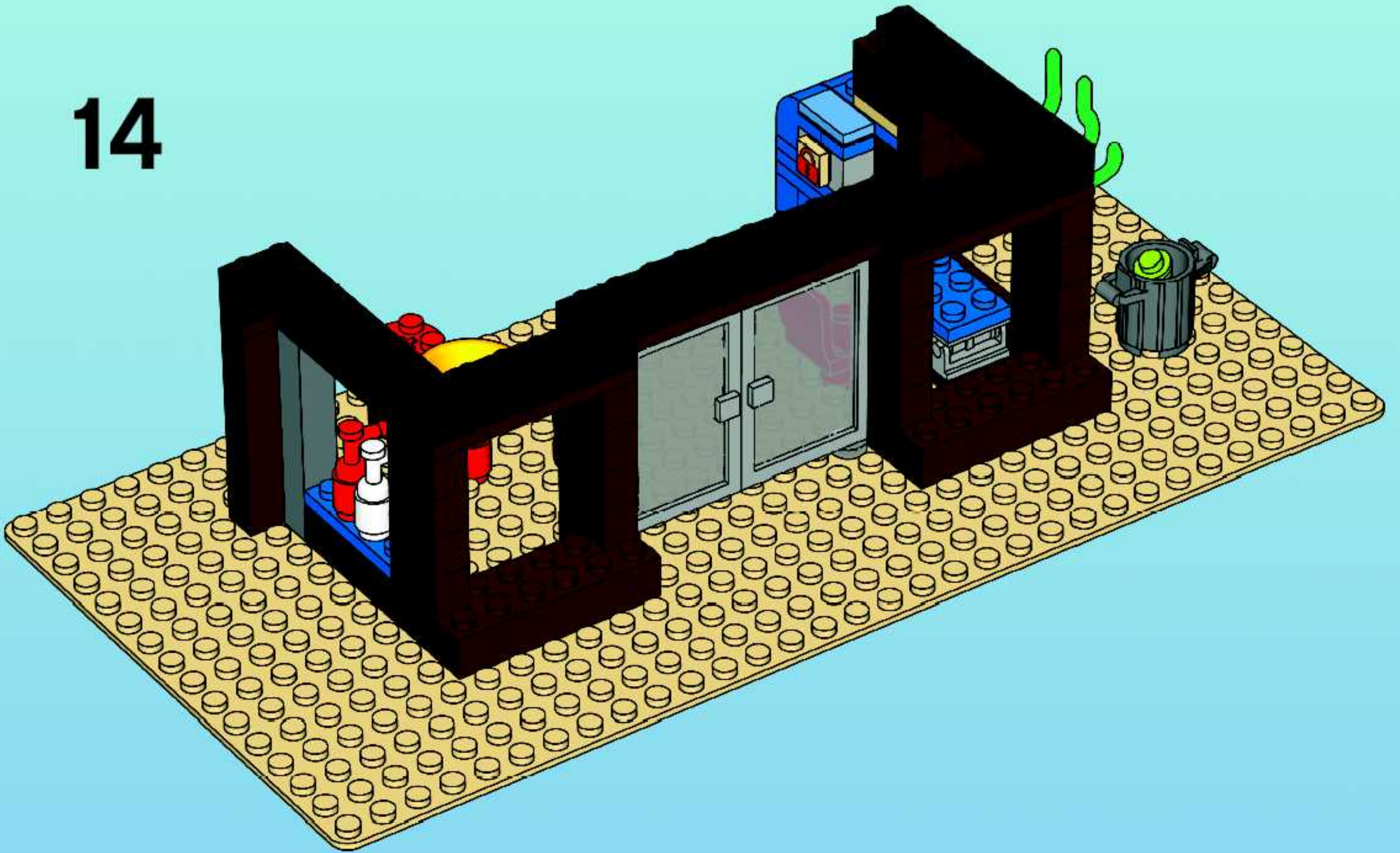

15

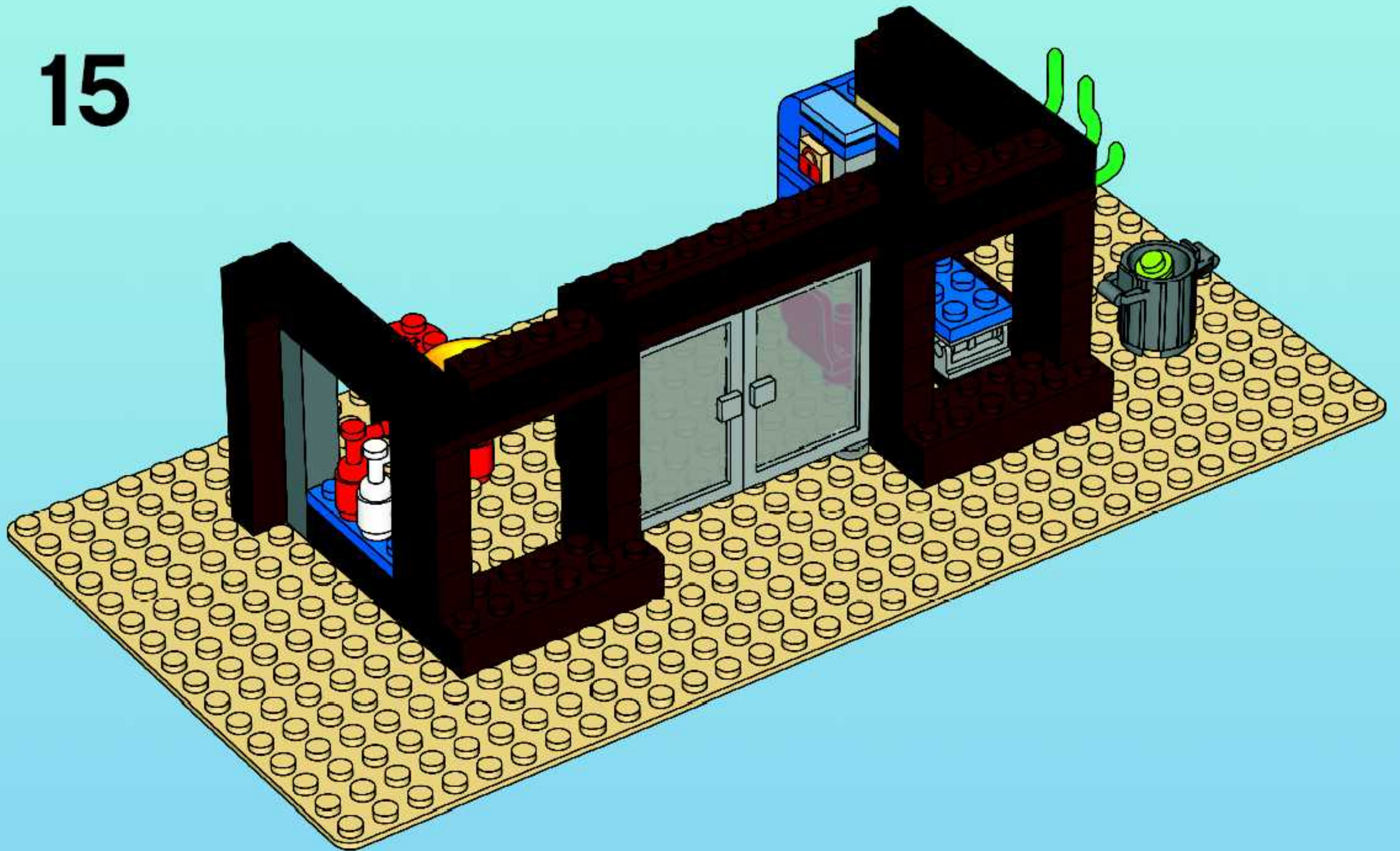

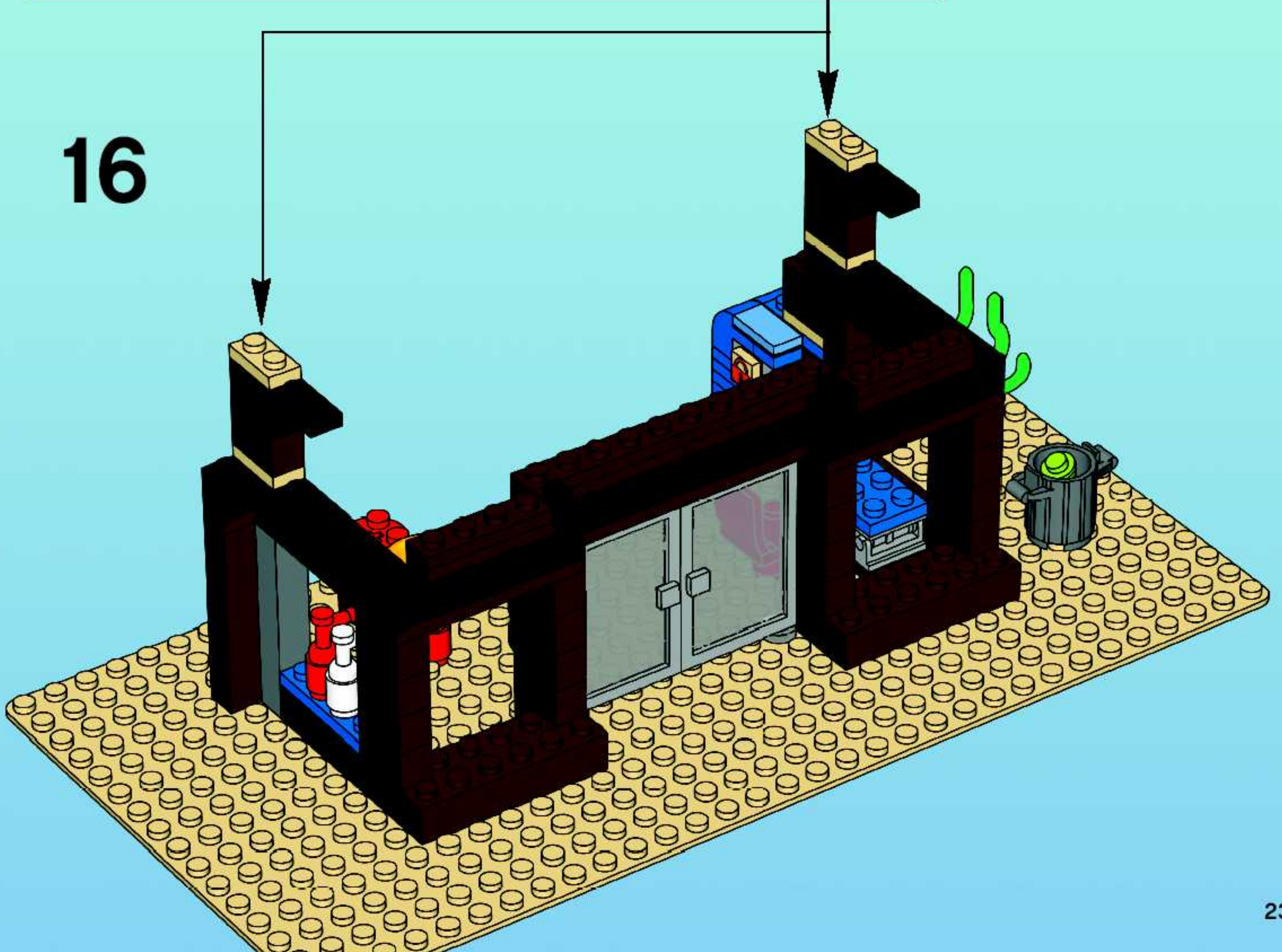
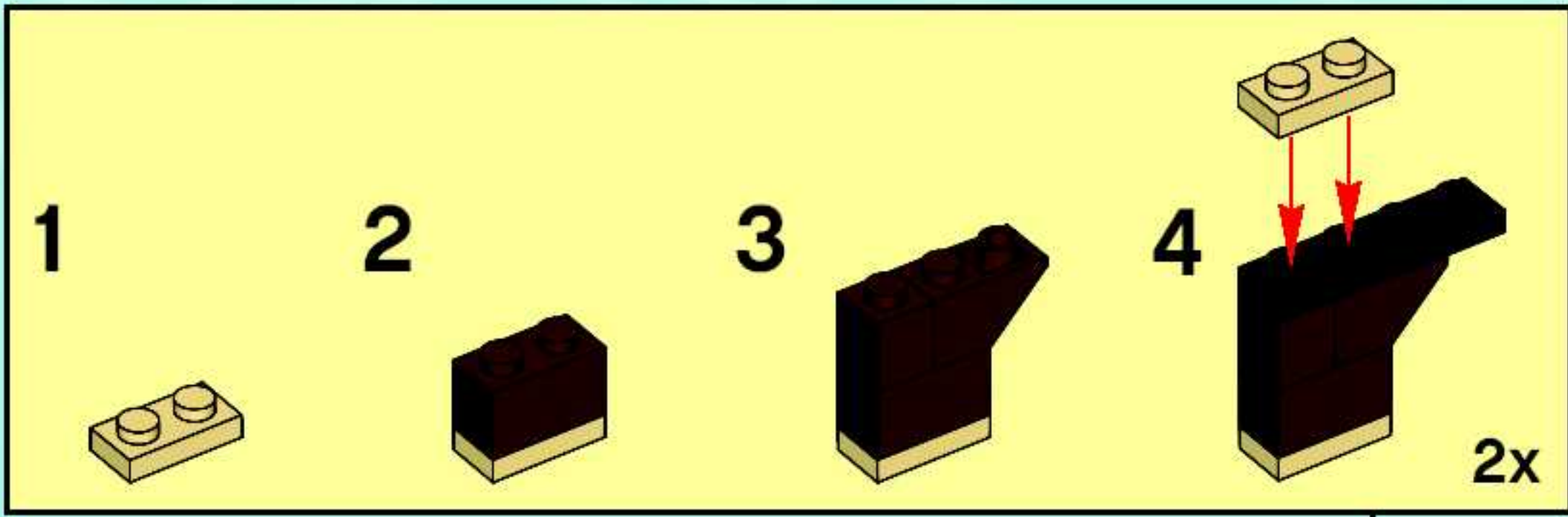

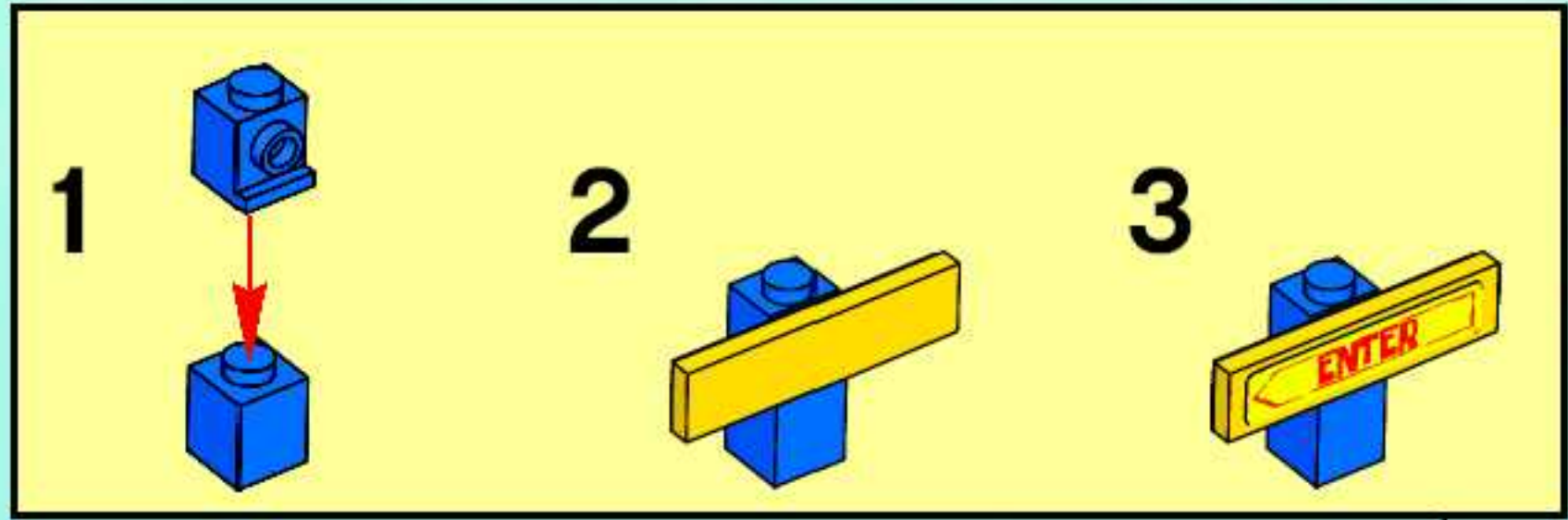

17

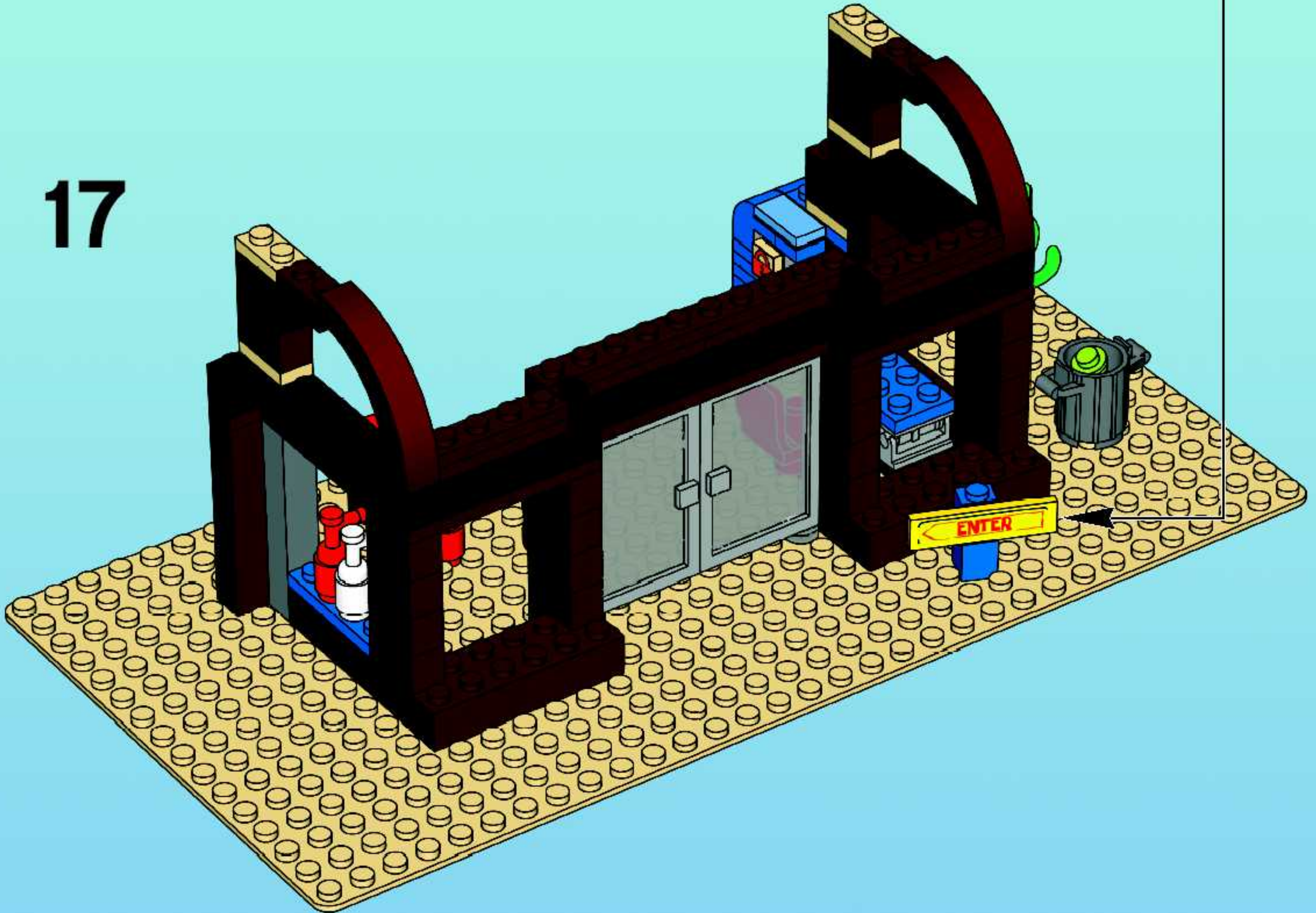



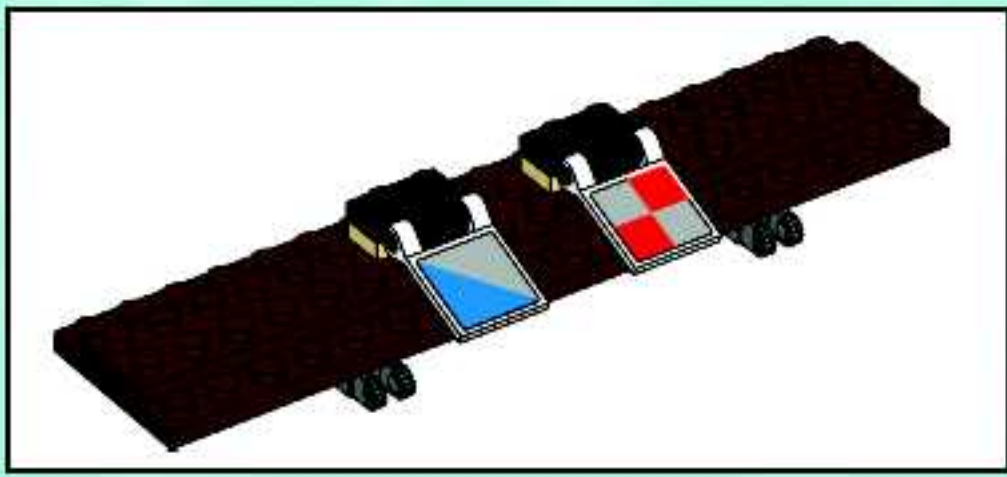

1

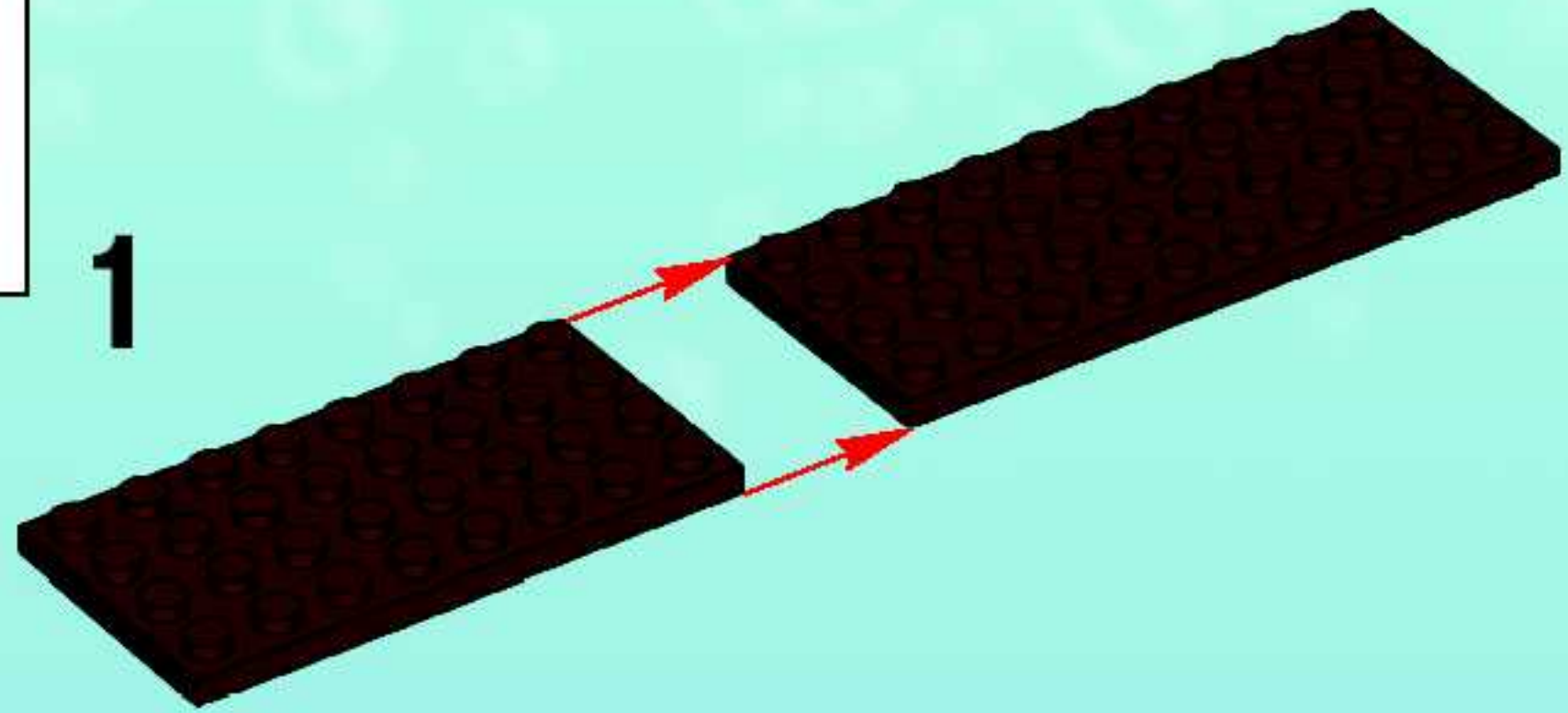

2

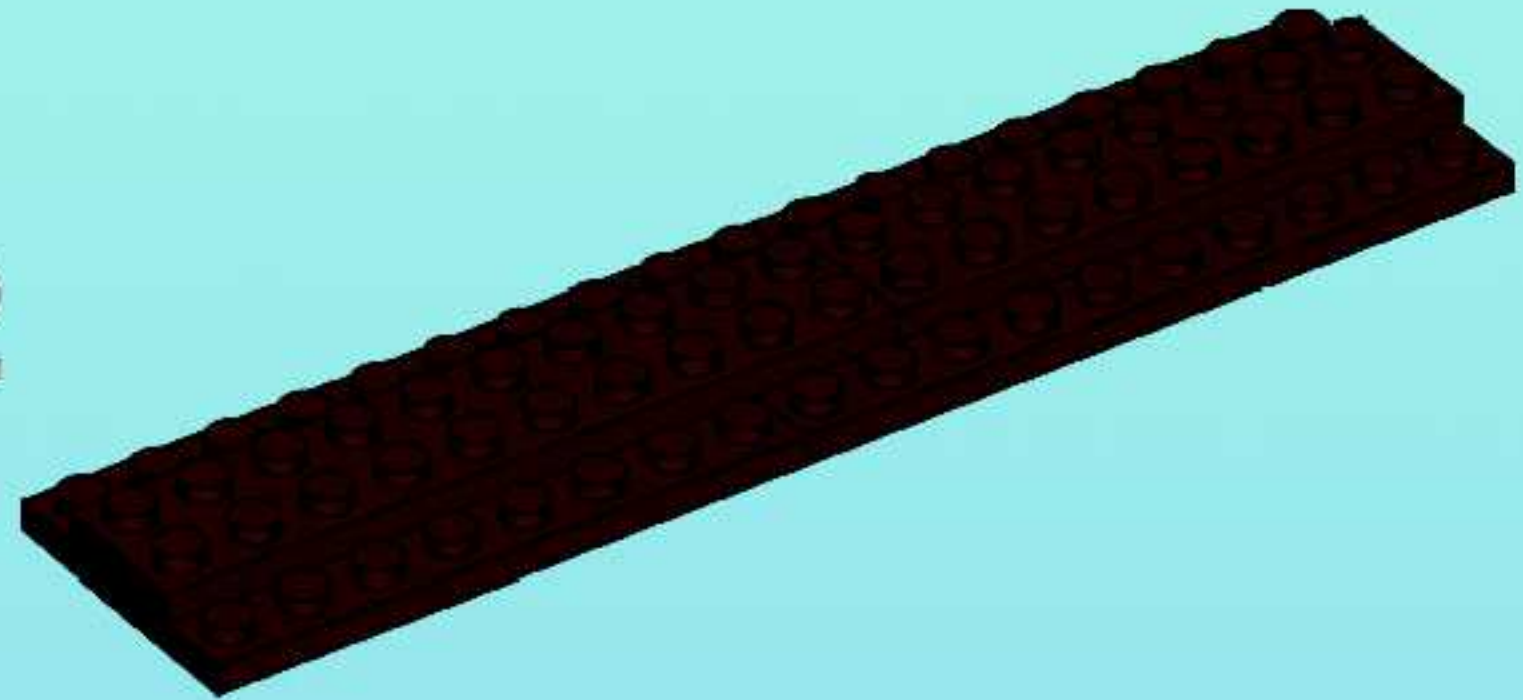

3

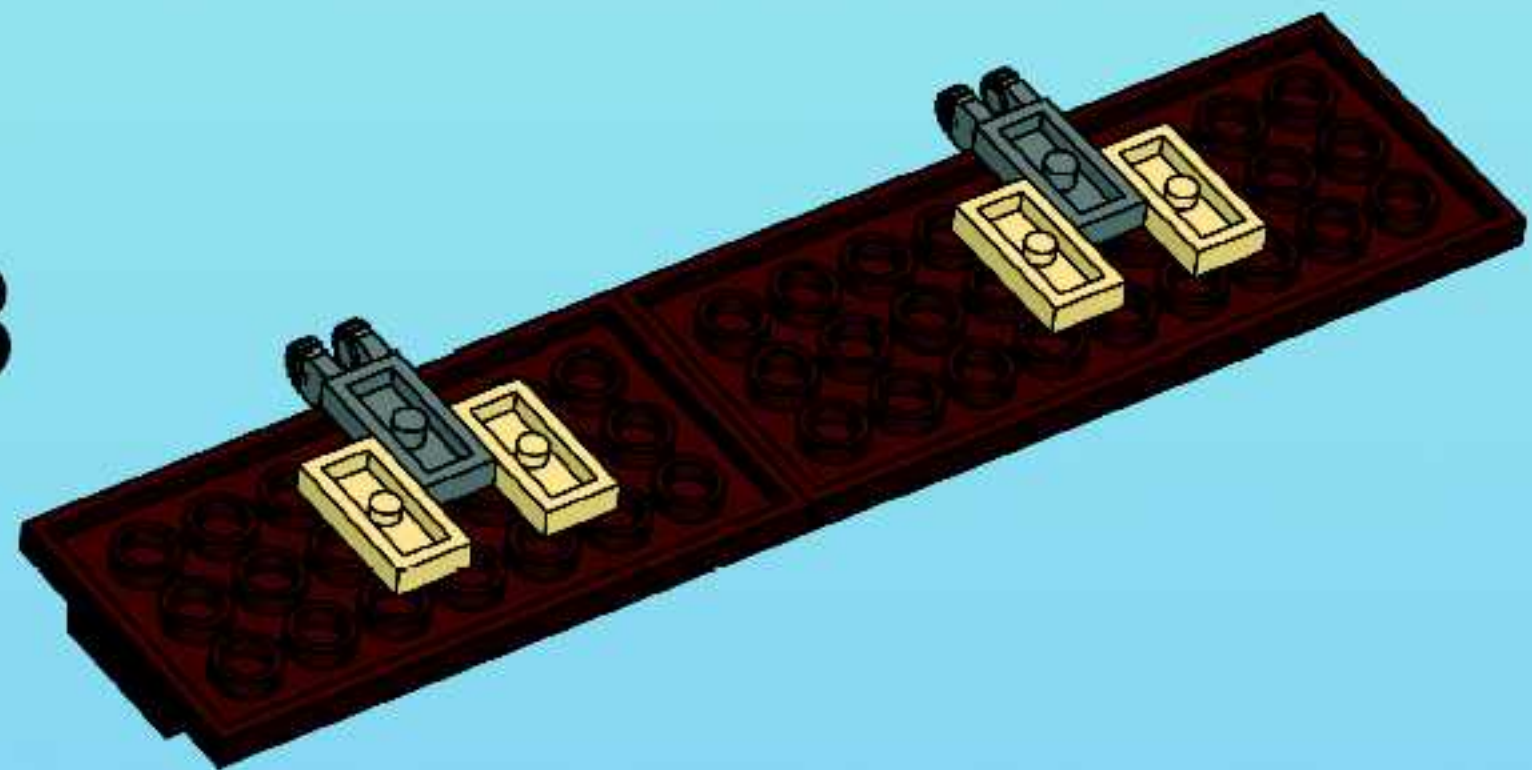

4

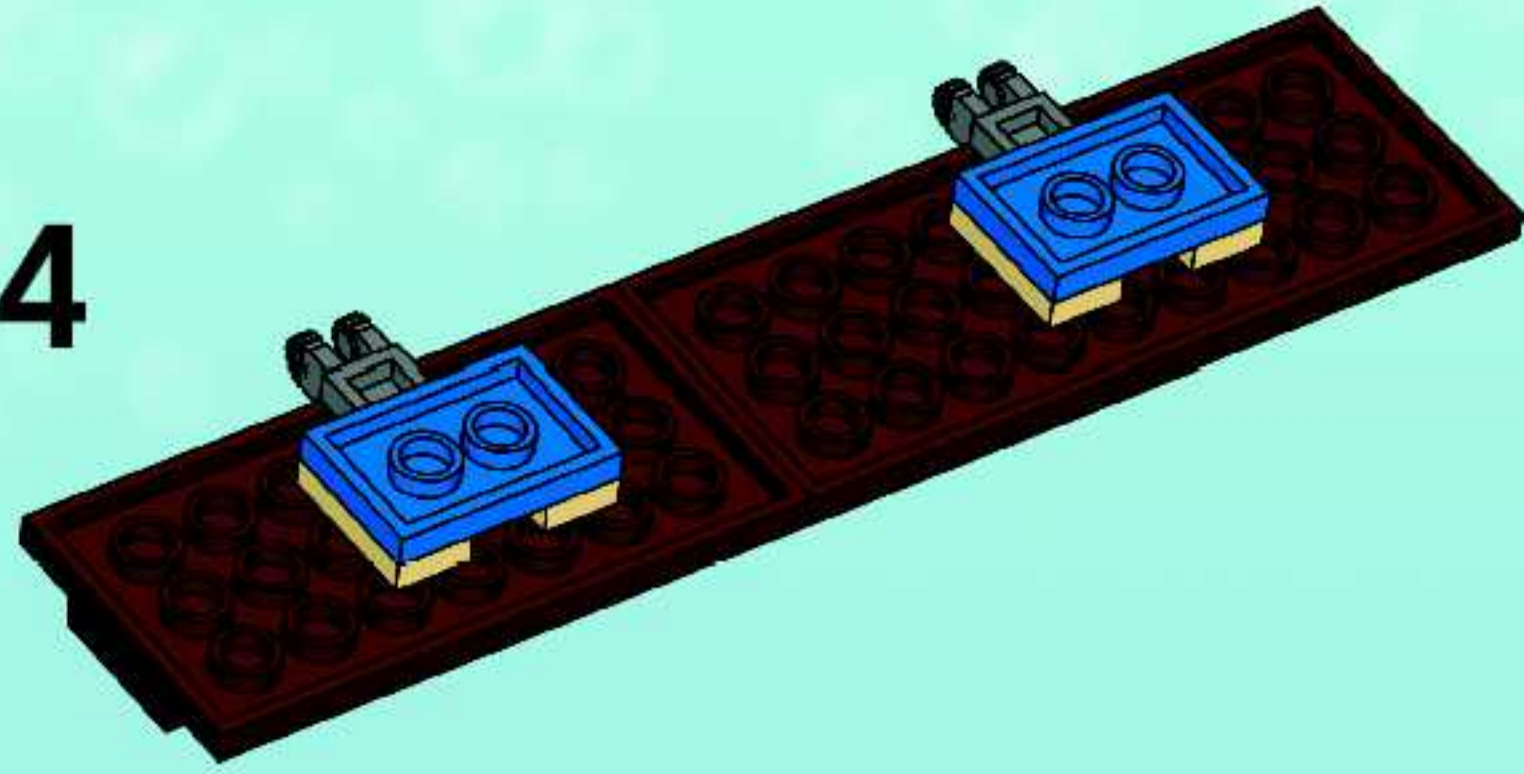

5

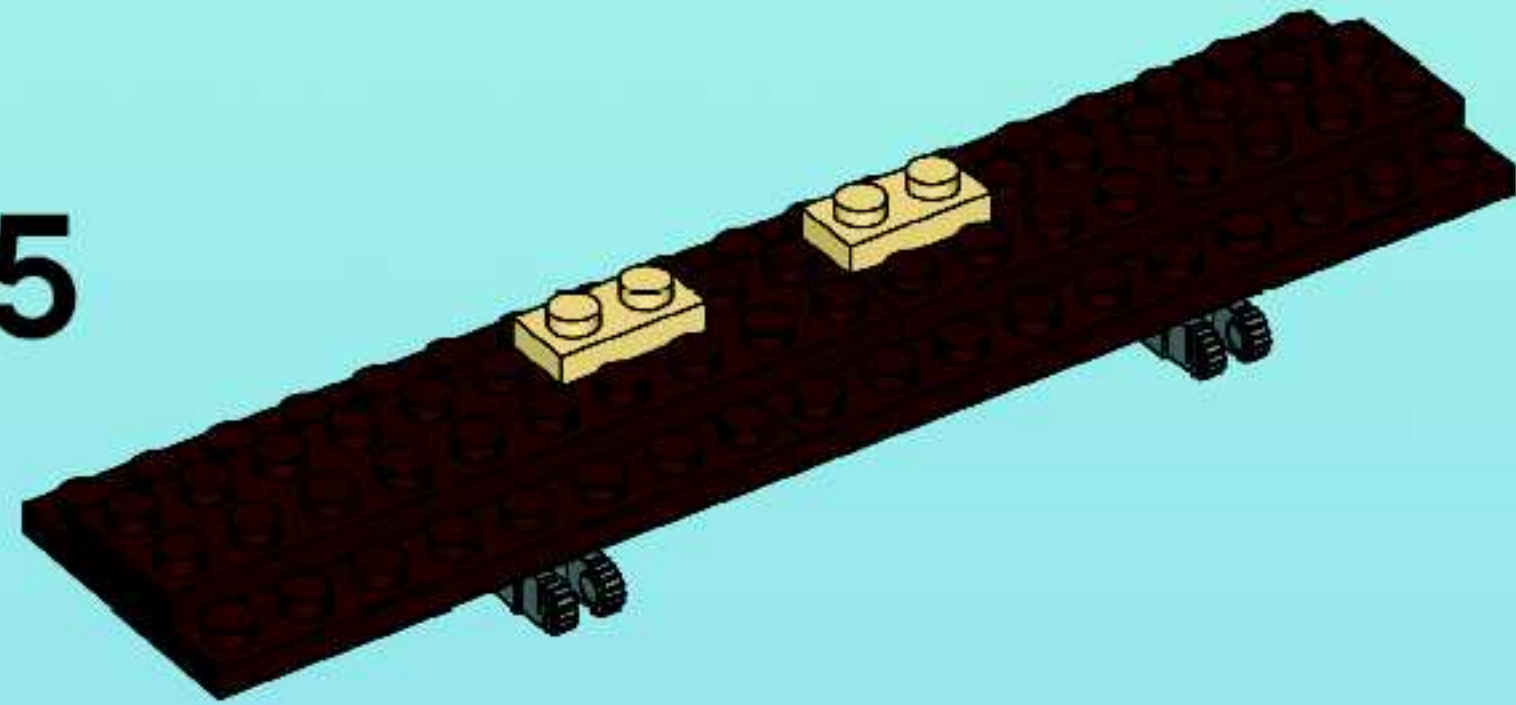

6

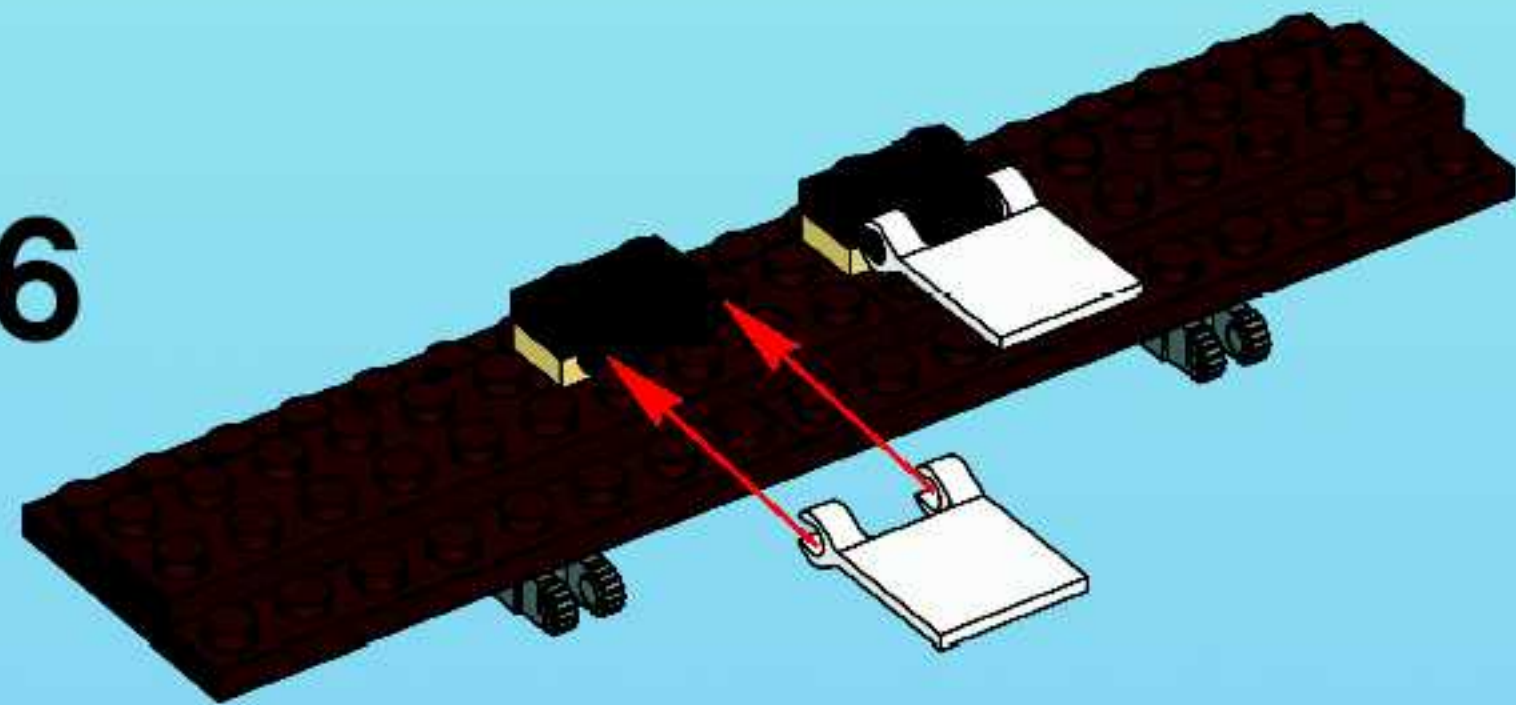

7

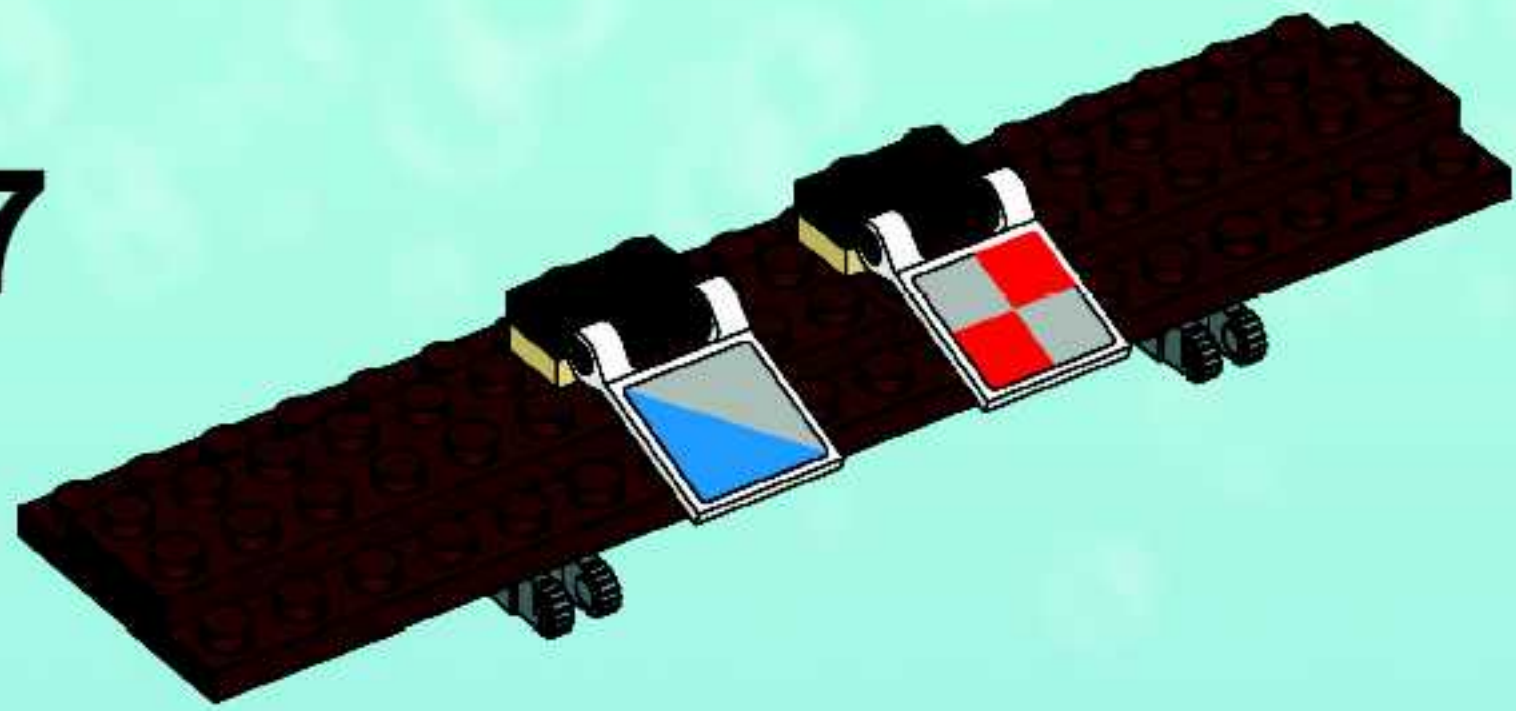

18

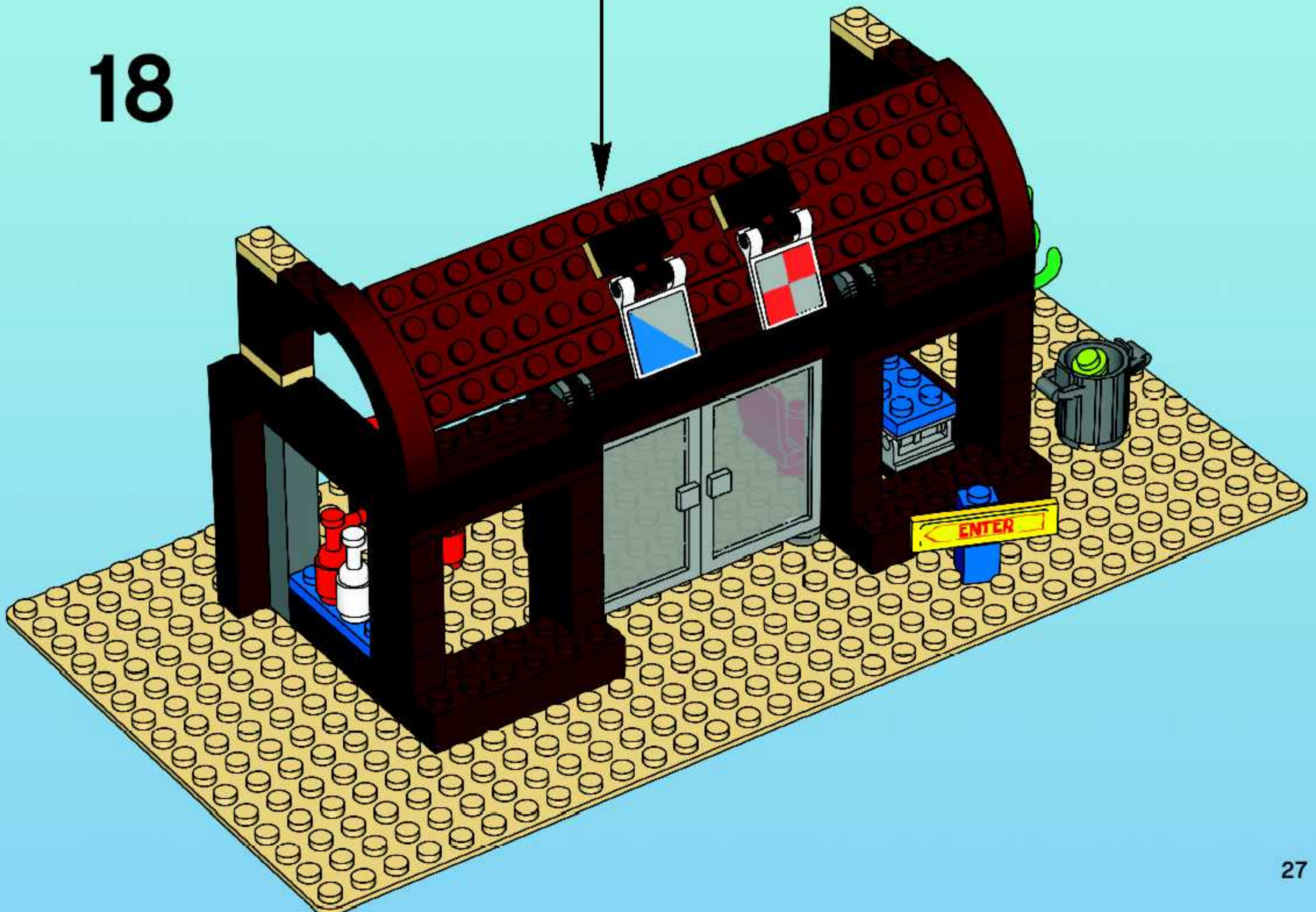

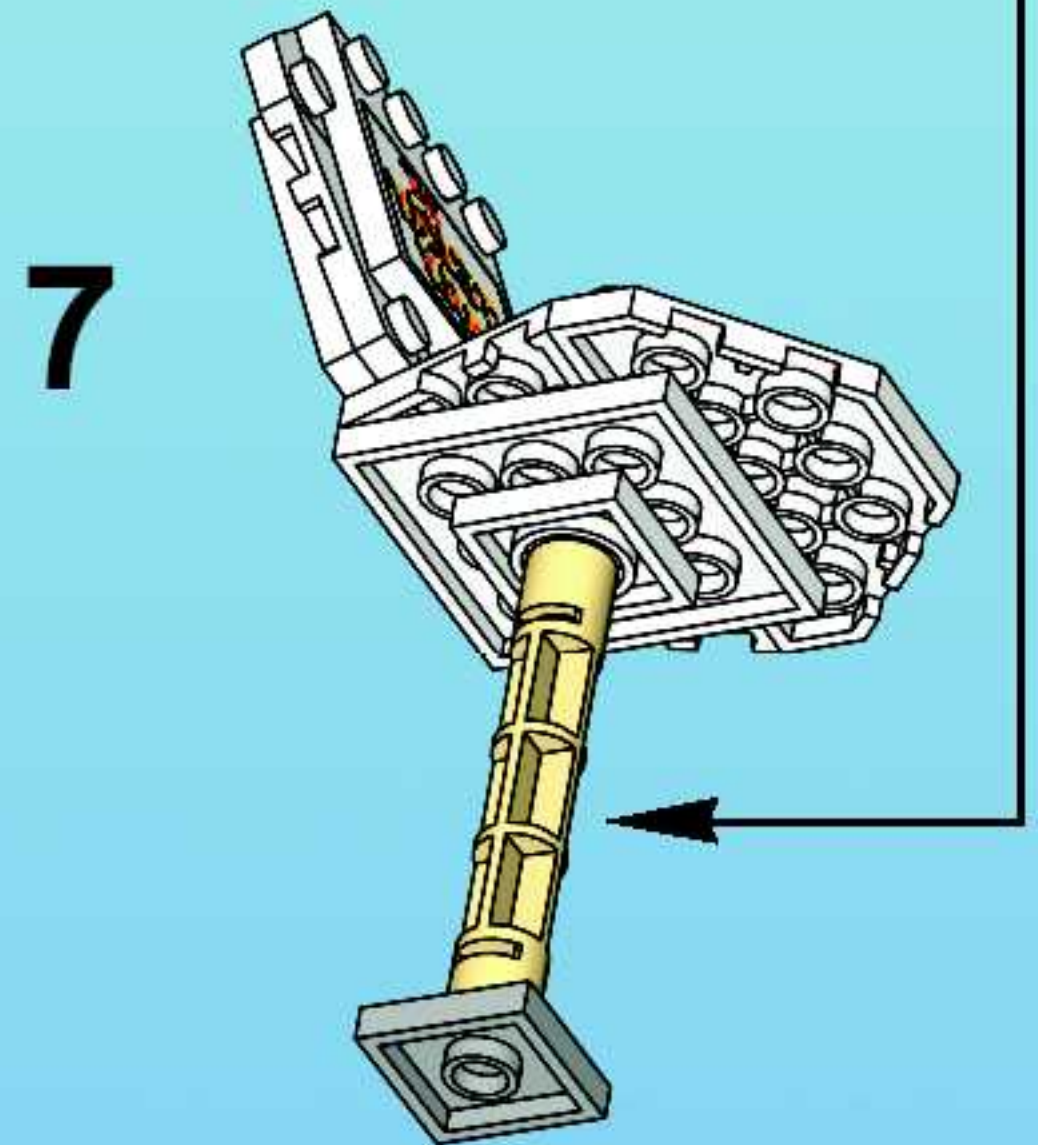
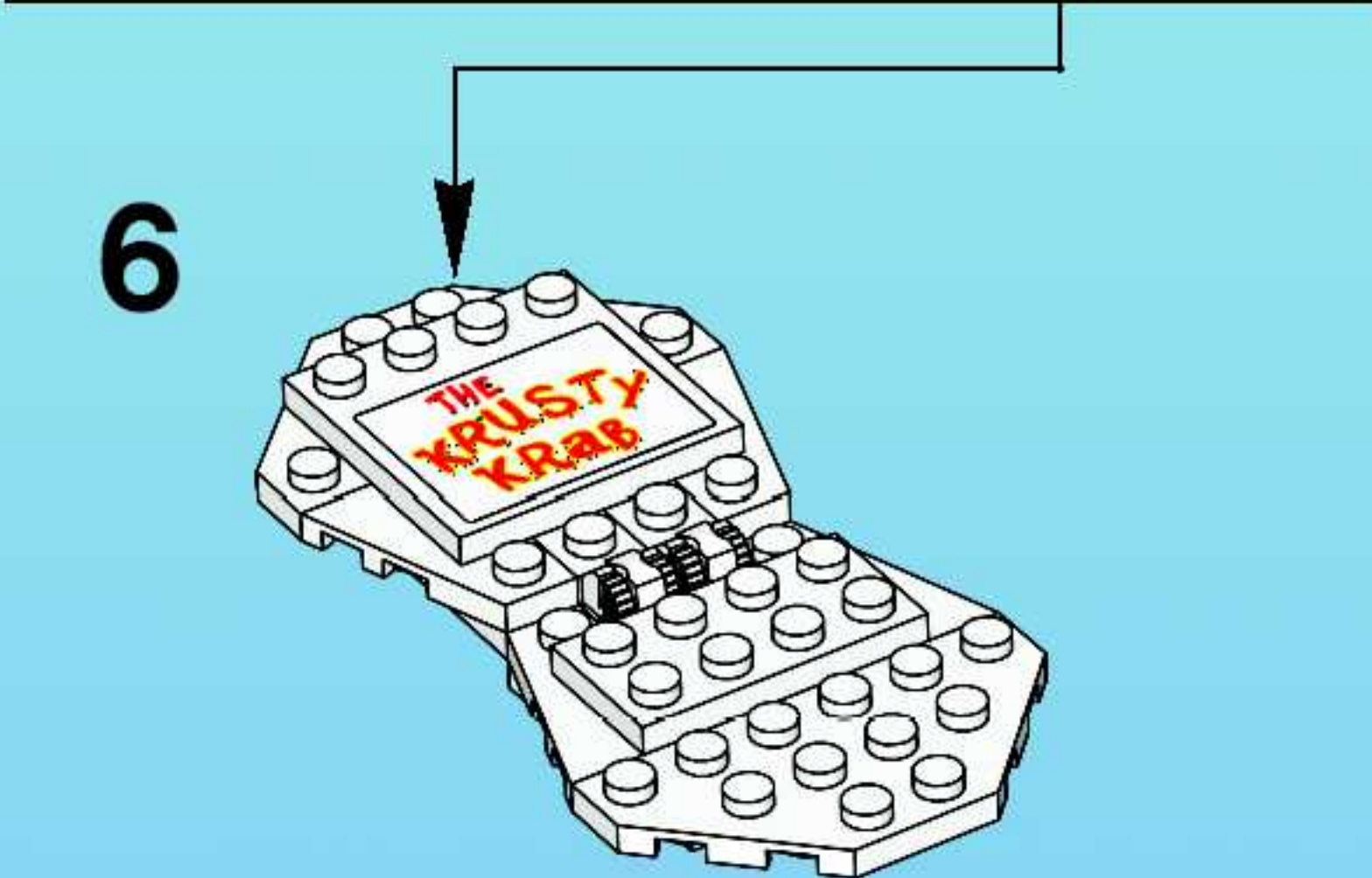
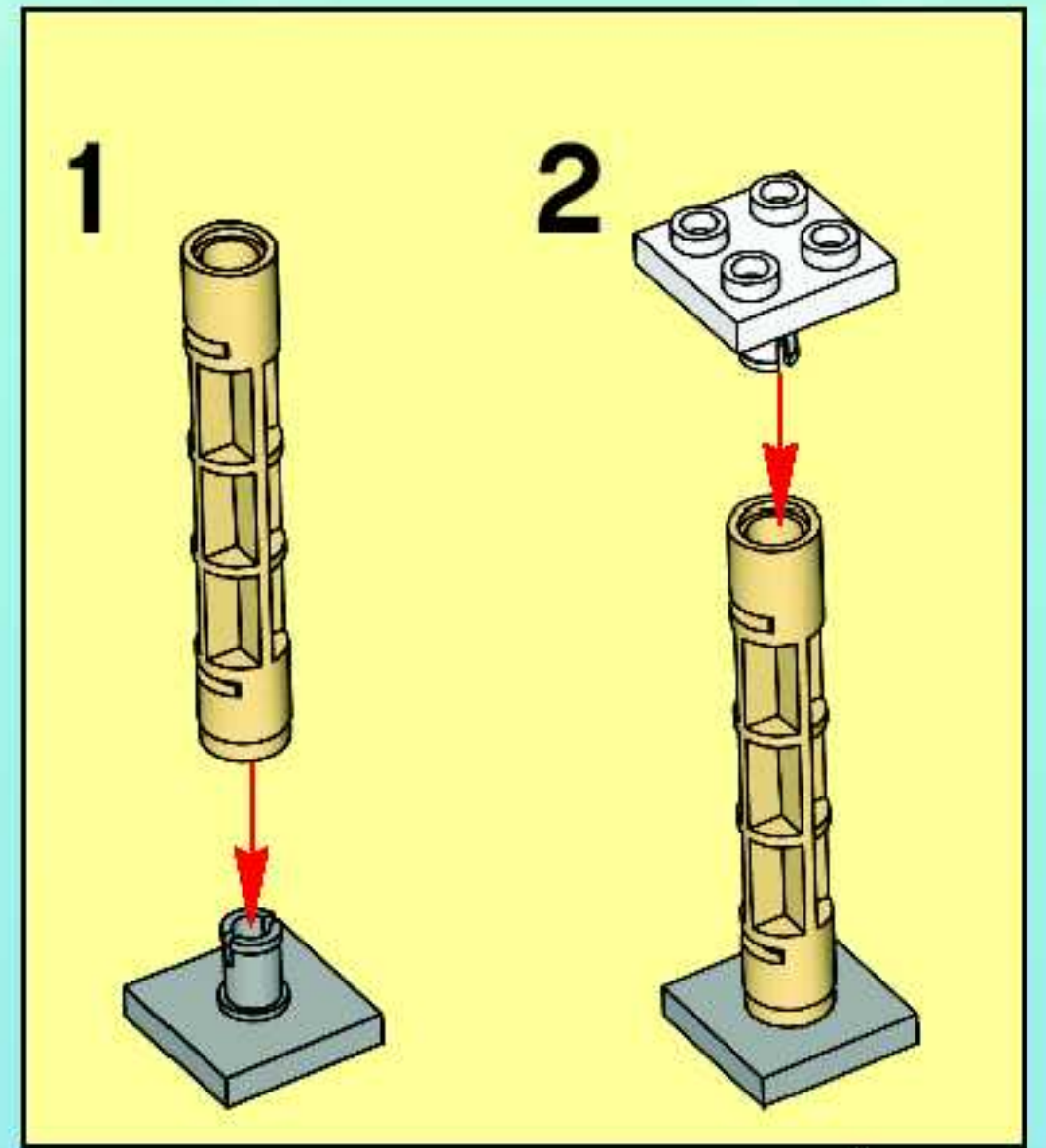
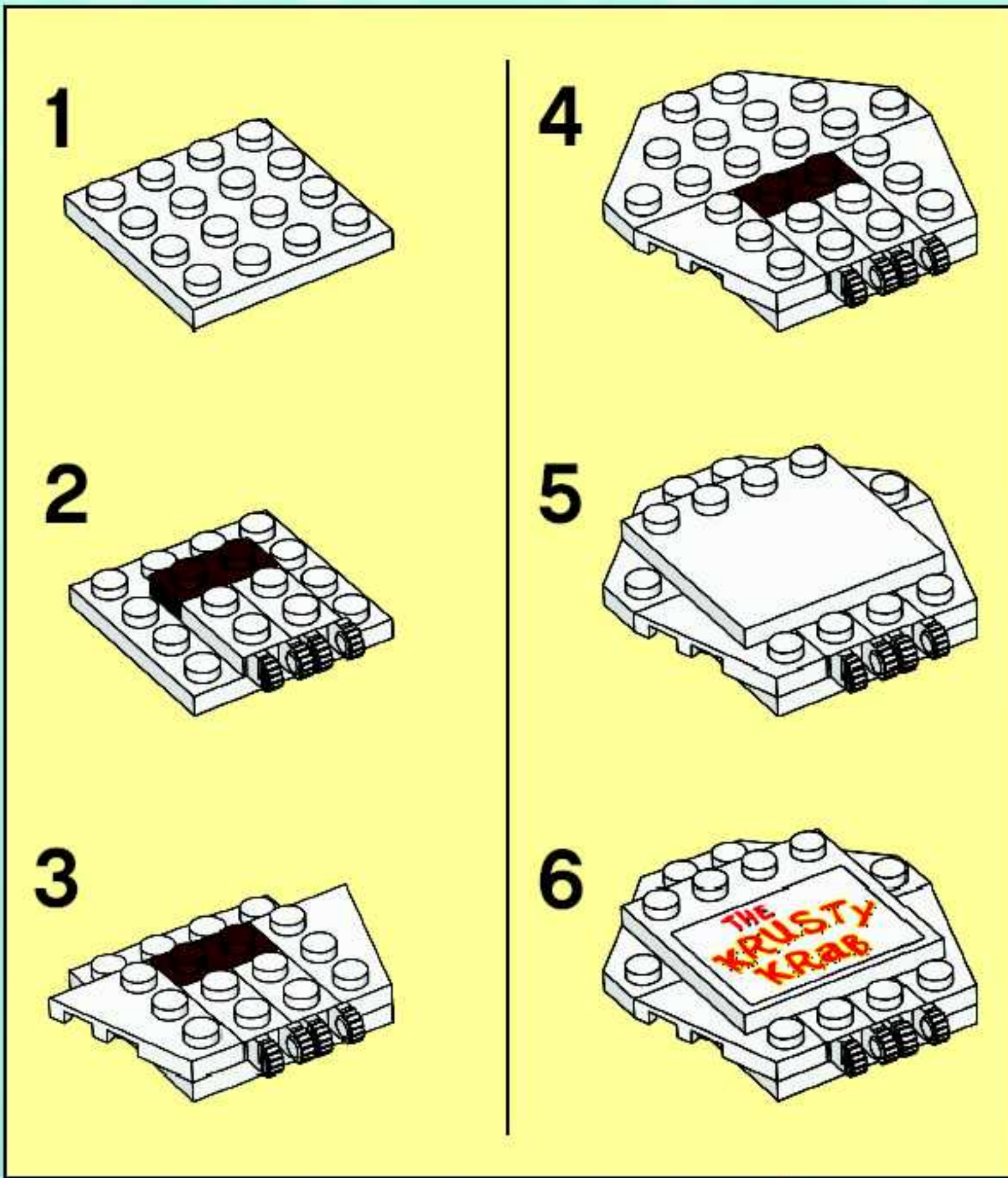

6

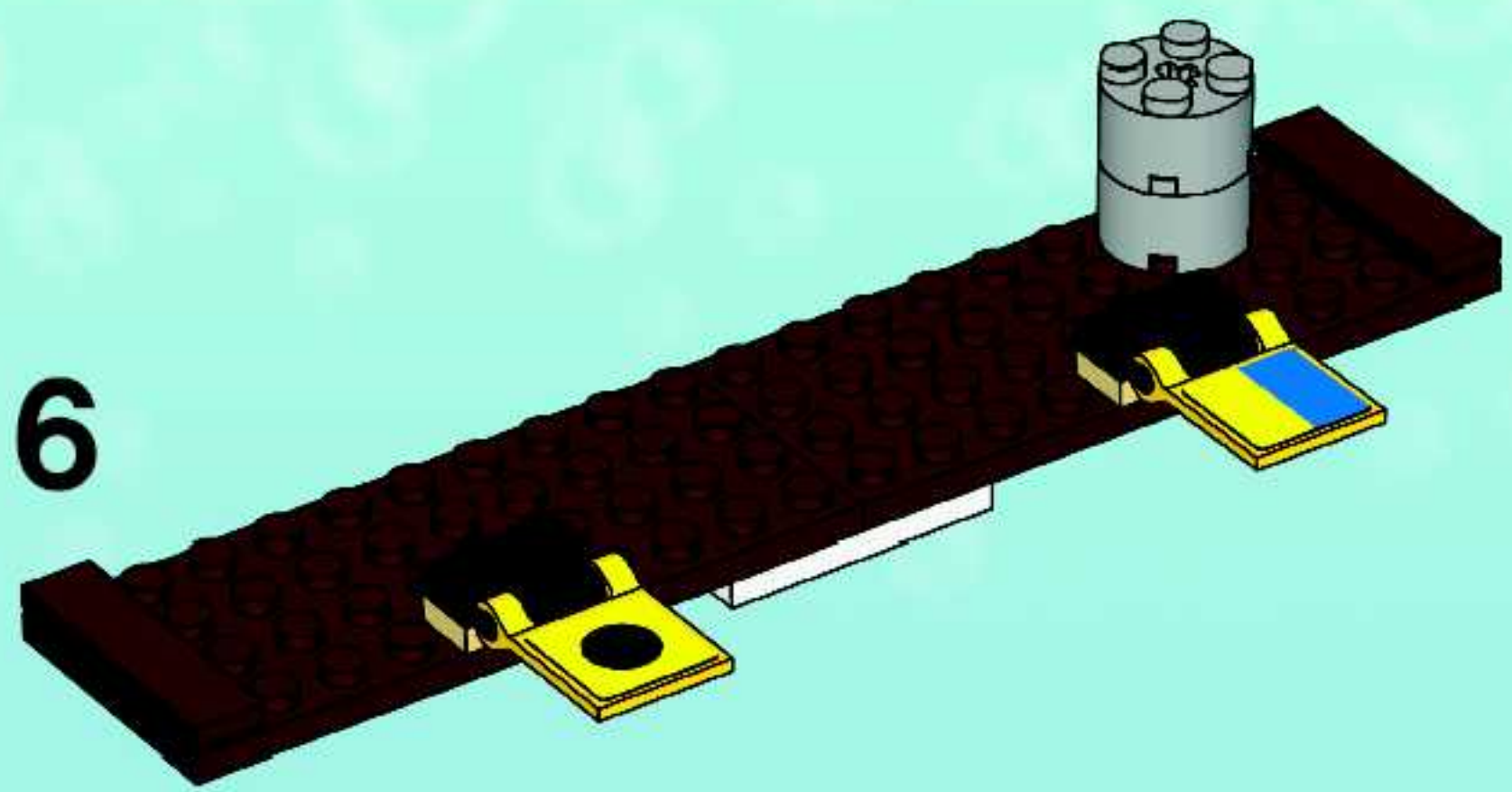

19

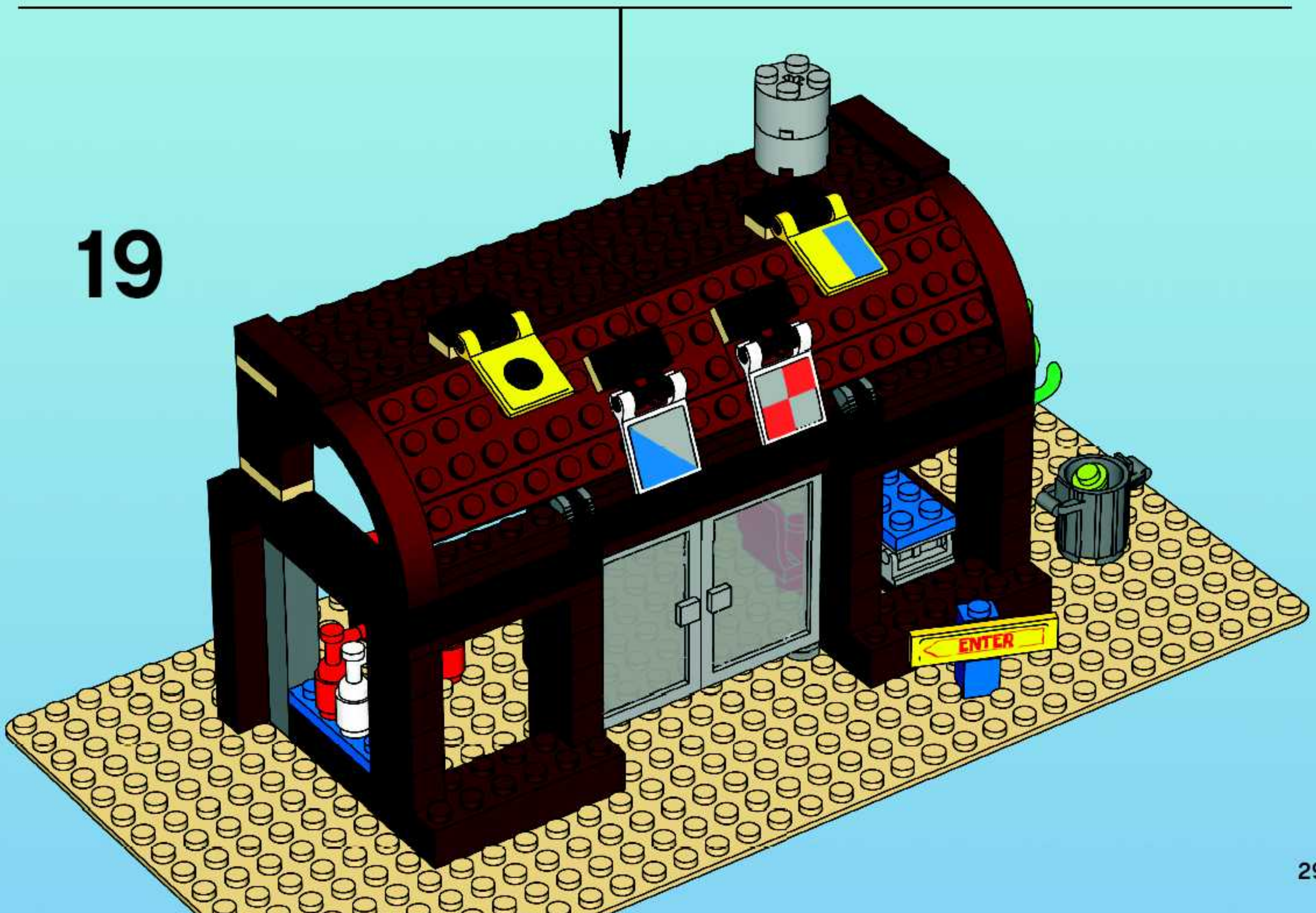

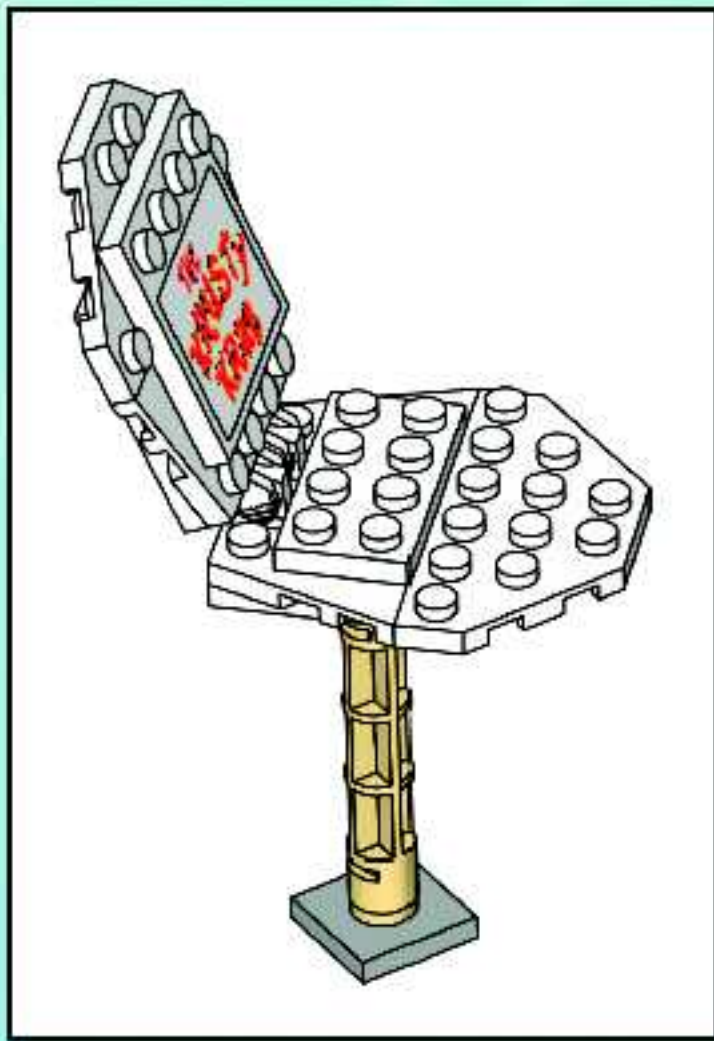

**1**

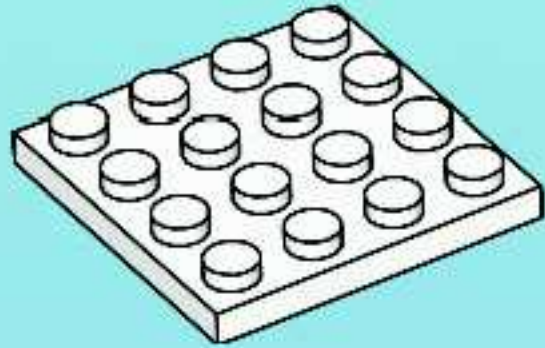

**2**

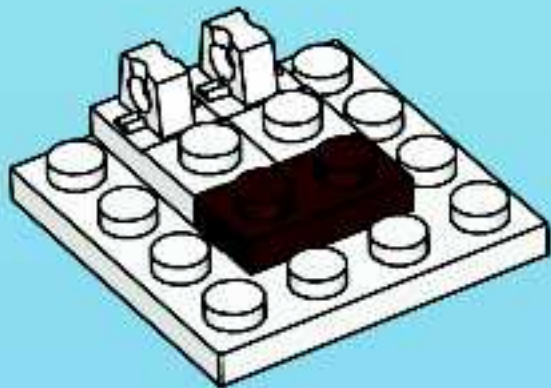

**3**

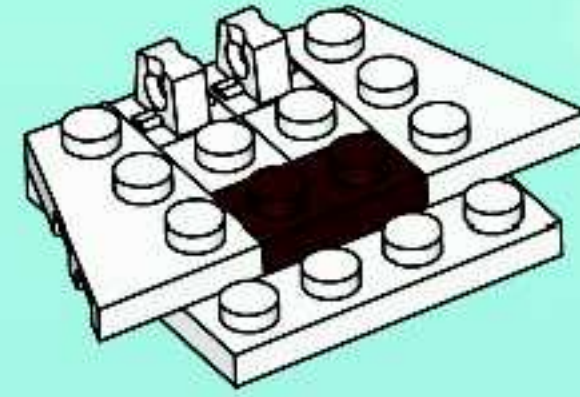

**4**

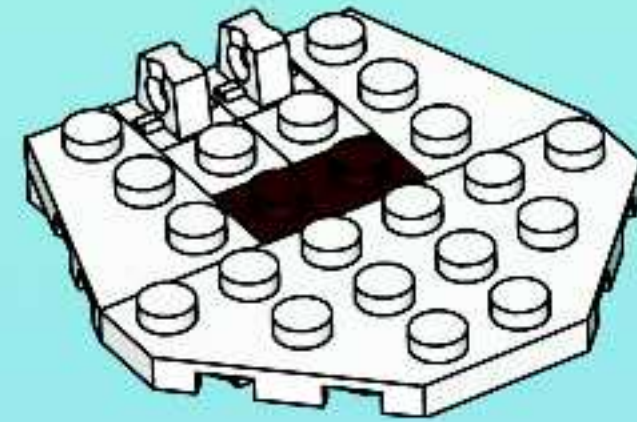

**5**

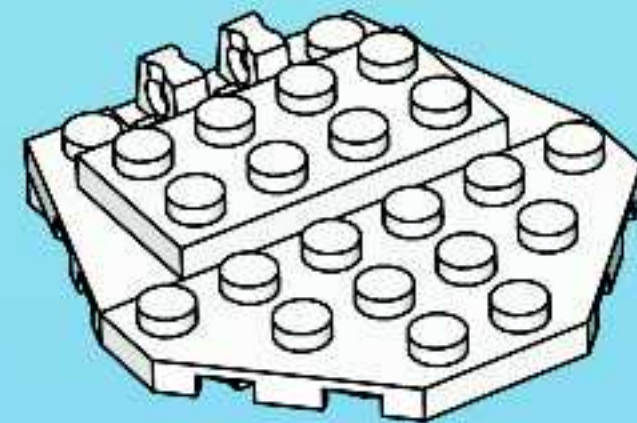

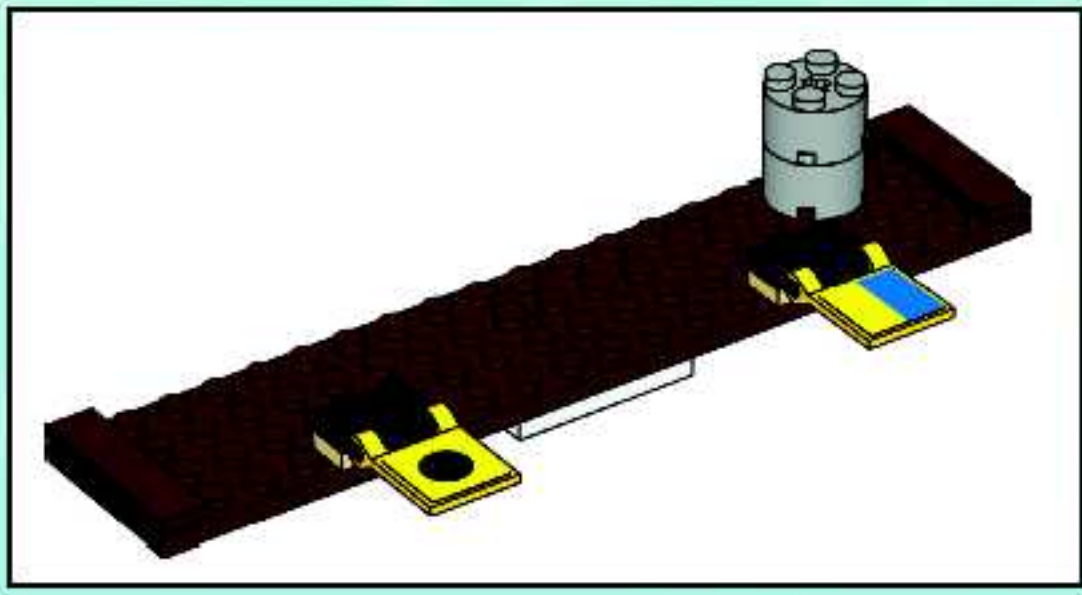

1

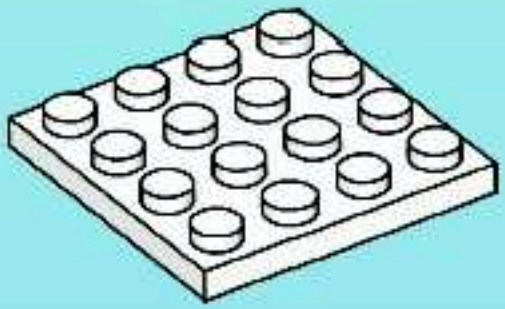

2

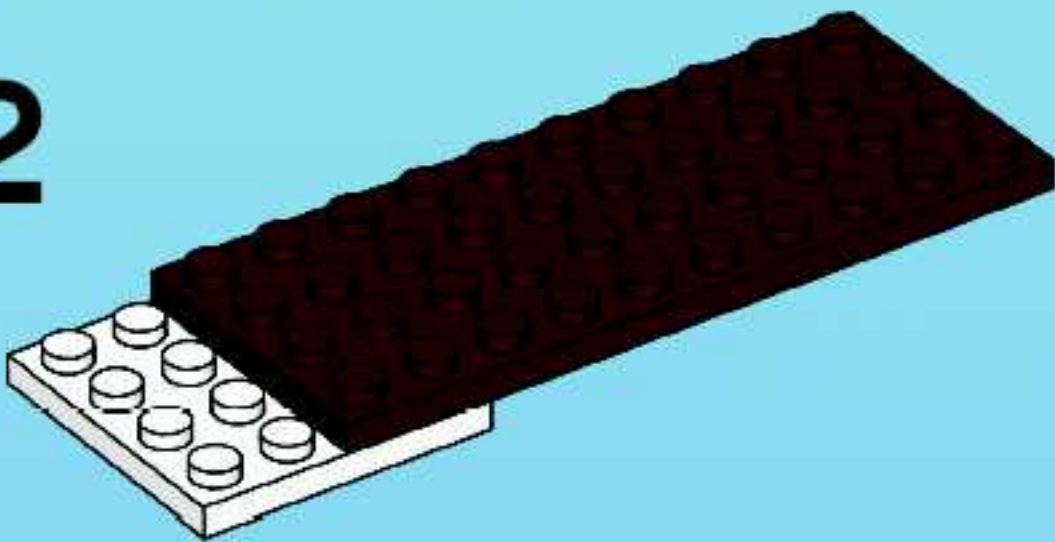

3

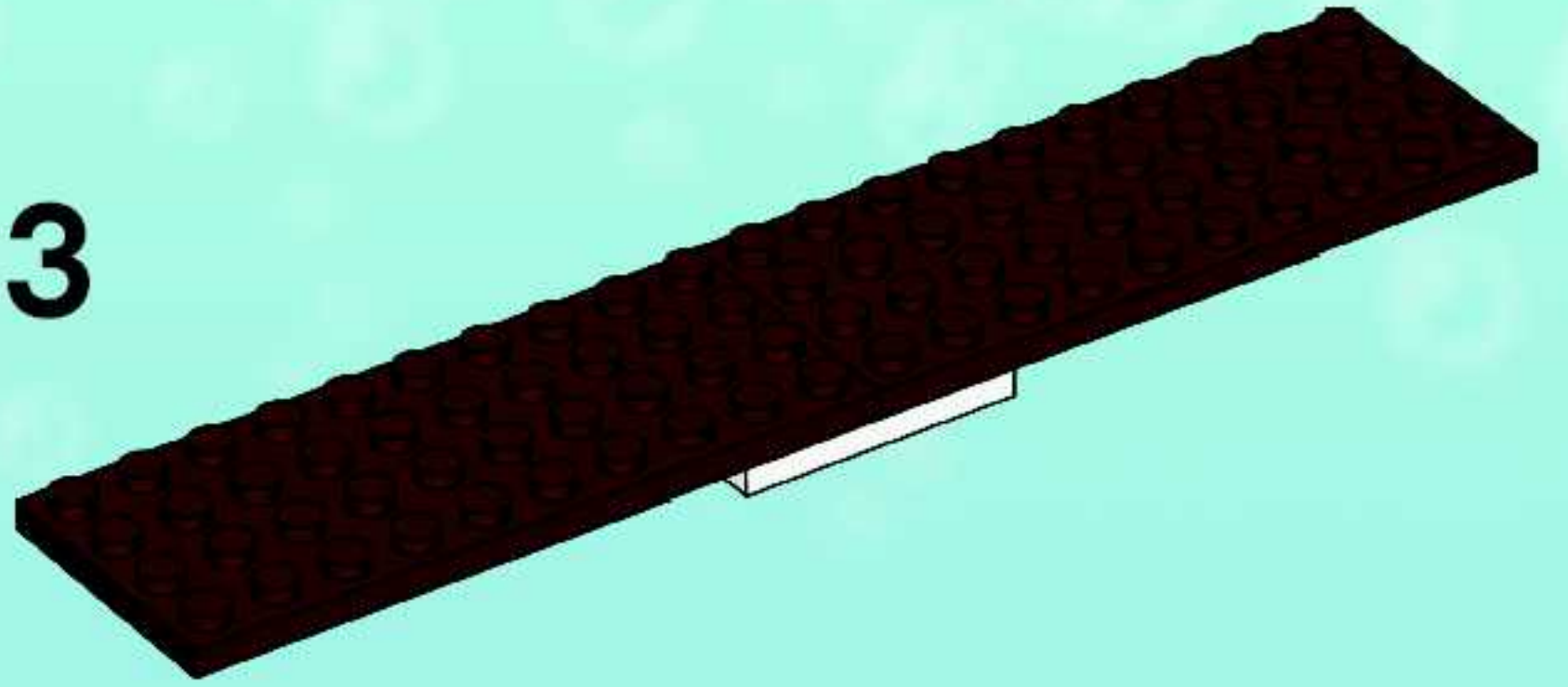

4

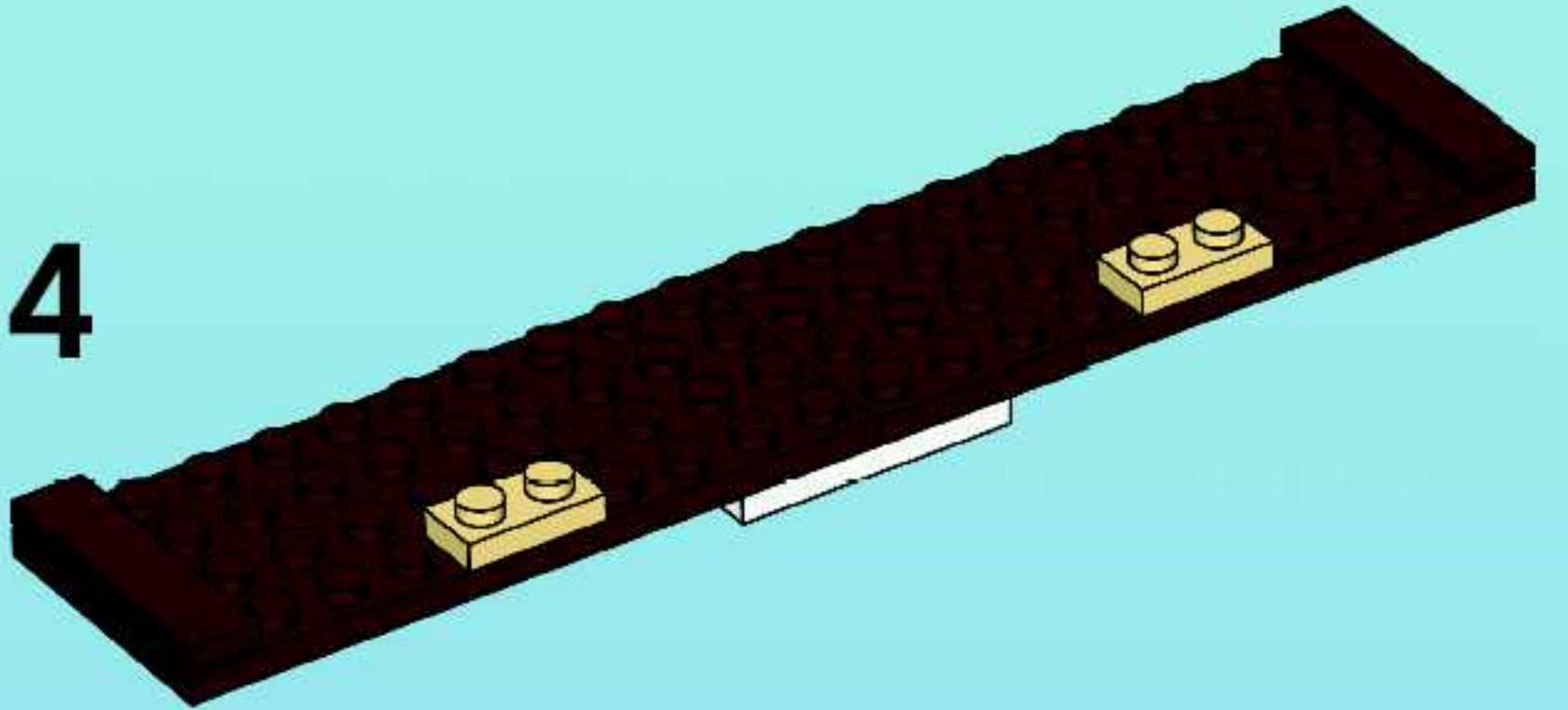

5

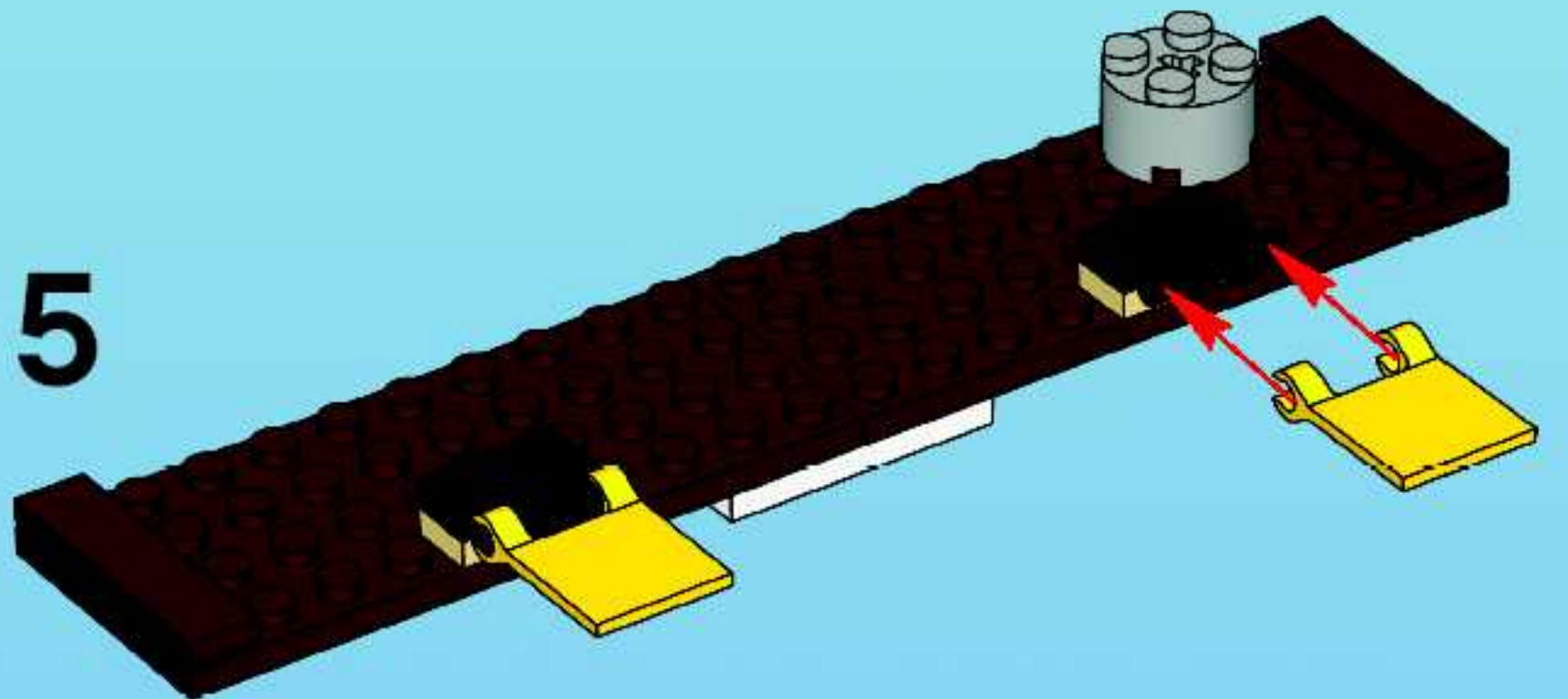

20





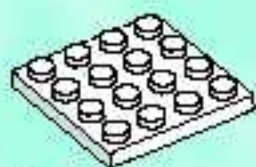

3x  
4243812

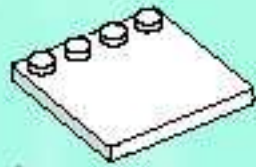

1x  
617901



2x  
4244370



2x  
366501



1x  
485501



1x  
306201



1x  
459901

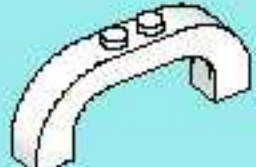

1x  
4250208

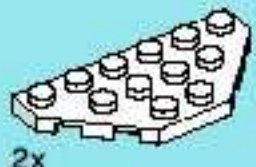

2x  
241901



2x  
233501



1x  
306901



2x  
4183048



2x  
4262011



1x  
4293876



2x  
4179875



2x  
4179874

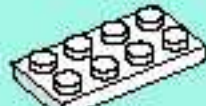

1x  
302001



1x  
4243920



1x  
4225469



2x  
4211147



14x  
4211242



3x  
4226966



12x  
4211149



4x  
4211220



1x  
4211225



4x  
4211193



2x  
4216615



2x  
4293100



1x  
4263459



2x  
4211194



1x  
4215449



1x  
4211157



1x  
4270443

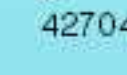

2x  
4223683



9x  
4211150



8x  
4211190



4x  
4221590



1x  
4211214



1x  
4211211



3x  
4225715



1x  
70501



1x  
4211207



2x  
4211222



3x  
4216581



2x  
242021



1x  
4293097



1x  
389921



3x  
403221



1x  
4238305



4x  
306221



4x  
614121









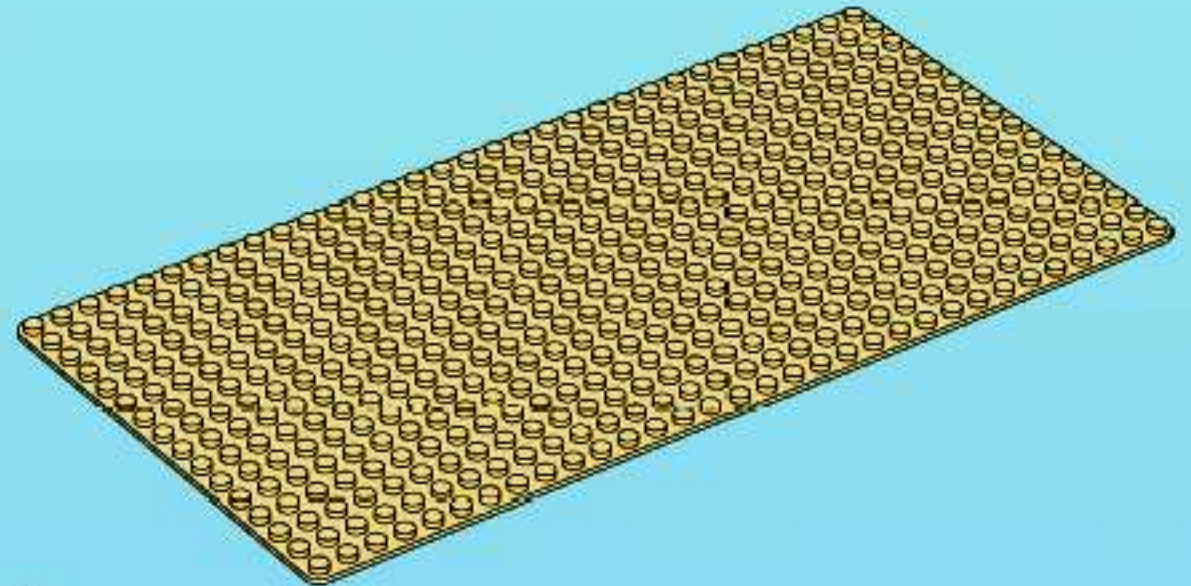















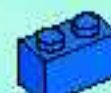

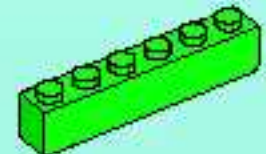

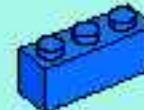

















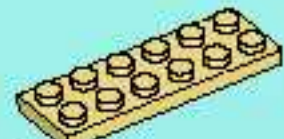

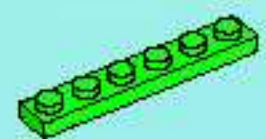
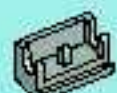

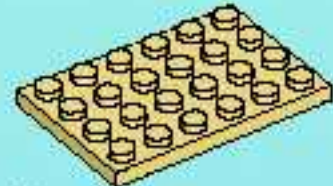

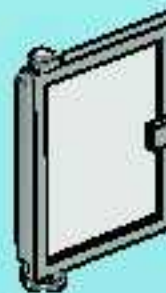



















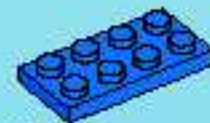



1x  
407921



1x  
459921



1x  
4295401

 2x 407023	 1x 4225289	 3x 300426	 1x 486526	 2x 4211526	 1x 4211086
 2x 300523	 1x 4288363	 2x 301026	 4x 4107736	 1x 4211539	 1x 4210978
 3x 300423	 1x 4114026	 1x 300826	 2x 4111844	 1x 4211483	 1x 4211075
 1x 362223	 1x 4293445	 5x 235726	 4x 4125281	 1x 4211628	 2x 4211104
 4x 4189123	 14x 4113917	 2x 233526	 2x 4295260	 1x 4211470	 1x 4210985
 1x 383023	 3x 4140562	 2x 654126	 1x 4188820	 1x 4211365	 7x 4210719
 1x 4293294	 1x 4113993	 1x 255526	 1x 366628	 1x 4211469	 2x 4216973
 3x 302423	 1x 4114001	 4x 4140588	 2x 4107637	 1x 4258478	 2x 4210884
 1x 379423	 3x 4278422	 2x 4144575	 1x 4256382	 1x 4258477	 3x 4211133
 3x 362323	 2x 233524	 2x 4107761	 4x 4183133	 1x 4211651	 2x 4211001
 3x 302123	 1x 243124	 2x 371026	 1x 4293288	 1x 4211440	 1x 4211115
 2x 302023	 1x 4293098	 1x 370926	 1x 4206504	 2x 4210639	 4x 4210633
 3x 4168345	 1x 4293300	 1x 303926	 1x 4293287		
 1x 4293444	 4x 614124	 1x 384926	 1x 4211709		

# Win! Gagne! 当たります Gewinne!

## Win LEGO products

We would like to know what you think about your new LEGO product. Log on to the web address below for further instructions.

## Gagne des produits LEGO

Nous aimerions savoir ce que tu penses de ton nouveau produit LEGO. Tu obtiendras davantage d'informations en visitant le site Internet indique ci-dessous.

## Gewinne LEGO produkte

Wir sind sehr an deiner Meinung über dein neues LEGO Produkt interessiert. Gehe einfach zu der unten angegebenen Webadresse – dort findest du weitere Informationen.

## Estimado usuario LEGO

Al contestar algunas preguntas en inglés, francés, alemán o japonés, en el sitio [www.acnielsen.aim.dk/lego](http://www.acnielsen.aim.dk/lego), podrás participar en el sorteo de algunos valiosos premios LEGO.

## Caro Consumidor da LEGO

Ao responder a algumas perguntas em Inglês, Francês, Alemão ou Japonês no endereço [www.acnielsen.aim.dk/lego](http://www.acnielsen.aim.dk/lego) irá participar num concurso para ganhar valiosos prémios da LEGO.

## Kedves ifjú LEGO Vásárló

Ha ellátogatsz a [www.acnielsen.aim.dk/lego](http://www.acnielsen.aim.dk/lego) honlapra és ott angol, francia, német vagy japán nyelven megválaszolsz néhány kérdést, akkor részt veszel egy versenyben, amelyben értékes LEGO díjakat nyerhetsz.

## 抽選でレゴ製品が当たります

私たちは、皆さんがお買い求めのレゴ製品についてどんな感想をお持ちか、知りたいと思っています。質問に答えて、楽しいレゴ製品の抽選に応募しませんか。アンケートの回答には、ほんの3分ほどしかかかりません！詳しくは、以下のウェブアドレスまでアクセスしてください。

[www.acnielsen.aim.dk/LEGO](http://www.acnielsen.aim.dk/LEGO)



Any questions regarding your new LEGO product, please contact:

**Customer Service | Kundenservice**

**Service Consommateurs | Servicio Al Consumidor**

**at [www.lego.com/service](http://www.lego.com/service) or dial**

 : 00800 5346 5555

 : 1-800-422-5346

Discover the **LEGO® UNIVERSE!**  
 Entdecke das **LEGO® UNIVERSUM!**  
 Ontdek het **LEGO® UNIVERSUM!**  
 Découvre **L'UNIVERS LEGO®!**



FREE LEGO Magazines  
 Des Magazines LEGO GRATUITS !  
 KOSTENLOSE LEGO Magazine  
 GRATIS LEGO Magazine



BIC26 BIC26 BI06U BI06U BI06F BI06C BI06C BI06C BI06N

Sign up now! Jetzt anmelden!

Abonne-toi maintenant ! Meld je nu aan!

<http://club.LEGO.com/signup>



**SHOP at HOME**



[www.LEGOshop.com/catalog](http://www.LEGOshop.com/catalog)