

ZNAZ™

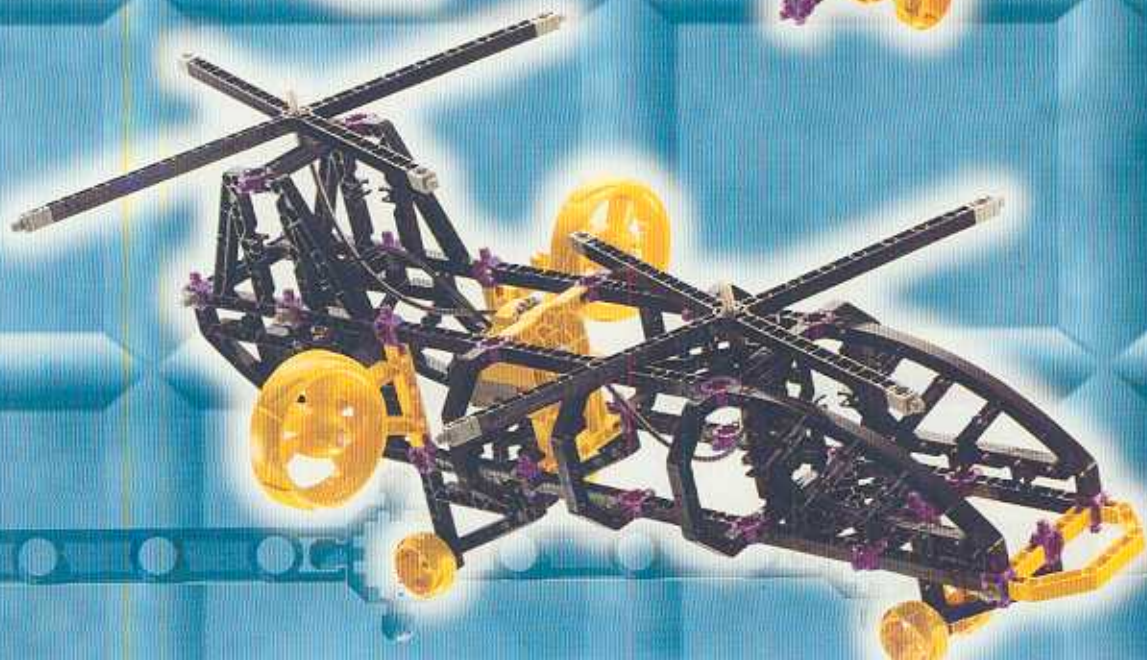

The LEGO logo, consisting of the word "LEGO" in white, bold, sans-serif capital letters with a yellow outline, set against a red background.

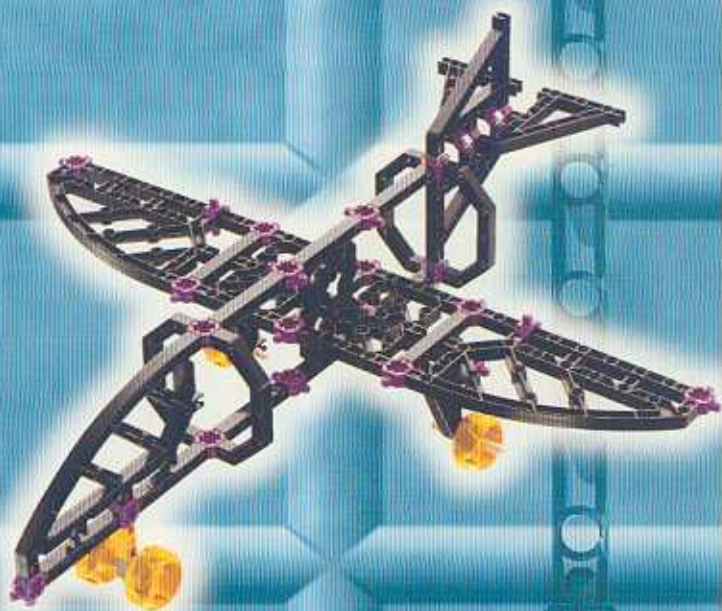
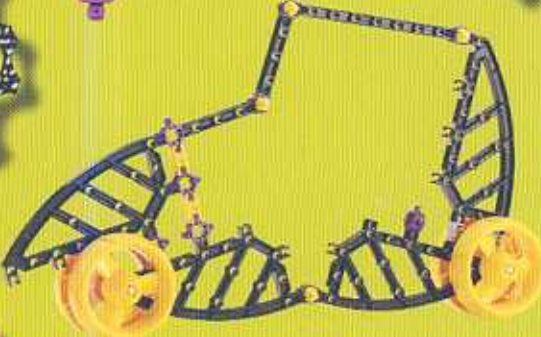

26

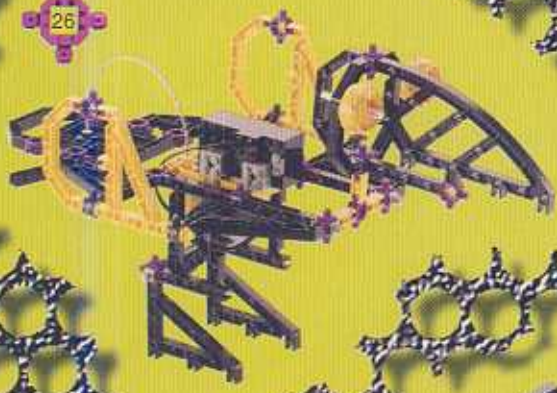

52



38



66

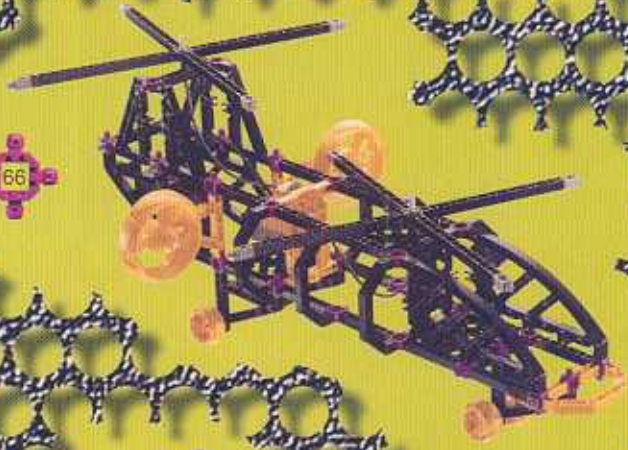

42



78

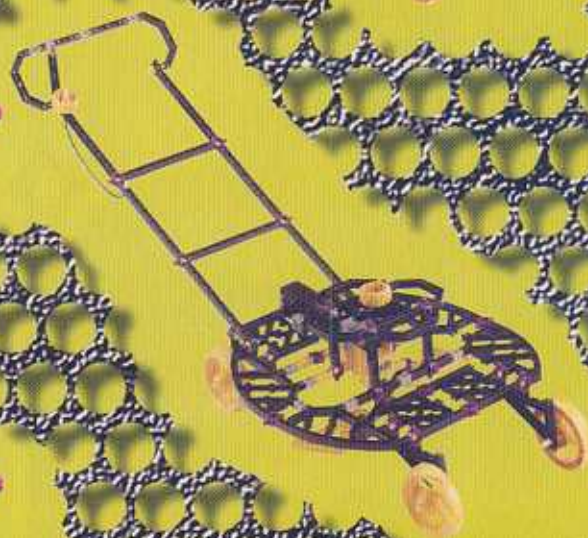

44



80



3

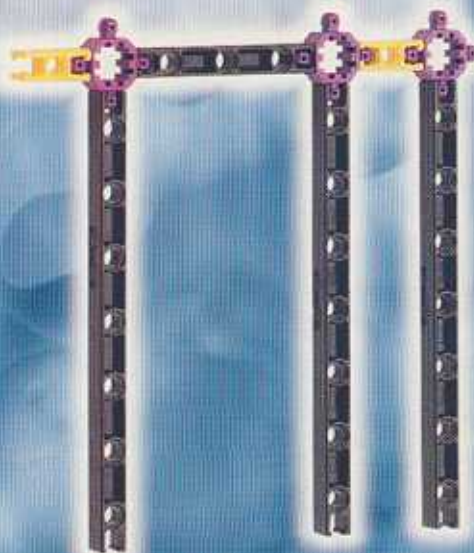

2

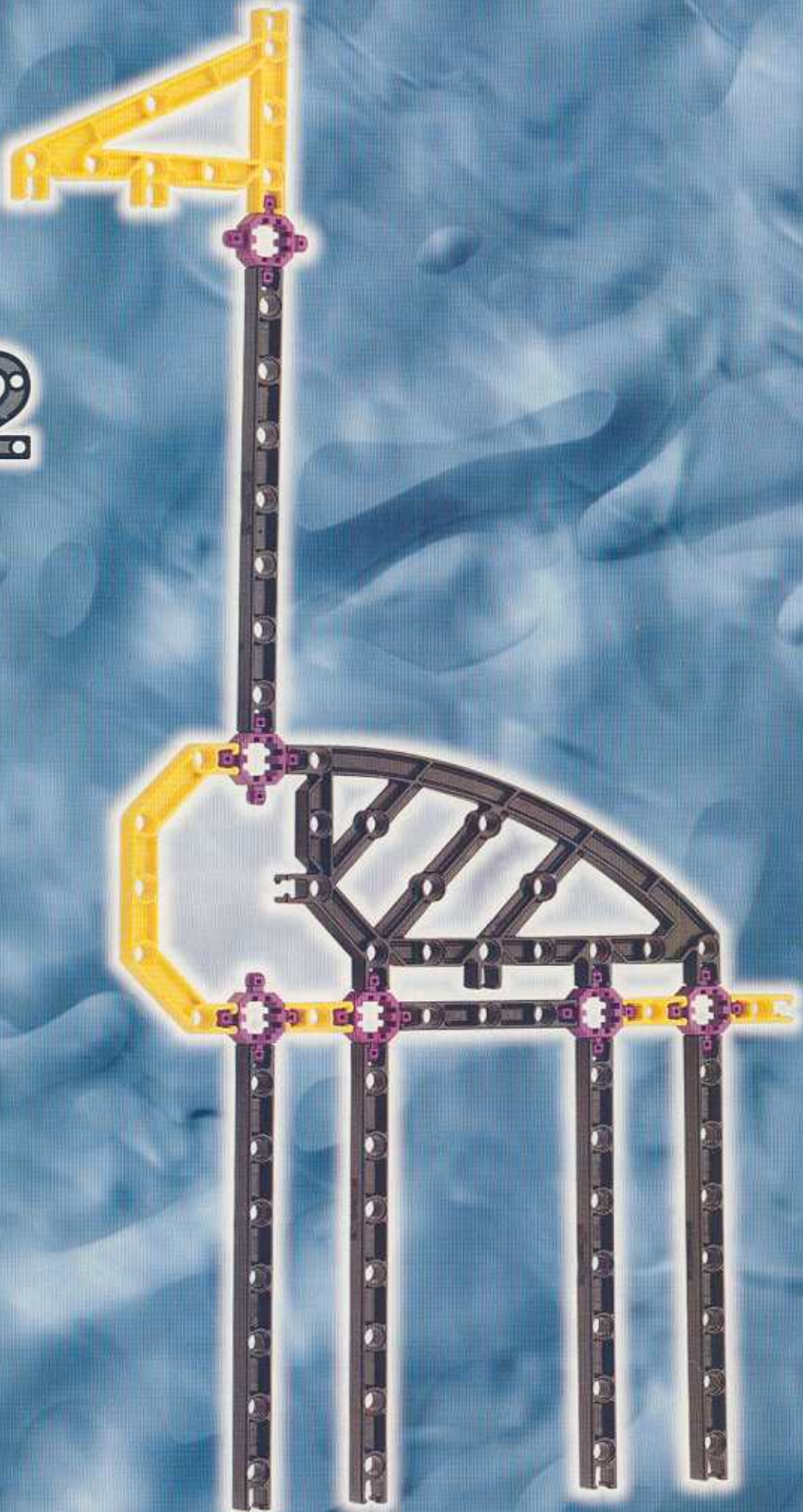

1

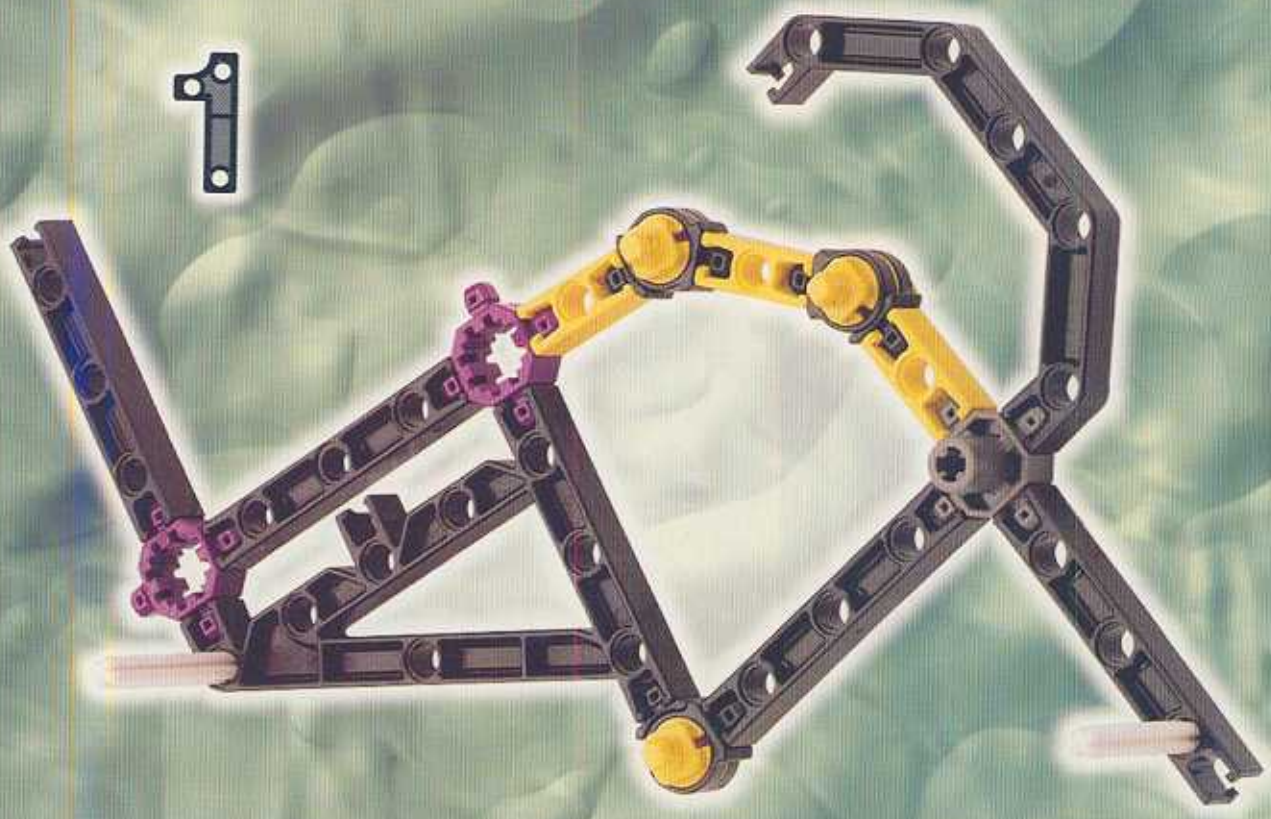

2



1

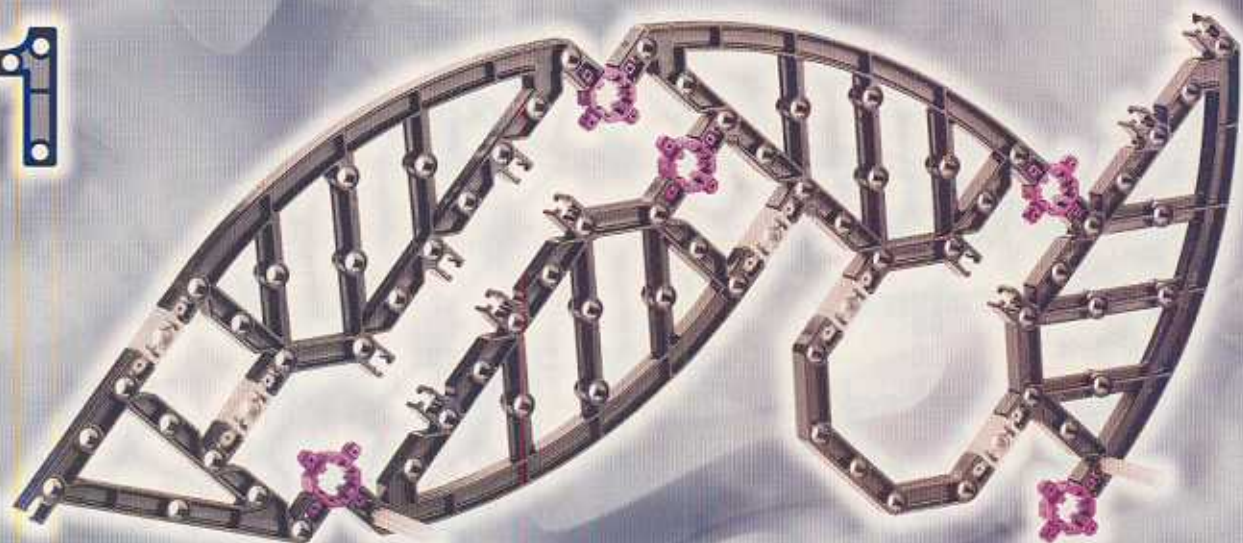

2

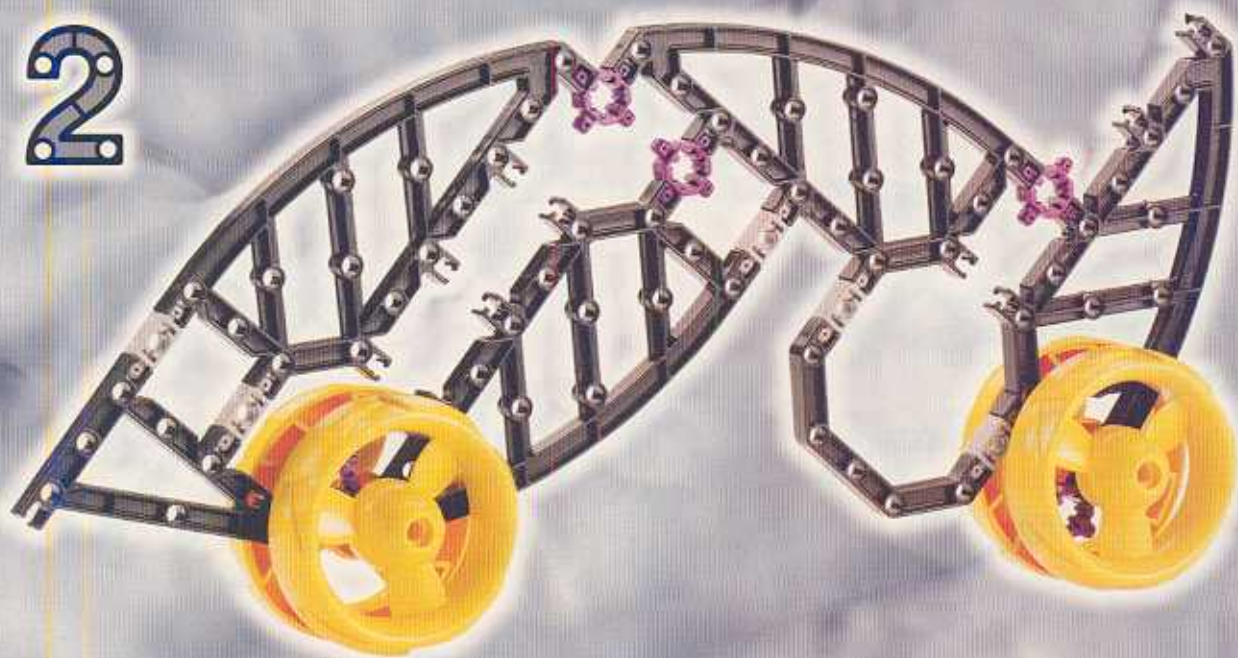

1

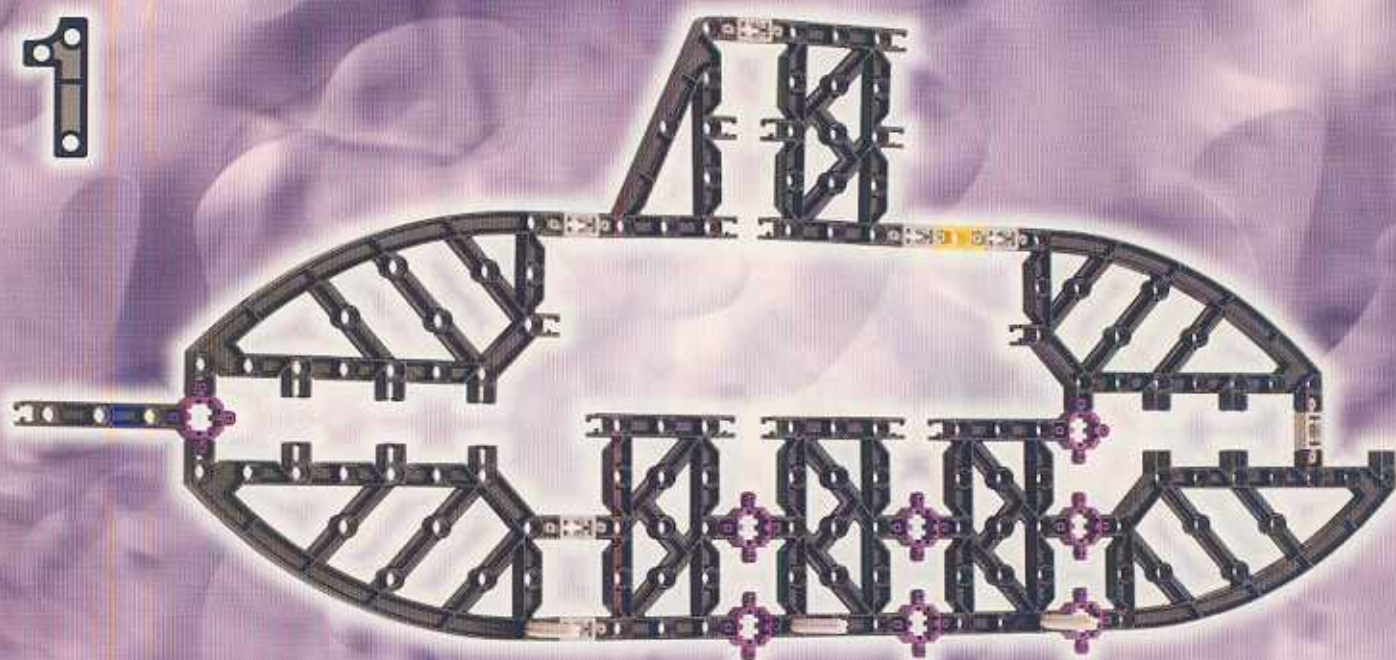

2

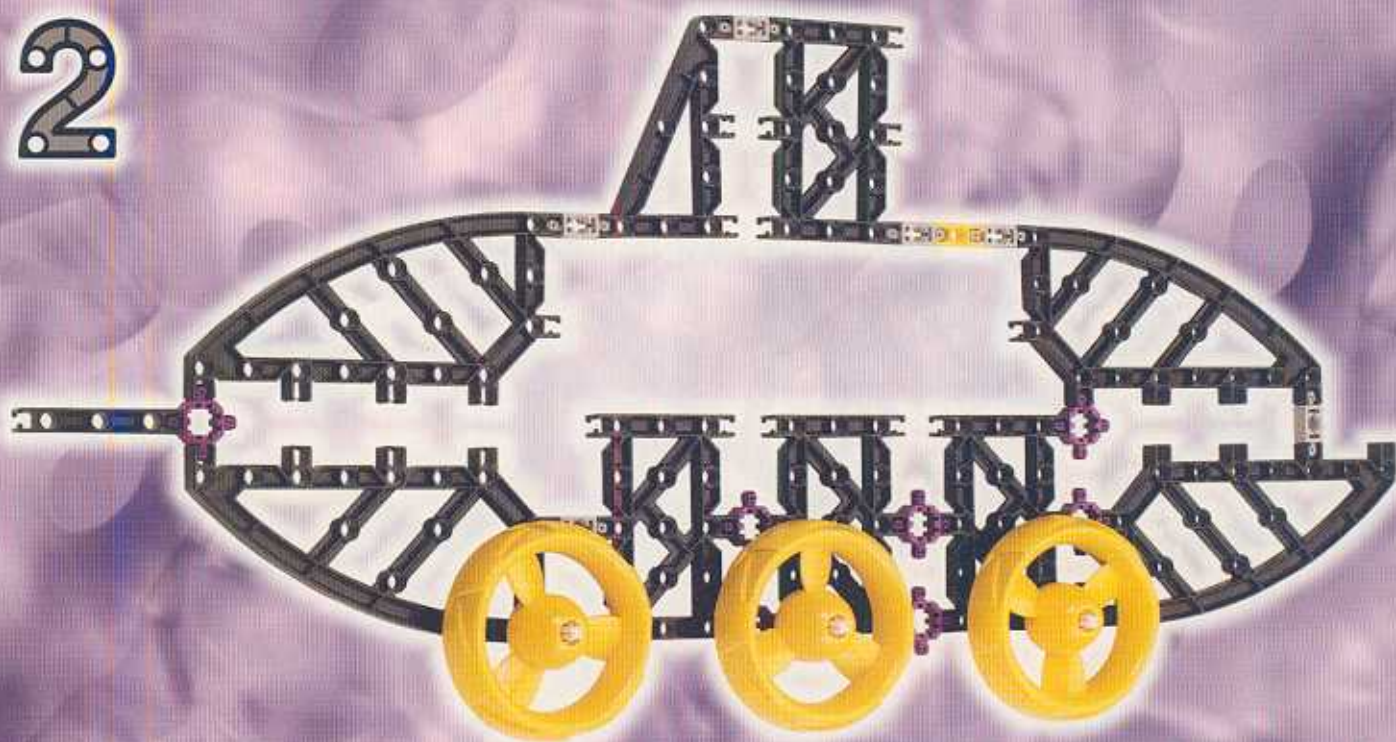

1

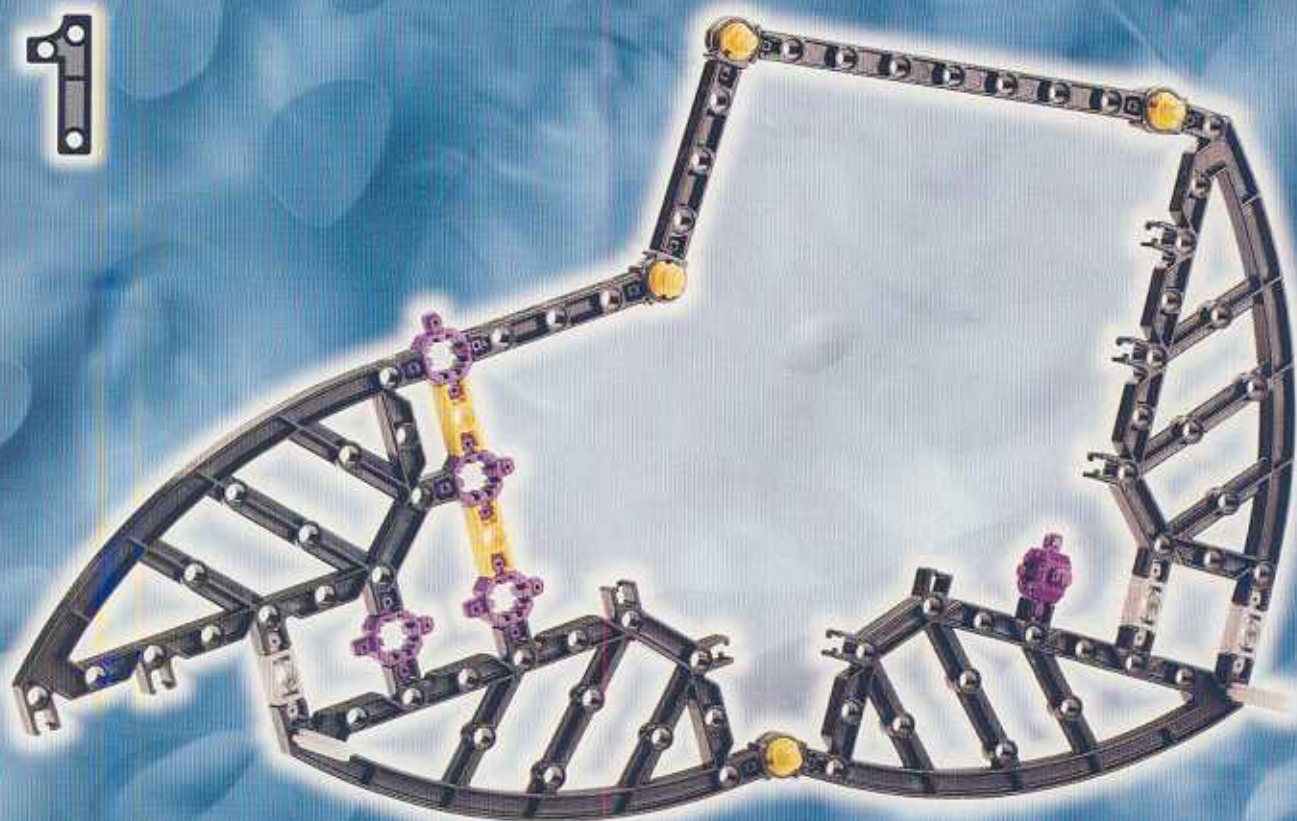

2





1



2

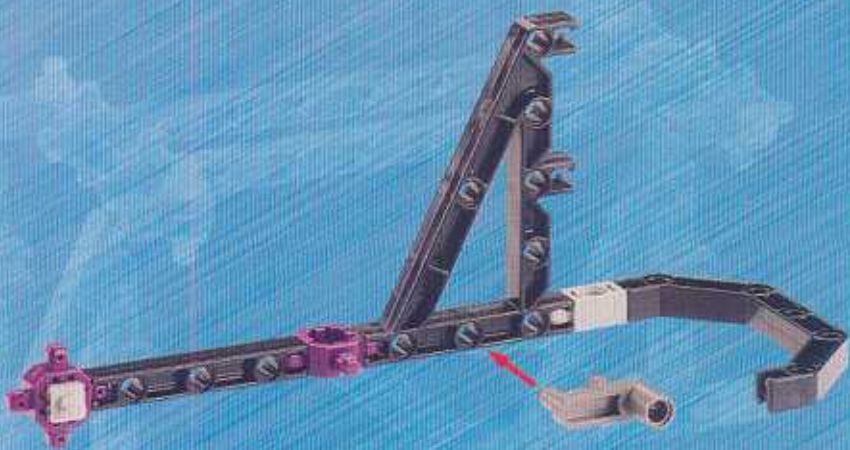

3



4



5



6



7



8



9



10

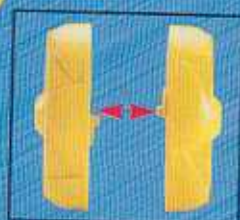

11



12



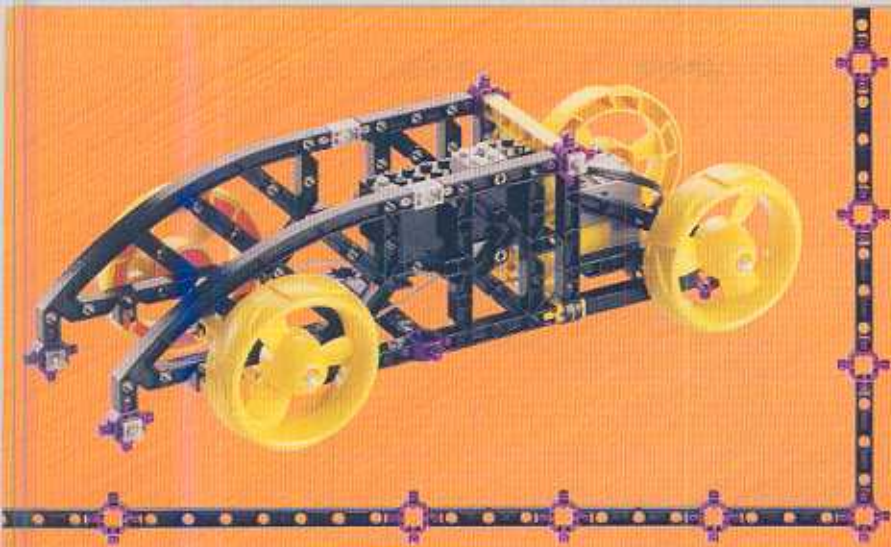

1

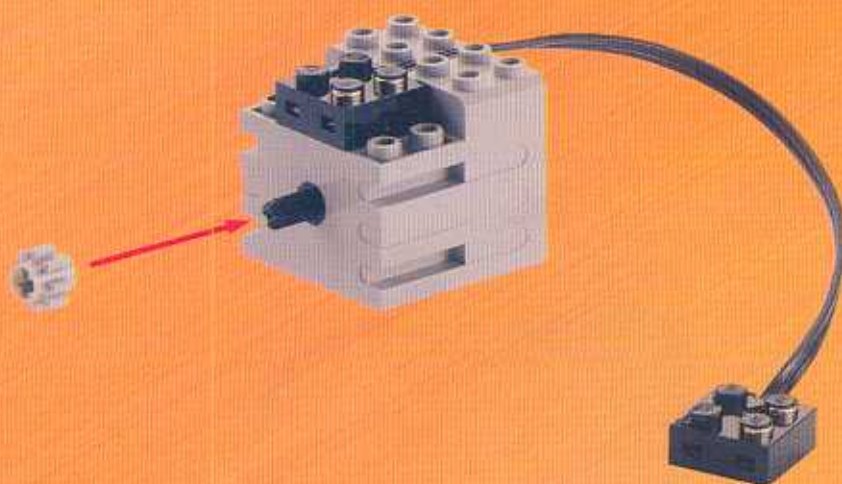

2

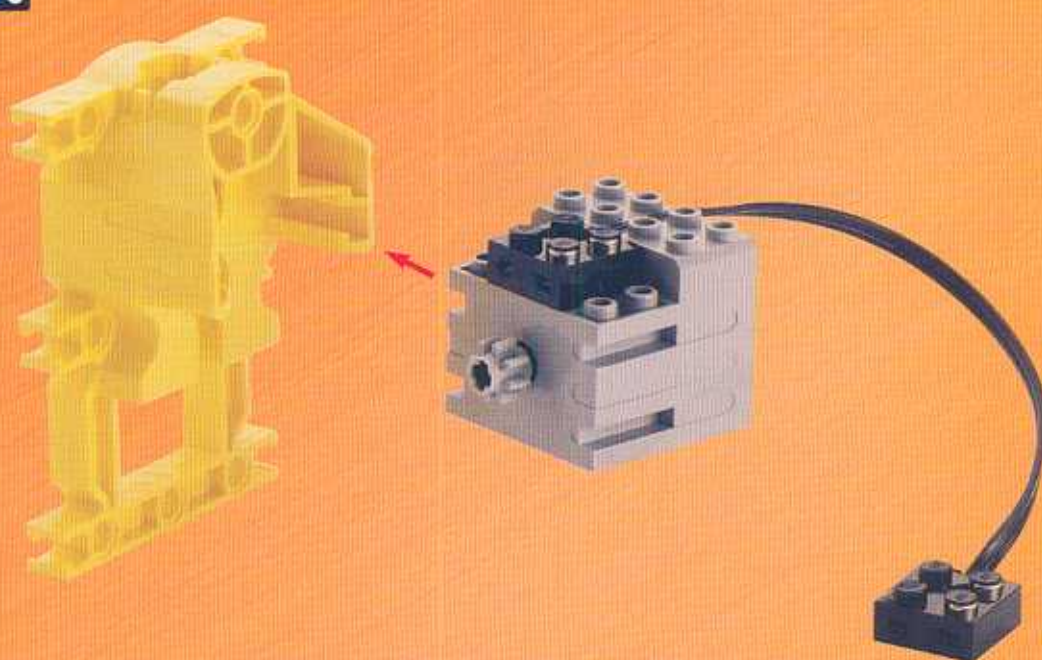

3

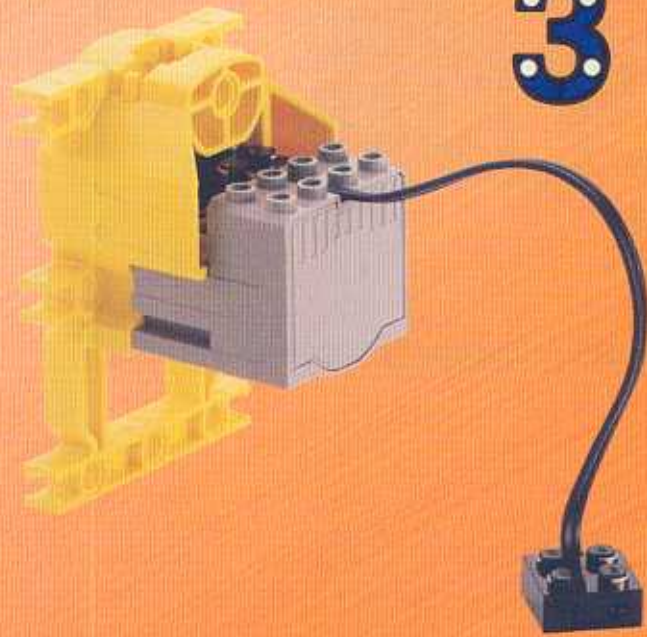

4

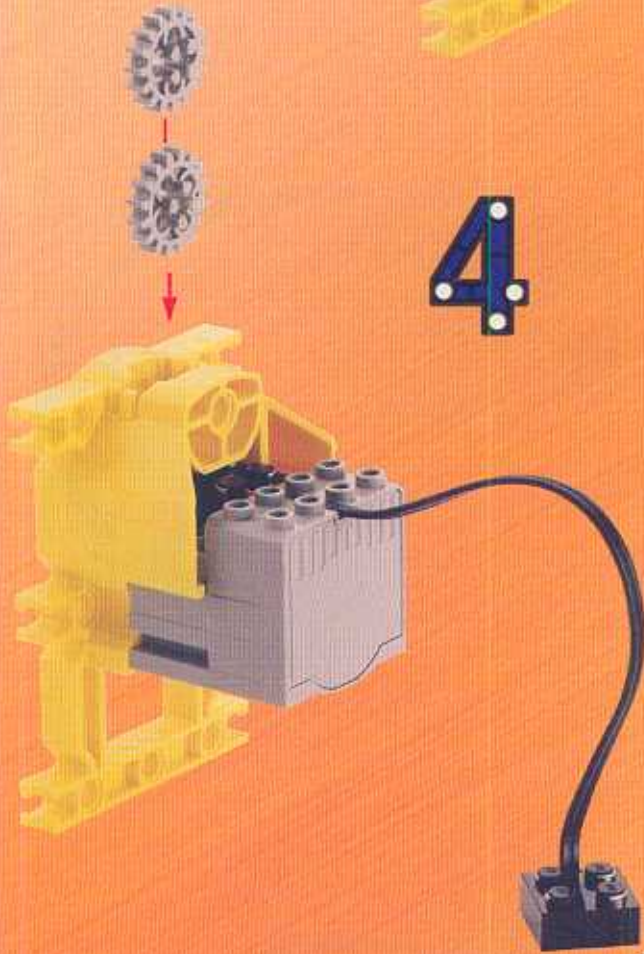

5

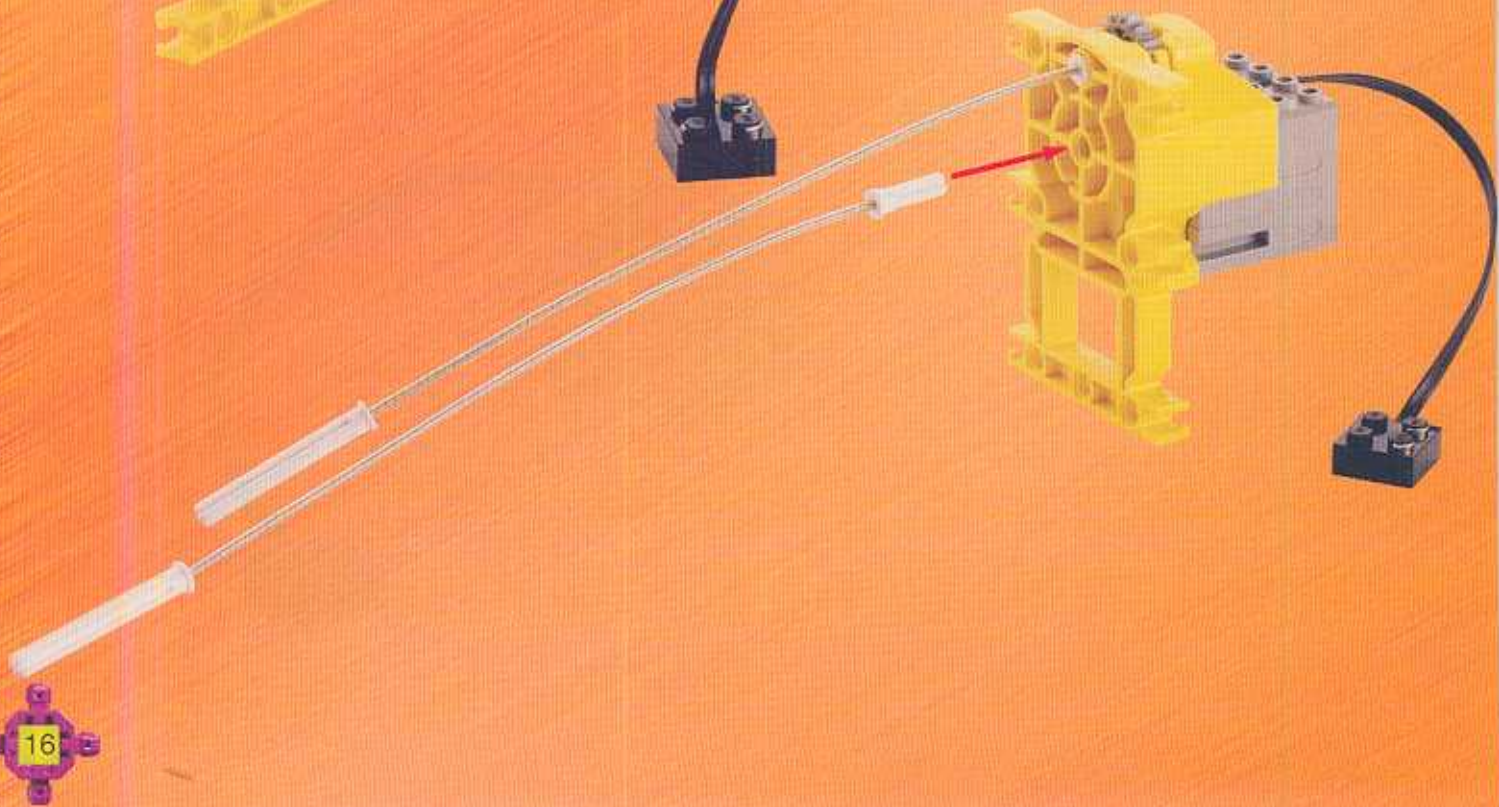

1



2



3

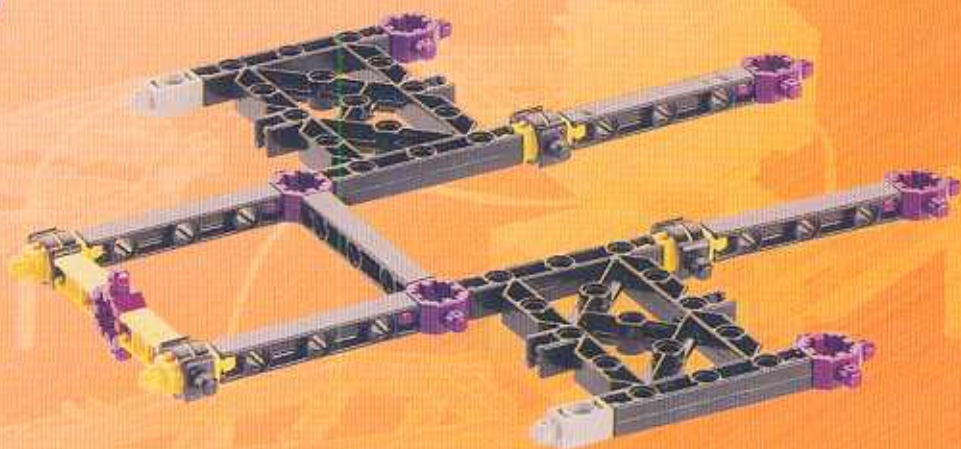

4

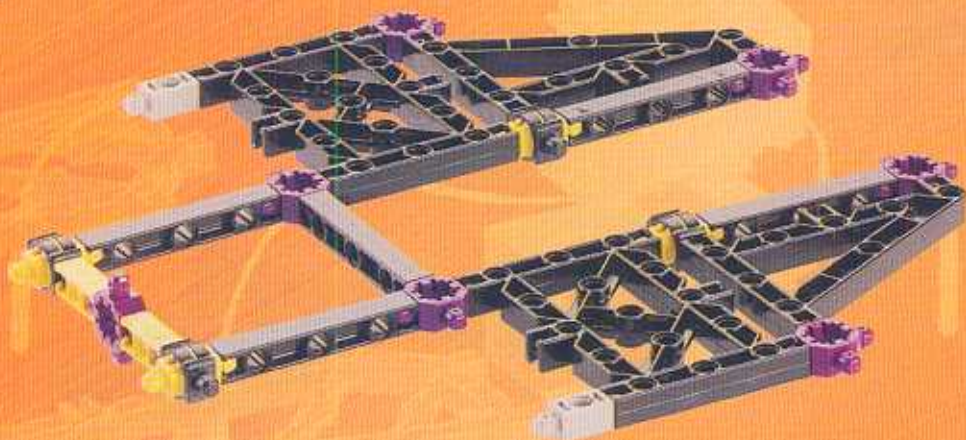

5



6

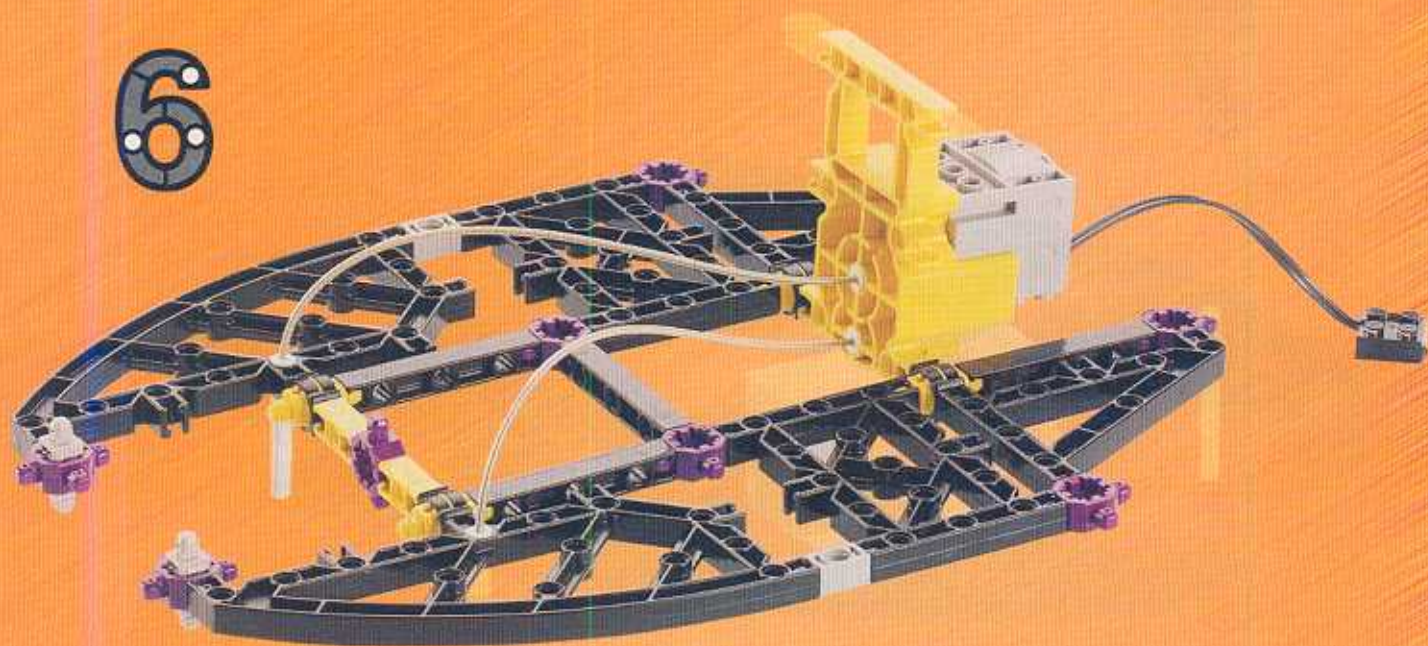

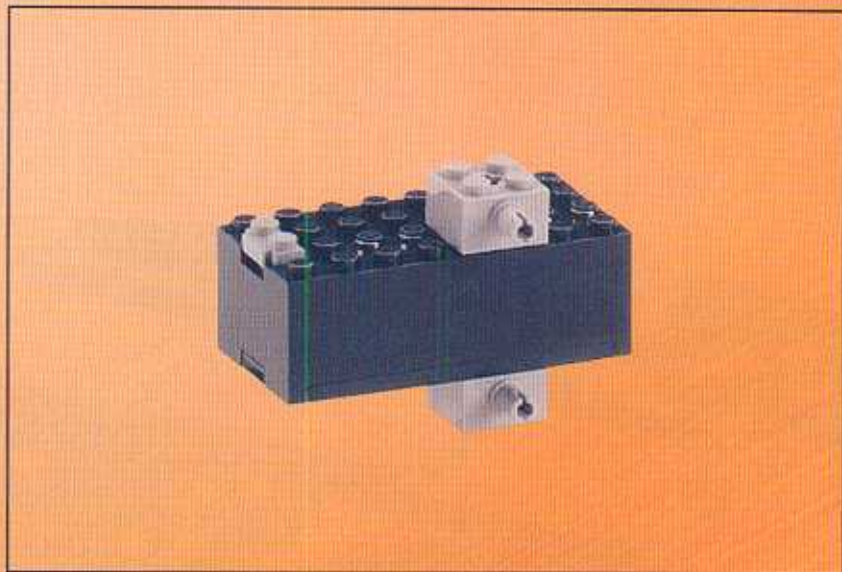

7



8

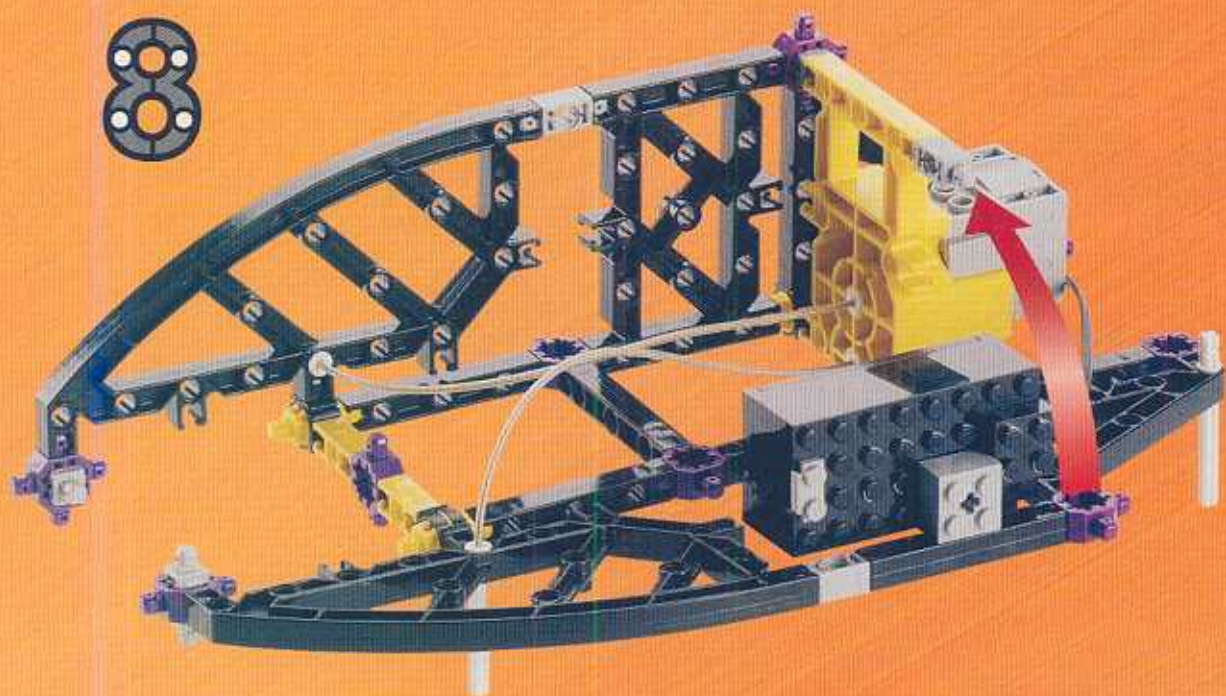

9

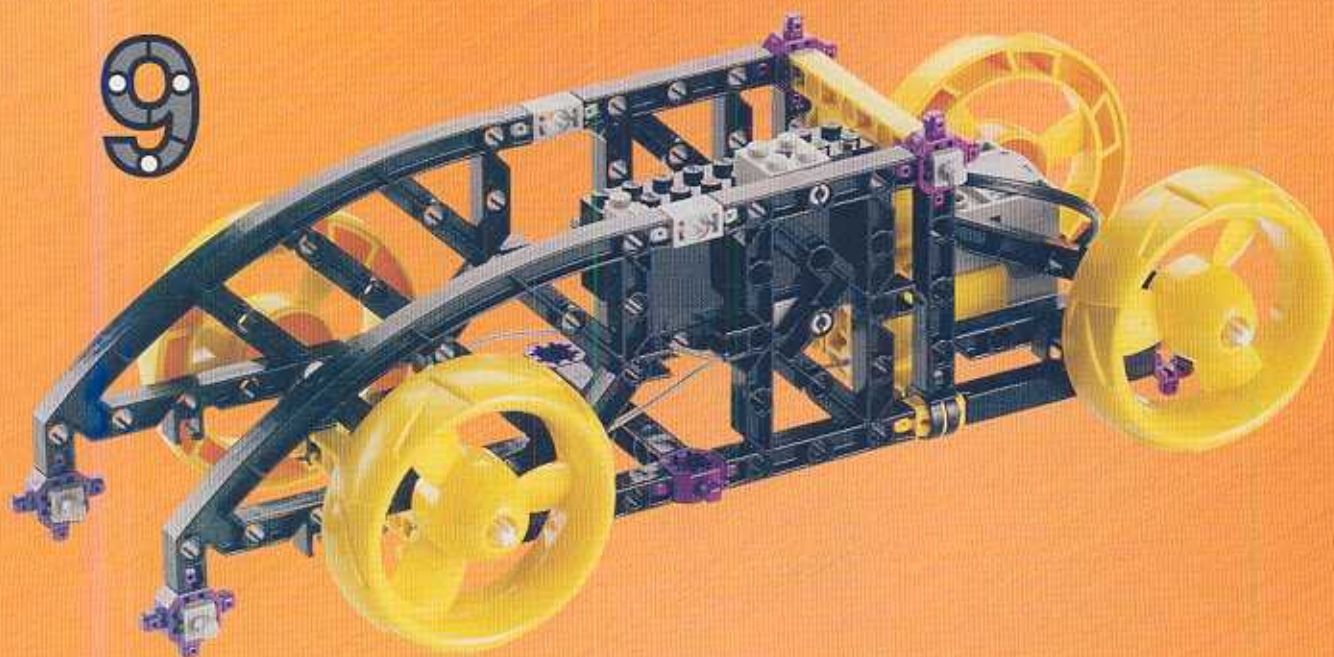

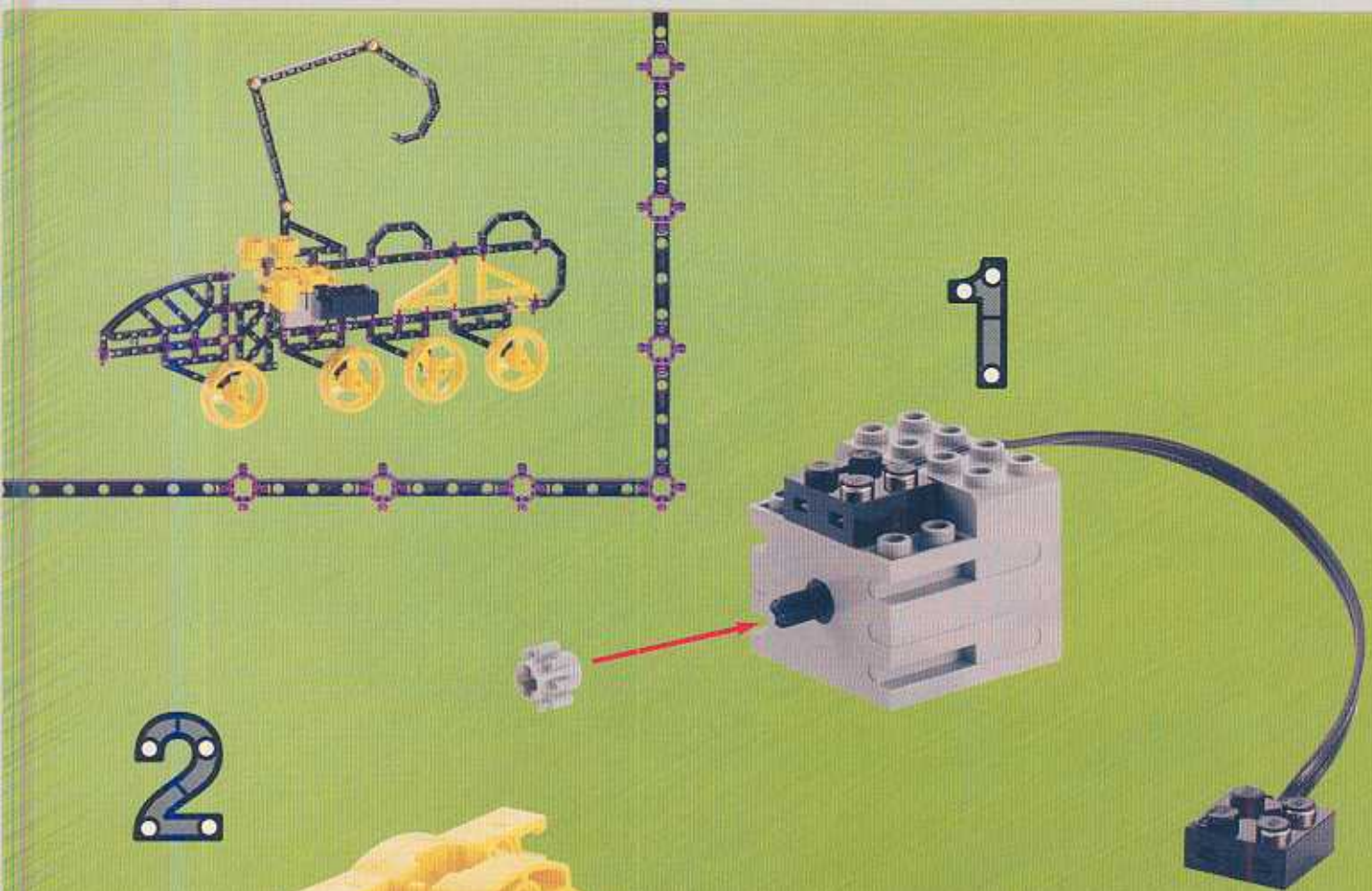

2

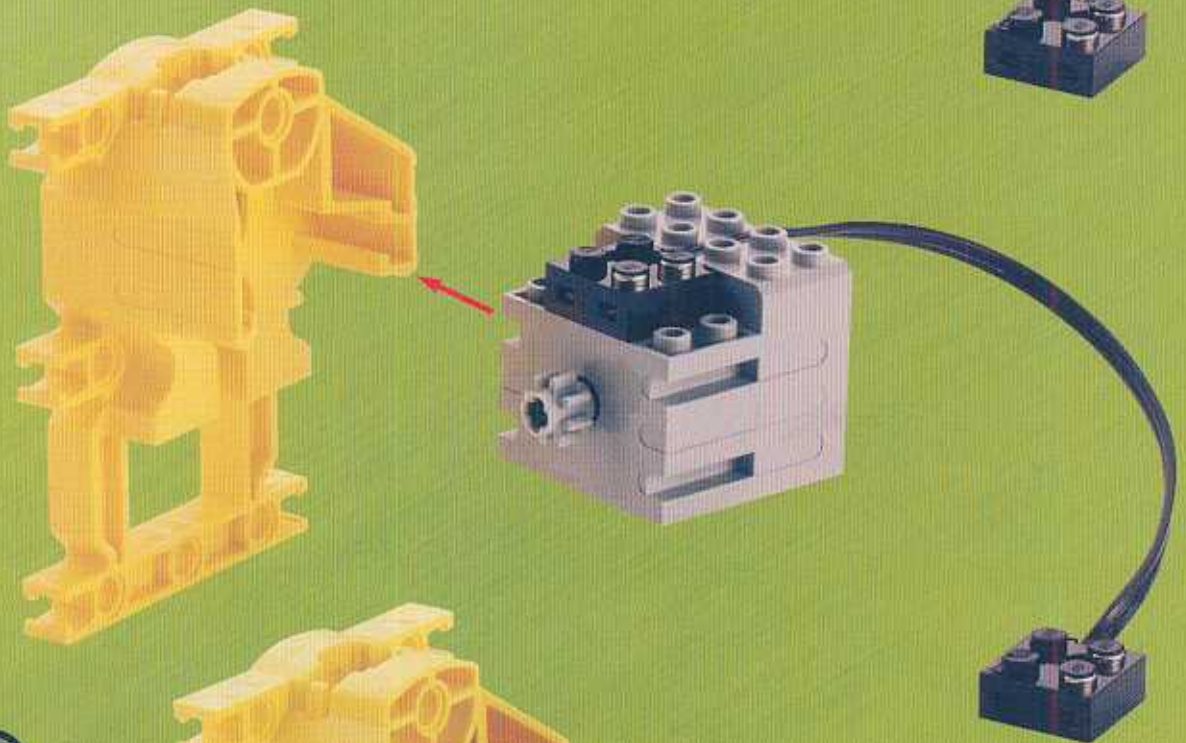

3



4

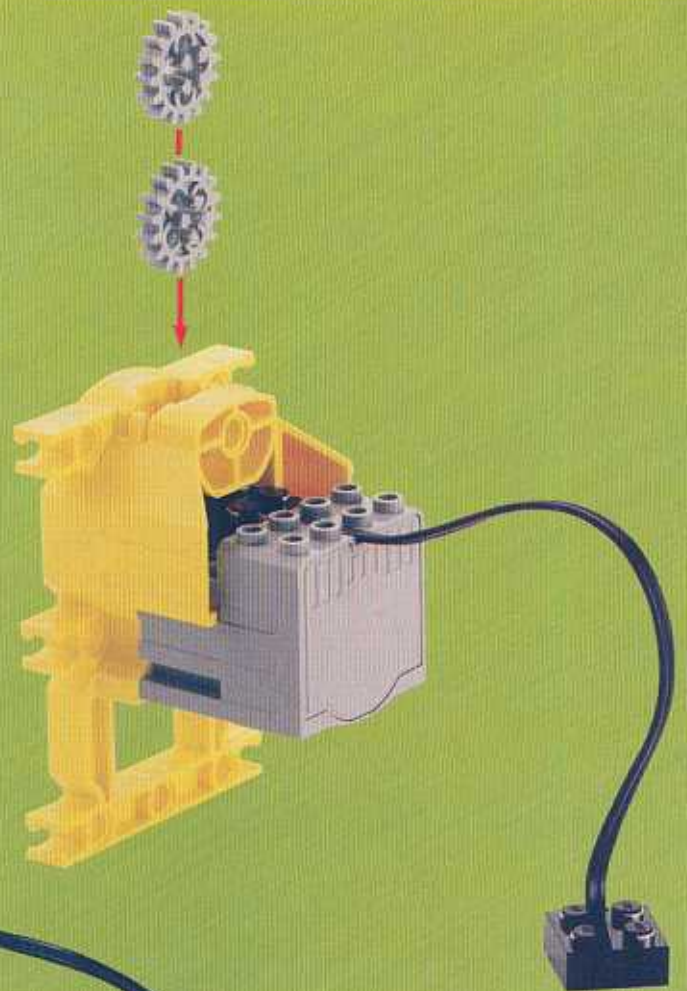

5

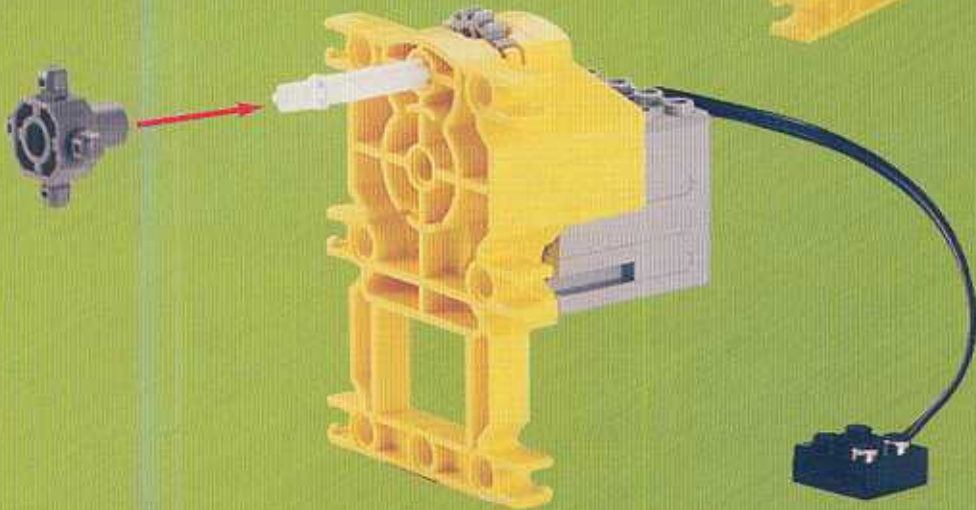

6

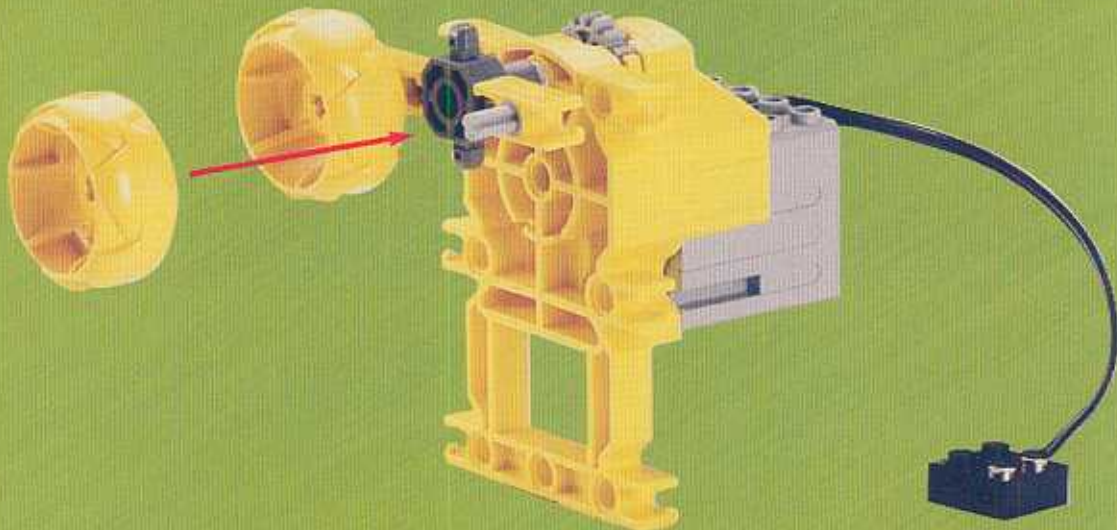



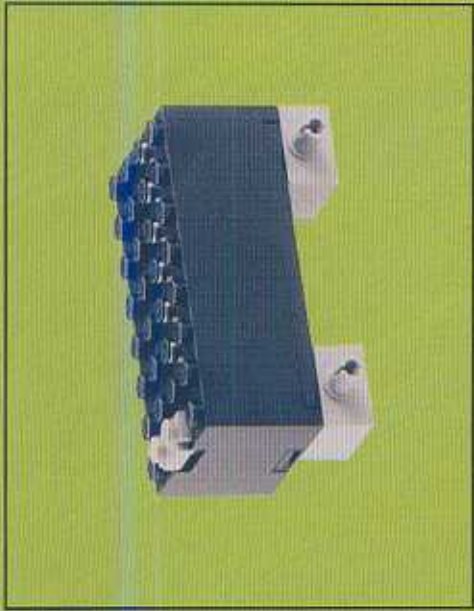

2



1

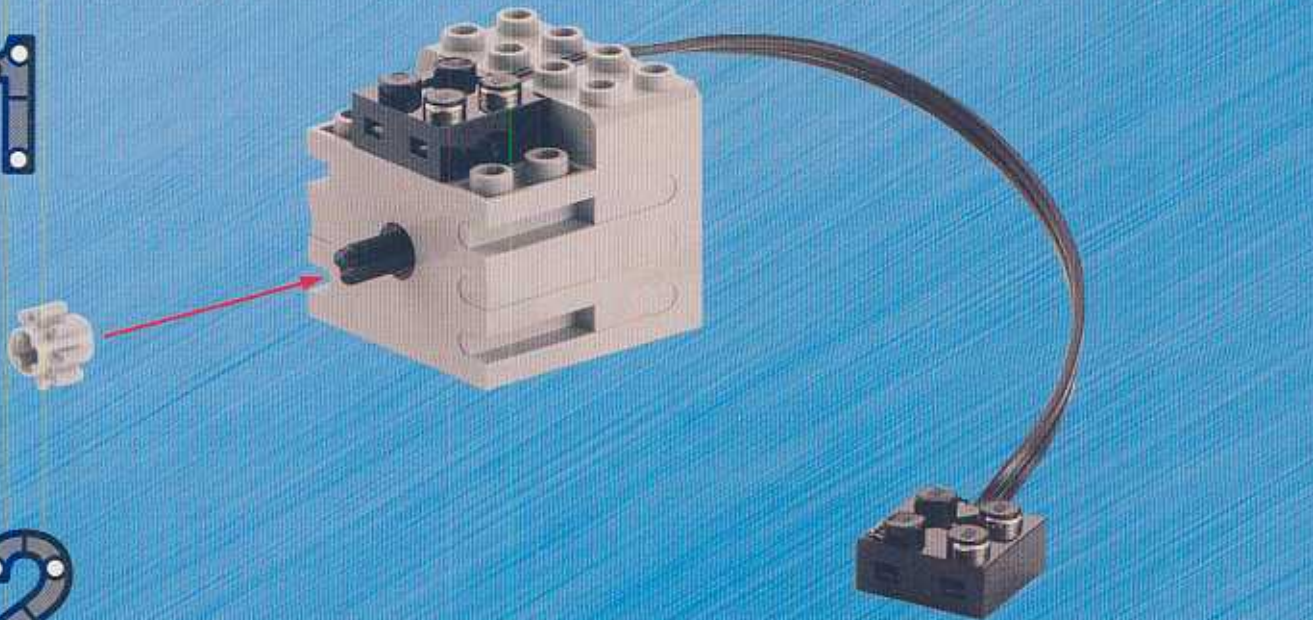

2

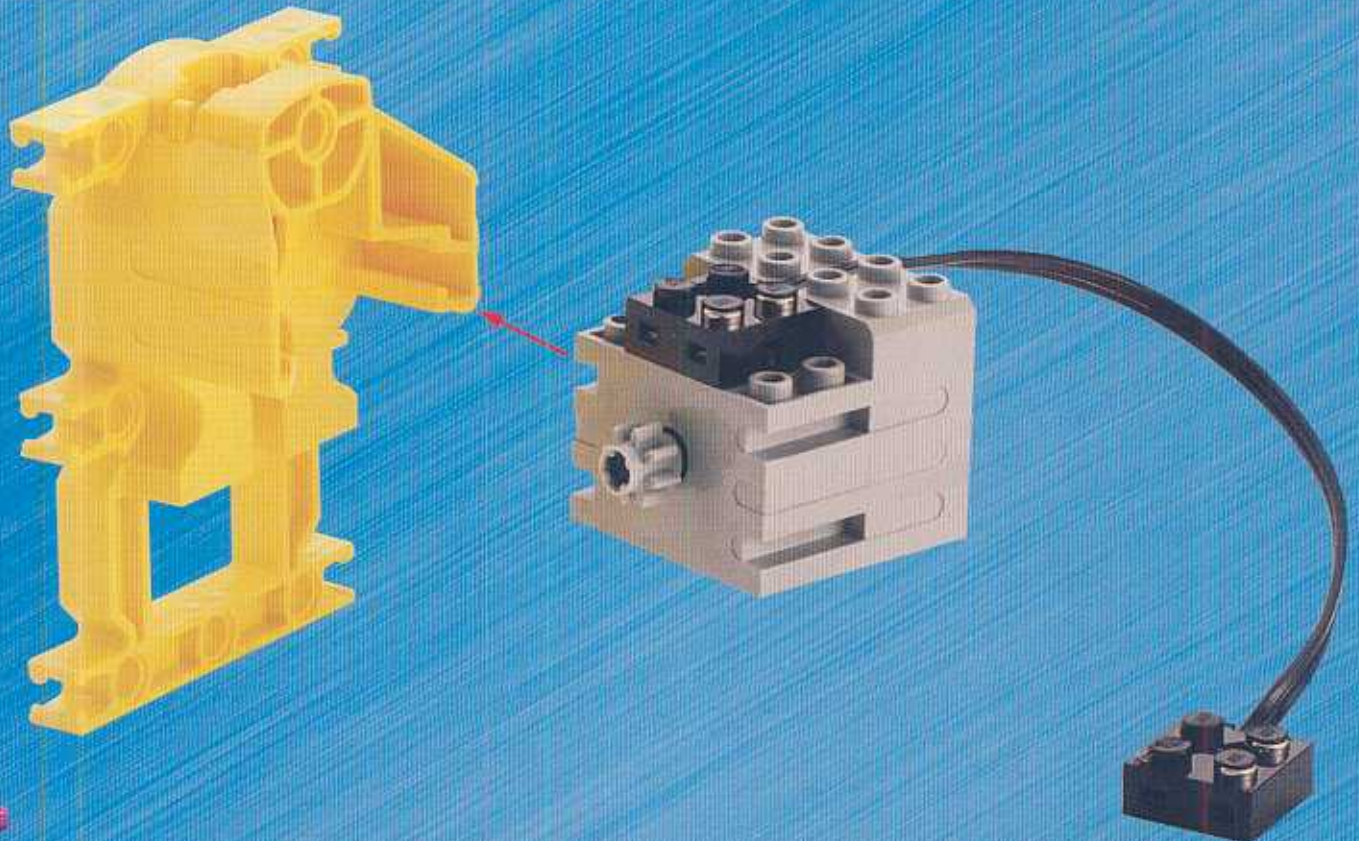

3



4

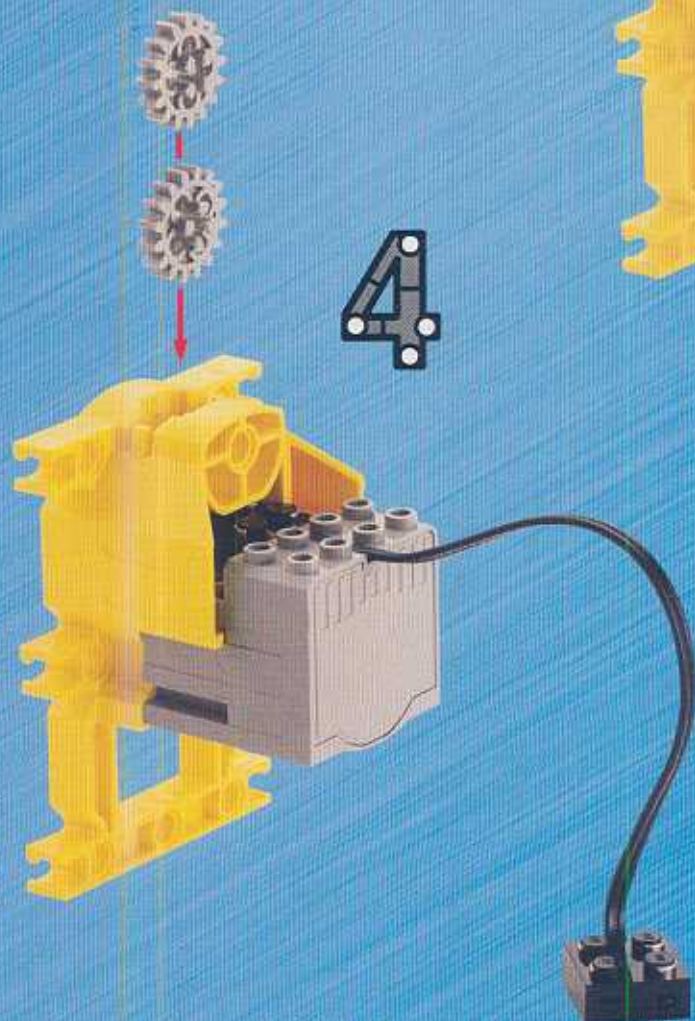

5

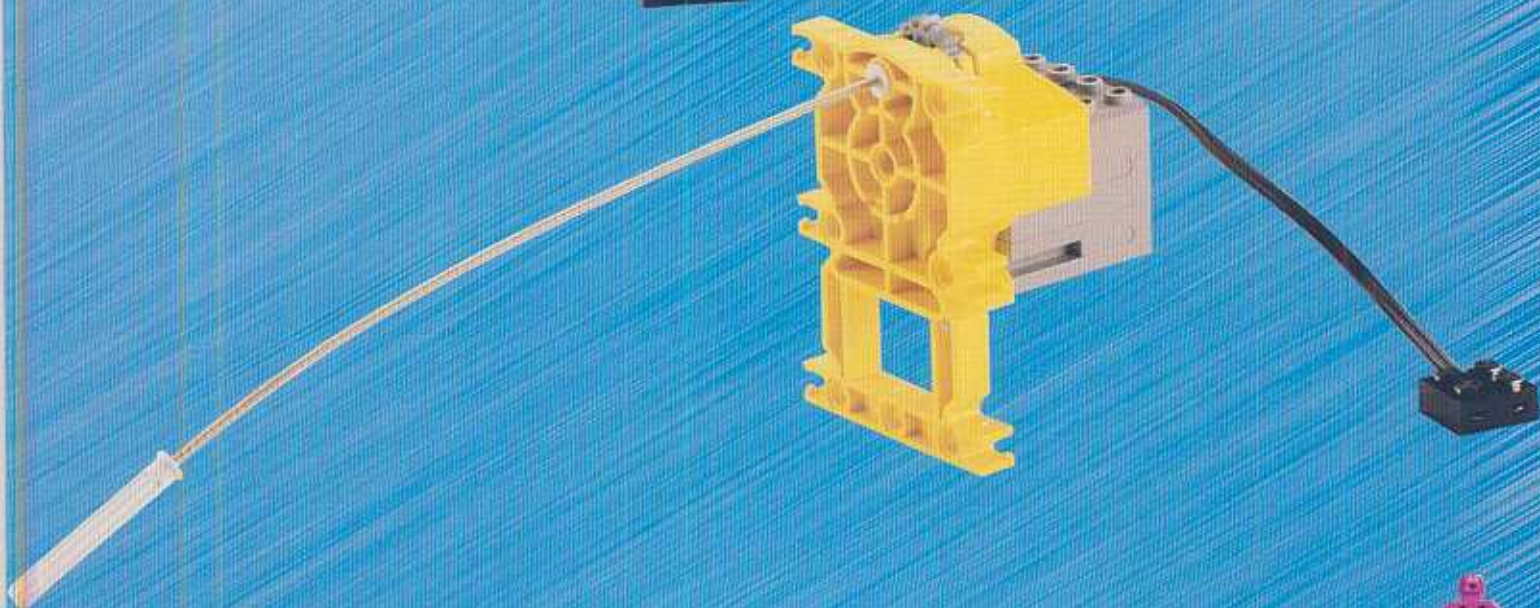

1

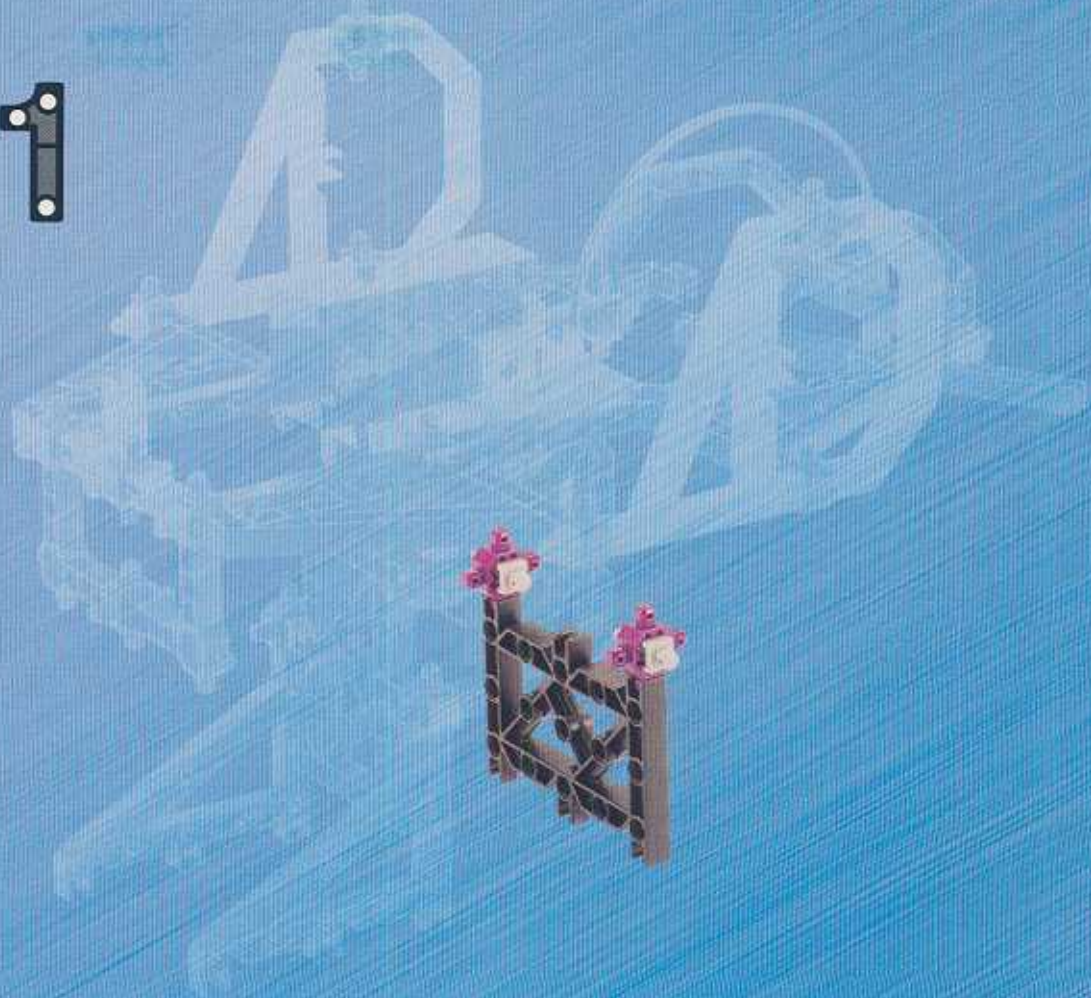

2



3



4



5

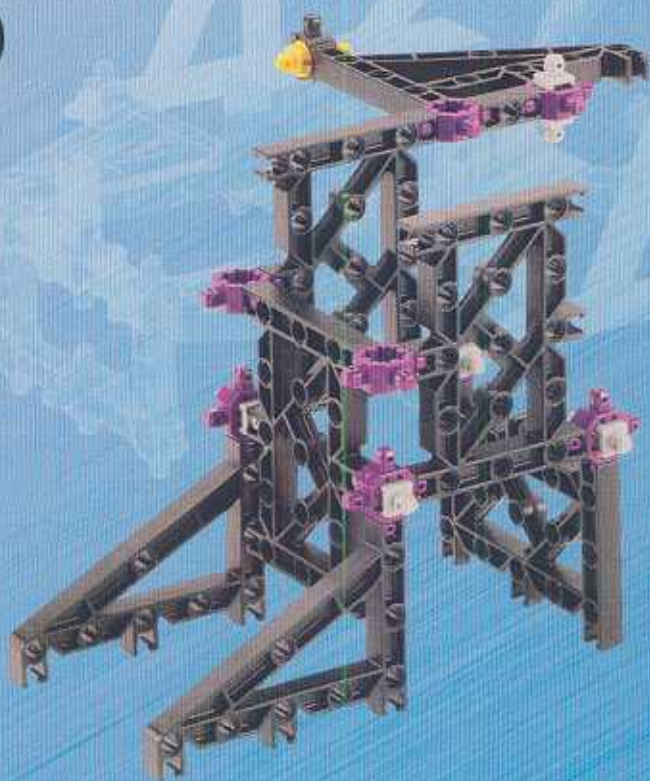

6



7

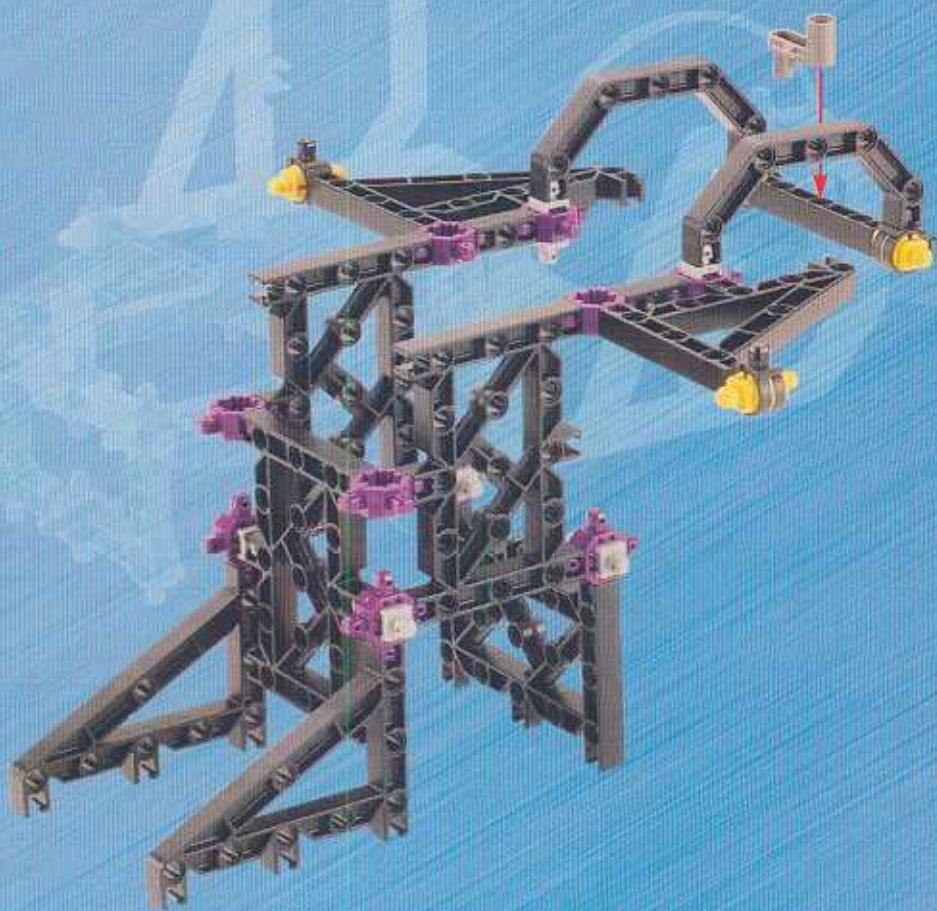

8



9



10



11



12



13

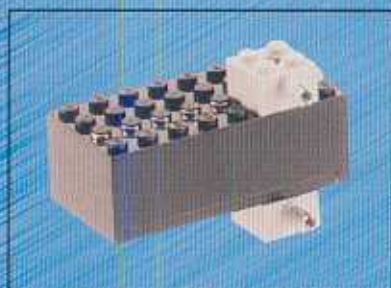

14



1



2



3



15



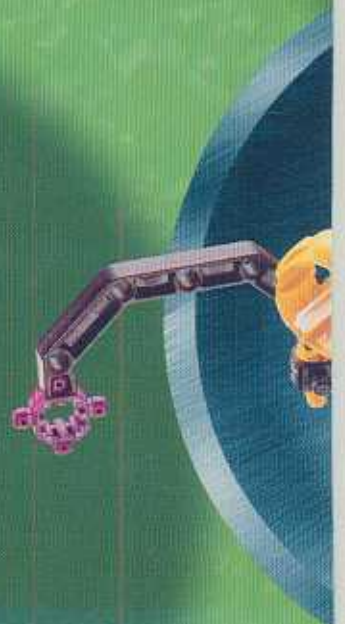
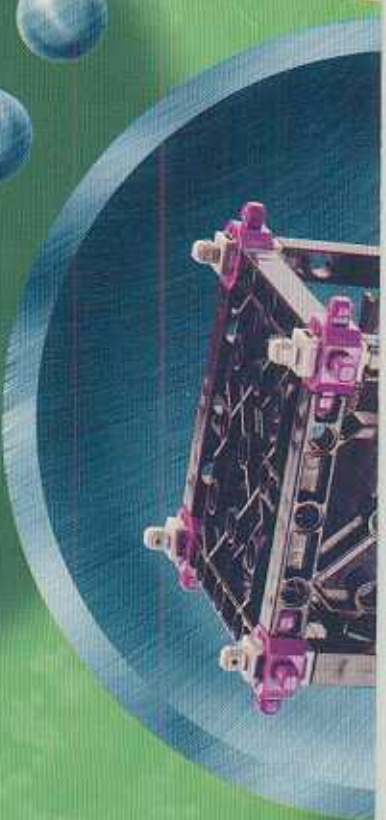
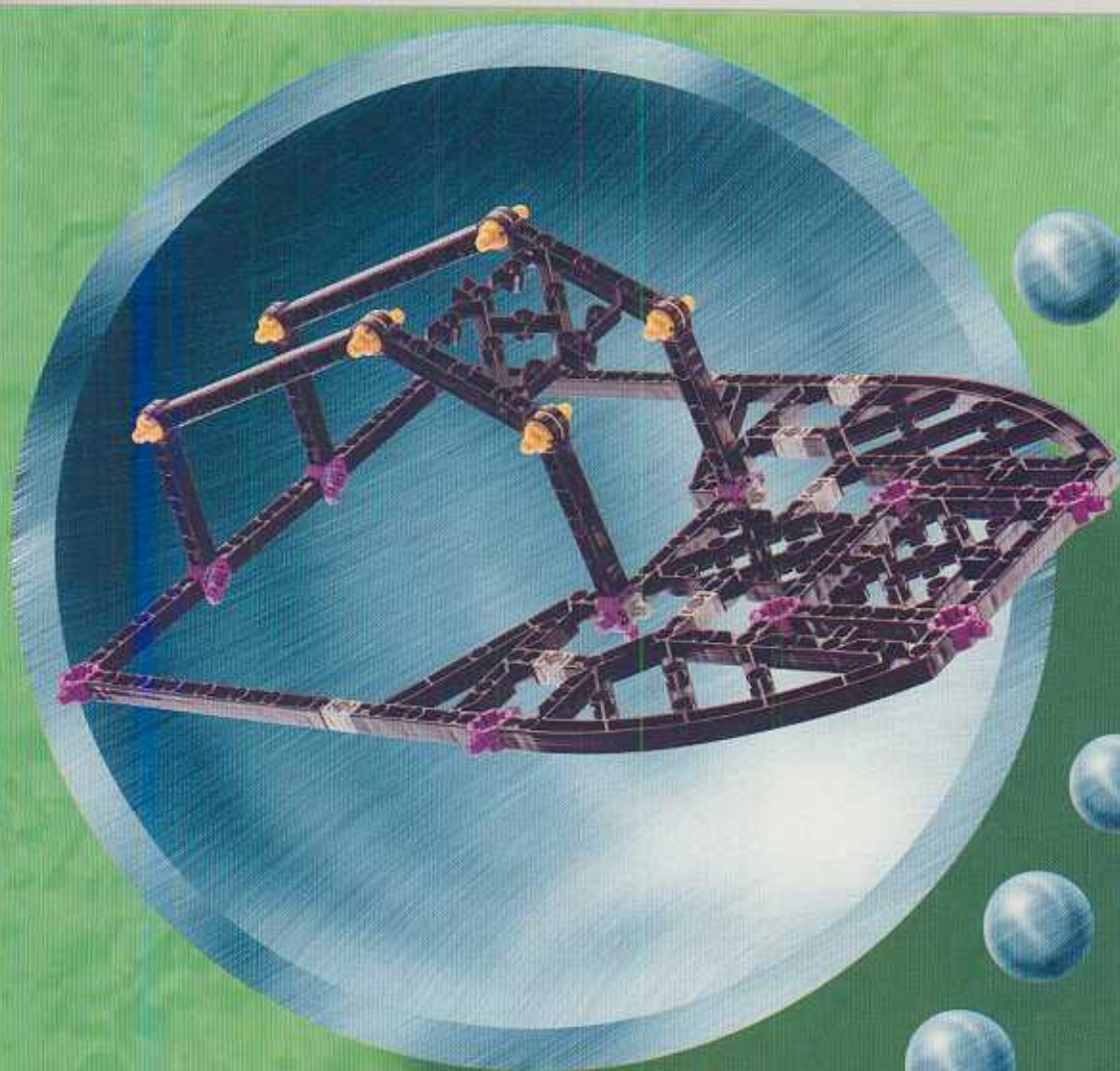



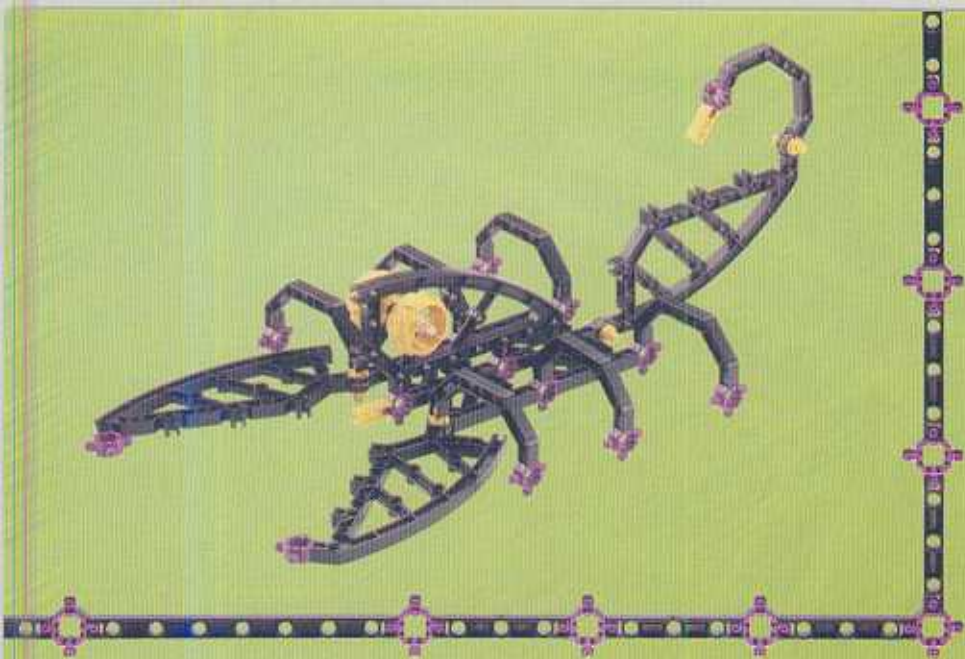

2



3



4

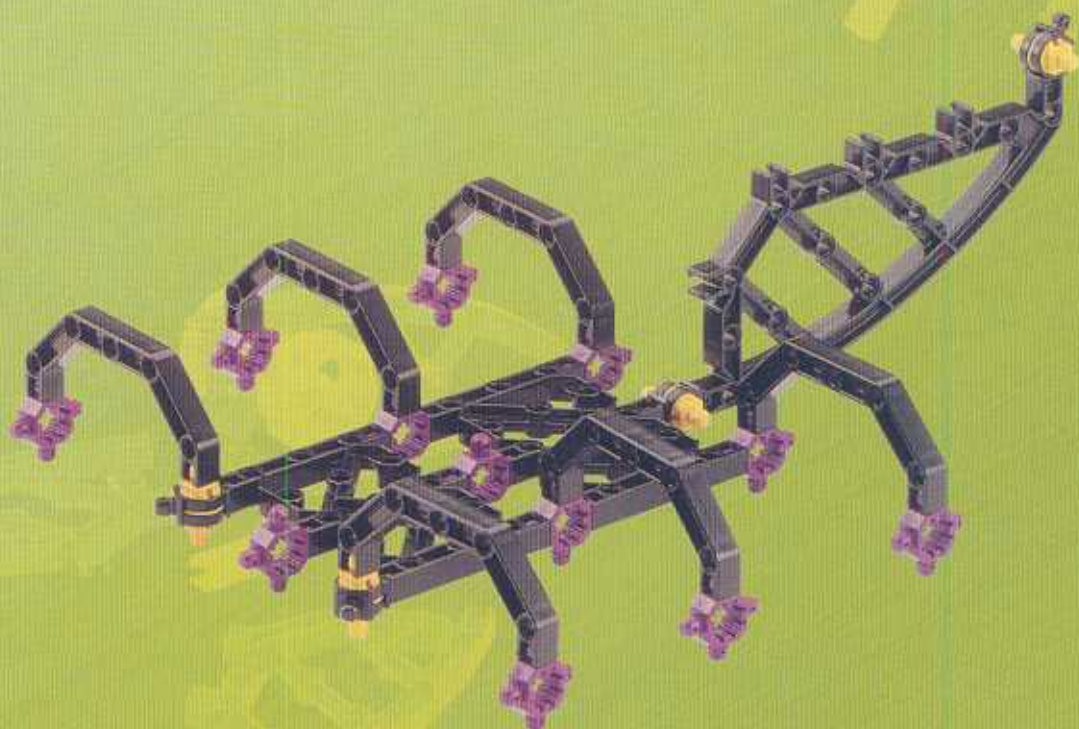

5



6



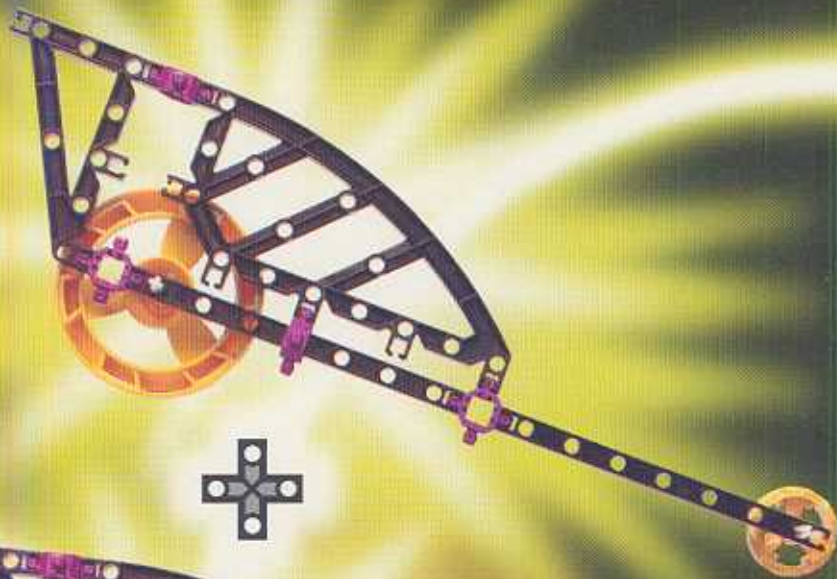

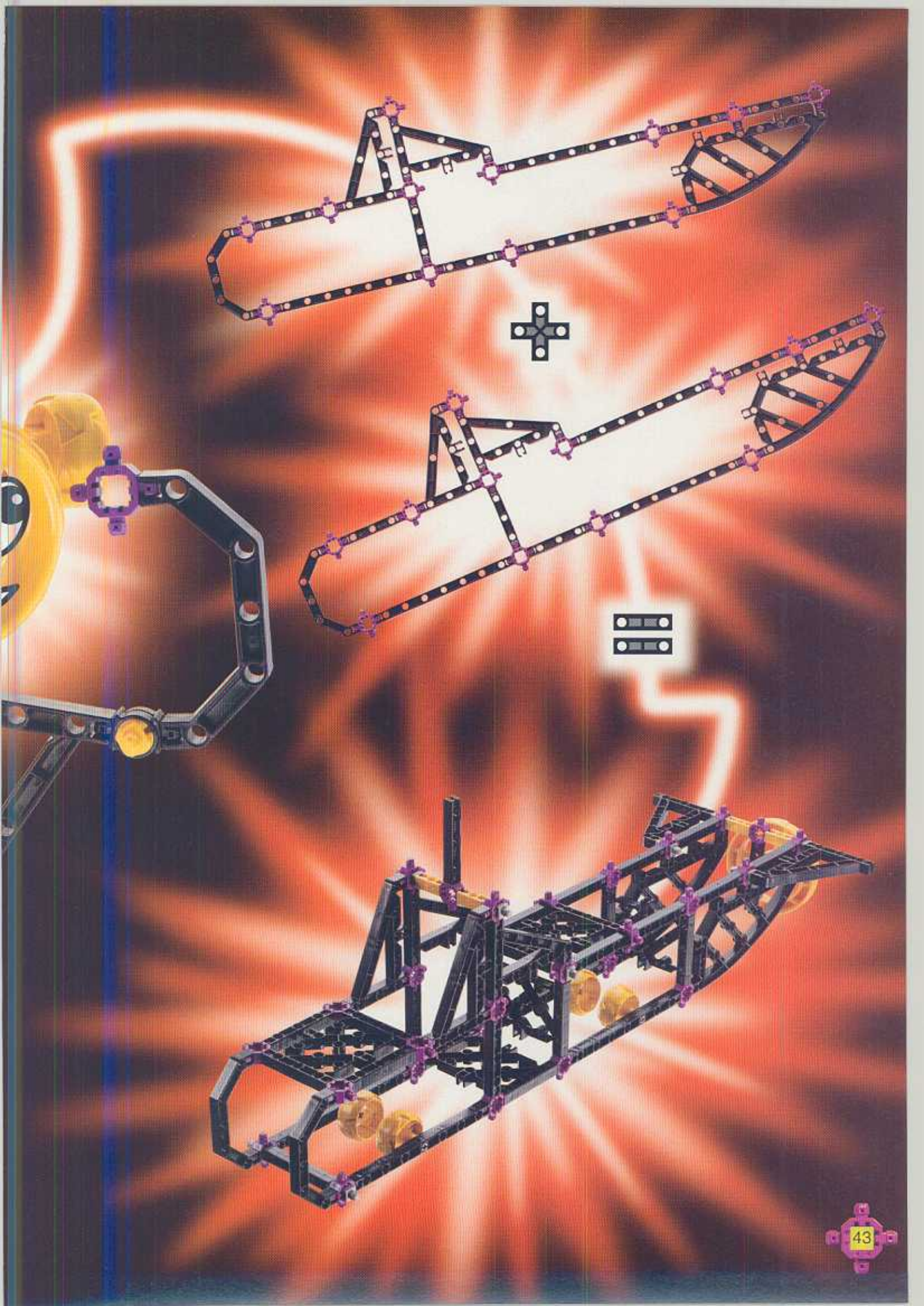

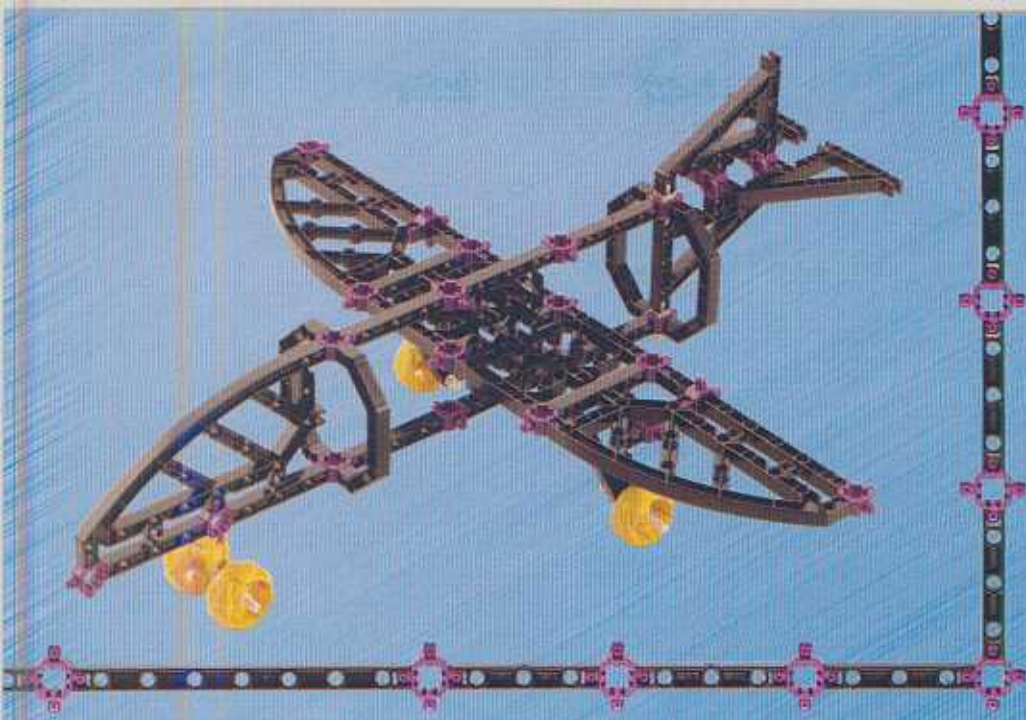

2

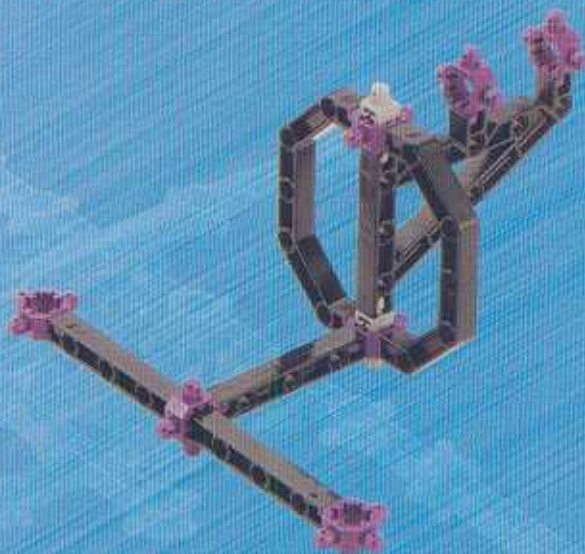

3

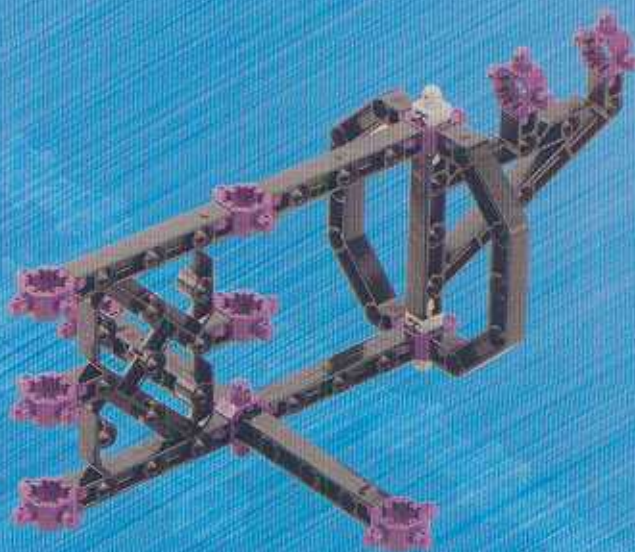

4



5

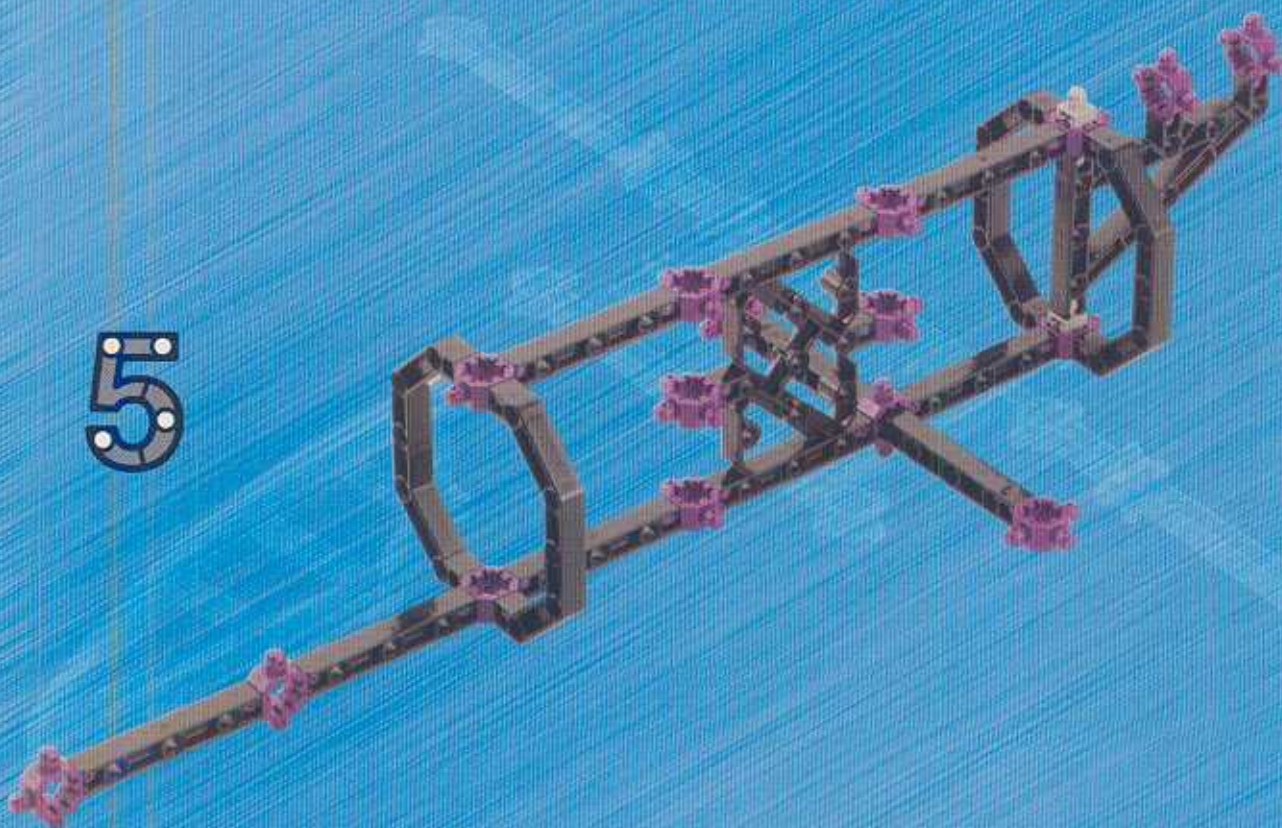

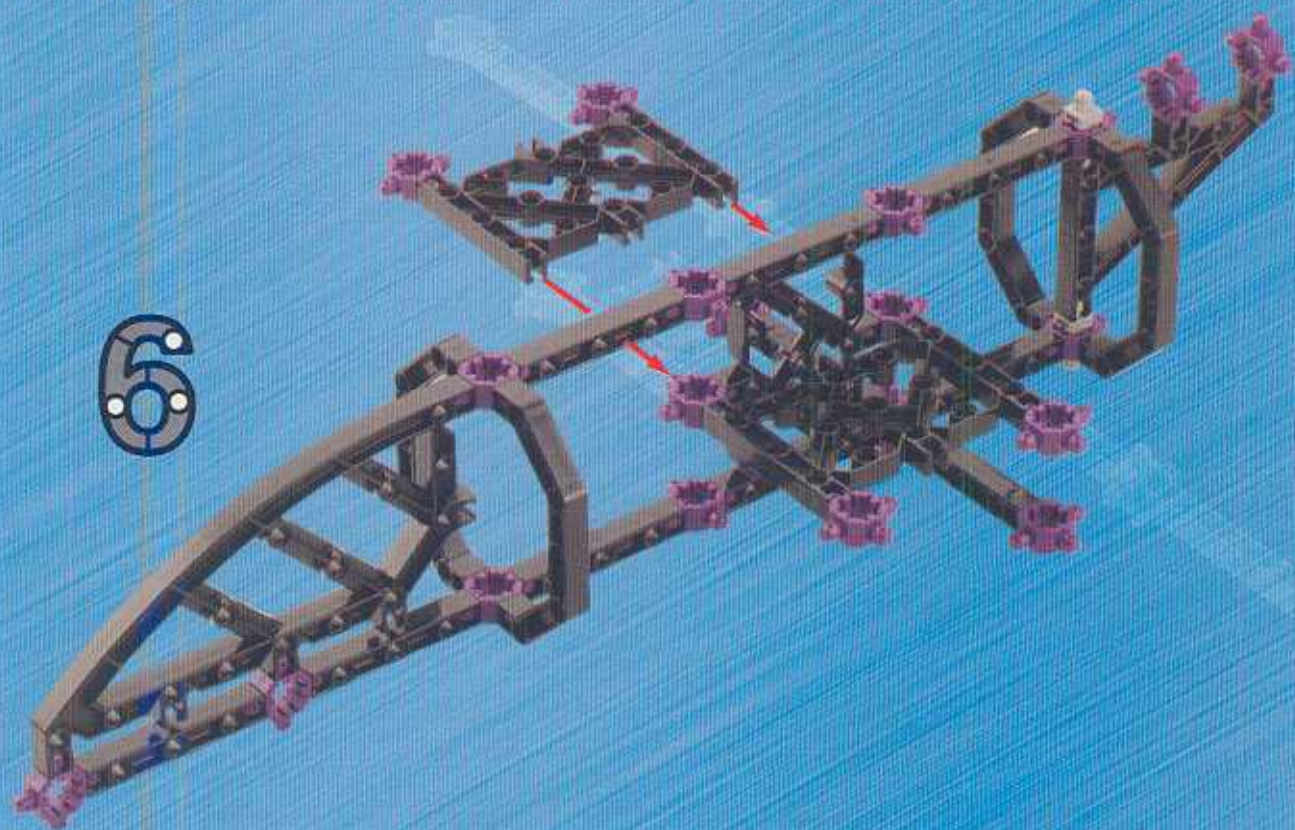

6



7



8

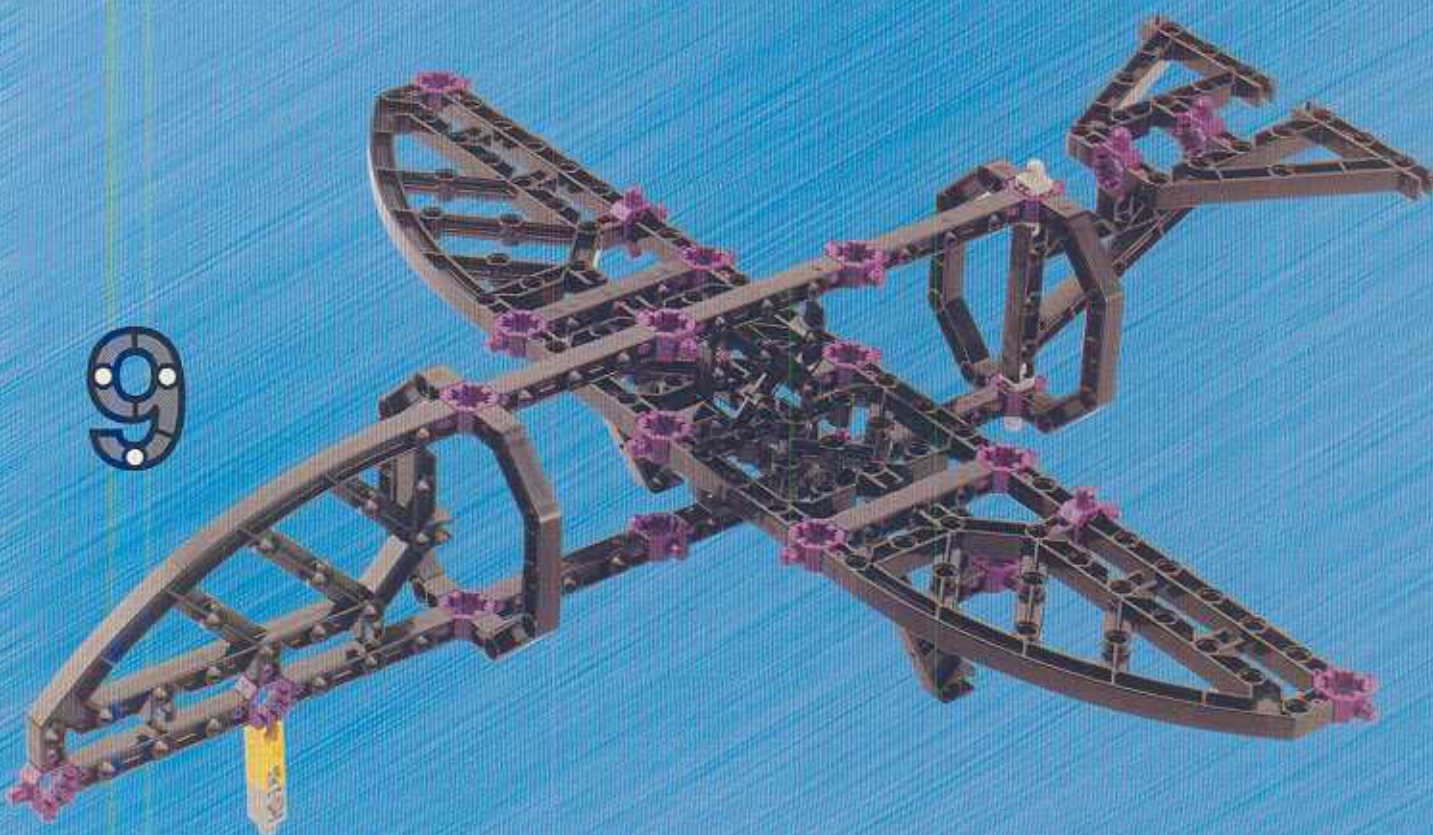

9

10



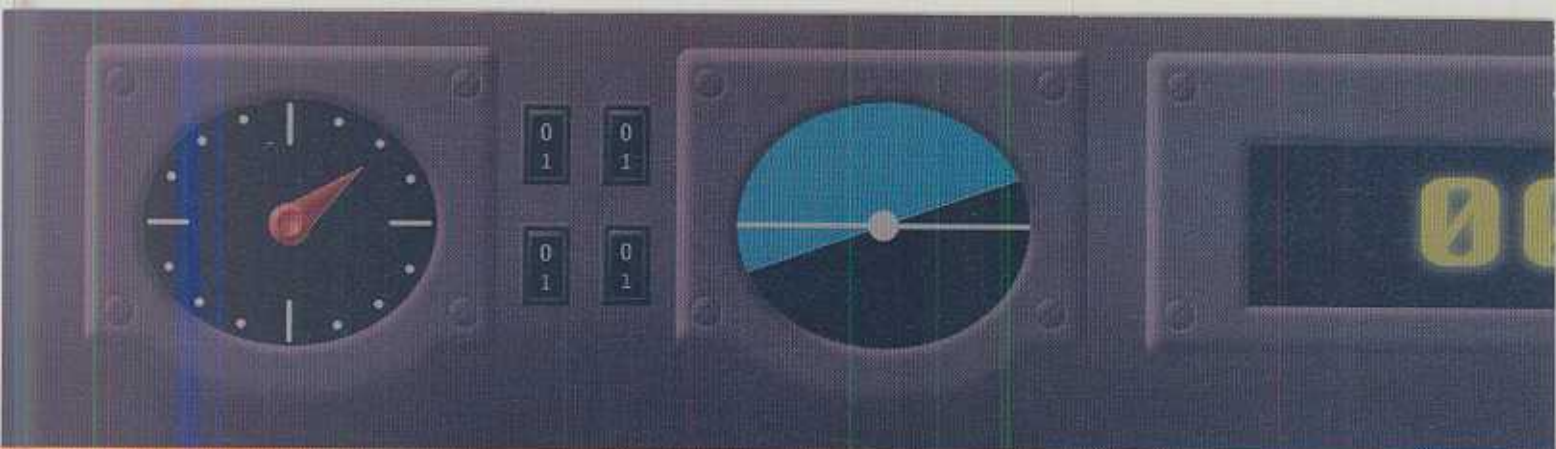

ALT

023



TIME

15:34

FUEL

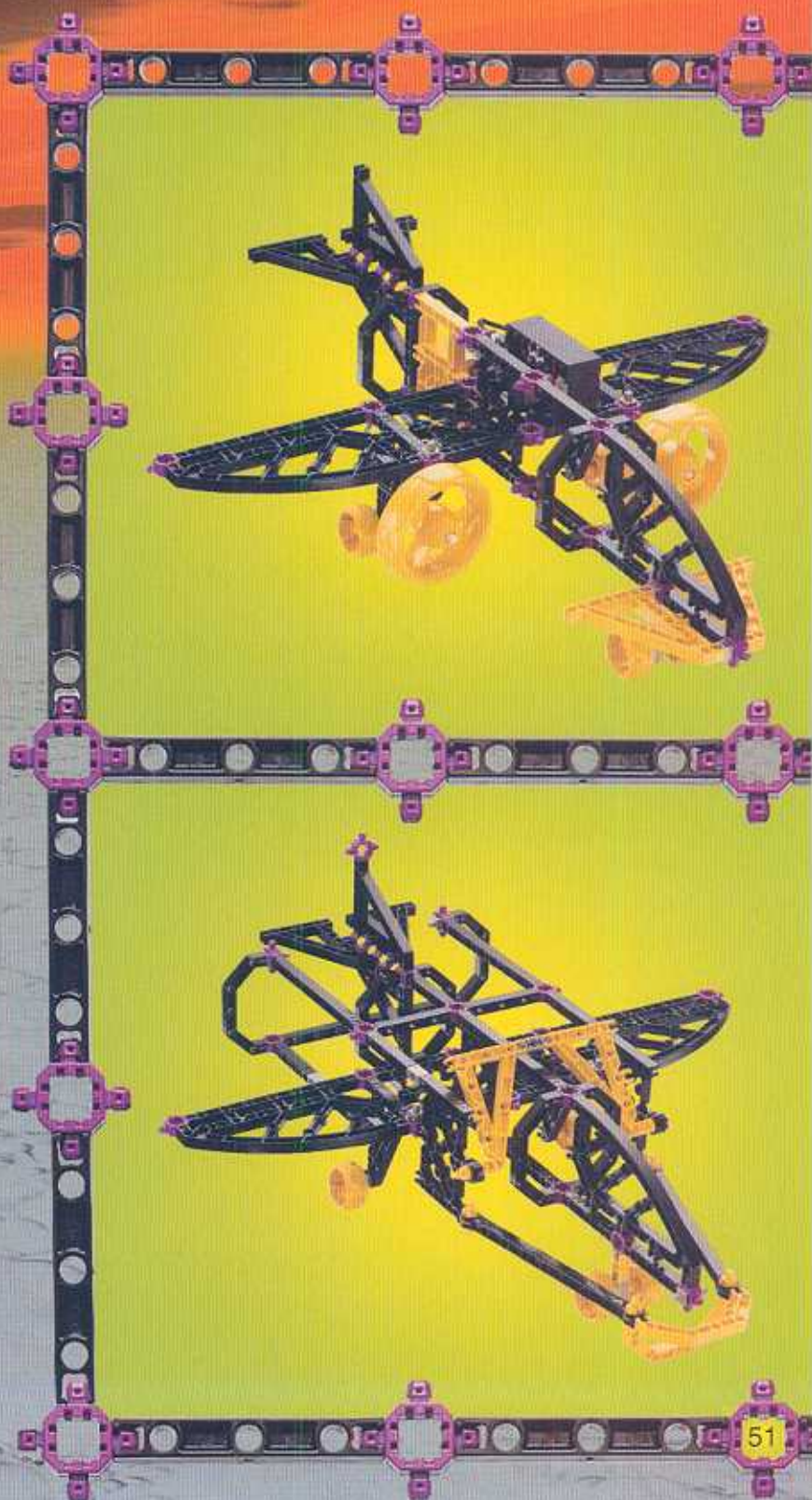
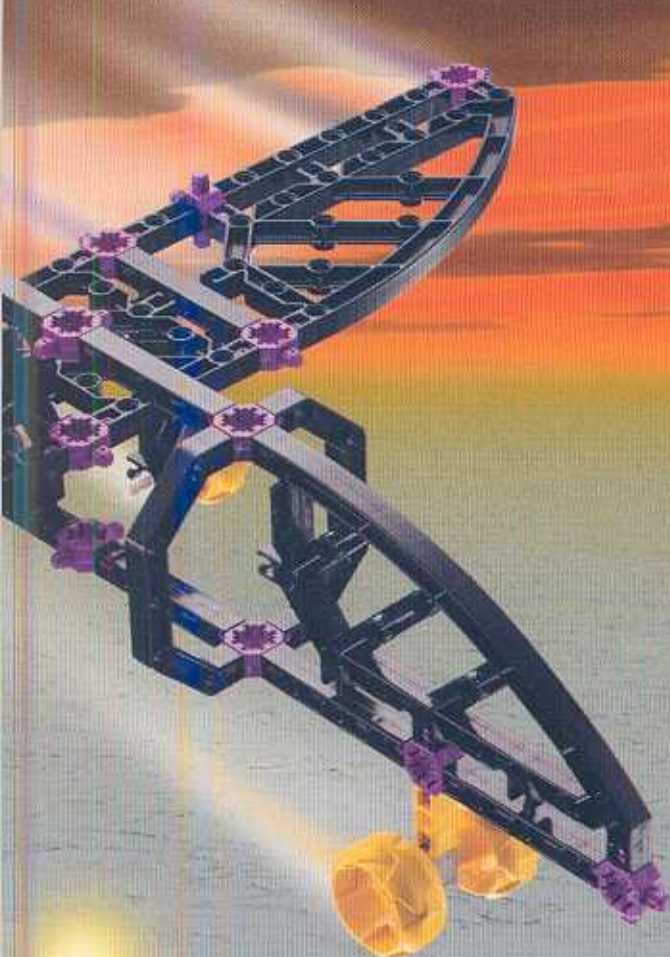

3

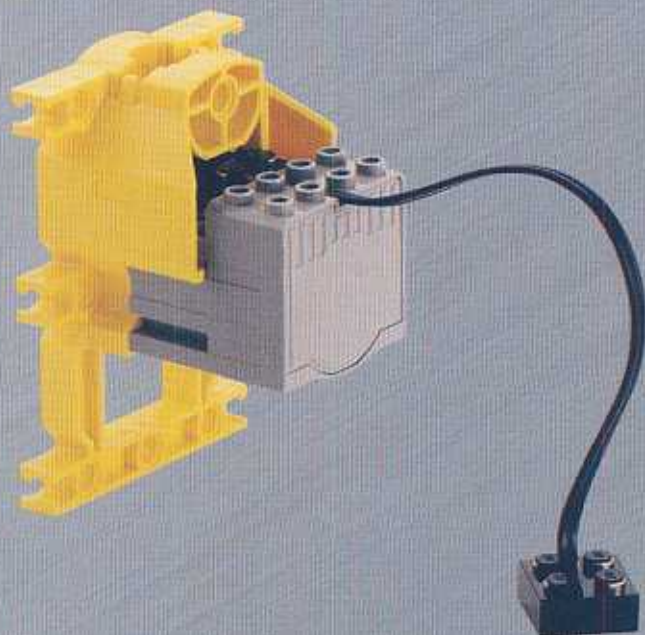

4

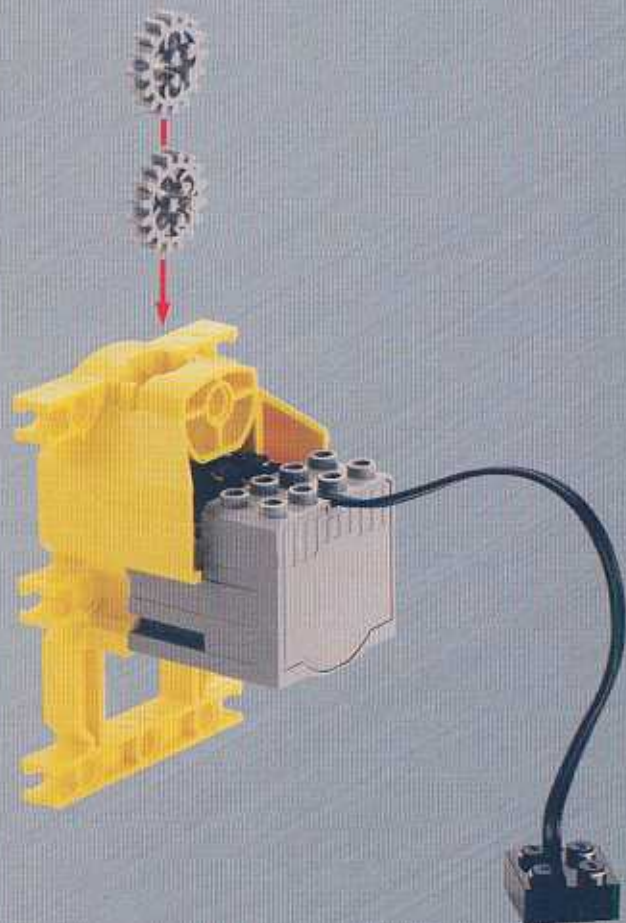

5



1

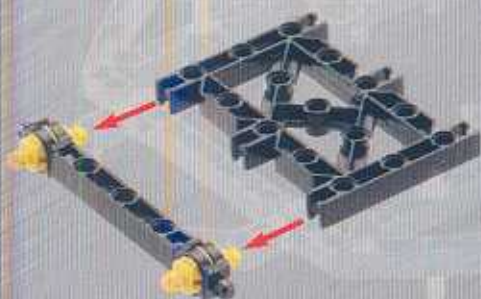

2

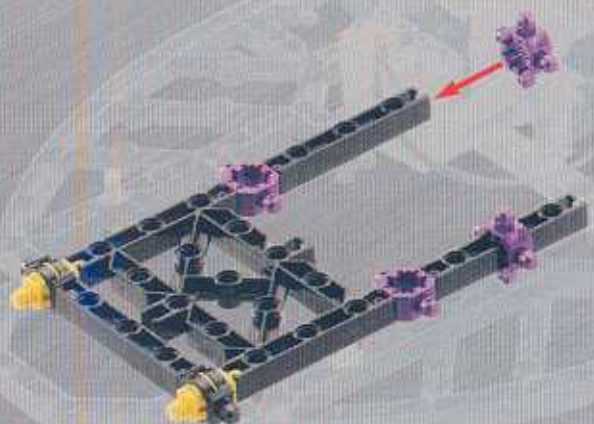

3

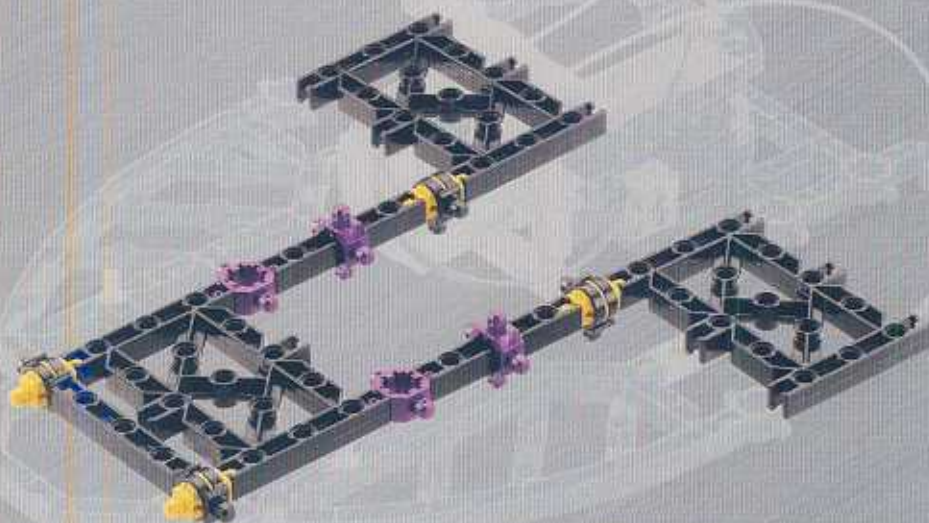

4

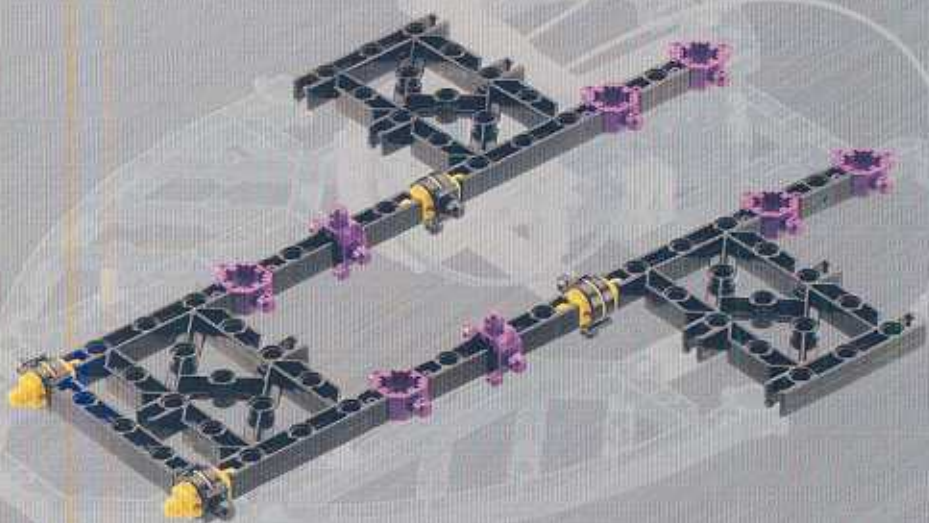

5

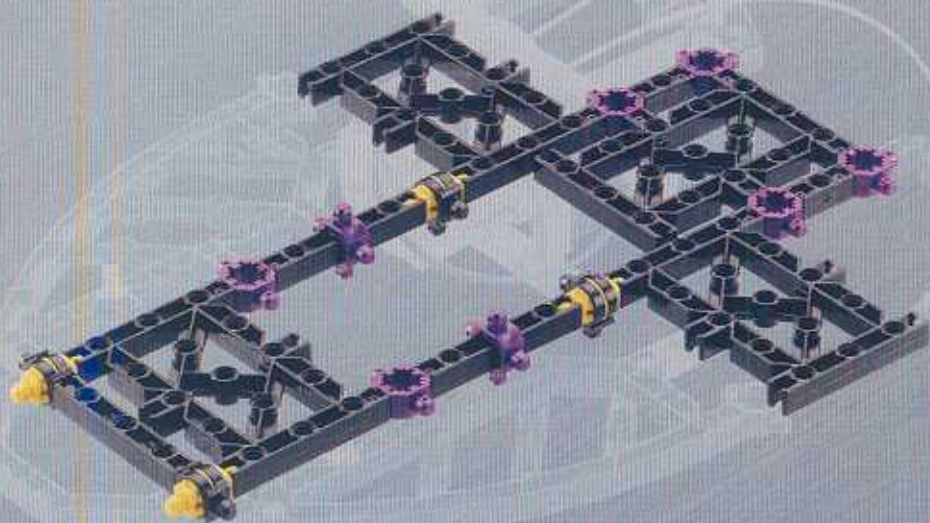

6



7



8

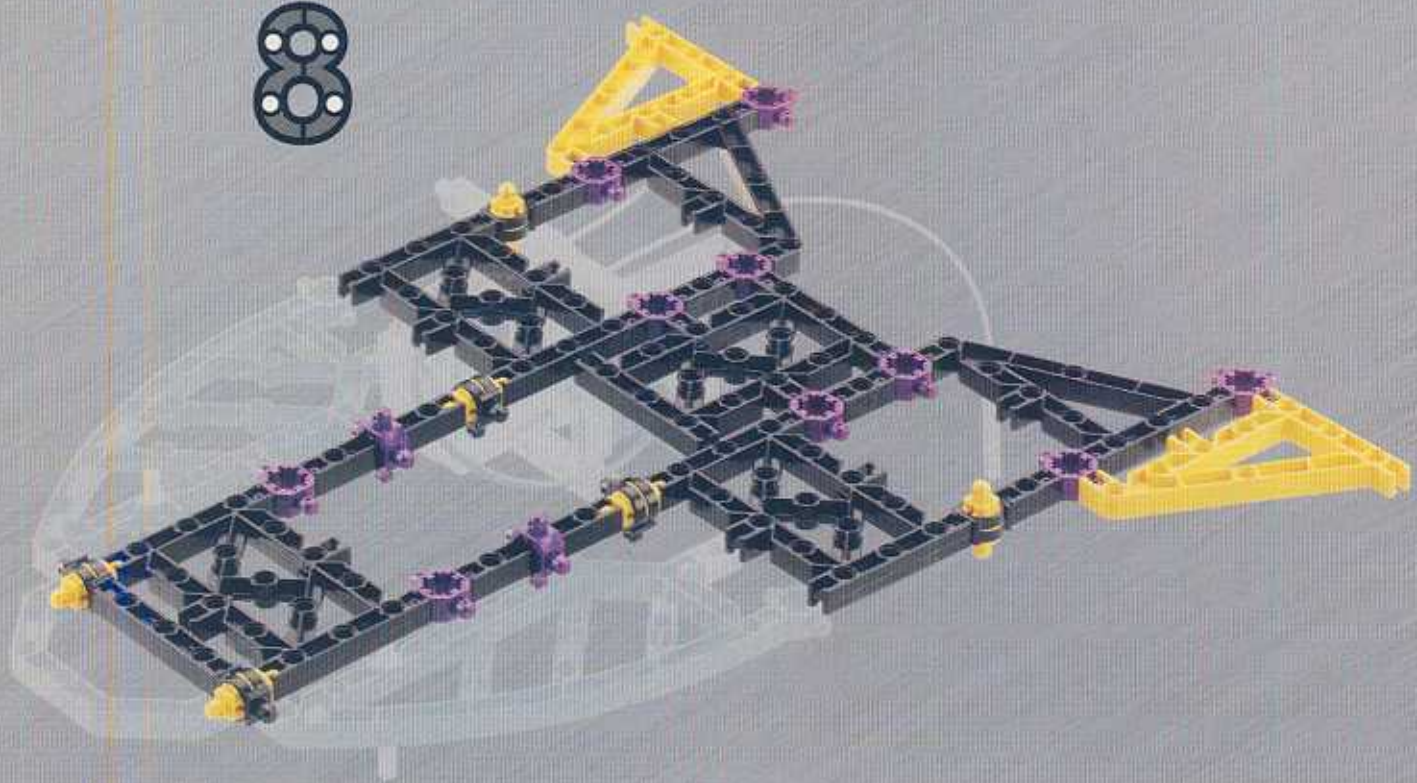

9



10

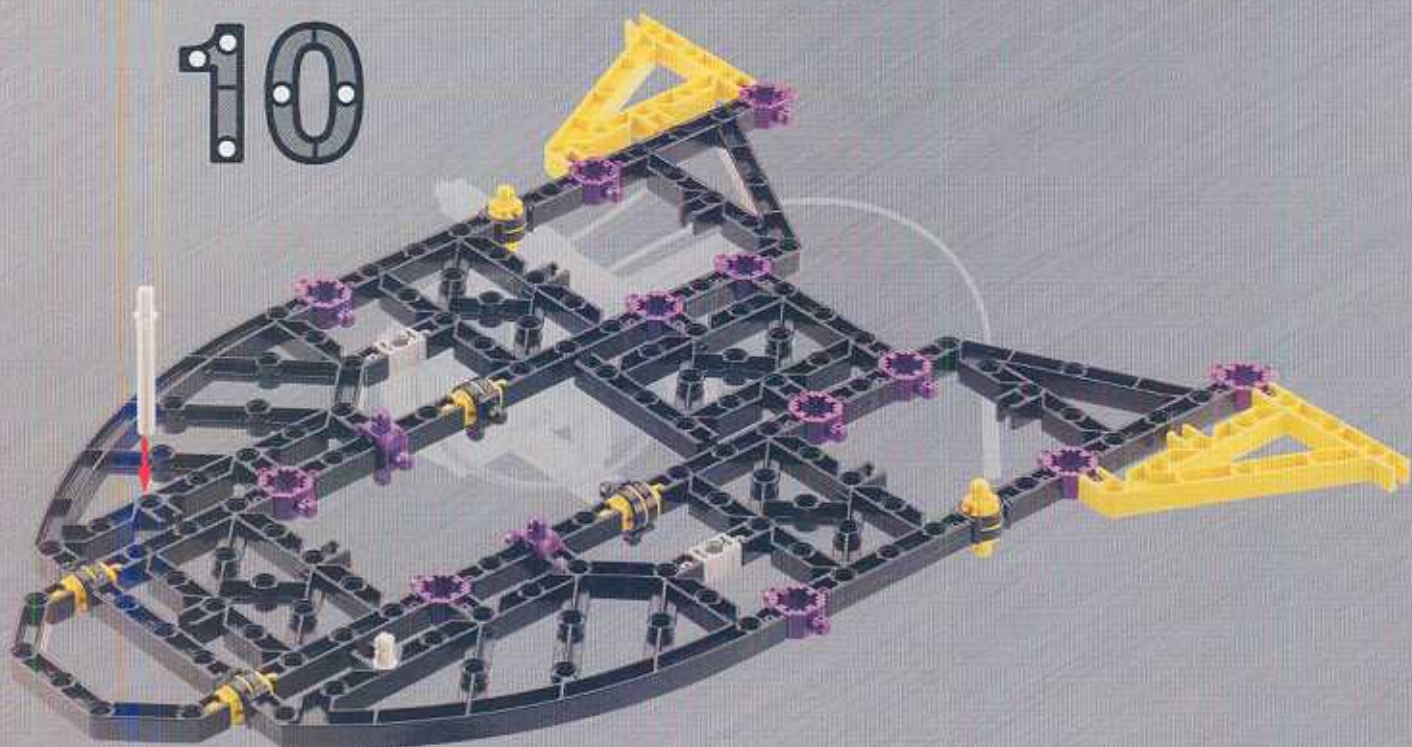

11

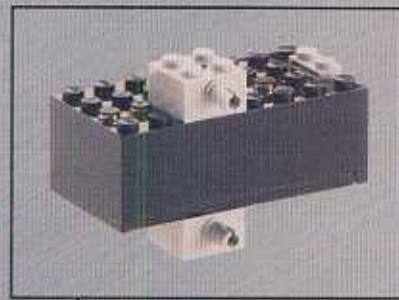
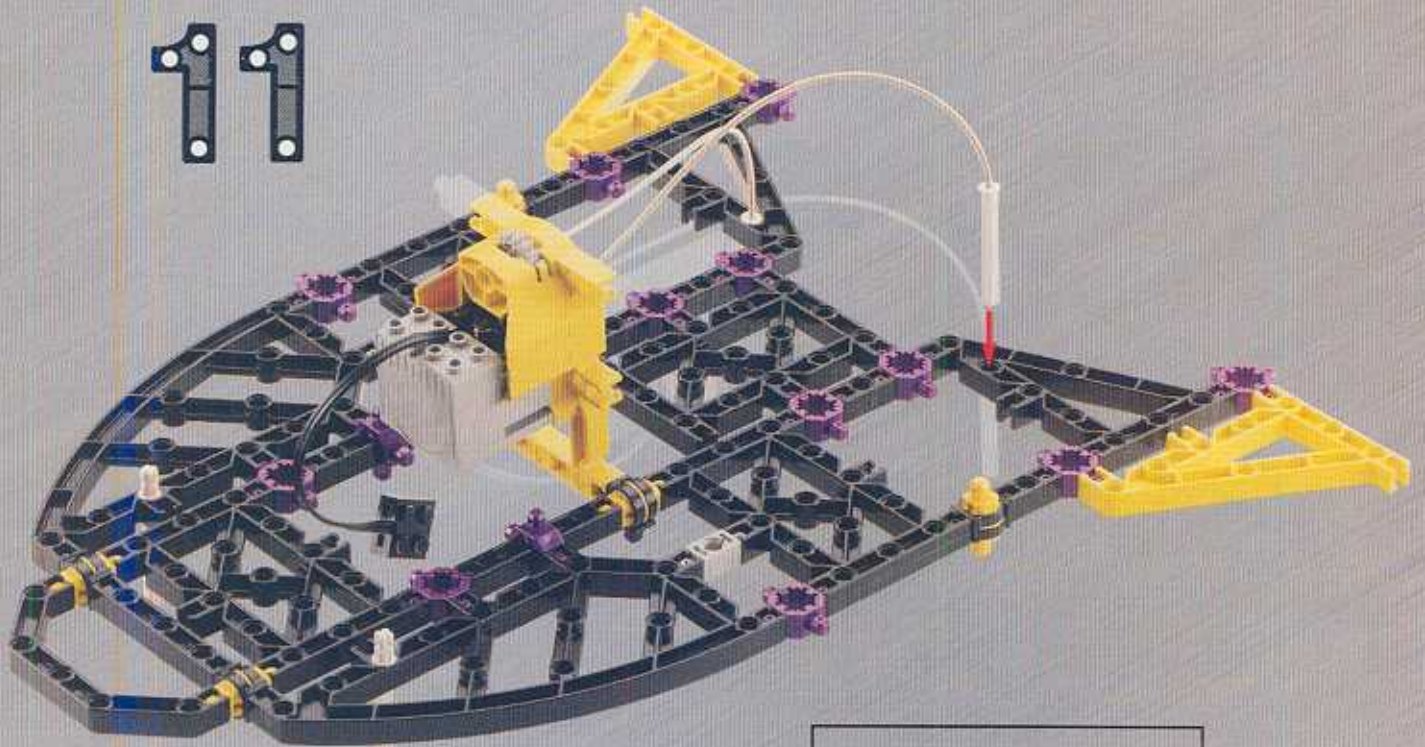

12

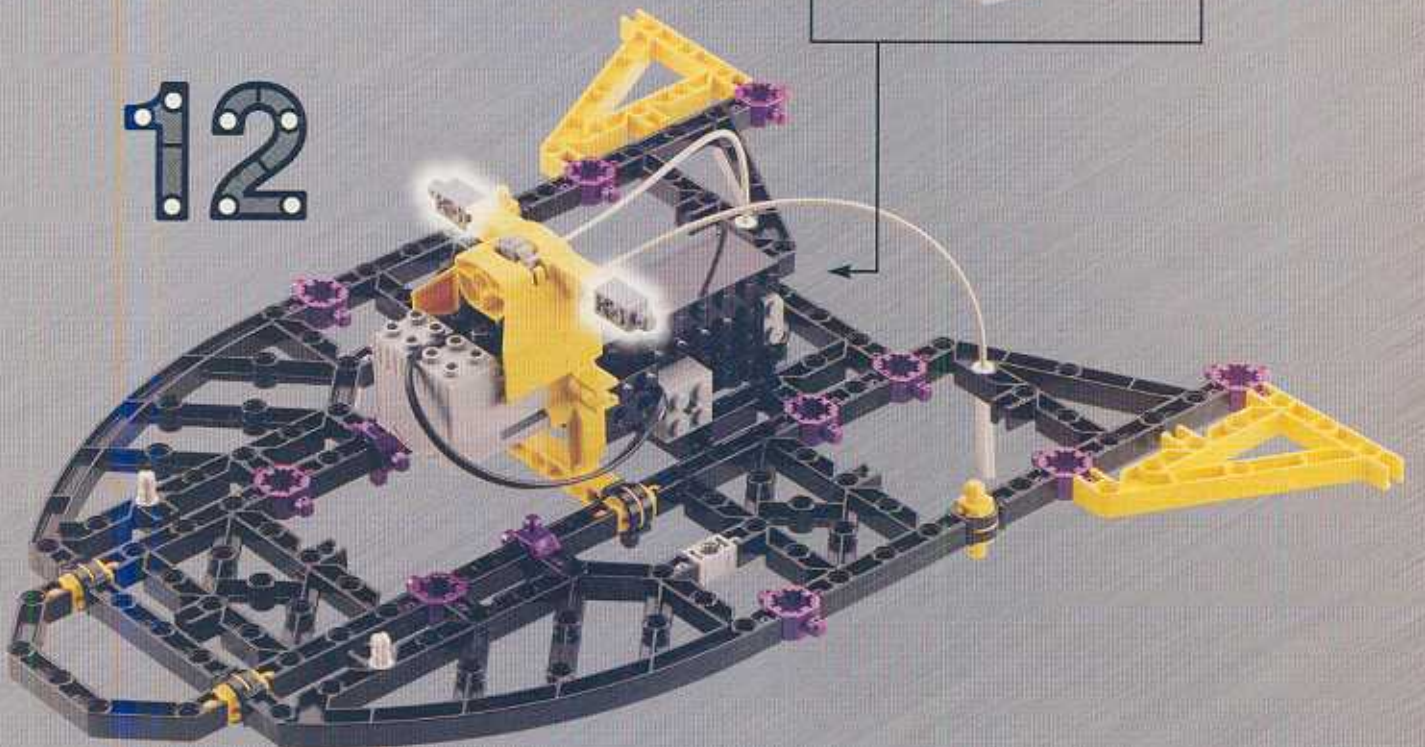

13



14



15

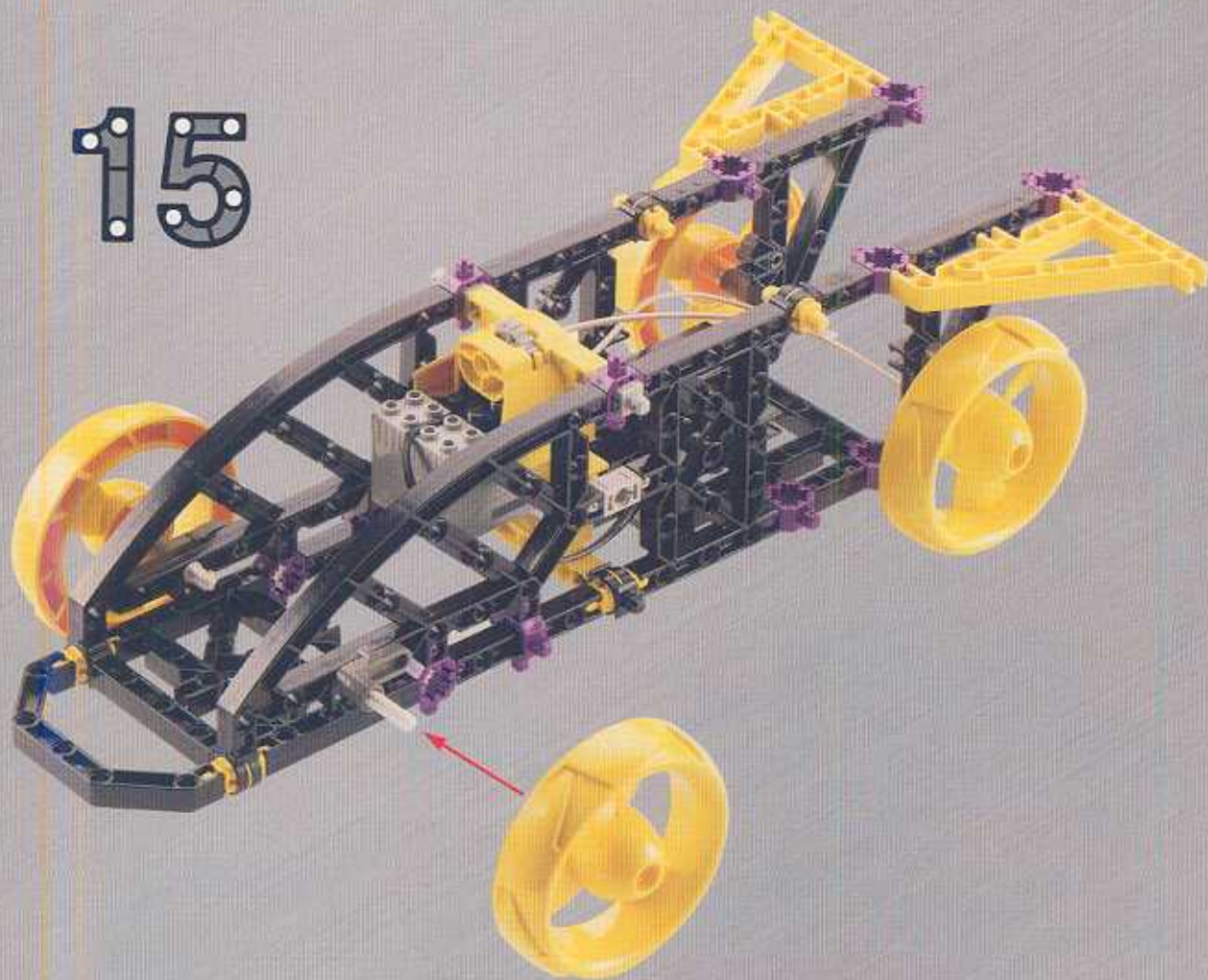

16



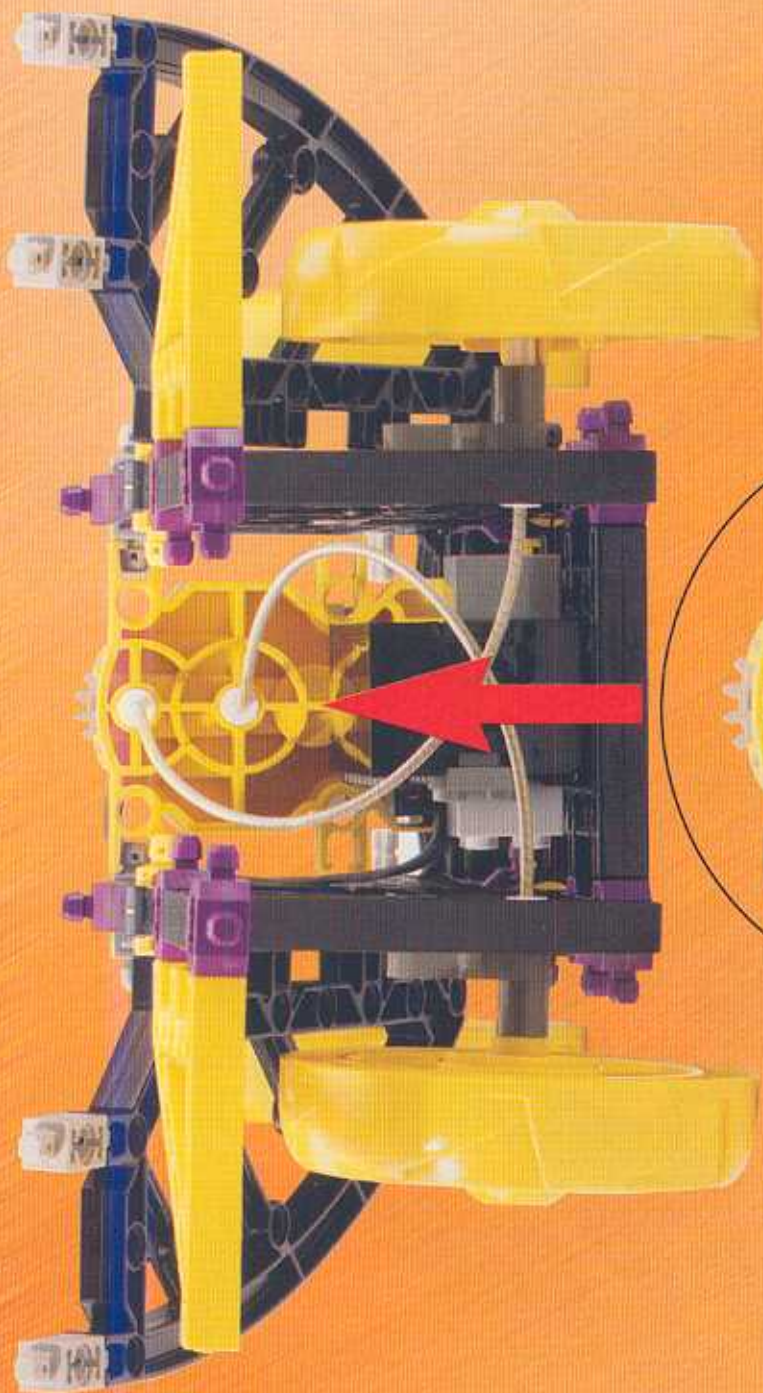



1

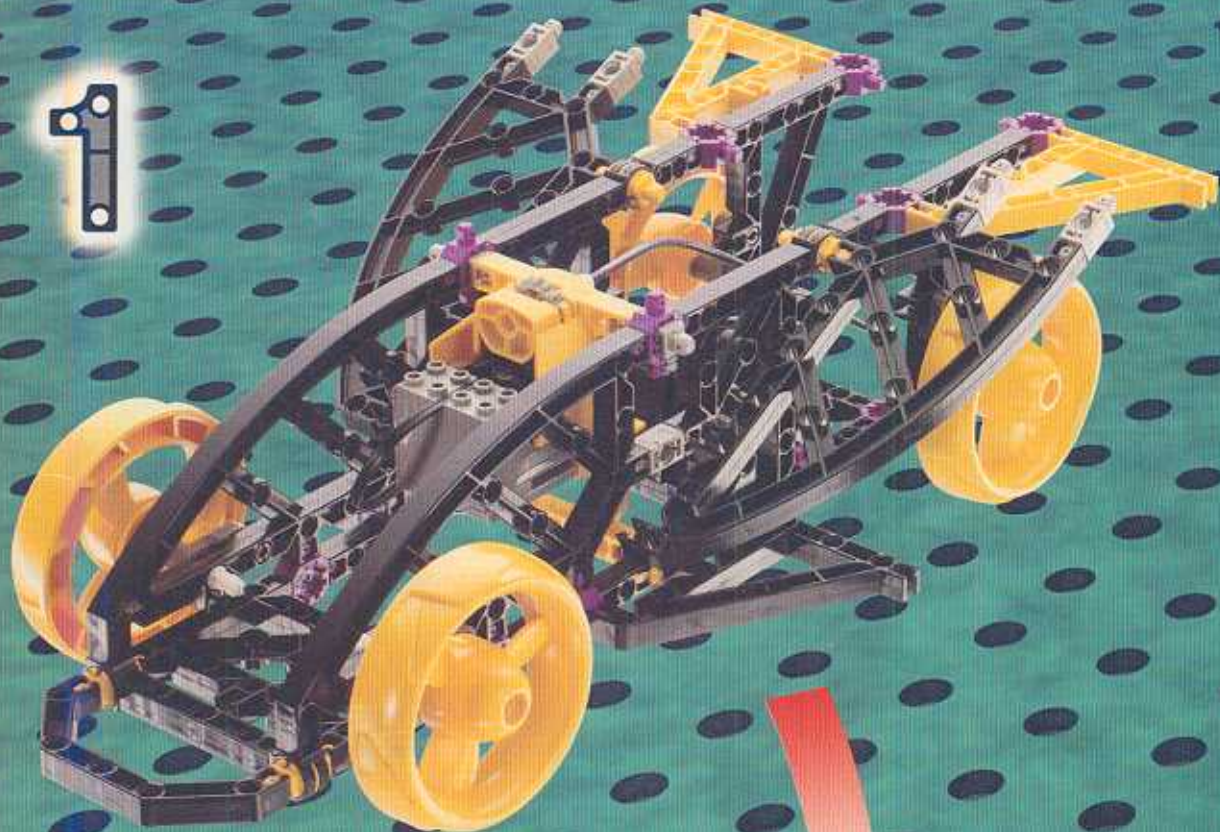

2



3

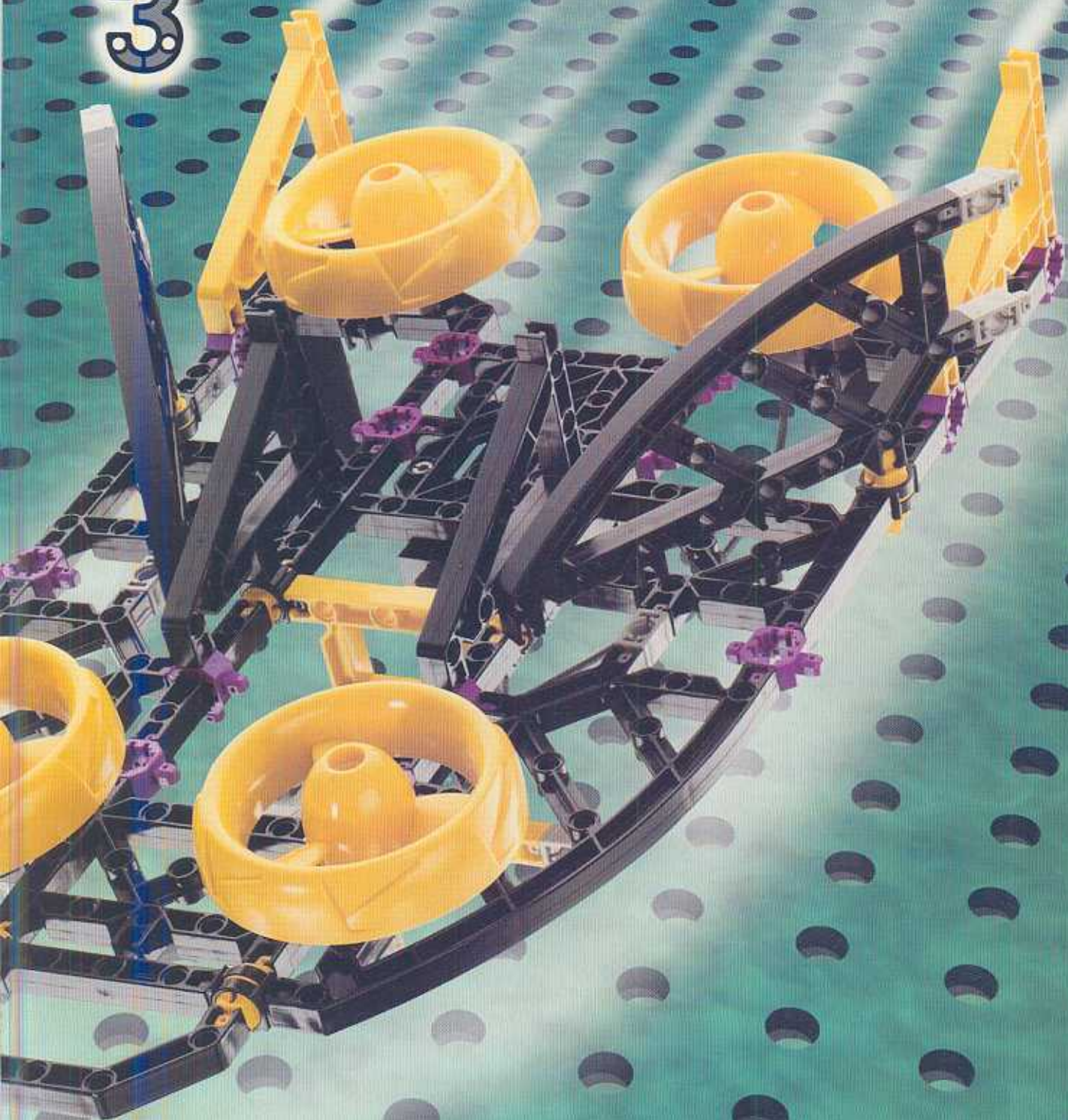

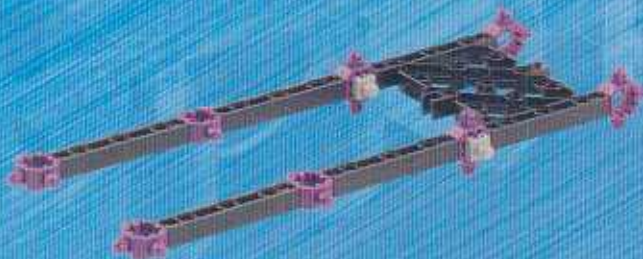
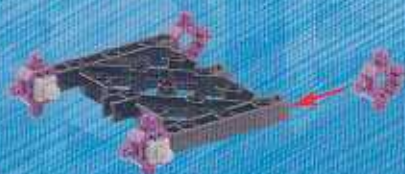

3

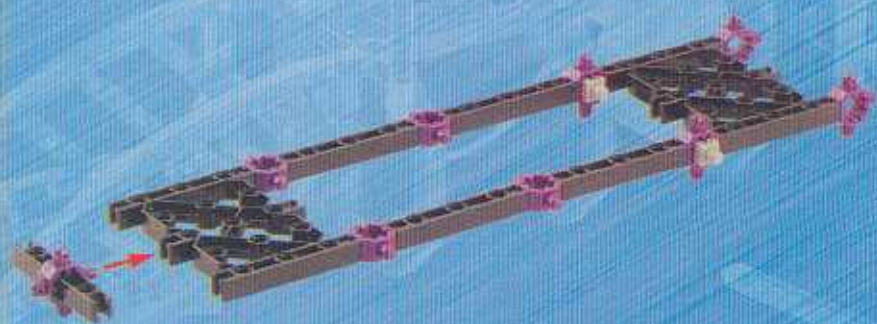

4

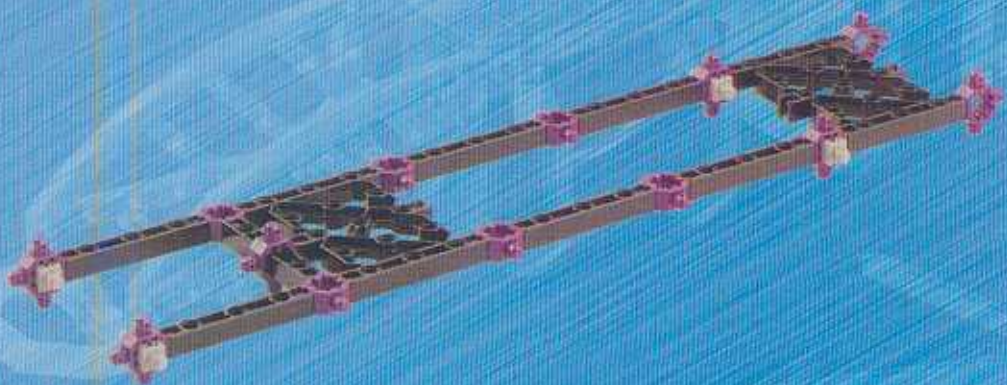

5

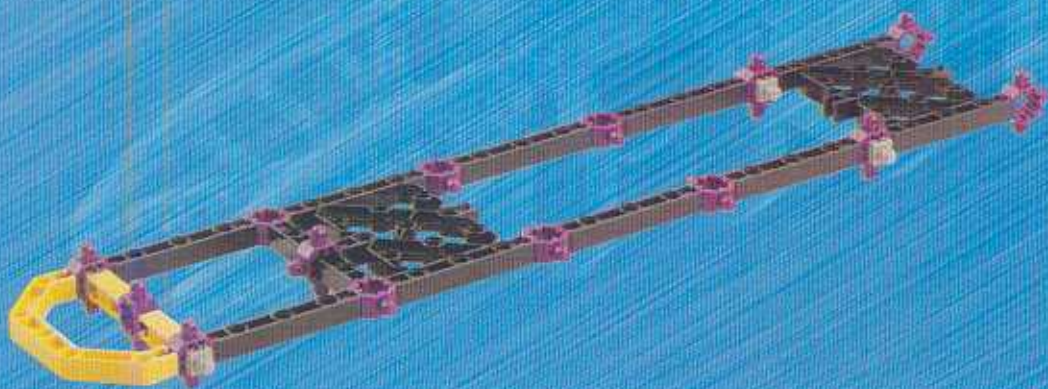

6

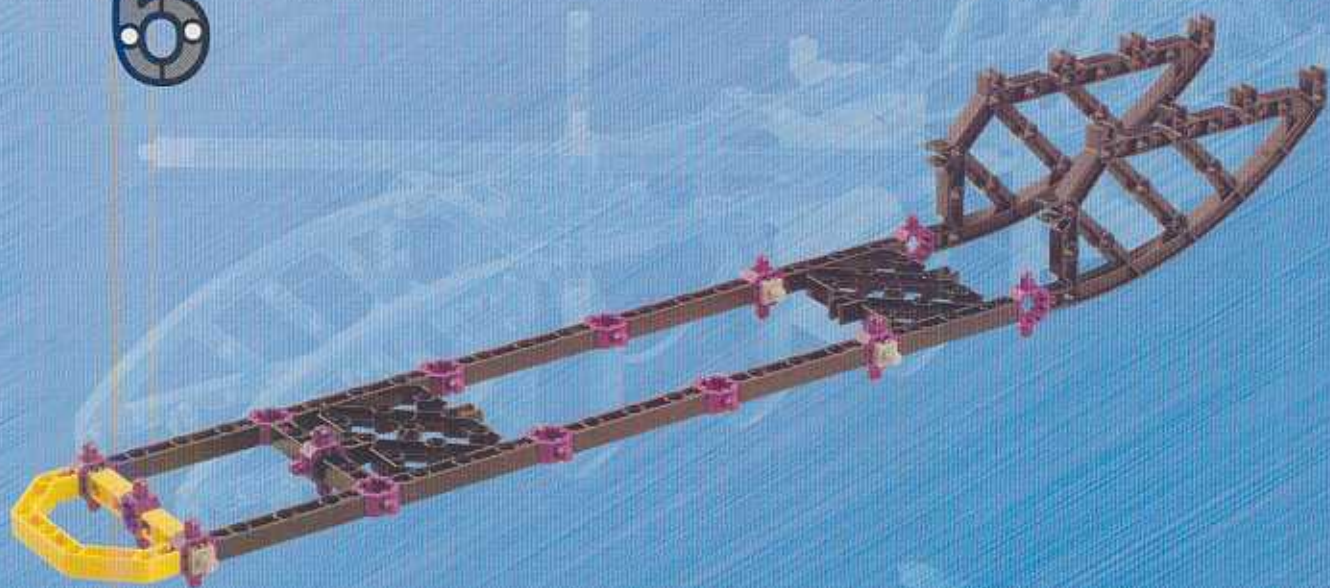

7

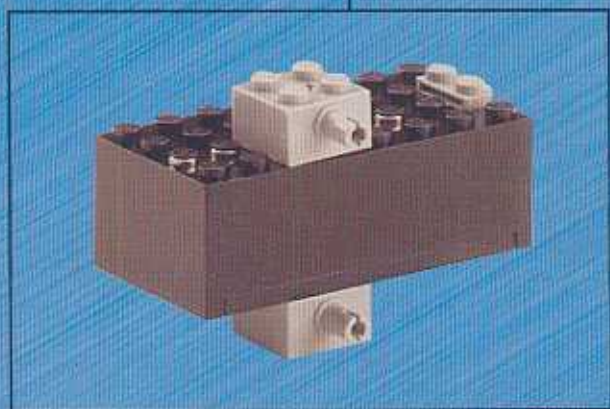
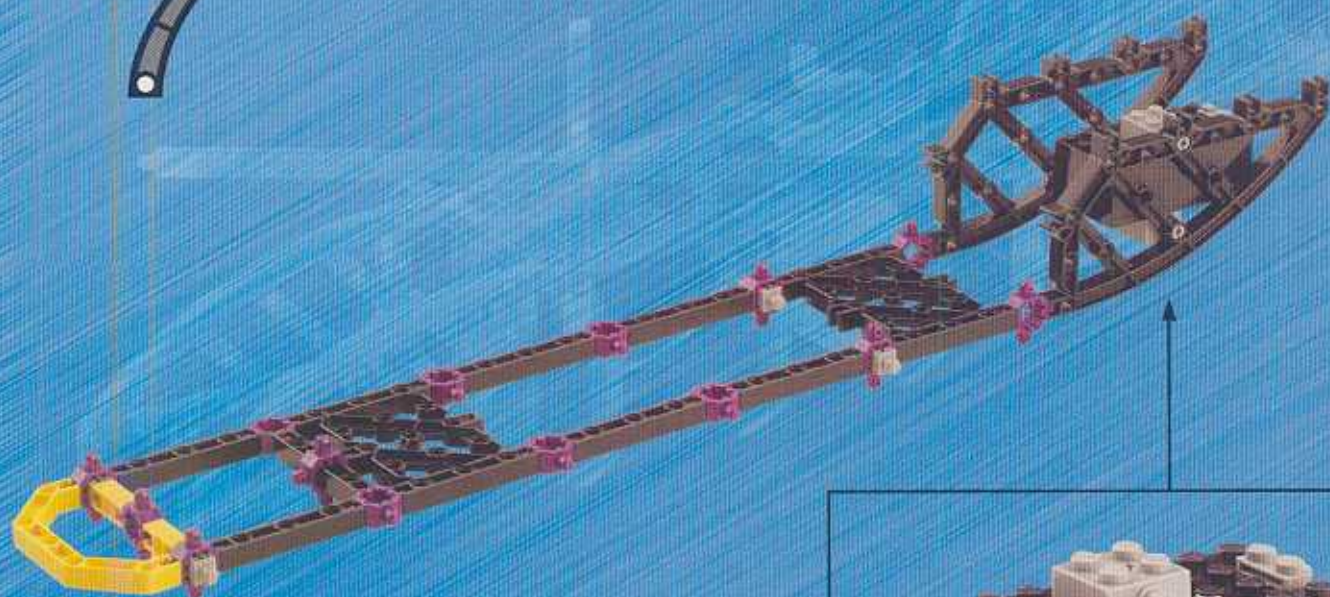

8



9



10



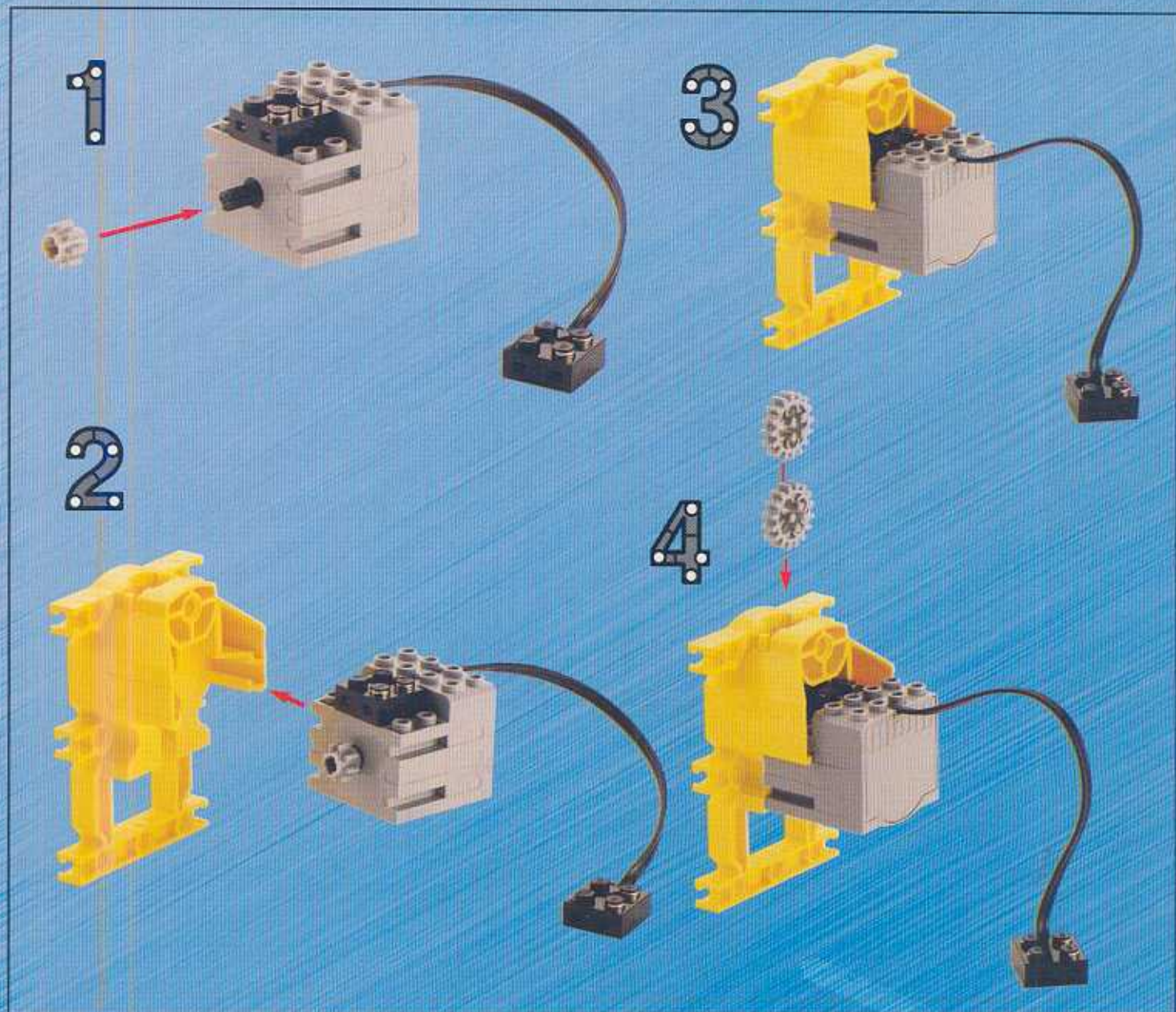

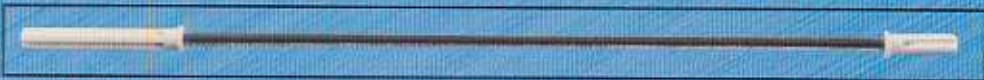

12



13



14



15

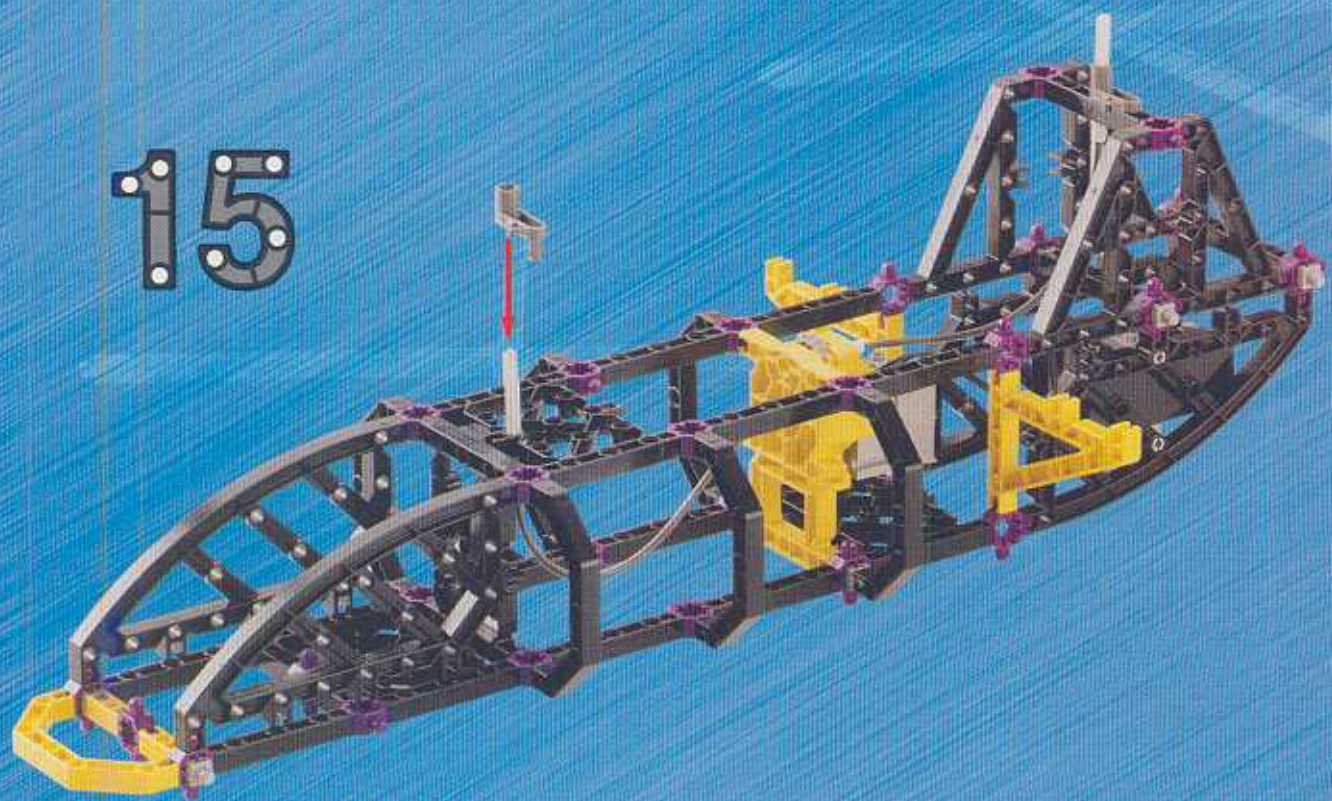

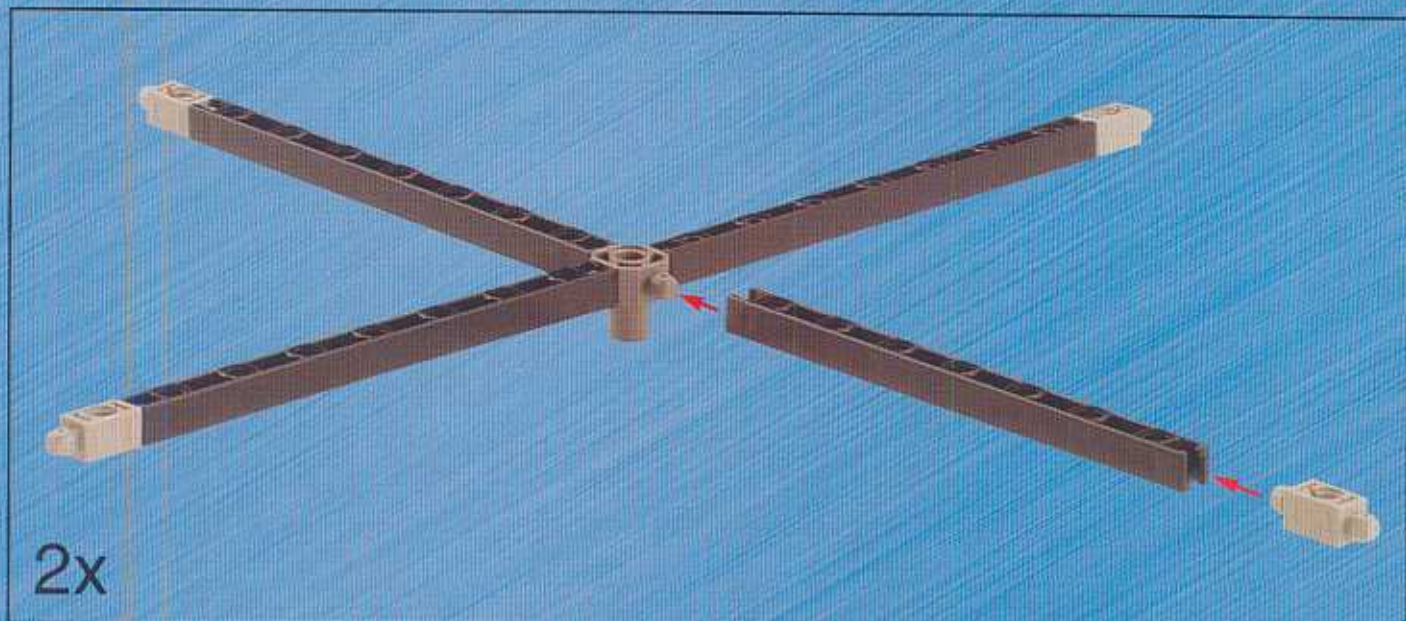

16

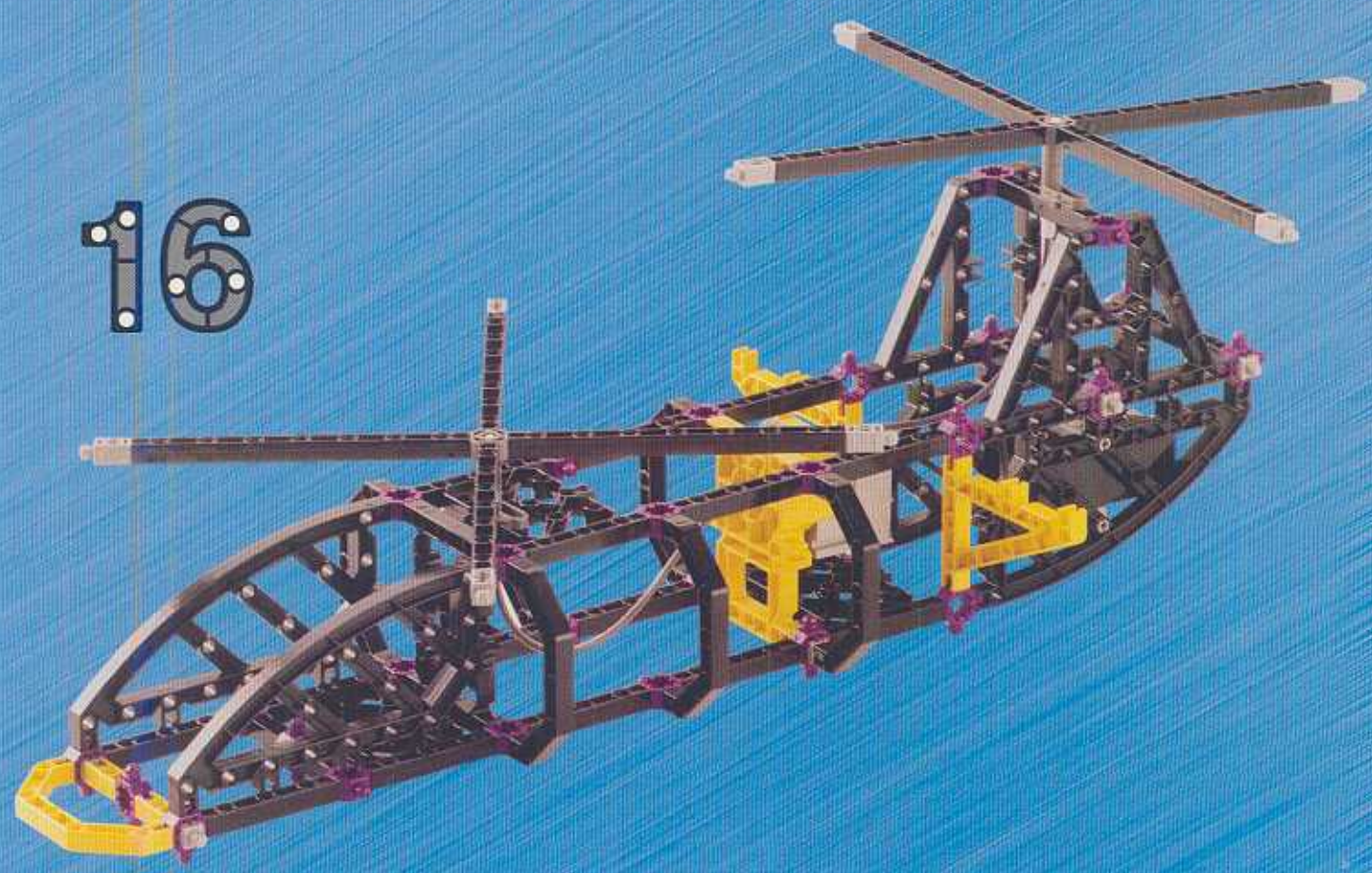

17

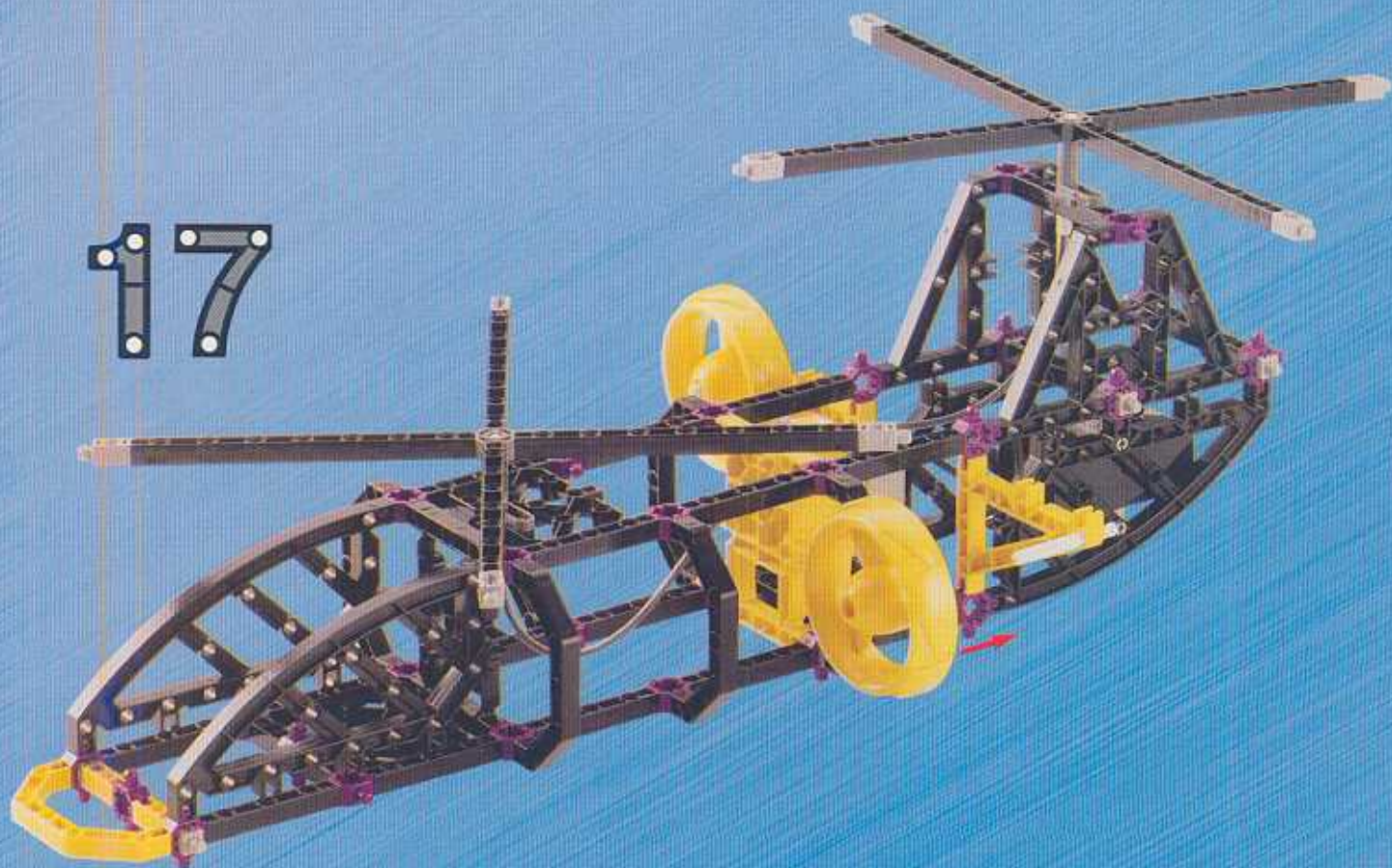

18

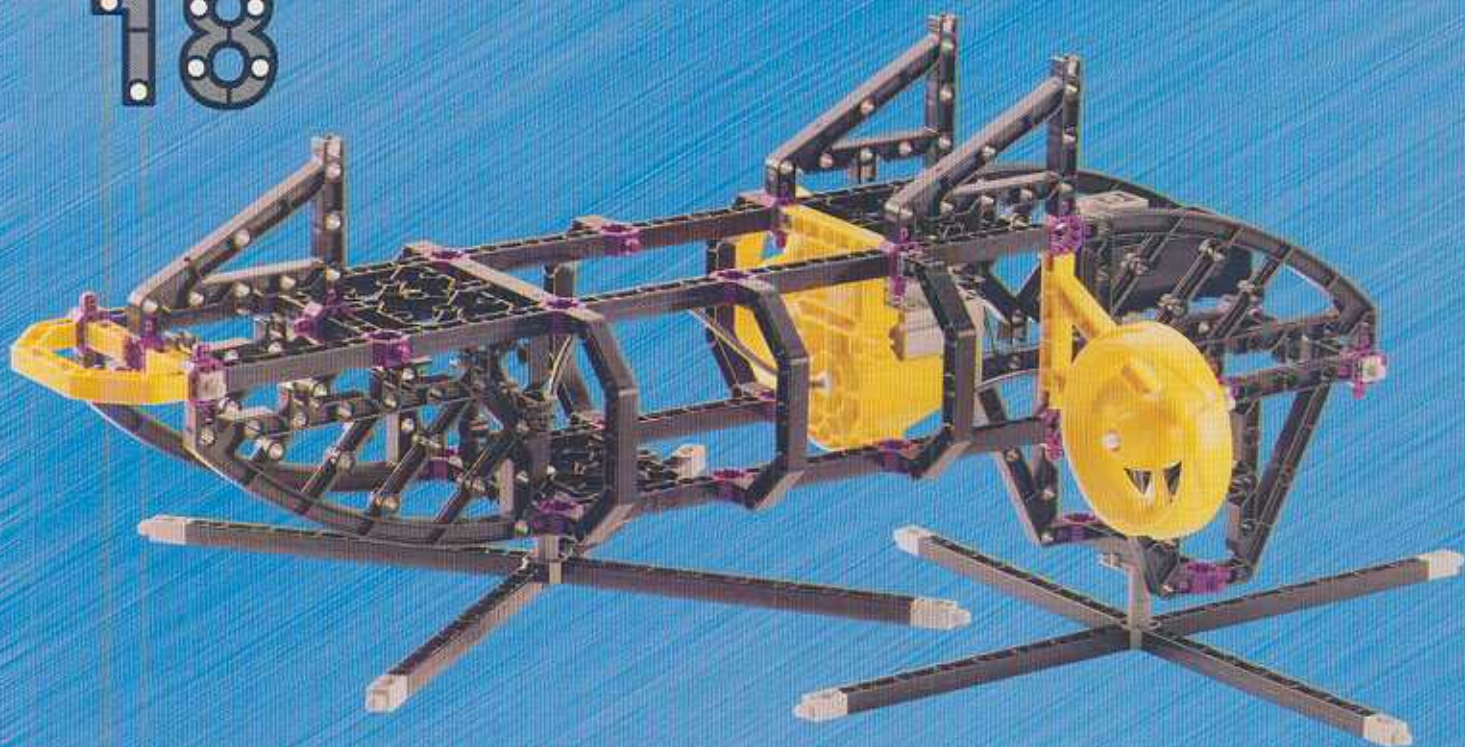

19

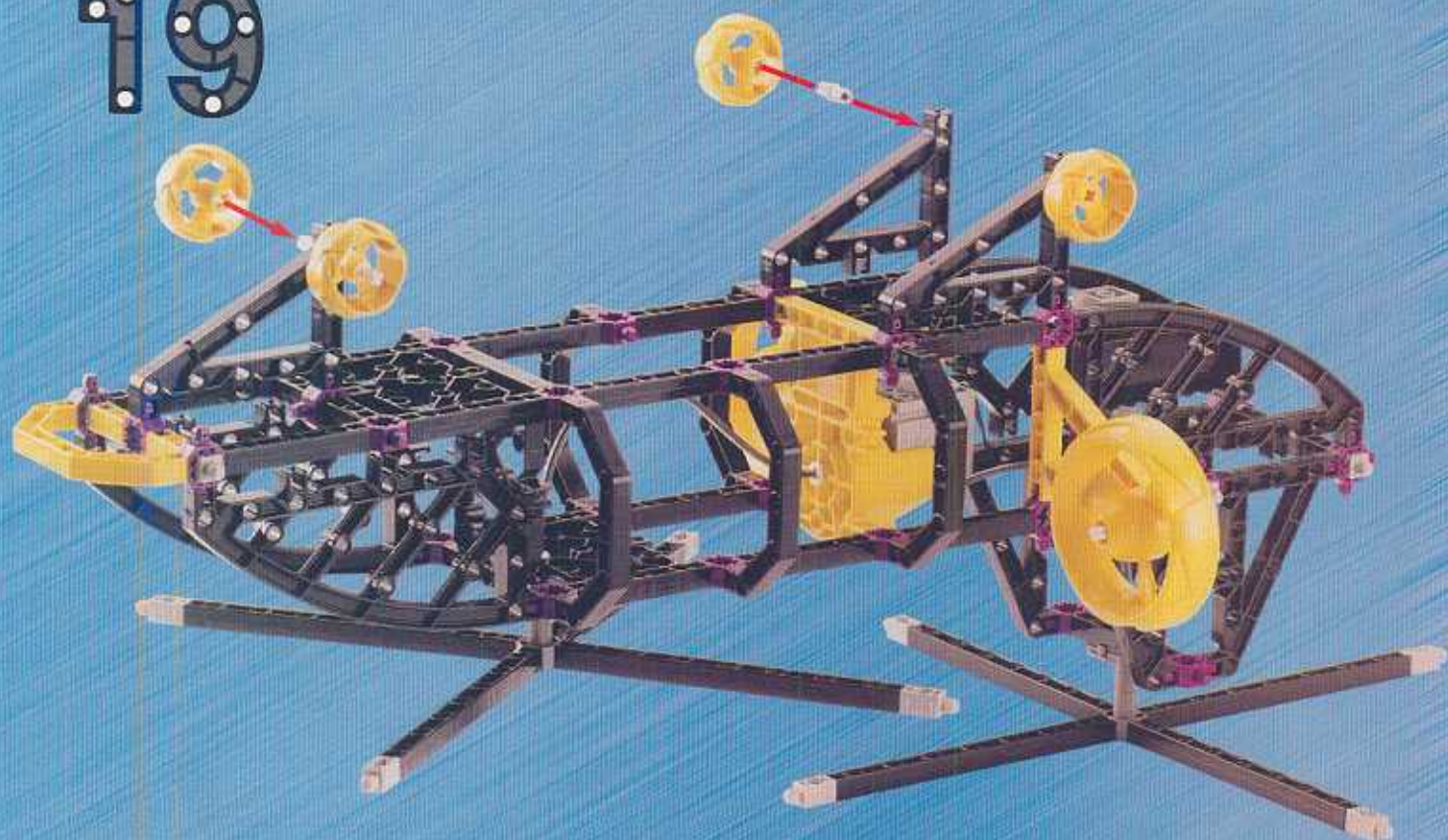

20



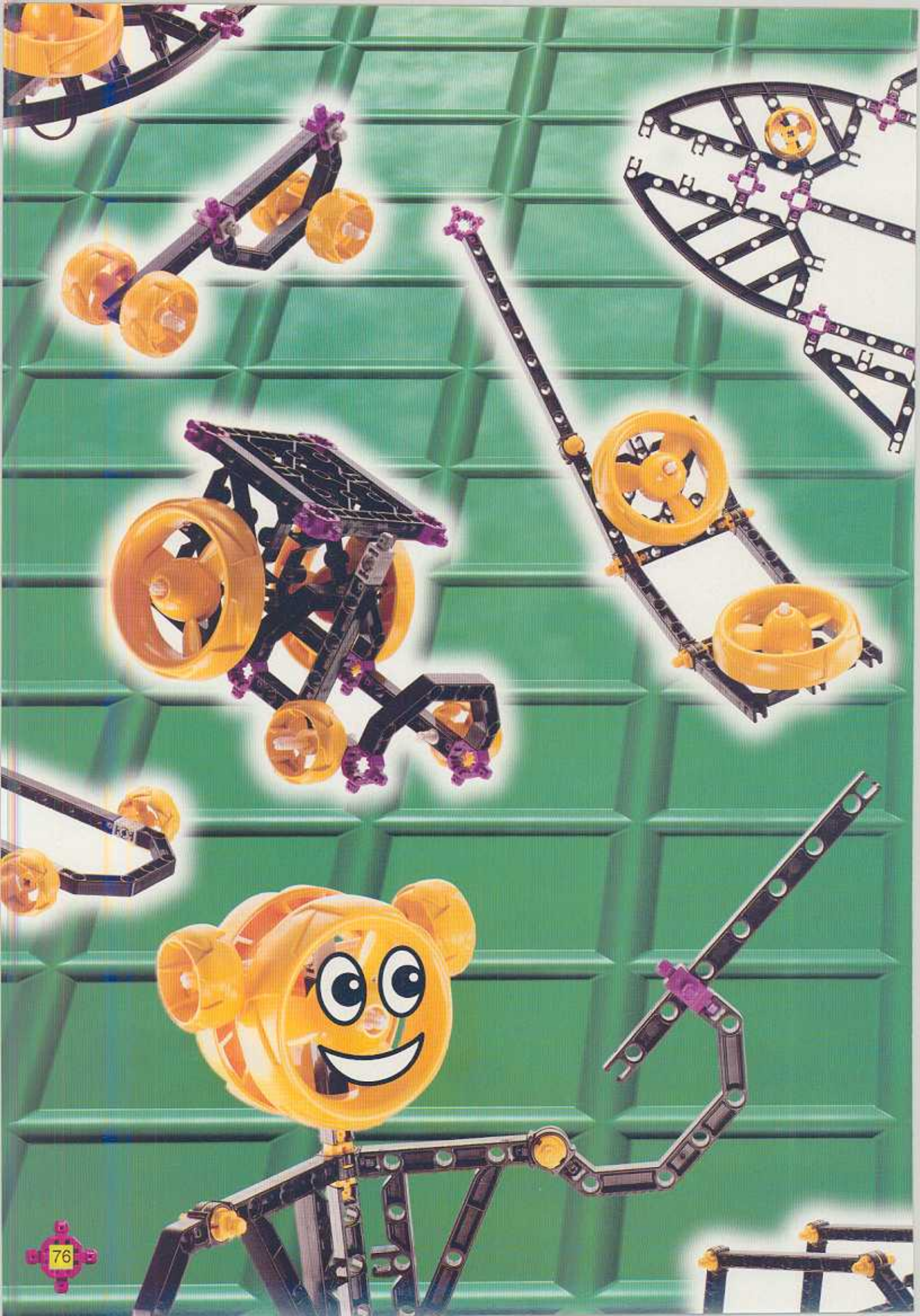



1

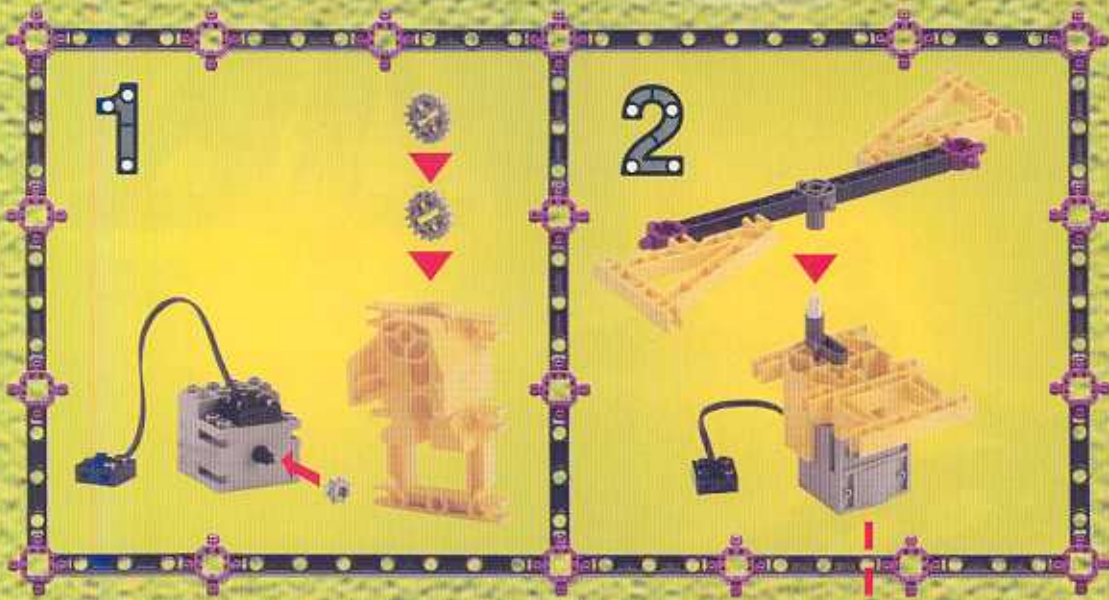
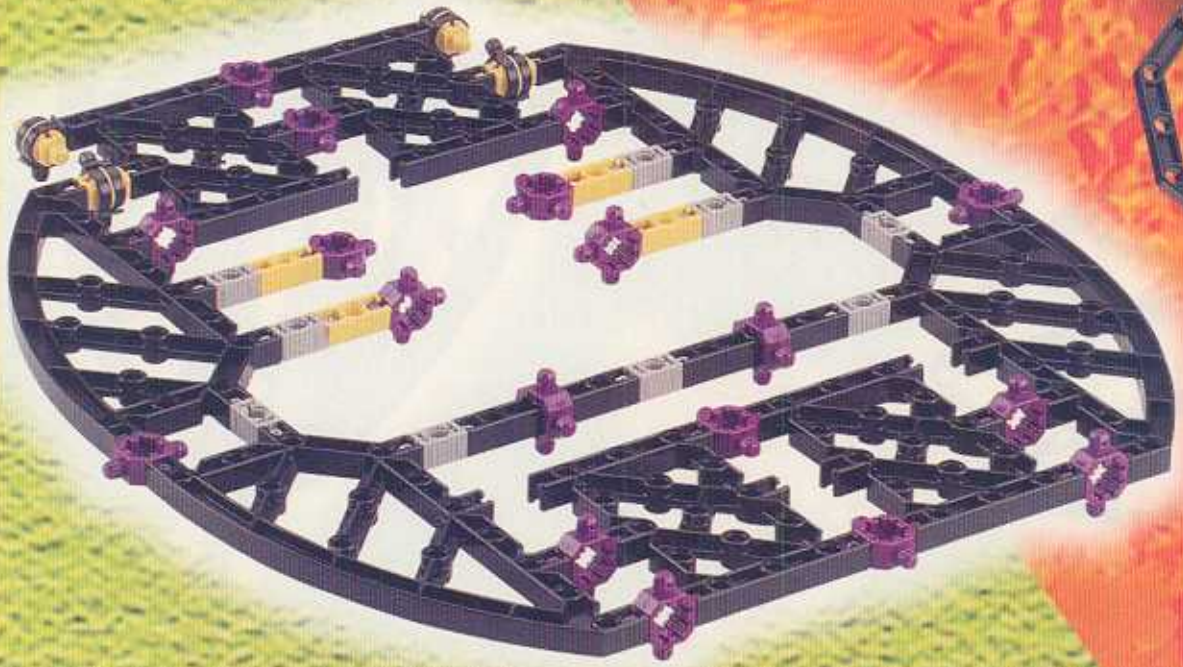

2

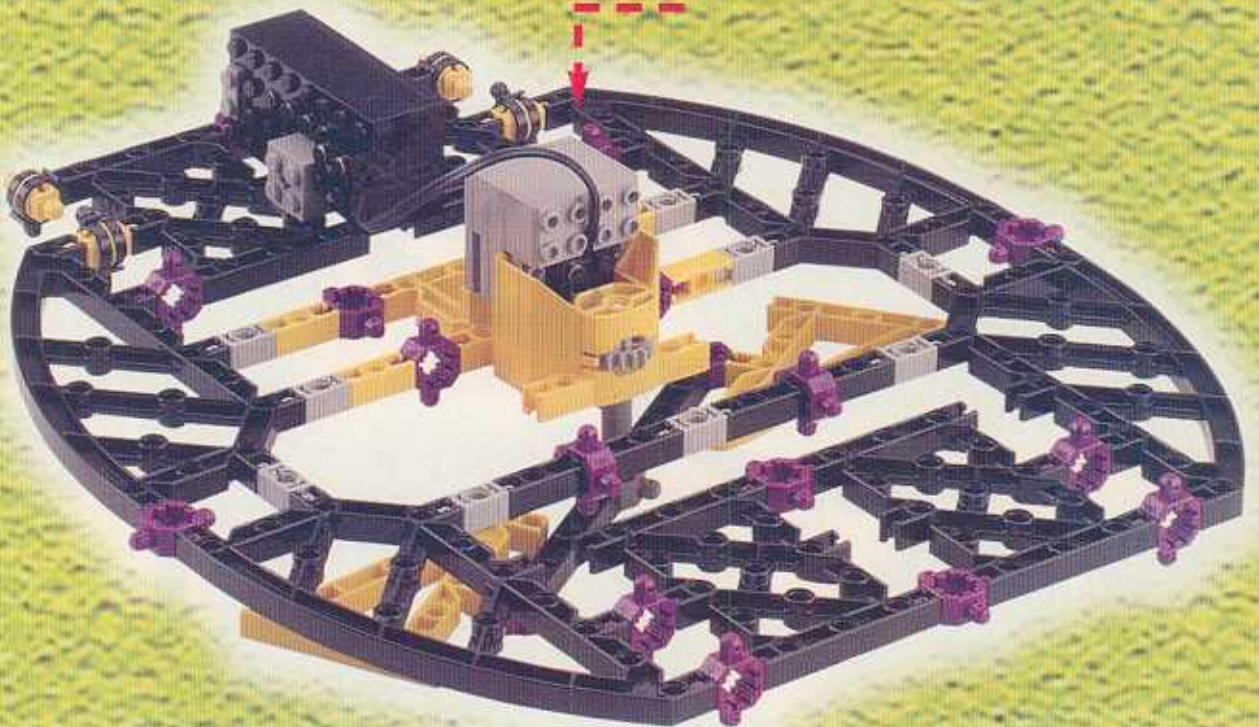



3

1



2



3



4





3552



3501



3502



3503



3504

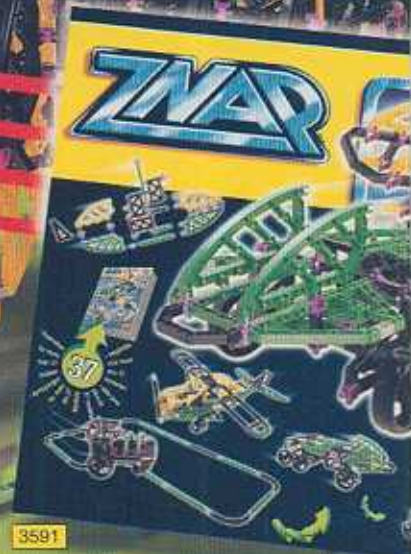

3591





3581

3571

3571

3551

3532

3531

3582

LEGO

4124604

® LEGO is a registered trademark

© 1998 LEGO Group.

<http://www.LEGO.com>

