



# SPORTS

3430



4224100











3428



3429



3433

3560



3561



3562



3563



3564



3565



3566



3567





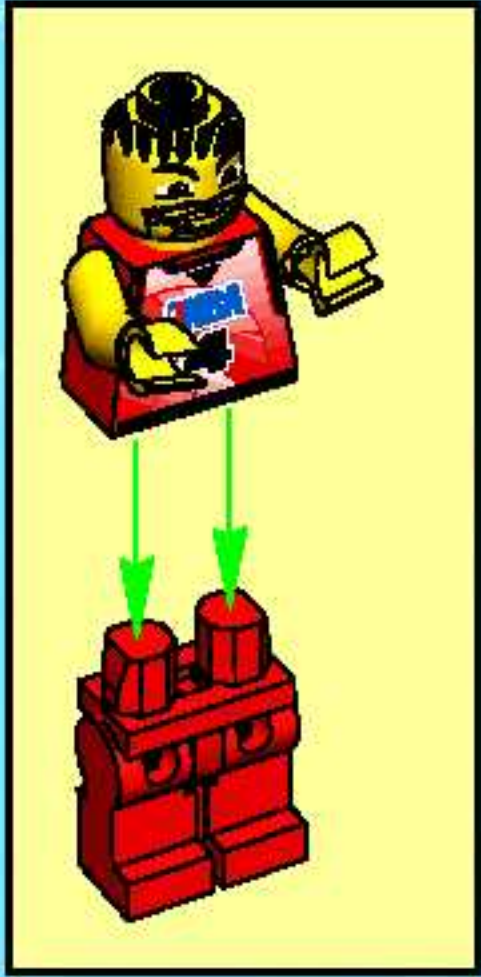







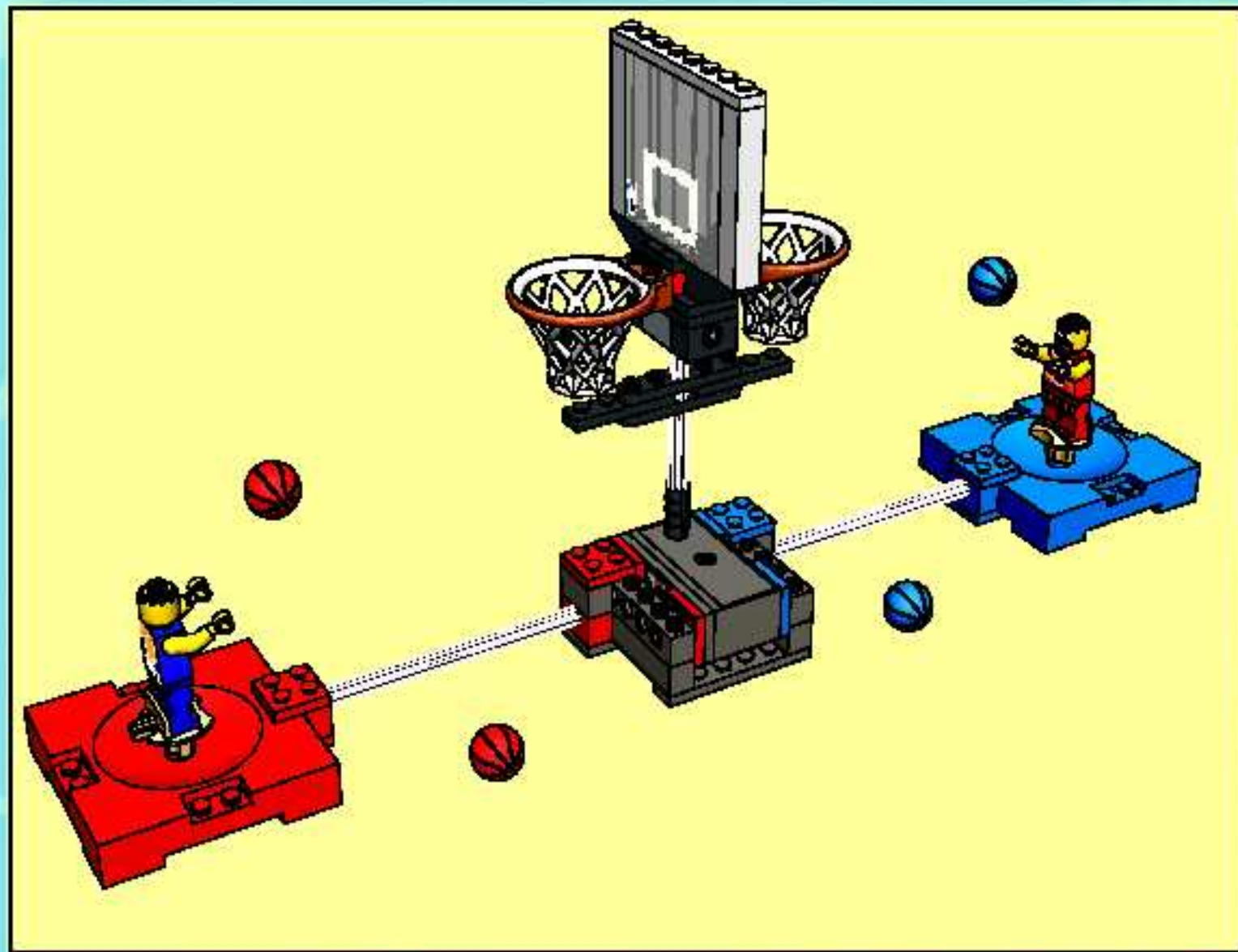

1



2

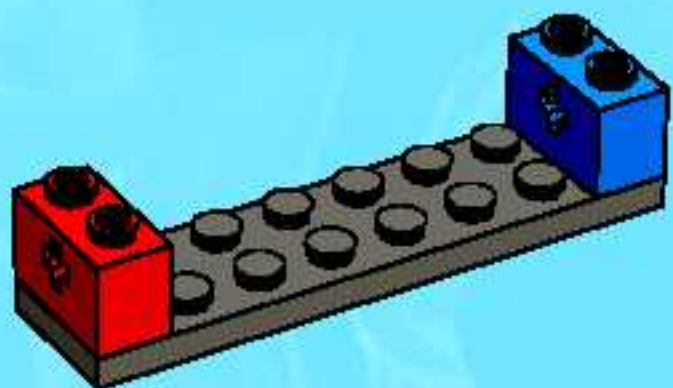

3

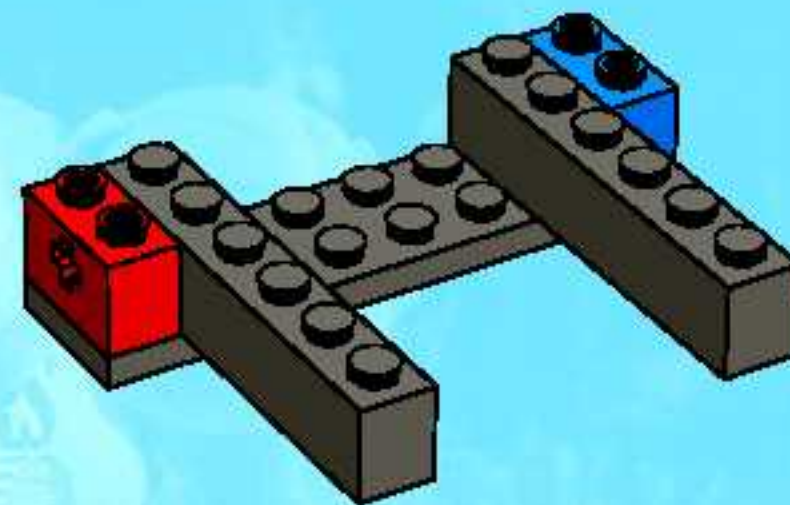

4

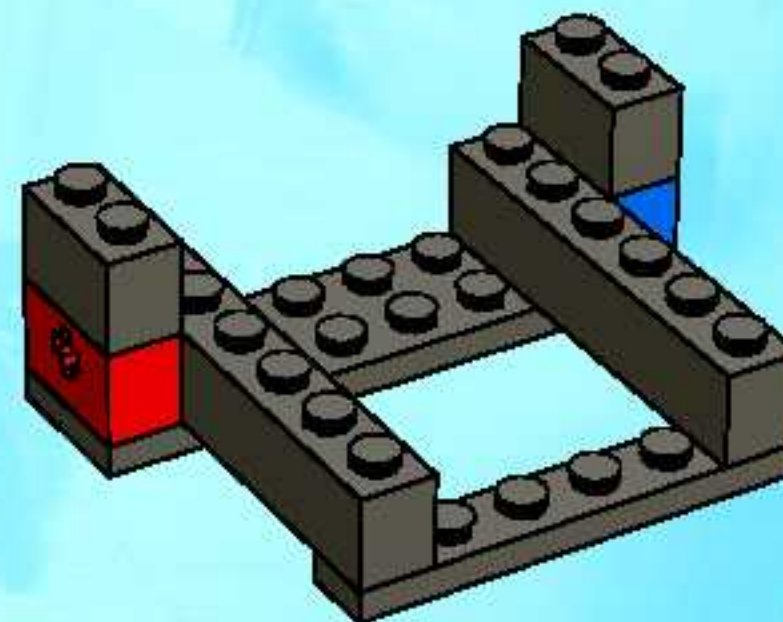



1

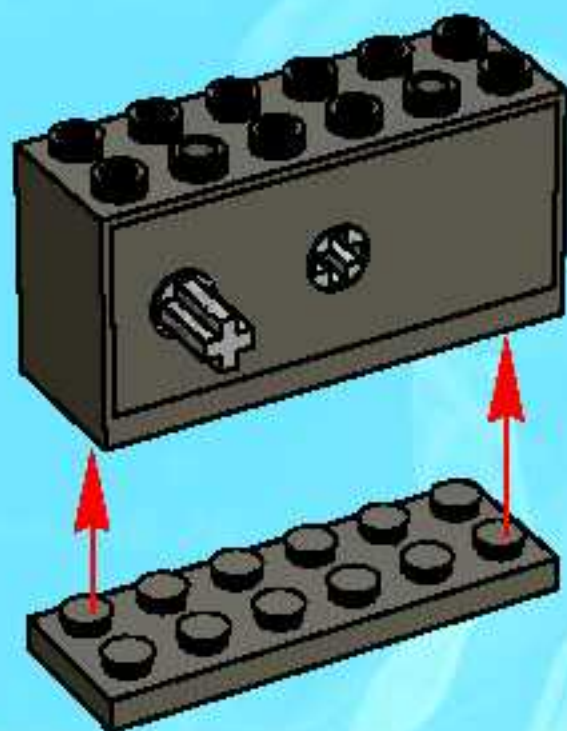

2

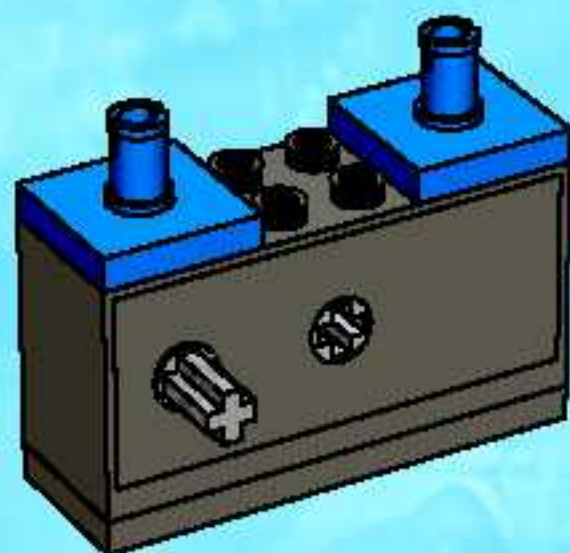

3

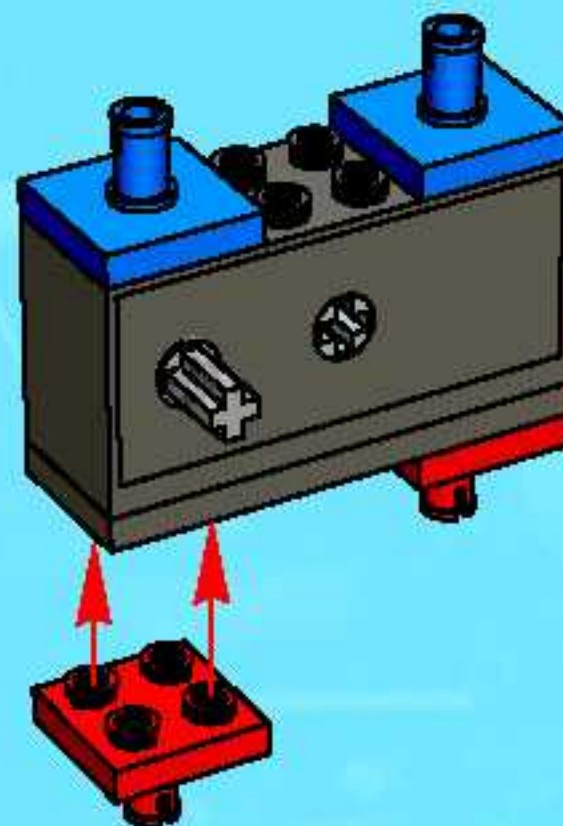

4

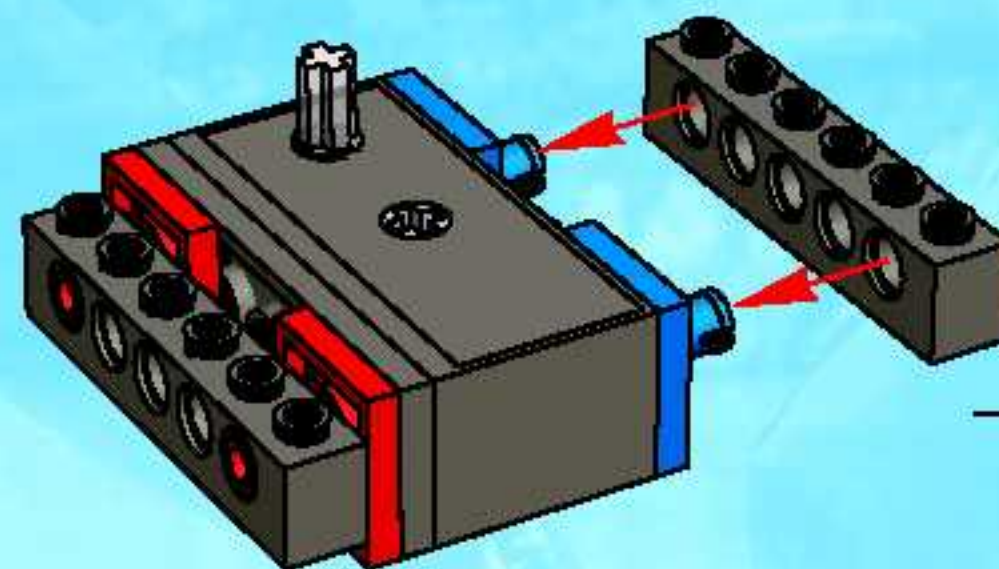

5

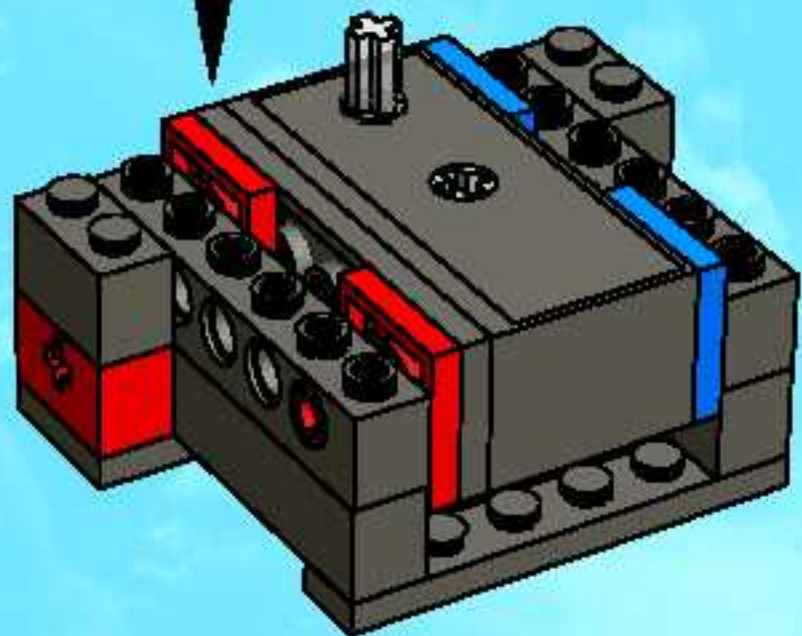

6

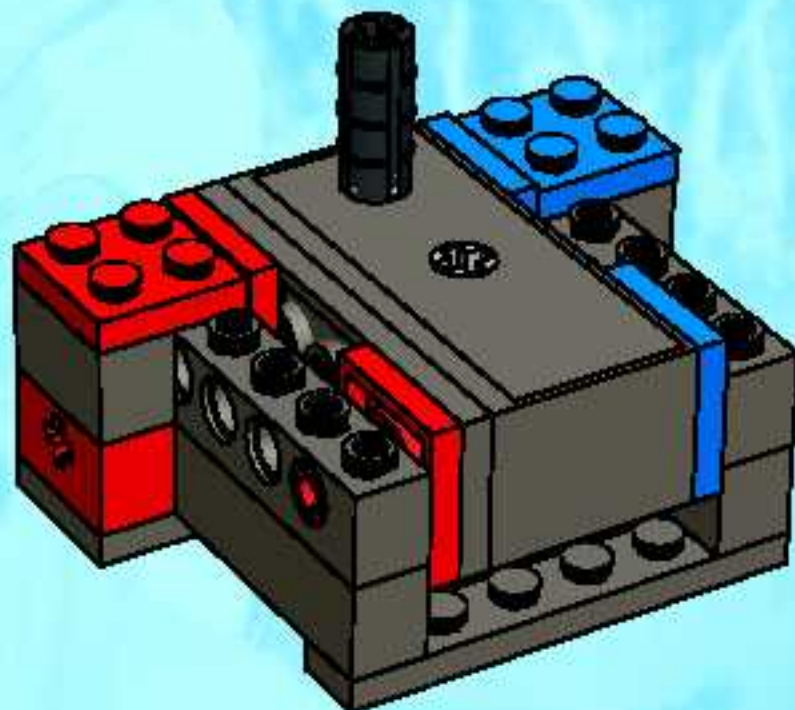



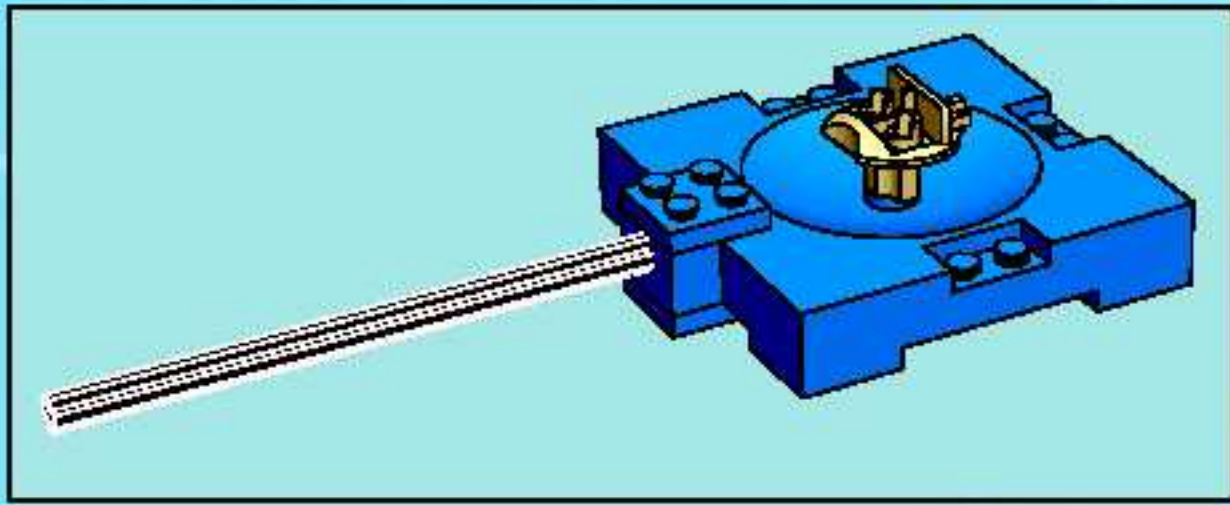

1

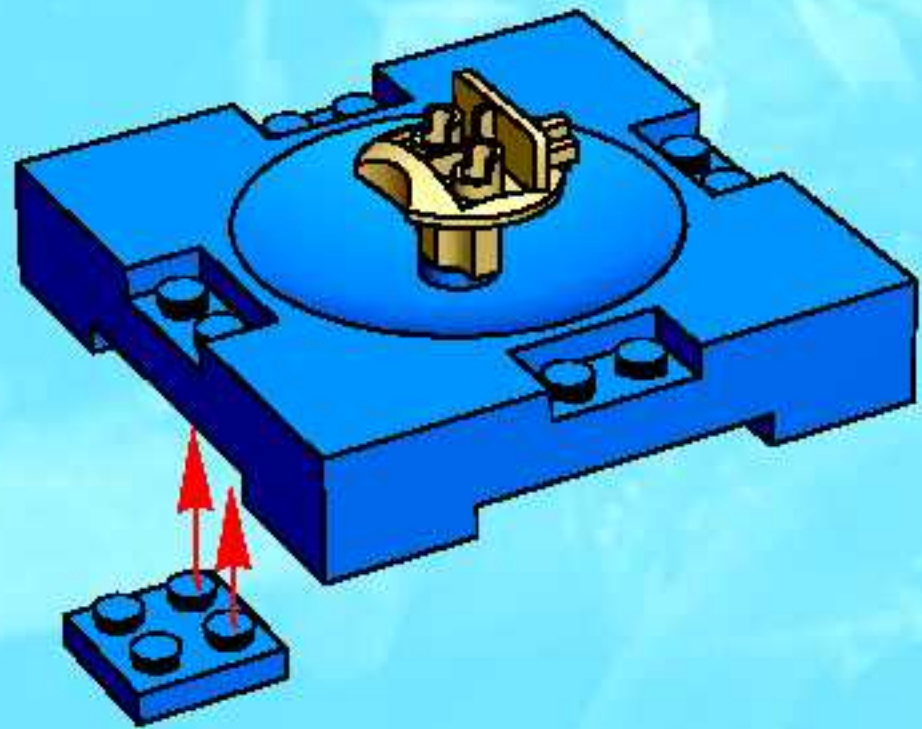

2



3

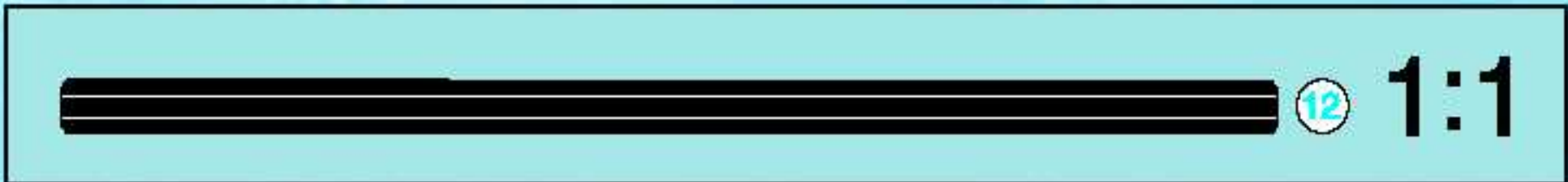
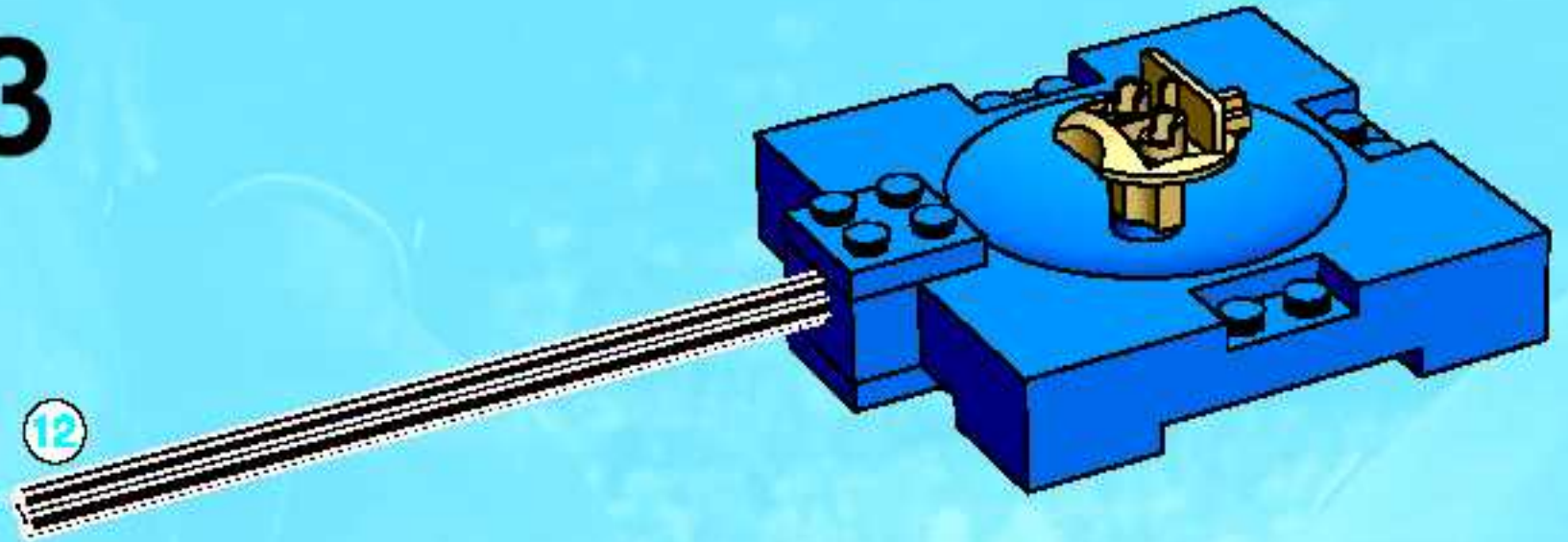



7

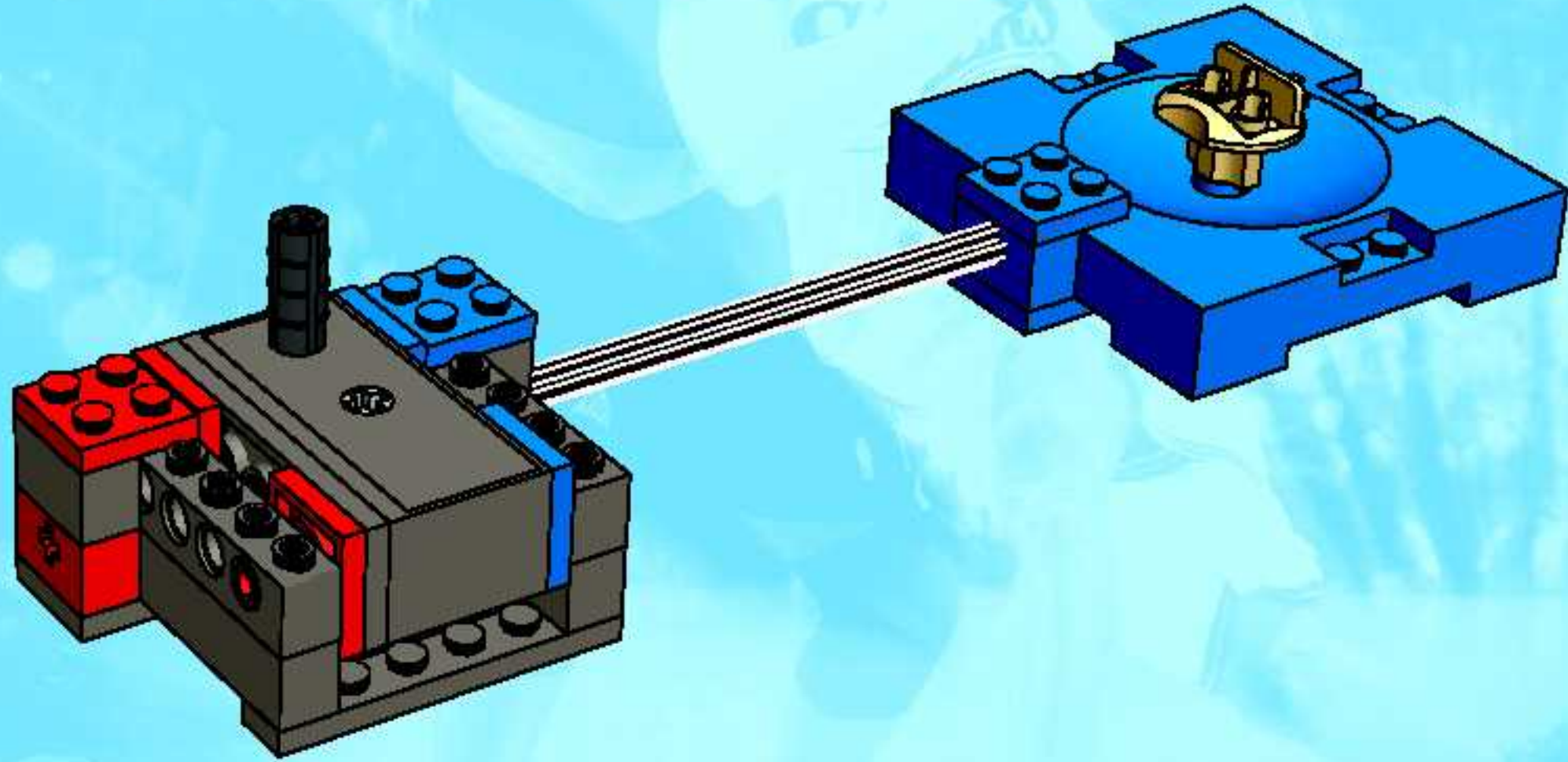



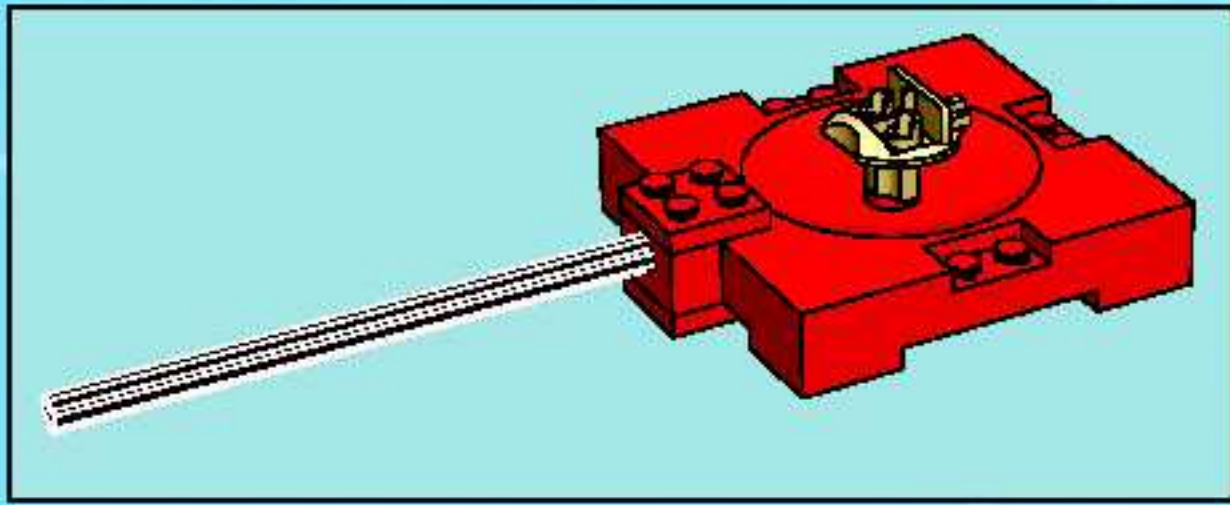

1

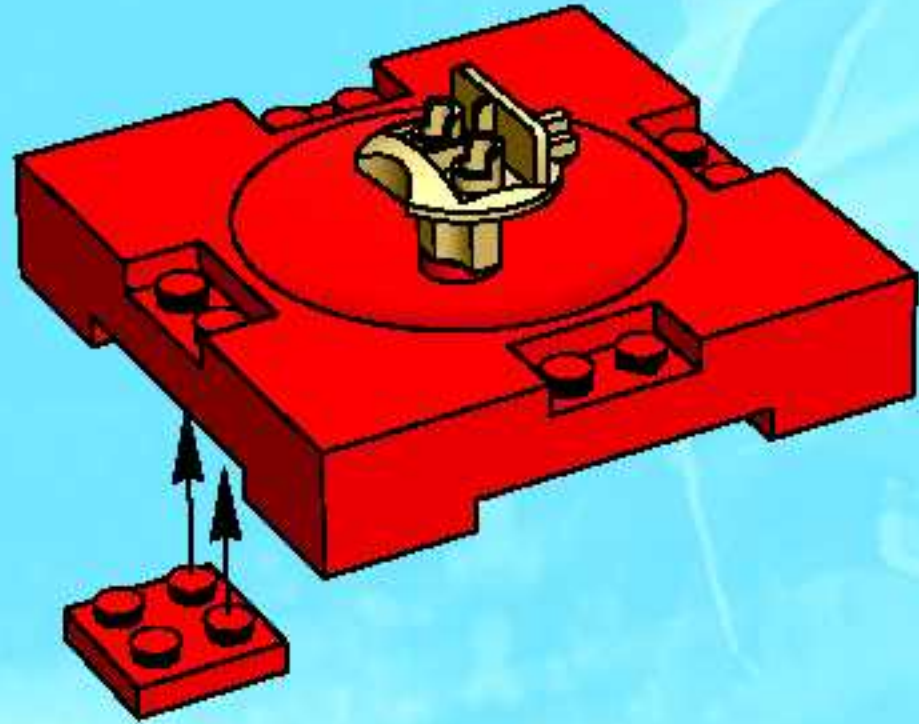

2



3

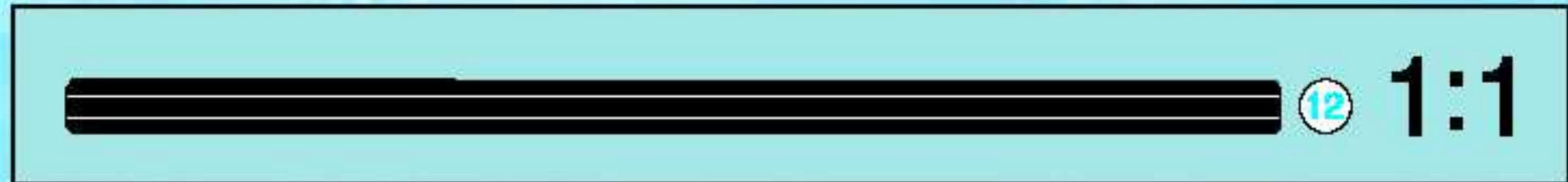
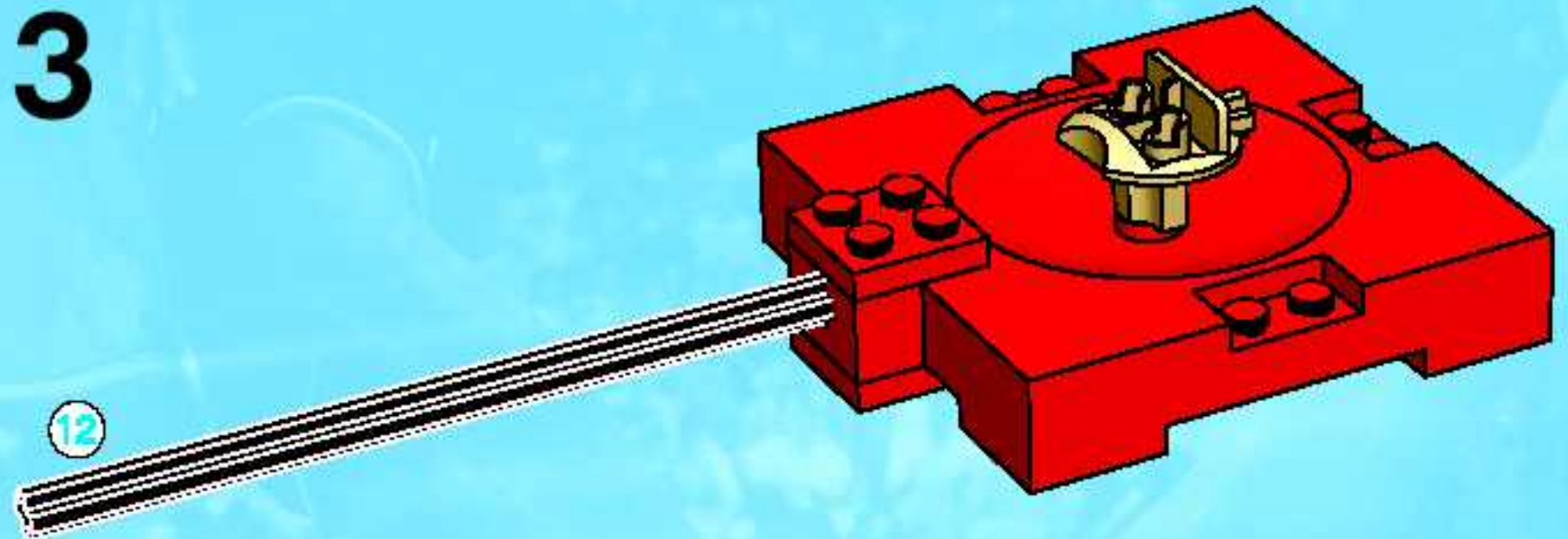



8

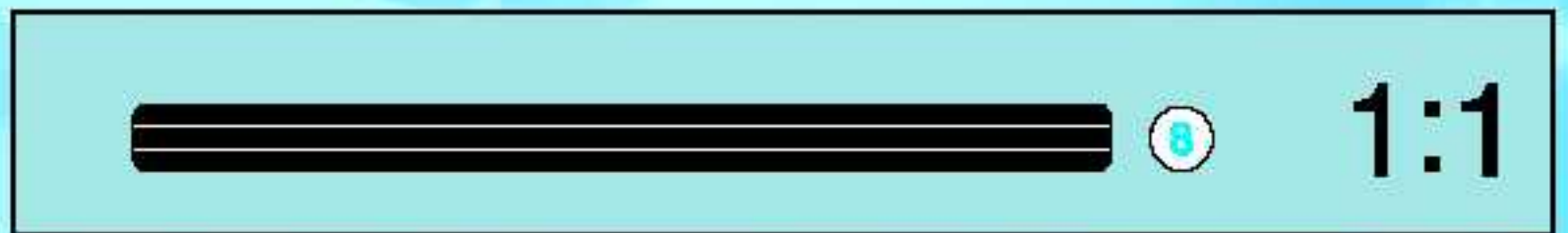
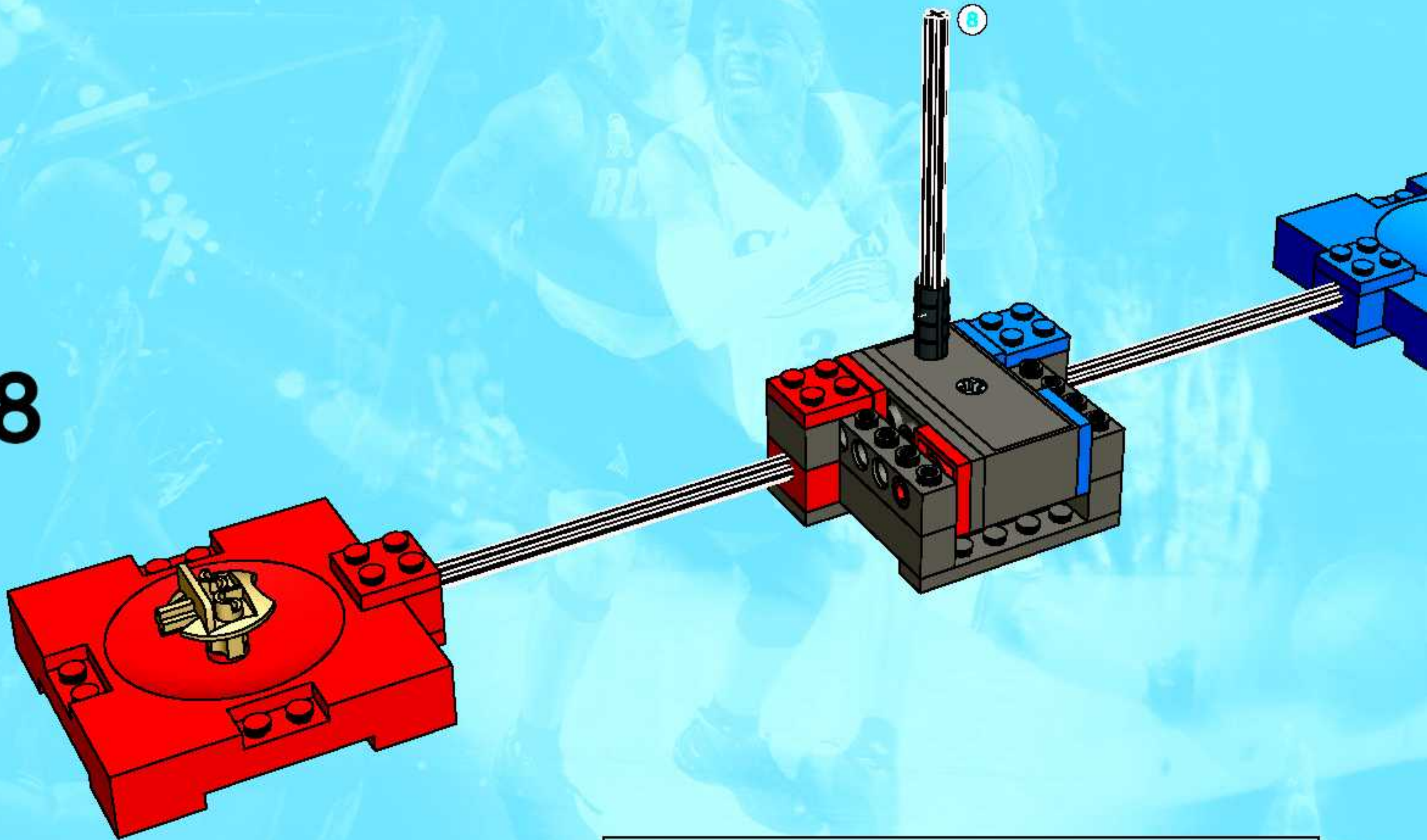



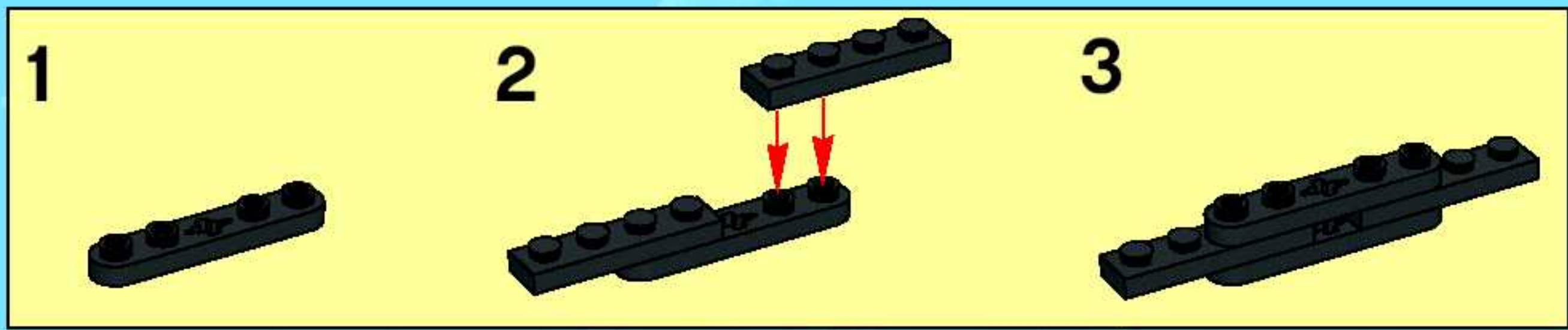

9

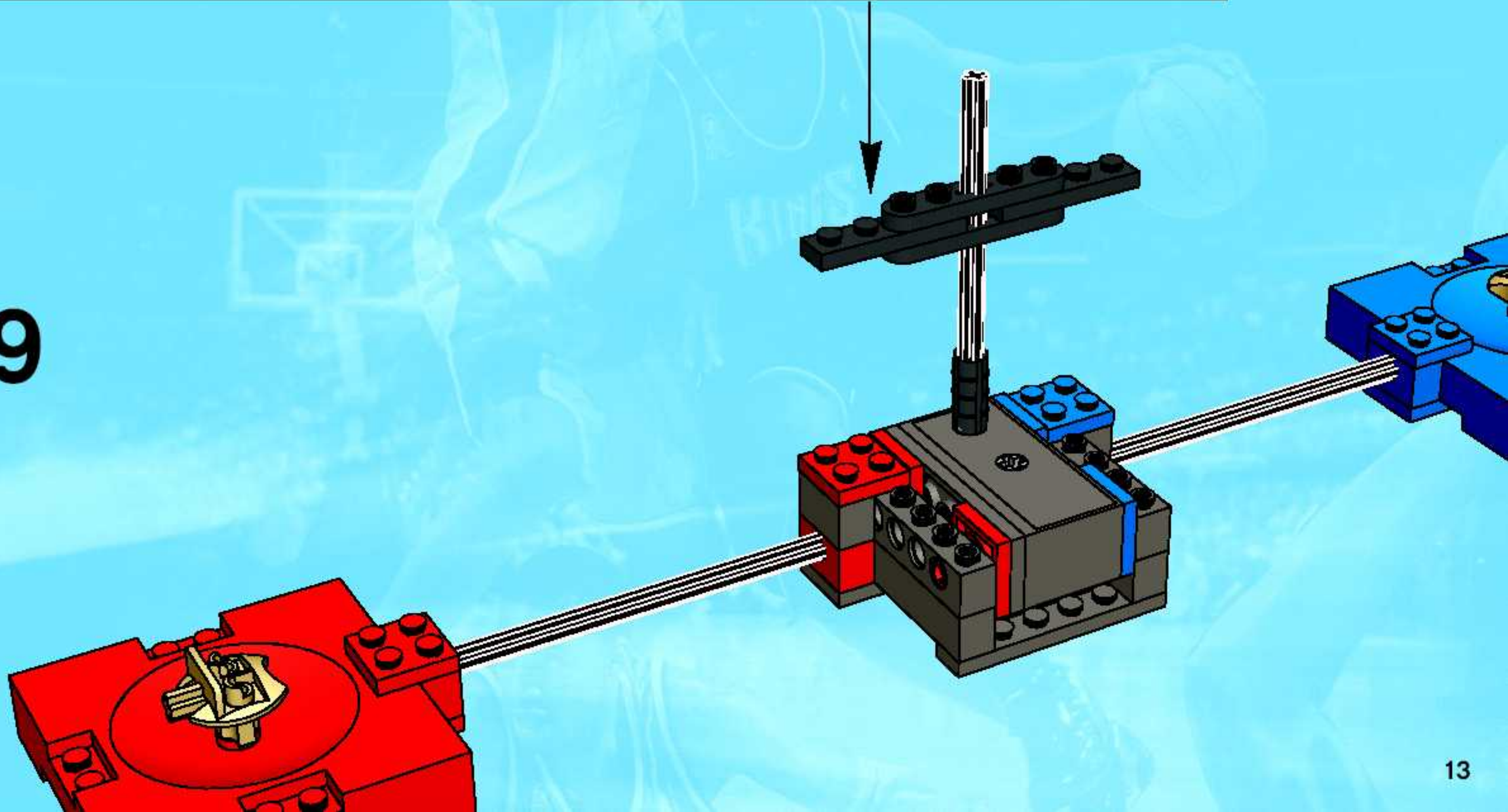



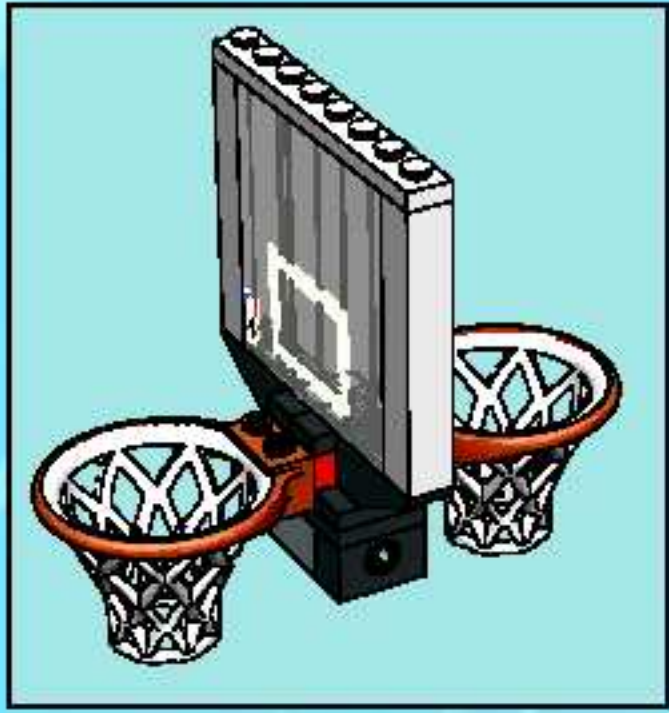

1

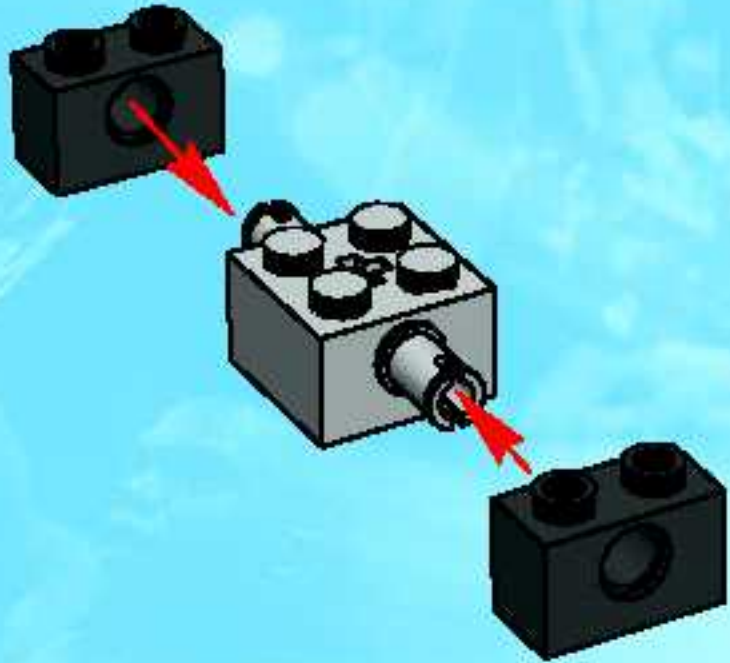

2



3

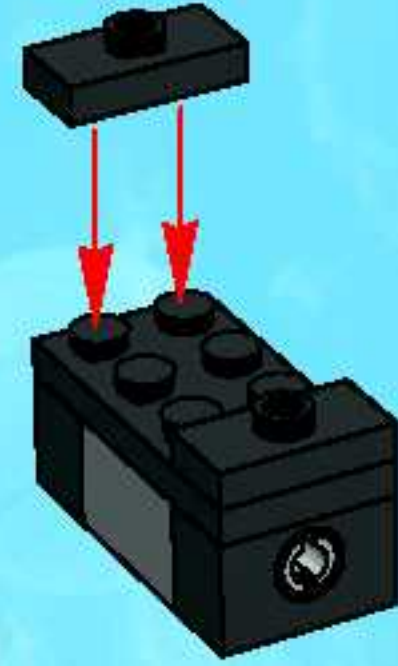

4



5

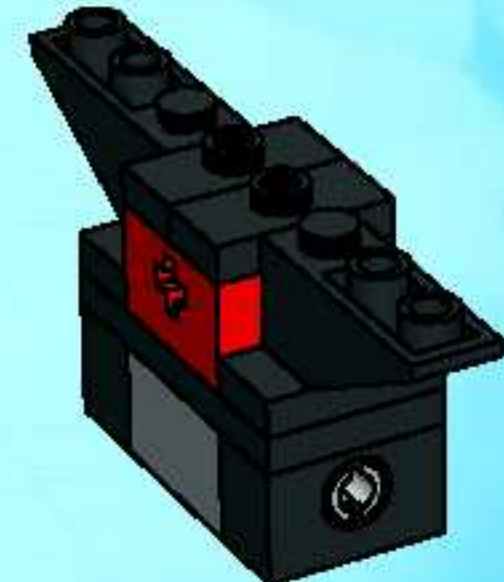



6

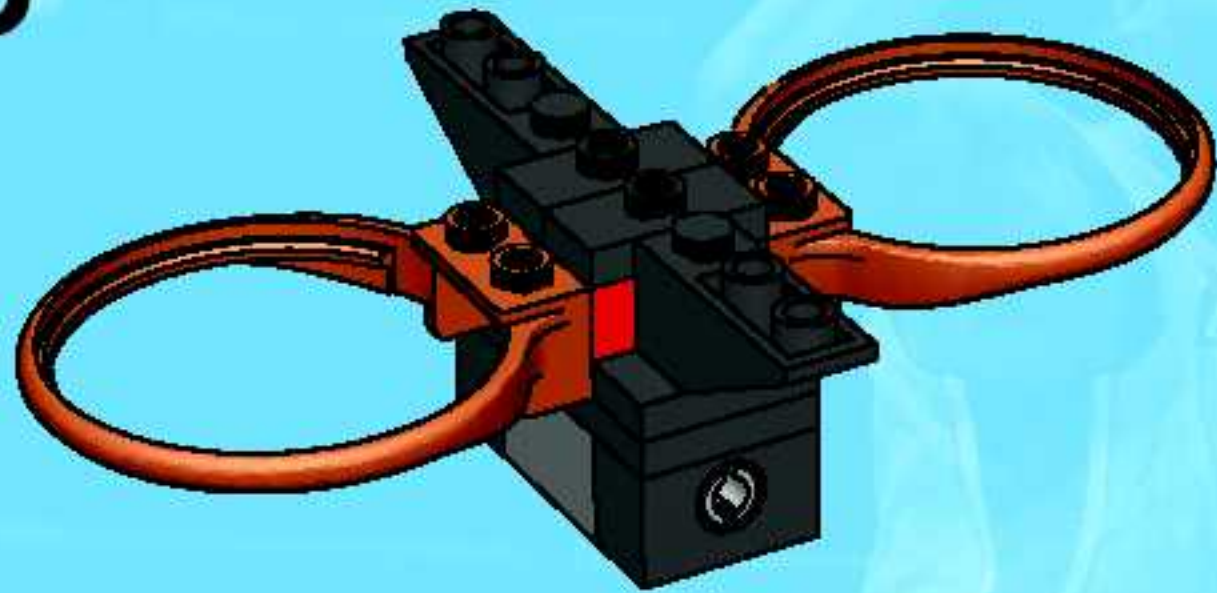

7

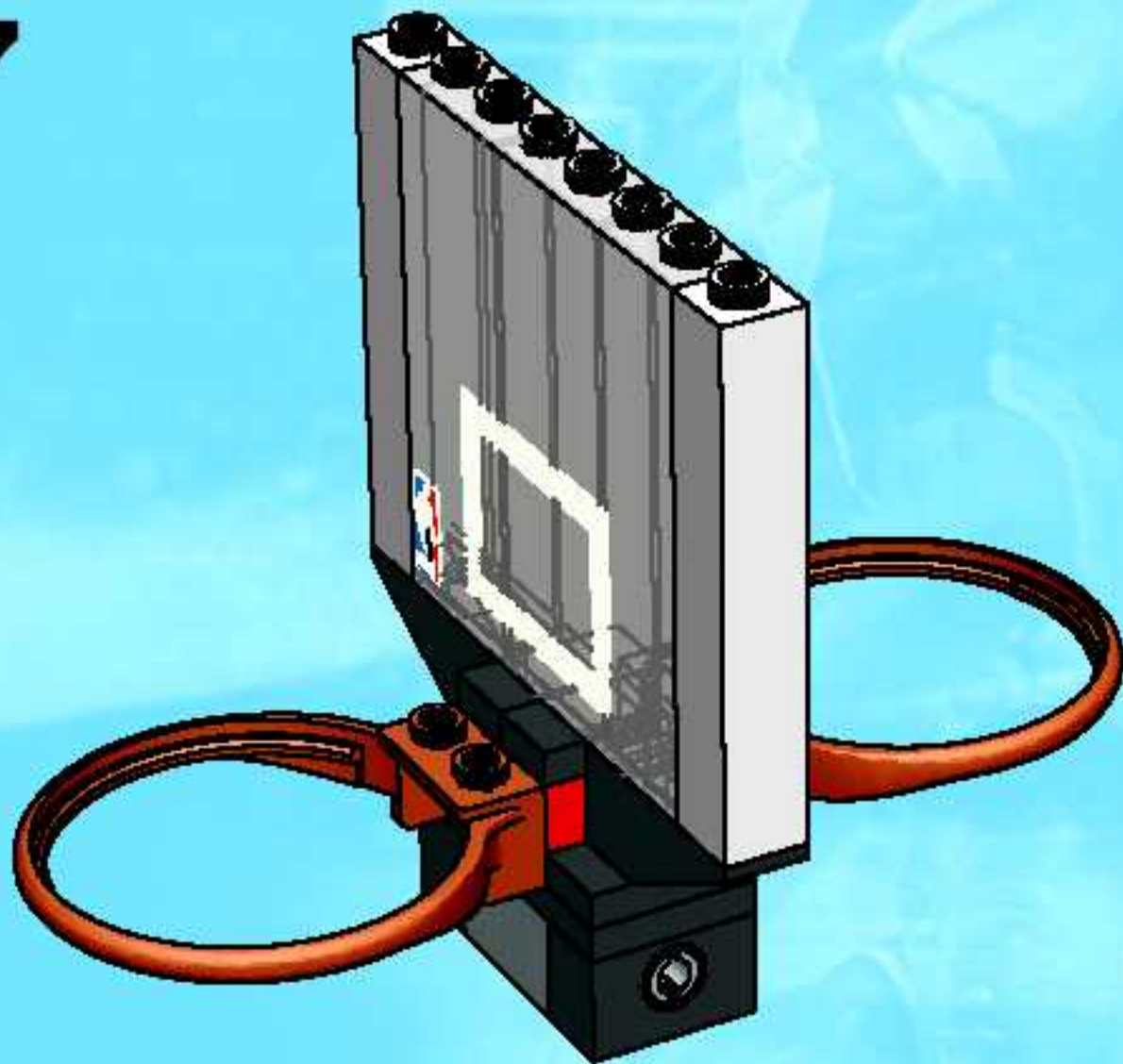

8

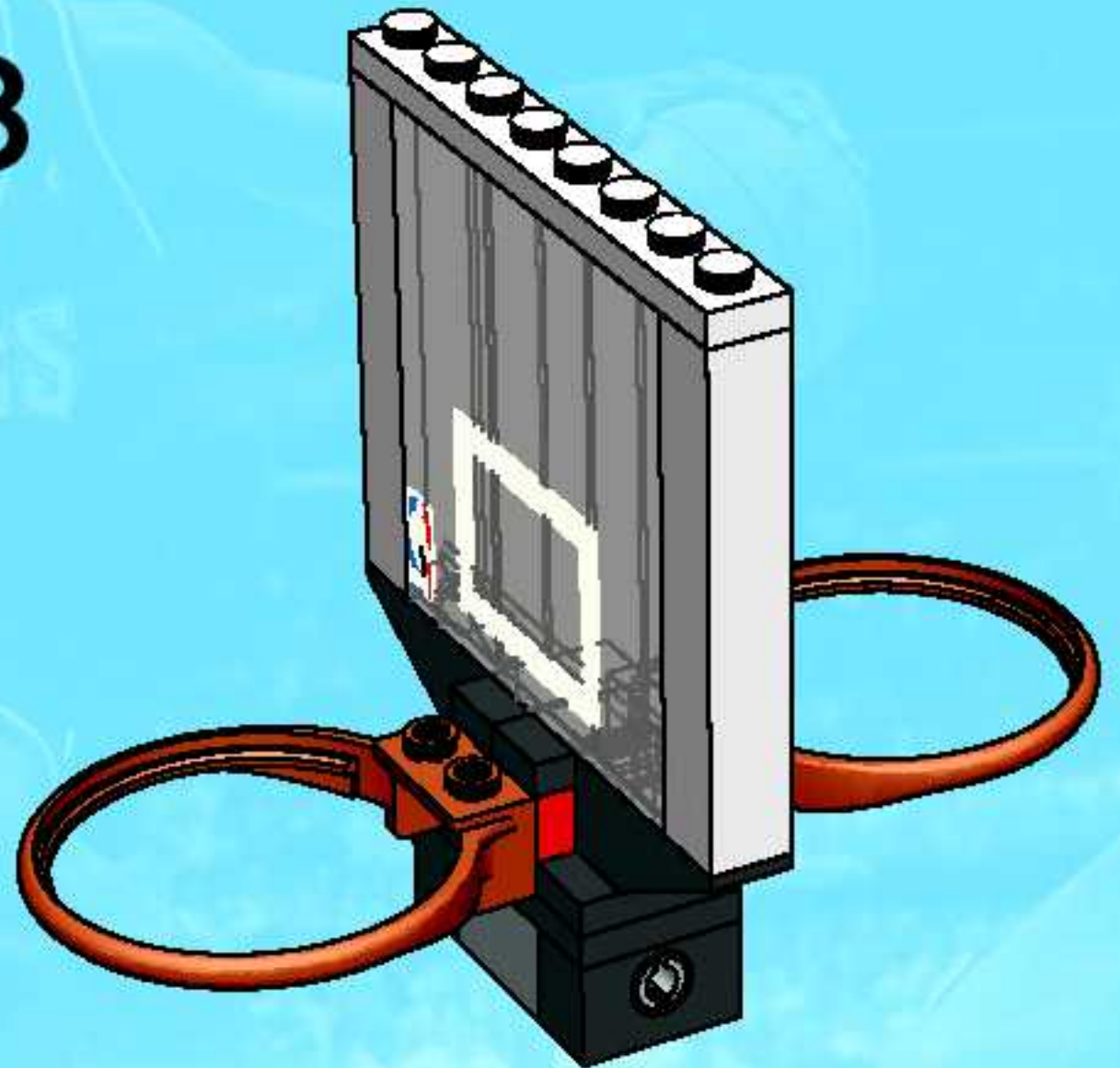



9

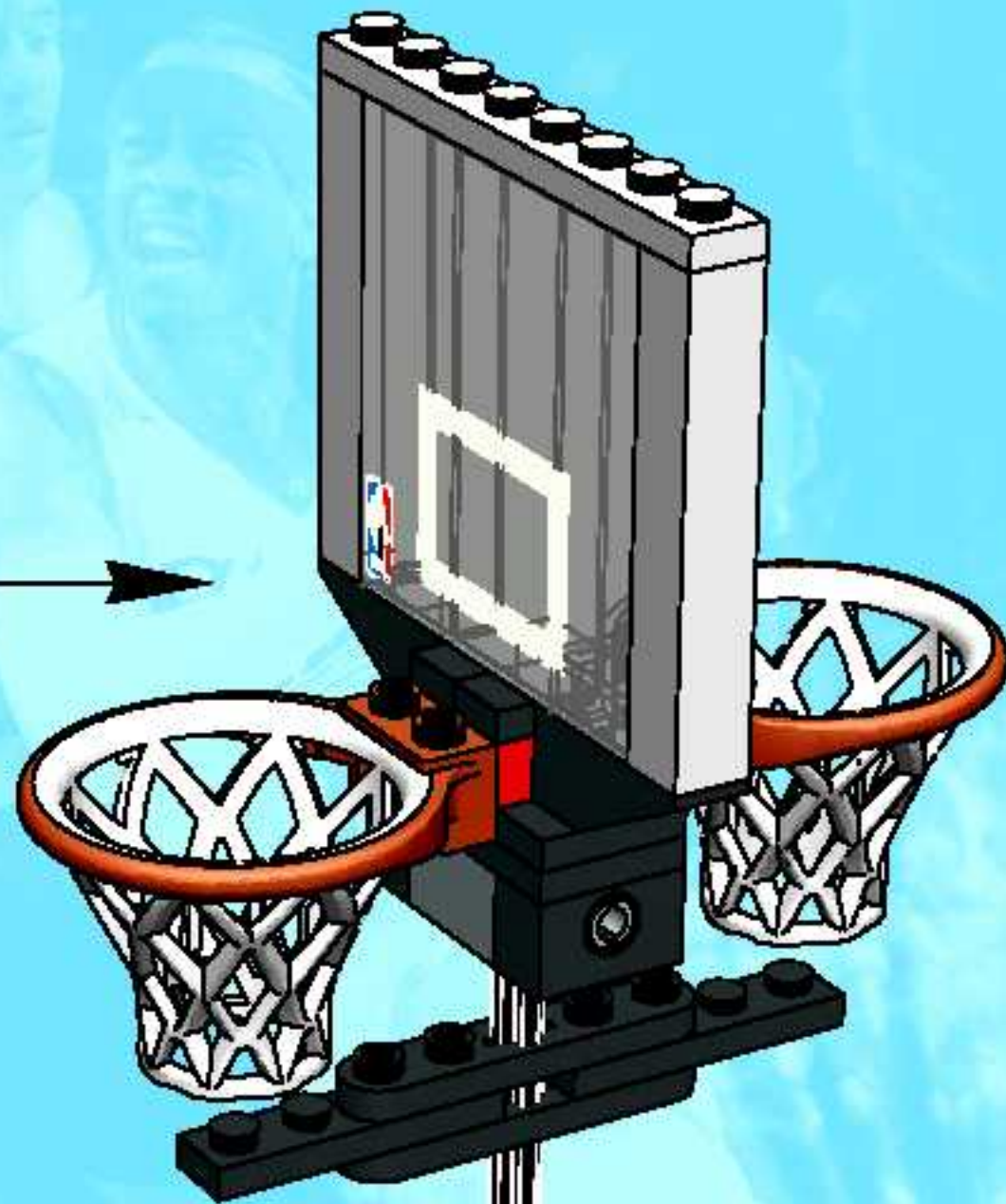
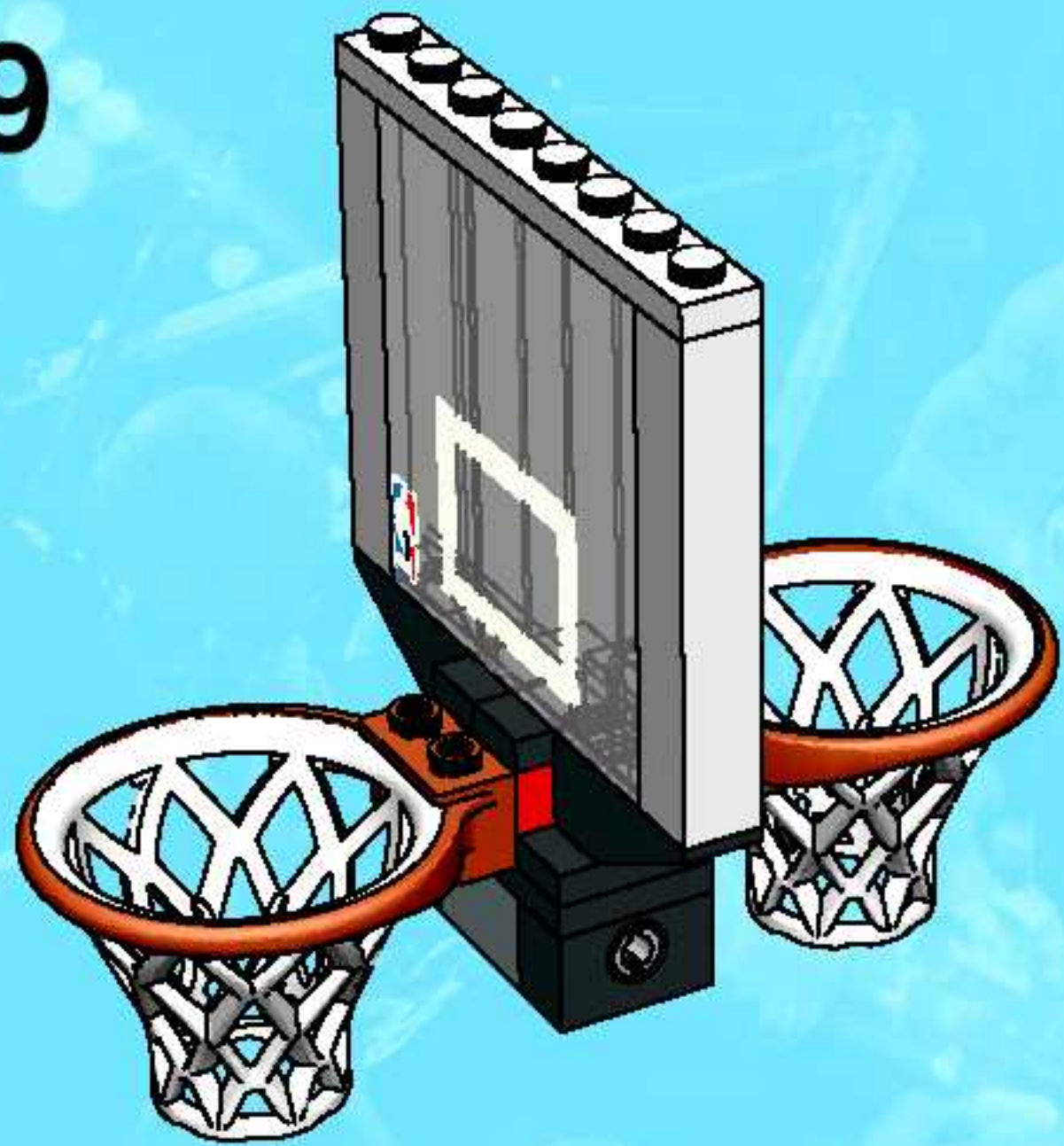

10

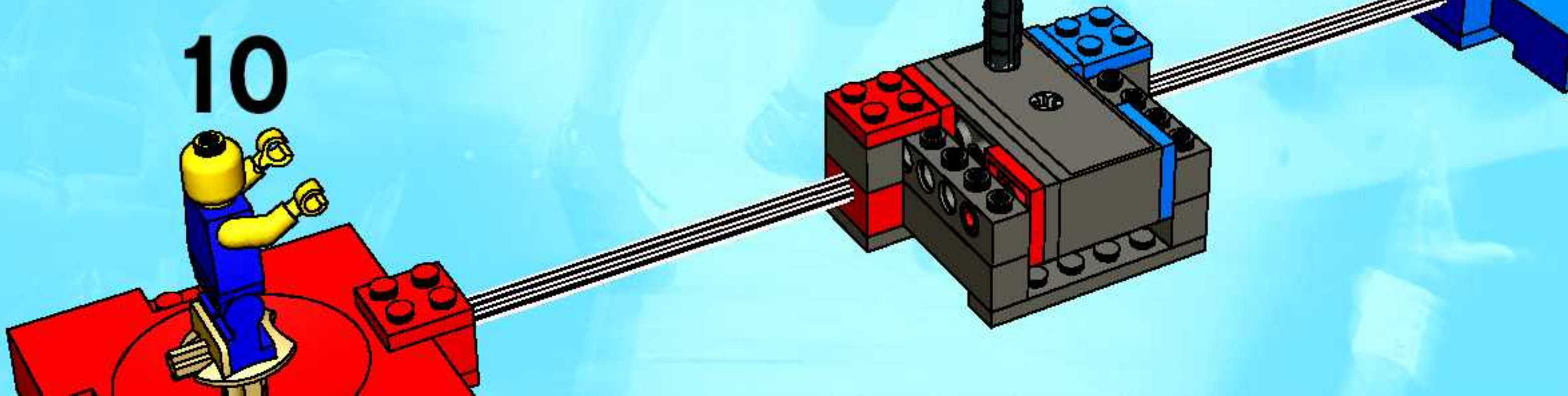









[www.LEGO.com/sports](http://www.LEGO.com/sports)



**NBA**  
**.COM**



© 2003 NBA Entertainment. Photo by Jasey D. Garra-brant. NBA/Getty Images.

© 2003 NBA Entertainment. Photo by Jasey D. Garra-brant. NBA/Getty Images.

© 2003 NBA Entertainment. Photo by Jasey D. Garra-brant. NBA/Getty Images.

© 2003 NBA Entertainment. Photo by Doug P. Stanger/NBA/Getty Images.

© 2003 NBA Entertainment. Photo by Jasey D. Garra-brant. NBA/Getty Images.



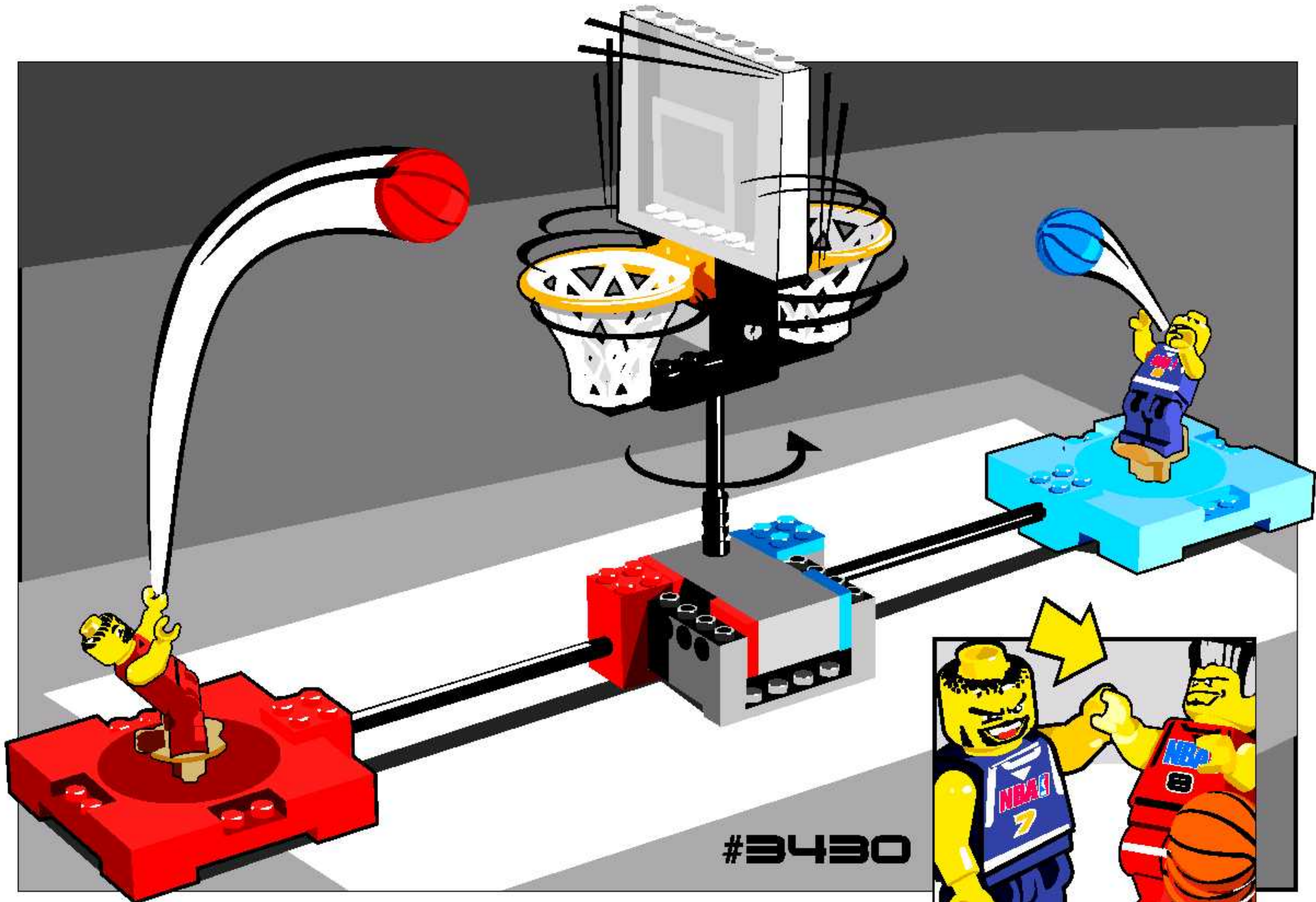

#3430







1

3431+3430

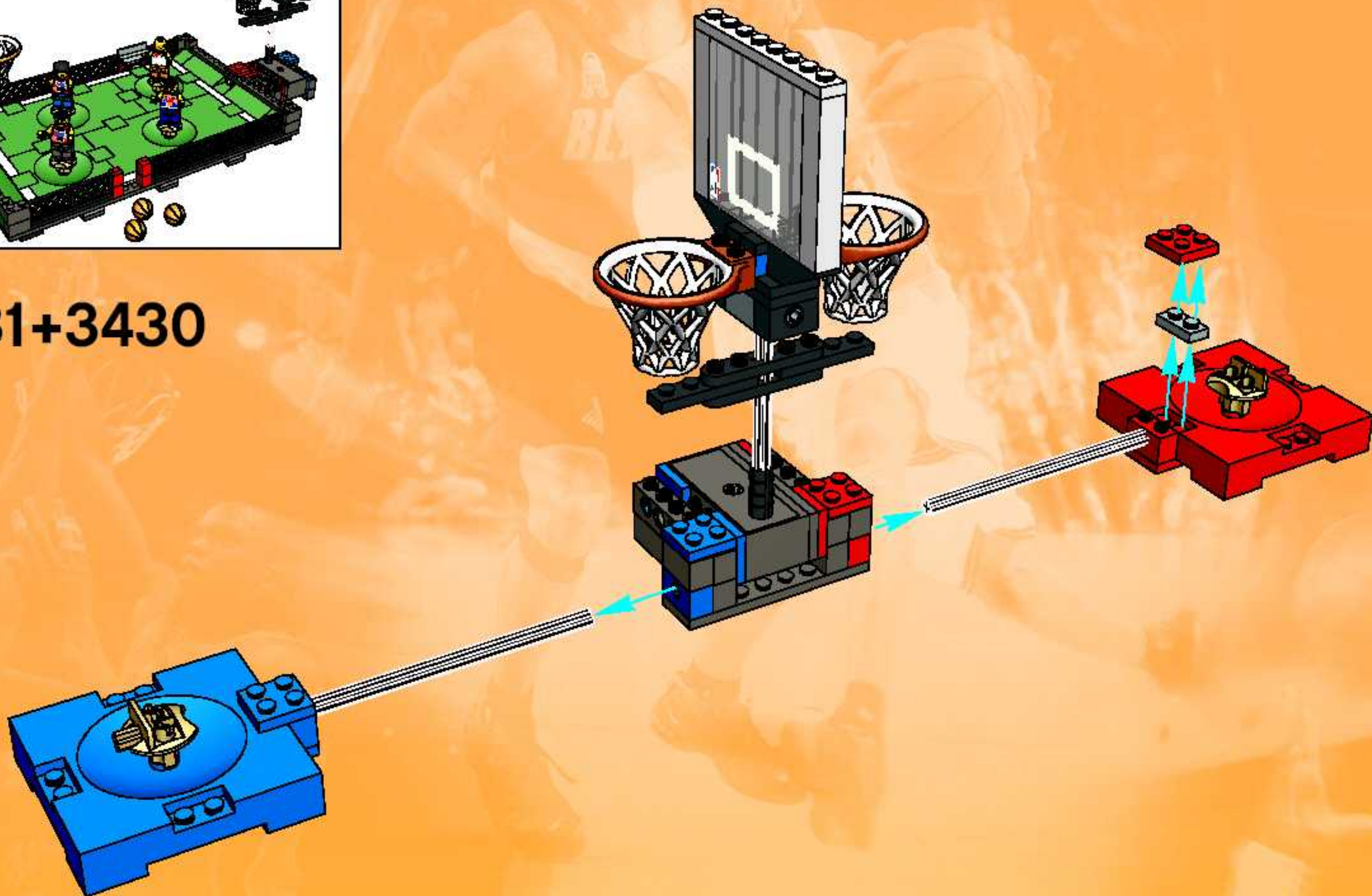



2





3





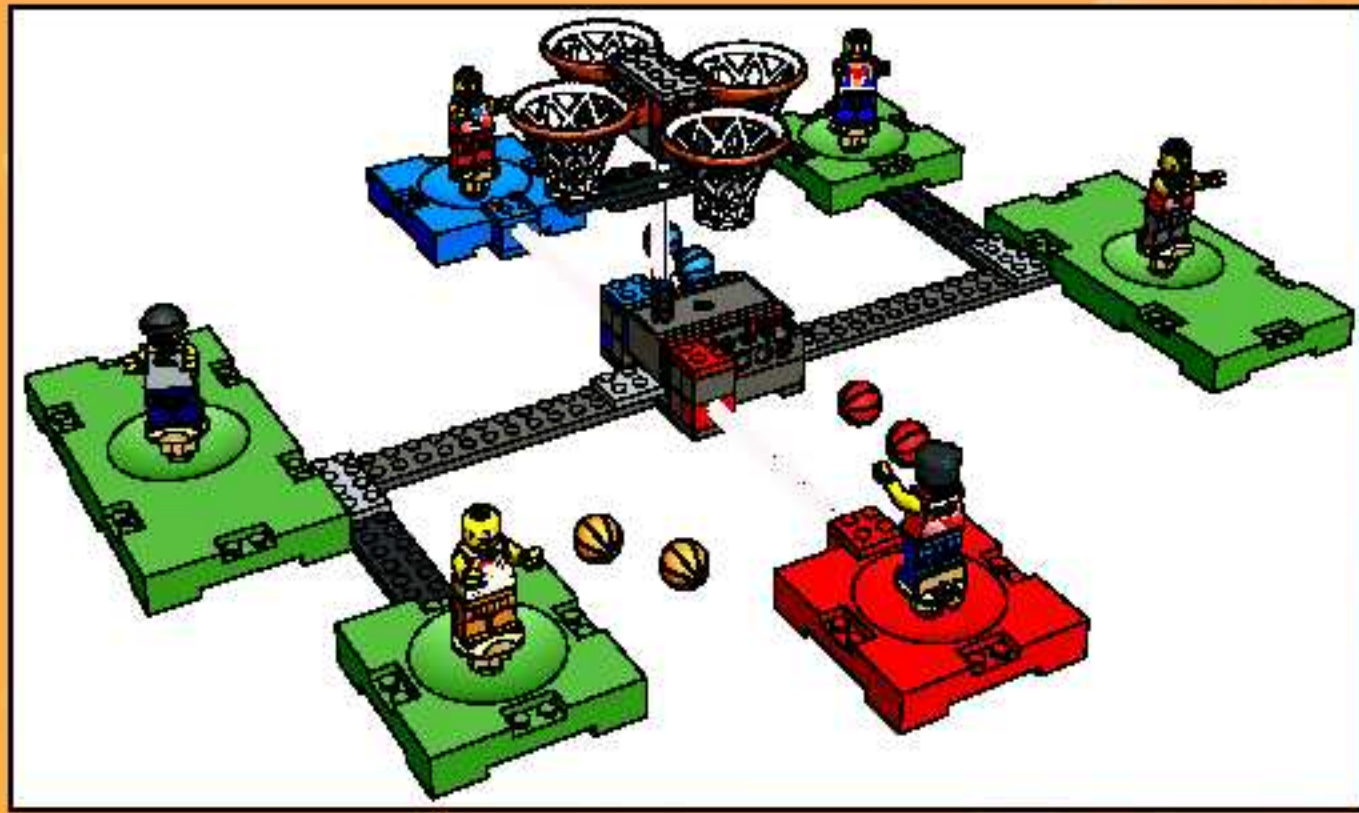

1

3431+3430

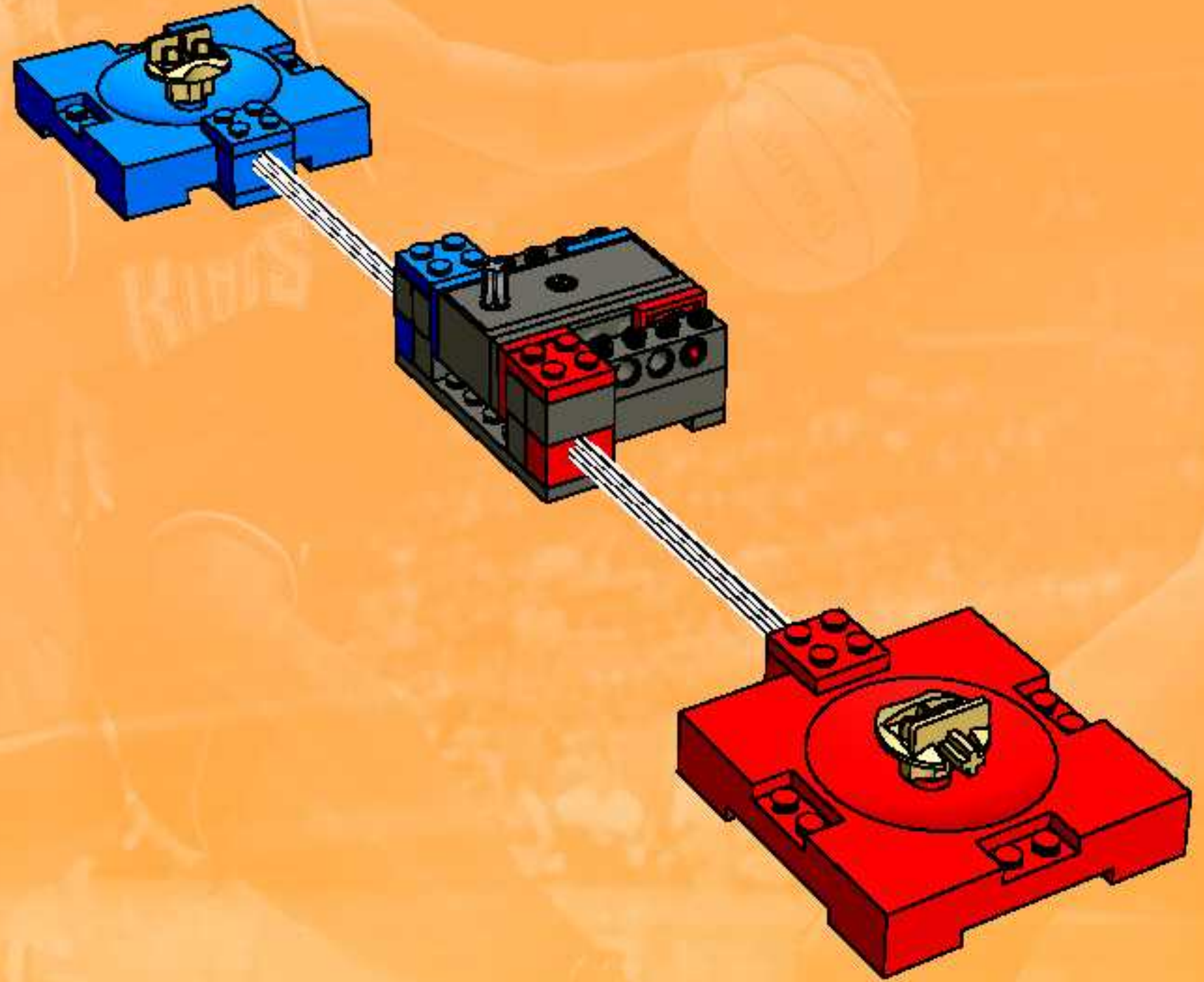



1

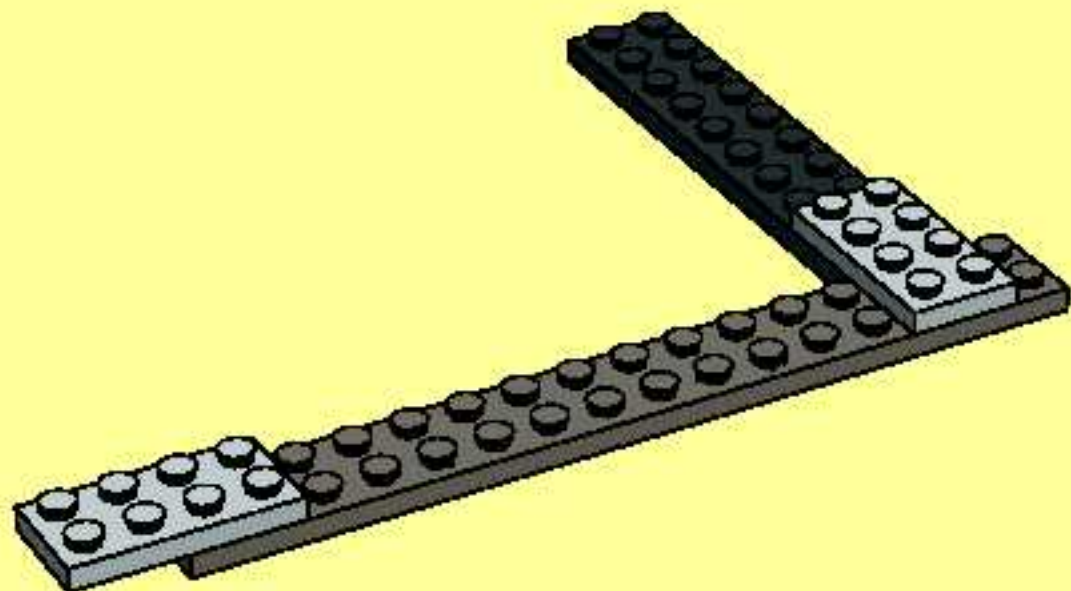

2

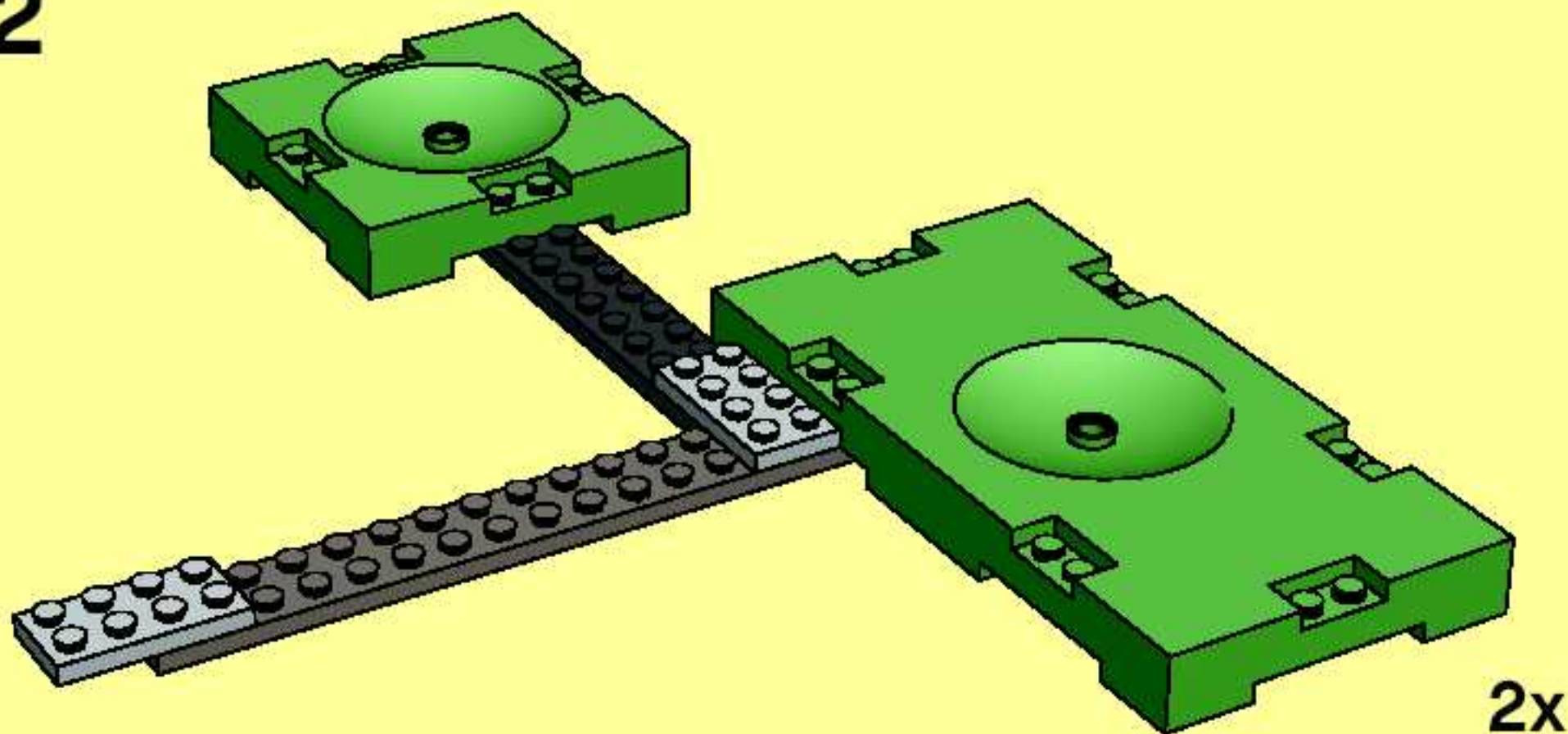

2x



2

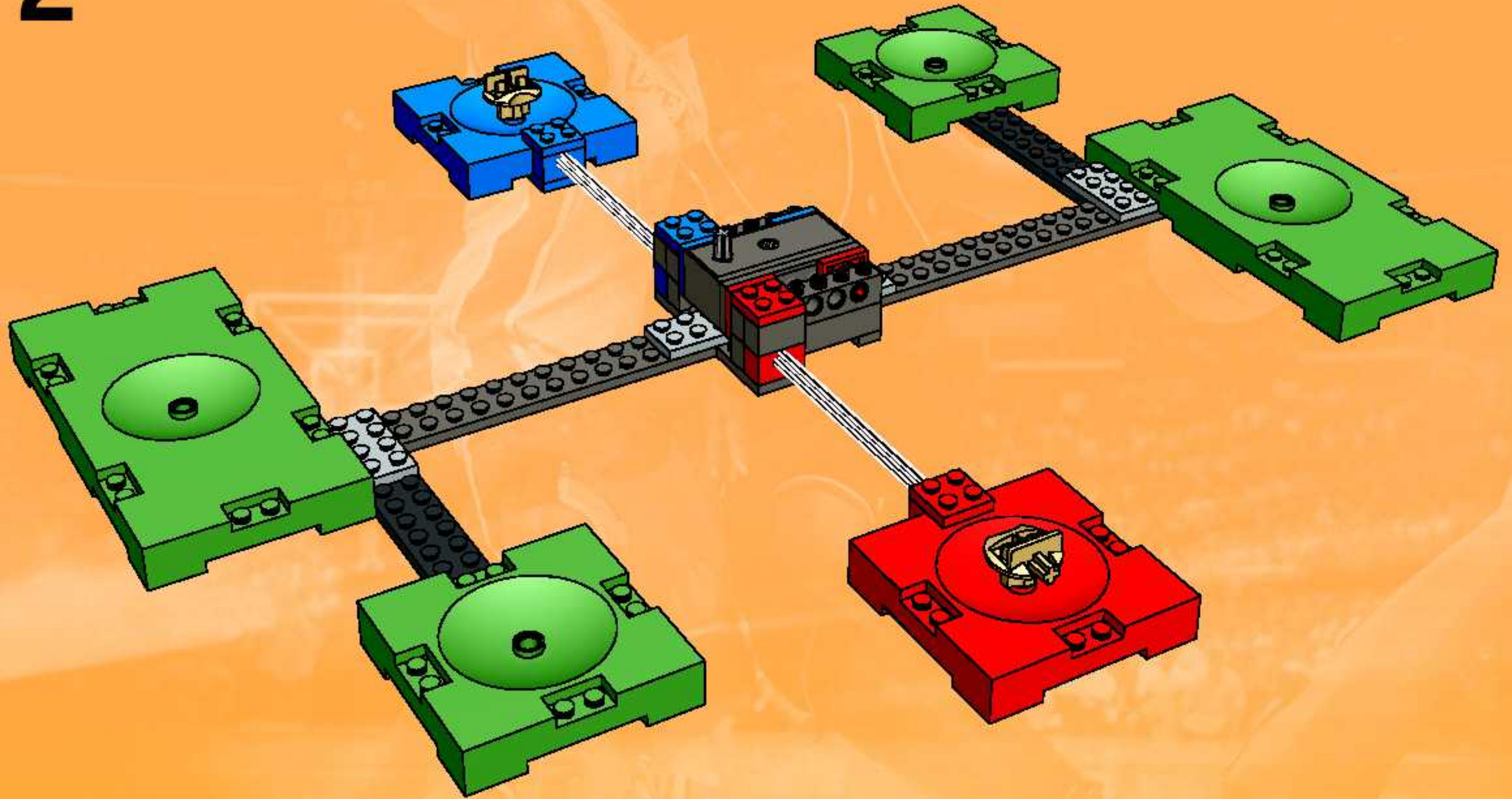



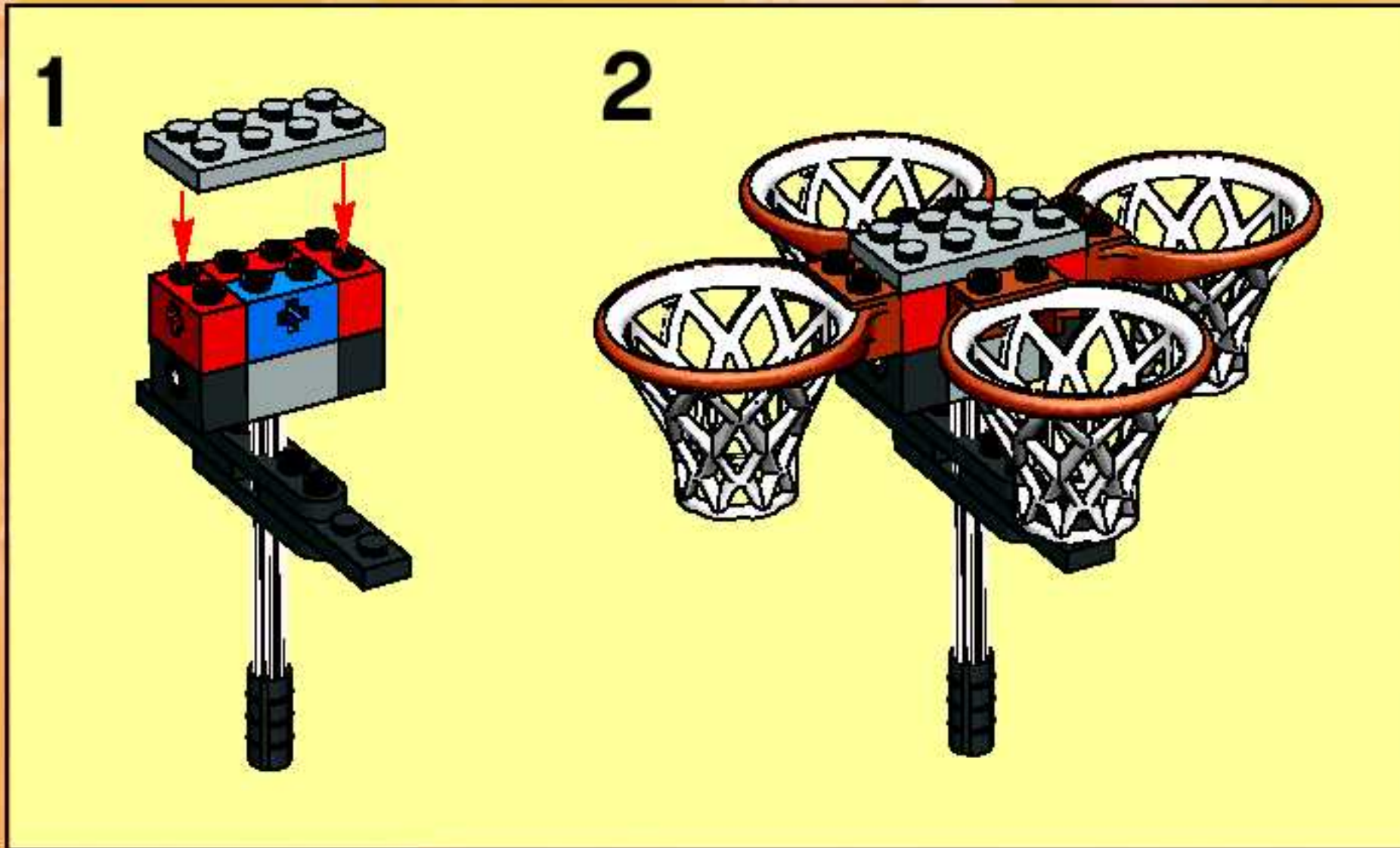



3

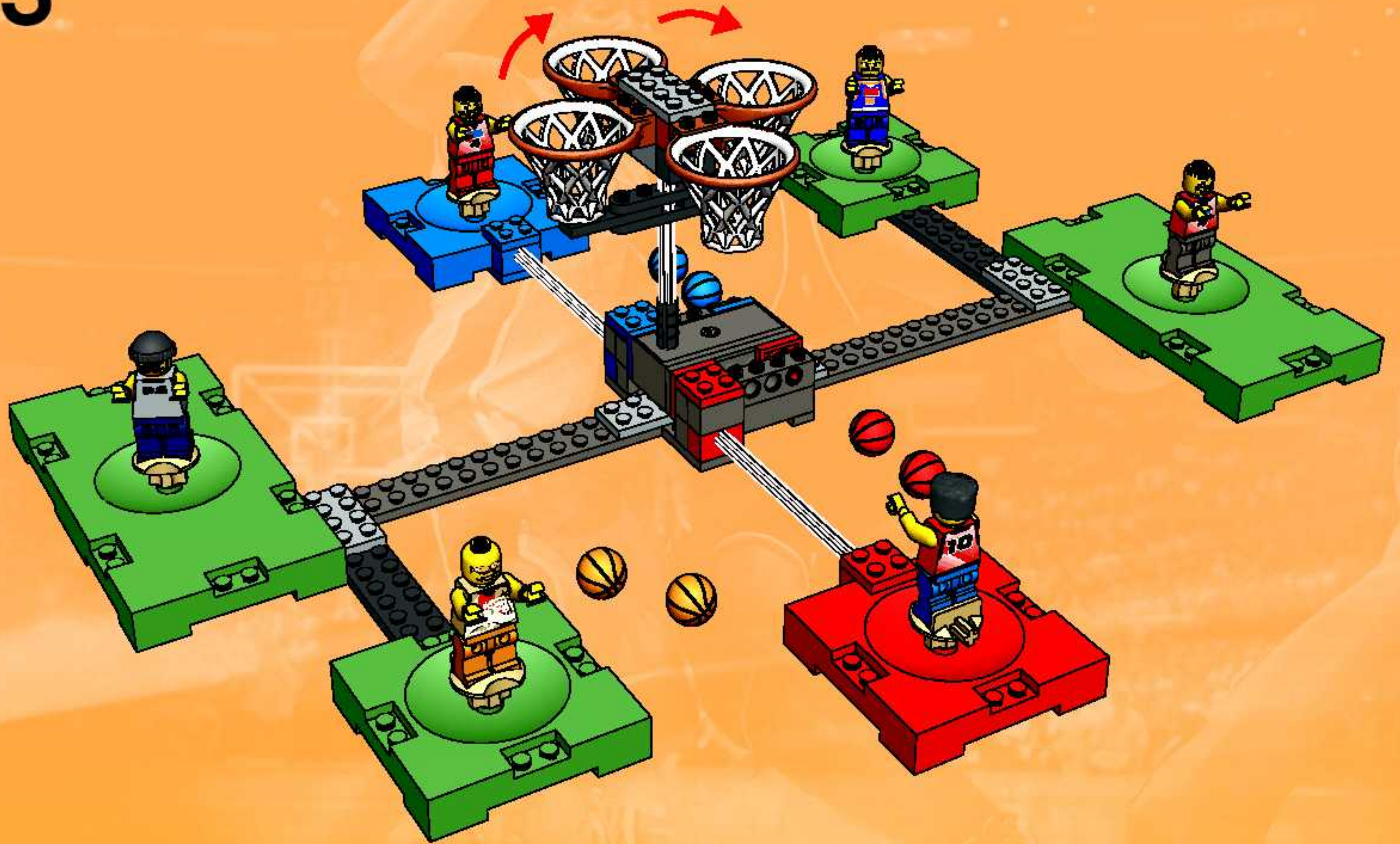





NBA identifications depicted are the exclusive property of NBA Properties, Inc. and/or the NBA Member Teams, and are used with permission.

SPALDING is a trademark of Spalding Sports Worldwide, Inc. or Lisco Sports, Inc., a Spalding affiliate.  
© Spalding Sports Worldwide, Inc. 2003.



NHL and the NHL Shield are registered trademarks of the National Hockey League. All NHL logos and marks and team logos and marks depicted herein are the property of the NHL and the respective teams and may not be reproduced without the prior written consent of NHL Enterprises, L.P. © NHL 2003. All Rights Reserved.

 [www.LEGO.com/sports](http://www.LEGO.com/sports)

LEGO, the LEGO logo and the Minifigure are trademarks of the LEGO Group. ©2003 The LEGO Group.

adidas, the adidas logo and the three stripe trademark are registered trademarks of the adidas-Salomon group, used with permission. Fevernova and the Trigon logo are trademarks of the adidas-Salomon group, used with permission.