

3430



SPORTS





3432

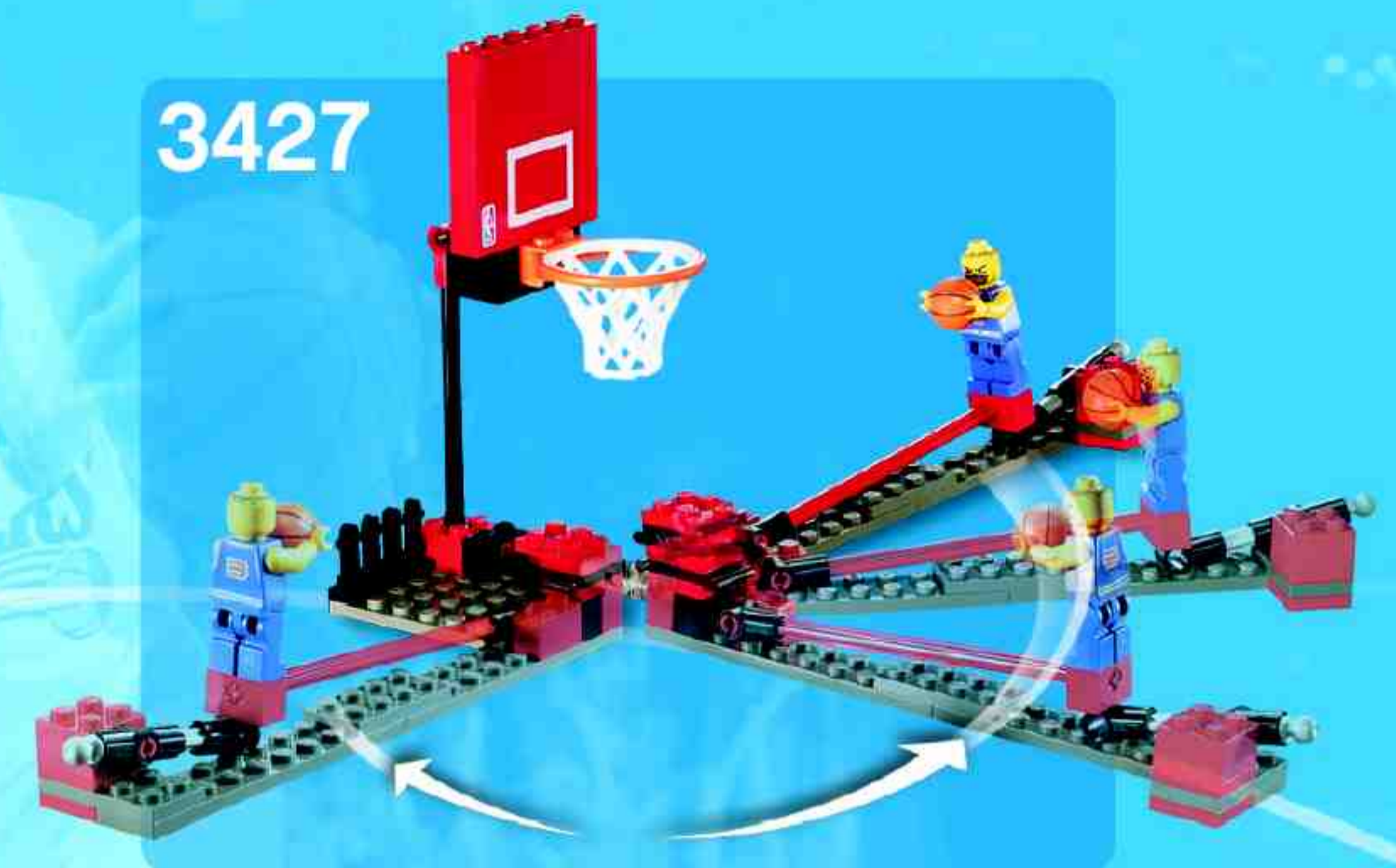

3427



3430



3431

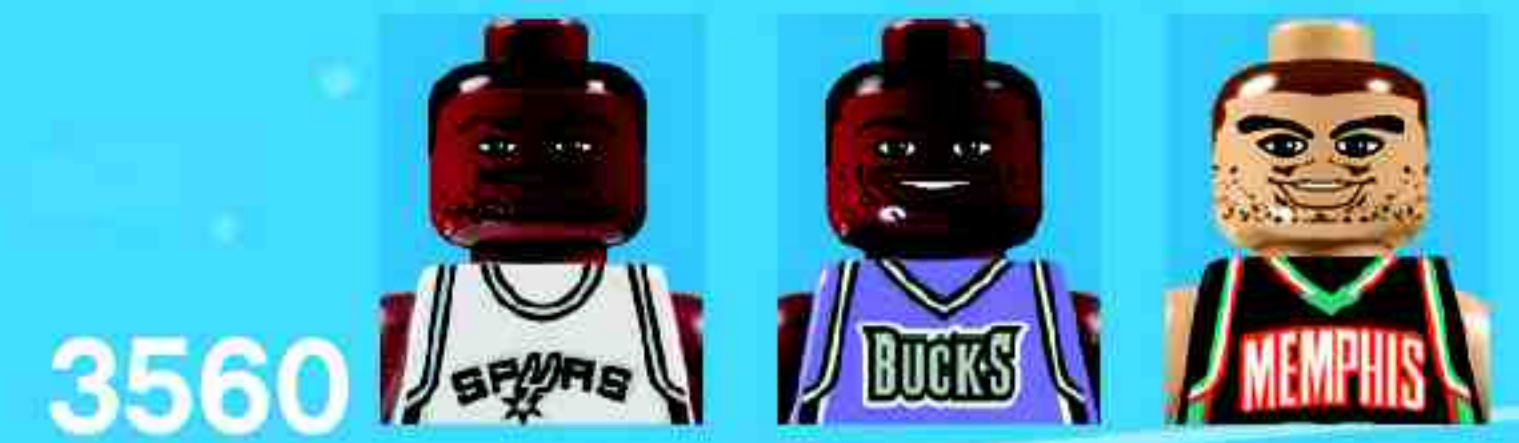

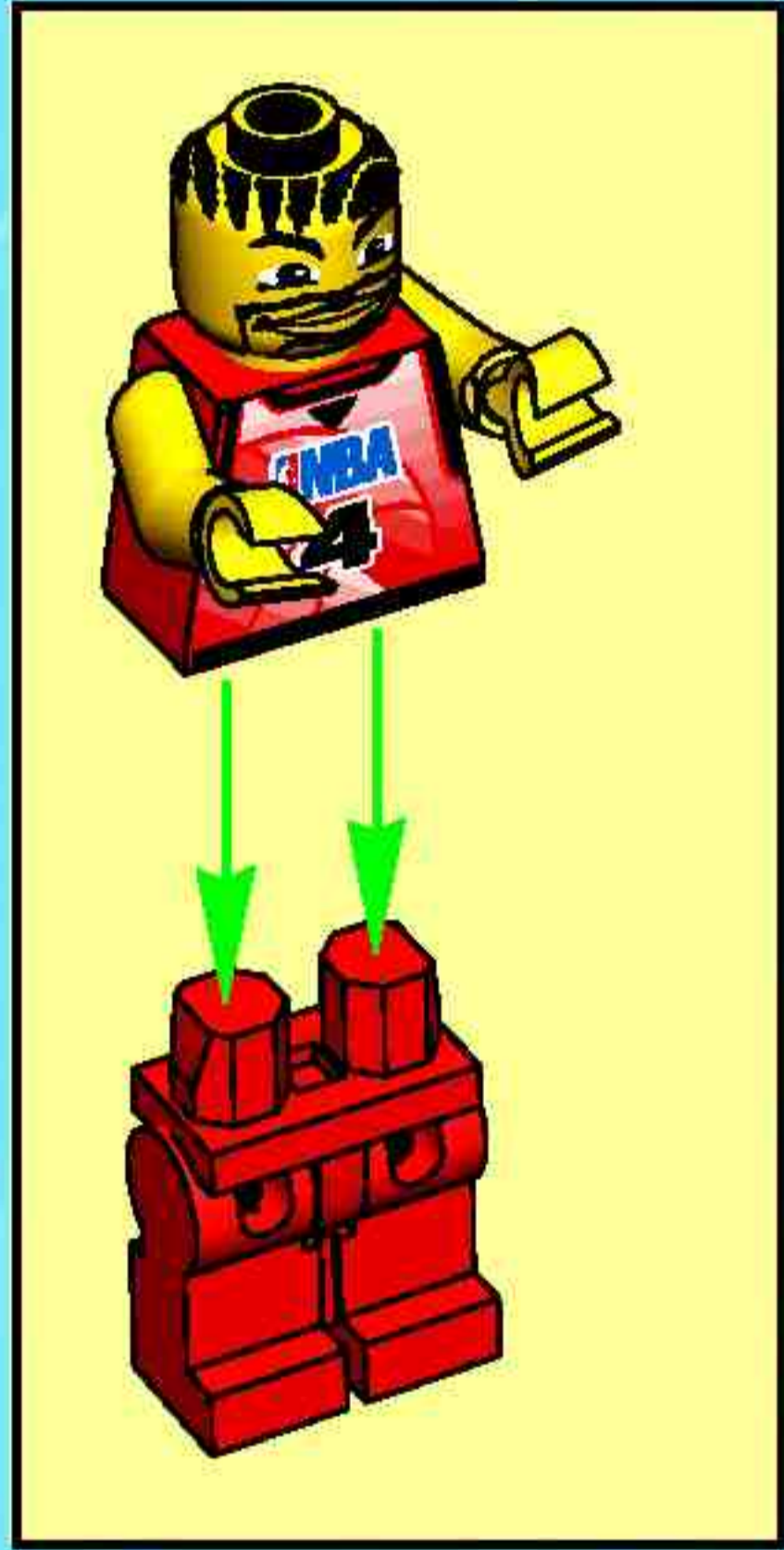

1

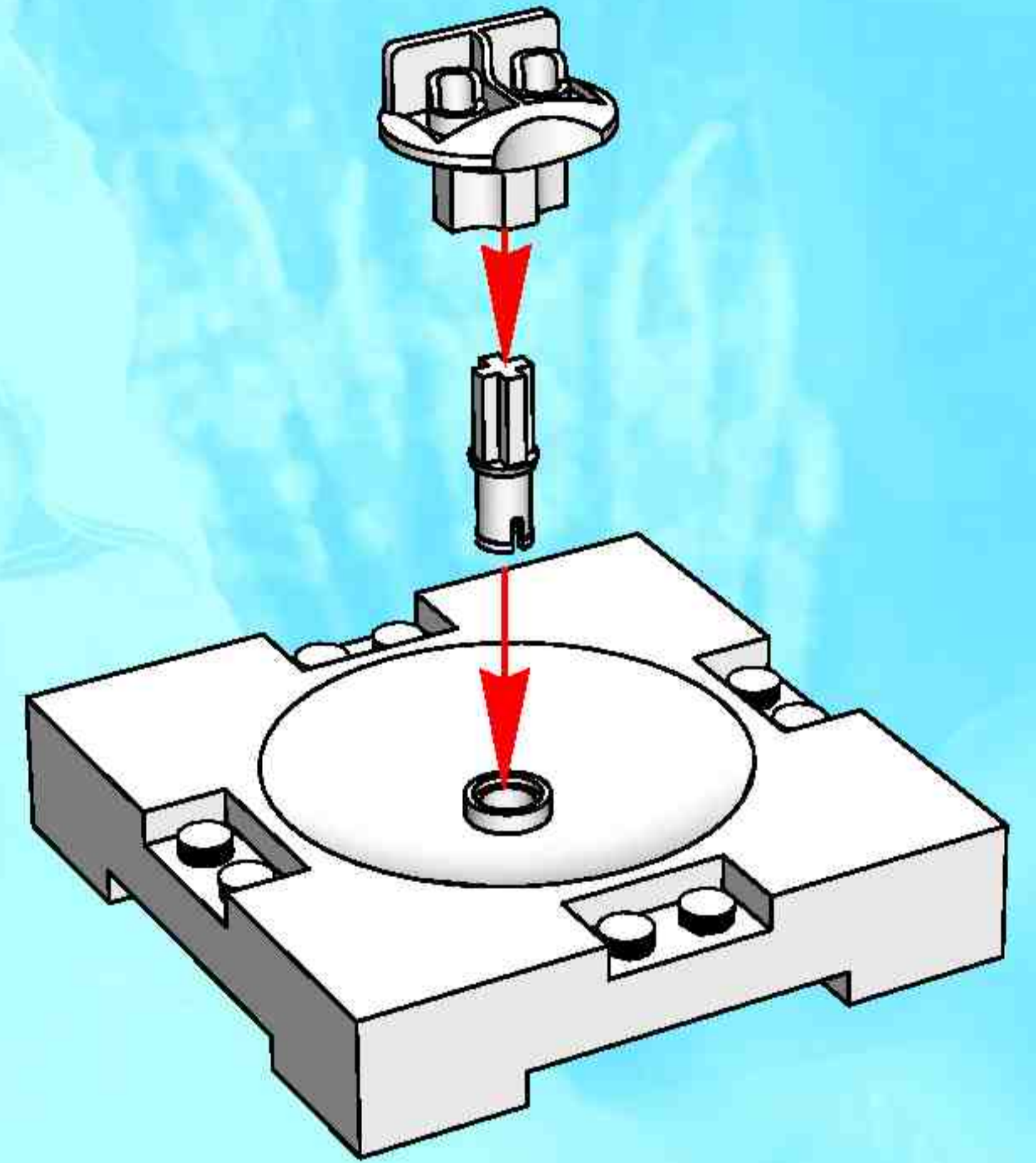

2

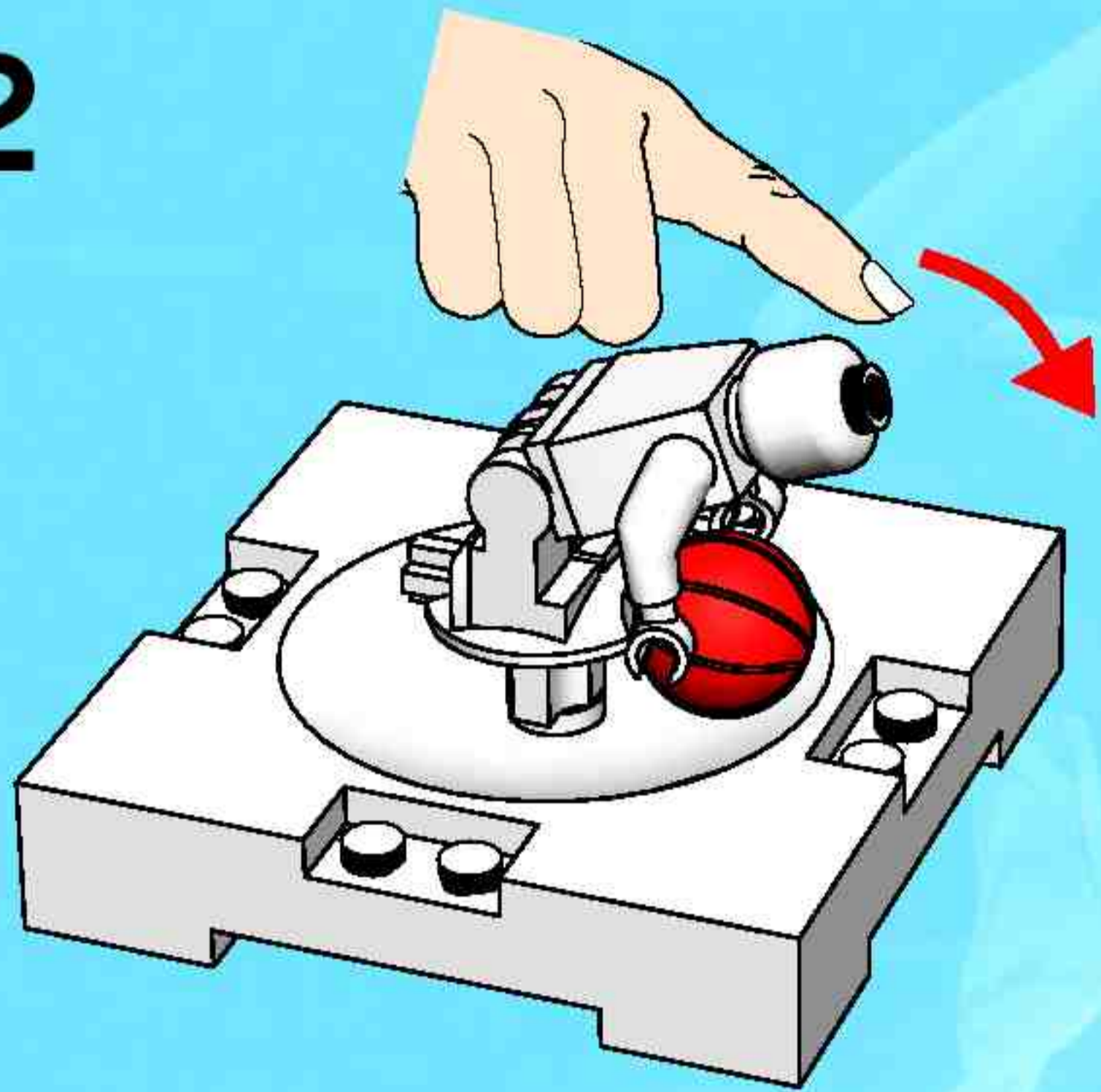

3

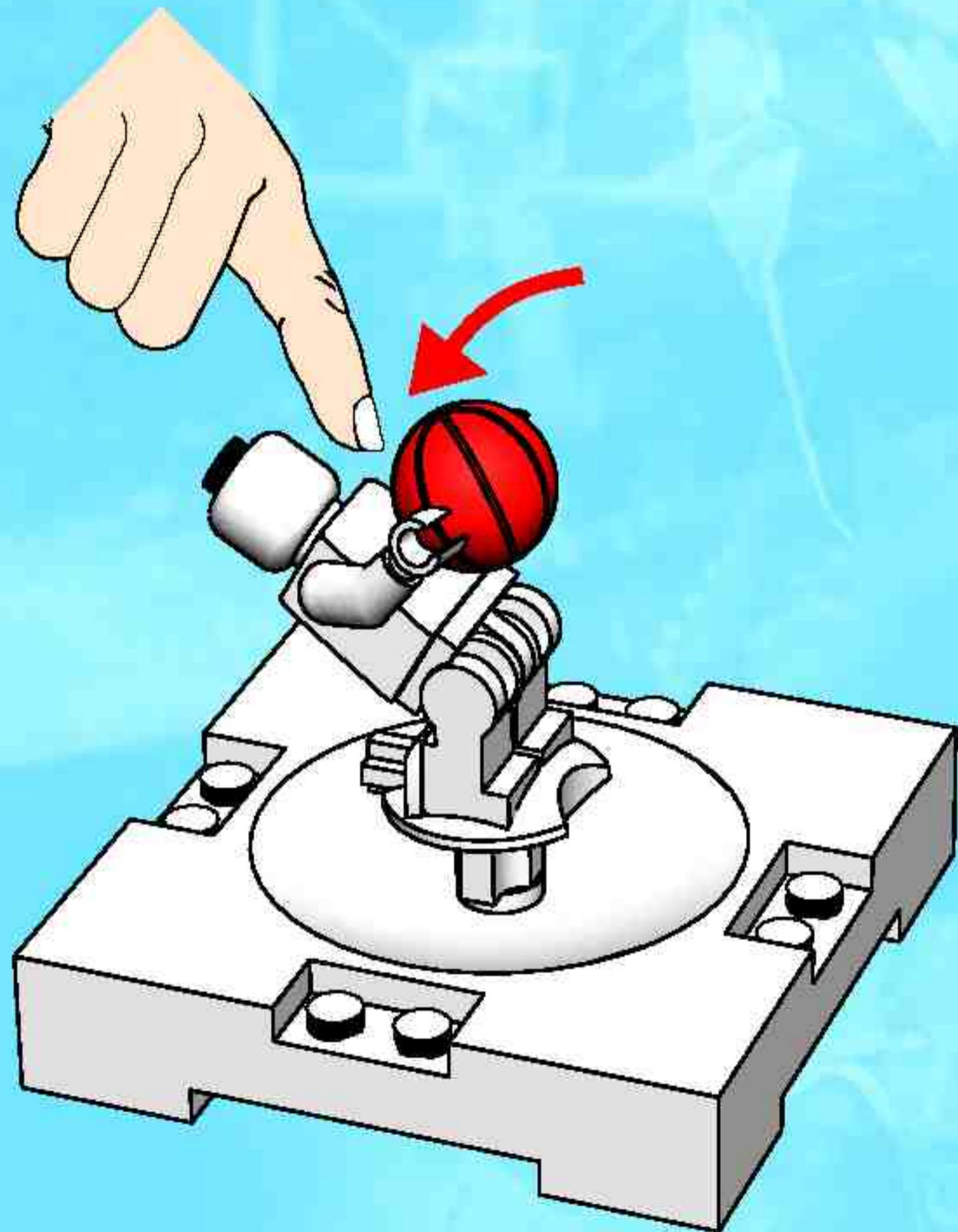

4

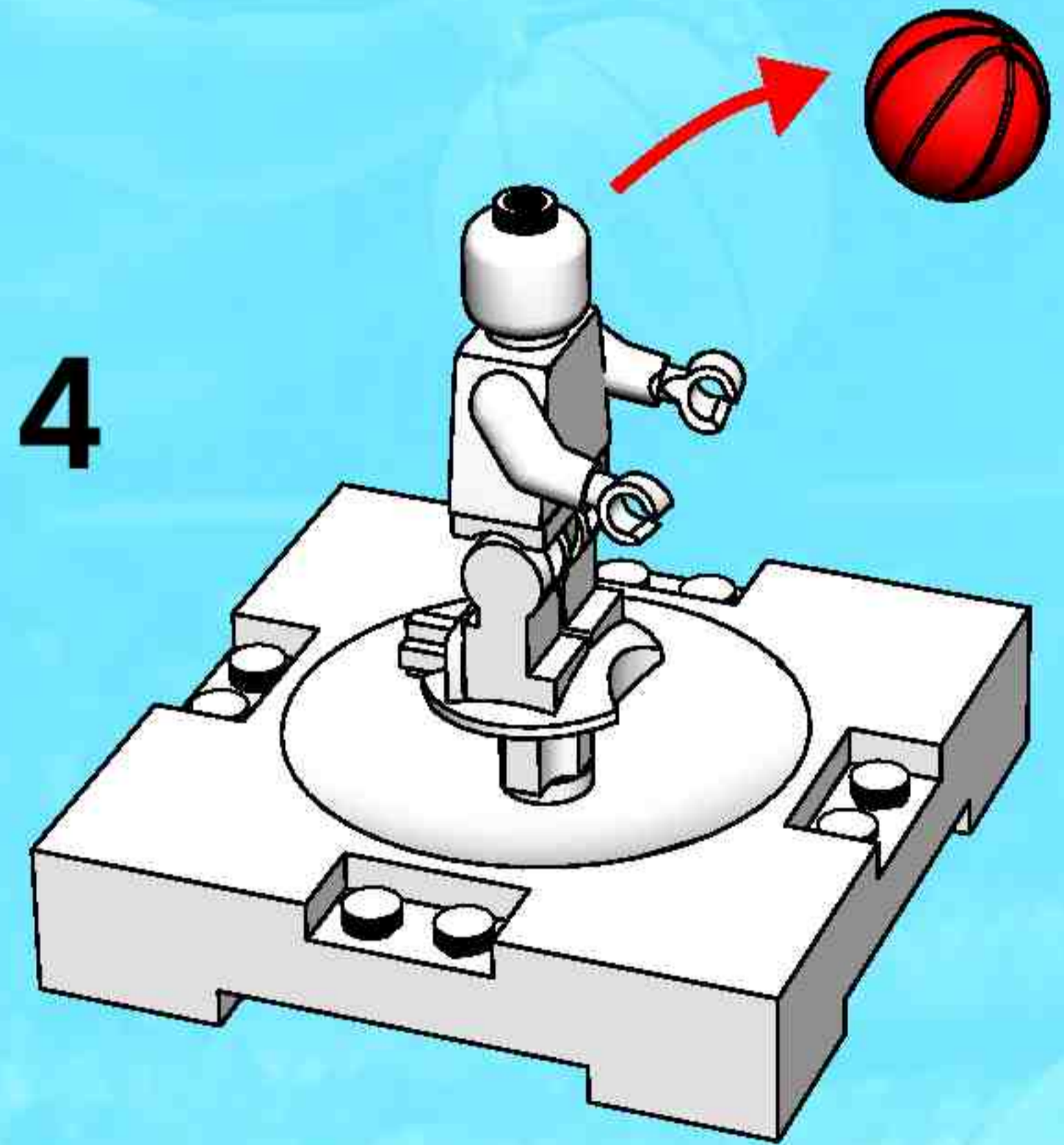

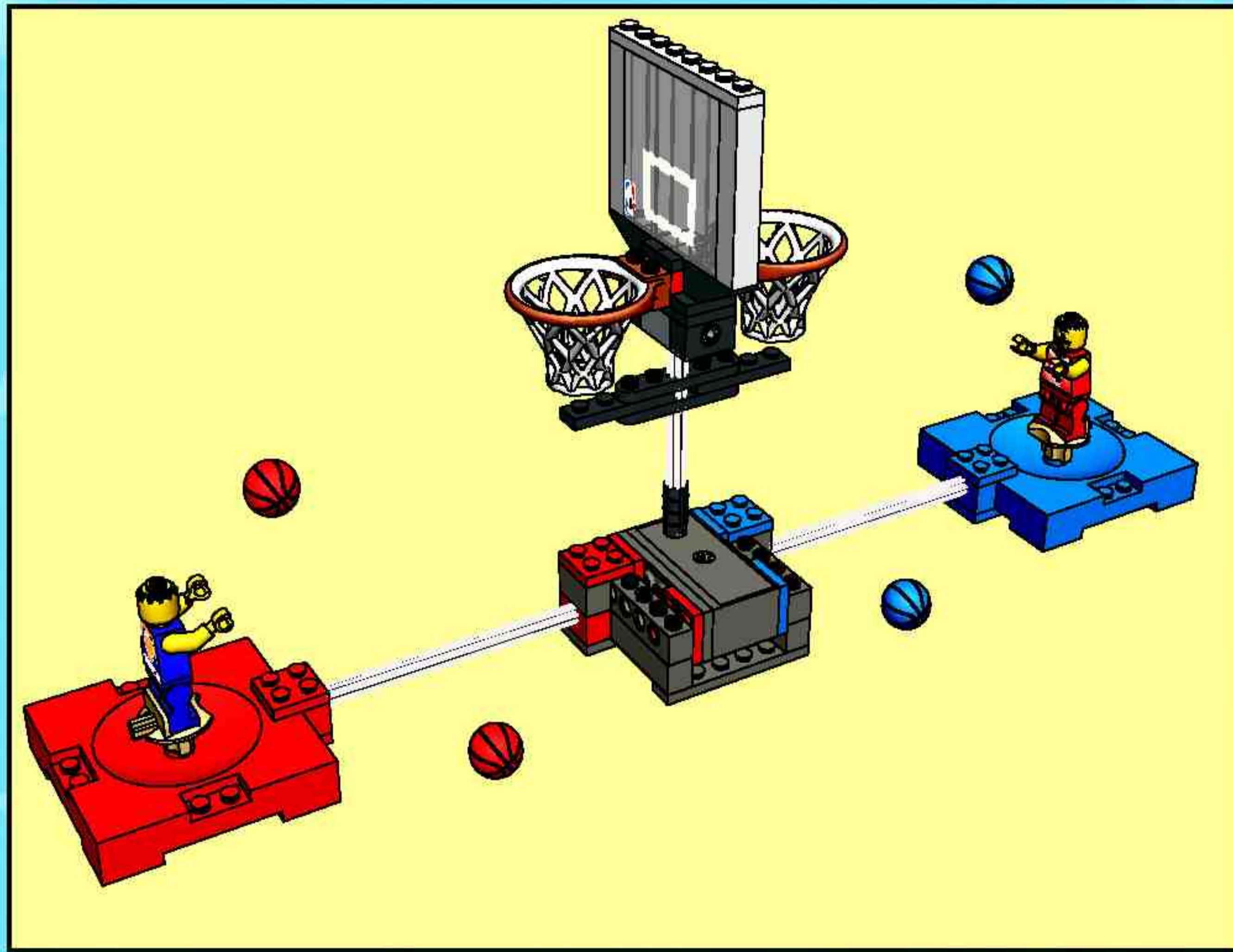

3

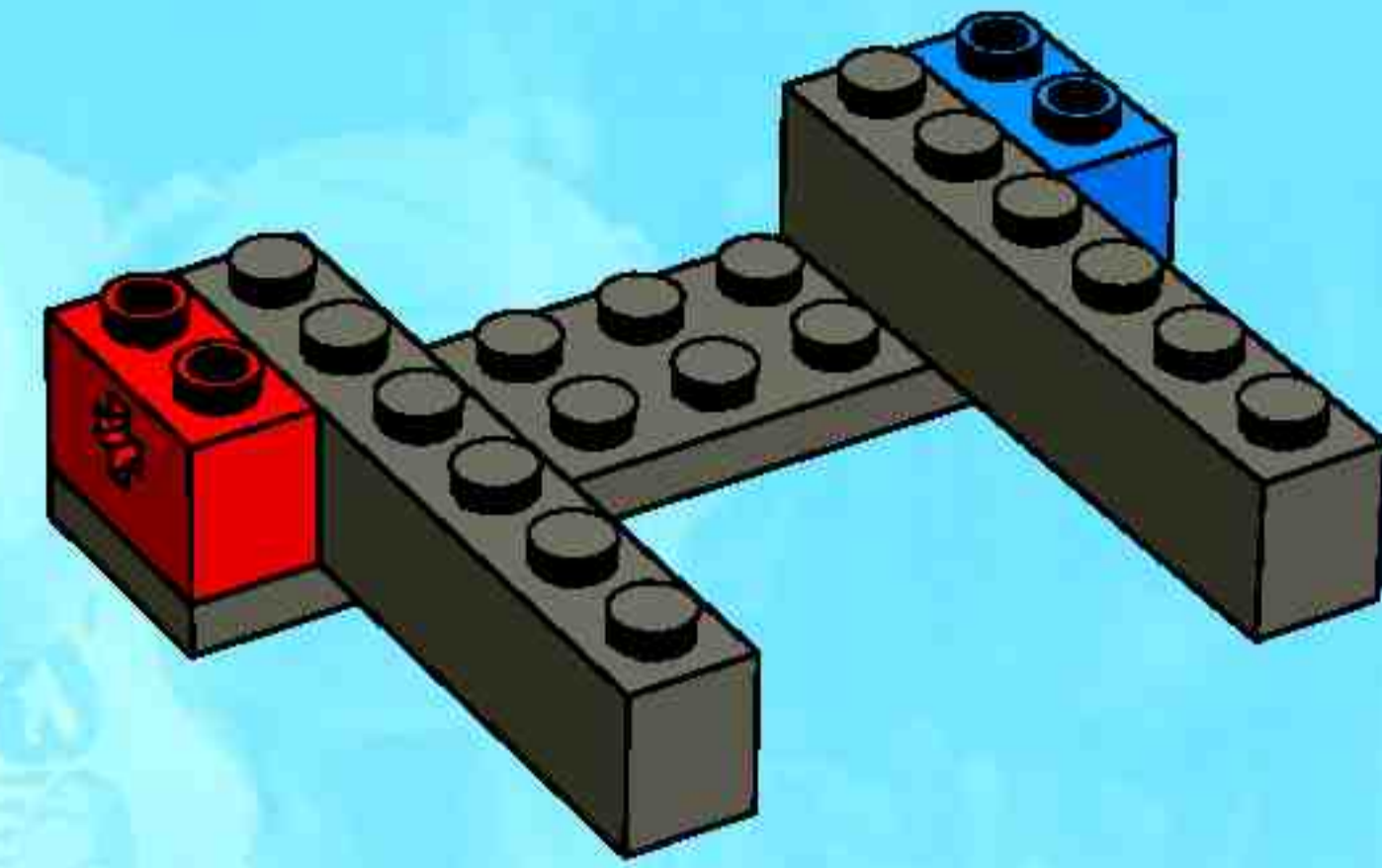

1

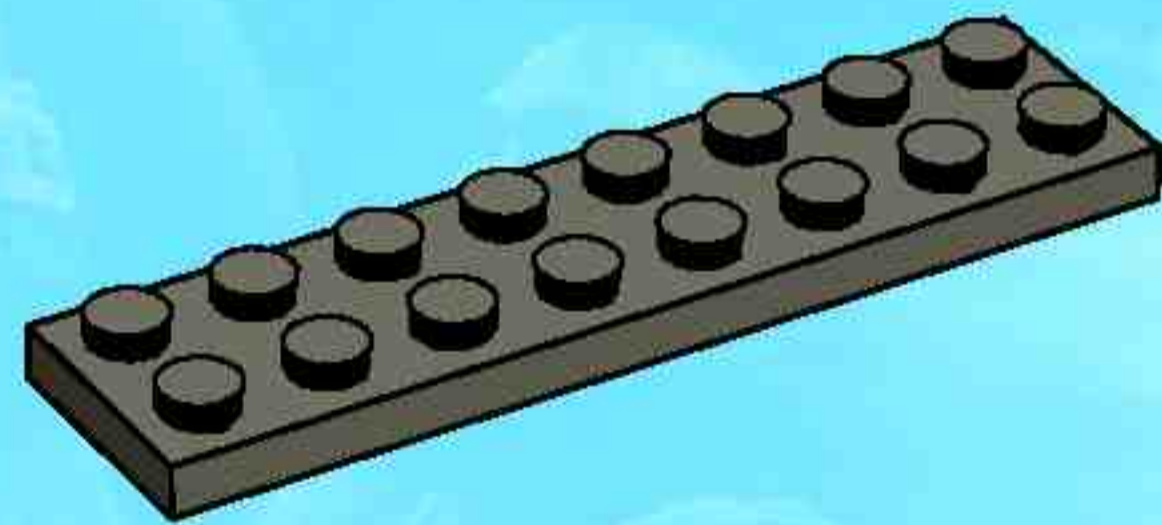

2

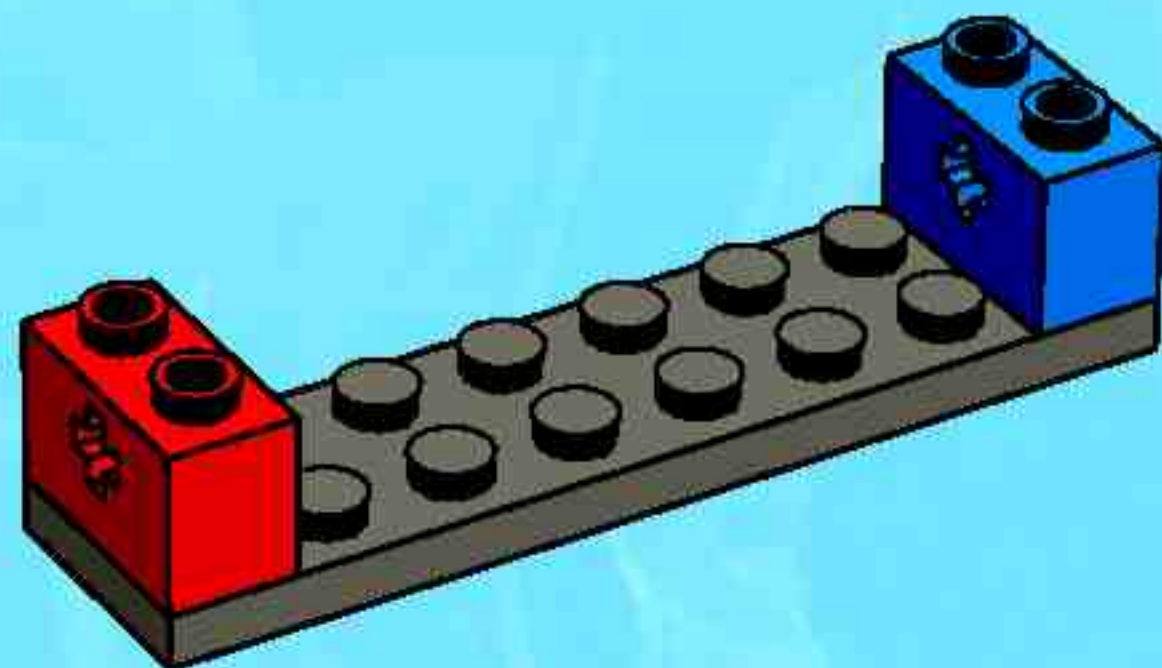

4

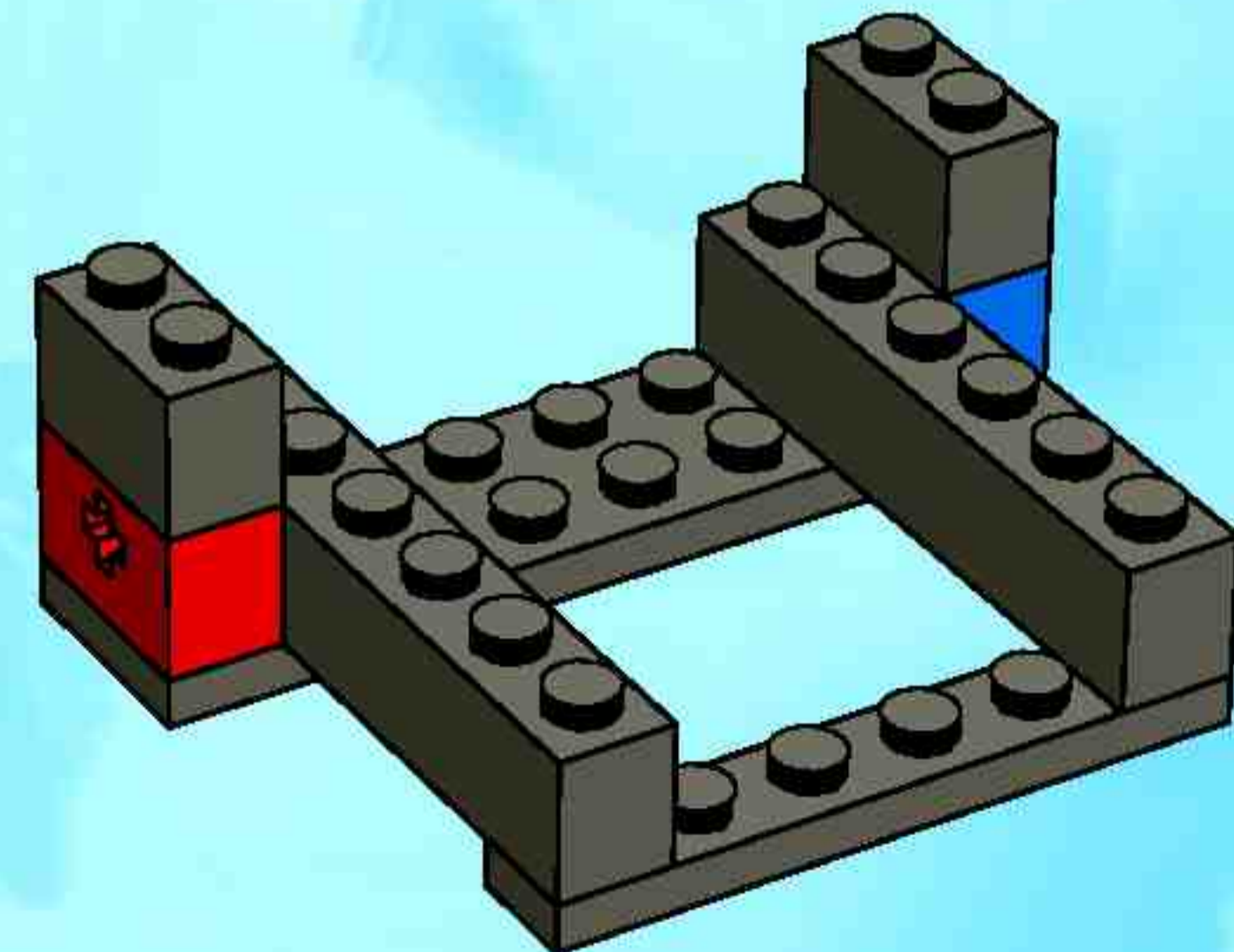

1

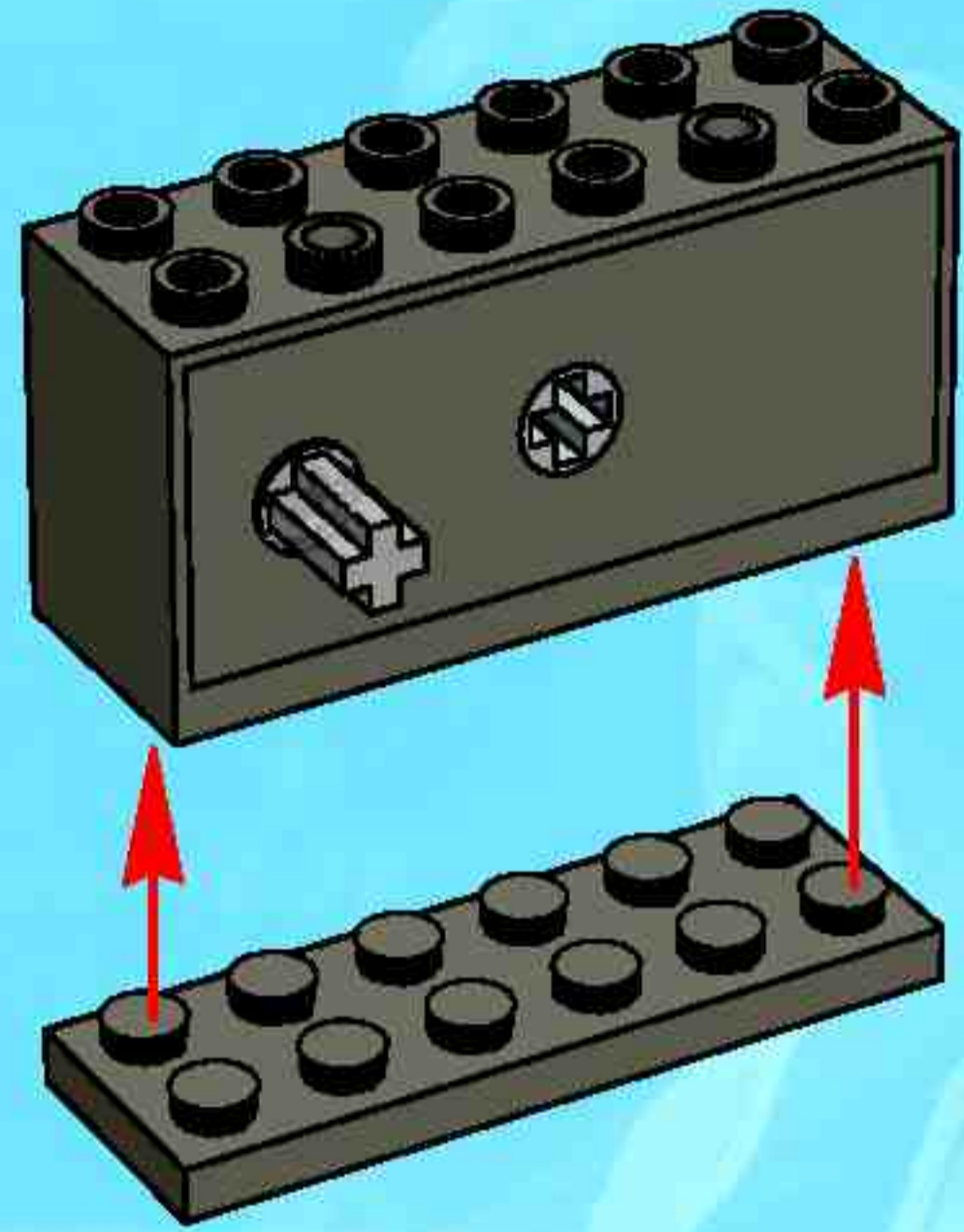

2

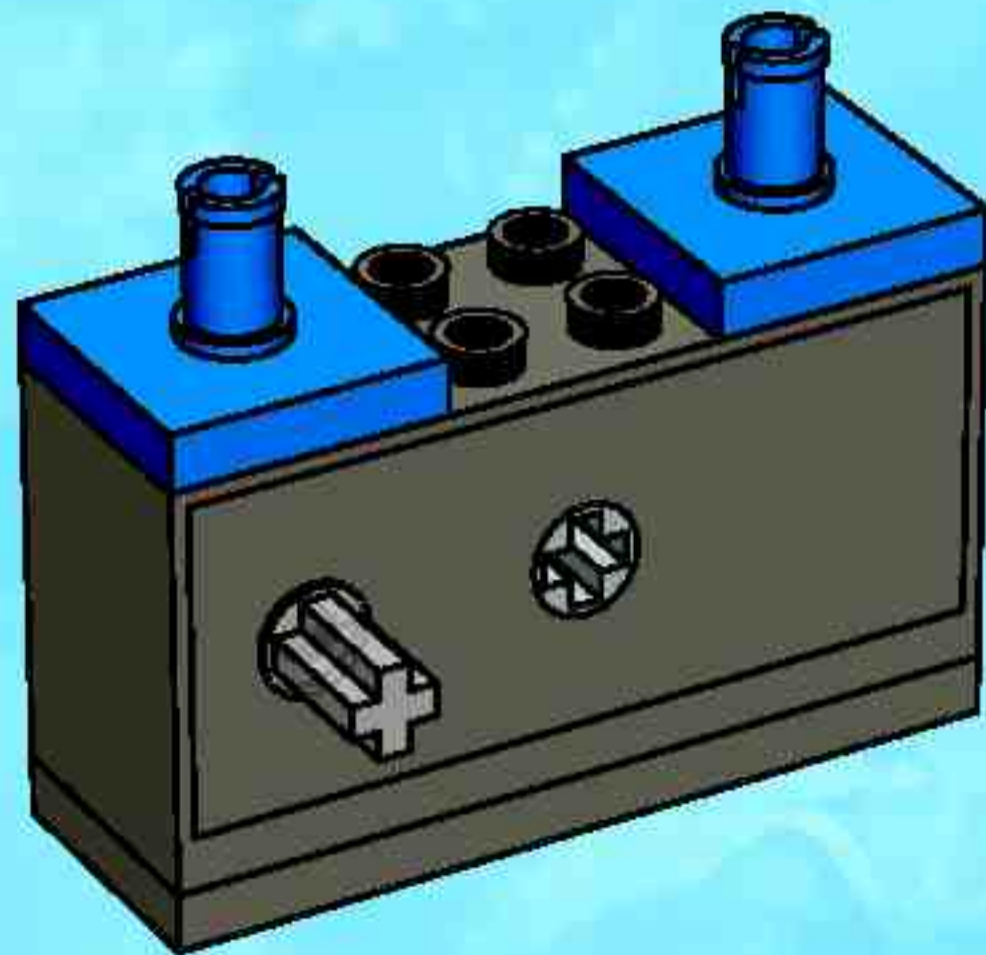

3

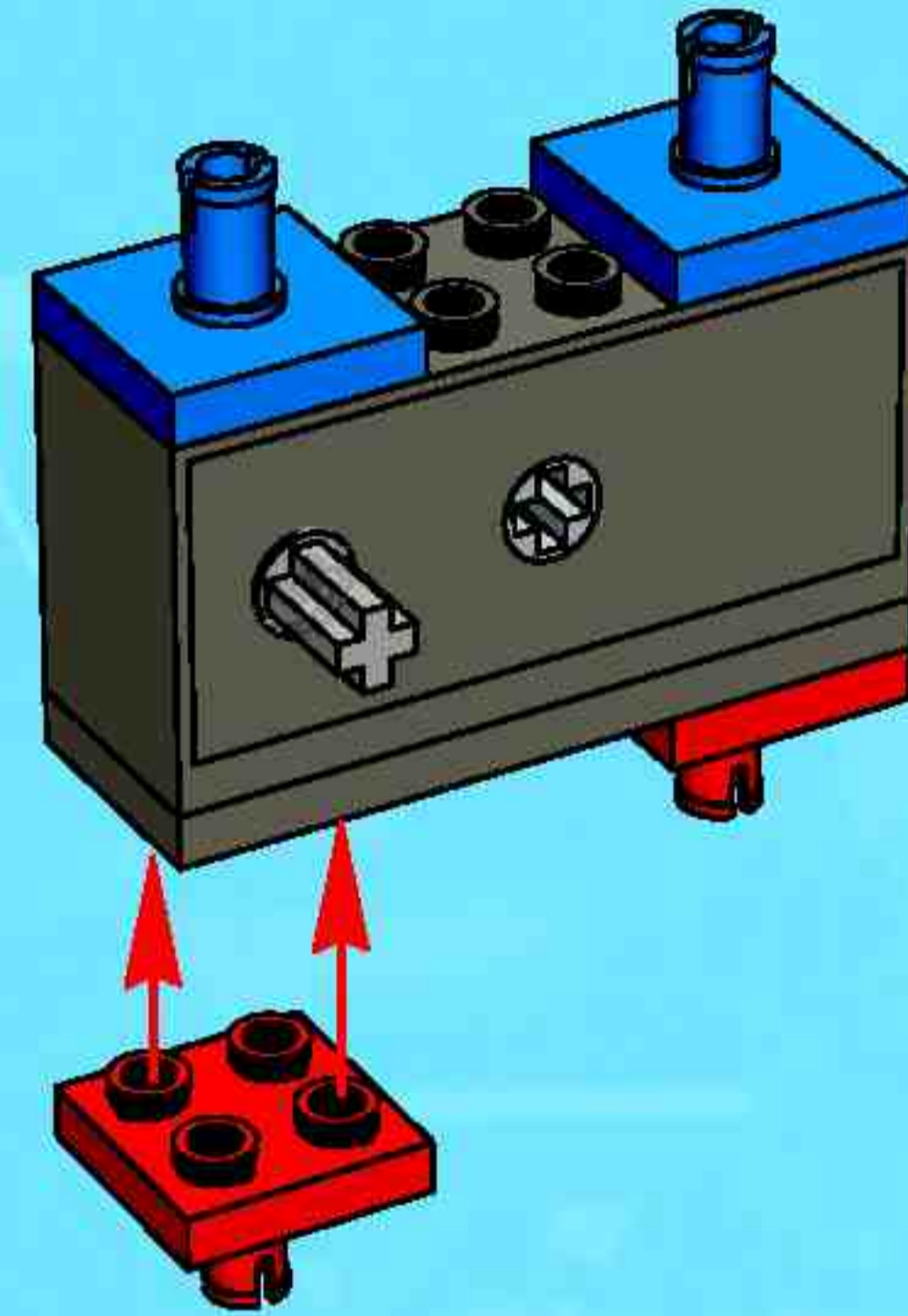

4

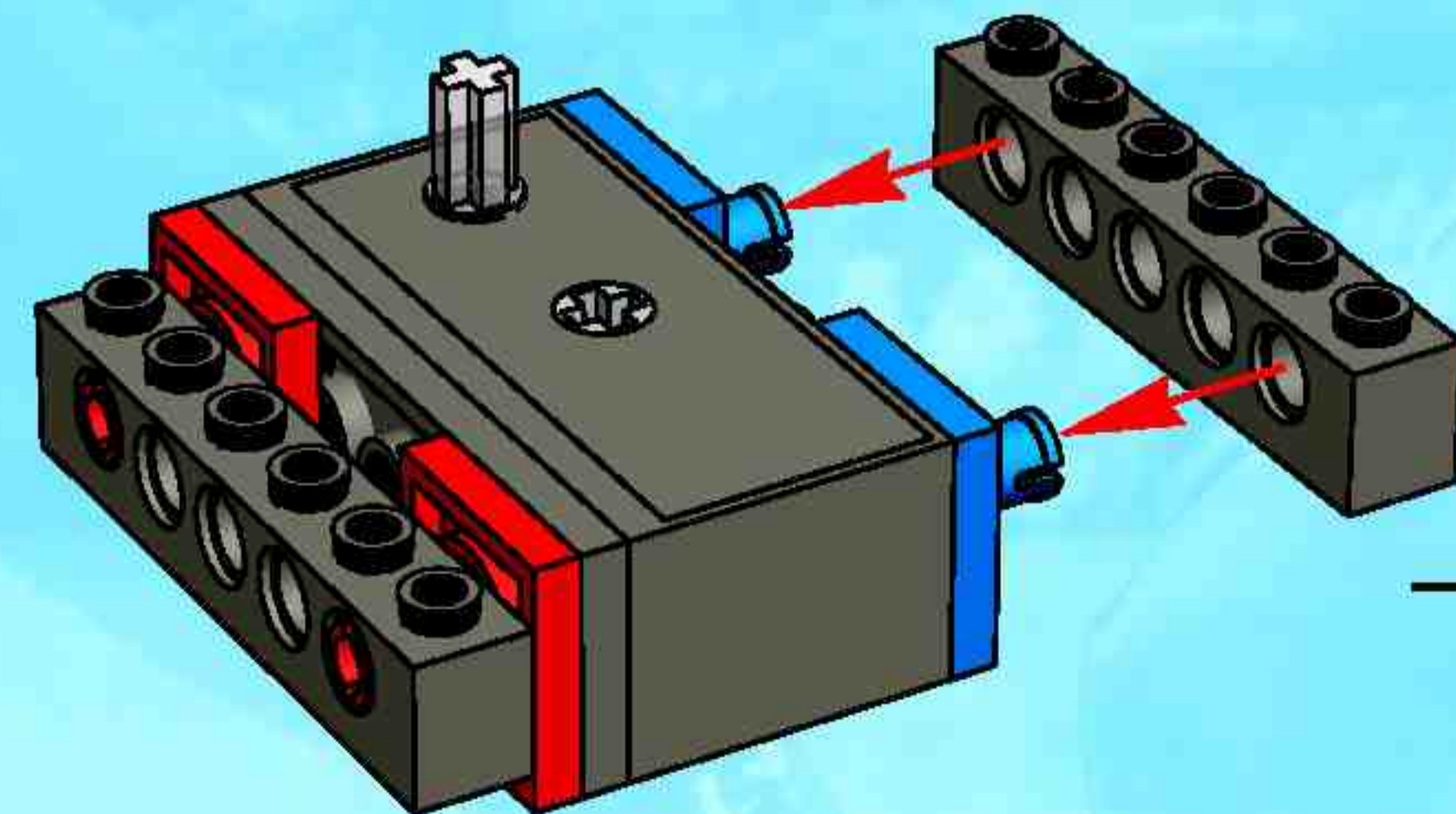

5

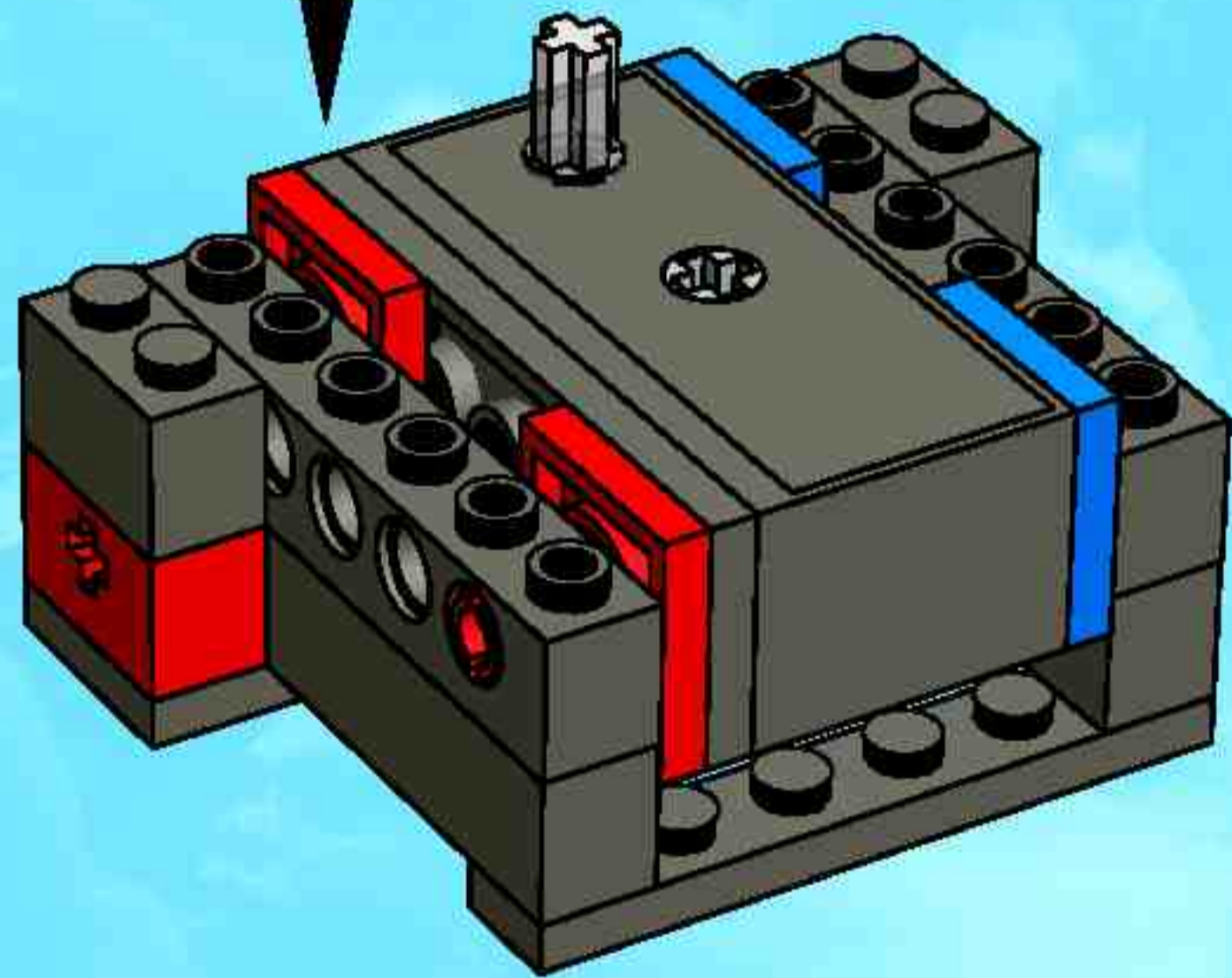

6

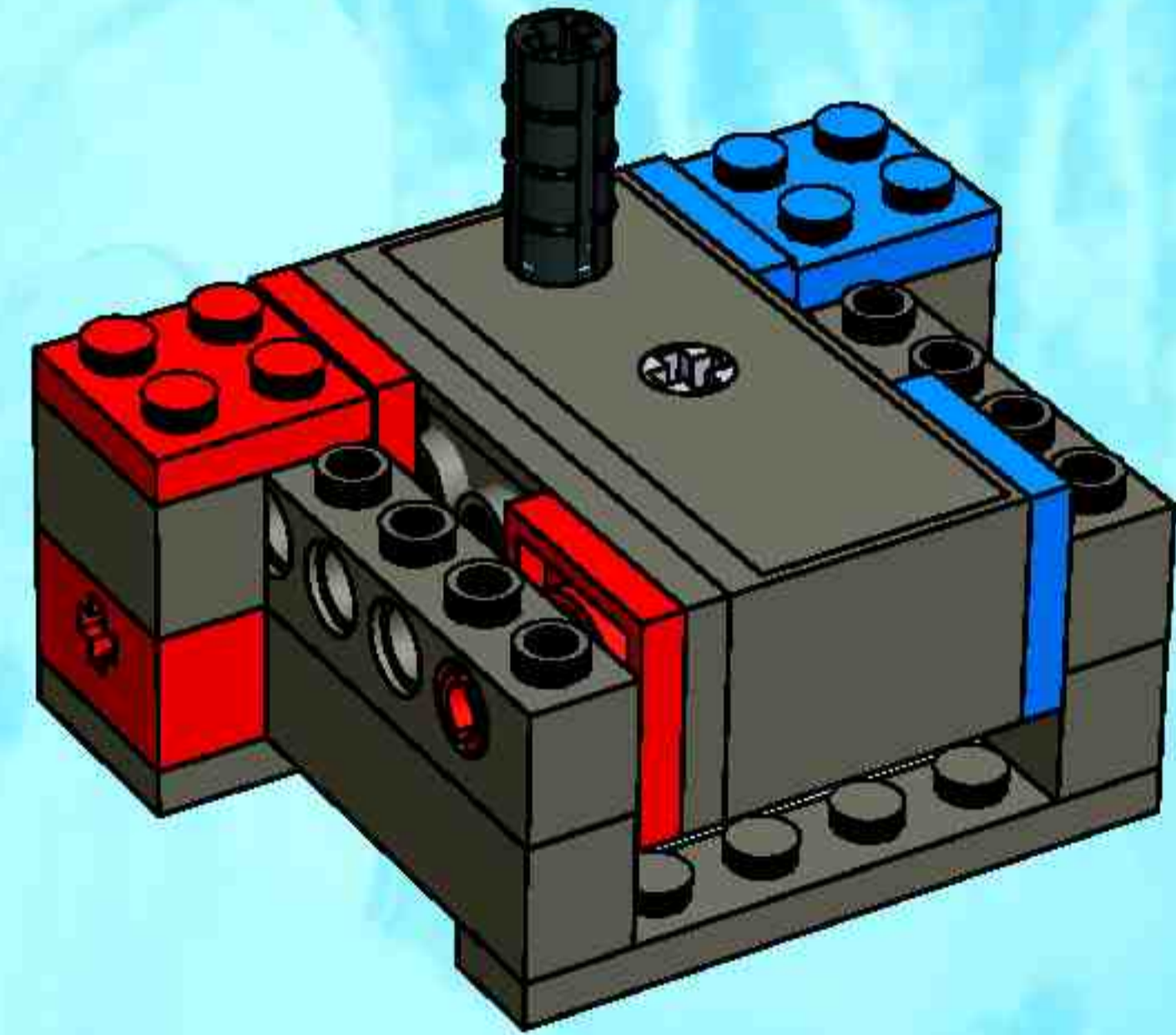

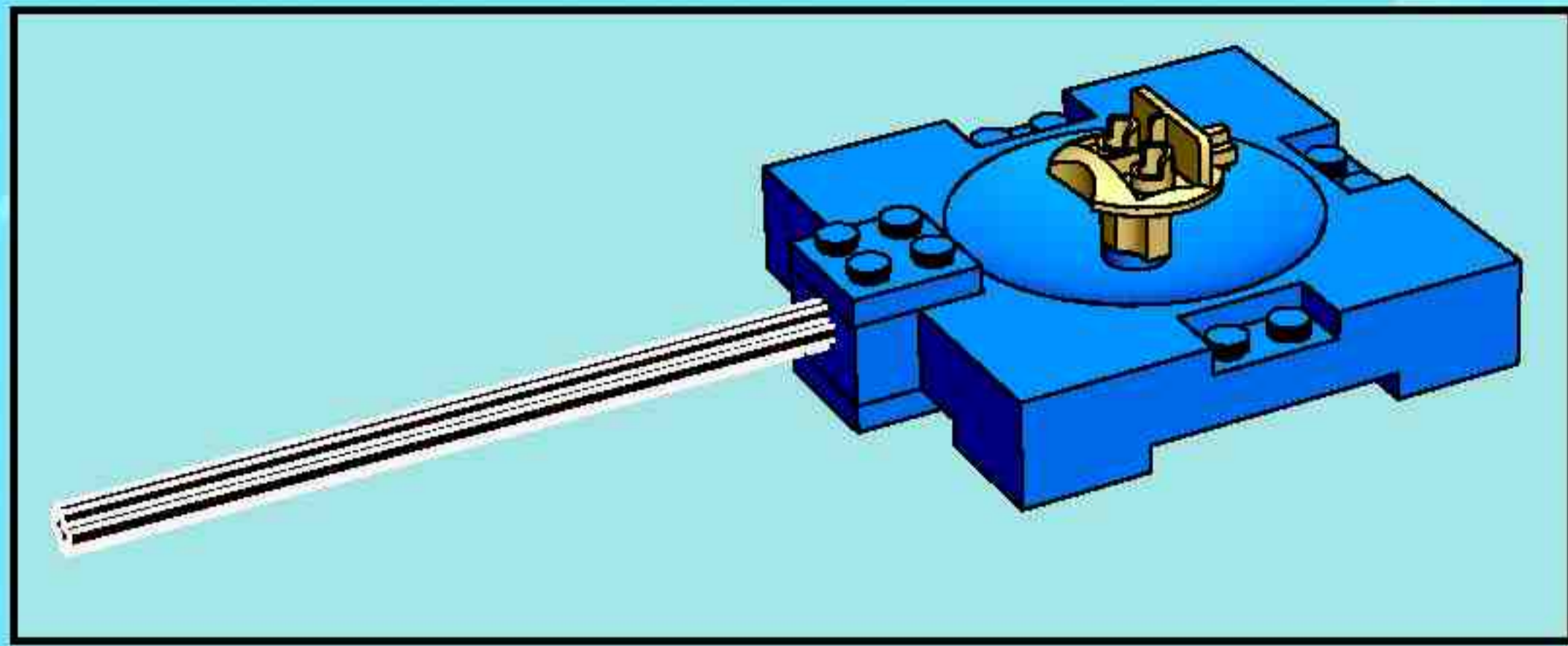

1

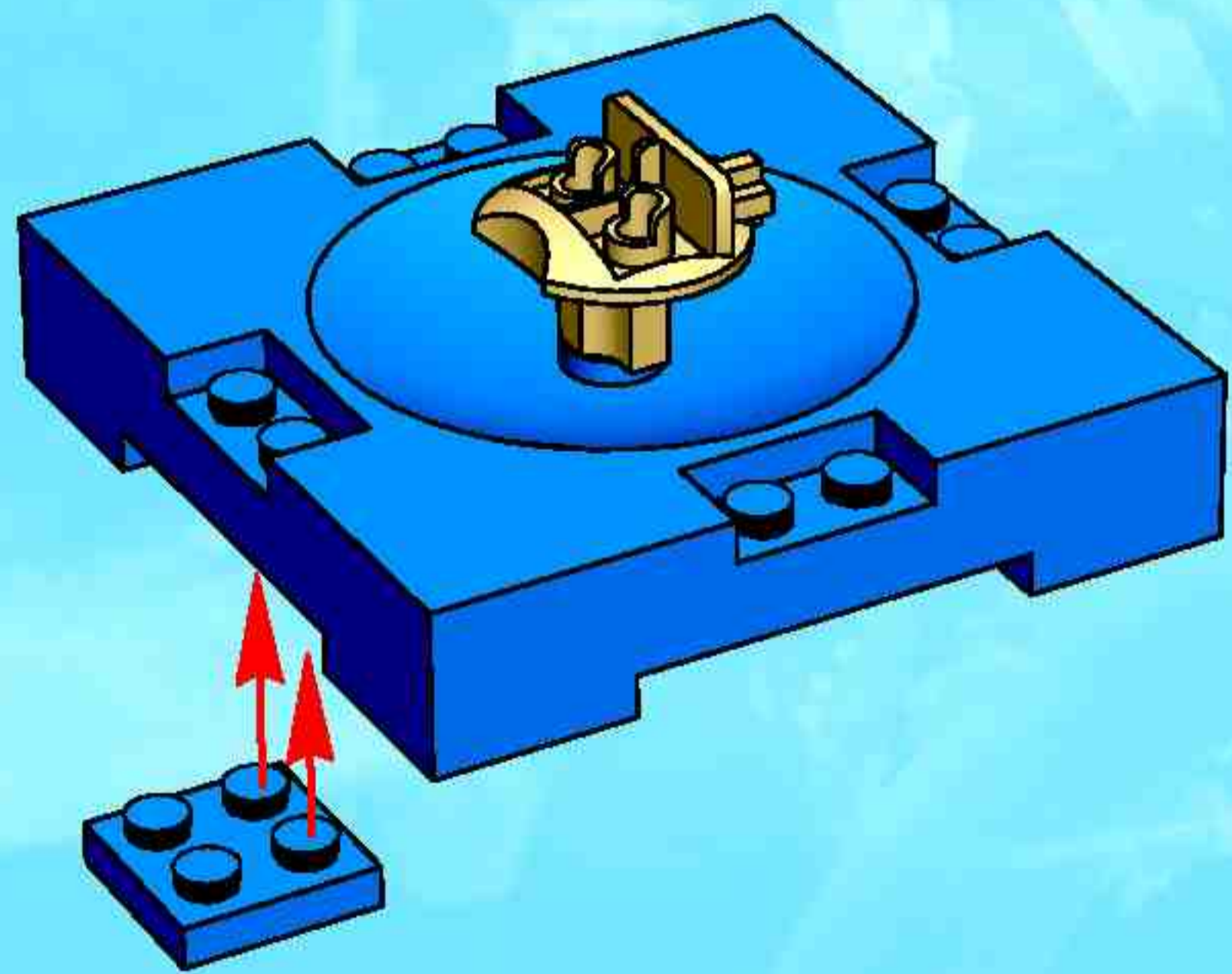

2

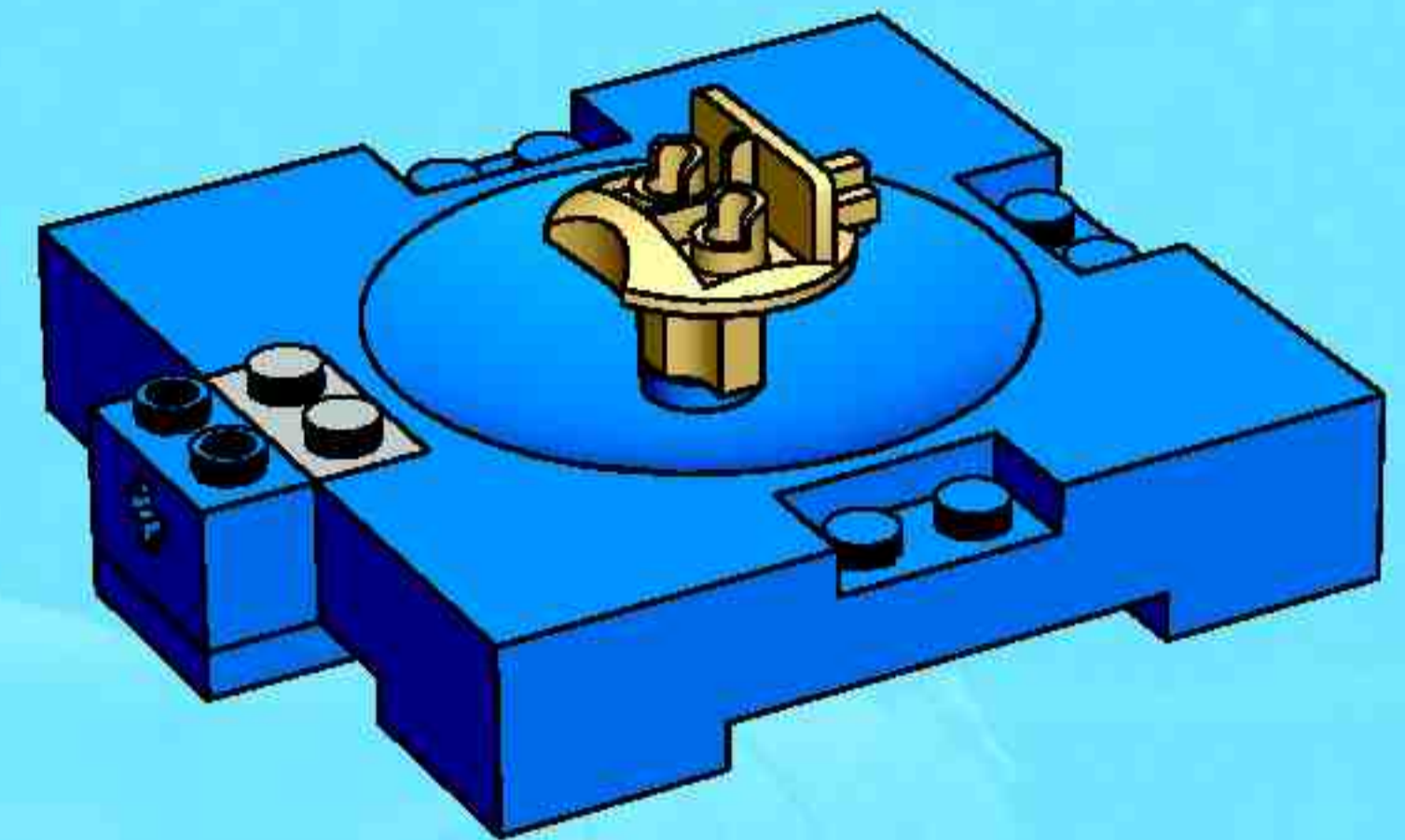

3

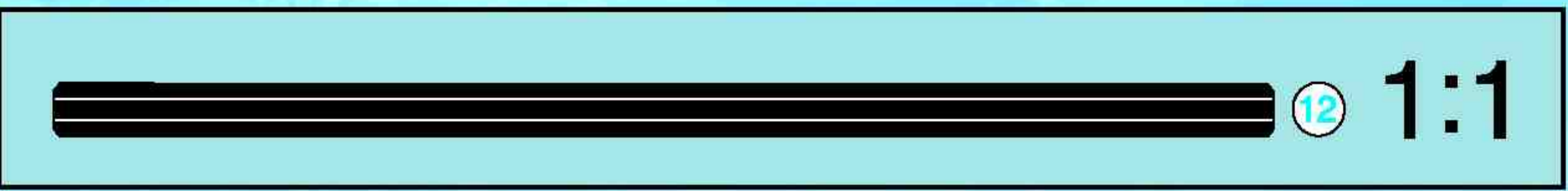
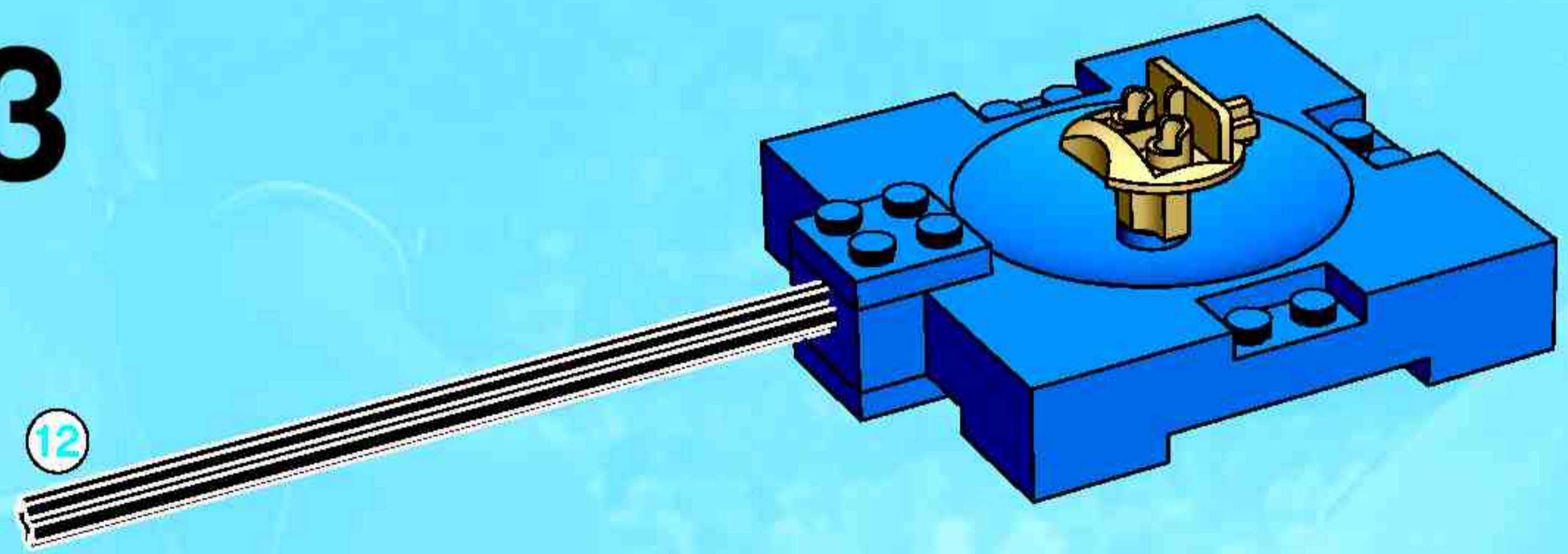

7

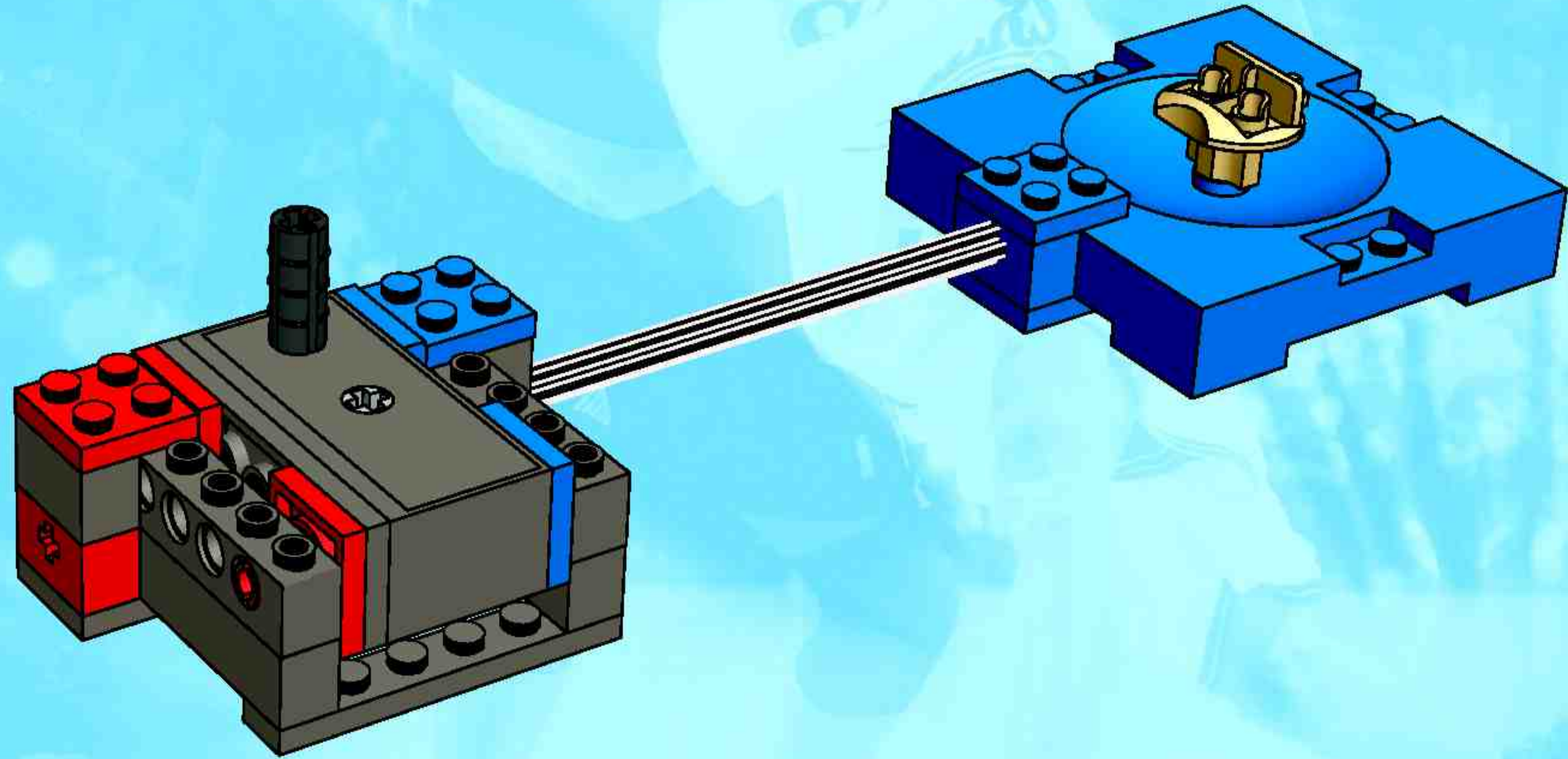

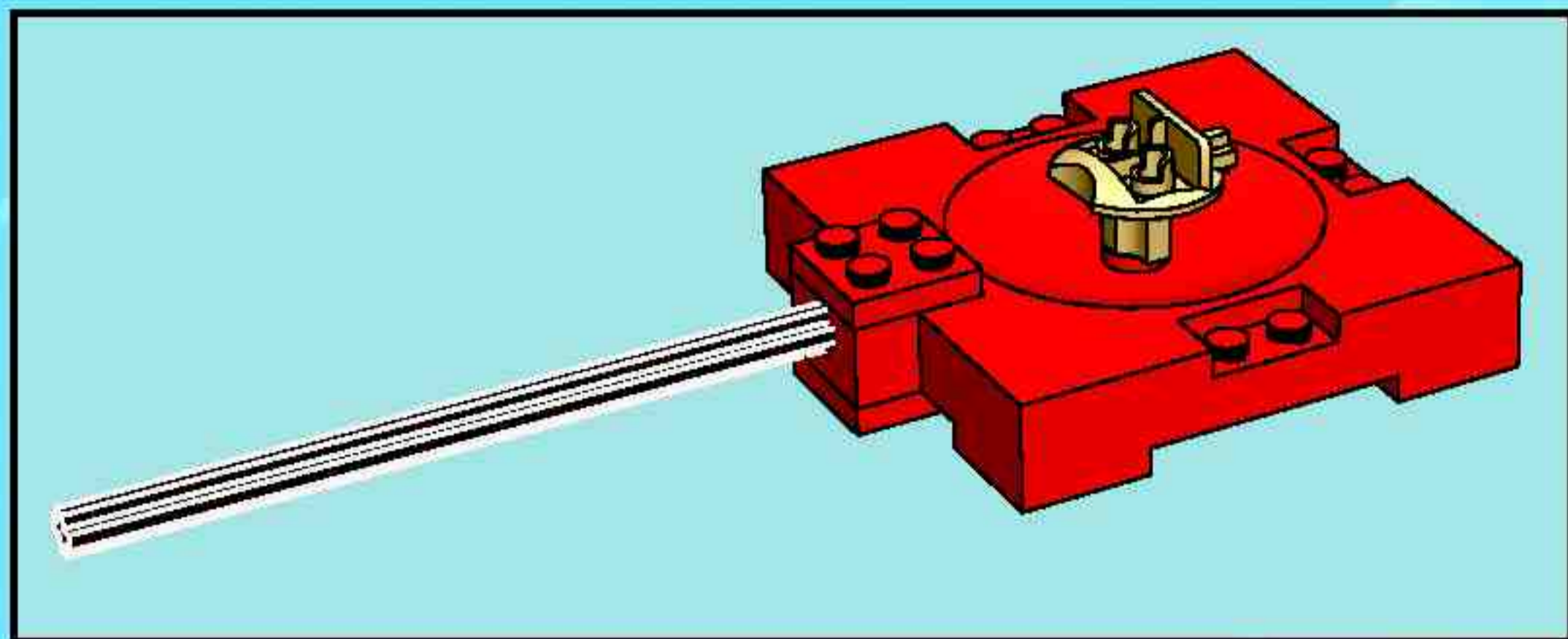

1

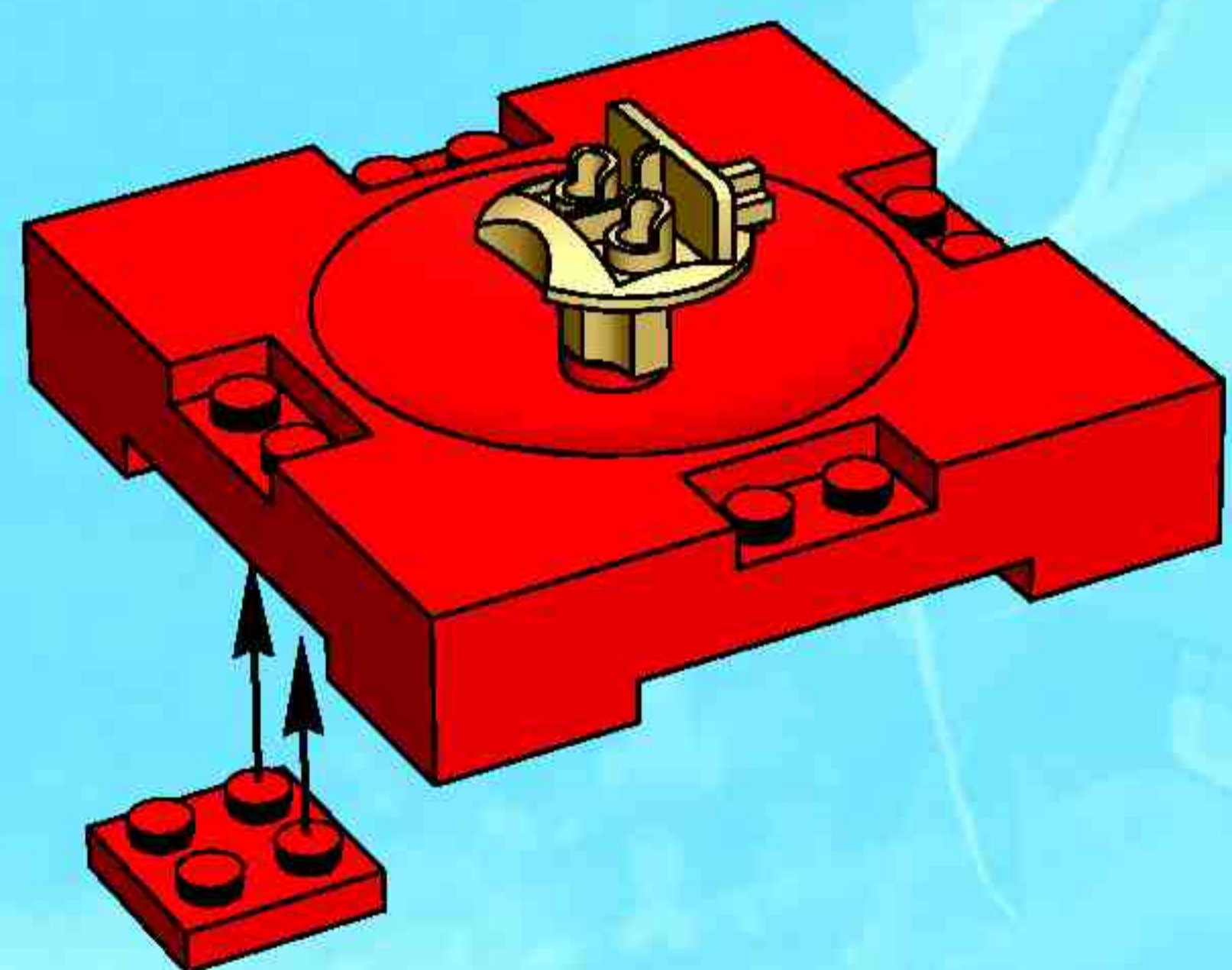

2

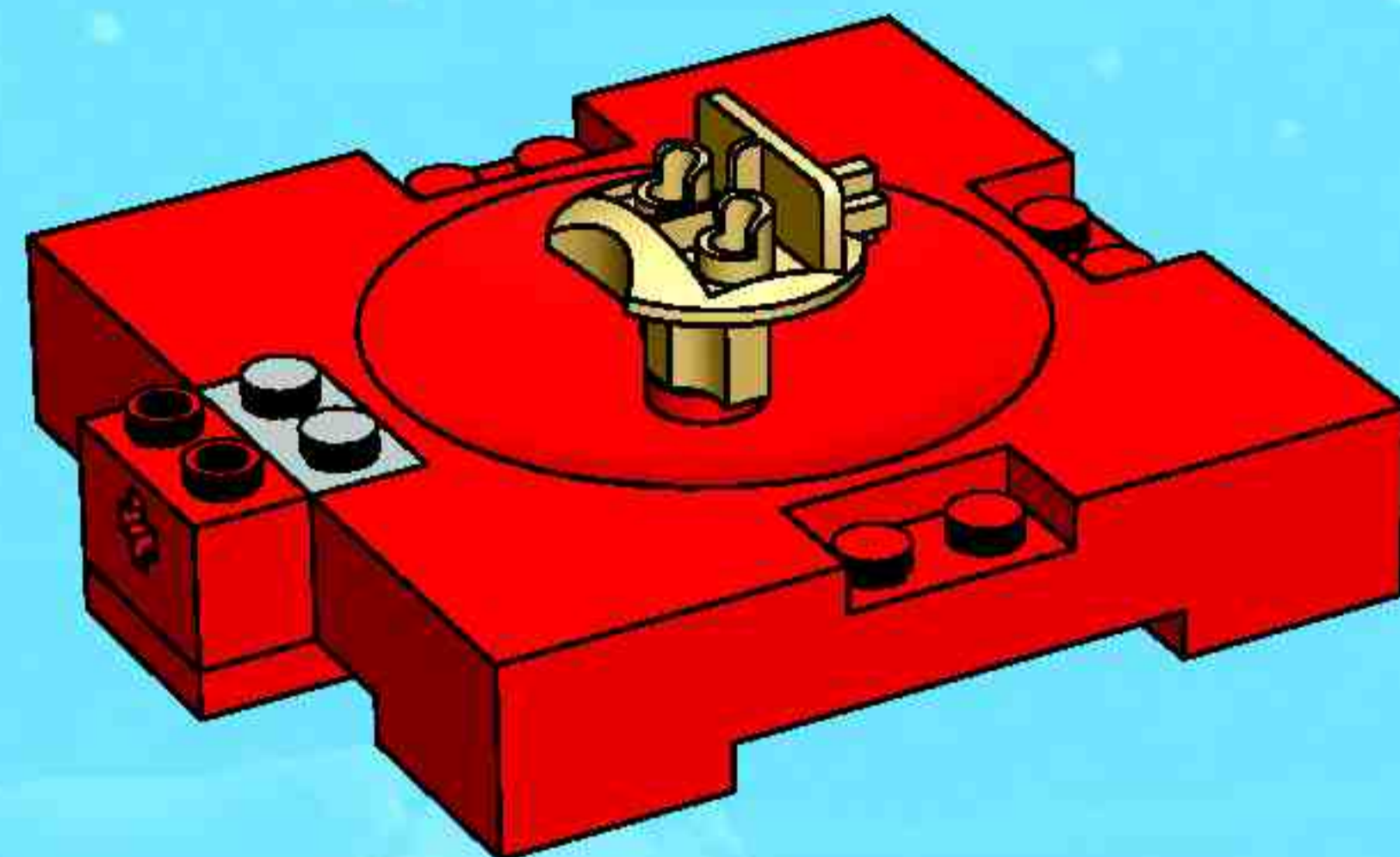

3

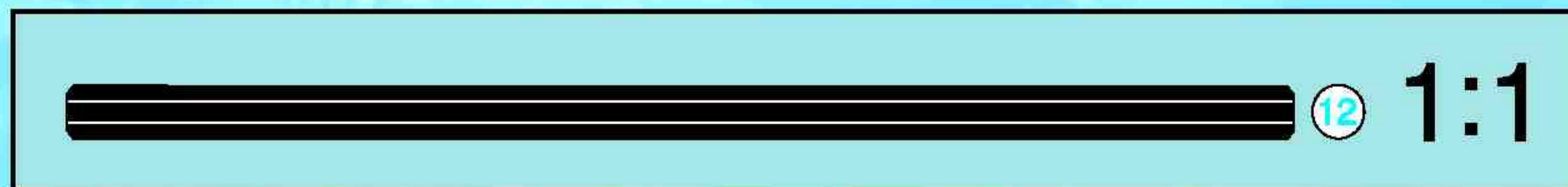
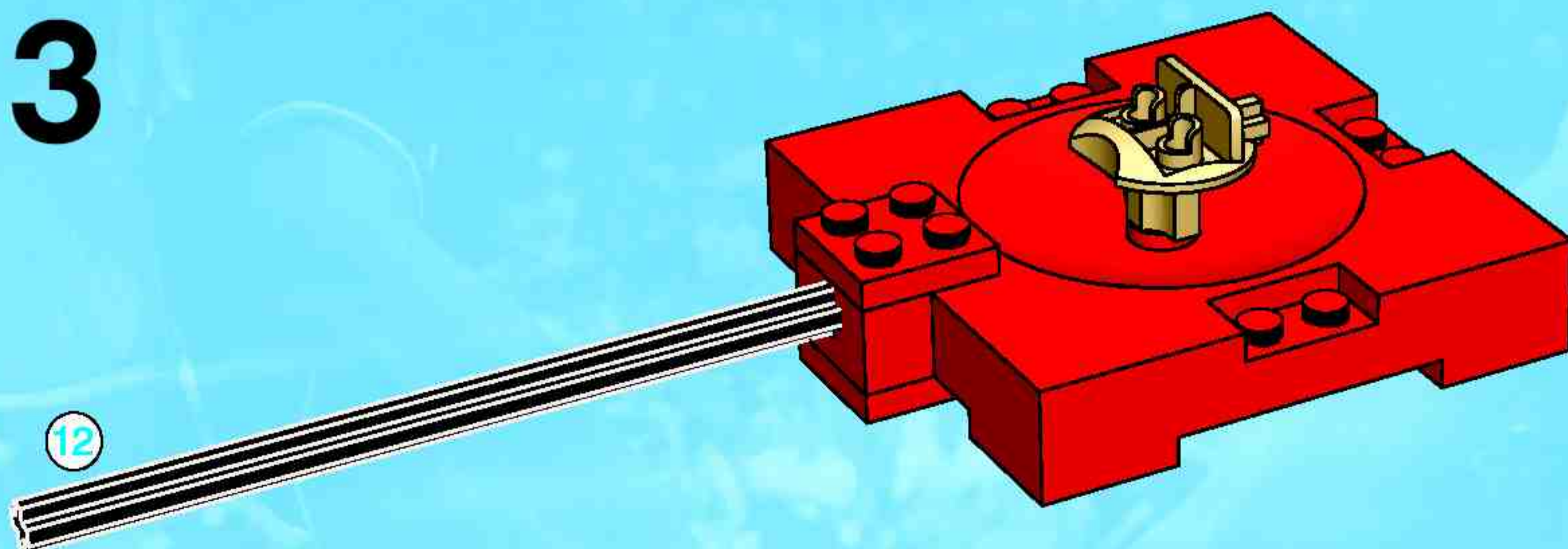

8

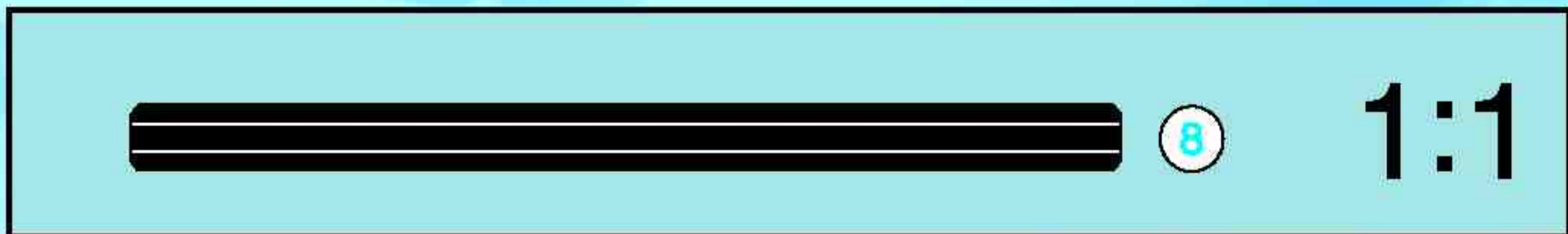
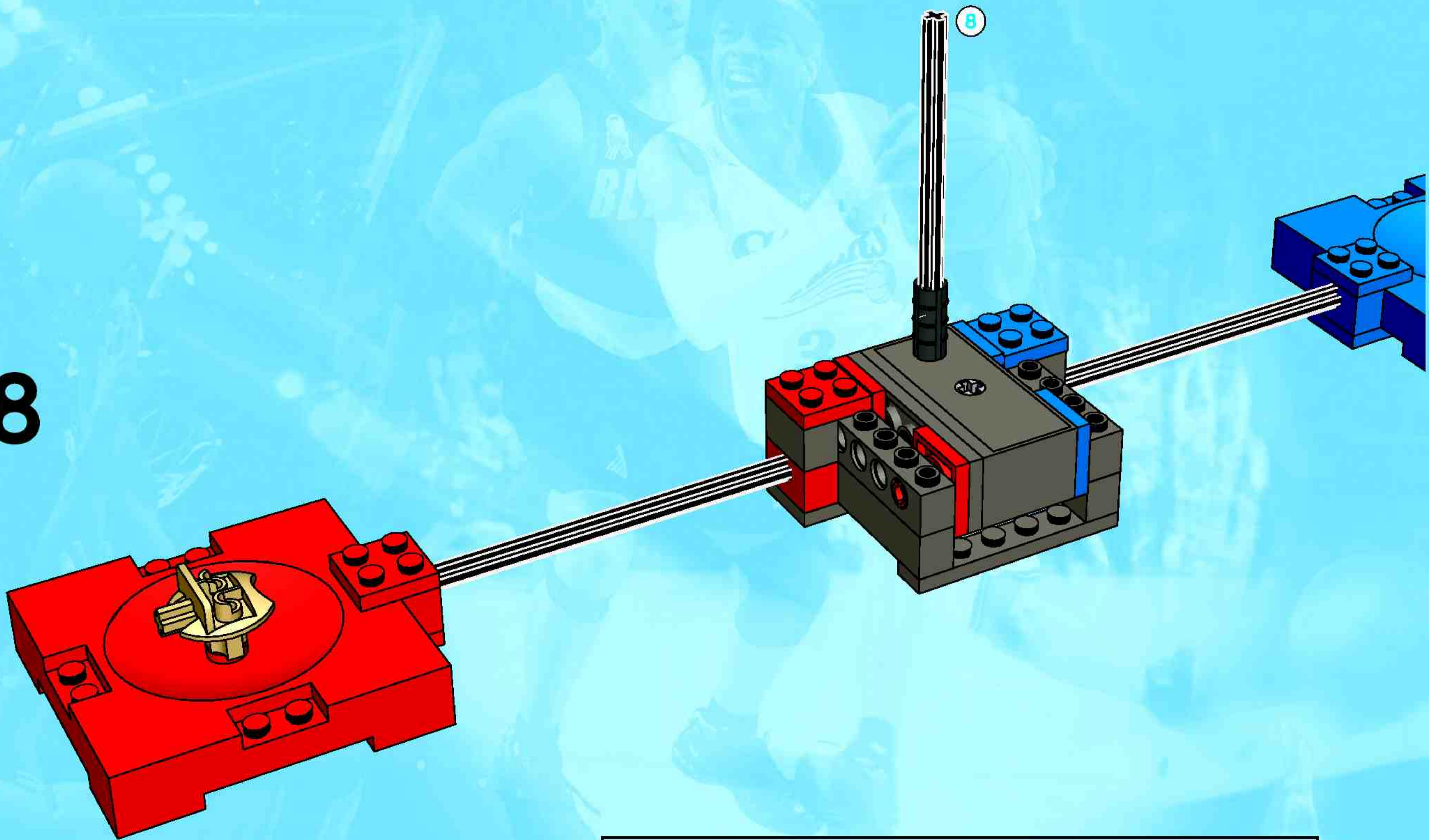

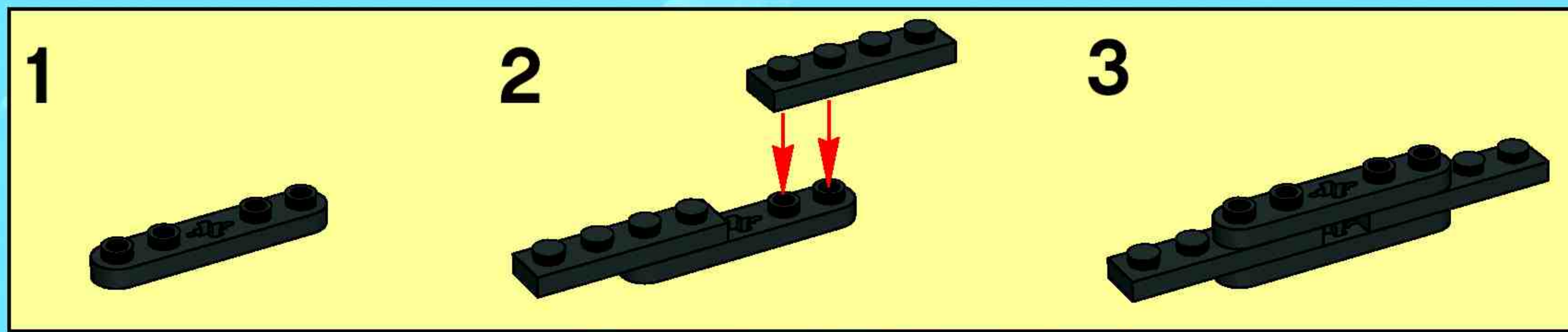

9

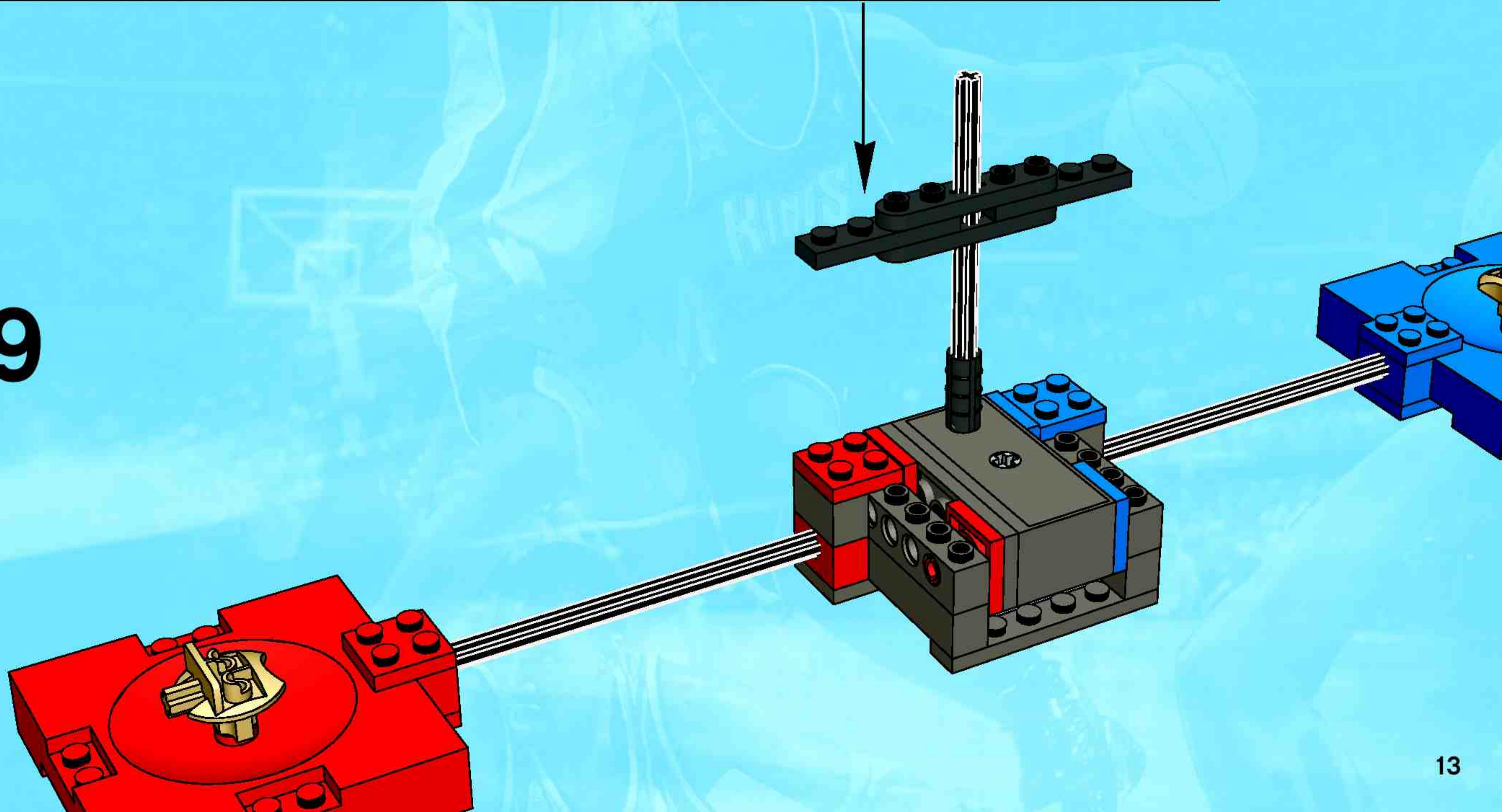

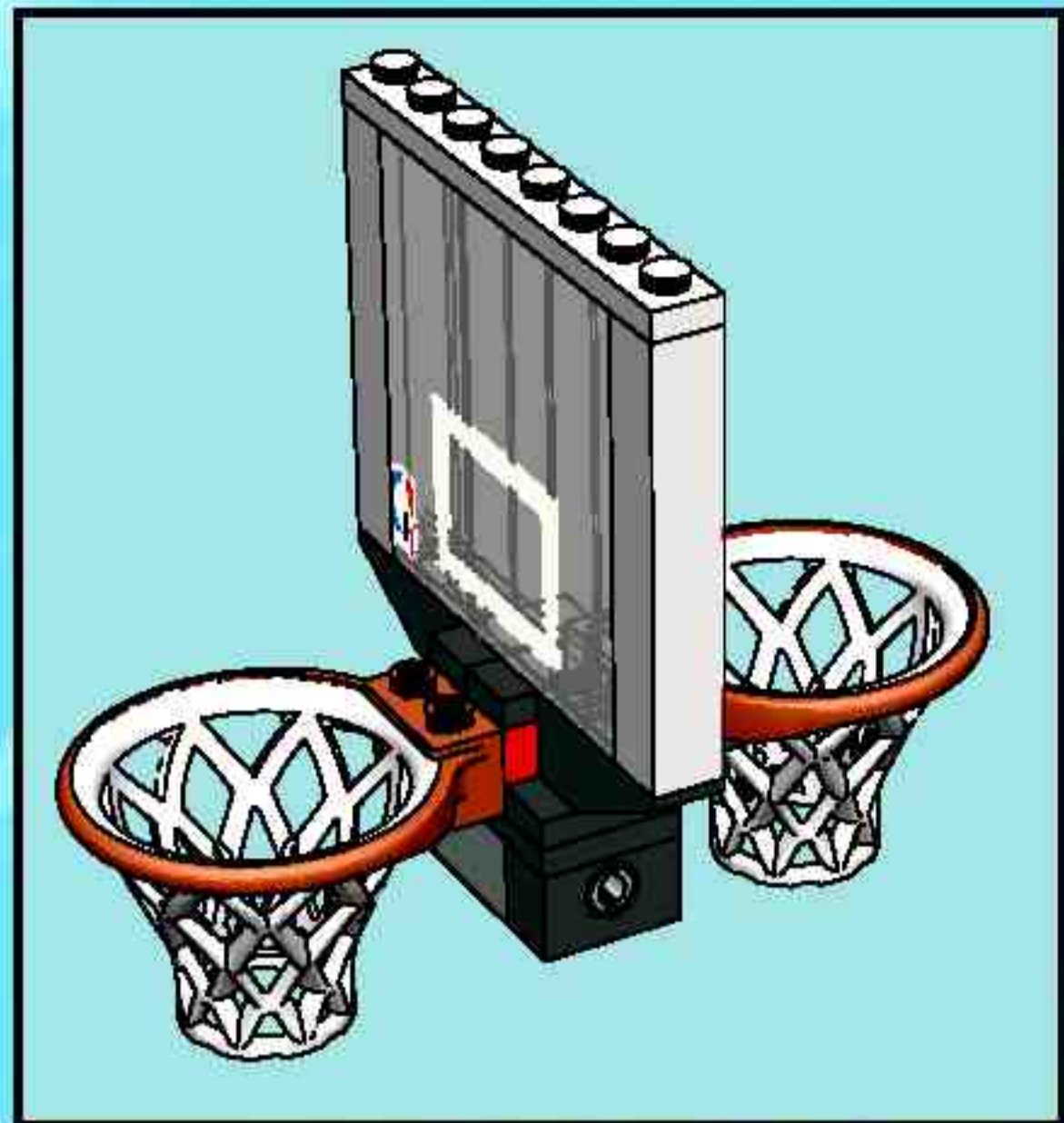

1

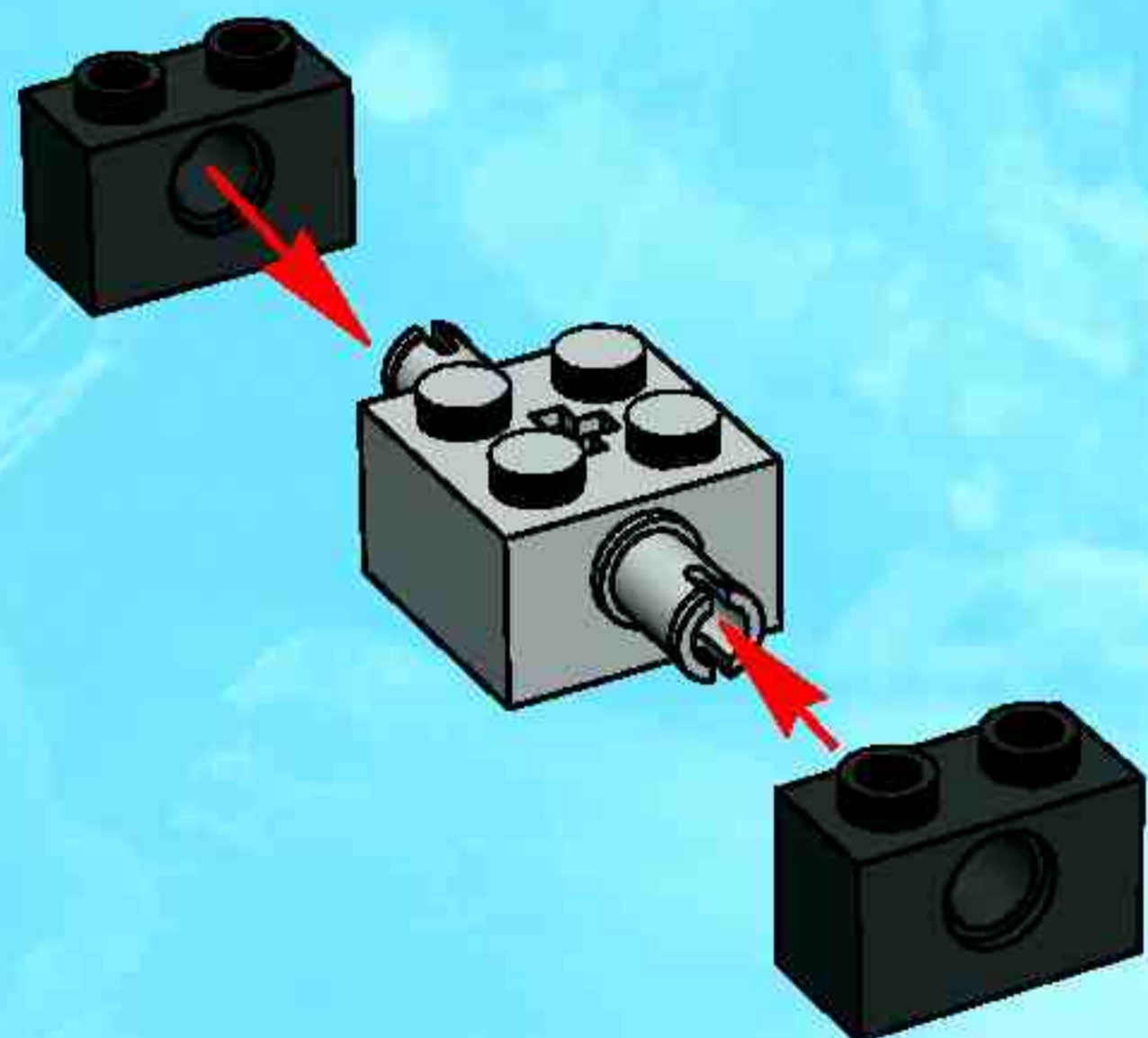

2



3

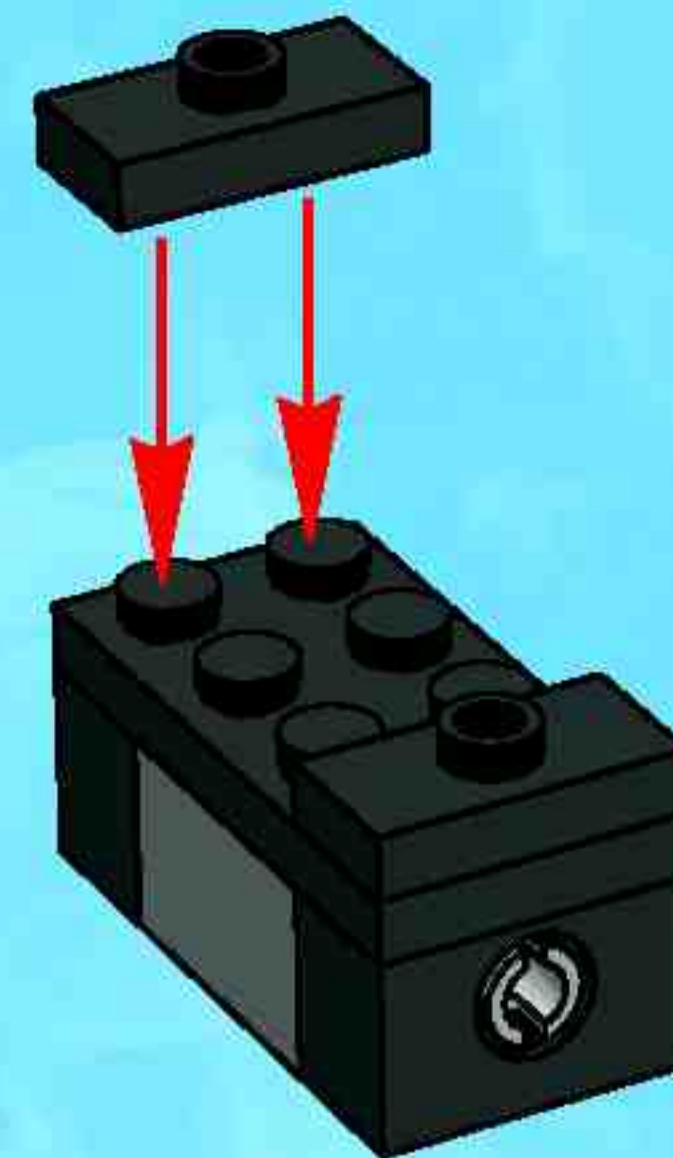

4

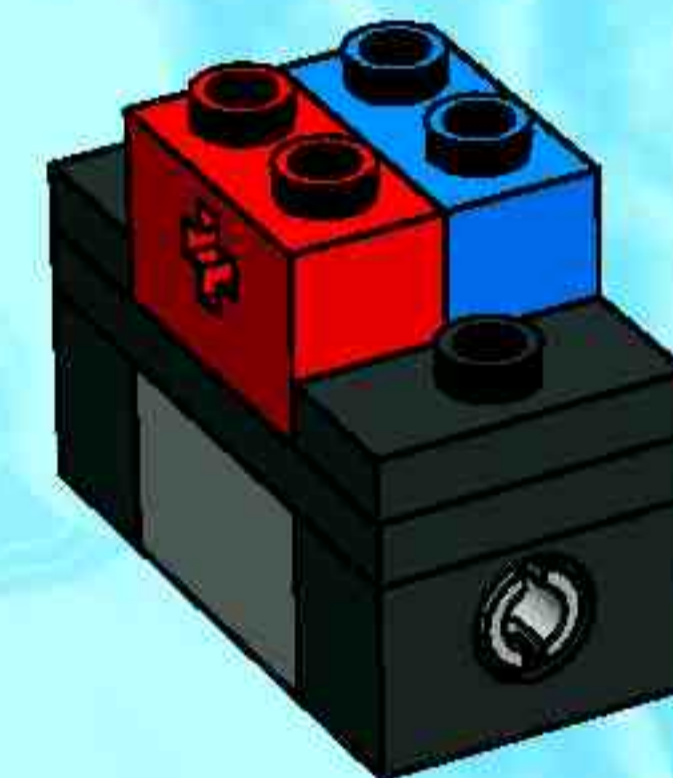

5

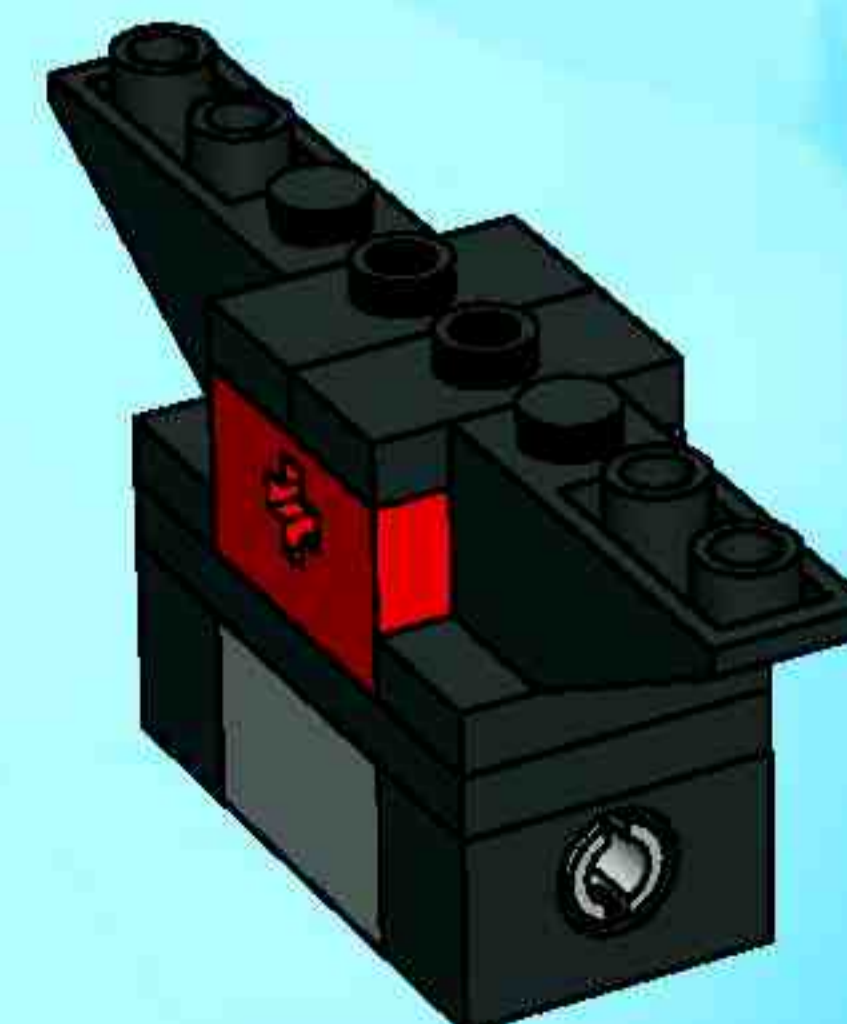

6

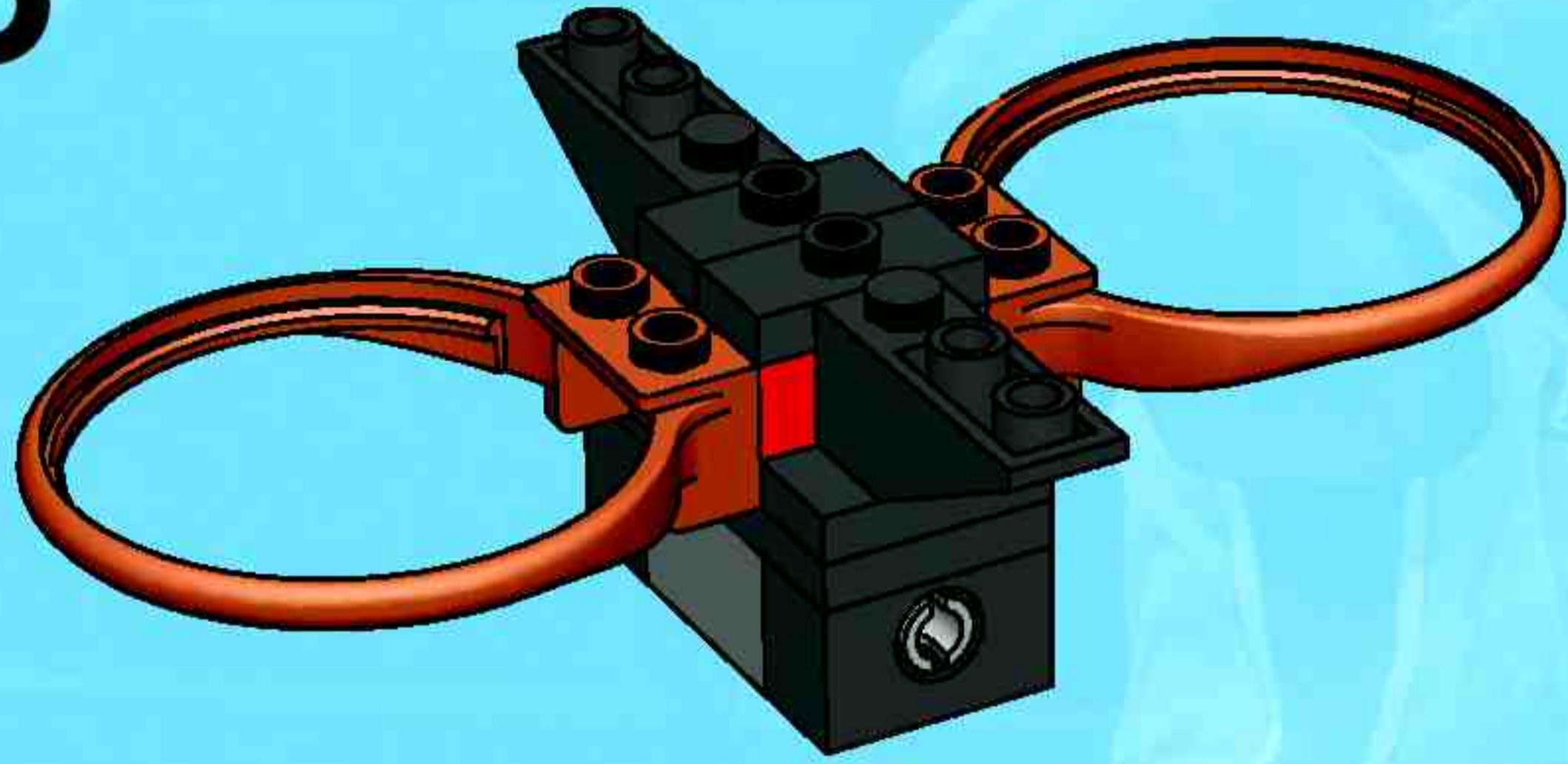

7

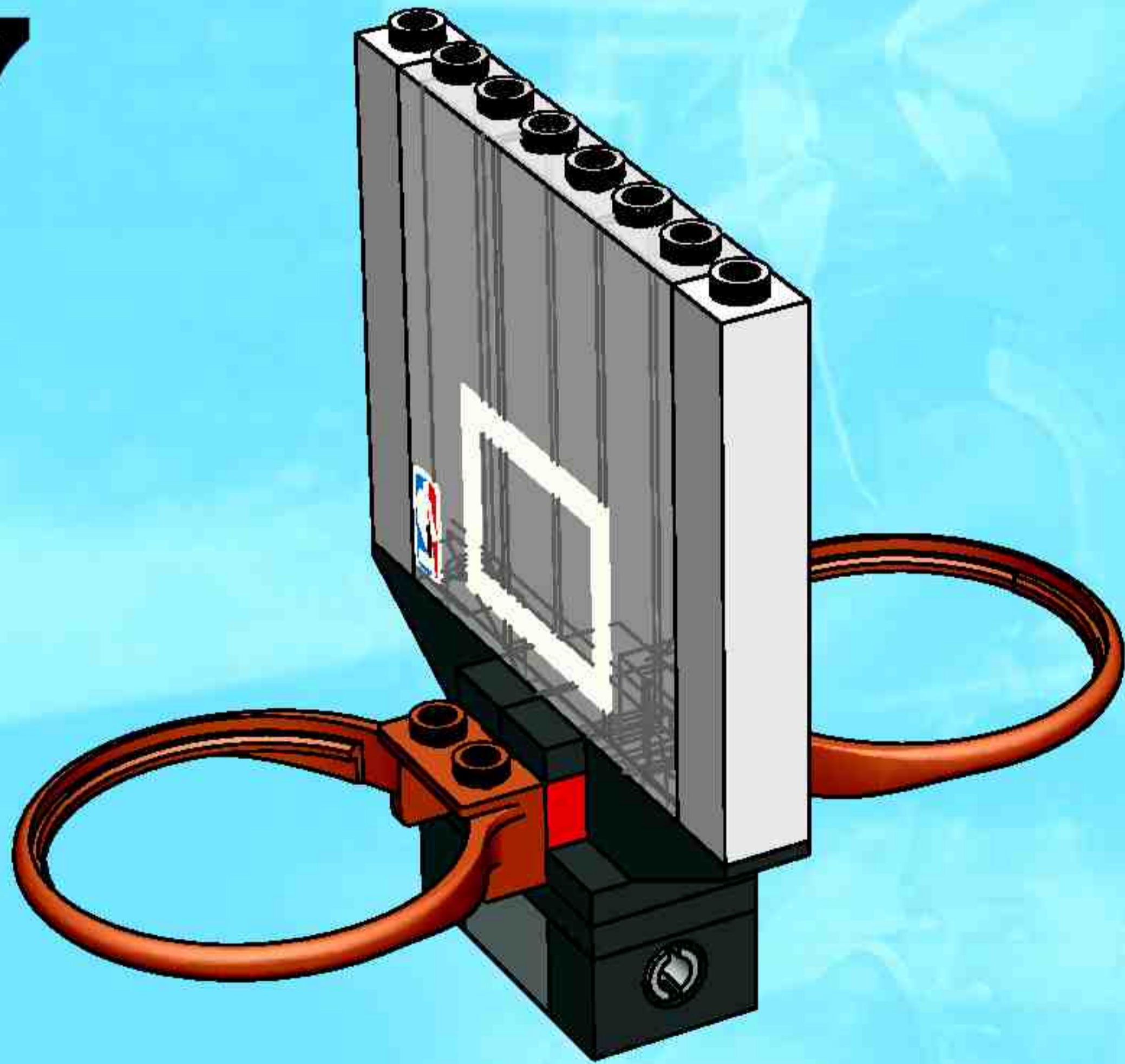

8

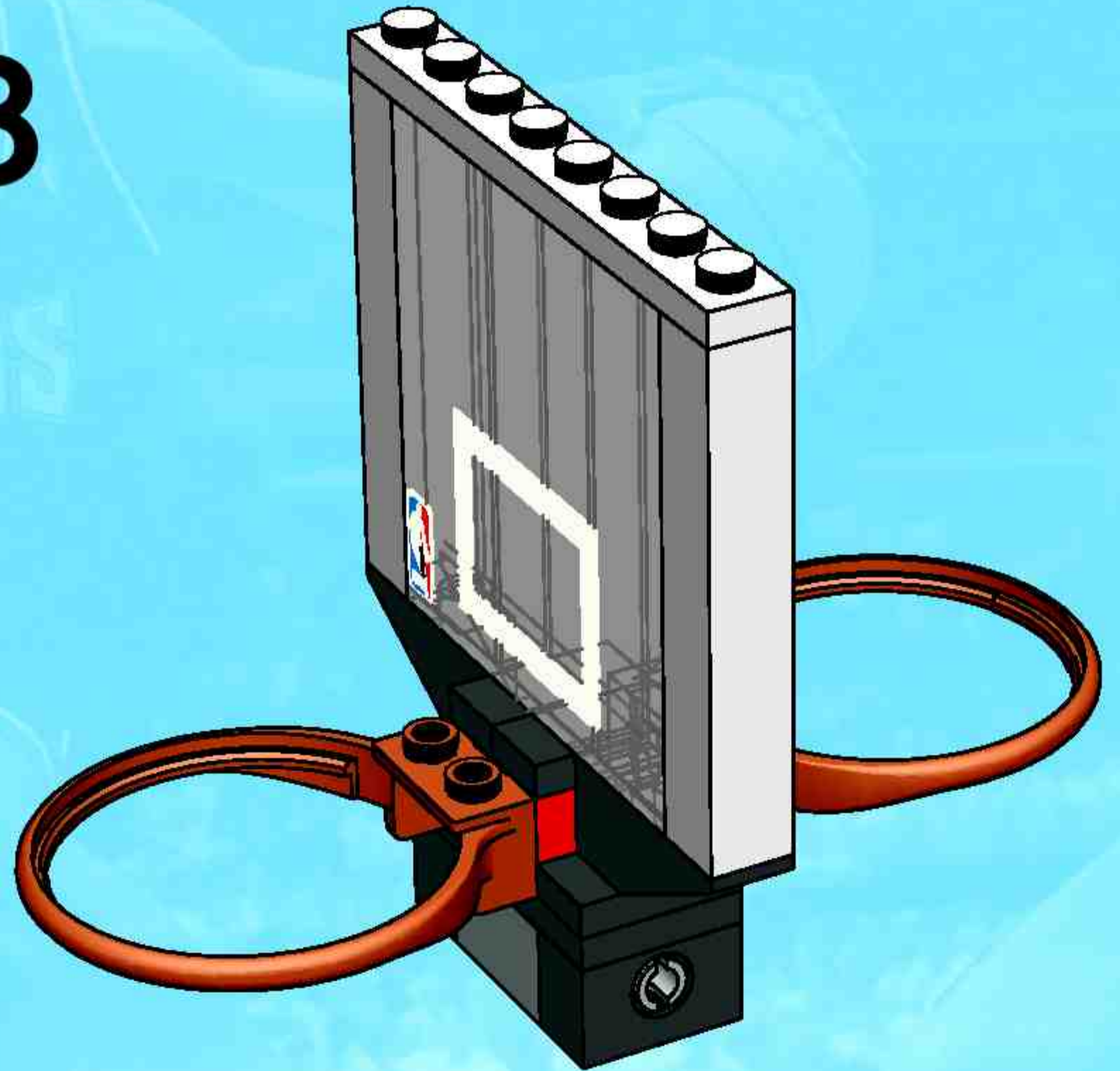

9

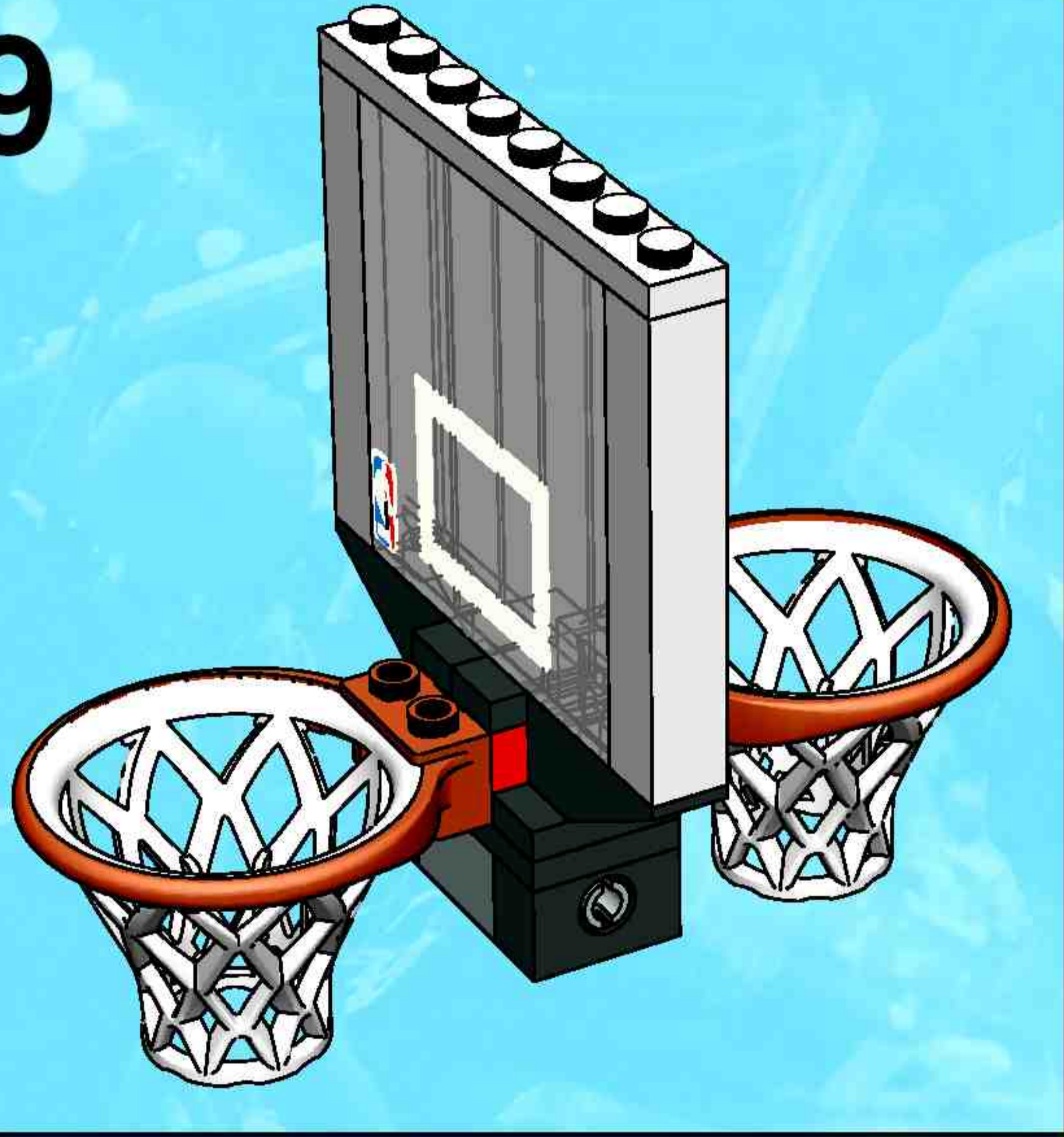

10

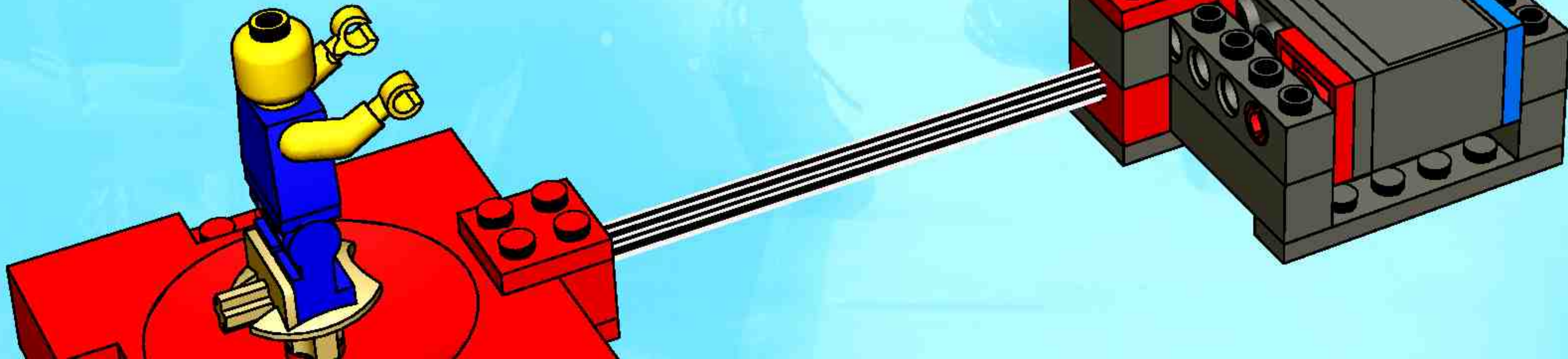

11

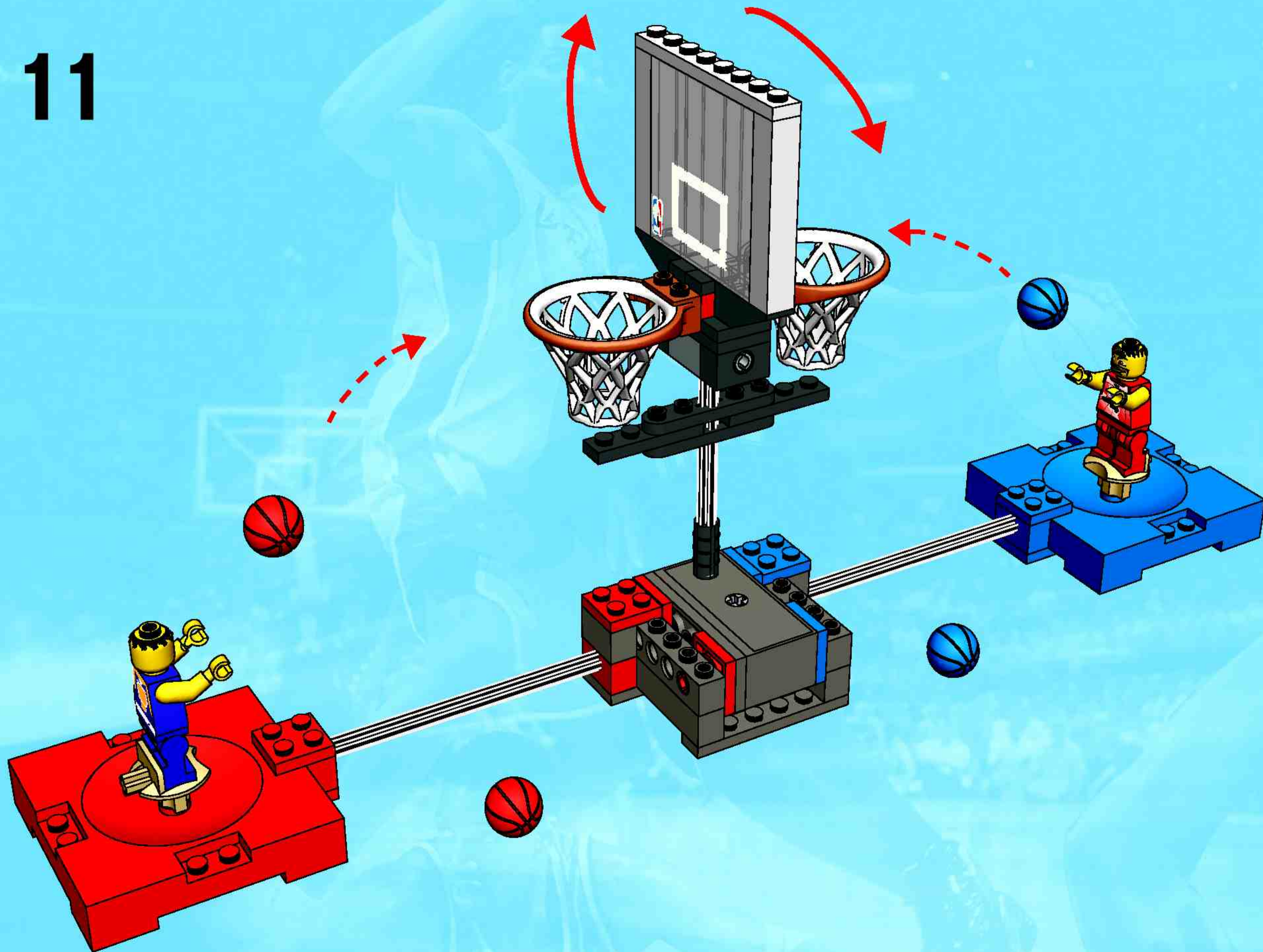



www.LEGO.com

NBA  **.COM**

 **NBA**



#3428



1

3431+3430

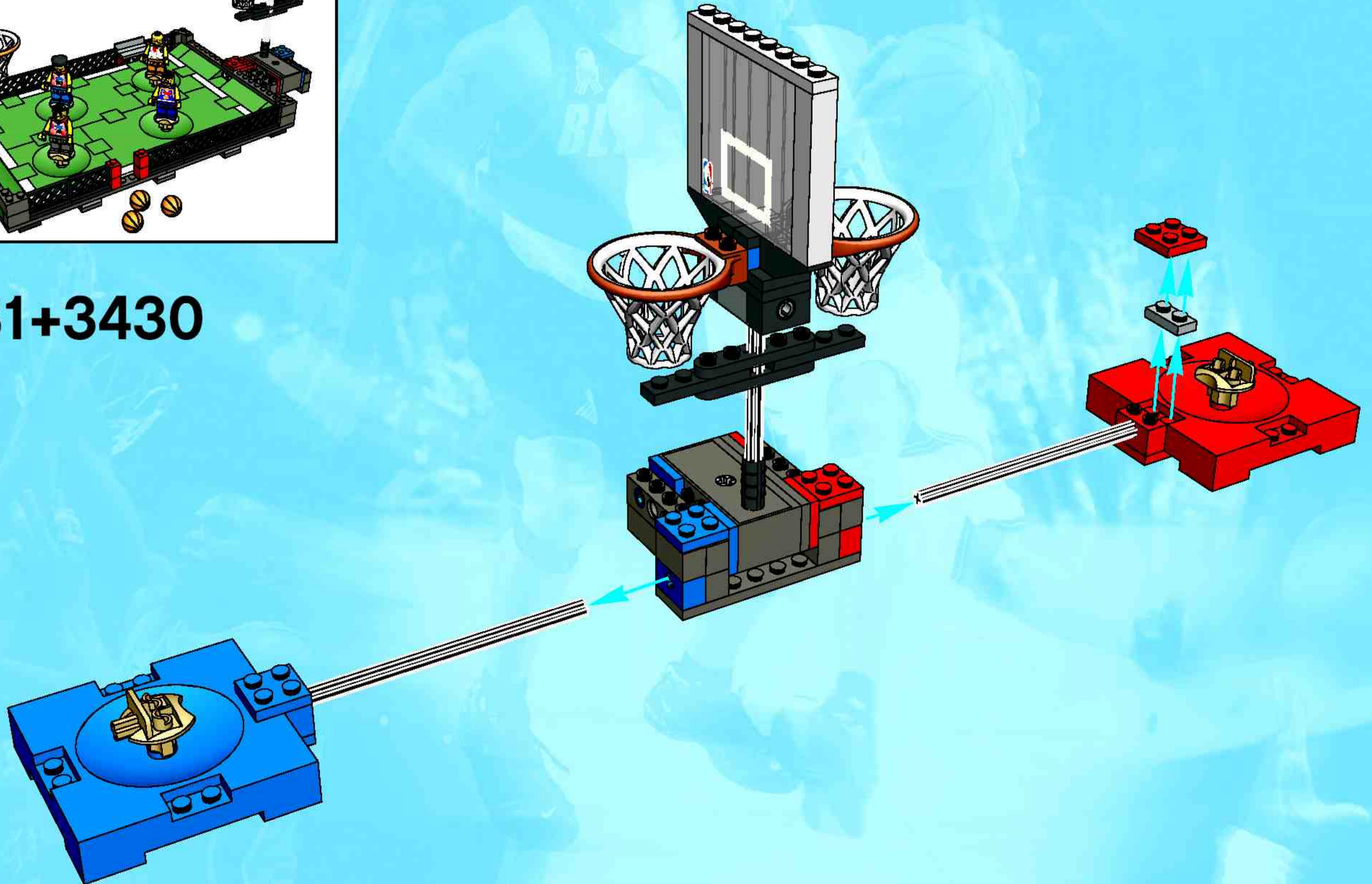

2



3



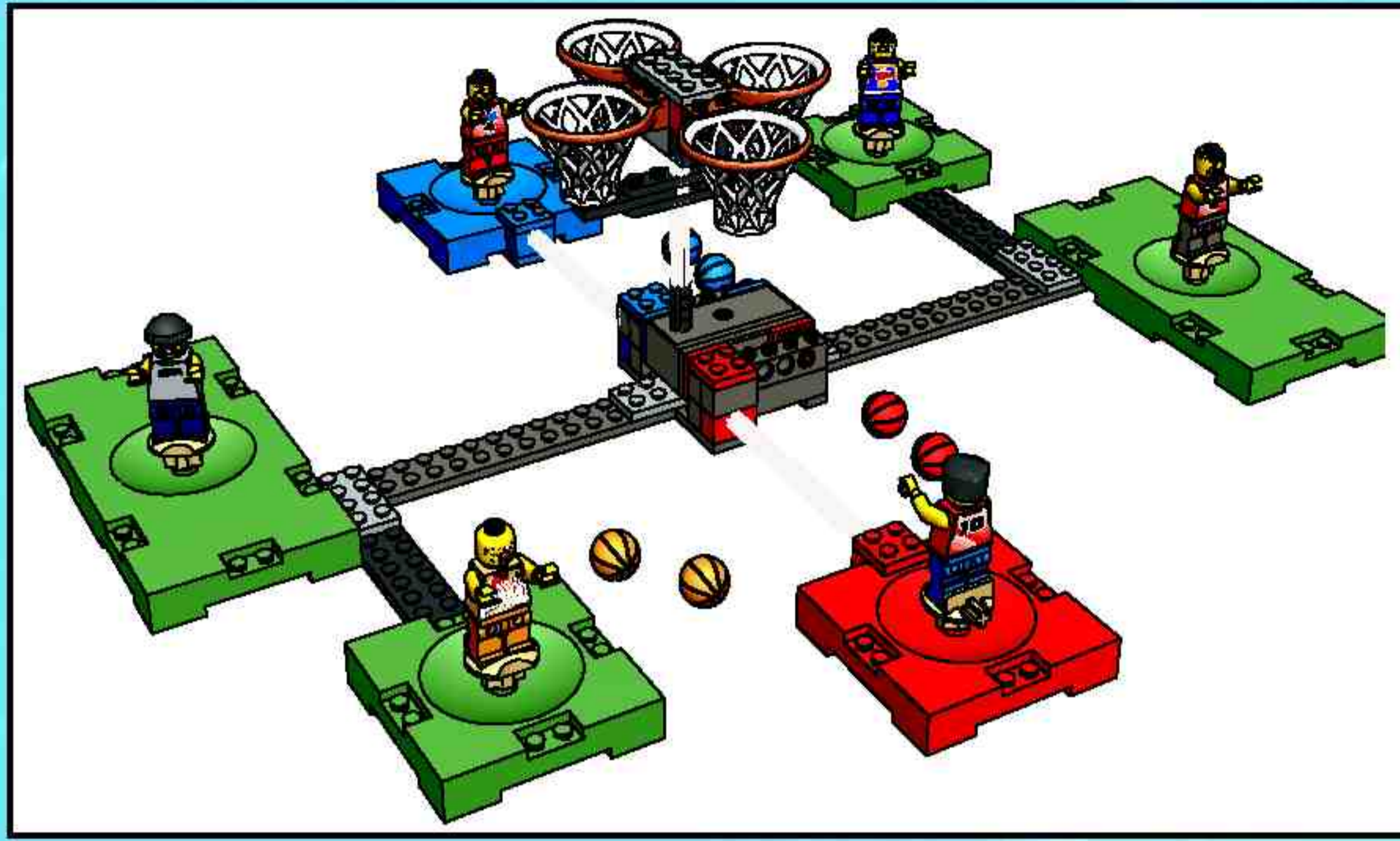

1

3431+3430

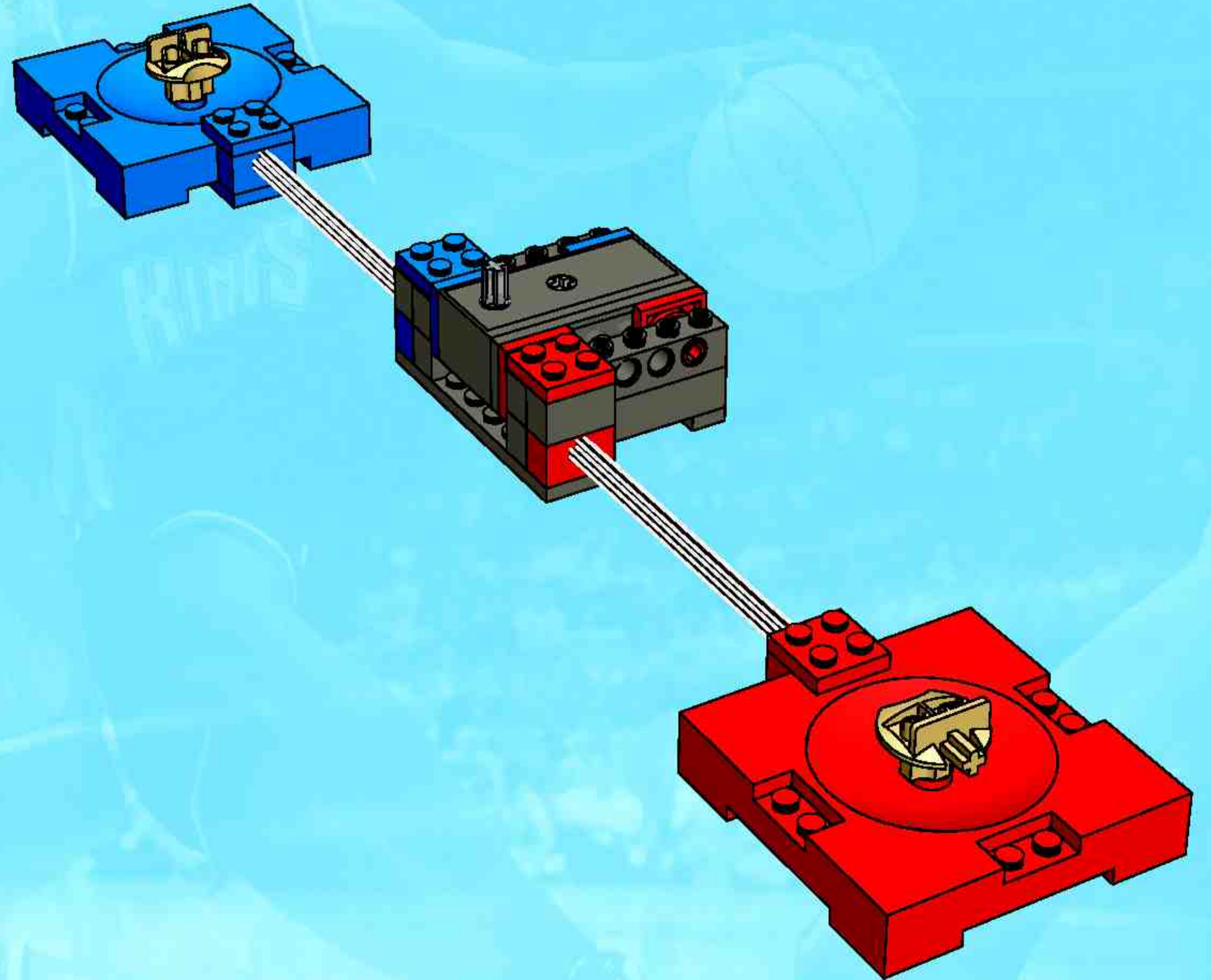

1

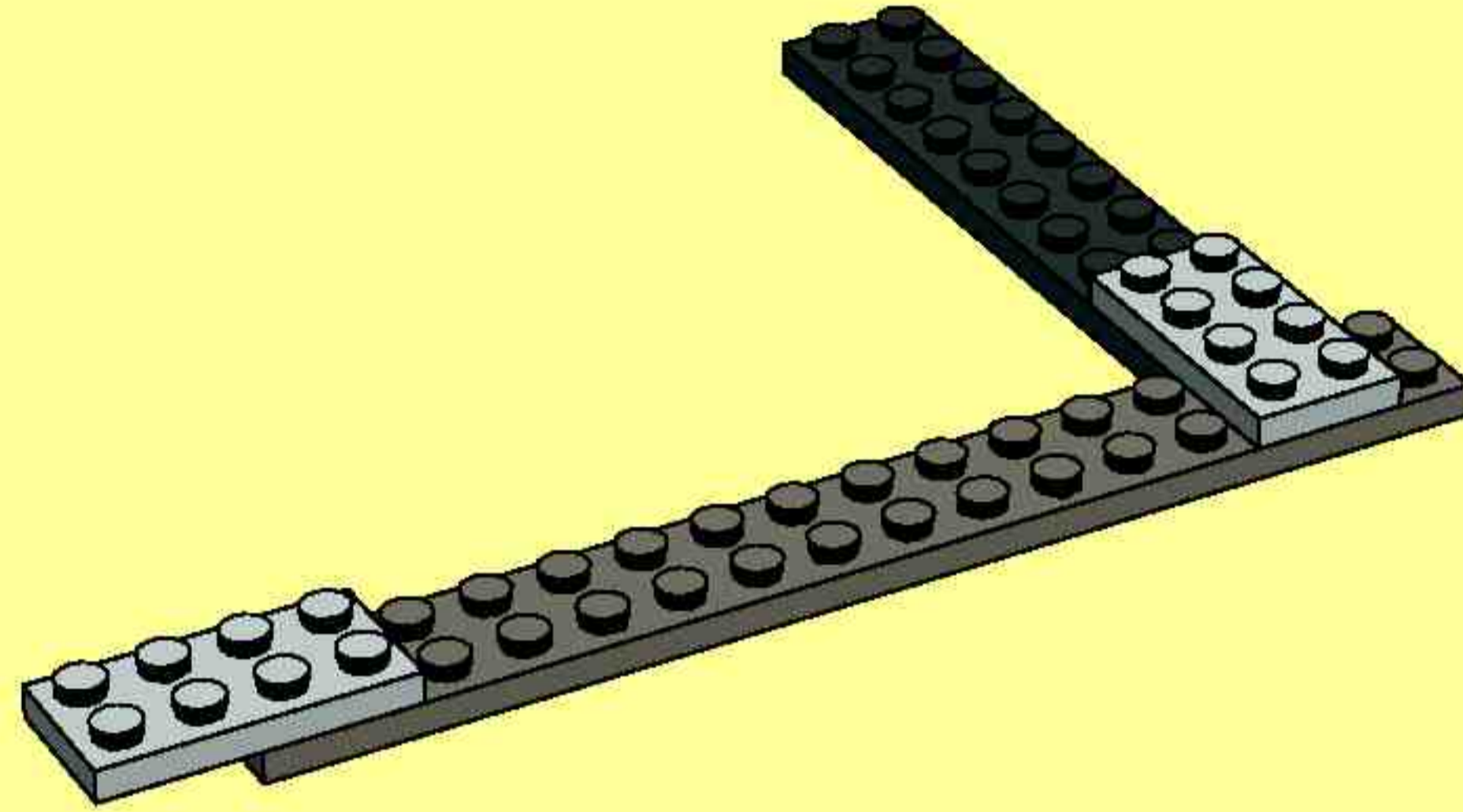

2

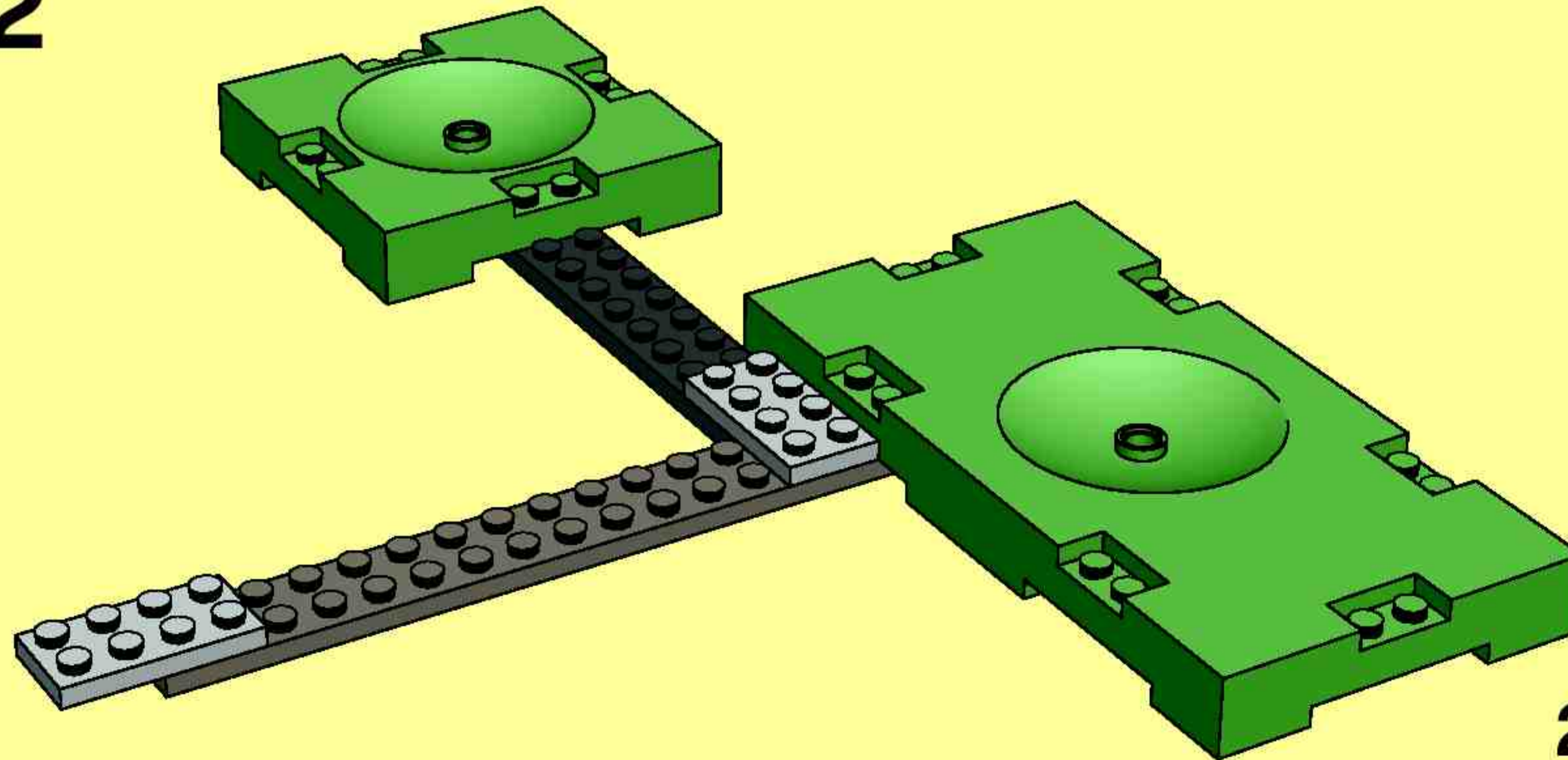

2x

2

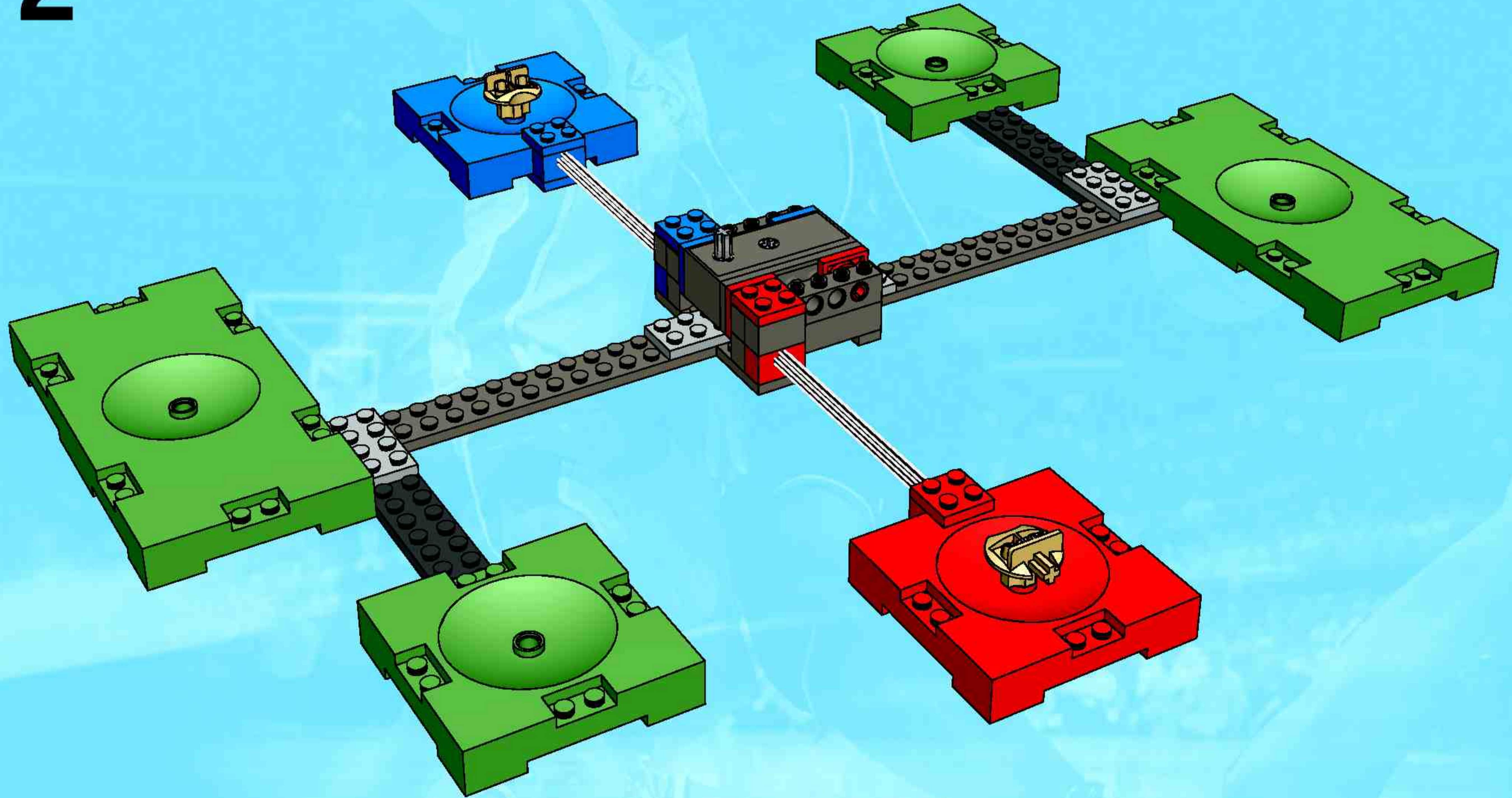

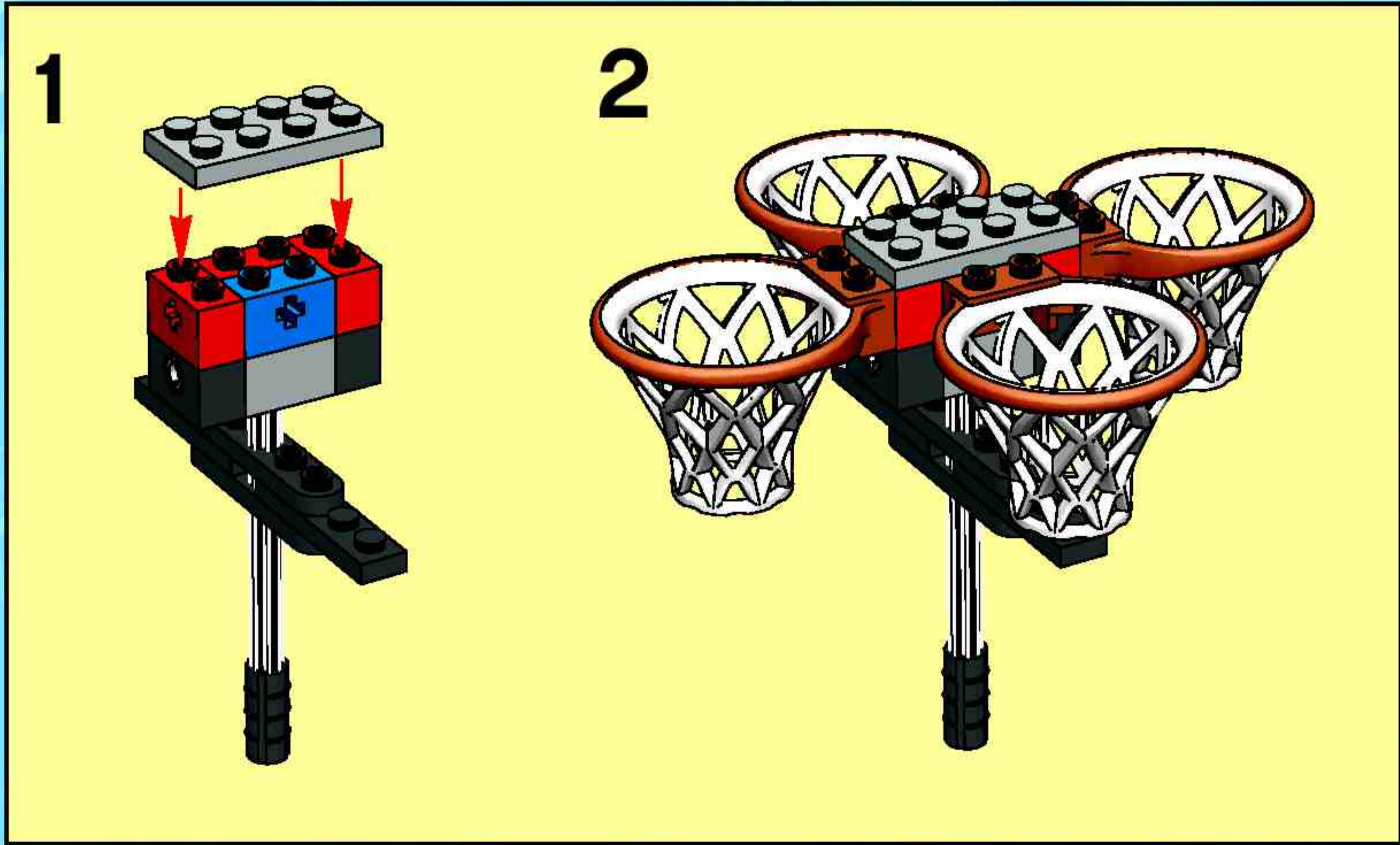

3

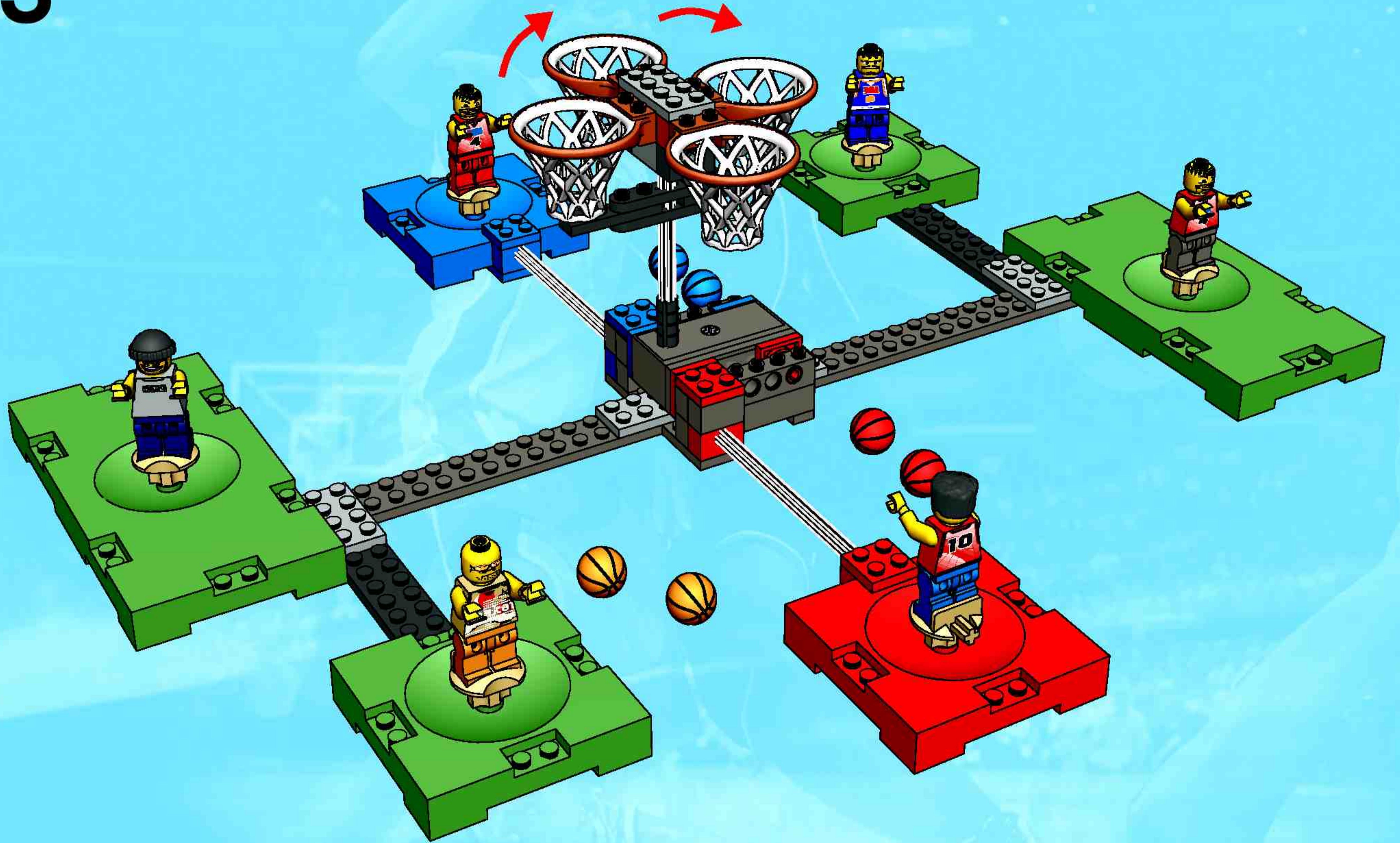



adidas, the adidas logo and the three stripe trademark are registered trademarks of the adidas-Salomon group, used with permission. Fevernova and the Trigon logo are trademarks of the adidas-Salomon group, used with permission.



www.LEGO.com

SPALDING is a trademark of Spalding Sports Worldwide, Inc. or Lisco Sports, Inc., a Spalding affiliate.
© Spalding Sports Worldwide, Inc. 2002

NBA identifications depicted are the exclusive property of NBA Properties, Inc. and/or the NBA Member Teams, and are used with permission.

LEGO and the LEGO logo are trademarks of the LEGO Group.
©2002 The LEGO Group.

