

LEGO

SPORTS

3427



 **NBA**

4195738





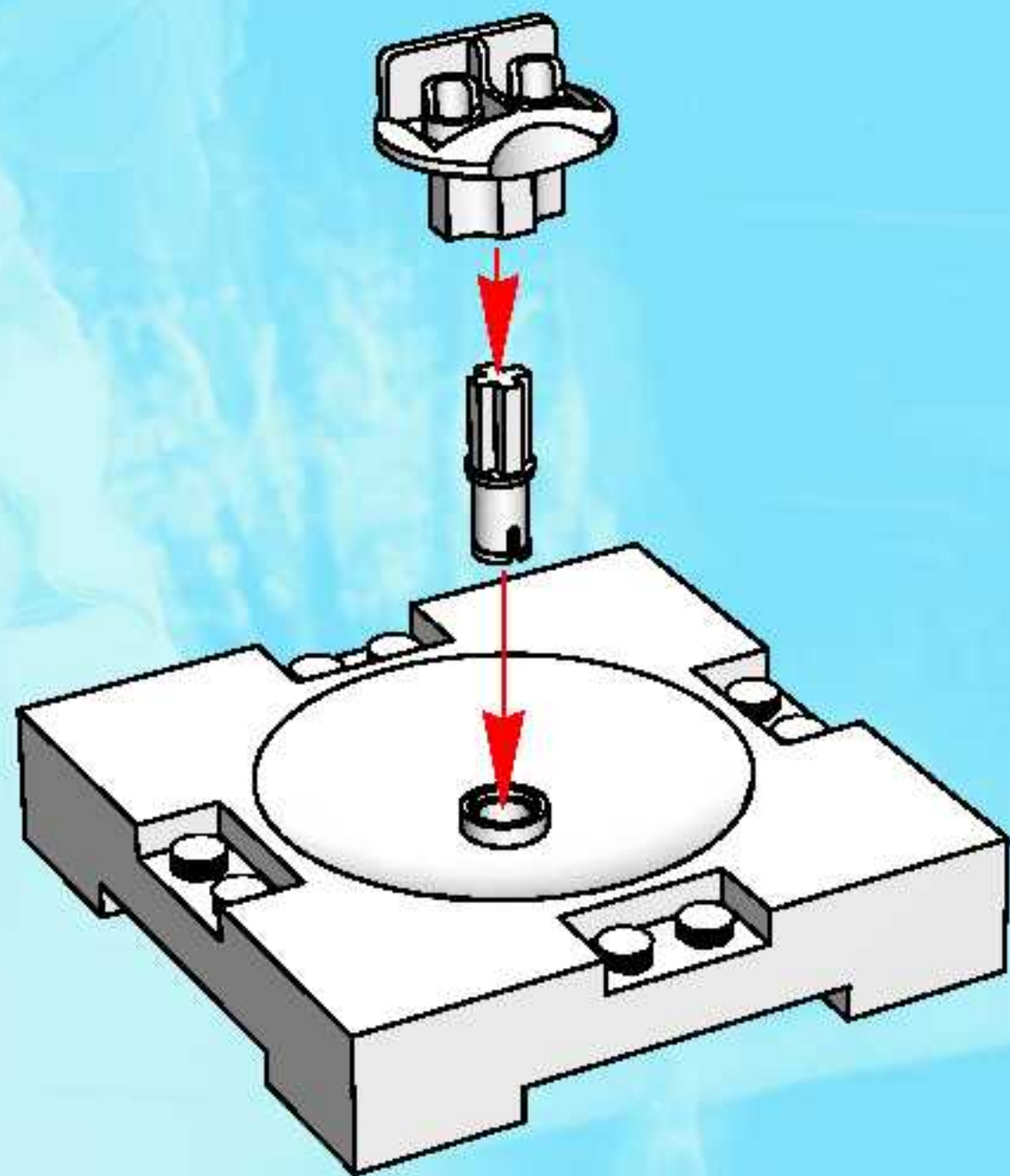
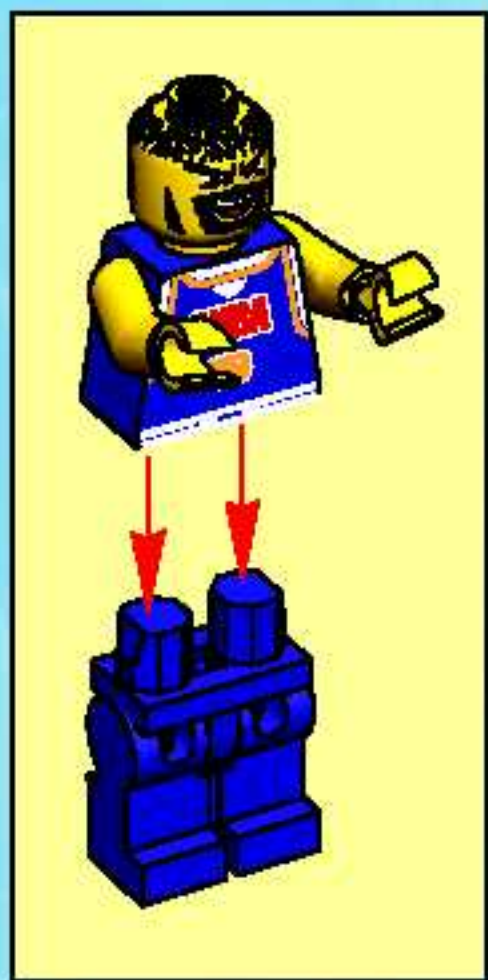

1

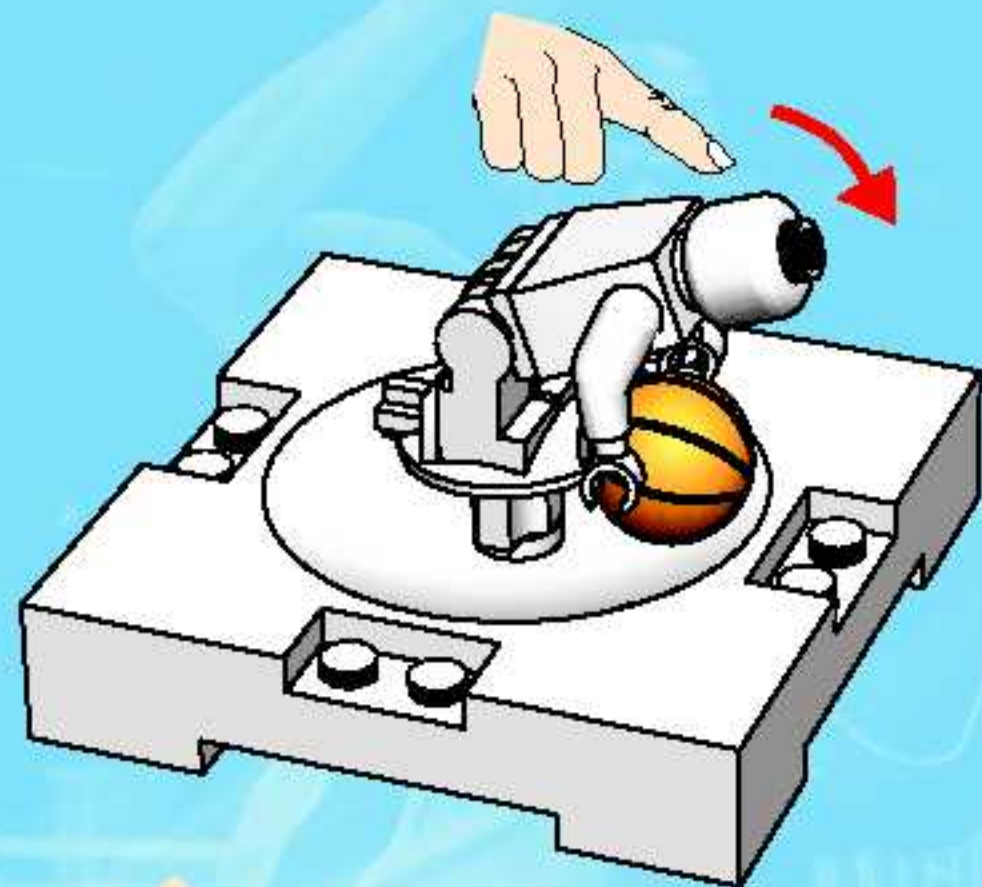

2

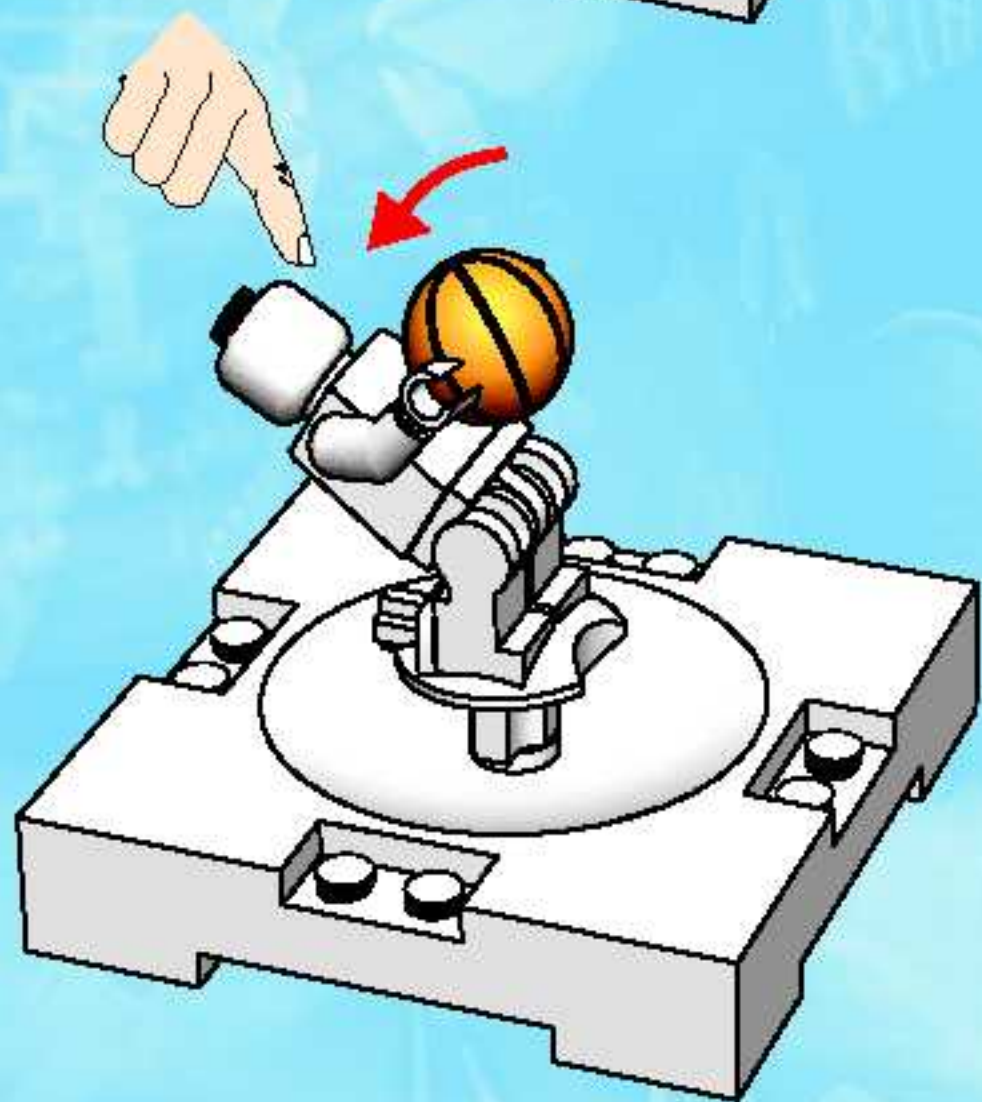

3

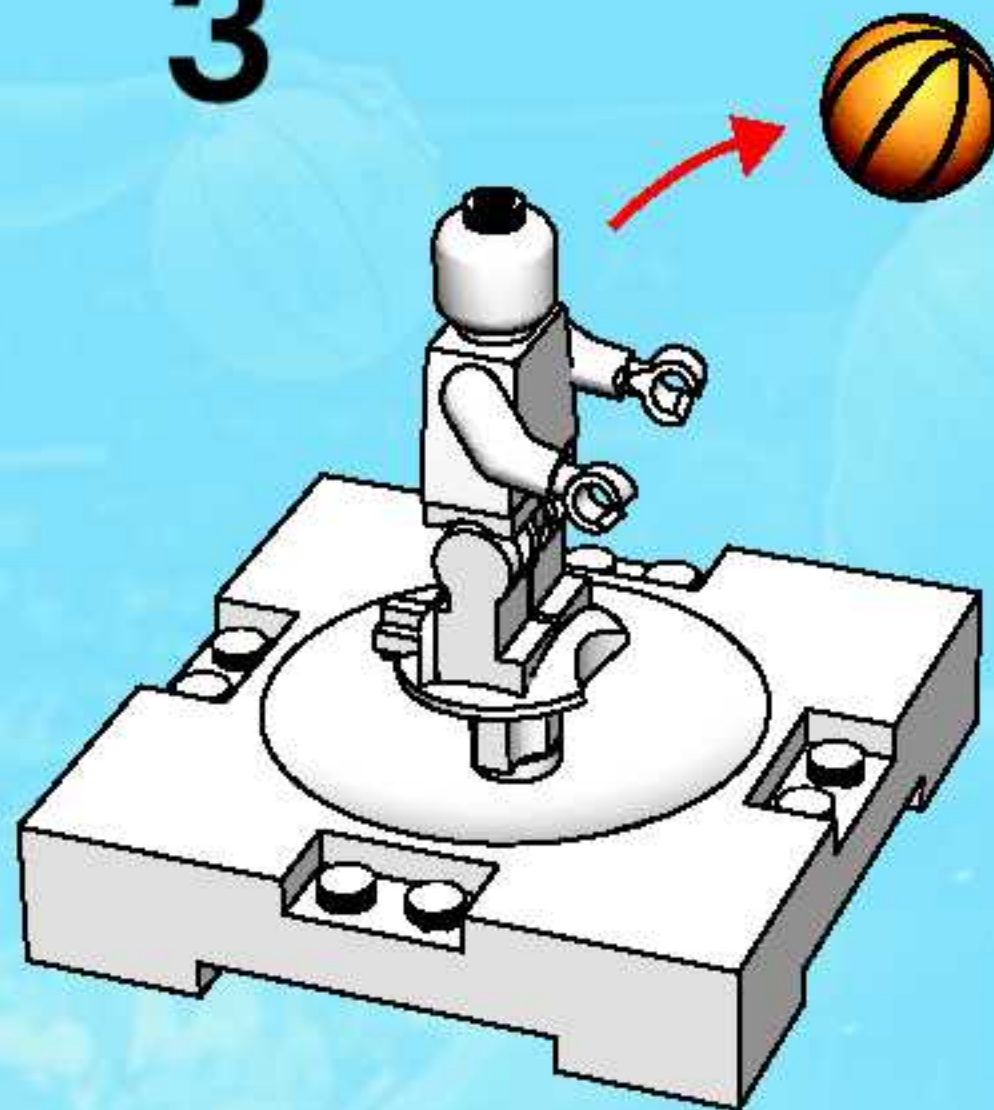

1



2

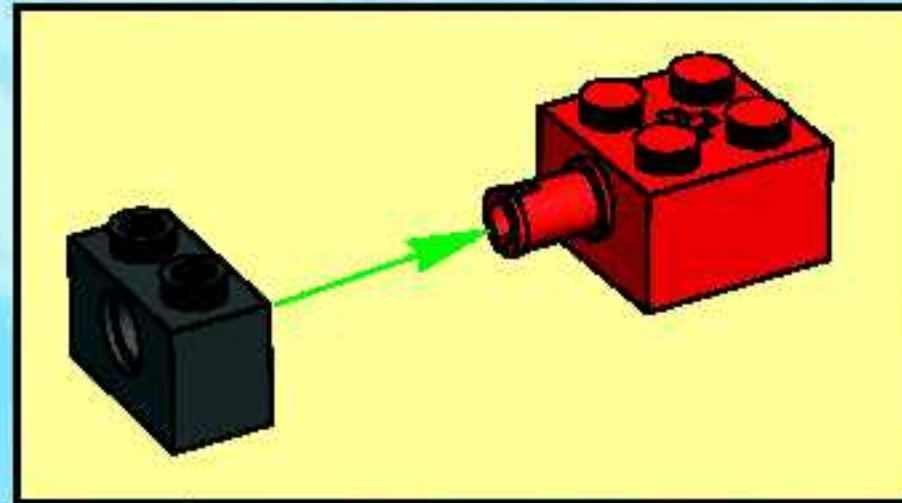

3

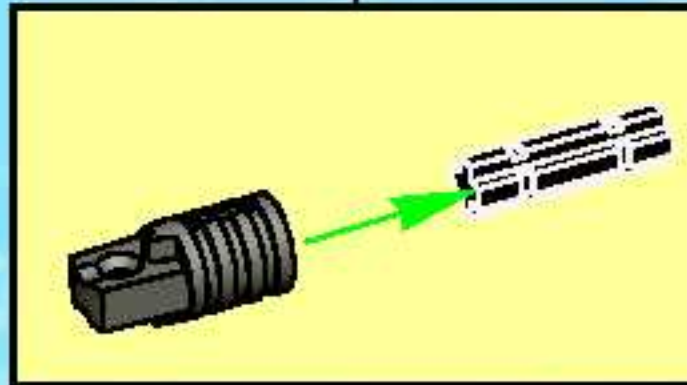
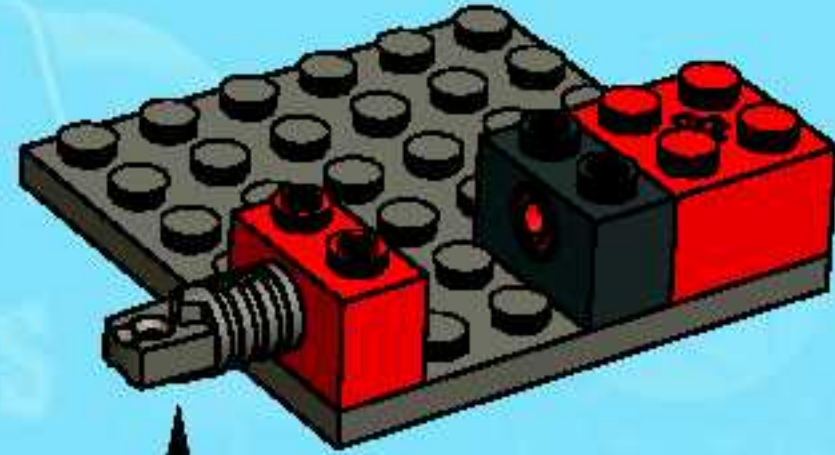

4

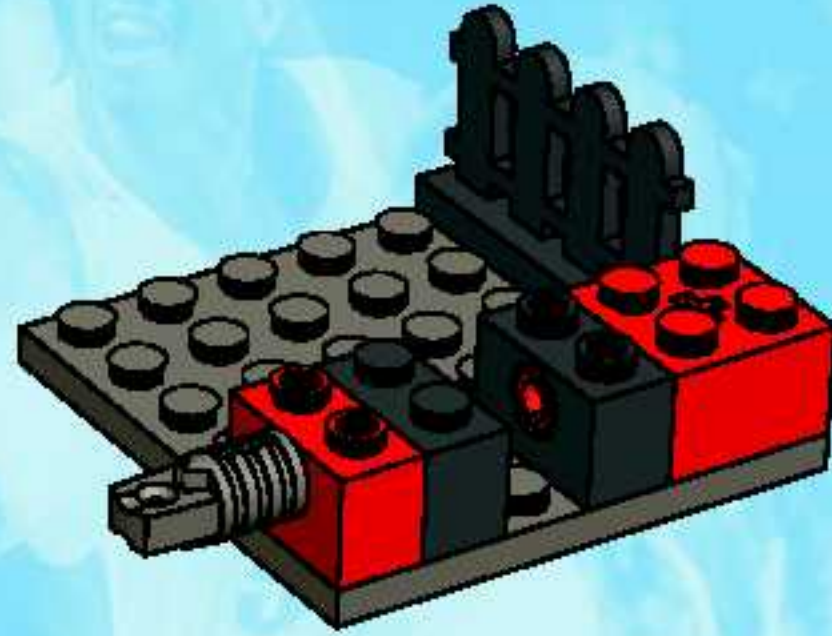

5

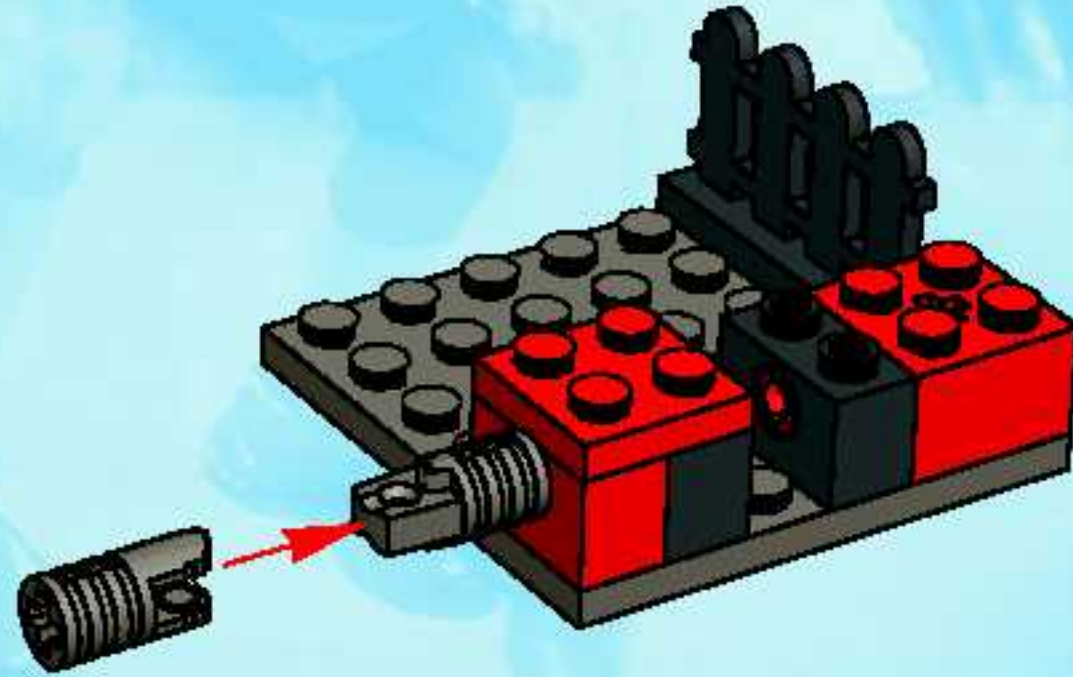

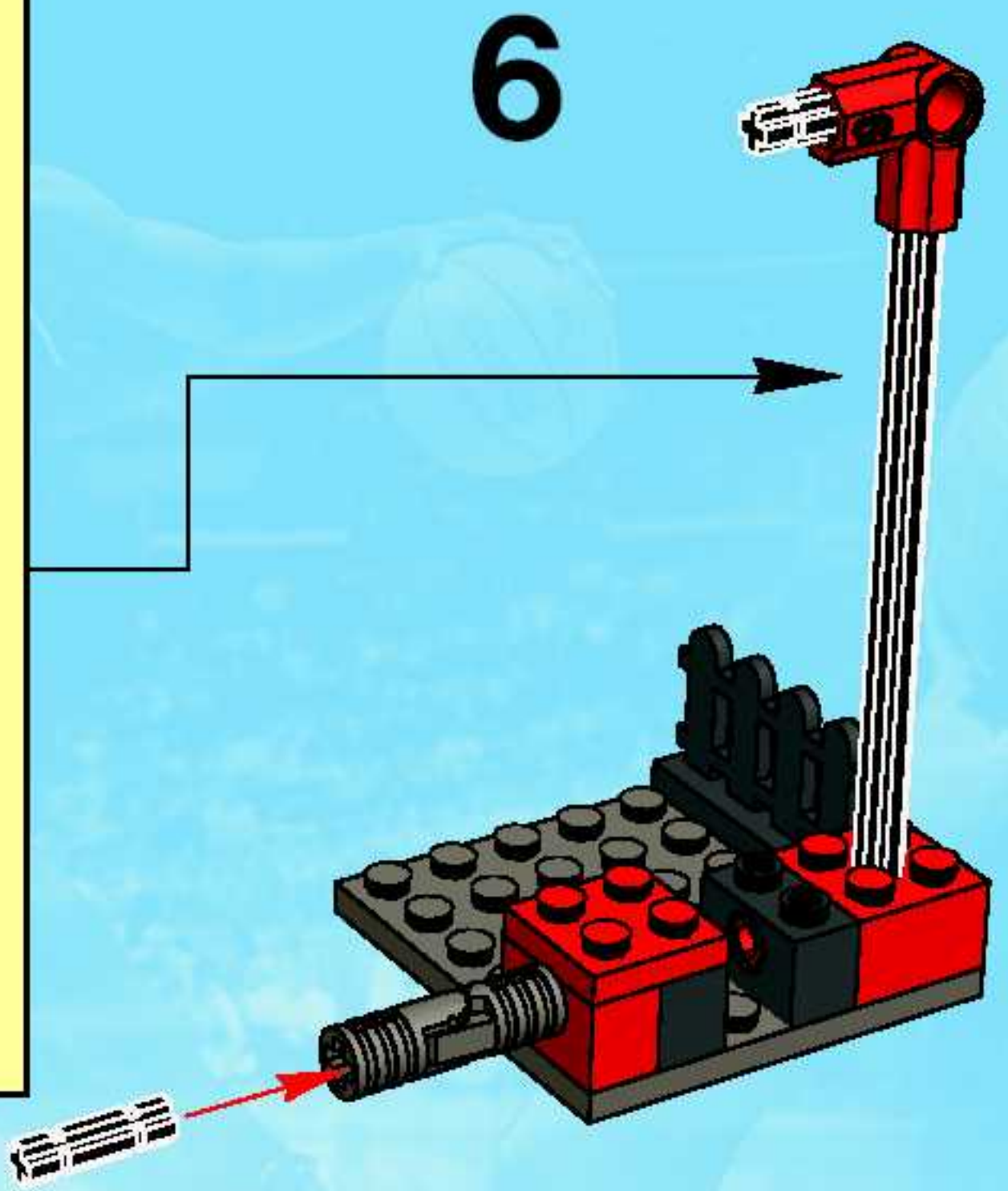
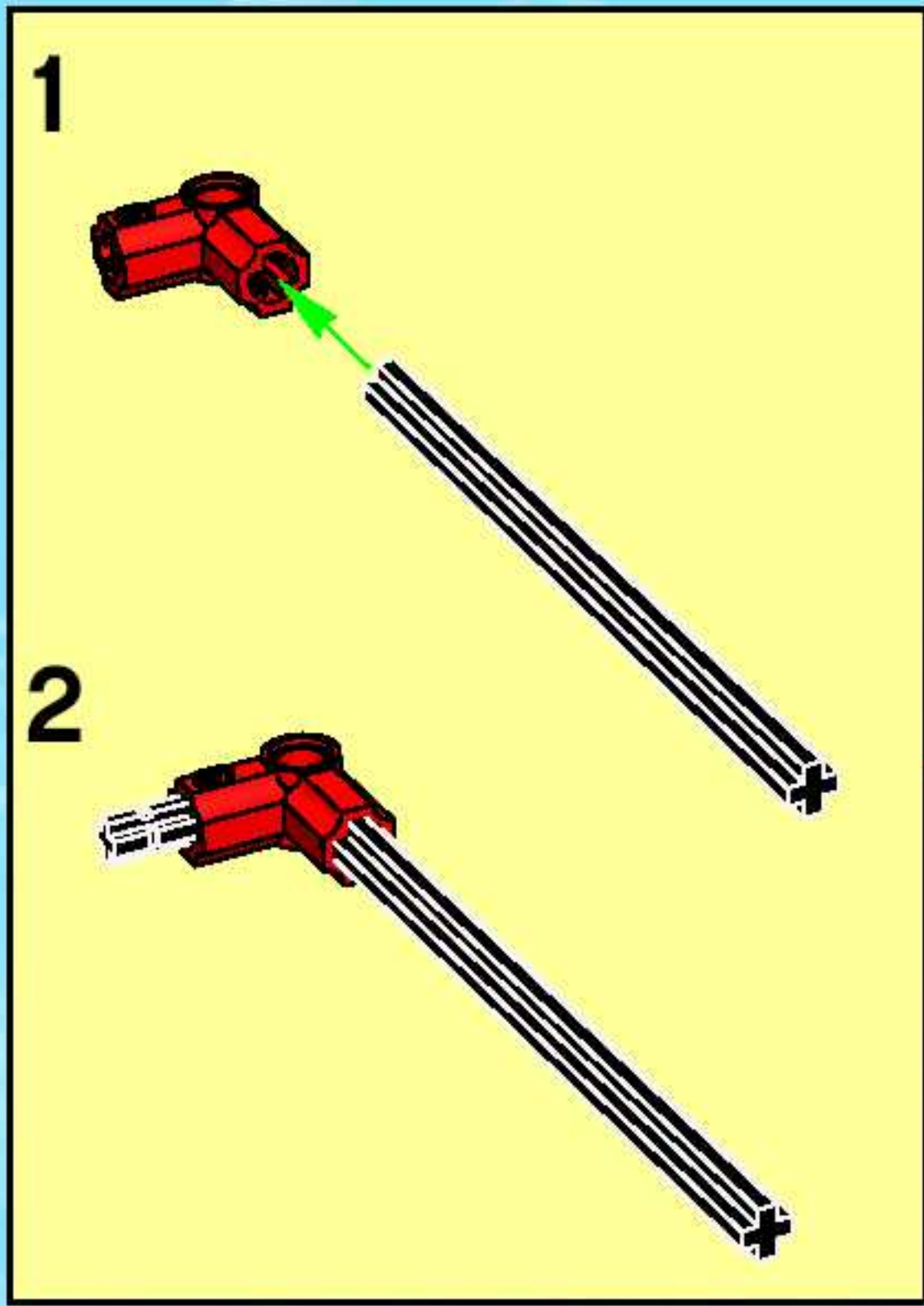

1



2

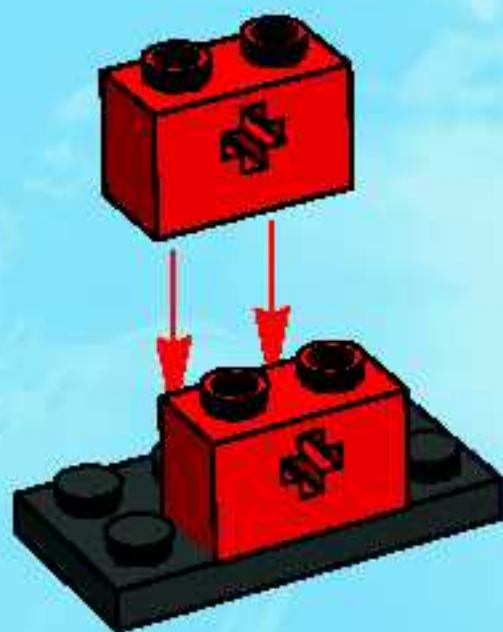

3



4

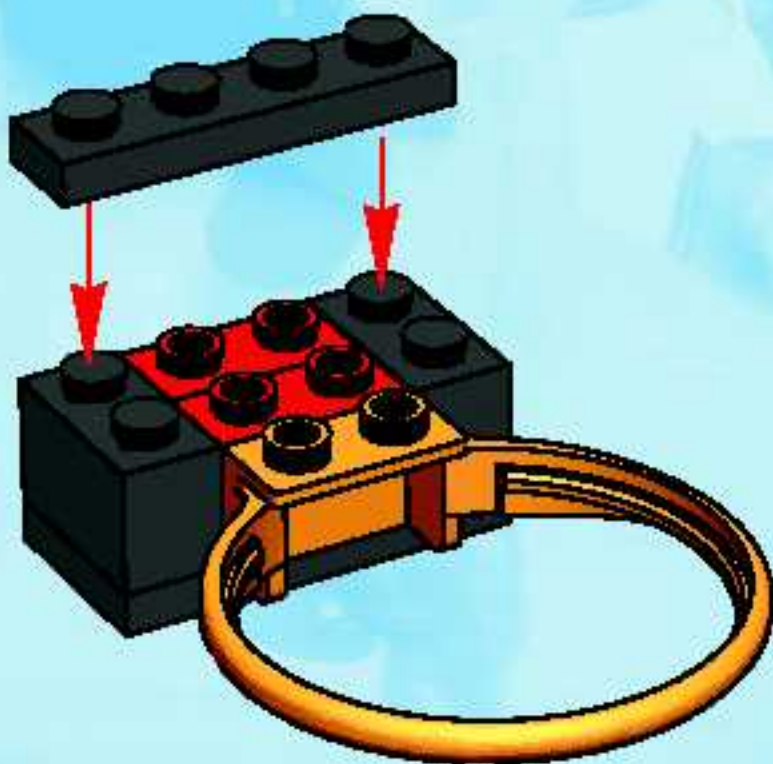

5

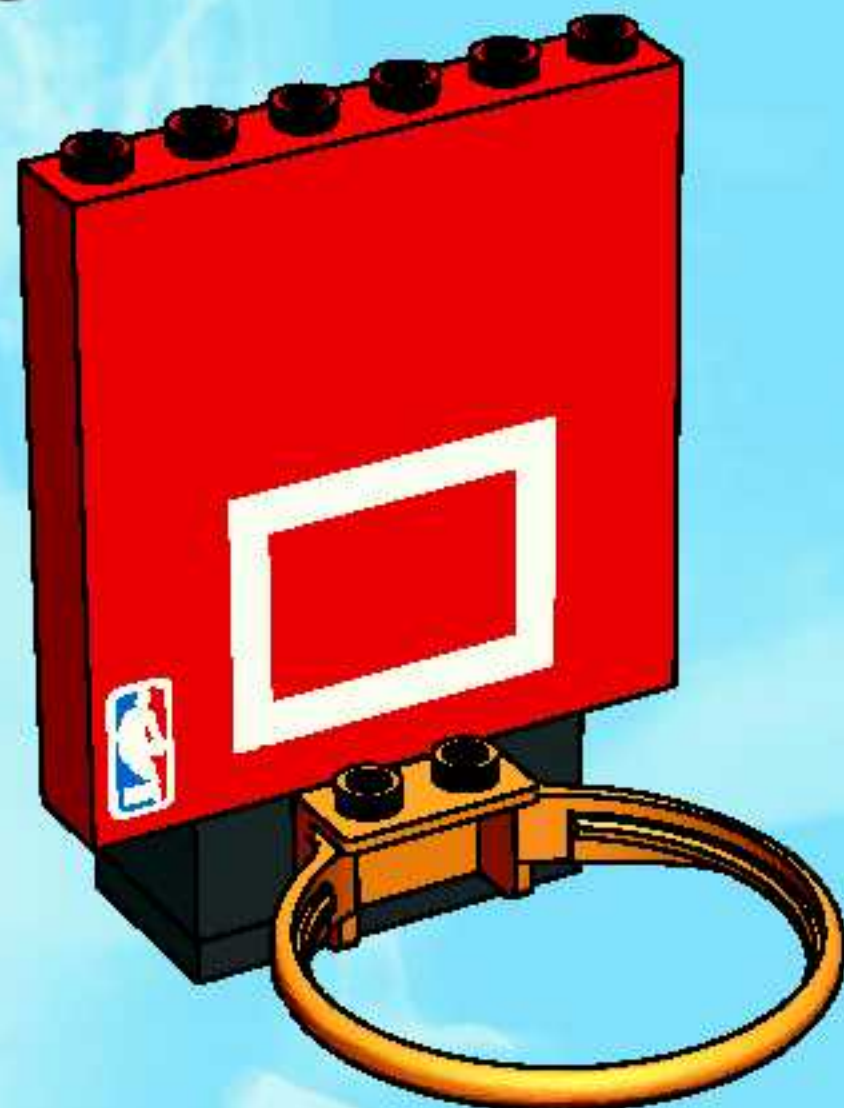

6



7



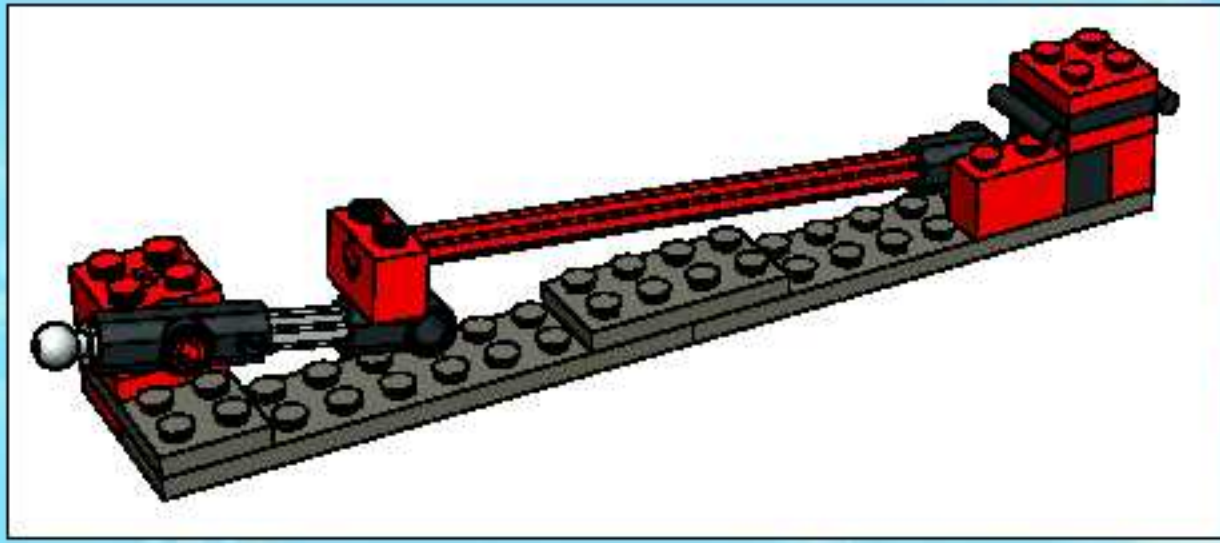

1

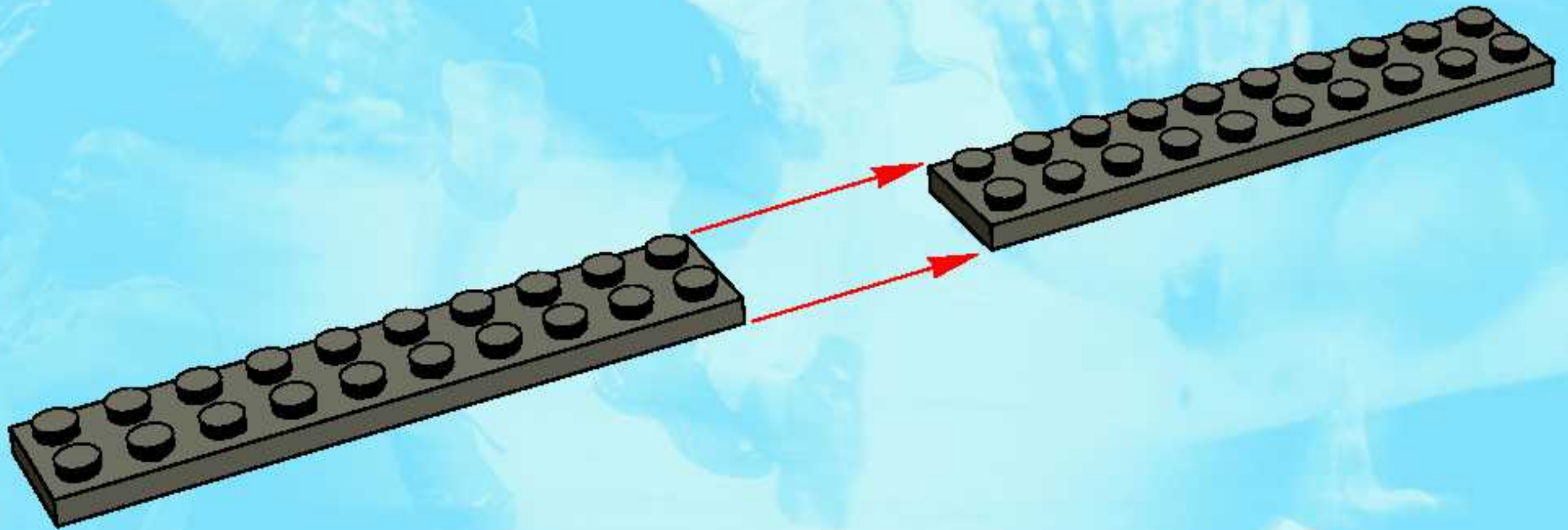

2

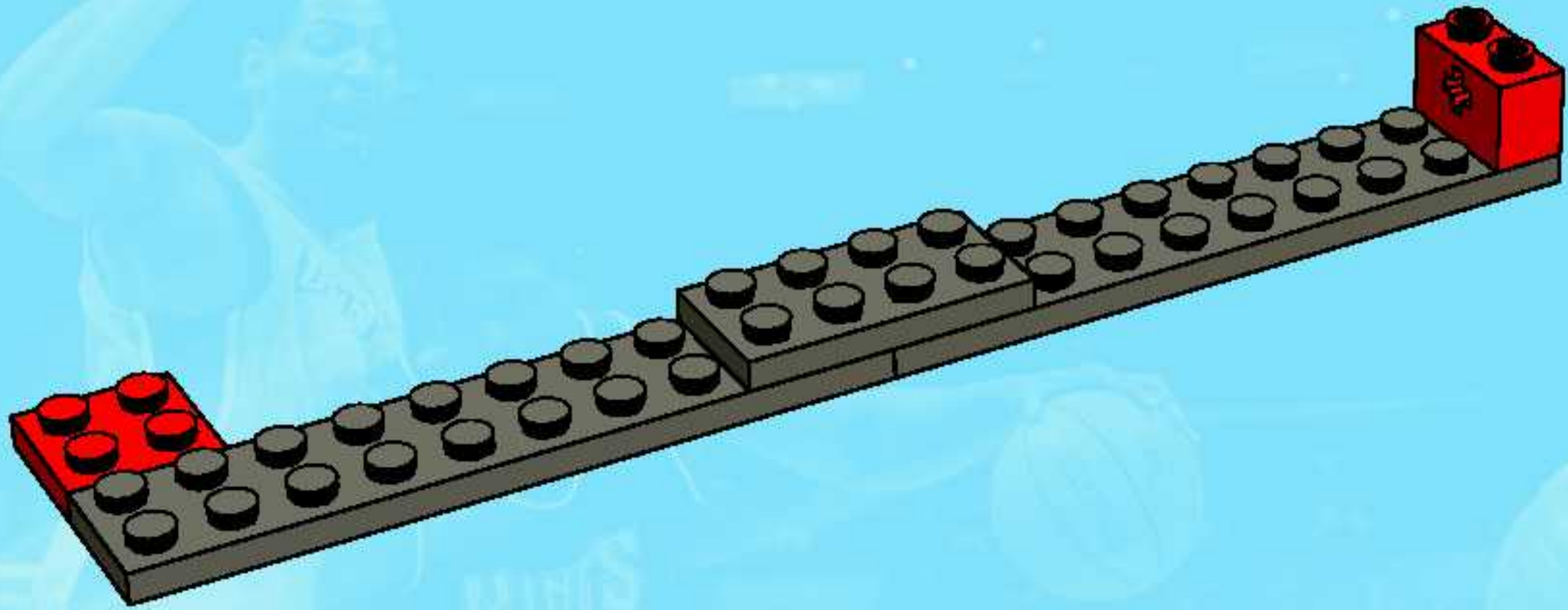

3

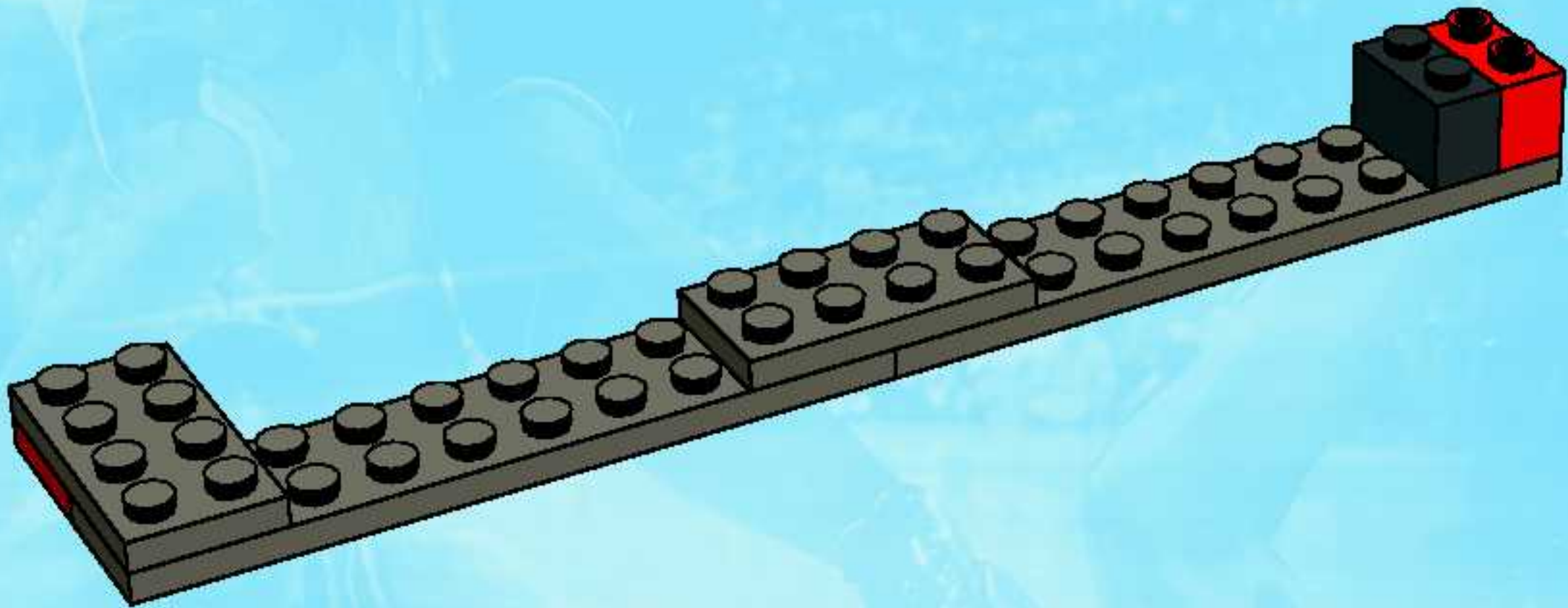

4

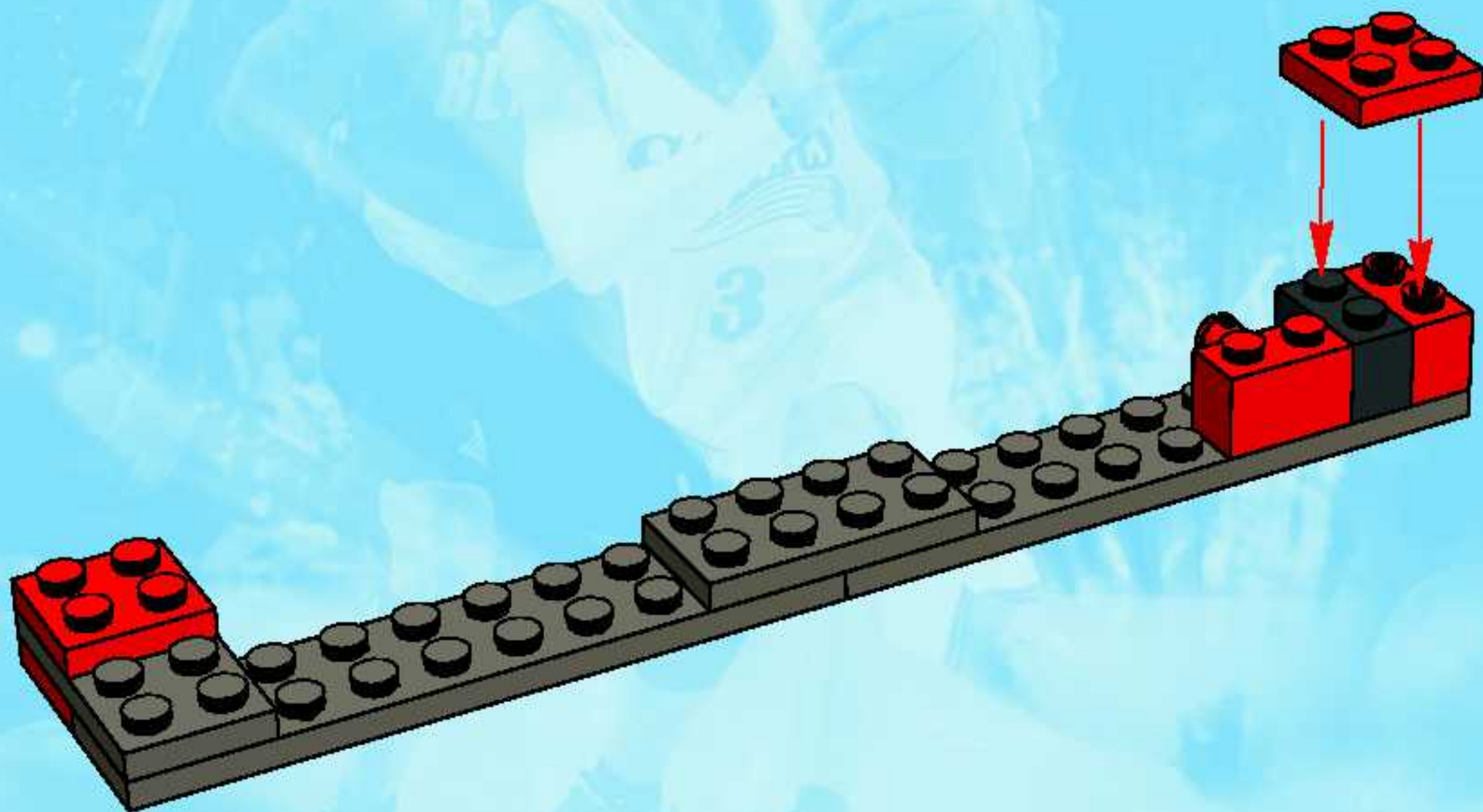

5

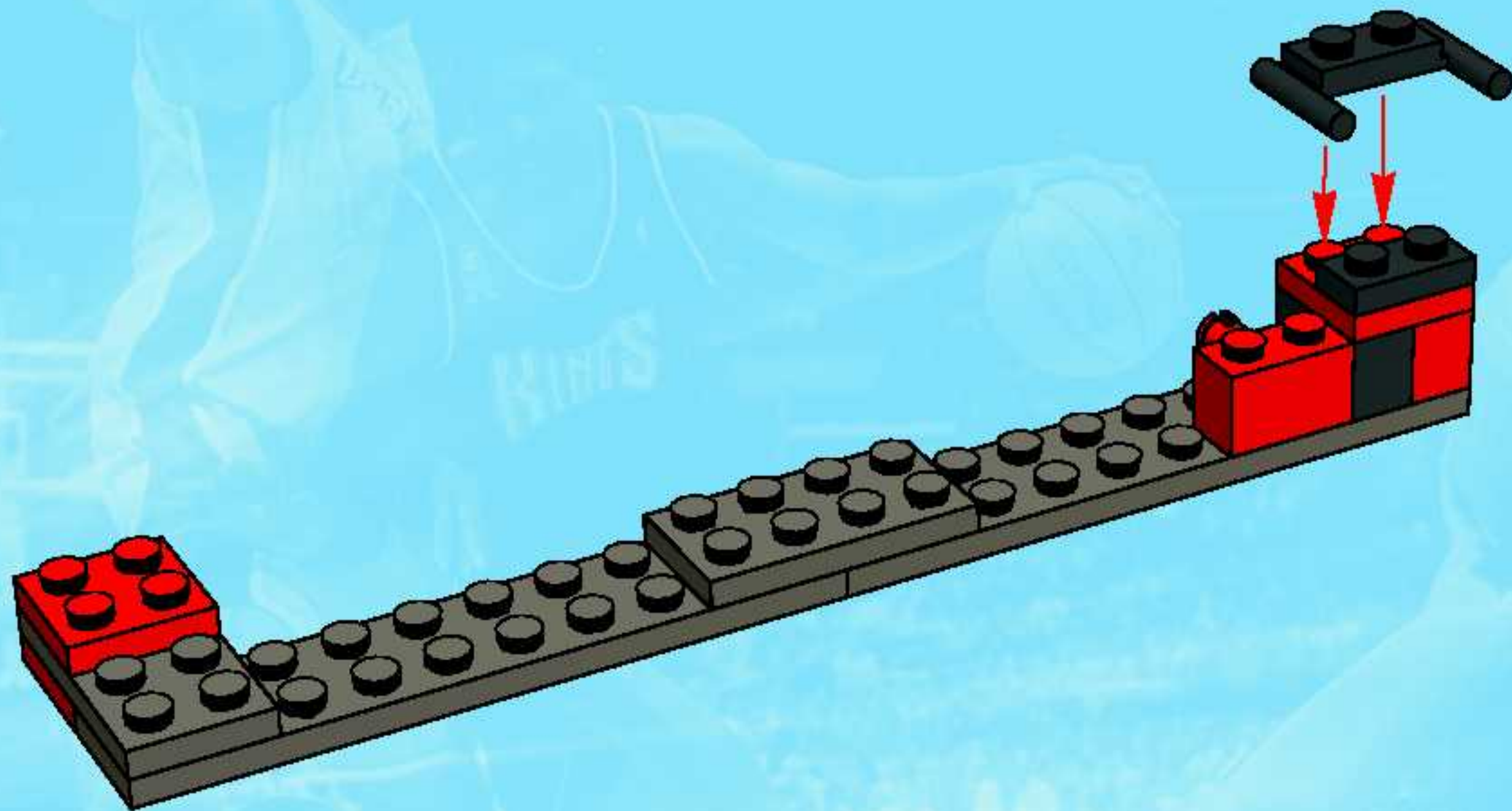

6

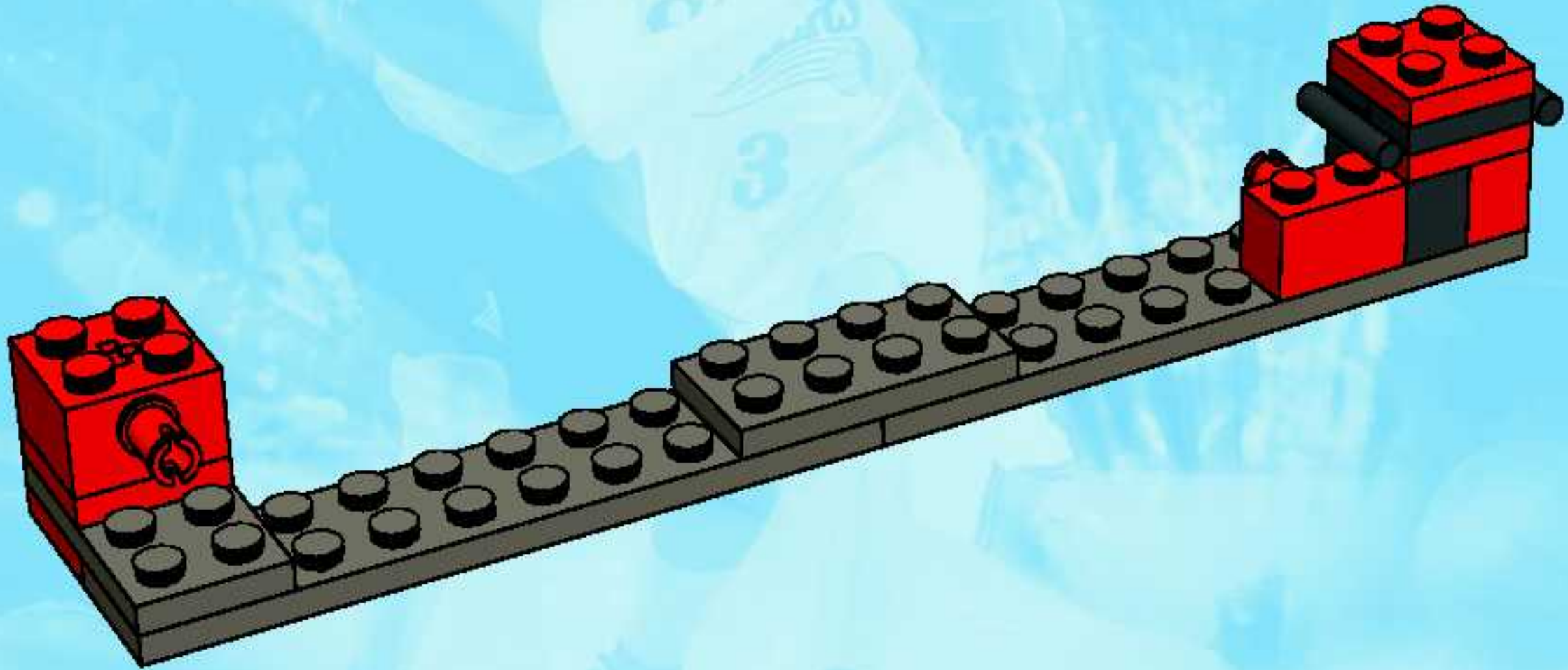

7

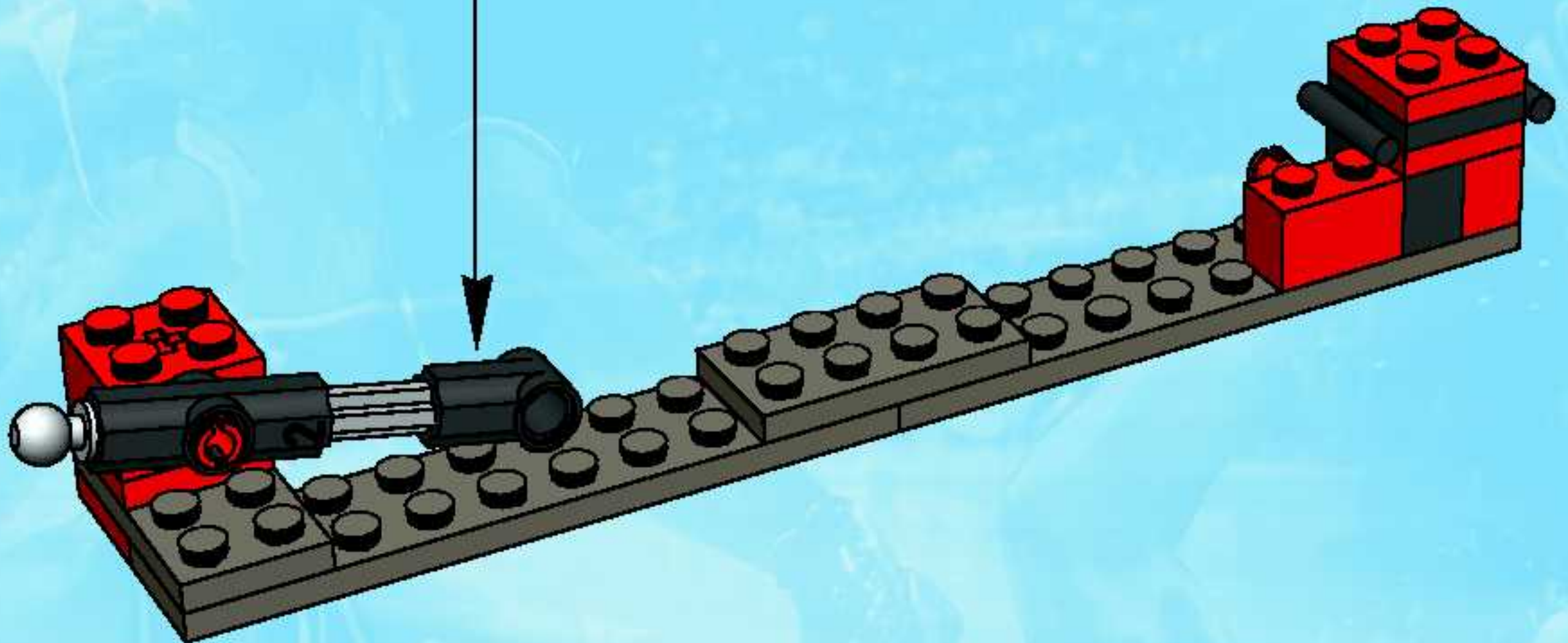
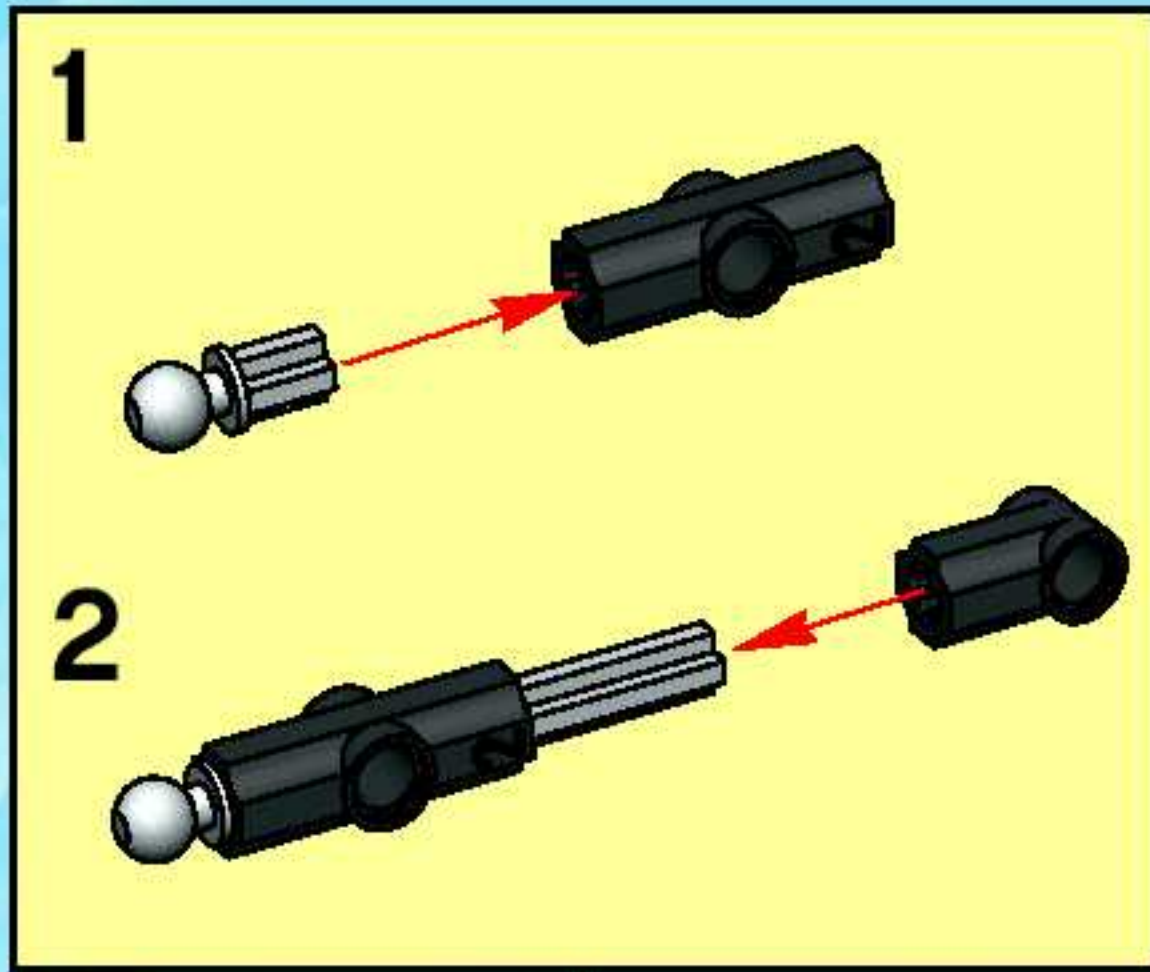

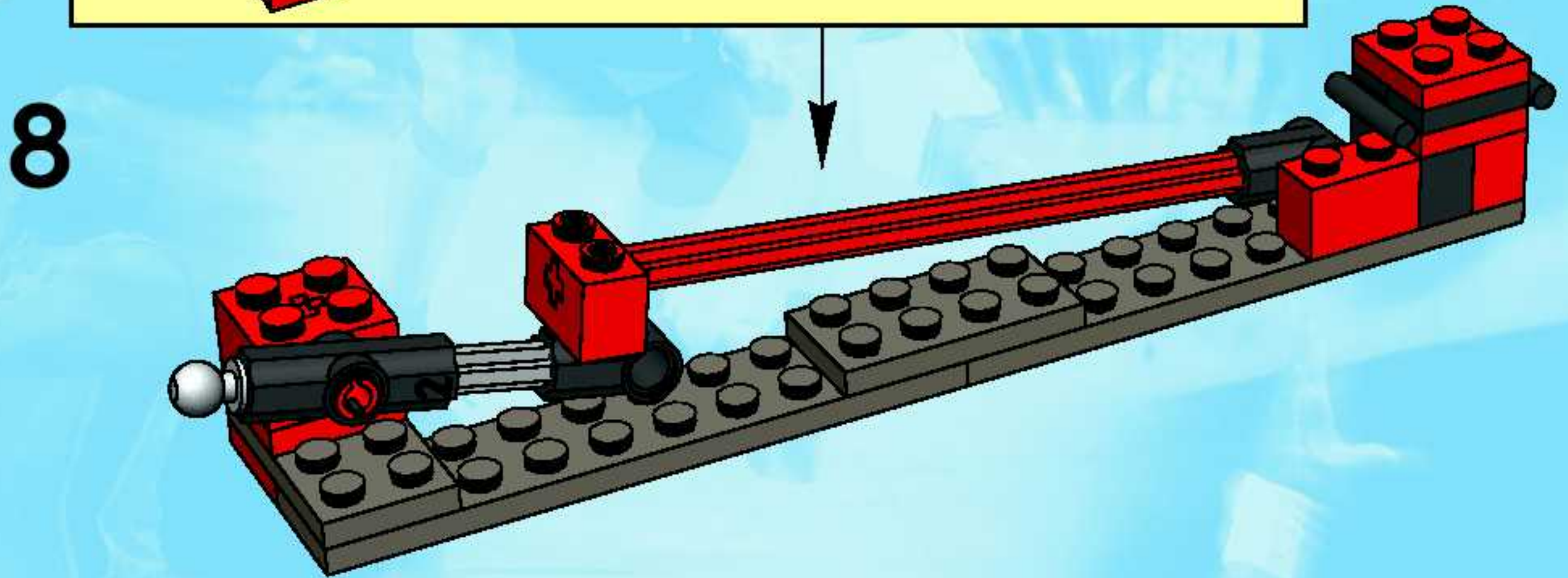
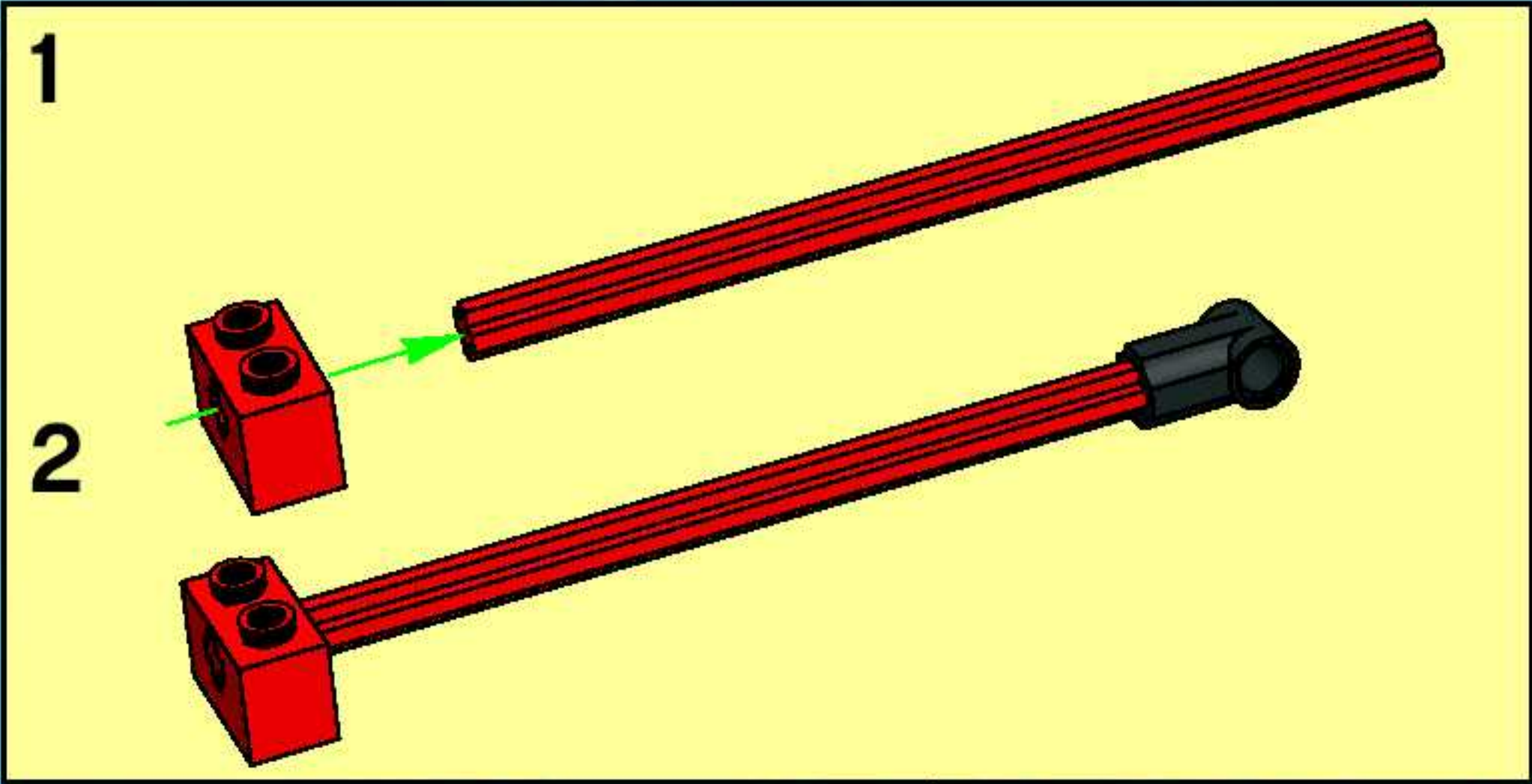

8

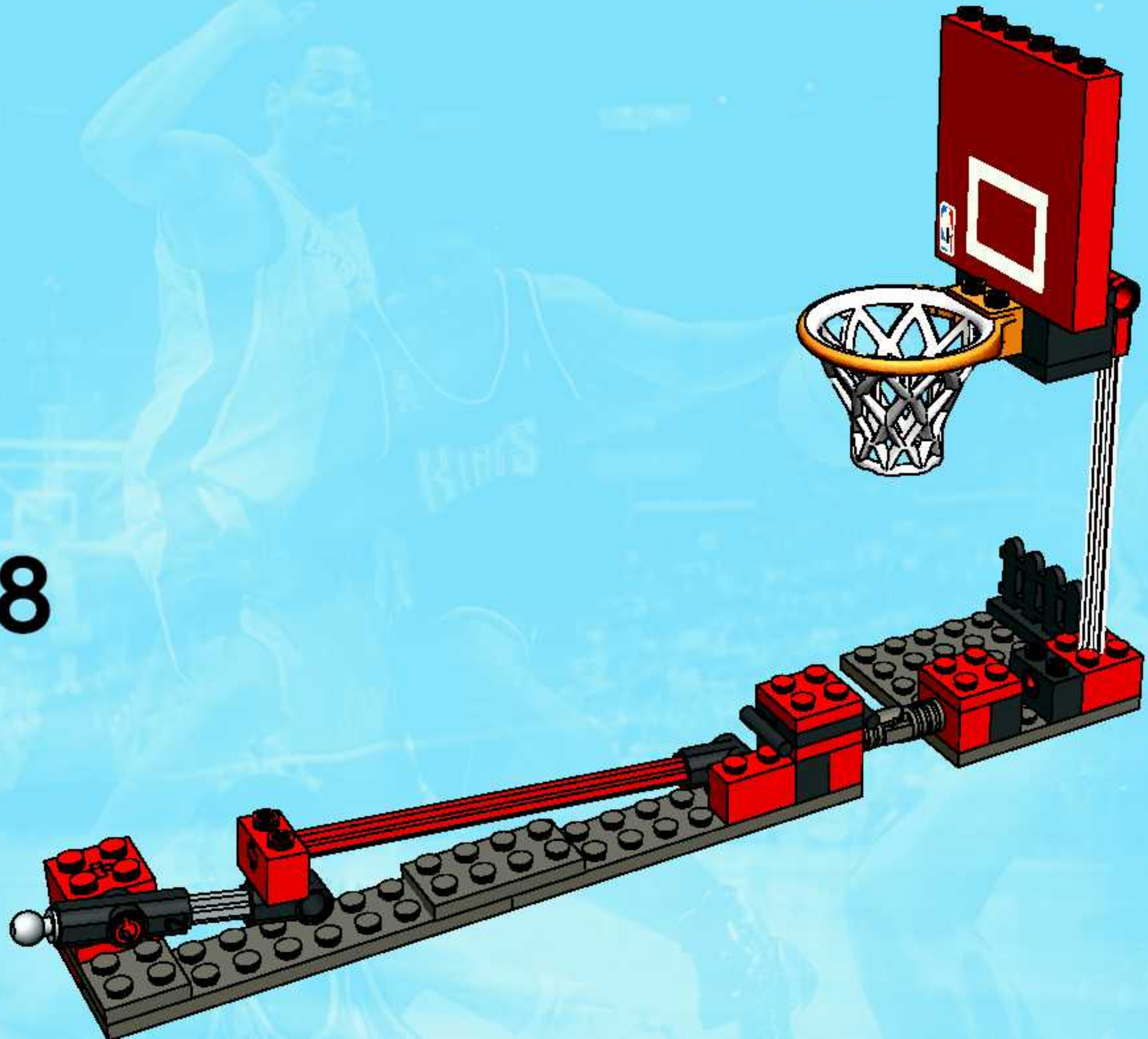

9

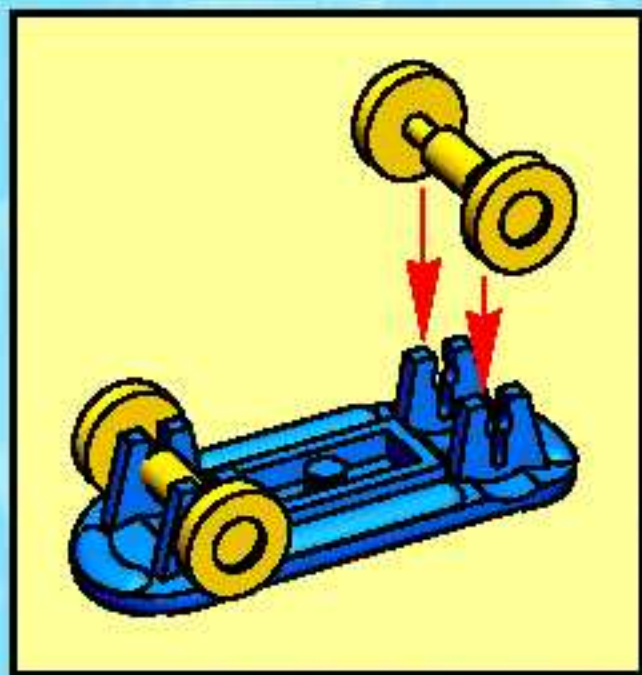



www.LEGO.com

NBA.COM







#3427 + #3428





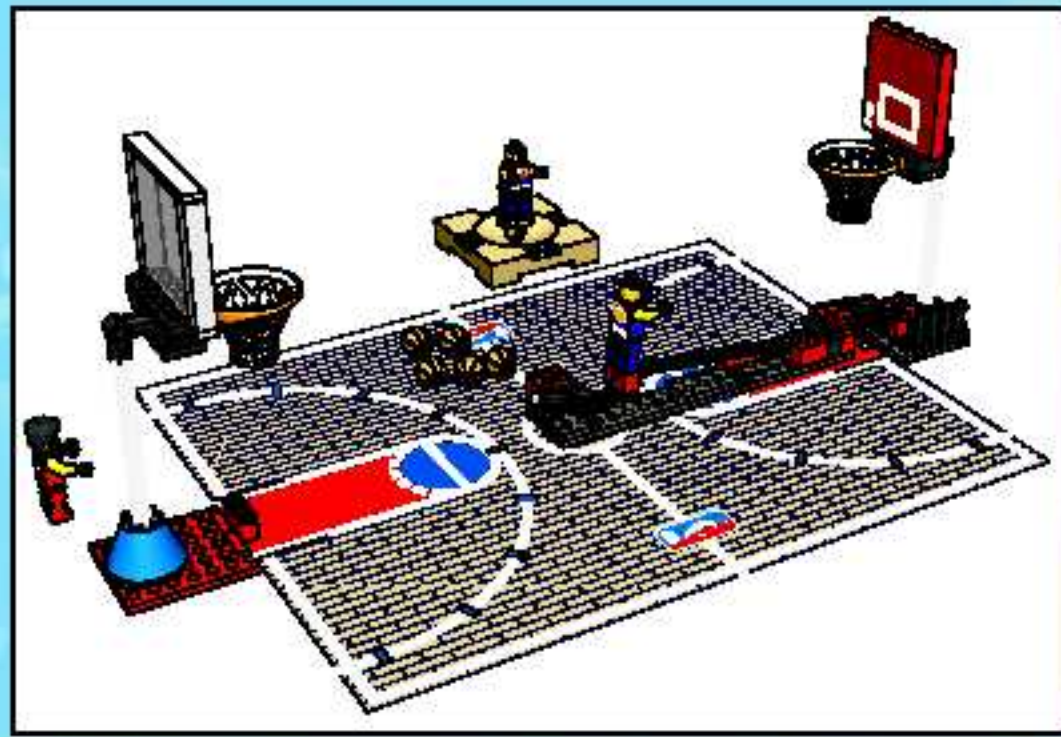

1

3428+3427

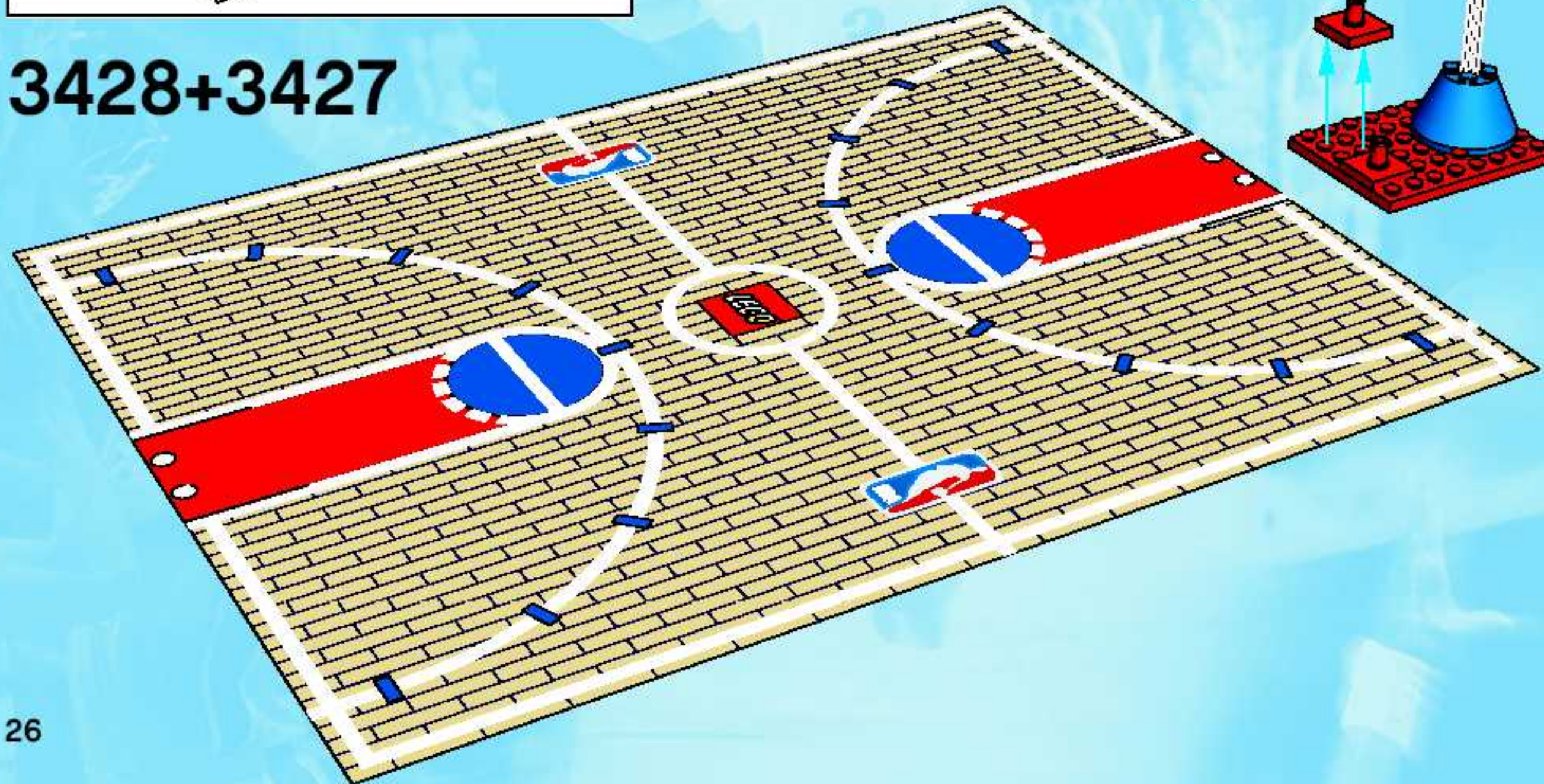

2

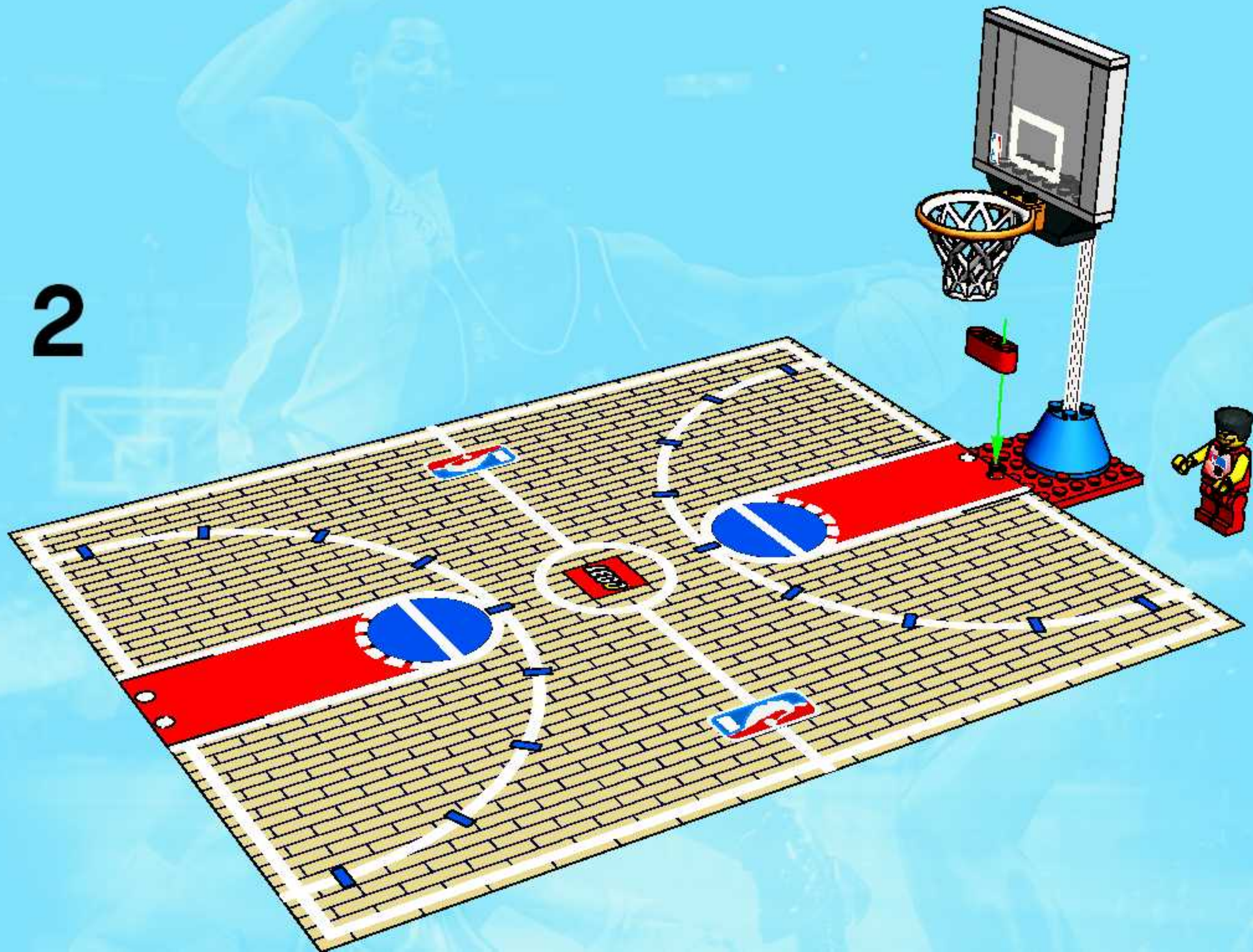

3



4



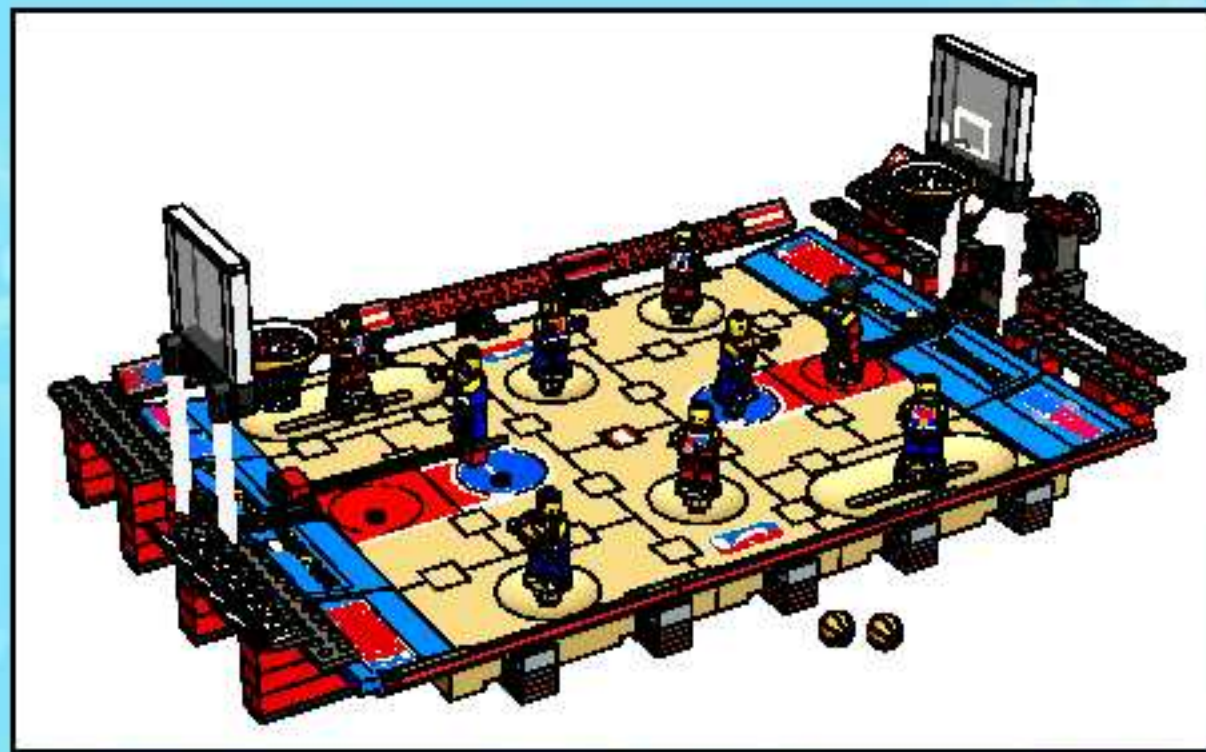

3427 + 3432

1

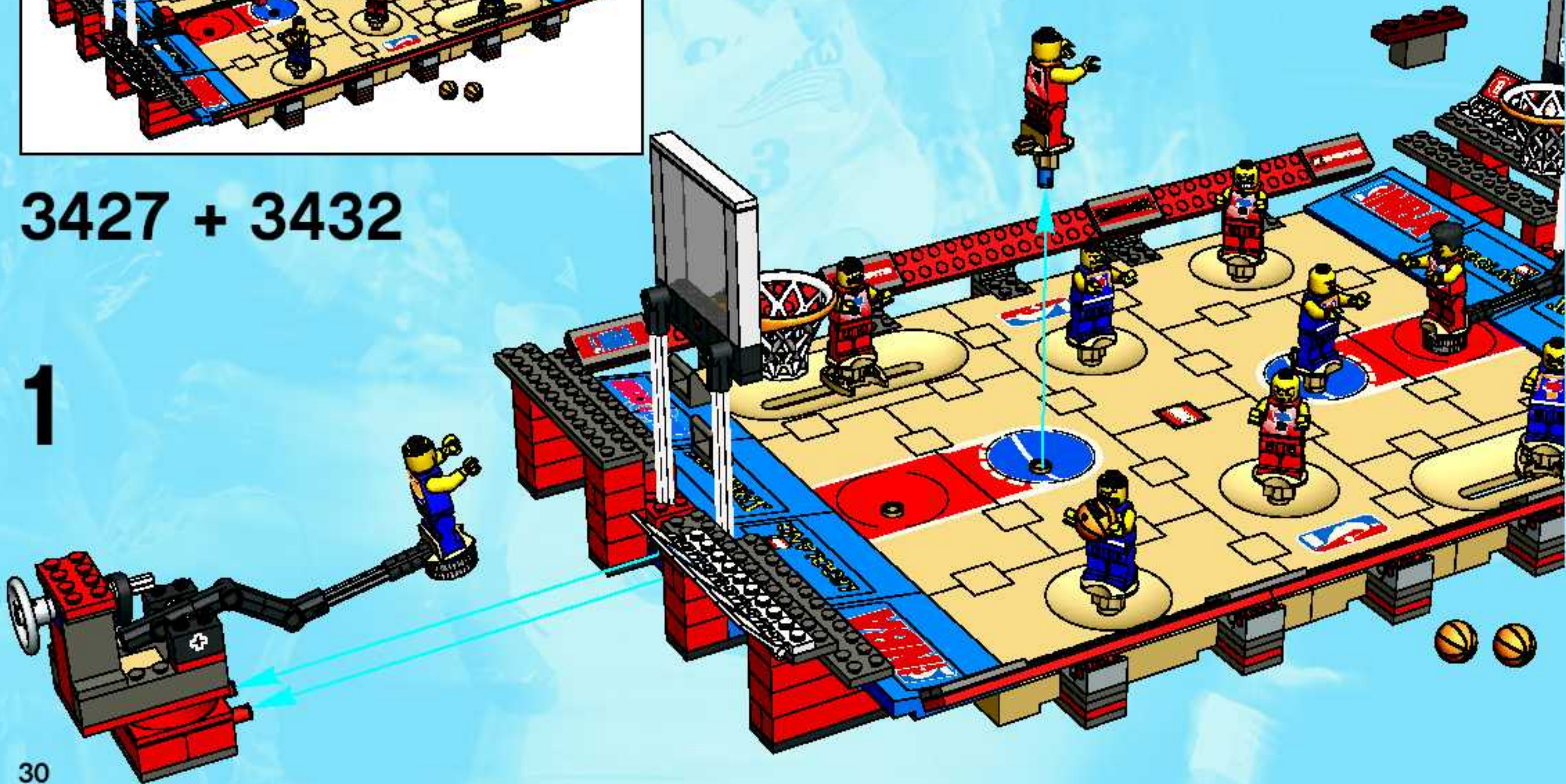

2

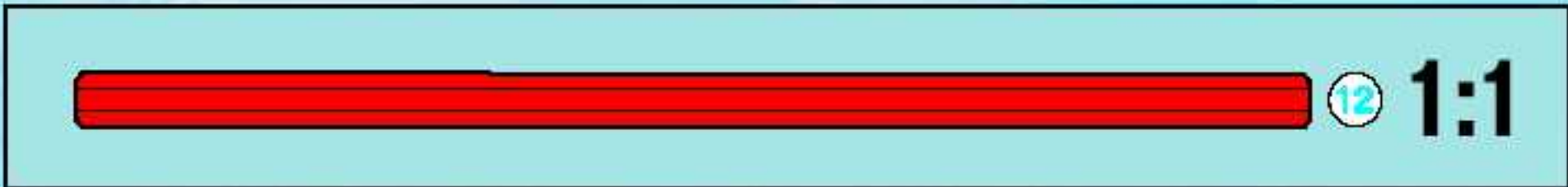
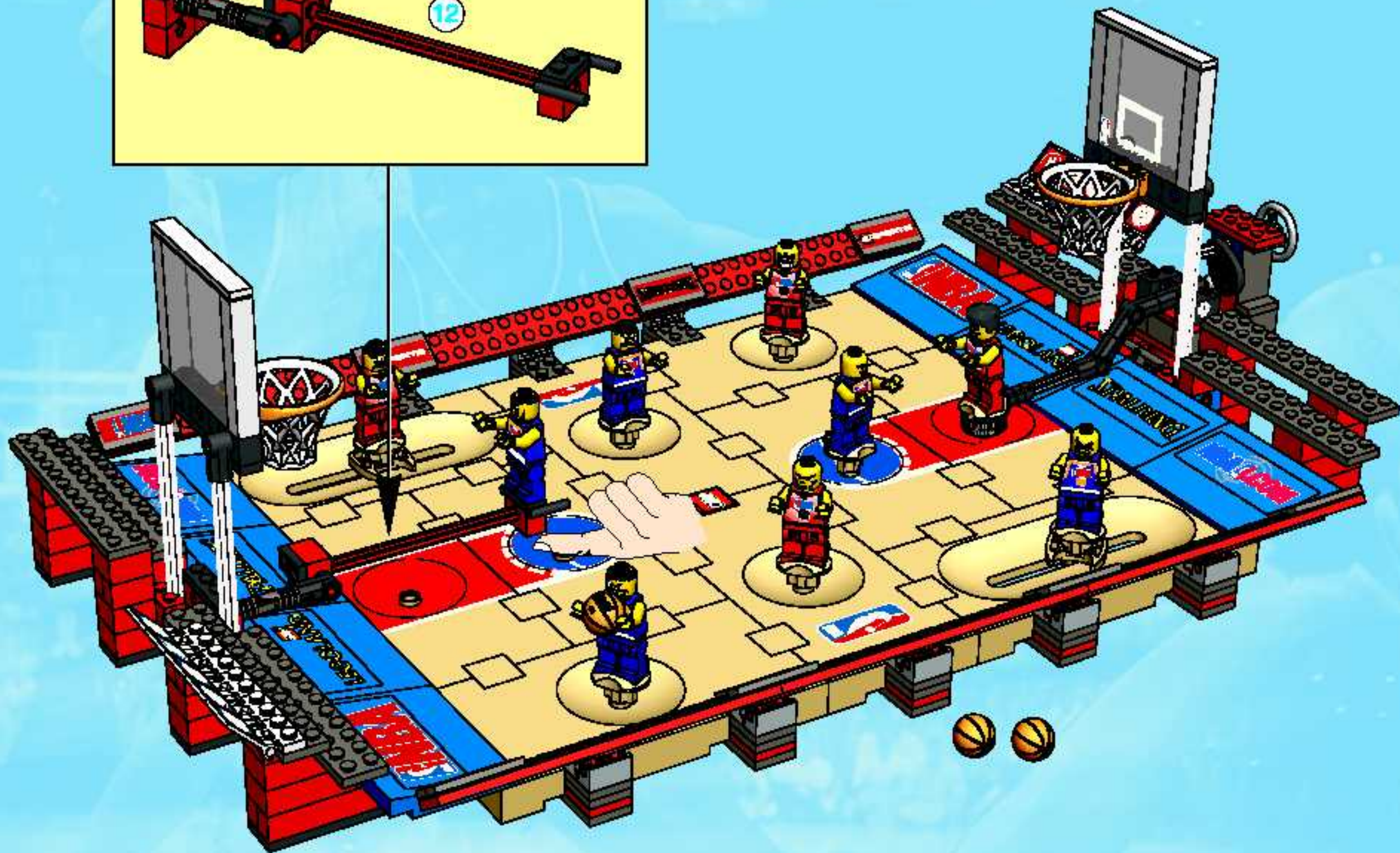
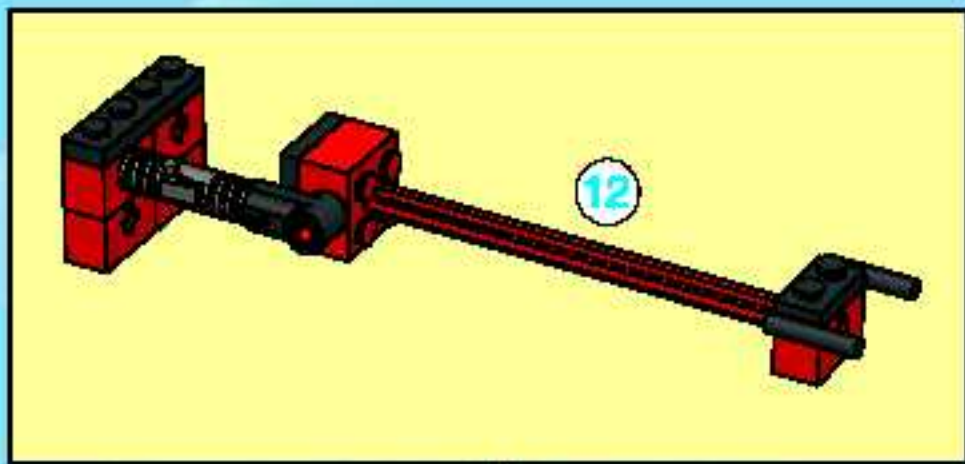



adidas, the adidas logo and the three stripe trademark are registered trademarks of the adidas-Salomon group, used with permission. Fevernova and the Trigon logo are trademarks of the adidas-Salomon group, used with permission.

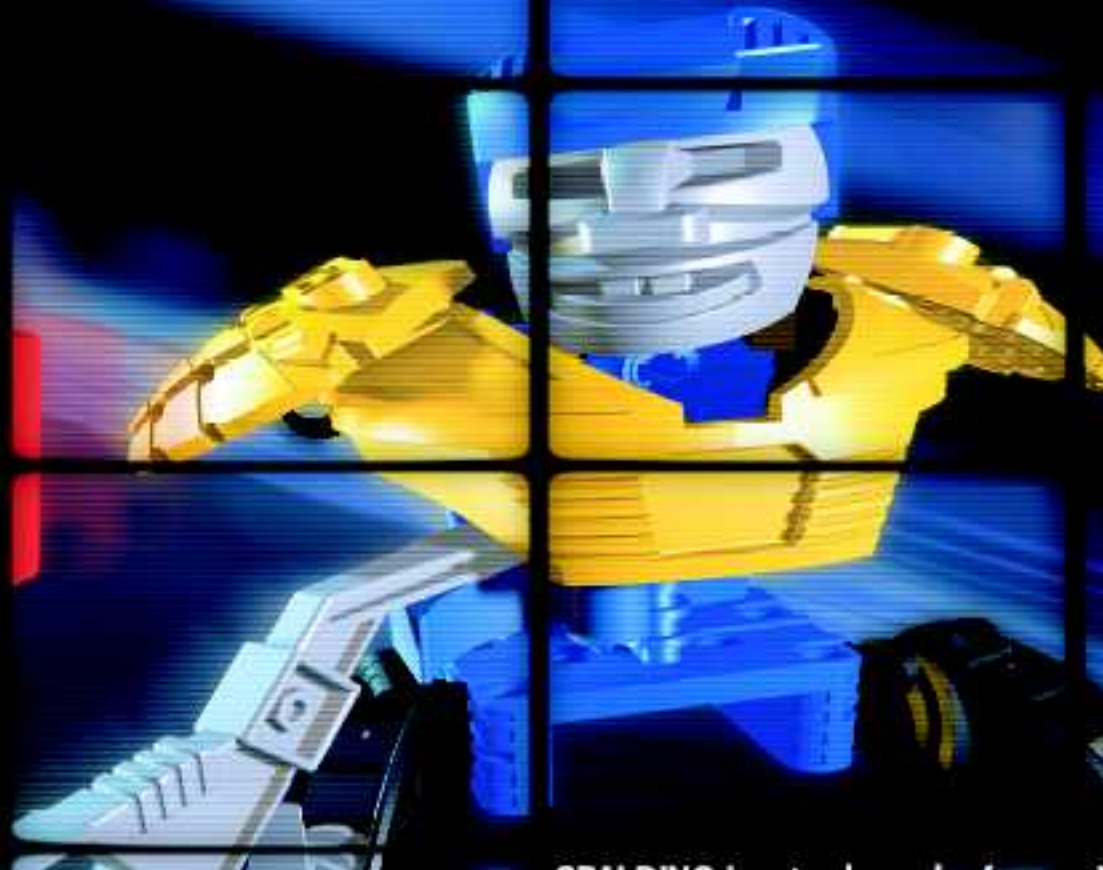

 www.LEGO.com

SPALDING is a trademark of Spalding Sports Worldwide, Inc. or Lisco Sports, Inc., a Spalding affiliate. © Spalding Sports Worldwide, Inc. 2002

NBA identifications depicted are the exclusive property of NBA Properties, Inc. and/or the NBA Member Teams, and are used with permission.

LEGO and the LEGO logo are trademarks of the LEGO Group. ©2002 The LEGO Group.

