



CITY

3366



WARNING: CHOKING HAZARD.
Toy contains small parts and a small ball.
Not for children under 3 years.



1

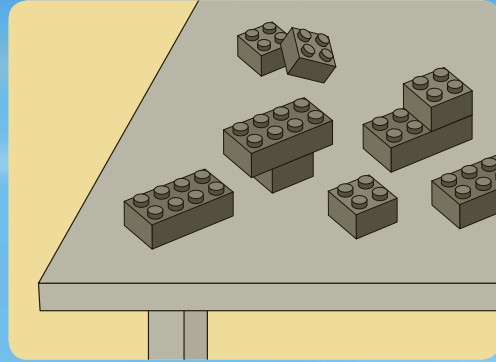

2



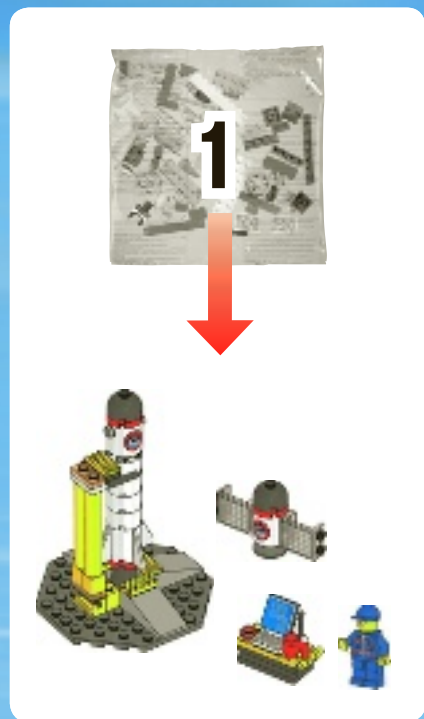



1

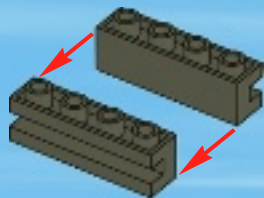

2

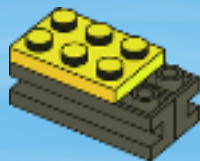

3



4



5



6





1

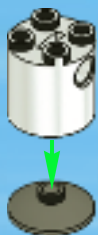

2



3



4

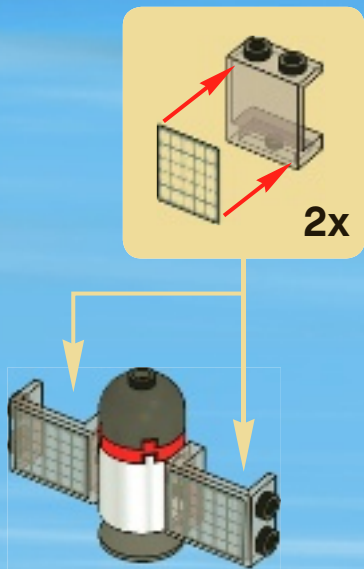

5

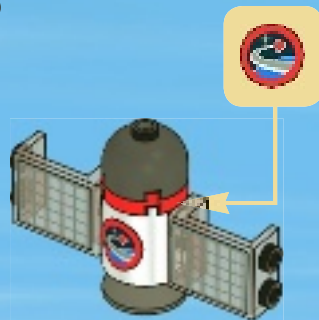



1



2



3



4



5

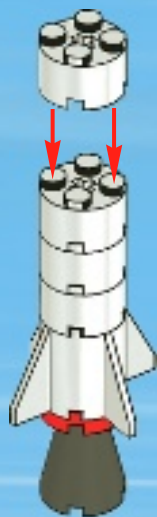

6



7

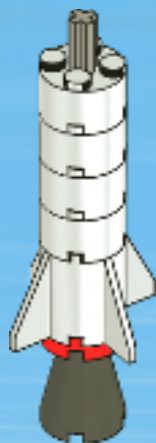

1



2



3



4



8





1



2



3

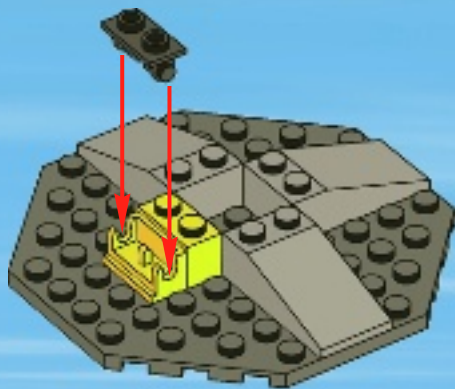

4

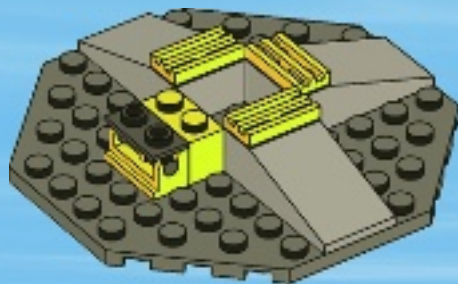

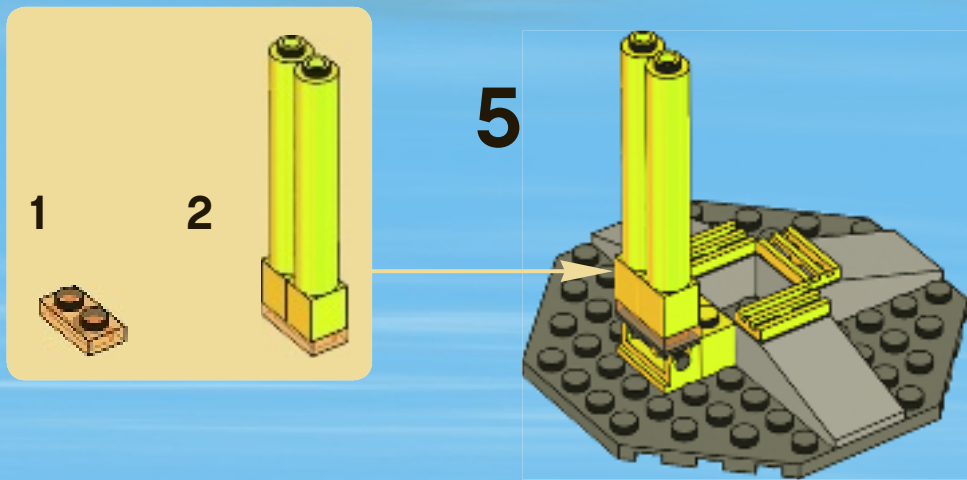

1



2



3



6

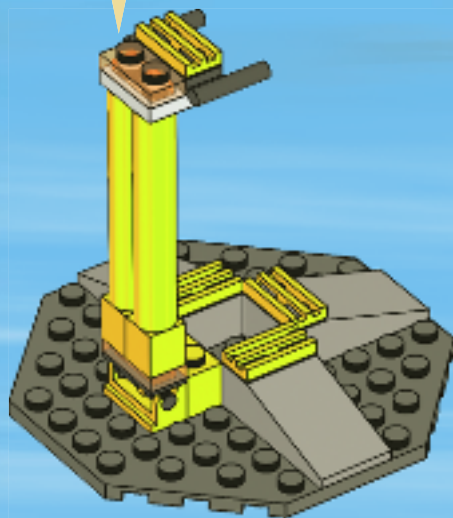

7

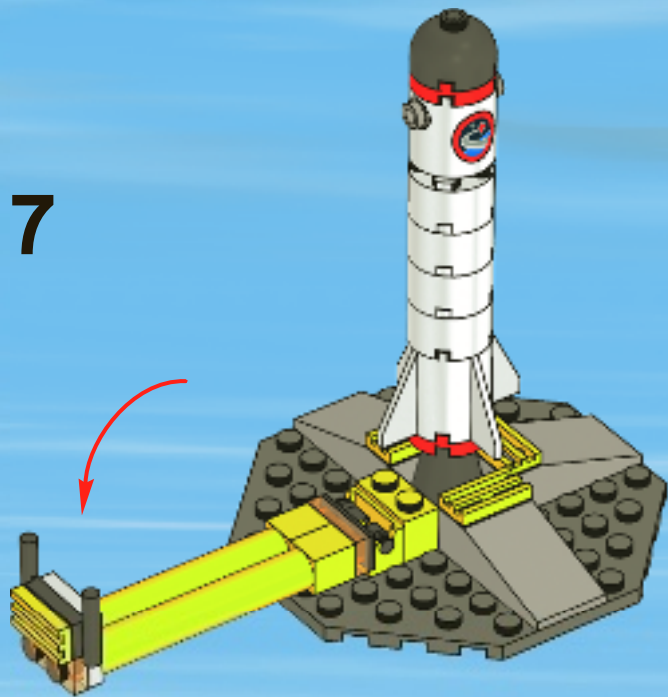

16

8

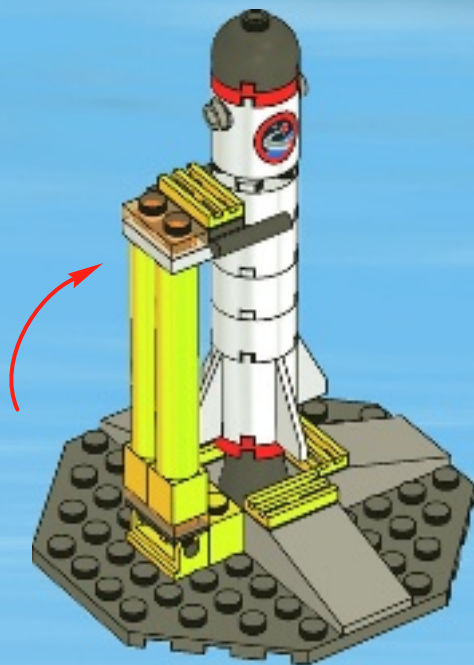

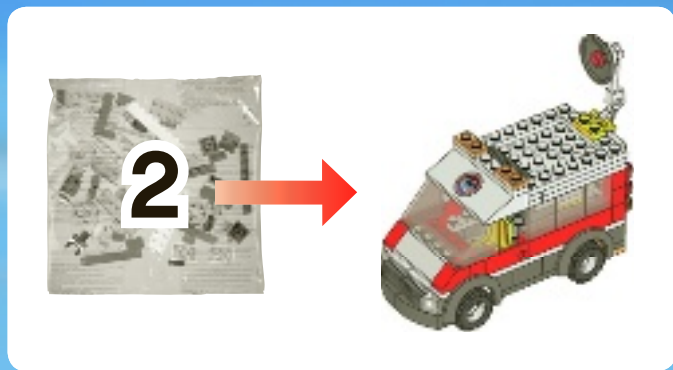

1

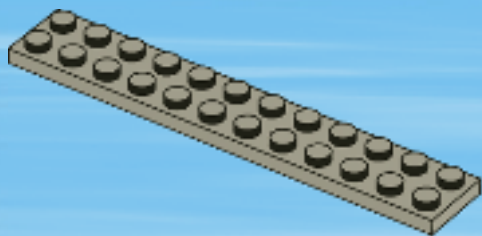

2

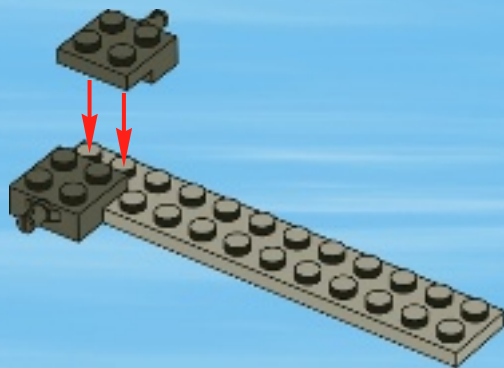

3



4

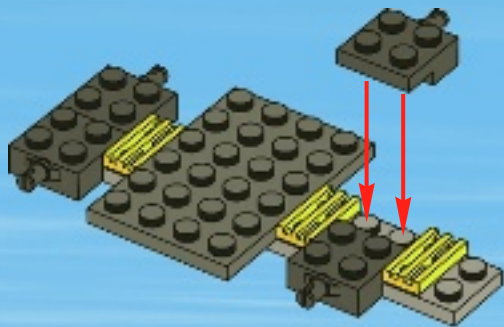

1



2

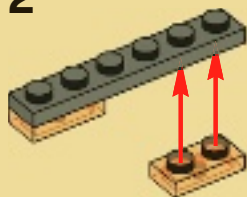

5

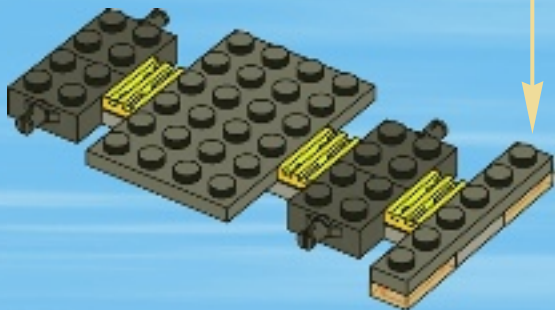

6

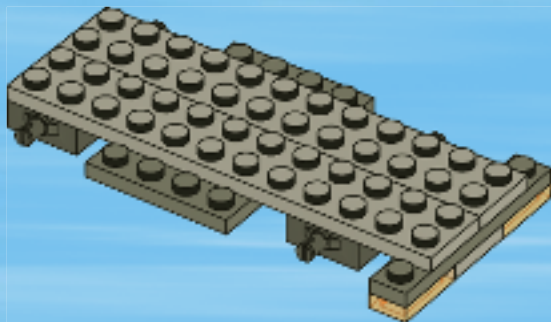

7

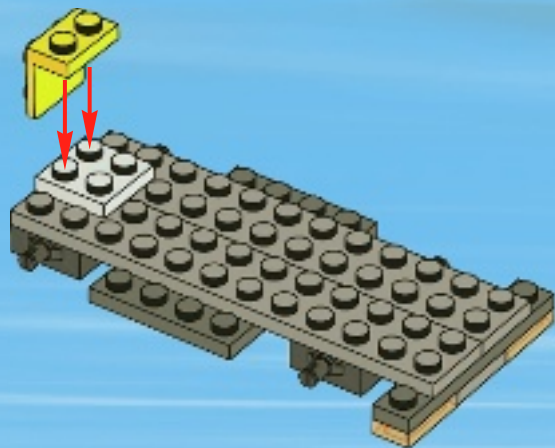

8

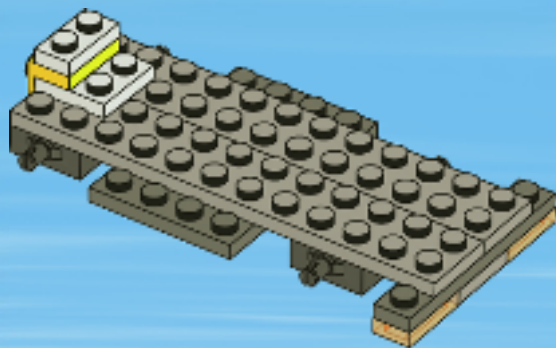

9

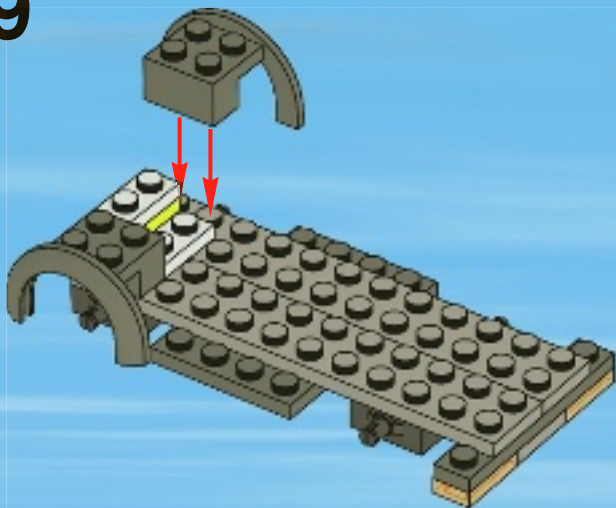

10

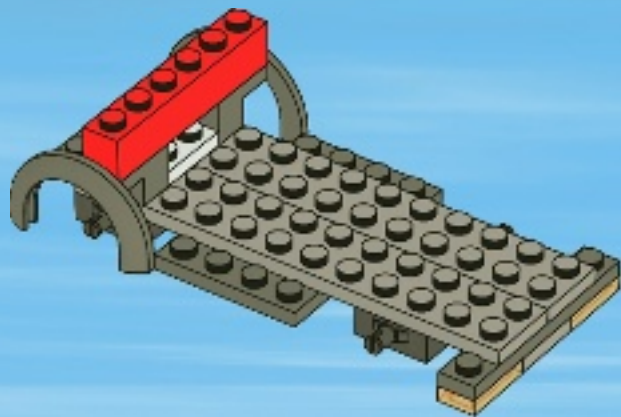

1

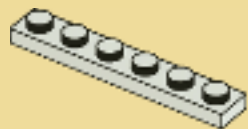

2

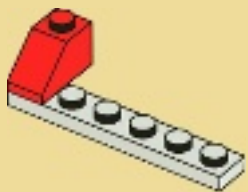

3

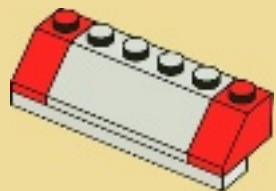

11

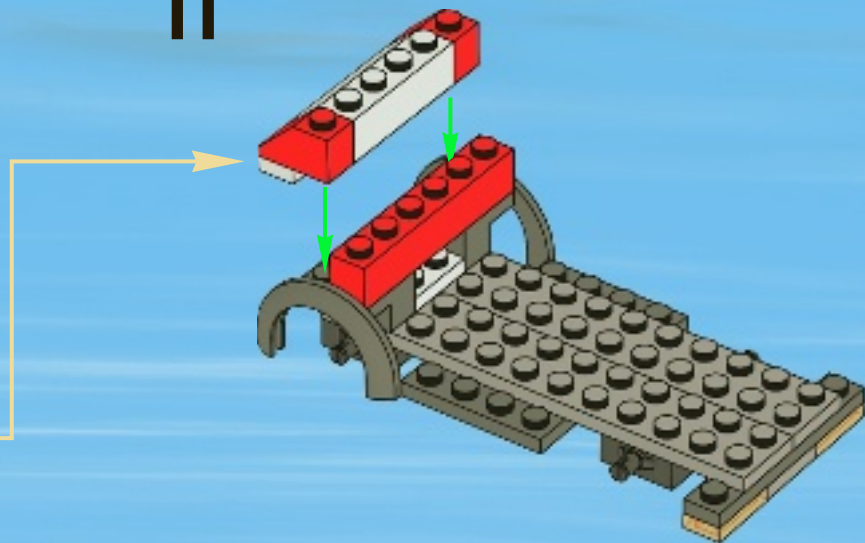

12

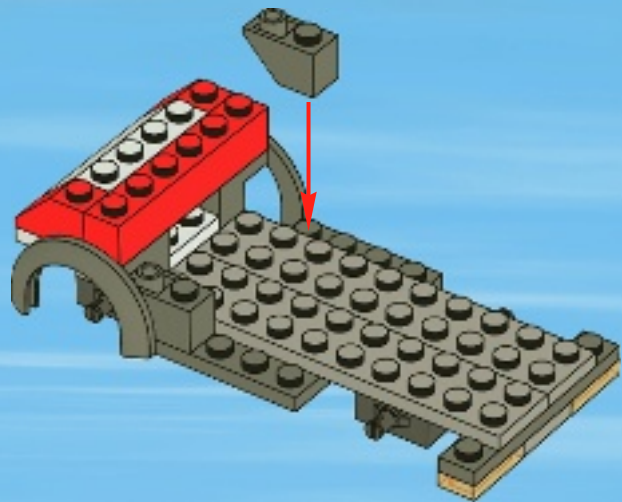

13

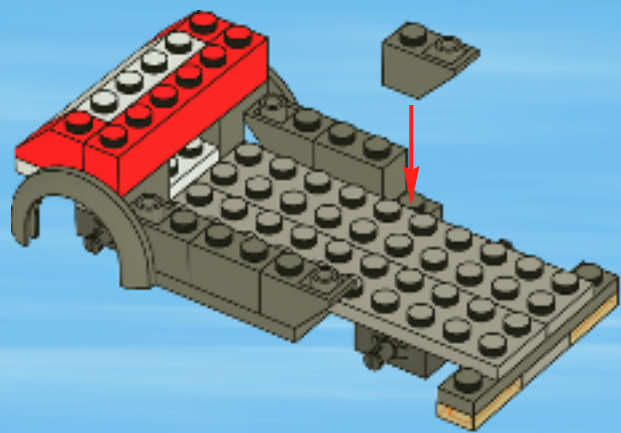

14

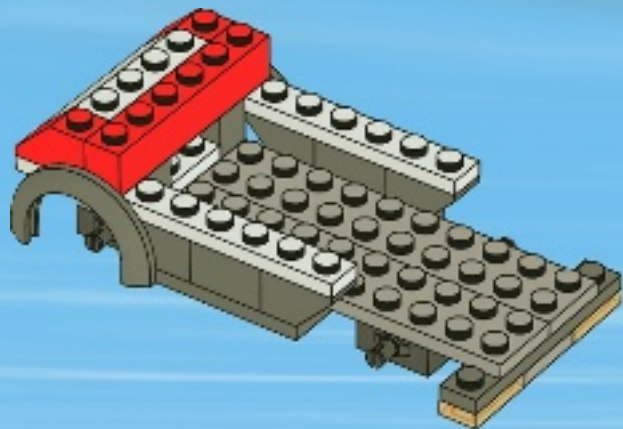

15

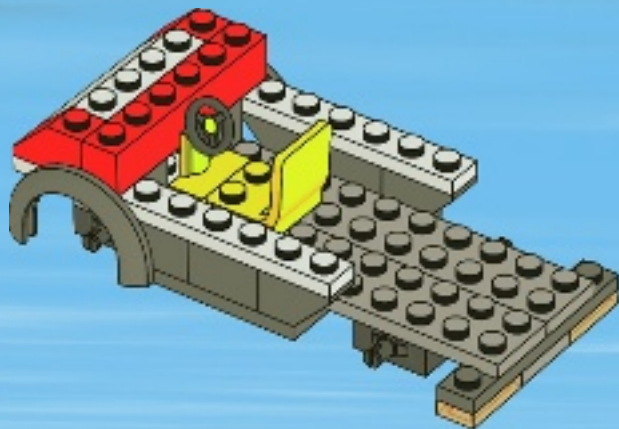

16

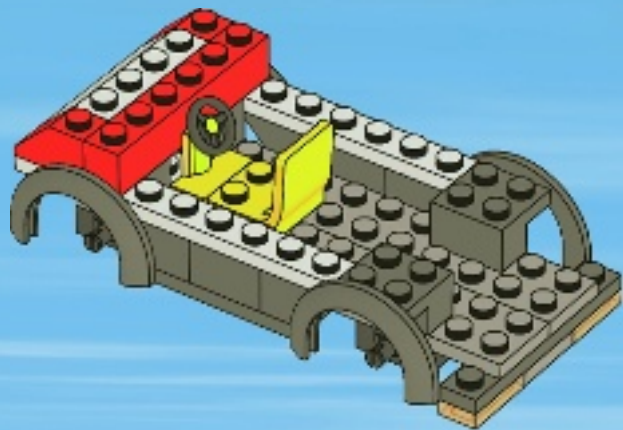

17

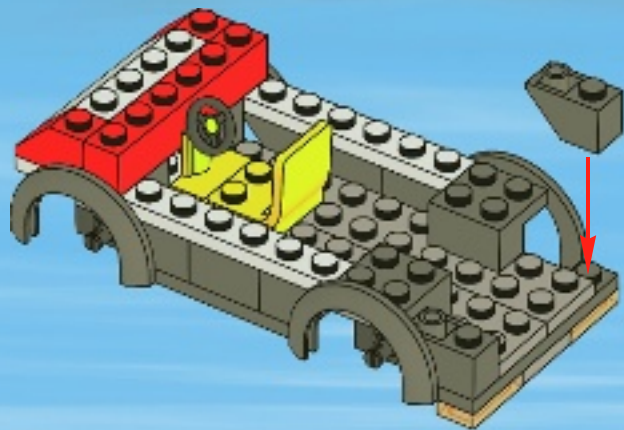

18

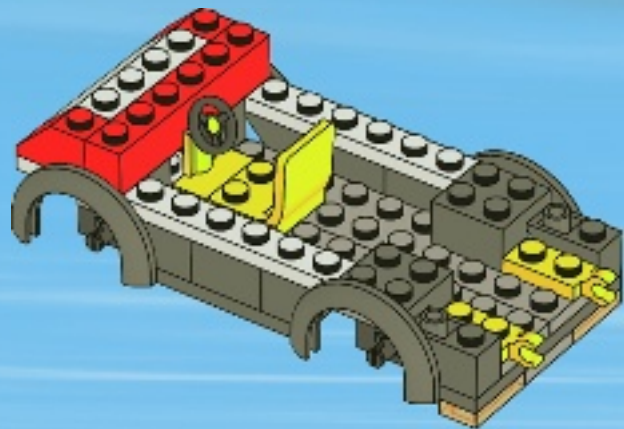

19

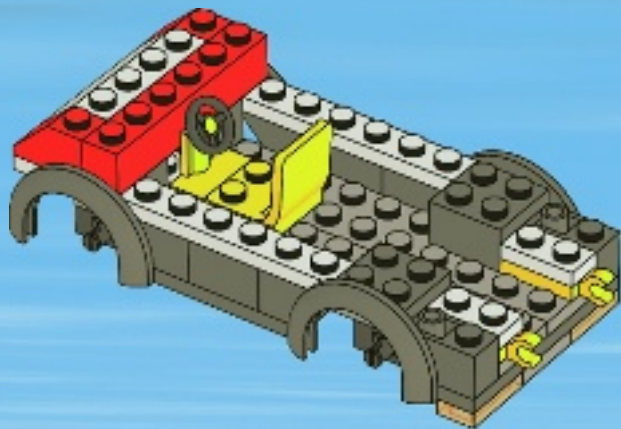

20

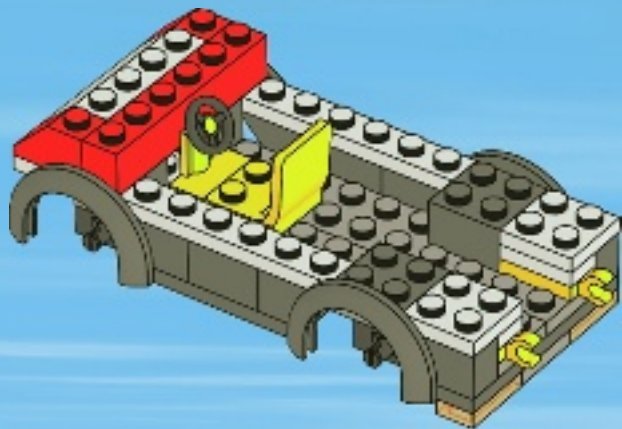

21

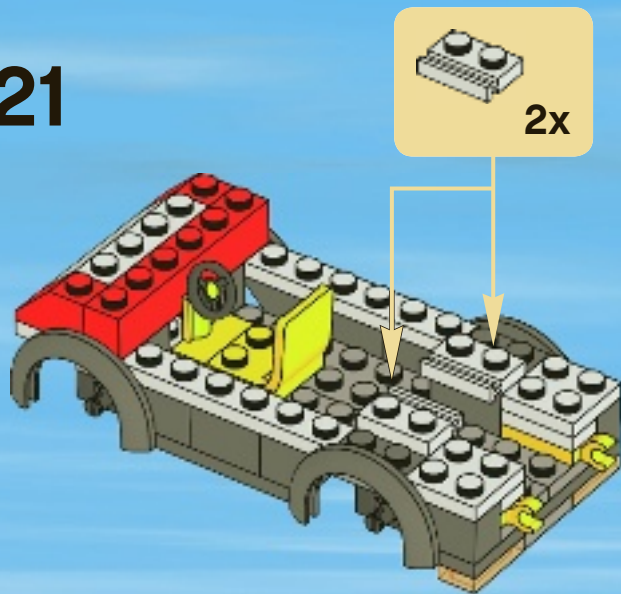



1

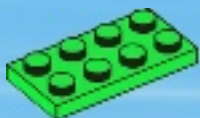

2

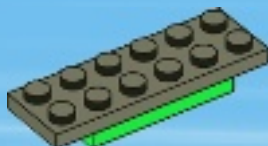

3

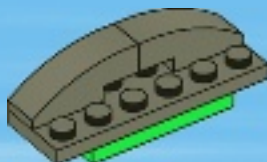

4

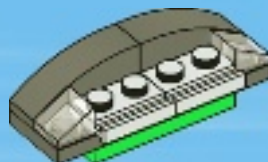

5

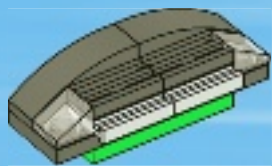

22

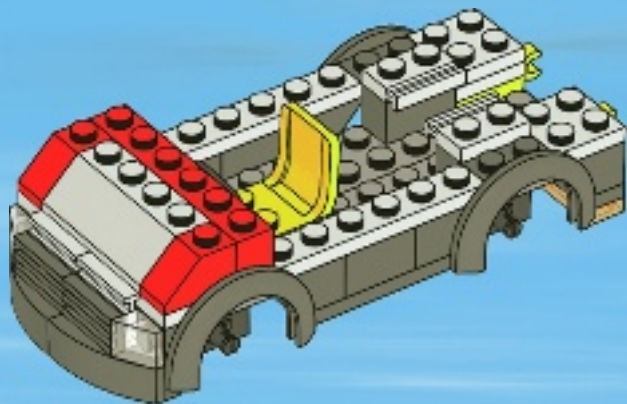

23

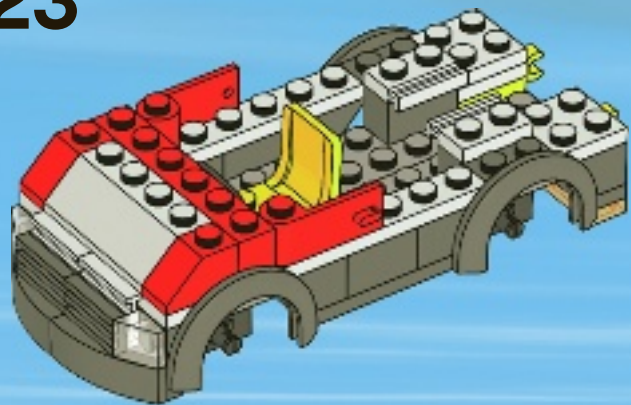

24

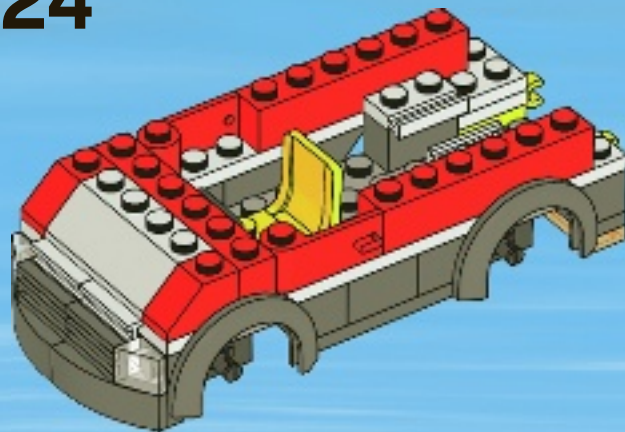

25

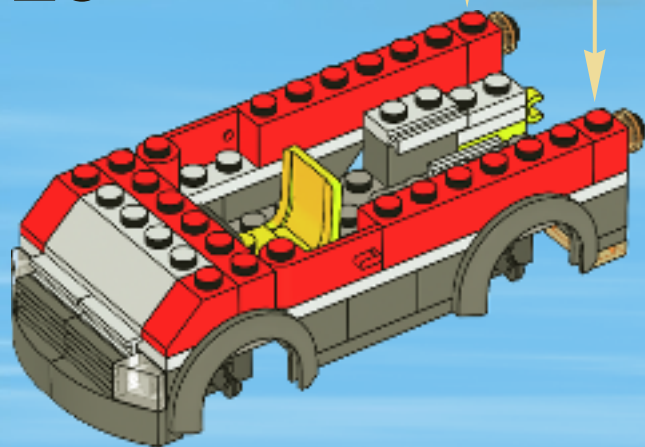

26

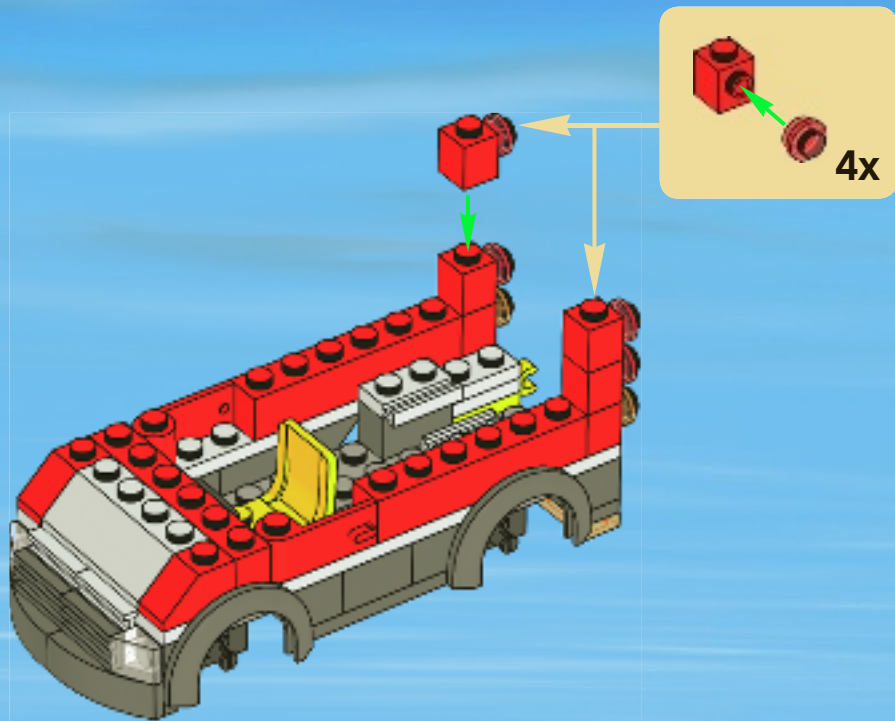

27

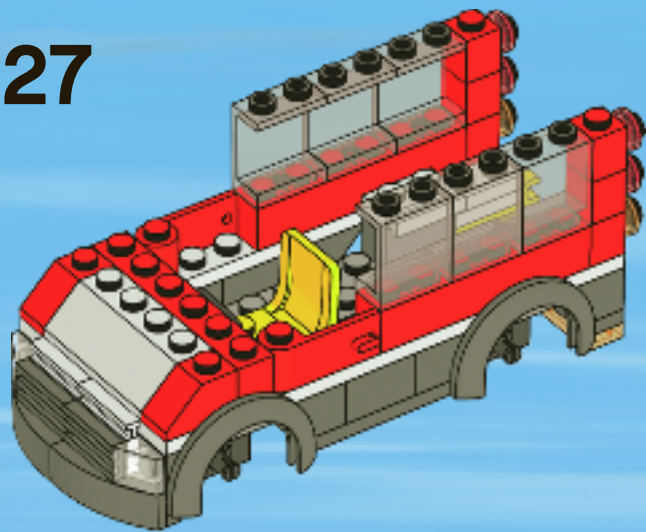

28

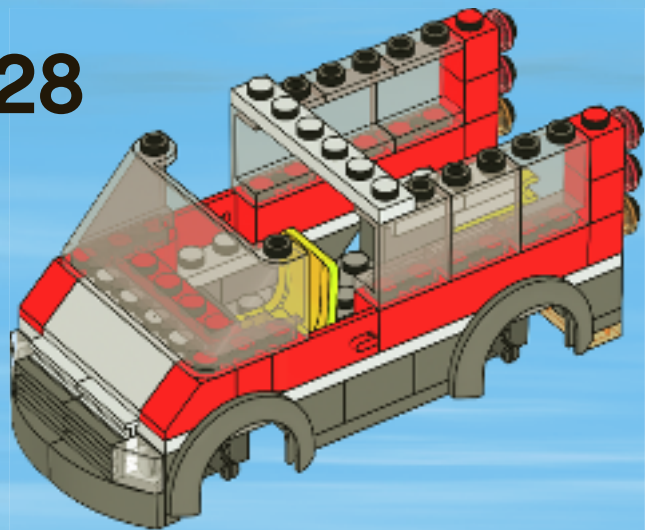

29

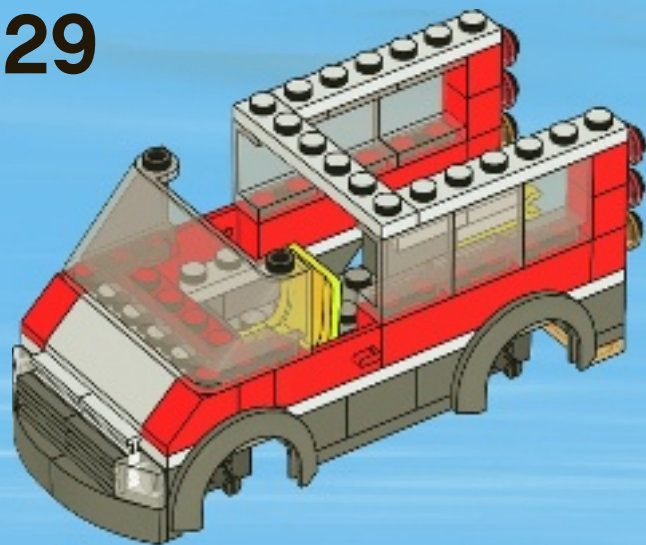

30

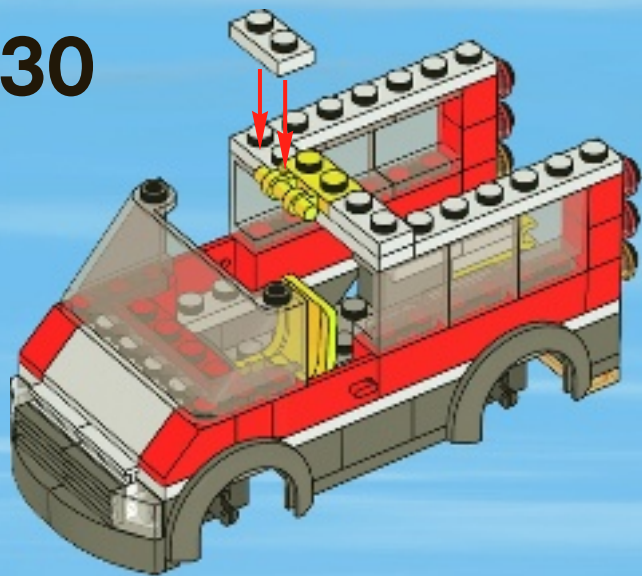

31

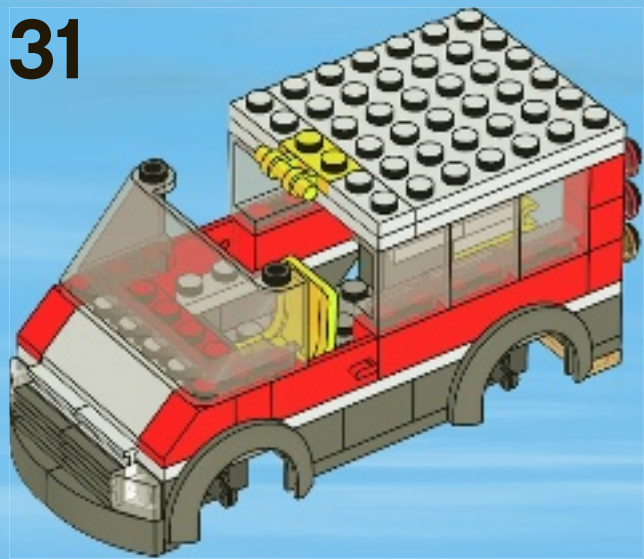

32

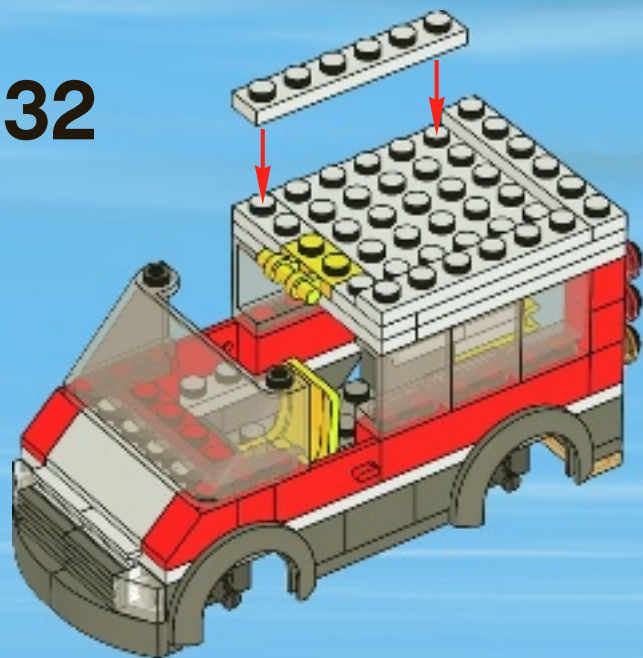

33



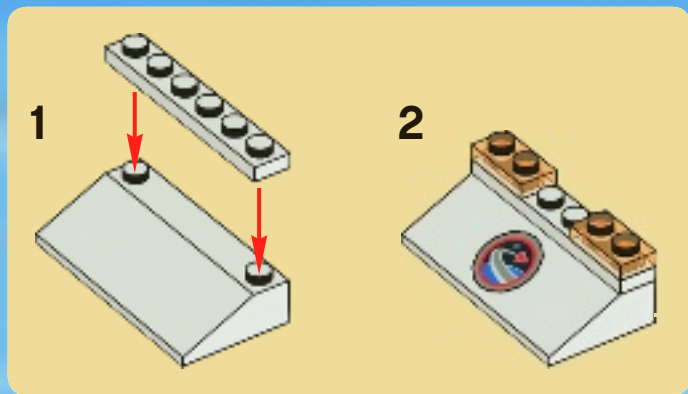

34

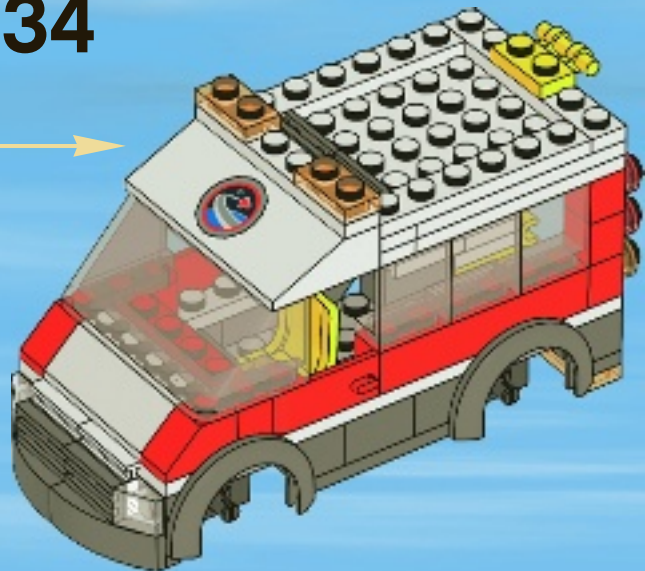

1

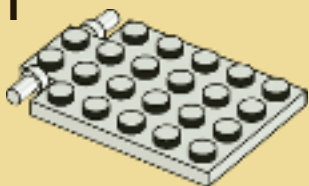

2



3



35

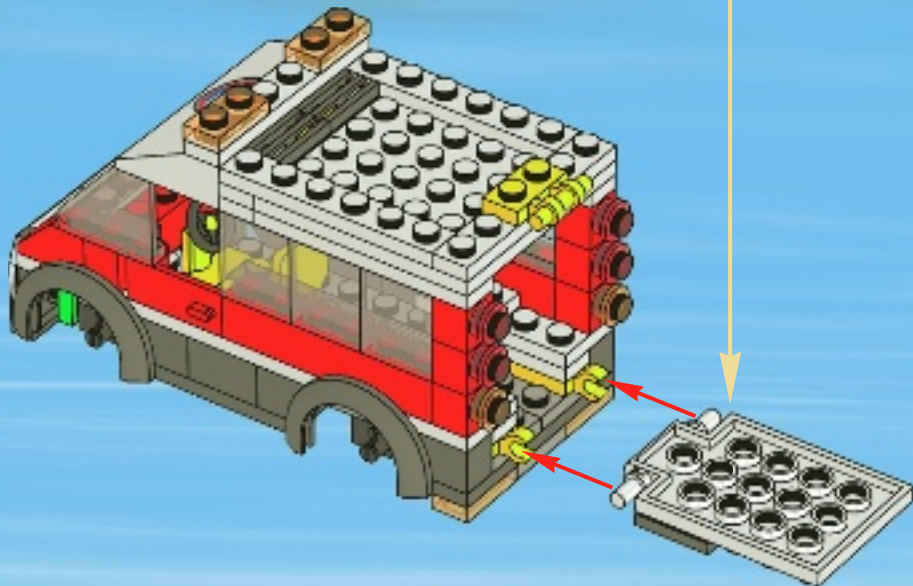

1

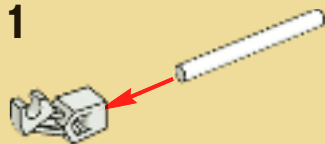

2

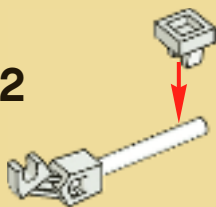

3

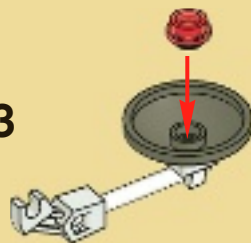

36

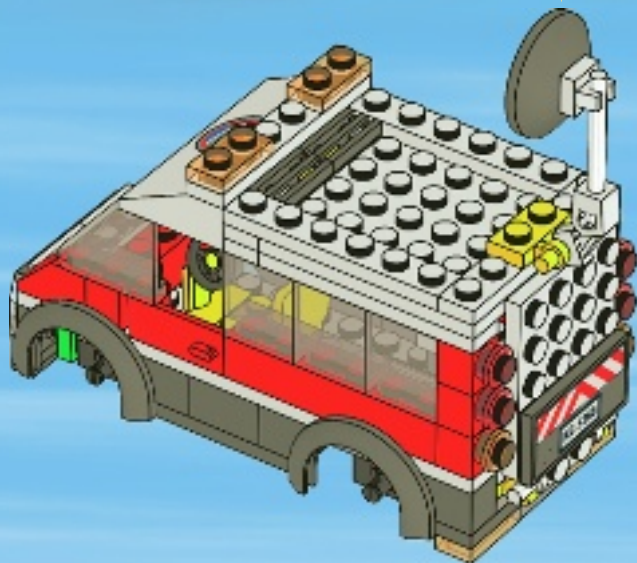

37



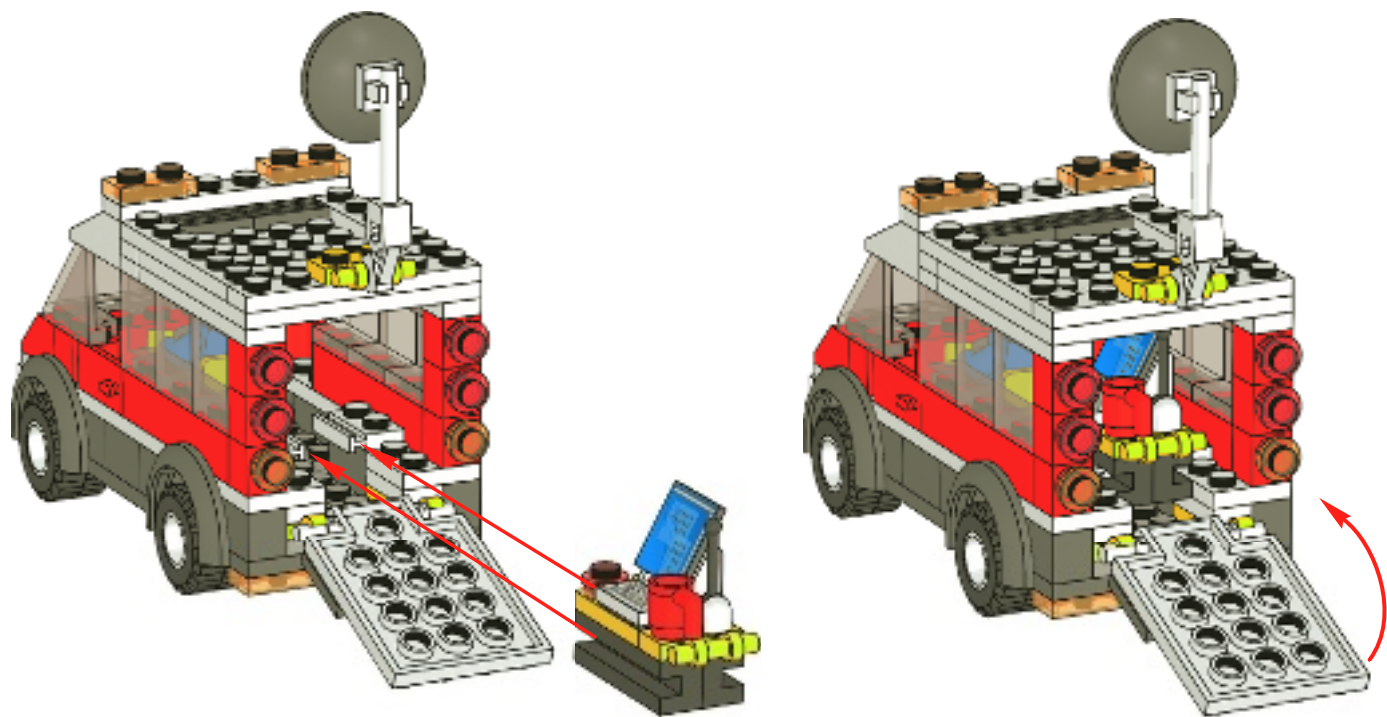

The LEGO logo is displayed in its characteristic white font with a black outline, set against a red rectangular background.The word "CITY" is written in a large, light blue, blocky font with a slight shadow effect, positioned to the right of the LEGO logo.

438 days was the longest duration For a single human space mission.

La mission spatiale humaine la plus longue en un seul vol a été de 438 jours.

La misión espacial más larga en la que han intervenido seres humanos duró 438 días.

NASA Astronaut



The Hubble Space Telescope is almost the size of a school bus and can fit inside a Space Shuttle payload bay.

Le Télescope Spatial Hubble est presque de la taille d'un bus scolaire et peut être placé dans la soute d'une navette spatiale.

El Telescopio Espacial Hubble tiene casi el tamaño de un autobús escolar y cabe dentro de la bodega de carga de un transbordador espacial.



NASA Space Shuttle



The LEGO CITY logo is located in the top left corner. It consists of the word "LEGO" in its signature white font with a black outline, set against a red square background. To the right of this square, the word "CITY" is written in a large, white, sans-serif font with a slight shadow effect.The word "CITY" is part of the LEGO CITY branding, positioned to the right of the red LEGO logo square.A LEGO astronaut minifigure is shown in the bottom left corner, viewed from behind. It has a white body, a gold helmet, and a grey backpack. The minifigure is positioned as if looking out at the planet Mars.

**The size of the ISS
(International Space Station) is 108 by 74 meters - longer than an
American Football Field (including end-zones).**

La taille de l'ISS (Station Spatiale Internationale) est de 108 par 74 mètres. Elle est plus longue qu'un terrain de Football américain.

La EEI (Estación Espacial Internacional) mide 108 x 74 metros; su longitud supera a la de un campo de Fútbol americano (incluyendo los extremos).

The ISS (International Space Station) passes over 90% of the world's population.

L'ISS (station spatiale internationale) survole plus de 90 % de la population mondiale.

La EEI (Estación Espacial Internacional) sobrevuela al 90% de la población mundial.

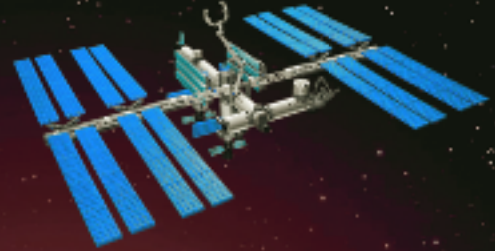

ISS • International Space Station





CITY



**The Hubble Space Telescope
orbits 353 miles above the surface of the Earth.**

Le Télescope Spatial Hubble orbite à environ 569 km de la surface de la Terre.

El Telescopio Espacial Hubble orbita a 569 kilómetros sobre la superficie de la tierra.

NASA Hubble Space Telescope



If you could see as well as the Wide Field and Planetary Camera on the Hubble Space Telescope, you would be able to read the fine print on a newspaper one mile away.

Si vous pouviez voir aussi bien que le champ large et la caméra planétaire du Télescope Spatial Hubble, vous seriez capable de lire les petits caractères d'un journal à une distance de 1,6 km.

Si tu agudeza visual fuese equivalente a la de la cámara planetaria y de gran angular con la que cuenta el Telescopio Espacial Hubble, serías capaz de leer la letra pequeña de un periódico a un kilómetro y medio de distancia.





CITY

In collaboration with NASA, En collaboration avec la NASA,
En colaboración con la NASA.

**If someone next to you
shouted in the vacuum of space you wouldn't
be able to hear them.**

Si une personne située à côté de vous dans le vide spatial
criait, vous ne pourriez pas l'entendre.

Si alguien gritara junto a ti en el vacío del espacio, no
podrías oírle.

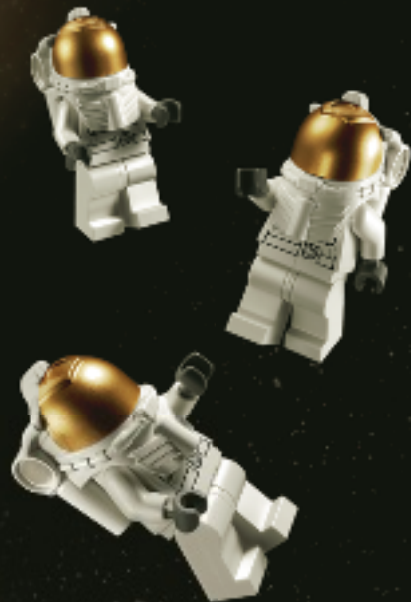

LEGO CITY



3365



3366



3367



3368



CITY



50

7279



7285



7286



7287



7288



7498

LEGO

CITY



7942



7239



7207



7208



CITY



3177



3178



3179



3180



3181



3182



CREATOR

5766





www.LEGOclub.com



LEGO Club Email



LEGO Club Magazine

LEGO club™

FREE! GRATIS! GRATUIT!

SIGN UP ONLINE!

www.LEGOclub.com



00800 5346 5555*



1-866-534-6258 • 1-877-518-5346

US & Canada only

One-time enrollment

- * Freephone. Mobile charges may apply.
- * Numéro sans frais. Des frais peuvent s'appliquer avec les téléphones cellulaires.
- * Gebührenfrei. Kosten für Anrufe aus Mobilfunknetzen können abweichen.
- * Gratis telefoonnummer vanaf vaste lijn.
- * Det er et gratis nummer, når du ringer fra fasttelefon.
- * Det är gratis, när du ringer från en fast telefon.
- * Numéro sans frais. Des frais peuvent s'appliquer avec les téléphones portables.

- | | | | | | | | | | |
|---------------|---------------|---------------|---------------|---------------|---------------|---------------|---------------|---------------|---------------|
| 1x
4129836 | 1x
255501 | 1x
394226 | 2x
4216660 | 3x
4140587 | 1x
9553 | 1x
389921 | 4x
4210631 | 2x
4246896 | 6x
3005741 |
| 1x
4602950 | 4x
4249563 | 4x
448826 | 1x
4609276 | 2x
4535740 | 1x
4570663 | 6x
4558886 | 1x
4211010 | 1x
4211056 | 8x
4189803 |
| 1x
243201 | 1x
4293350 | 1x
383926 | 1x
393826 | 1x
407924 | 1x
4567909 | 2x
4121934 | 1x
4210865 | 1x
4211002 | 6x
4280341 |
| 1x
303701 | 5x
302301 | 1x
383926 | 1x
393826 | 1x
393724 | 1x
4548877 | 3x
403221 | 2x
4211088 | 1x
4211002 | 2x
4222960 |
| 1x
4569841 | 4x
302201 | 4x
4514560 | 4x
4514560 | 1x
300424 | 1x
9341 | 1x
4537986 | 6x
4211096 | 1x
4211115 | |
| 1x
4569841 | 1x
4296948 | 2x
265326 | 2x
265326 | 2x
4180814 | 3x
4509915 | 1x
4288209 | 4x
4260124 | 1x
4583688 | |
| 10x
366601 | 4x
4170457 | 1x
302028 | 1x
302028 | 2x
302124 | 1x
4538098 | 3x
300921 | 1x
4560184 | | |
| 1x
4144012 | 1x
73737 | 2x
4244362 | 2x
4244362 | 1x
302124 | 1x
4211639 | 4x
4211483 | | | |
| 1x
4599044 | 4x
614301 | 1x
4599456 | 1x
4599456 | 7x
241224 | 3x
4211360 | | | | |
| | 2x
4194010 | | | 1x
4277925 | | | | | |



Customer Service
Kundenservice
Service Consommateurs
Servicio Al Consumidor

www.lego.com/service or dial

- | | | | | | | | | | | |
|-------------------|--|--|--|--|--|--|--|--|--|--|
| | | | | | | | | | | |
| : 00800 5346 5555 | | | | | | | | | | |
| : 1-800-422-5346 | | | | | | | | | | |



www.LEGO.com

WIN!

Go to www.LEGOsurvey.com/product to fill out a survey for a chance to win a cool LEGO® Product.

No purchase necessary.

Open to all residents where not prohibited.



www.LEGOsurvey.com/product

GEWINNE!

Nimm an der Umfrage auf www.LEGOsurvey.com/product teil und hab die Chance ein cooles LEGO® Produkt zu gewinnen!

Die Teilnahme am Gewinnspiel führt zu keinerlei Kaufverpflichtungen. Teilnahme in allen nicht ausgeschlossenen Ländern möglich.

4625139

WIN!

Ga naar www.LEGOsurvey.com/product, vul een enquêteformulier in en maak kans op een cool LEGO® product.

Geen aankoopverplichting. Iedereen mag deelnemen, uitgezonderd ingezetenden van landen waar een enquêteverbod geldt.

GAGNE!

Visite www.LEGOsurvey.com/product pour répondre à un questionnaire et avoir une chance de gagner un produit LEGO® très cool!

Aucune obligation d'achat. Ouvert à tous les résidents des pays autorisés.

当てよう!

www.LEGOsurvey.com/product にアクセスして、アンケートにご記入ください。当選者にはレゴ®製品を差し上げます。

お買い上げの必要はありません。禁止されていない限り、すべての皆様にご利用いただけます。

LEGO and the LEGO logo are trademarks of the/sont des marques de commerce de/son marcas registradas de LEGO Group. ©2011 The LEGO Group.