



Booklet available in English on  
Livret disponible en français sur  
Folleto disponible en español en



## WELCOME TO LEGO® ART

● Your new LEGO® Art Rolling Stones set is a unique piece of fan art. It's the first of its kind, a celebration of Rock & Roll and creativity, and your personal, creative outlet. Feel the satisfaction of disappearing into your own world and relive your favorite memories from the band's stunning career as you build.

## BIENVENUE À LEGO® ART

● Votre nouvel ensemble LEGO® Art Rolling Stones est une œuvre d'art unique. Premier en son genre, il est une célébration du rock'n'roll et de la créativité, et votre exutoire créatif personnel. Obtenez la satisfaction de plonger dans votre propre univers et de revivre vos souvenirs préférés de l'impressionnante carrière du groupe durant la construction.

## TE DAMOS LA BIENVENIDA A LEGO® ART

● Tu nuevo set LEGO® Art The Rolling Stones es una exclusiva obra de arte para fans. La primera en su género, constituye un homenaje al rocanrol y el ingenio, así como una válvula de escape personal y creativa. Siente la satisfacción de desaparecer en tu propio mundo y repasa tus recuerdos favoritos de la impresionante carrera de la banda mientras construyes.



# BREAKING THE FRAMES OF THE LEGO ART CANVAS

○ The "Lips and Tongue" logo is perhaps the most iconic band logo in the world. The original design is so aesthetically perfect and captures the essence of The Rolling Stones' legacy; a desire for, and celebration of, creative rebellion that spans generations and cultures. This is the first time the logo has been officially created in an artwork like this in LEGO brick form, and I hope music lovers of all ages will love to explore every facet of it.

● Le logo de « lèvres et langue » est sans doute le logo de groupe le plus emblématique. Le concept original est esthétiquement parfait et saisit l'essence de l'héritage des Rolling Stones : un désir et une célébration de la rébellion créative qui traverse les générations et les cultures. C'est la première fois que le logo est officiellement créé dans une œuvre comme celle-ci en briques LEGO, et j'espère que les mélomanes de tous âges aimeront en explorer toutes les facettes.

● El logotipo de "los labios y la lengua" puede ser el emblema de banda más popular del mundo. El diseño original es estéticamente perfecto y plasma la esencia del legado de The Rolling Stones; un deseo de rebelión creativa y un tributo a las ideas relacionadas que trasciende generaciones y culturas. Es la primera vez que el logotipo se representa oficialmente mediante una obra de arte como esta, creada con bricks LEGO, y espero que todos los amantes de la música, independientemente de su edad, disfruten explorando sus facetas.

FIORELLA GROVES  
LEGO Art Creative Lead & Design Manager  
Responsable de la création et de la conception LEGO Art  
Directora creativa y jefa de diseño de LEGO Art

# SORTIR DU CADRE DE LA TOILE LEGO ART

# ROMPEMOS LOS LÍMITES DEL LIENZO LEGO ART



○ It's only a fitting tribute to The Rolling Stones, who transcend barriers in everything they do, that we break the frames of our standard LEGO Art canvas in this set. Triangular, square and rectangular elements make up the logo's organic curves and capture its raw, edgy energy. The model is intuitive and engaging to build, and the colorful built-in layers serve both as technical solutions and foundation for the relief artwork, fun surprises and our hat tip to this colorful band.

● C'est un hommage approprié aux Rolling Stones, qui transcendent les barrières dans tout ce qu'ils font, de sortir du cadre de notre toile LEGO Art standard pour cet ensemble. Des éléments triangulaires, carrés et rectangulaires forment les courbes organiques du logo et saisissent son caractère cru et son énergie. Le modèle est intuitif et engageant à construire, et les couches colorées intégrées servent à la fois de solutions techniques et de base pour les reliefs, en plus de rendre hommage à ce groupe haut en couleur.

● Es un justo reconocimiento a The Rolling Stones, que superan todas las barreras con cada cosa que hacen, que rompamos los límites del lienzo LEGO Art estándar en este set. Usamos elementos triangulares, cuadrados y rectangulares para conformar las curvas orgánicas del logotipo y captar su intensa e incisiva energía. El modelo es intuitivo de construir y resulta cautivador. Las vistosas capas que integra cumplen una función técnica, pero también sientan las bases del trabajo de relieve, las divertidas sorpresas y el respeto por la peculiar banda que queríamos incluir en la creación.

ANNEMETTE BAASKJÆR NIELSEN  
LEGO Art Model Designer  
Conceptrice de modèles LEGO Art  
Modelista de LEGO Art



## L'HISTOIRE DERRIÈRE LE CÉLÈBRE LOGO DE « LÈVRES ET LANGUE »

● Le concept original du logo de « lèvres et langue » a été créé par un jeune étudiant en art, John Pasche, en 1970. Inspiré par la musique et la culture indiennes, le groupe présente à Pasche une image de la déesse hindoue Kali (généralement représentée avec la langue tirée) comme référence. Pasche opte pour une interprétation moderne, élégante, stylisée et audacieuse. L'image saisissante devient instantanément synonyme du groupe et de sa maison de disques, Rolling Stones Records, après être apparue sur la couverture et la pochette de l'album *Sticky Fingers* en 1971. Le logo marque une nouvelle ère pour la musique, la culture, la mode et l'art, et les amateurs l'adoptent rapidement comme symbole de l'esprit contestataire, de la créativité sans compromis et de l'expression libre de soi.

Depuis sa création, le logo figure sur tous les albums des Rolling Stones. Au fil des ans, différents artistes ont créé des versions uniques pour des éditions et des occasions spéciales. Son esthétisme intemporel séduit toujours les amateurs et fait partie intégrante des supports graphiques, de la scénographie et des produits dérivés du groupe.

## THE STORY BEHIND THE FAMOUS "LIPS AND TONGUE" LOGO

● The original "Lips and Tongue" design was created by a young art student, John Pasche, in 1970. Inspired by Indian music and culture, the band presented Pasche with an image of the Hindu goddess Kali (usually portrayed with her tongue sticking out) as a style reference. Pasche opted for a modern interpretation that was sleek, stylish and fittingly defiant. The striking image became instantly synonymous with the band and their recording label, Rolling Stones Records, after it appeared on the *Sticky Fingers* album cover and sleeve in 1971. It epitomized a new era in music, culture, fashion and art and fans immediately embraced the logo as a symbol of anti-establishment, unapologetic creativity and free-spirited self-expression.

The logo has been on every Rolling Stones album since. Over the years, various artists have created unique iterations for special releases and occasions. Its timeless aesthetic still appeals to fans of all ages and is an integrated part of the band's graphic materials, scenography and merchandise.

## LA HISTORIA DEL FAMOSO LOGOTIPO DE "LOS LABIOS Y LA LENGUA"

● El diseño original de "los labios y la lengua" fue creado por John Pasche, un joven estudiante de arte, en 1970. Inspirándose en la música y la cultura de la India, el grupo le presentó a Pasche una imagen de la diosa hindú Kali (normalmente representada con la lengua fuera) como referencia de estilo. Pasche optó por una interpretación más moderna, elegante y apropiadamente desafiante. La llamativa imagen se convirtió de inmediato en sinónimo de la banda y su sello discográfico, Rolling Stones Records, luego de aparecer en la portada y la funda del álbum *Sticky fingers* en 1971. El logotipo representaba los elementos fundamentales de una nueva era para la música, la cultura, la moda y el arte, y los fans lo aceptaron desde el principio como un símbolo de la lucha contra el sistema, la creatividad sin complejos y la autoexpresión de espíritu libre.

La ilustración ha formado parte de todos los álbumes de The Rolling Stones desde entonces. A lo largo de los años, numerosos artistas han creado diferentes versiones con motivo de lanzamientos y ocasiones especiales. Su estética intemporal sigue seduciendo a fans de todas las edades y formando parte de los materiales gráficos, la escenografía y los productos promocionales de la banda.



## ROLLING MILESTONES

● Formed in 1962, The Rolling Stones first knocked the socks off the world of music, and the world in general, with *(I Can't Get No) Satisfaction* in 1965. It's hard to overstate the influence the band has had on music history and culture over the span of six decades (and counting), from defining the early roots of Rock & Roll to dominating world stages and playlists in the age of digital music. With dozens of albums and thousands of breathtaking and charismatic performances, they remain one of the best-selling groups of all time.

The members of The Rolling Stones, as well as their famous logo, have long been brands in their own rights and synonymous with the original British Rock & Roll lifestyle, always challenging the status quo, and inspiring generations to express their creativity in their own ways. Influenced by different genres and world music, they have incorporated blues, punk, R&B, jazz, country, psychedelic music, disco, ballads and much more into their music, always with authenticity and curiosity. With equal parts reckless abandon and profound respect for all genres, they continually surprise their audiences and make room for each other's creative twists and playful experiments.



## MOMENTS MARQUANTS

● Formé en 1962, le groupe The Rolling Stones frappe le monde de la musique, et le monde en général, avec *(I Can't Get No) Satisfaction* en 1965. La contribution du groupe à l'histoire et à la culture musicales au fil de six décennies (à ce jour) est phénoménale, de la fondation des premières racines du rock à la domination des scènes mondiales et des listes de lecture à l'ère du numérique. Avec des dizaines d'albums et des milliers de concerts époustouffants, il demeure l'un des groupes les plus populaires de tous les temps.

Les membres des Rolling Stones, ainsi que leur célèbre logo, sont depuis longtemps des marques à part entière et des synonymes du style de vie rock'n'roll britannique original, qui contestent toujours le statu quo et inspirent des générations à exprimer leur créativité à leur façon. Influencés par différents genres et musiques du monde, ils ont incorporé entre autres le blues, le punk, le R&B, le jazz, le country, la musique psychédélique, le disco et les ballades dans leur musique, toujours avec authenticité et curiosité. Avec autant d'abandon désinvolte que de respect profond pour tous les genres musicaux, ils ne cessent de surprendre leur public et laissent place à la créativité et aux expériences ludiques de chacun.

## MOMENTOS DESTACADOS

● Formada en 1962, The Rolling Stones tomó por sorpresa al sector musical, y al mundo en general, con *(I Can't Get No) Satisfaction* en 1965. Es difícil sobrevalorar la influencia que la banda ha tenido en la historia y la cultura de la música a lo largo de seis décadas (y sumando), desde que definiera las raíces primigenias del rocanrol hasta llegar a dominar los escenarios y las listas de reproducción de todo el mundo en la era de la música digital. Con docenas de álbumes y miles de impresionantes y carismáticas actuaciones, el grupo sigue siendo uno de los más vendidos de todos los tiempos.

Los miembros de The Rolling Stones, al igual que su famoso logotipo, han sido durante mucho tiempo marcas por derecho propio y sinónimos del estilo de vida original del rocanrol británico, desafiando constantemente lo establecido y animando a generaciones a expresar su creatividad según sus propios criterios. Influidos por diferentes géneros y músicas del mundo, han hecho suyos el blues, el punk, el R&B, el jazz, el country, la música psicodélica, la música disco, la balada y otros muchos estilos, siempre con autenticidad y curiosidad. Con un temerario abandono y un profundo respeto por todos los géneros a partes iguales, no dejan de sorprender a su público ofreciendo espacio a los creativos giros e inusuales experimentos que propone cada uno.

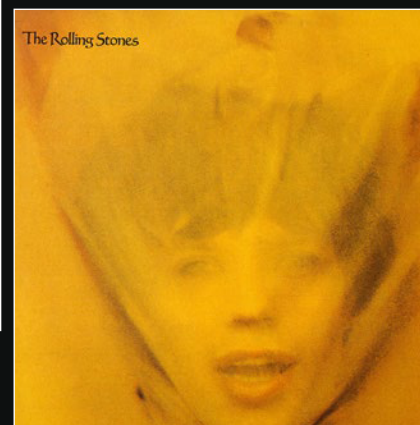
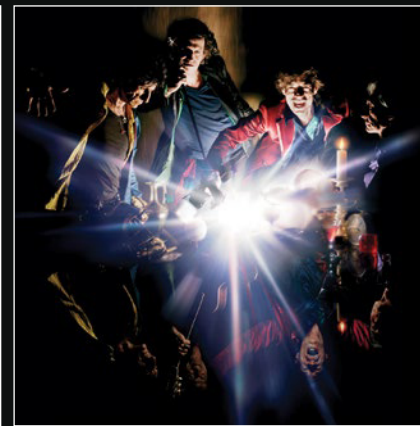
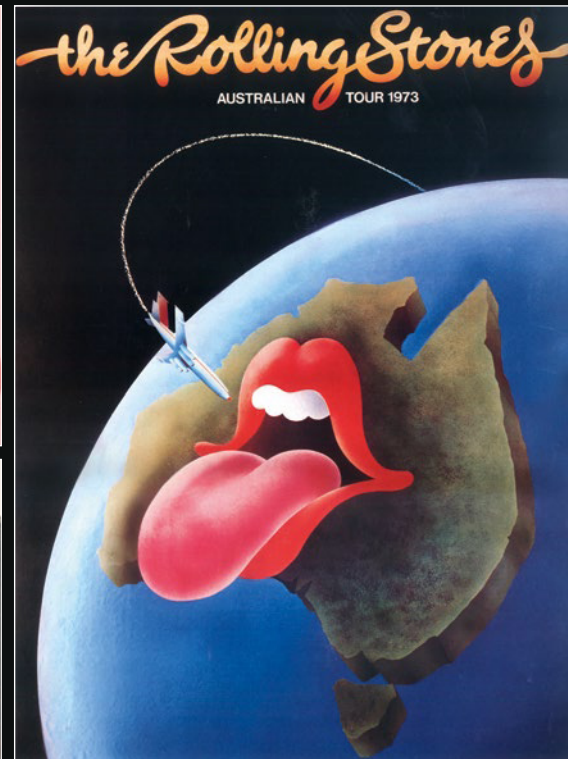
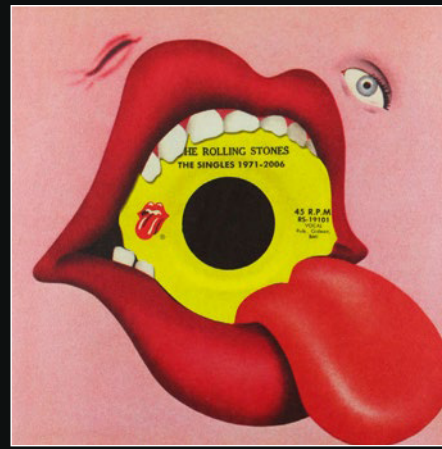



## BUILD AND DISPLAY YOUR WAY

● Every LEGO® Art element plays a part in the big picture but, in the spirit of creativity, who are we to say you can't rebuild it your way? Get an all-access backstage pass to the stories and inspiration behind both the logo and the LEGO Art design as you build – just download the exclusive Soundtrack and press play. (Sorry, not available on vinyl.) And then all you need to do is find the perfect place to display your own piece of Rock & Roll art history.

## CRÉEZ ET EXPOSEZ À VOTRE FAÇON

● Chaque élément LEGO® Art joue un rôle dans l'image globale, mais qui sommes-nous pour dire que vous ne pouvez pas le reconstruire à votre façon ? Accédez aux coulisses des histoires et découvrez l'inspiration derrière le logo et le concept LEGO Art pendant que vous construisez. Téléchargez la bande sonore exclusive et lancez la lecture. (Malheureusement non disponible en vinyle.) Il ne vous reste plus qu'à trouver l'endroit idéal pour exposer votre propre pièce de l'histoire de l'art du rock.



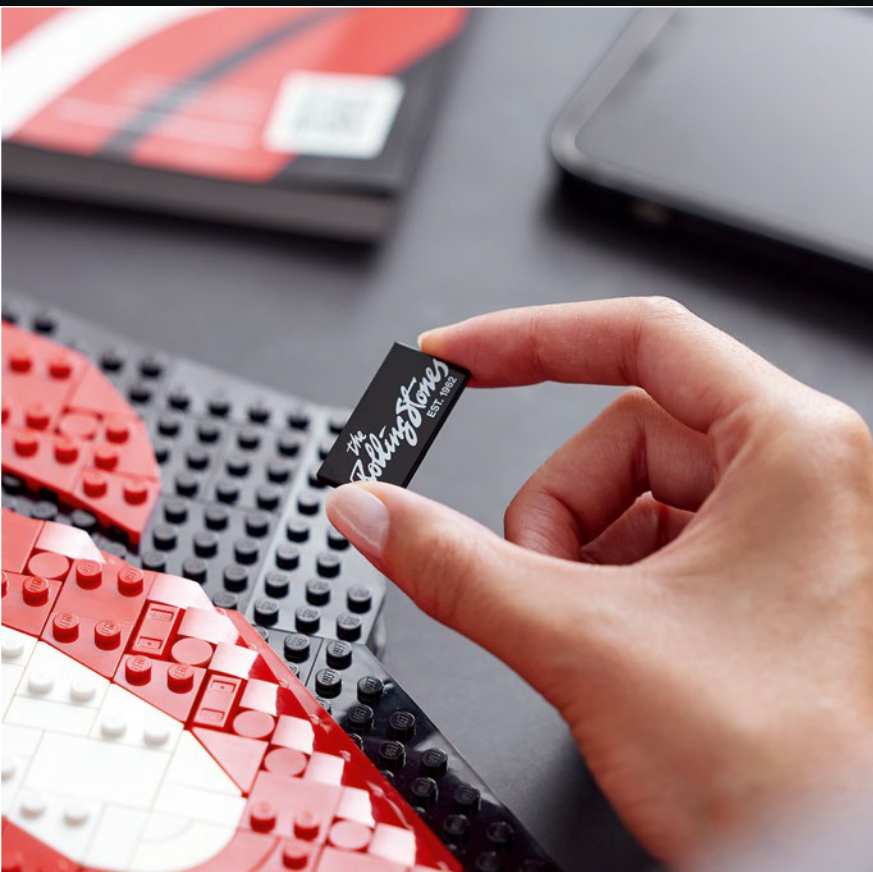

## CONSTRUYE Y DECORA A TU MANERA

• Todos los elementos LEGO® Art interpretan un papel en el cuadro general. No obstante, en defensa de la creatividad, ¿quiénes somos nosotros para decirte que no puedes reconstruir el modelo a tu manera? Obtén un pase de acceso total tras bambalinas para conocer las historias y la inspiración que rodean al logotipo y el diseño del modelo LEGO Art mientras construyes: solo tienes que descargar la banda sonora exclusiva e iniciar la reproducción. (Lo sentimos, no está disponible en vinilo). Luego, todo lo que tienes que hacer es encontrar el lugar perfecto para exhibir tu propio fragmento de la historia del arte y el rocanrol.

 **SOUNDTRACK**  
Only in English  
**BANDE SONORE**  
En anglais uniquement  
**BANDA SONORA**  
Disponibile solo en inglés

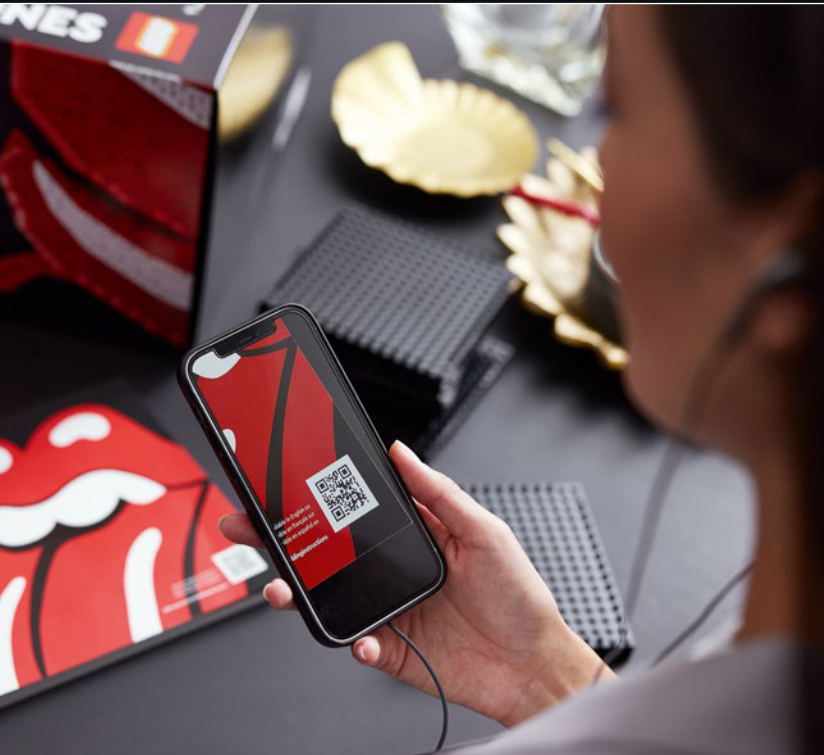

## LISTEN

● Scan the QR code to tune into the exclusive Soundtrack curated around the LEGO® Art Rolling Stones set.

## BUILD

Channel your inner (or outer) Rock & Roll star as you build and watch your artwork take form.

## RELAX

This set is your personal VIP ticket to unwind, de-stress and relax with a tribute to your favorite band.

## ÉCOUTER

● Scannez le code QR pour écouter la bande sonore créée exclusivement pour l'ensemble LEGO® Art Rolling Stones.

## CONSTRUIRE

Réveillez l'étoile du rock qui sommeille en vous et regardez votre œuvre prendre forme.

## SE DÉTENDRE

Cet ensemble est votre laissez-passer VIP pour la détente avec un hommage à votre groupe préféré.

## ESCUCHA

● Escanea el código QR y sintoniza la exclusiva banda sonora seleccionada para el set LEGO® Art The Rolling Stones.

## CONSTRUYE

Canaliza a la estrella del rocanrol que llevas dentro (o que todos conocen) mientras construyes y ves cómo tu obra de arte va tomando forma.

## RELÁJATE

Este set es un boleto vip personal para un evento que te ayudará a desconectarte, desestresarte y relajarte rindiéndole tributo a tu banda favorita.

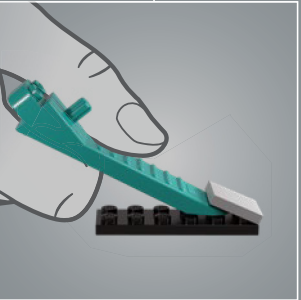
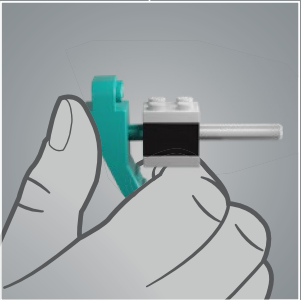
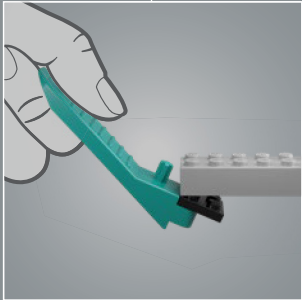
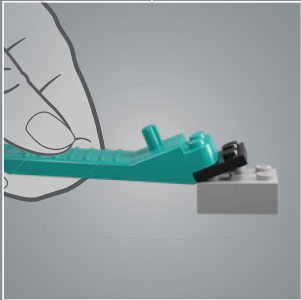
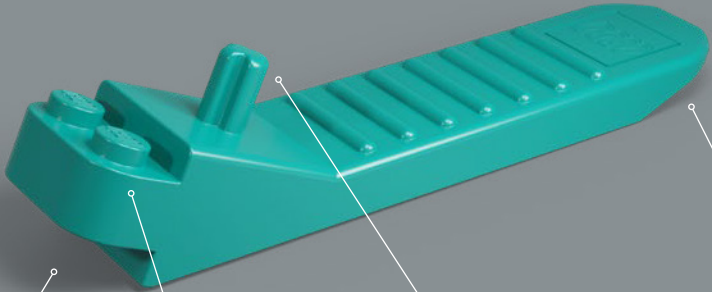

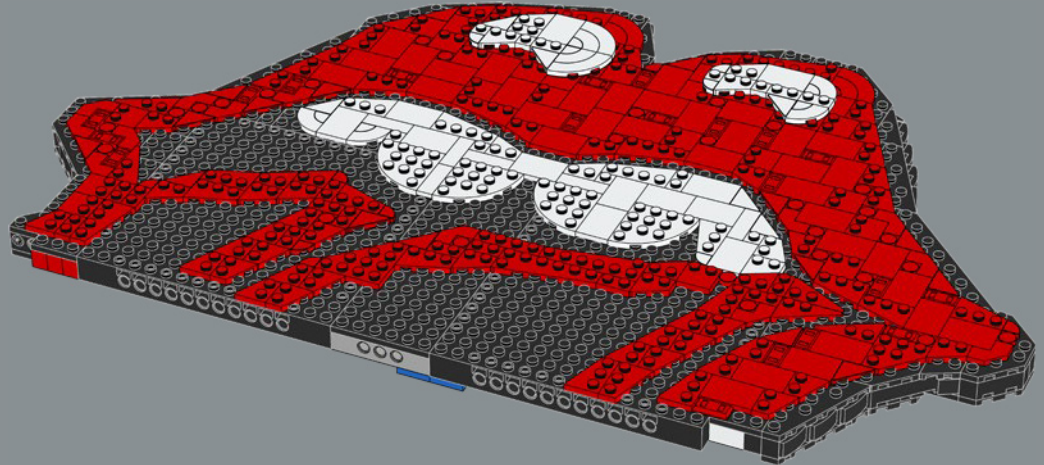
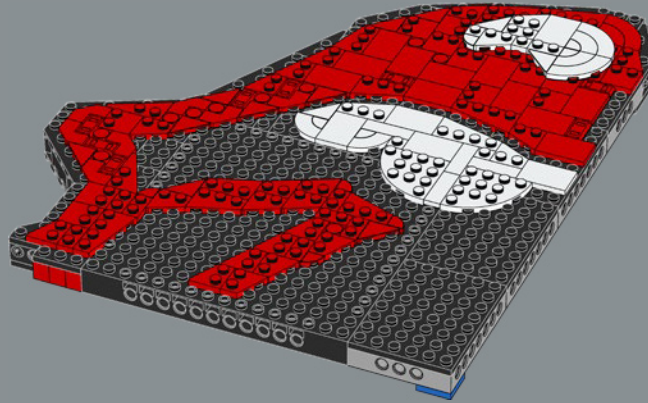

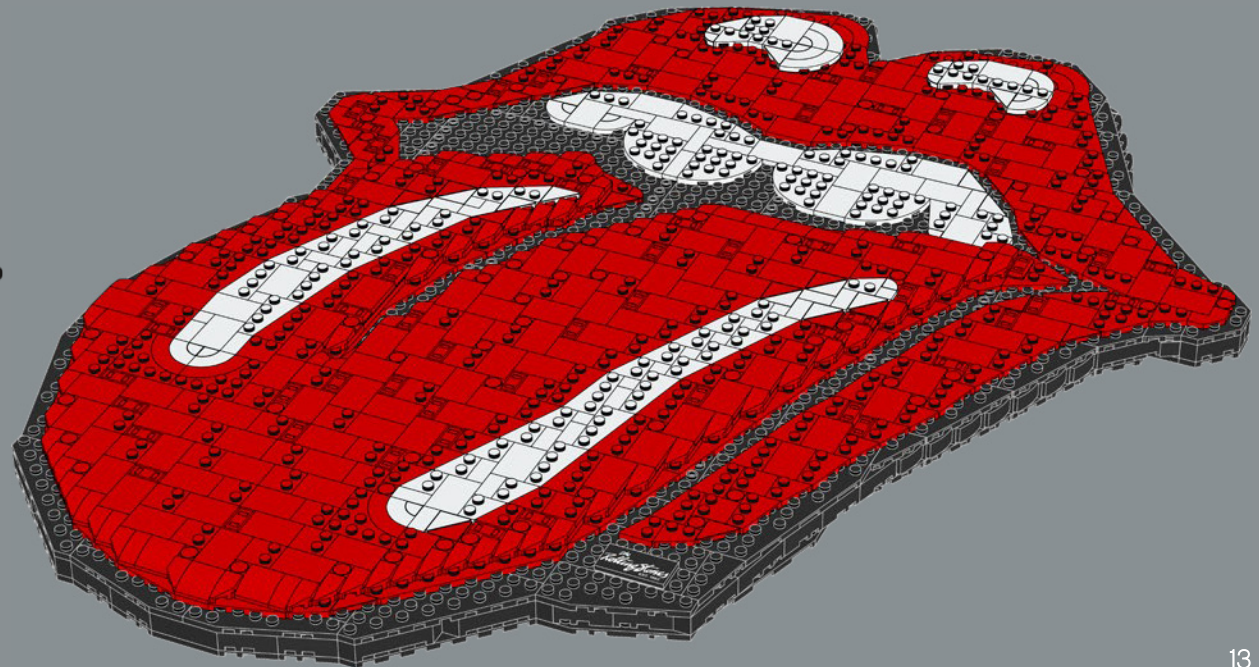
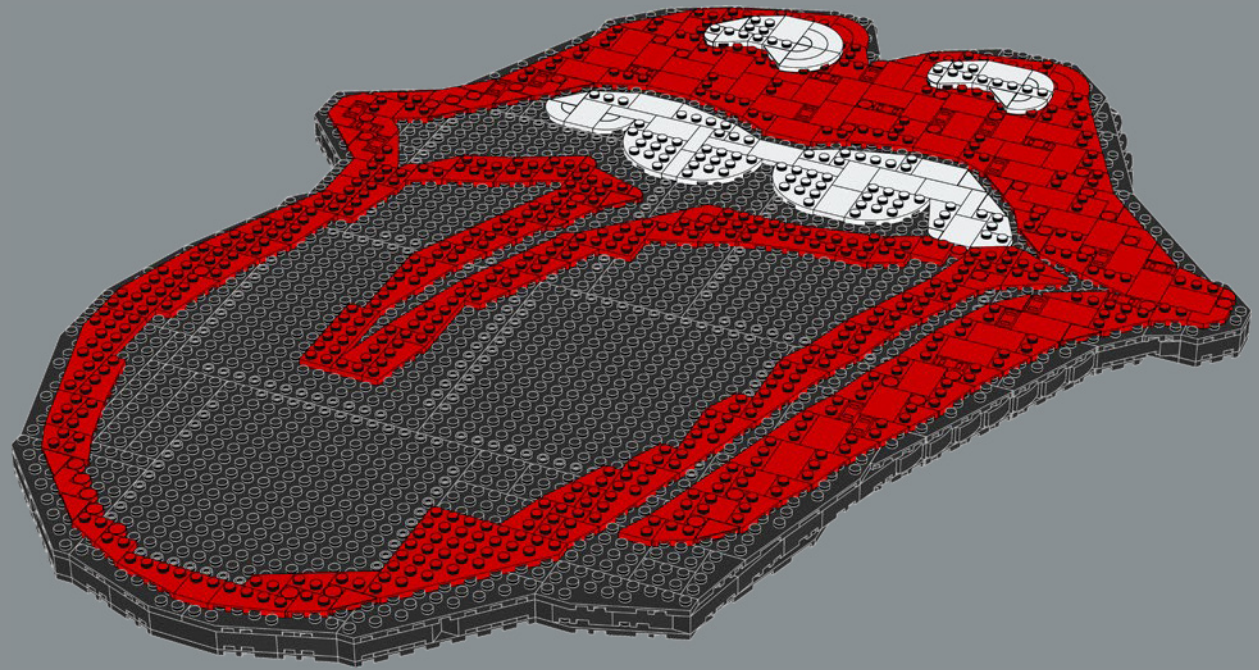

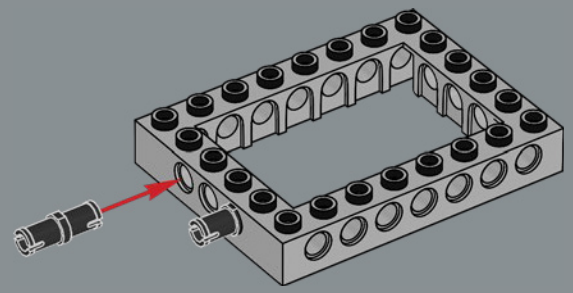
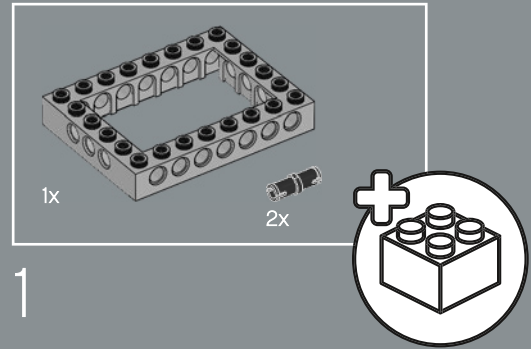
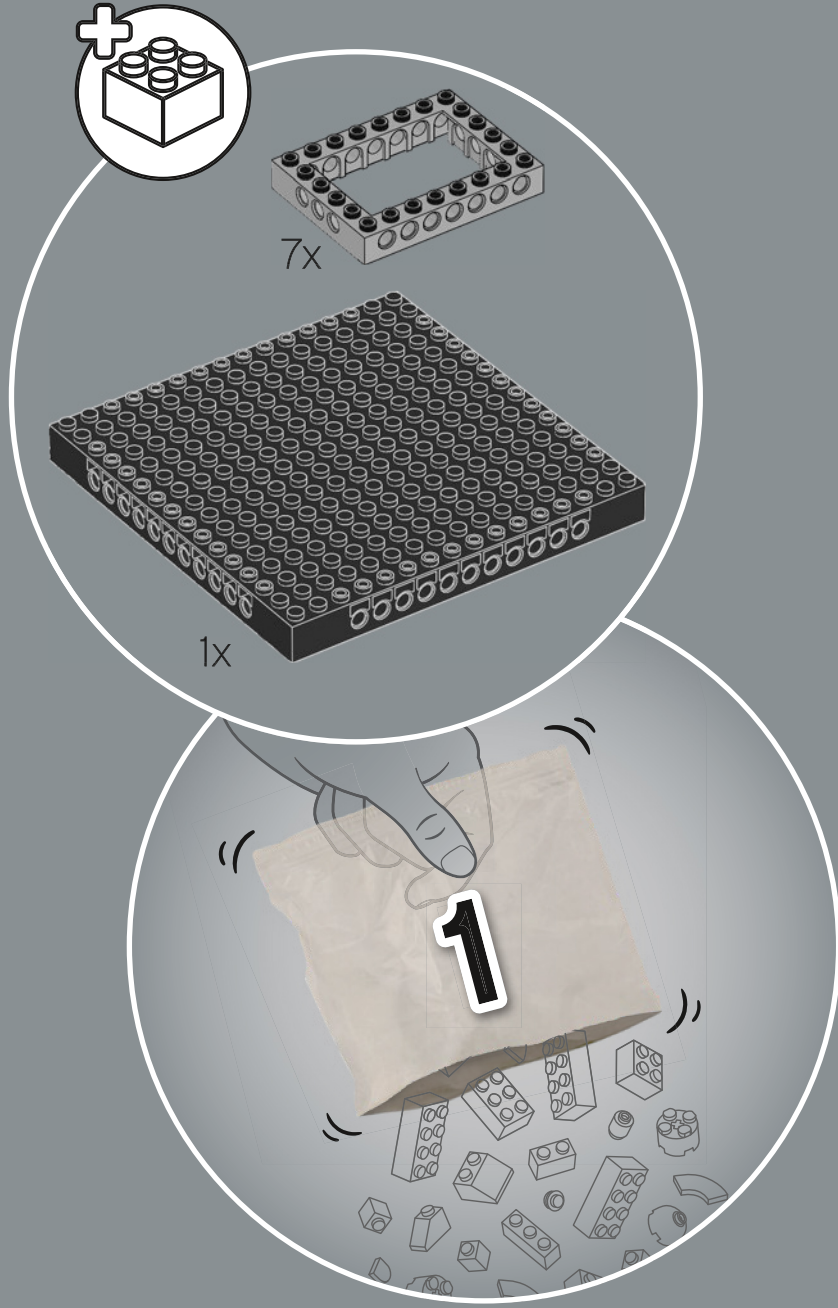

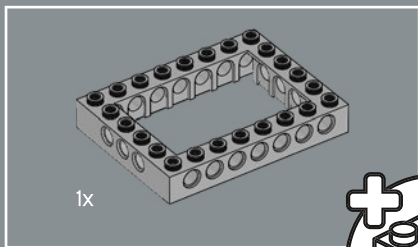

2

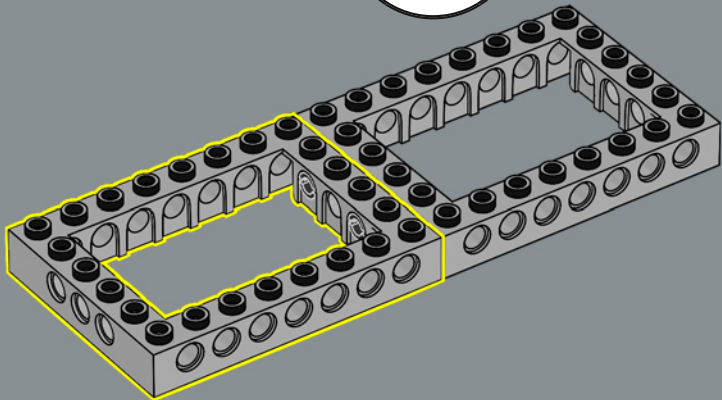
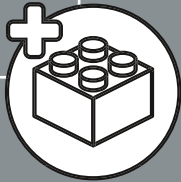

3

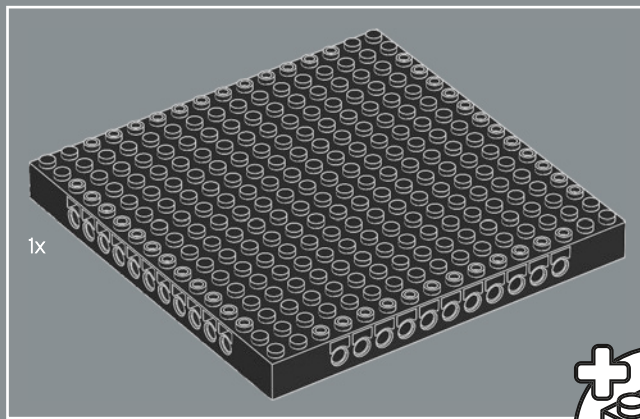
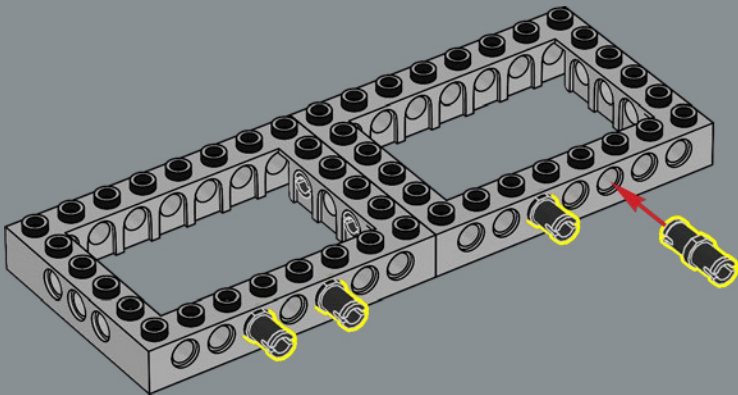

4

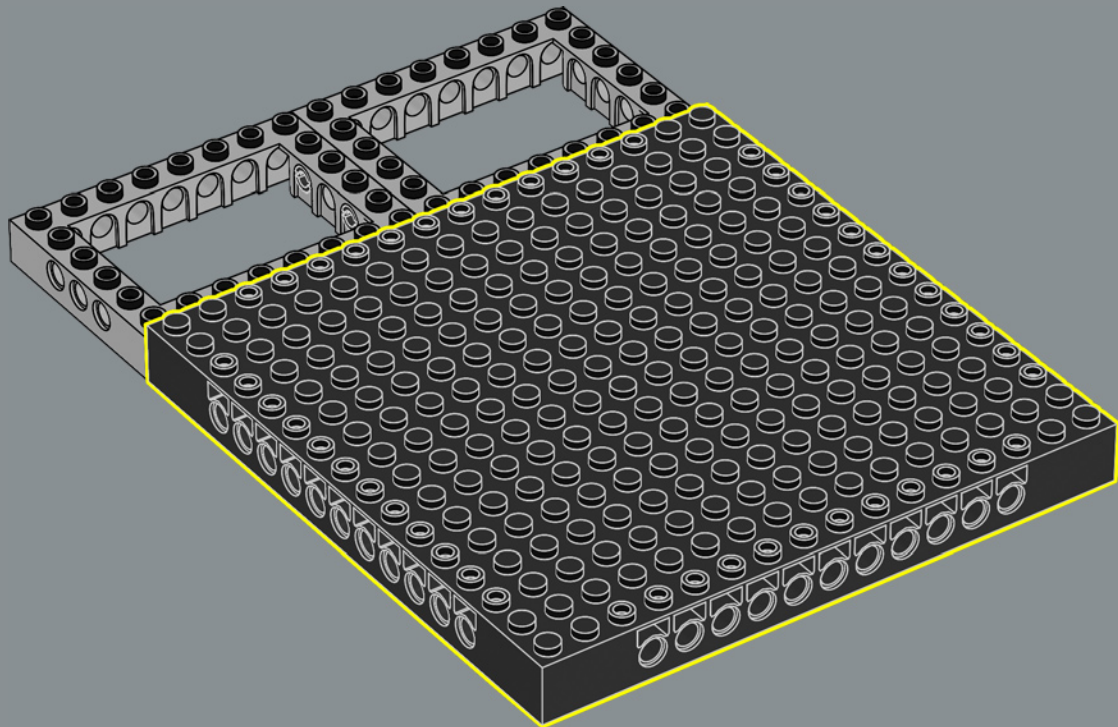
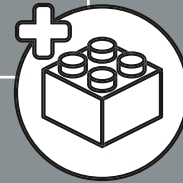

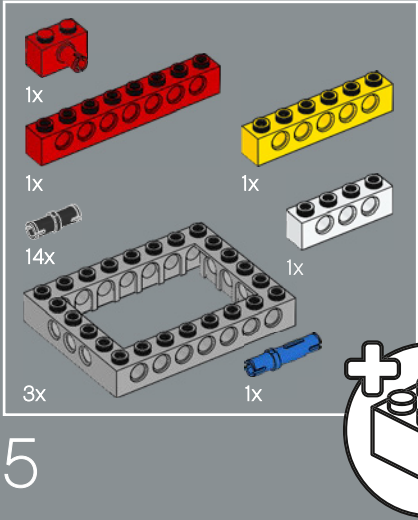
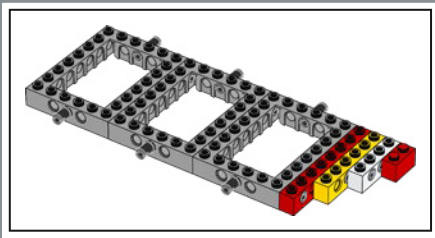

5

1

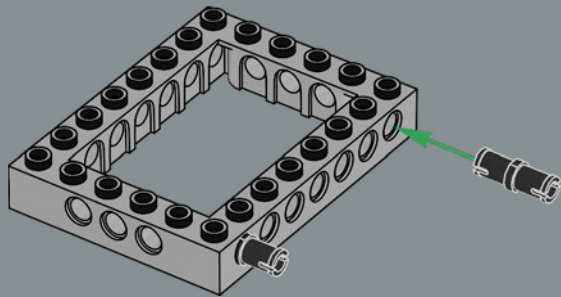

2

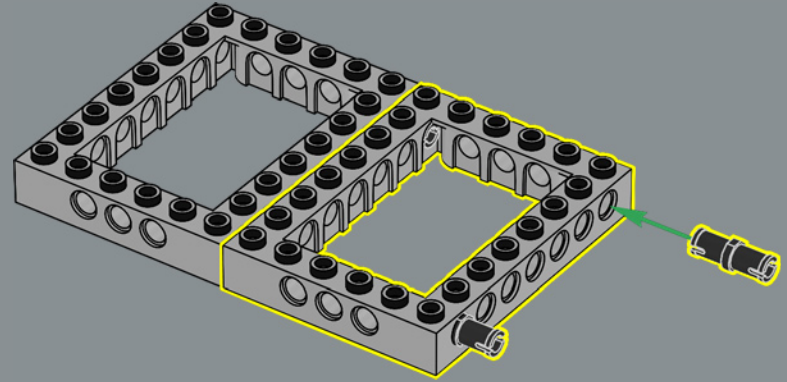

3

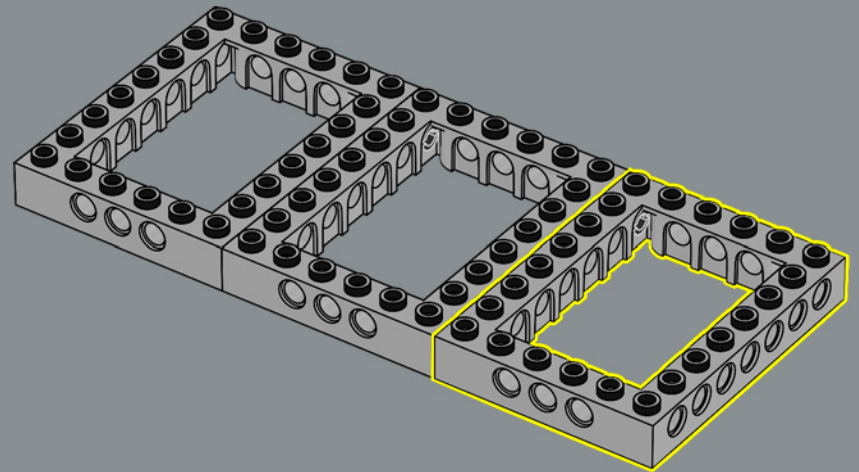



4

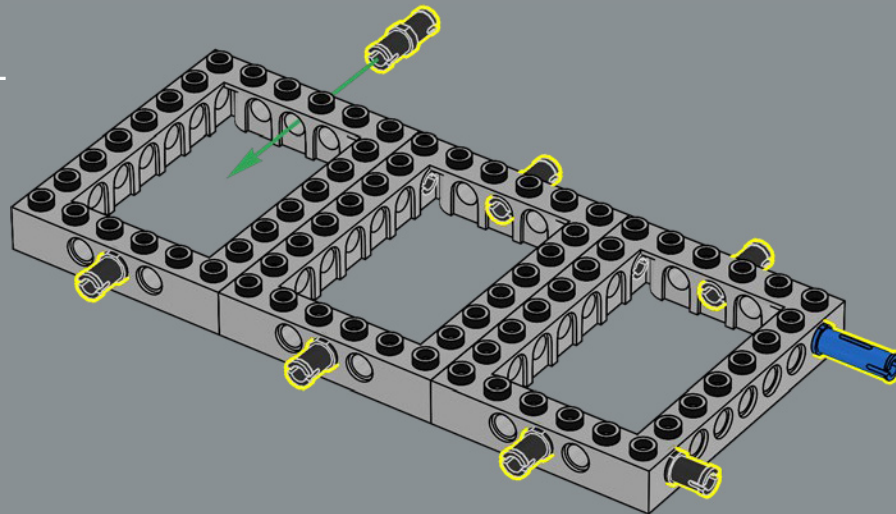

5

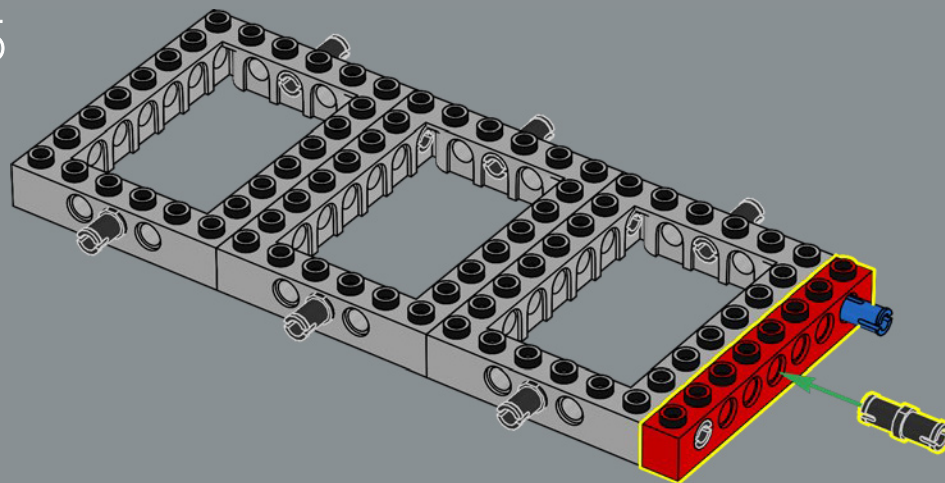

6

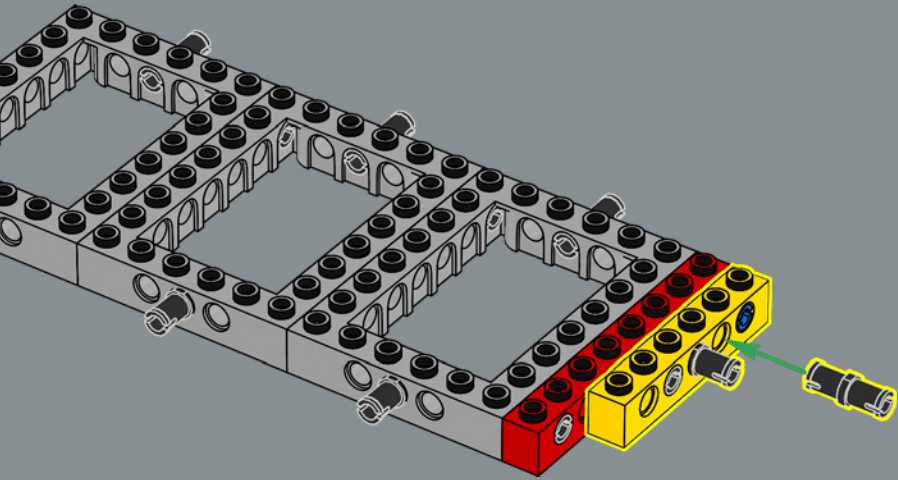

7

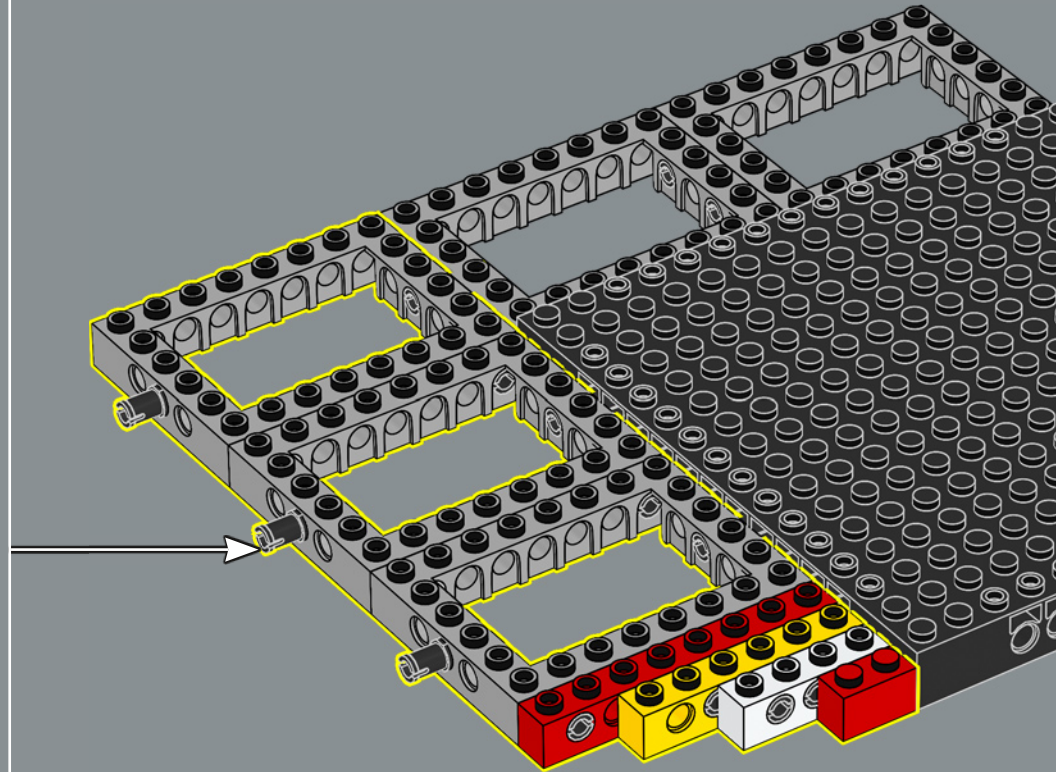
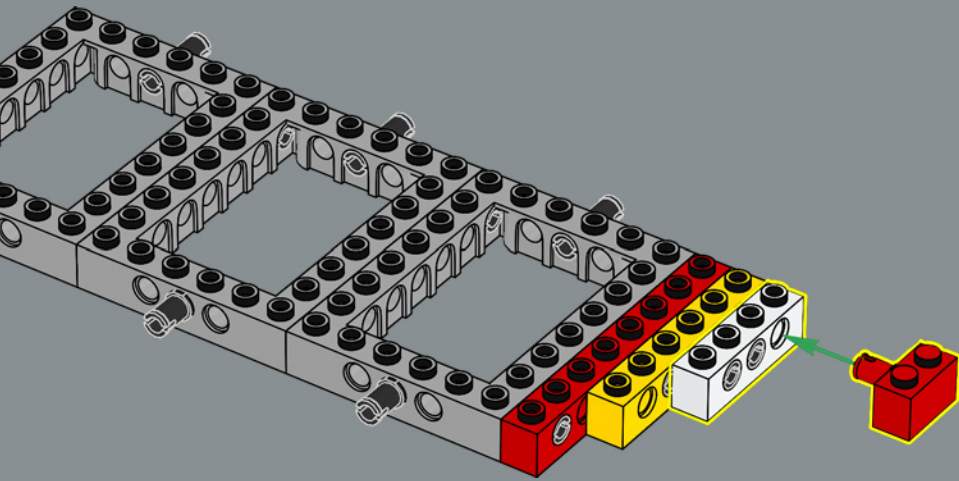

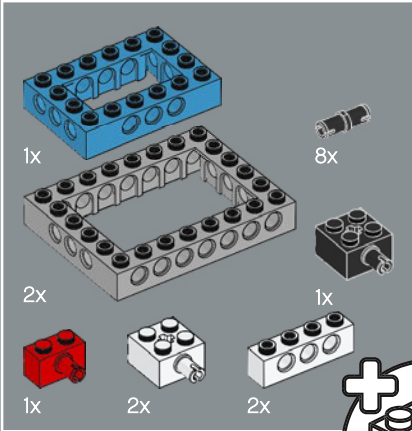
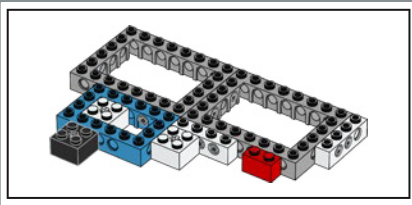

6

1

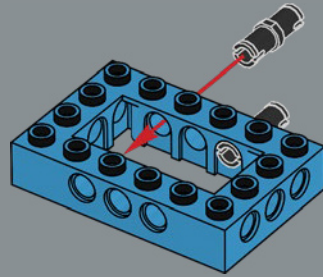

2

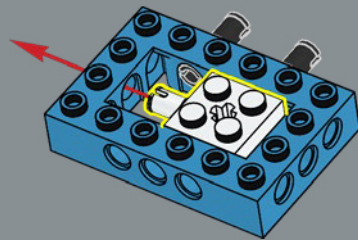

3

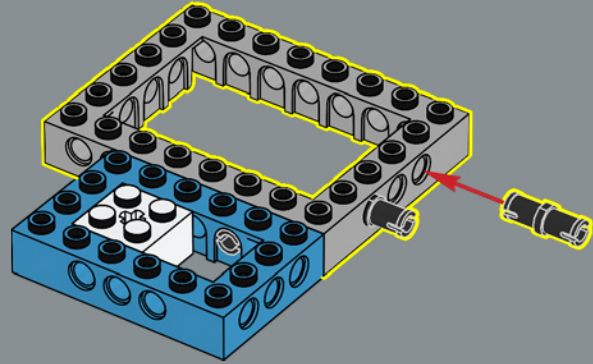

4

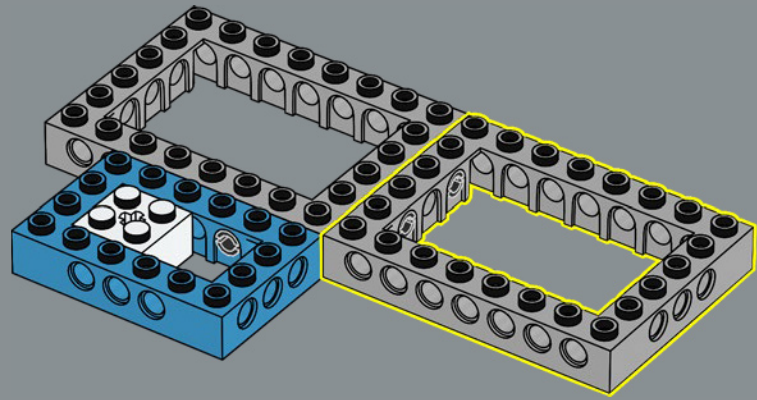

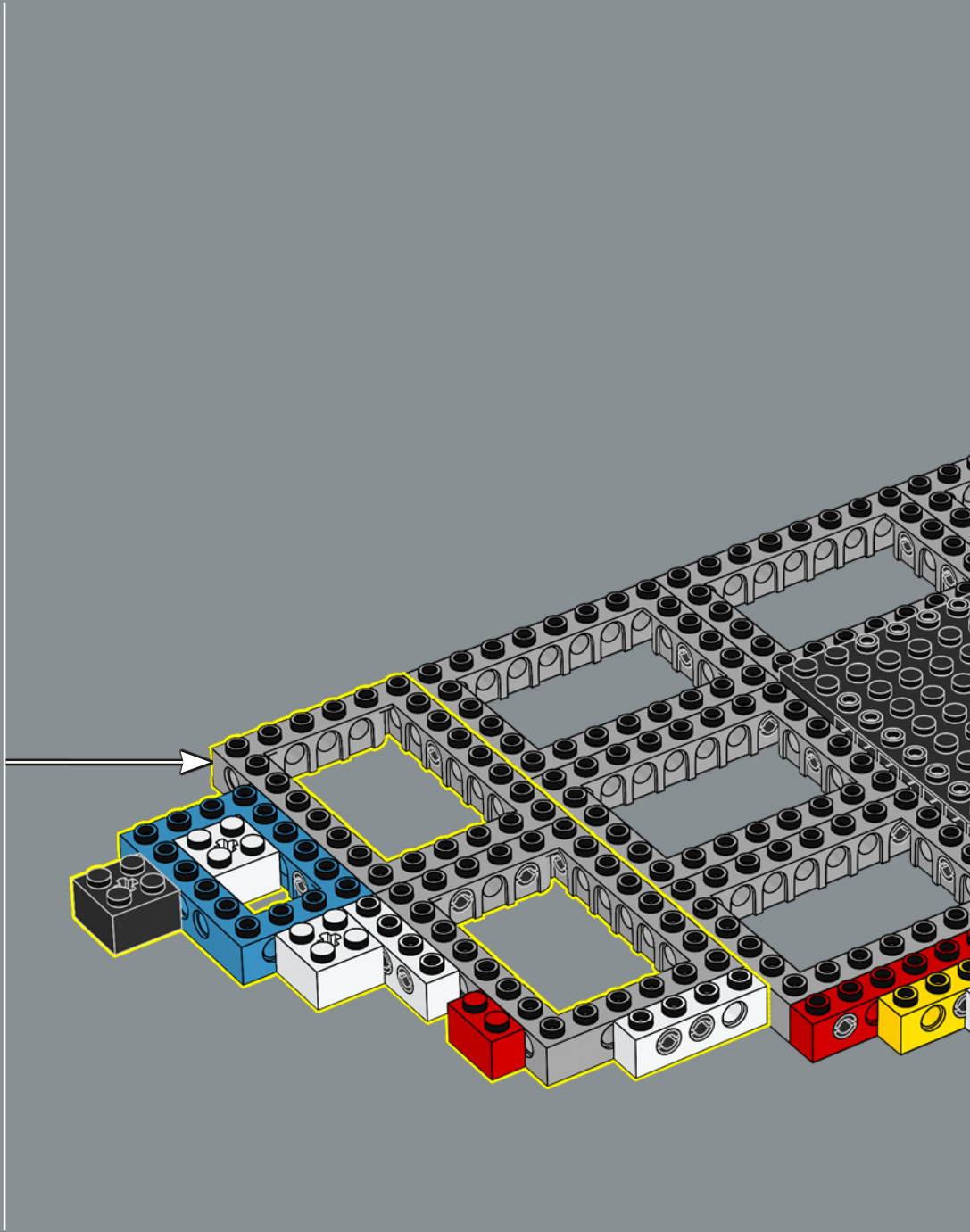
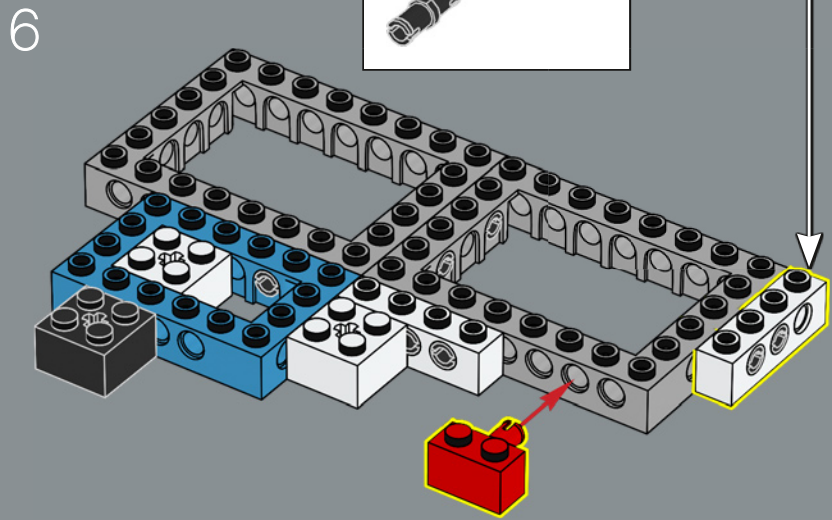
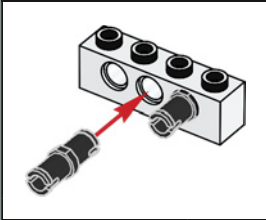
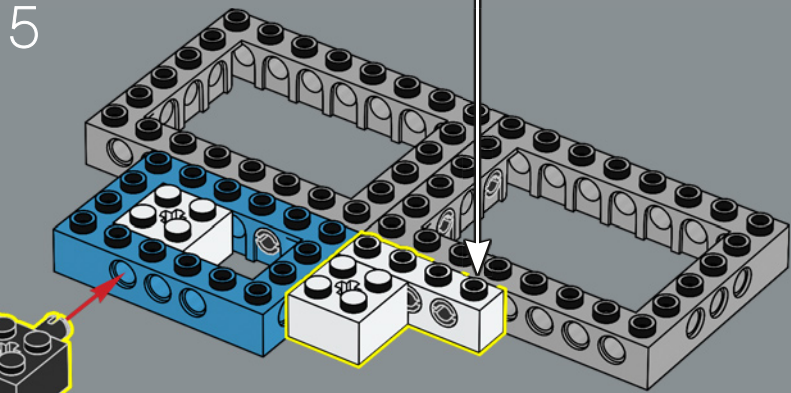
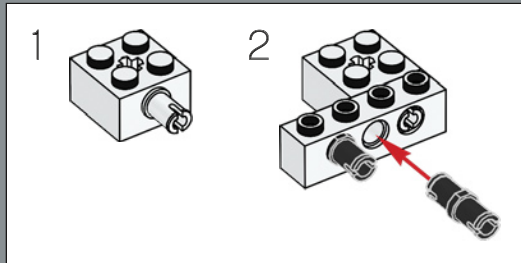

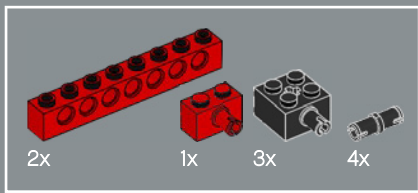

7

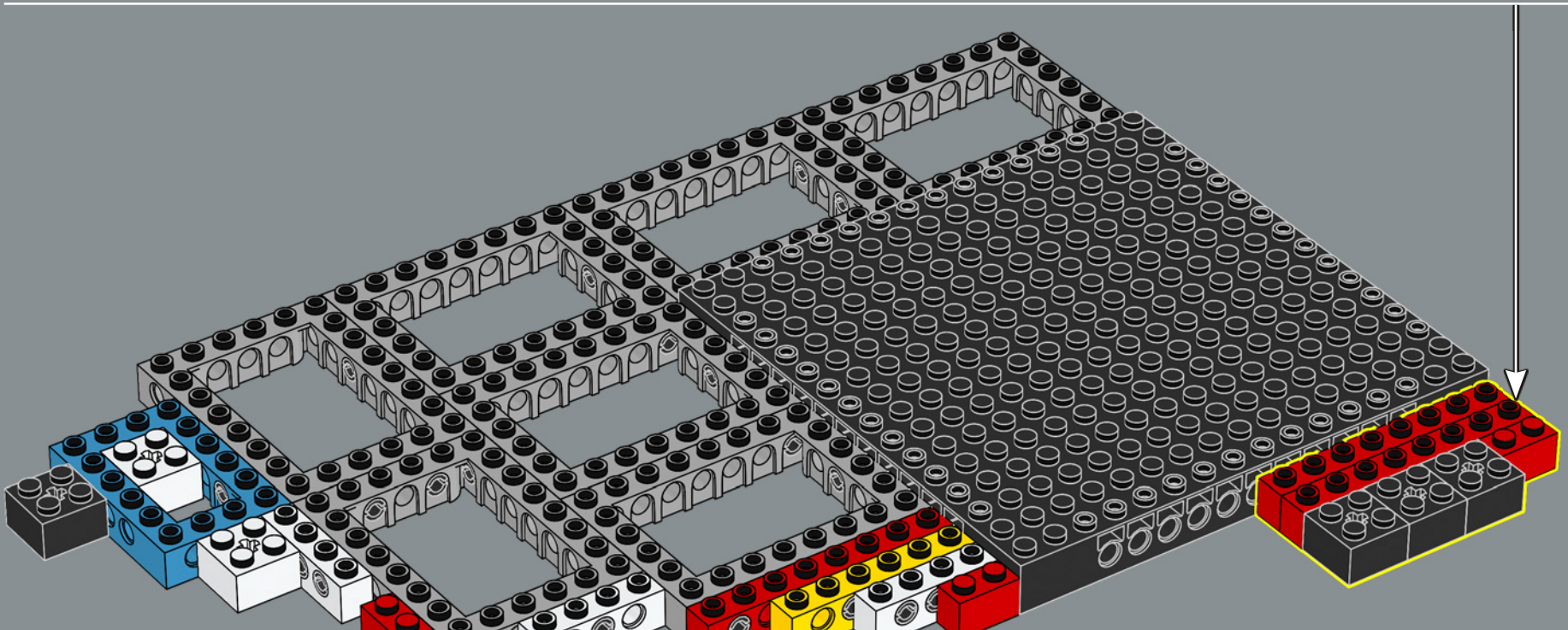
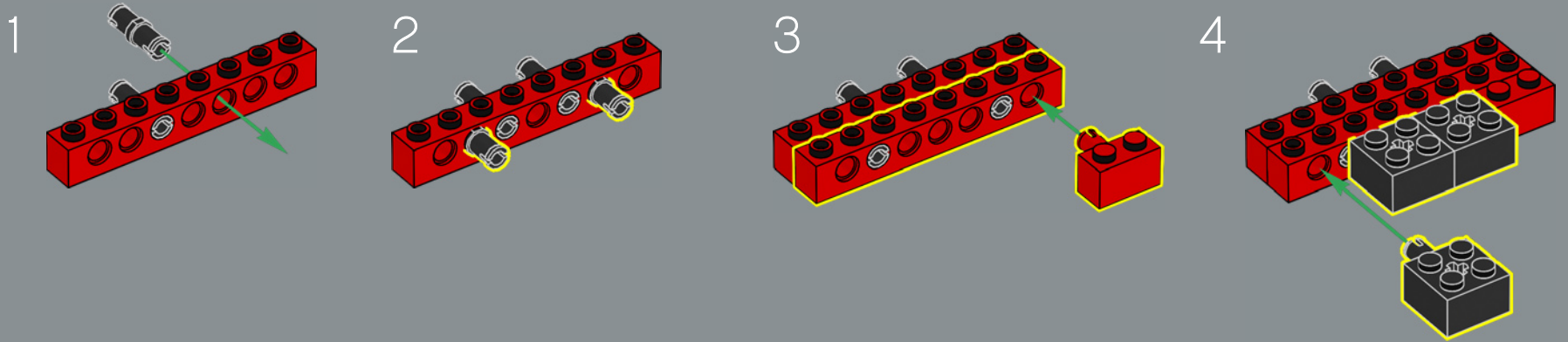

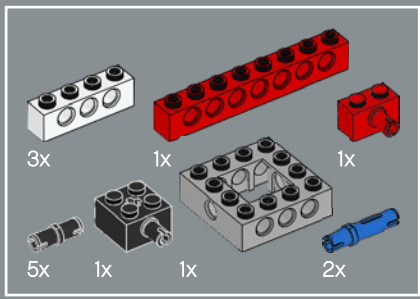

8

1

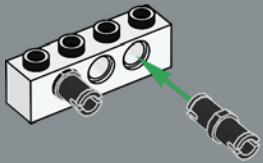

2

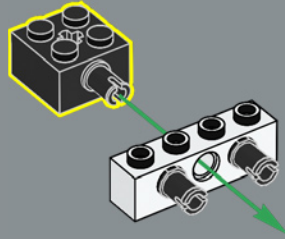

3

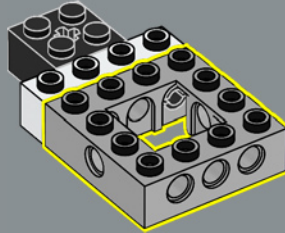

4

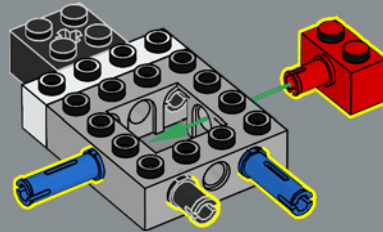

5

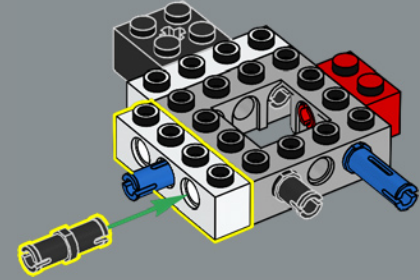

6

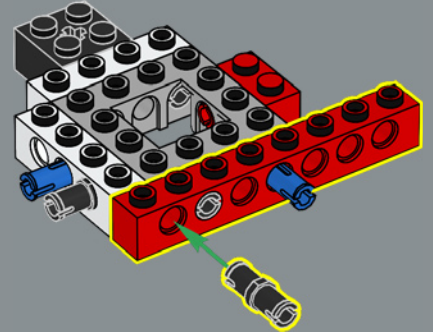

7

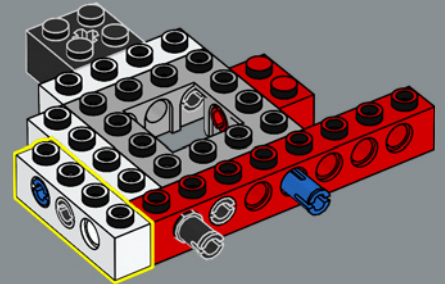

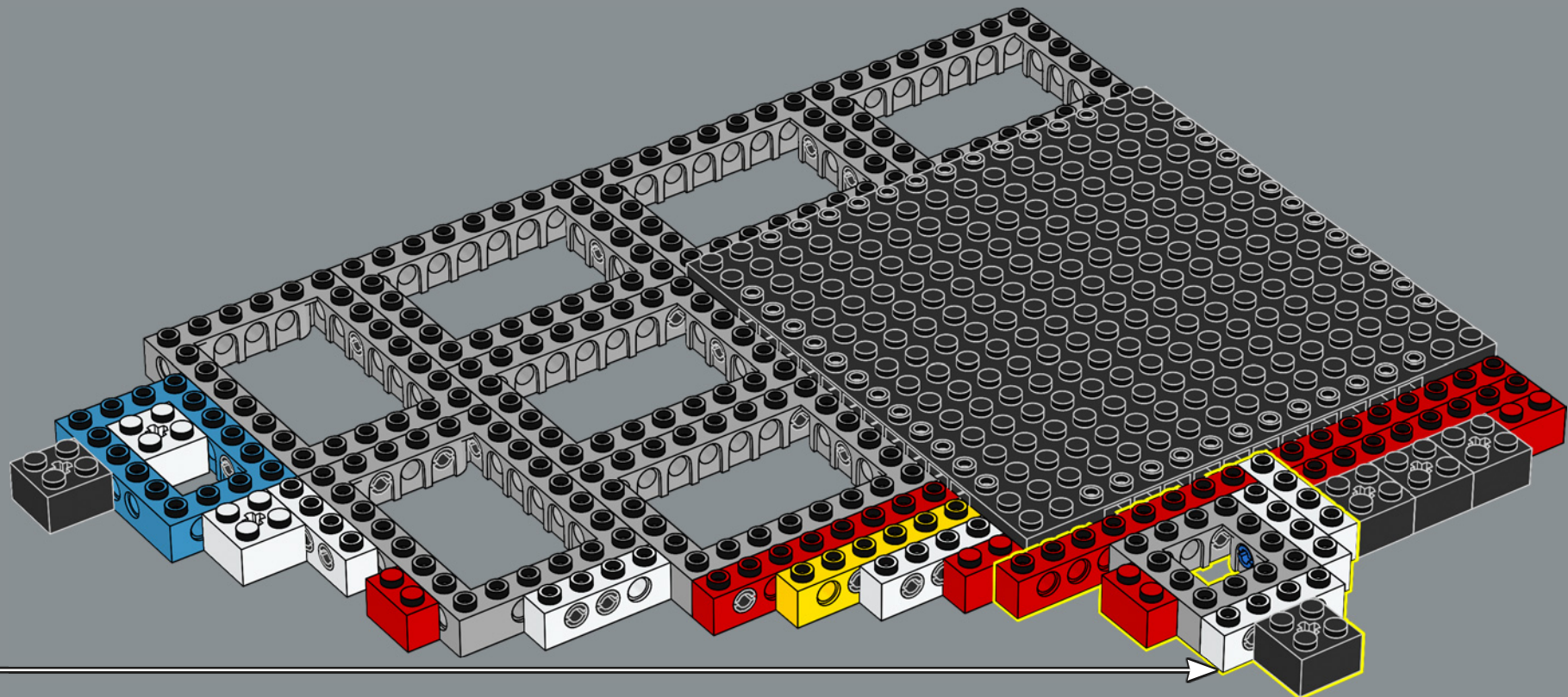

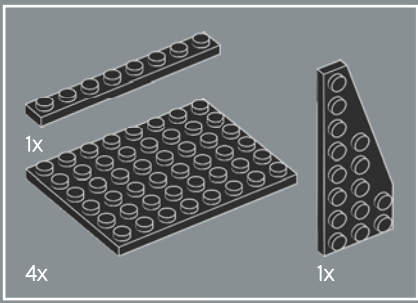

9

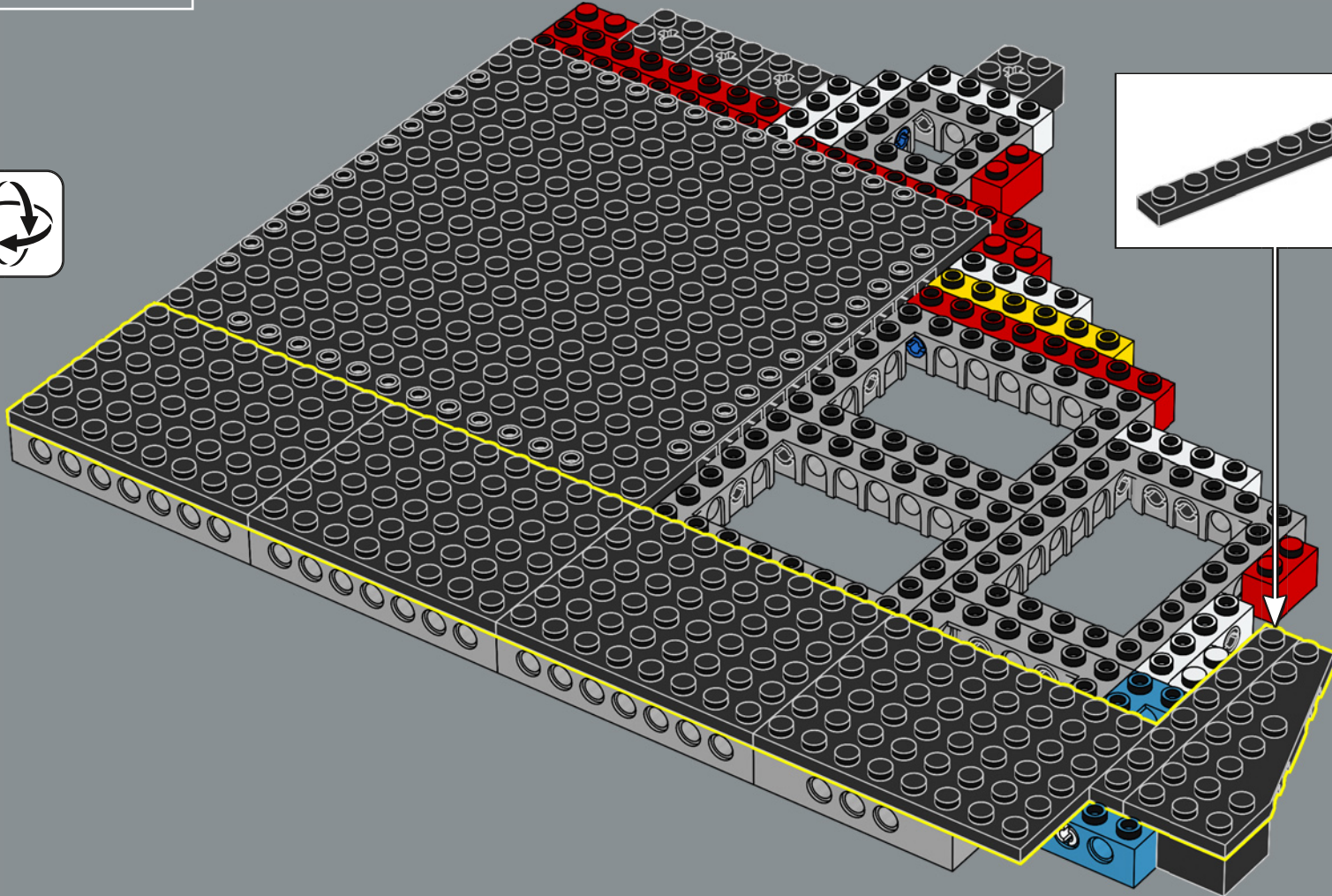



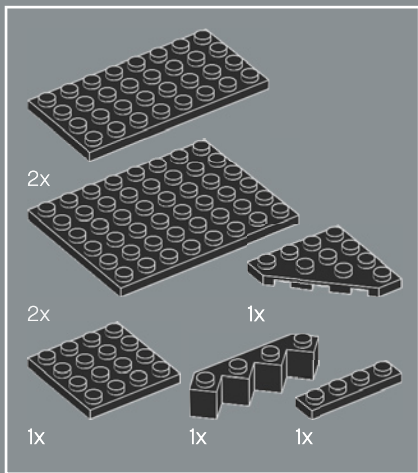

10

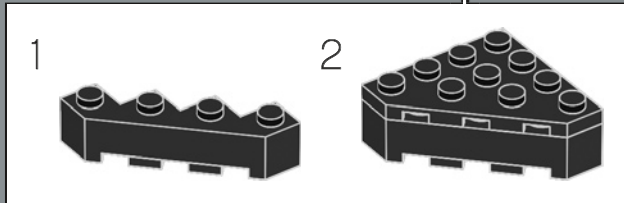
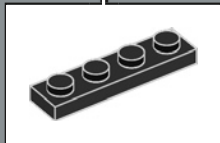
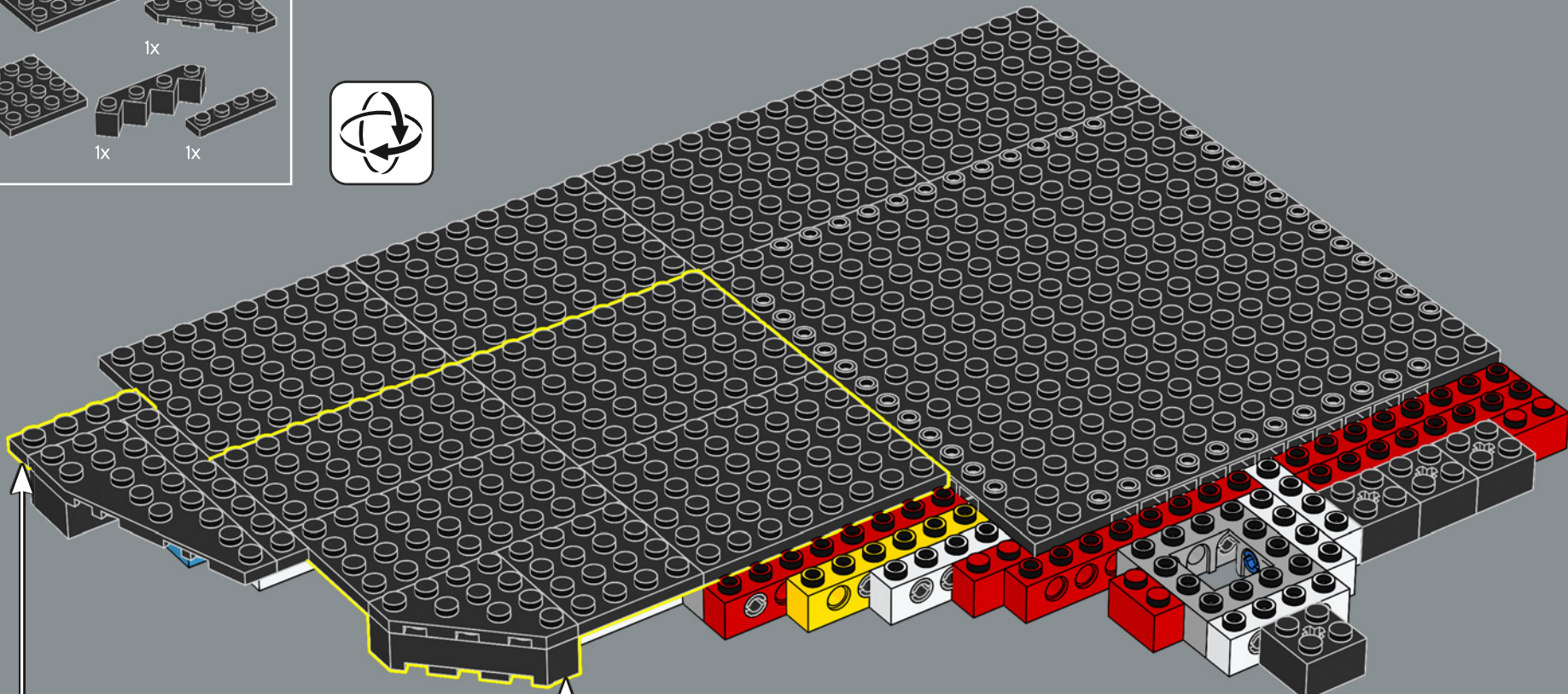

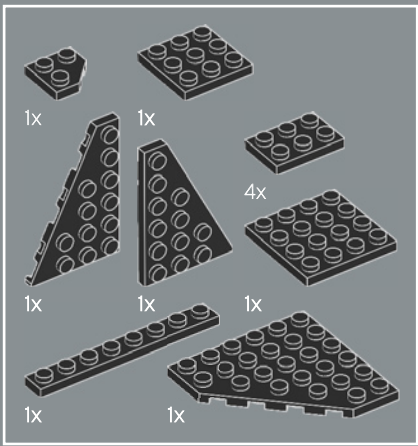

11

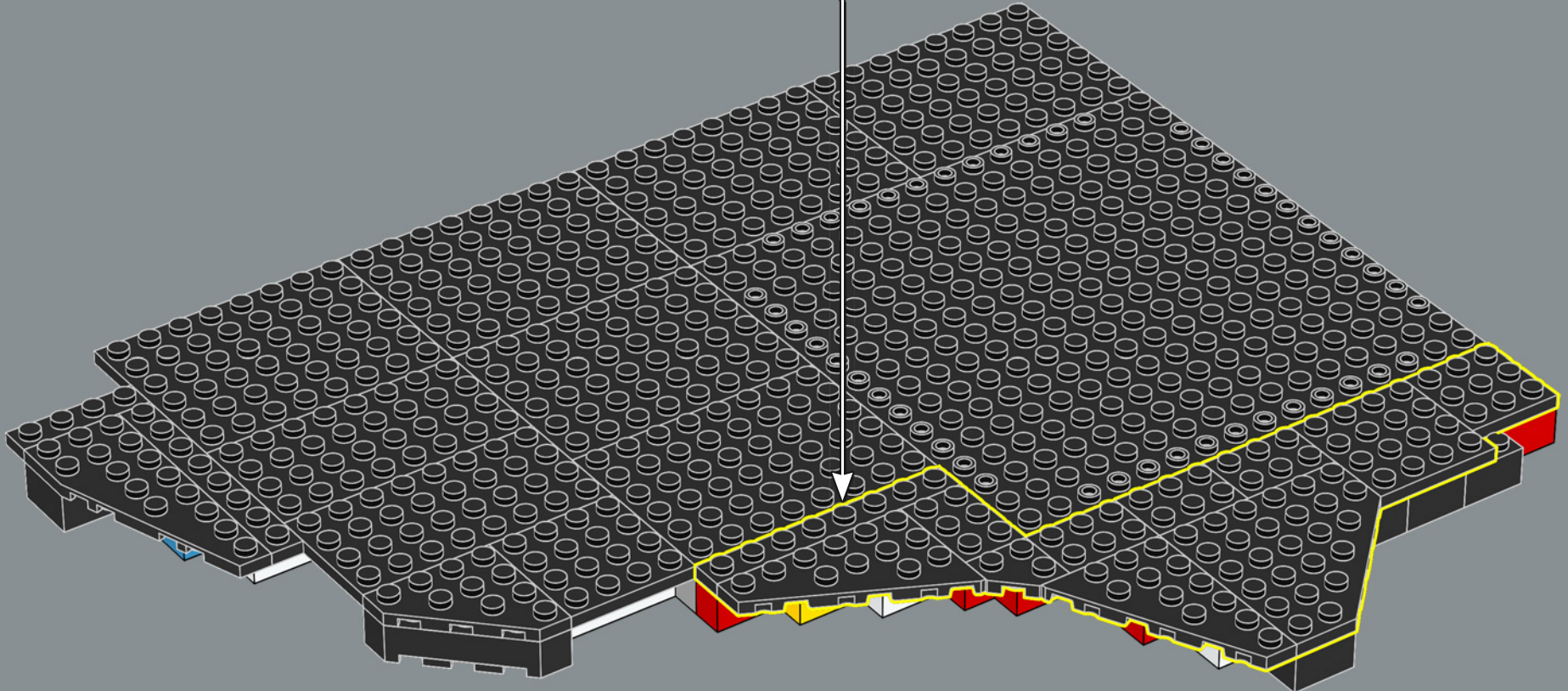
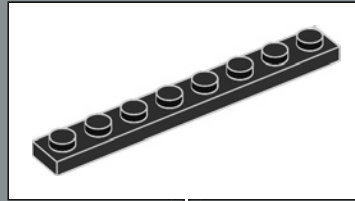

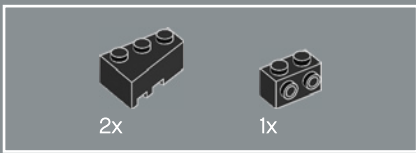

12

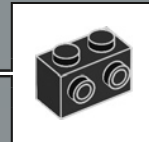
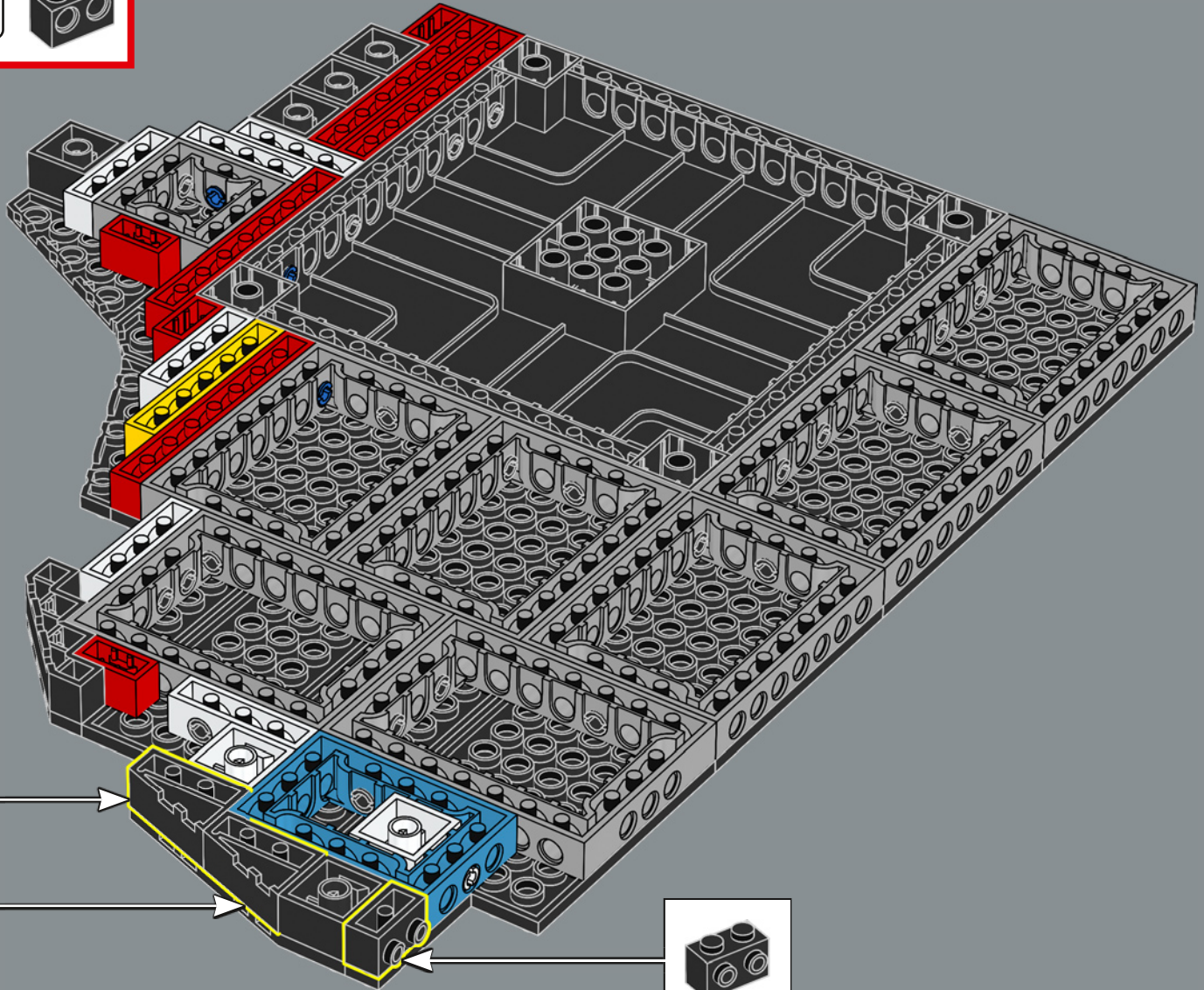
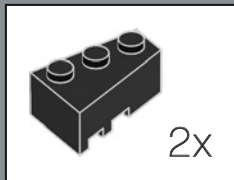
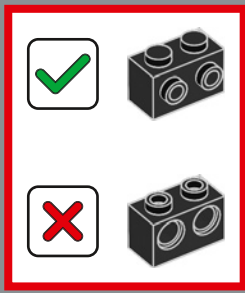

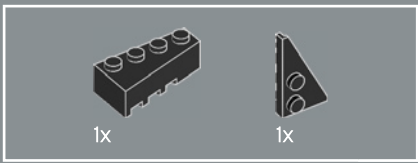

13

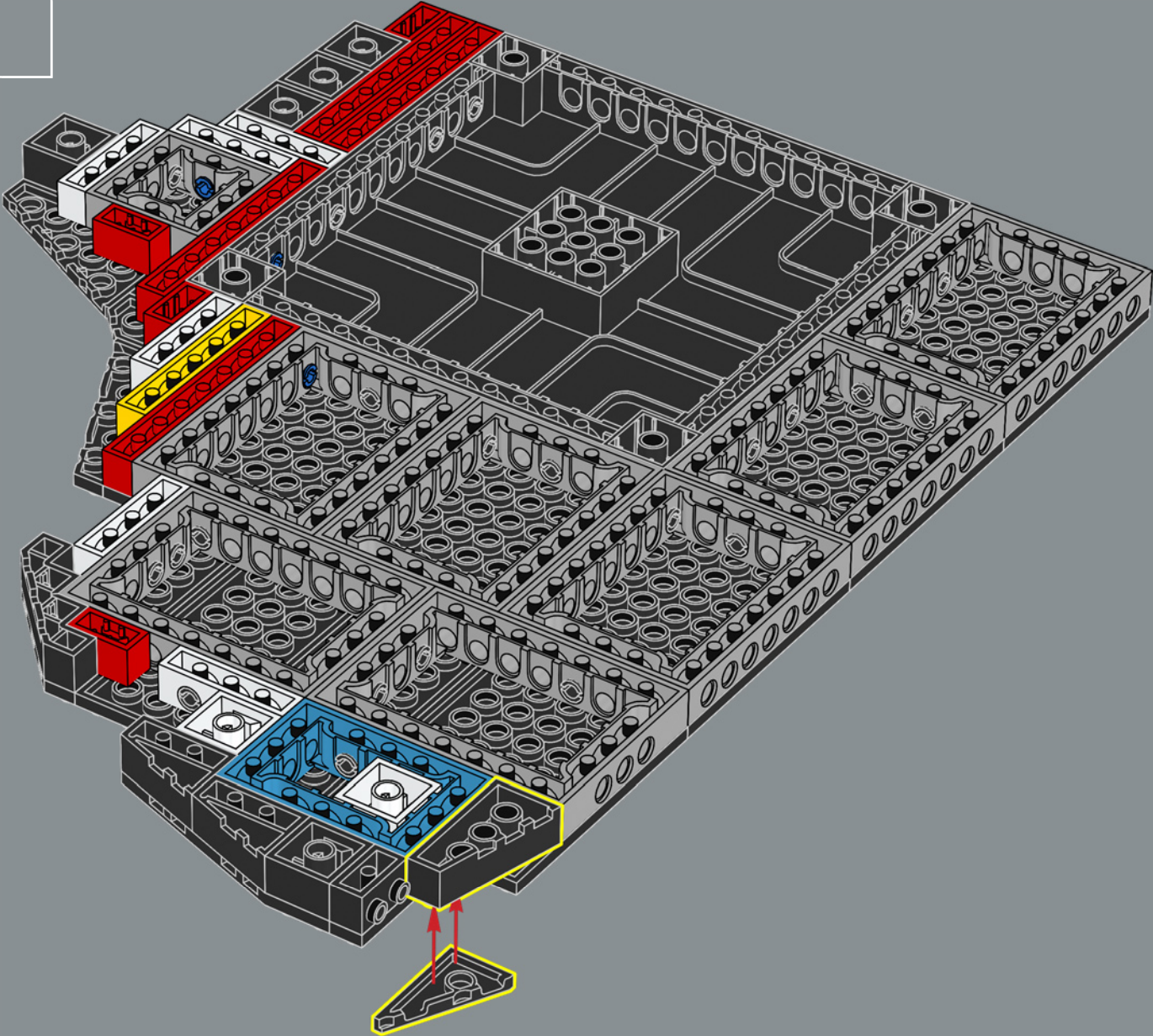

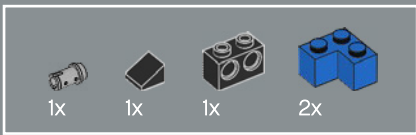

14

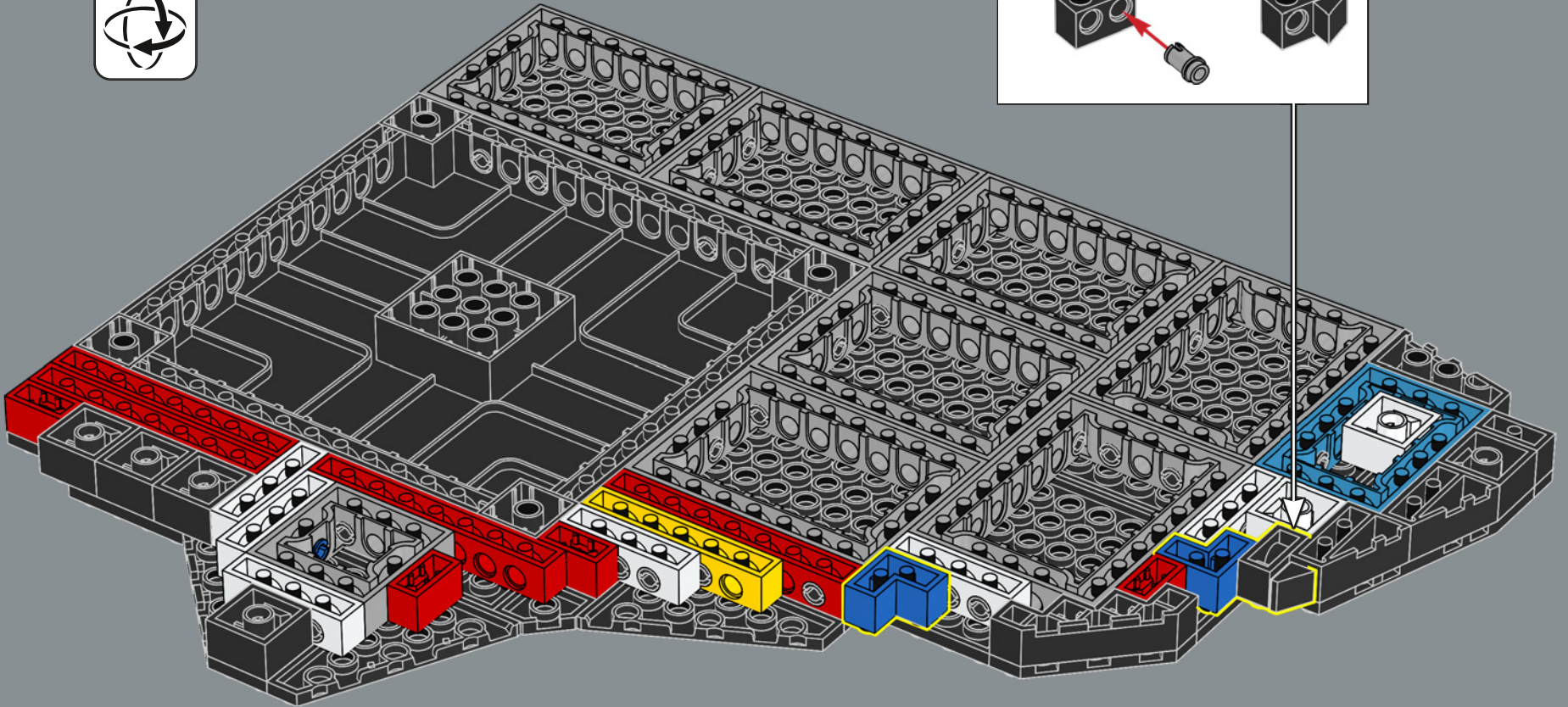

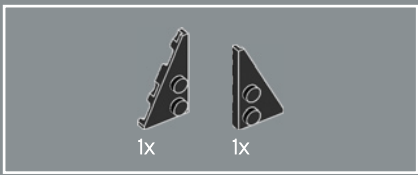

15

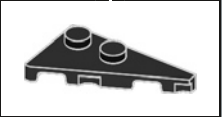
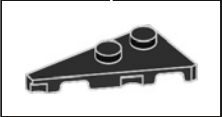
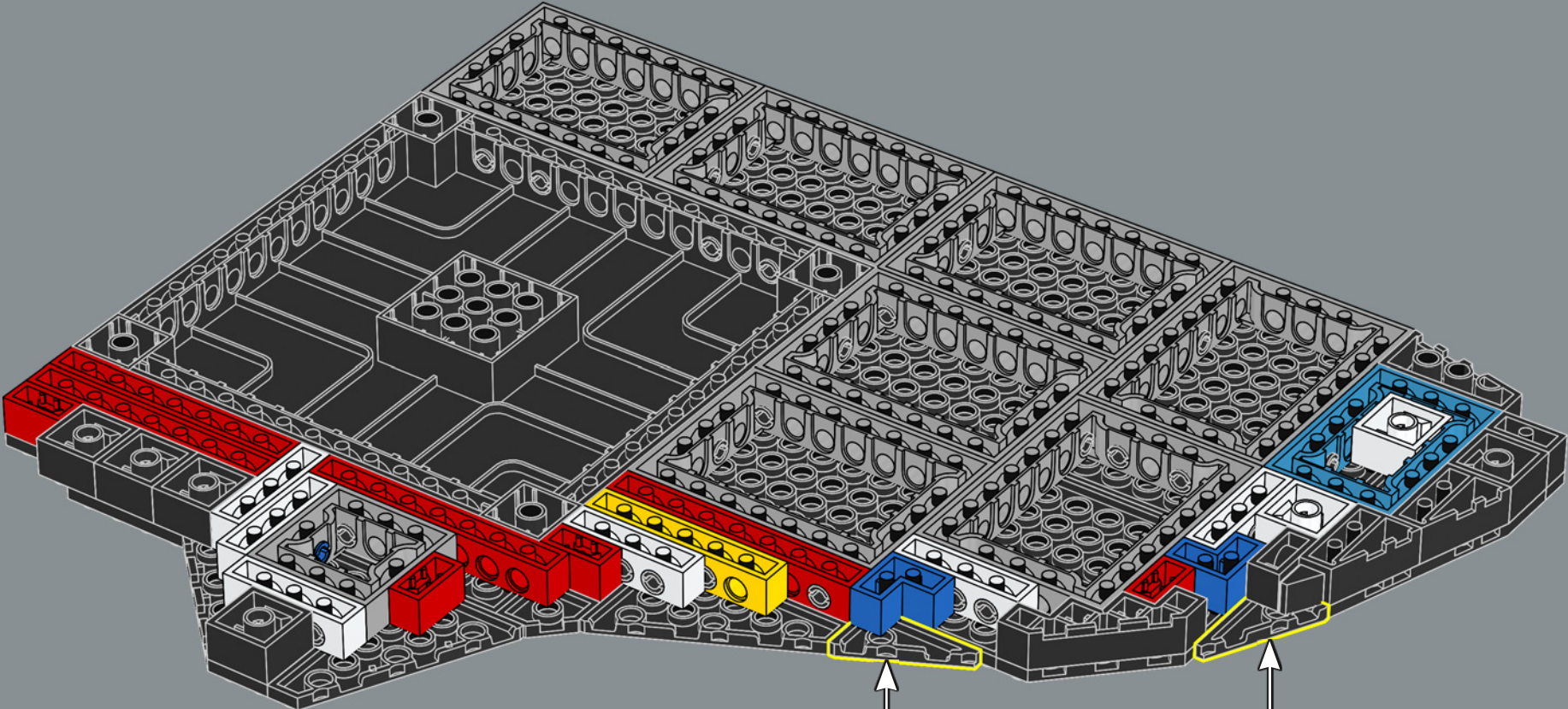

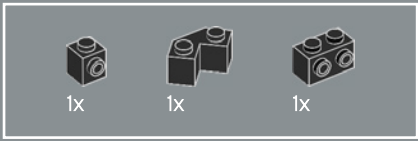

16

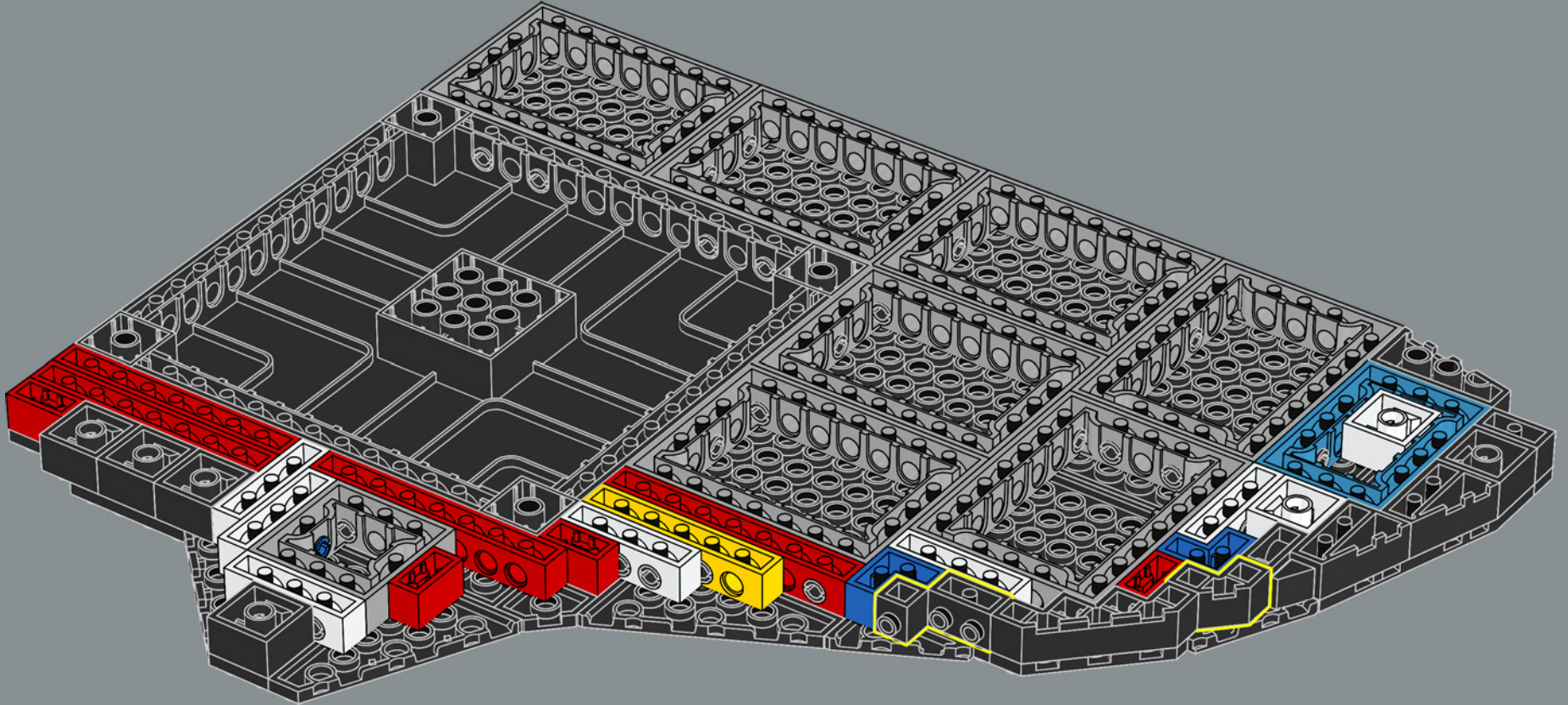
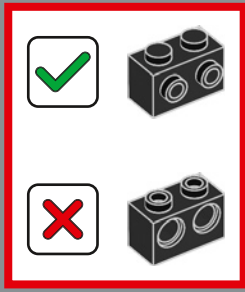

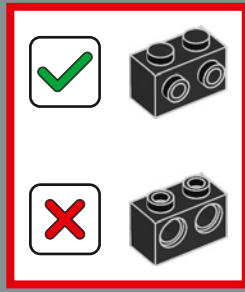
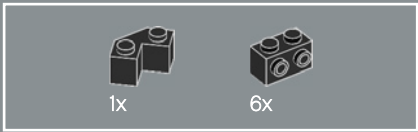

17

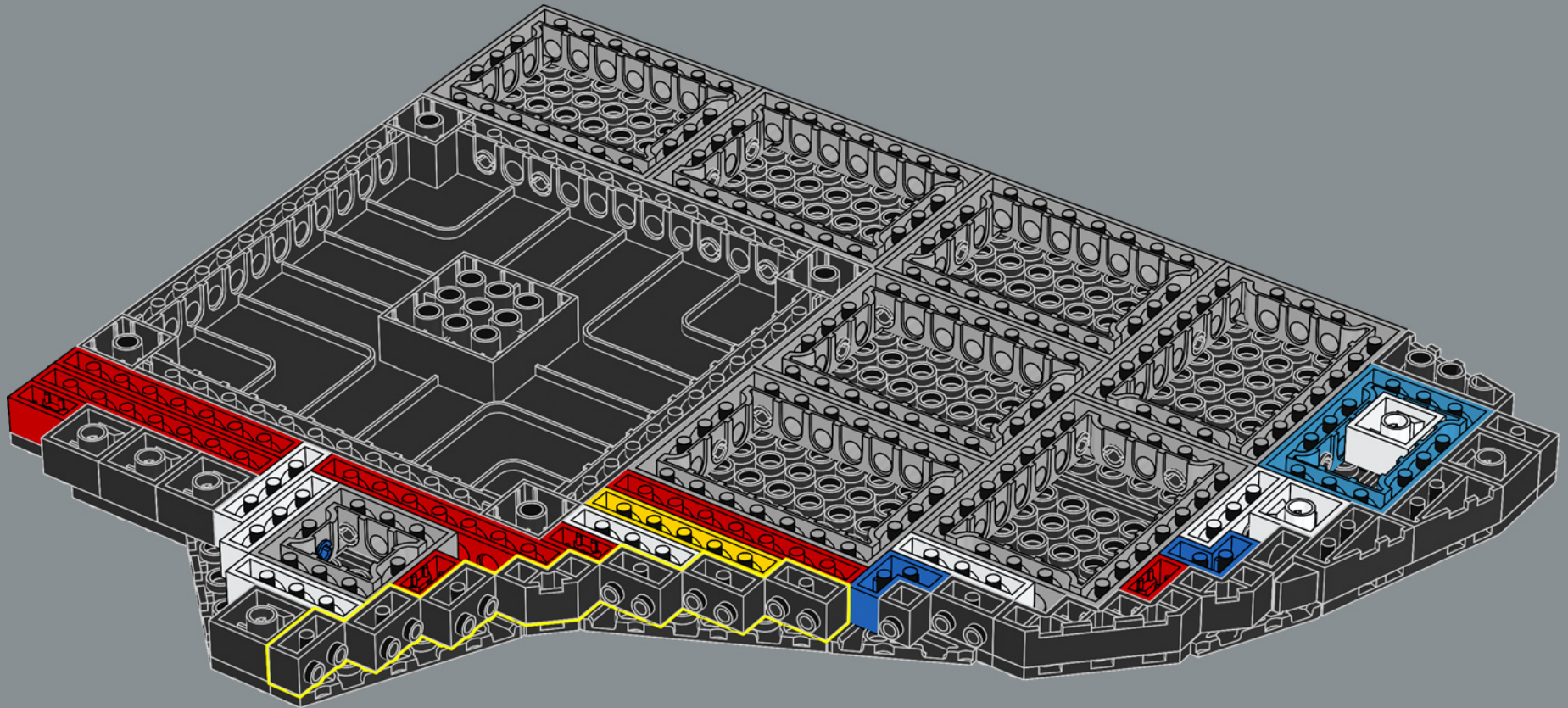





18

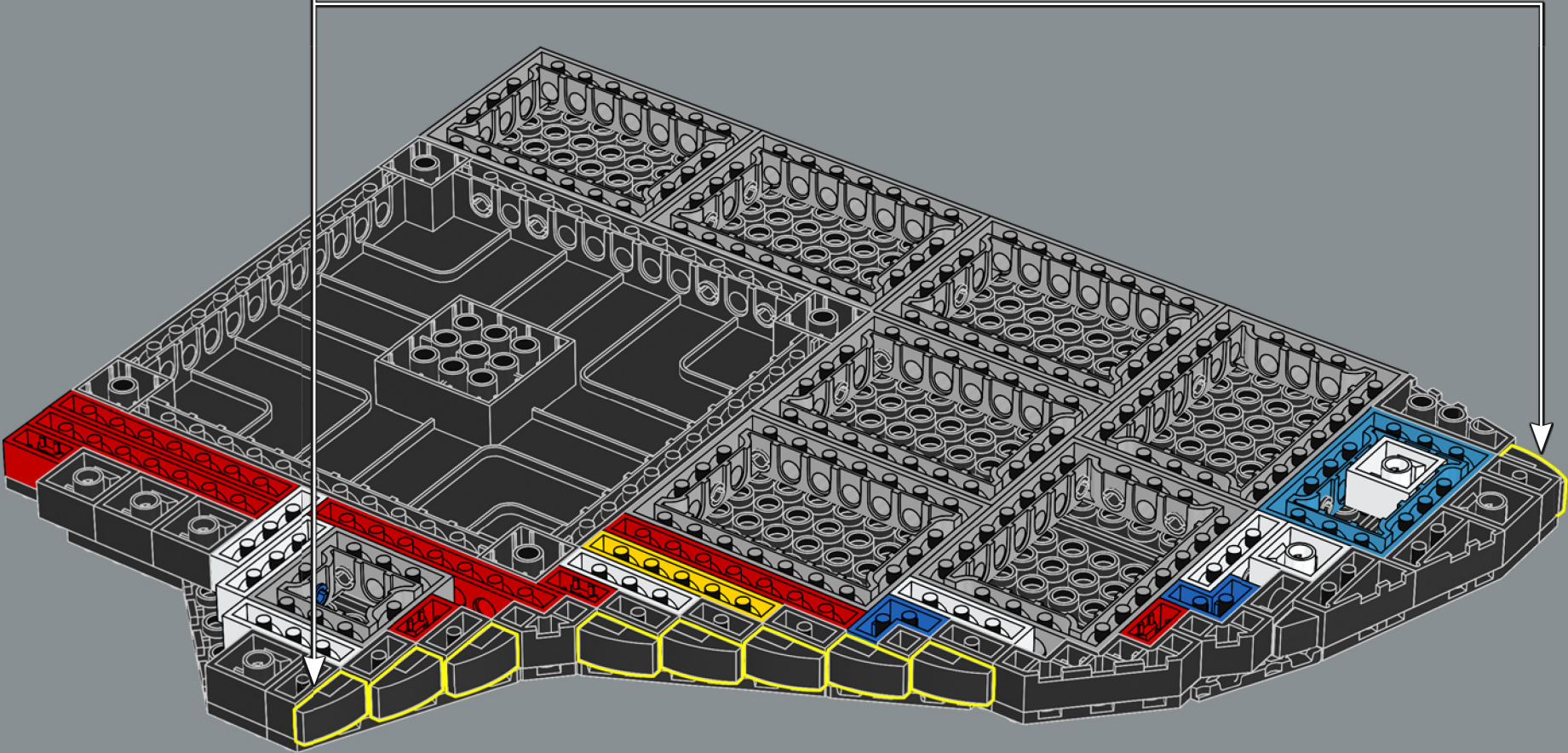
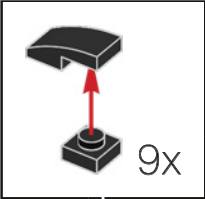

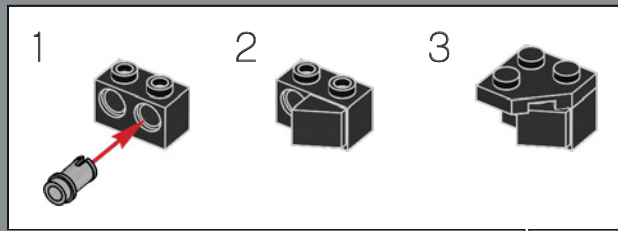
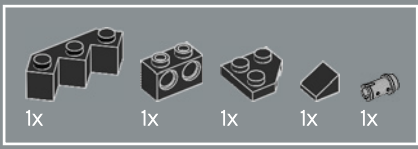

19

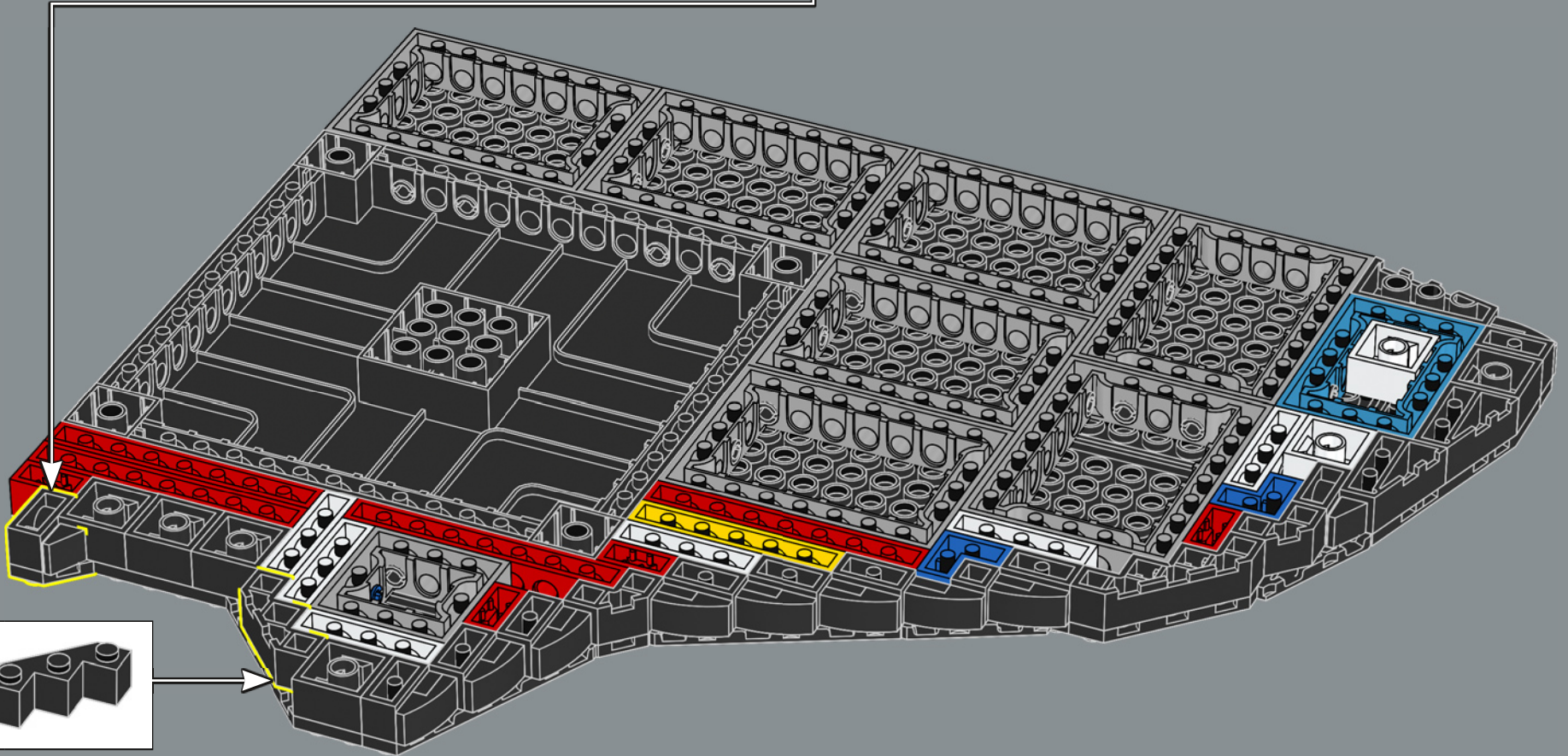

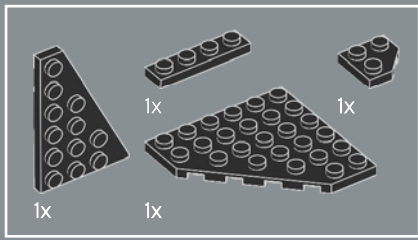

20

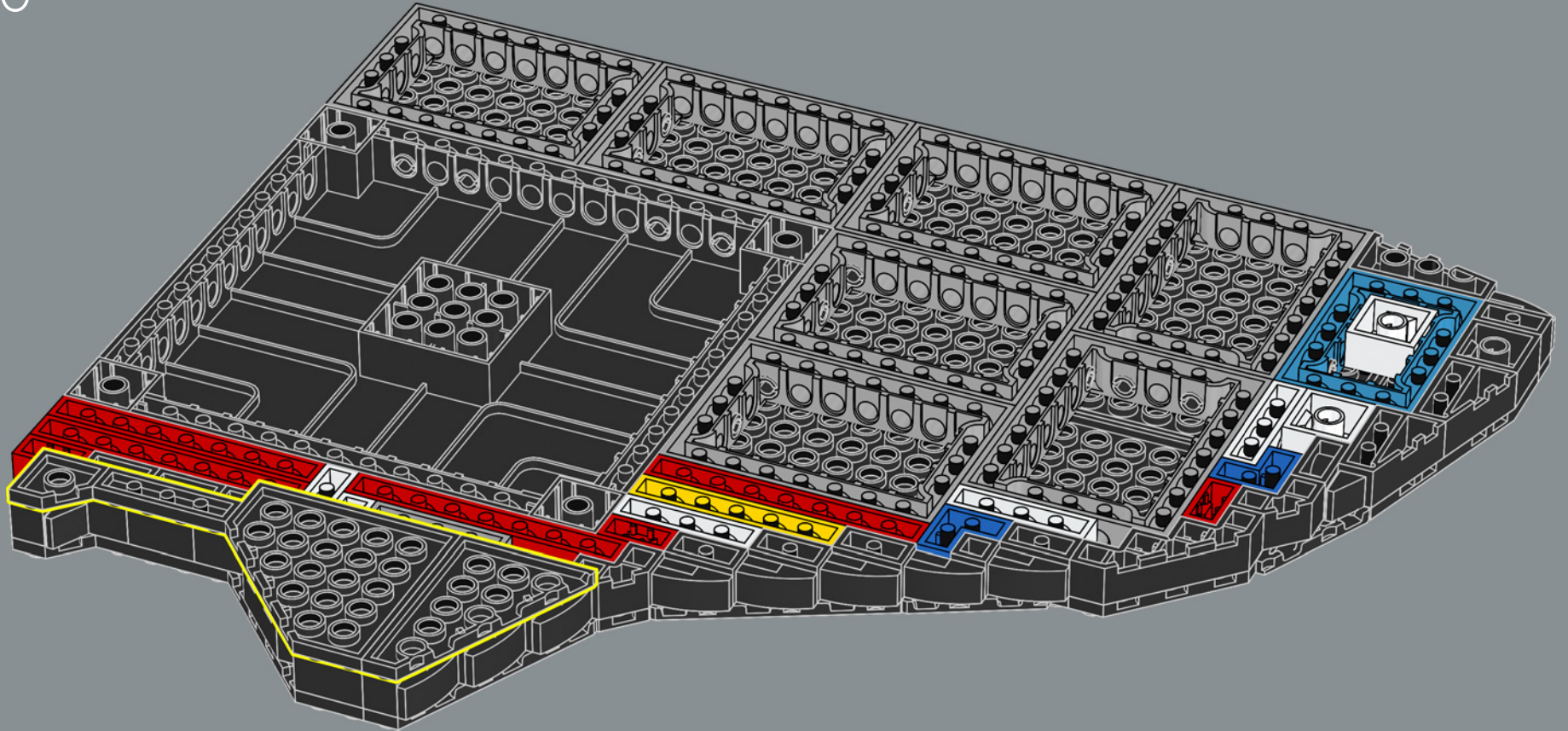

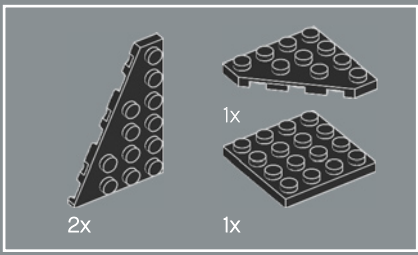

21

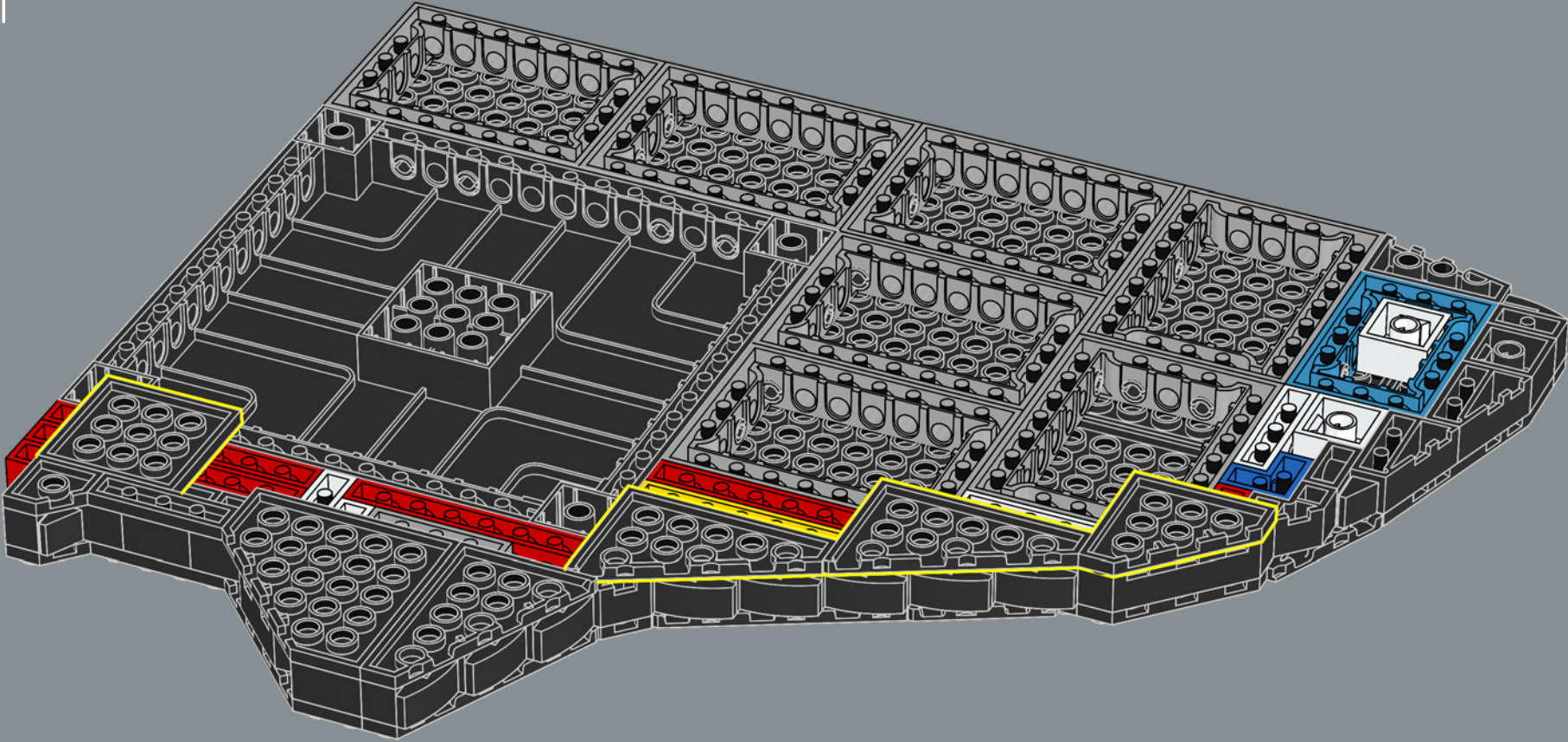

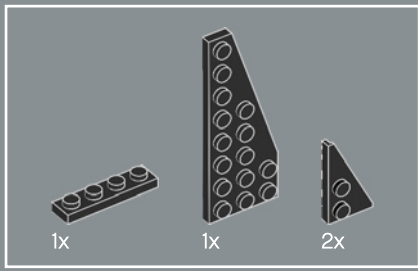

22

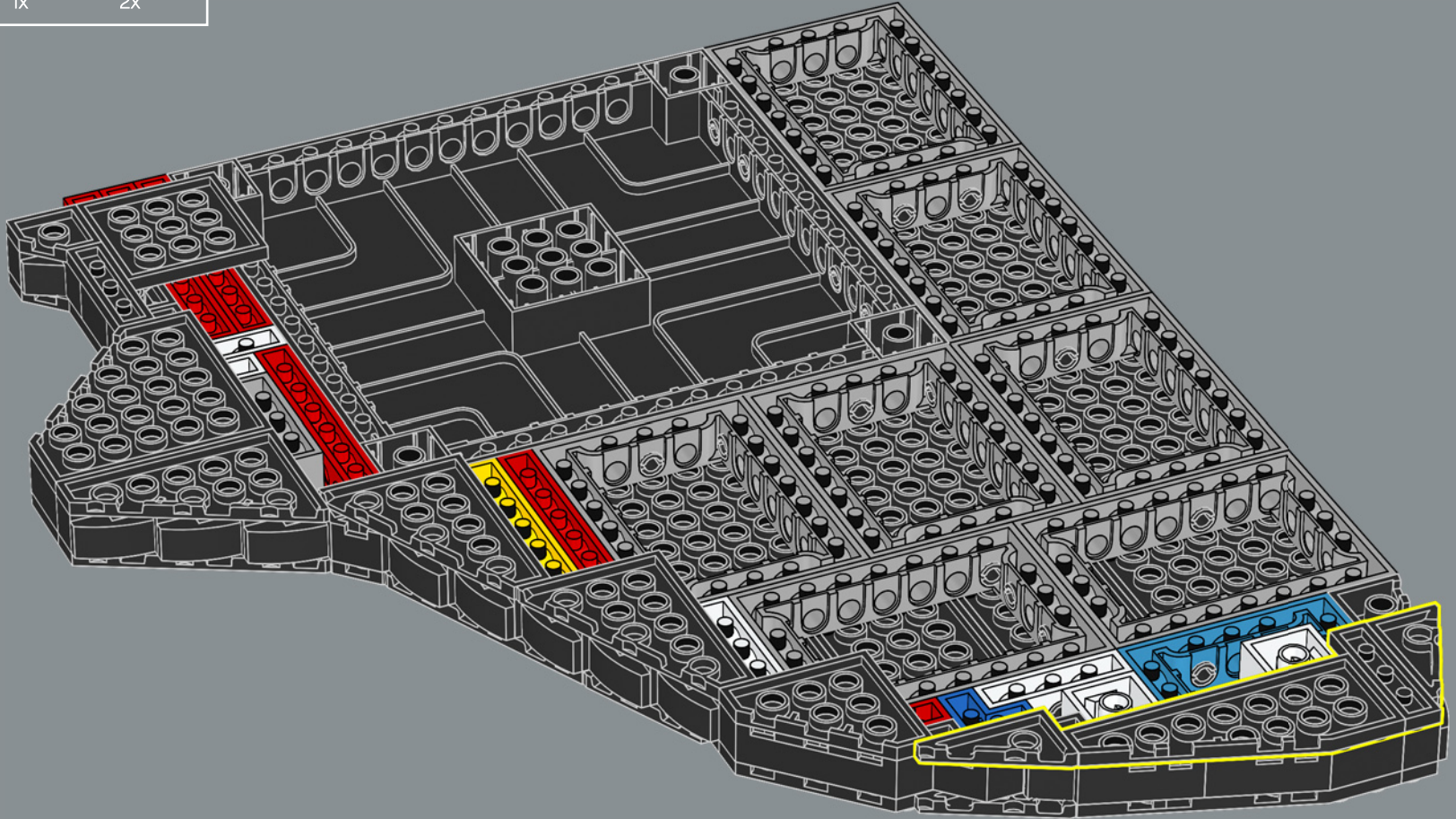

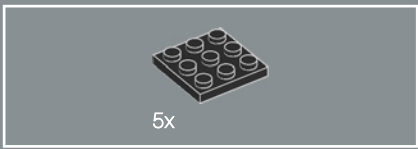

23

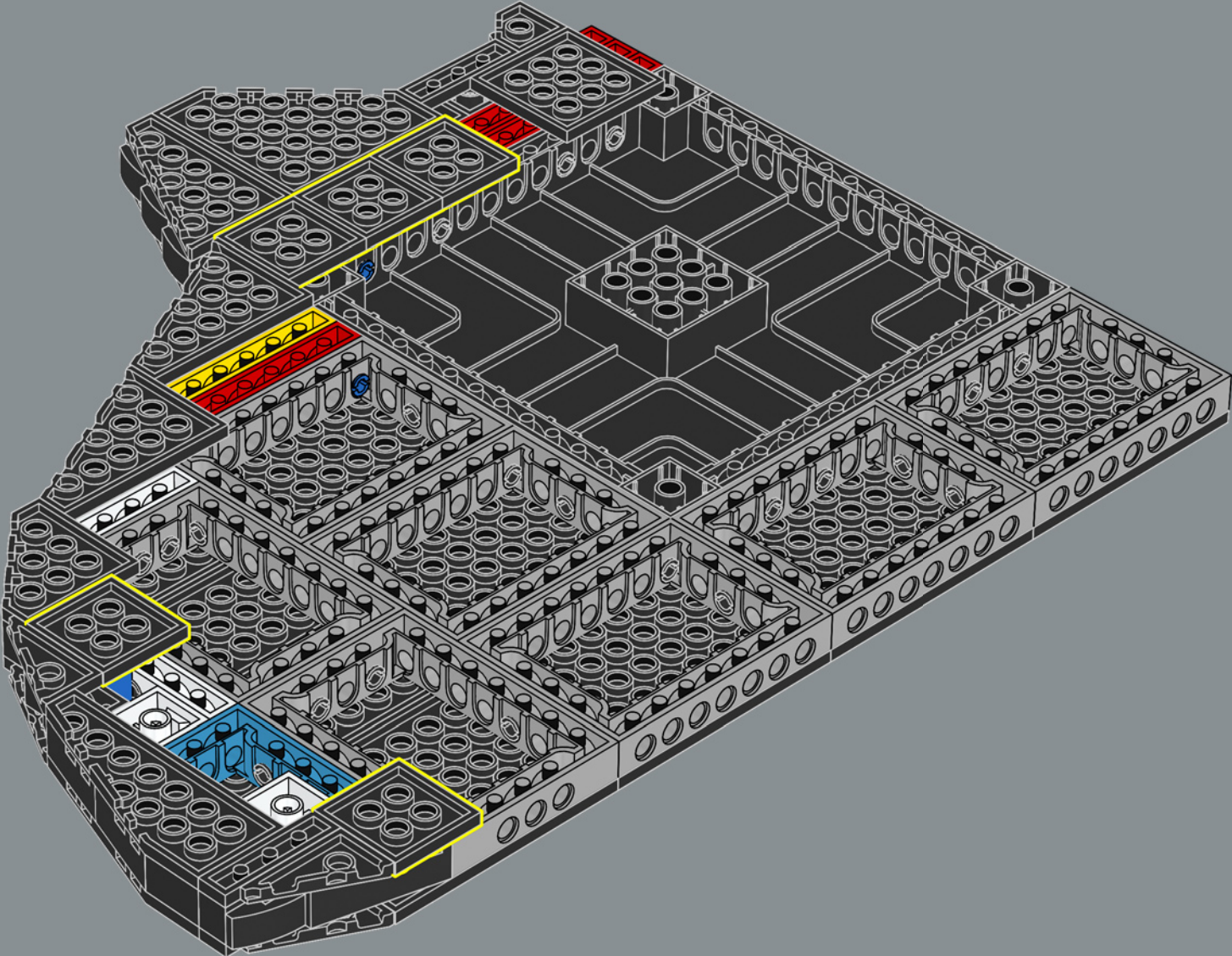

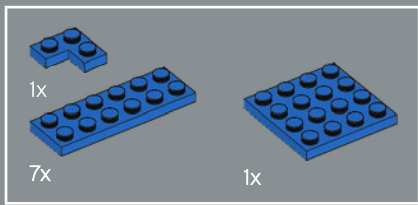

24

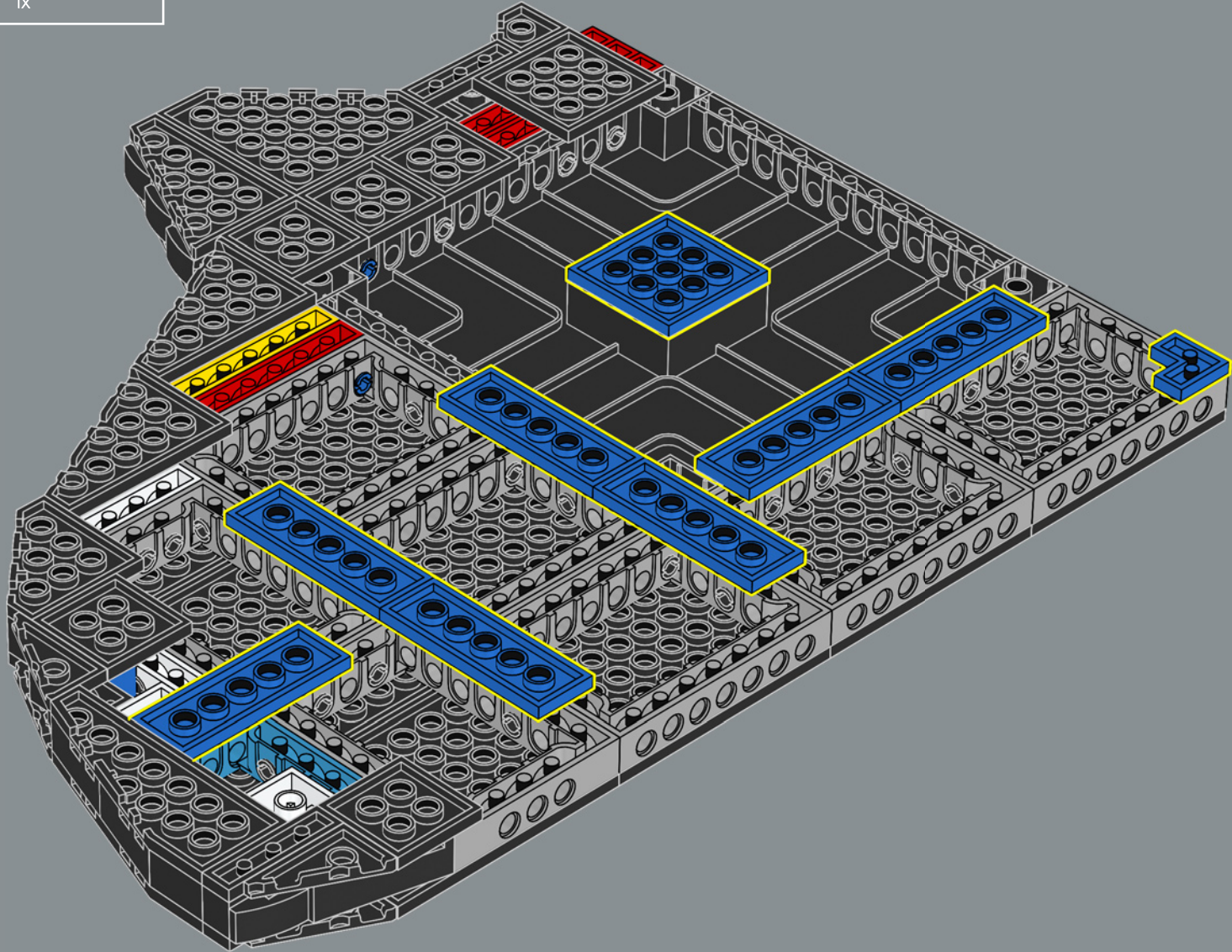

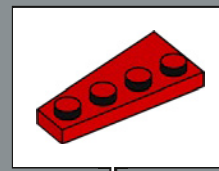
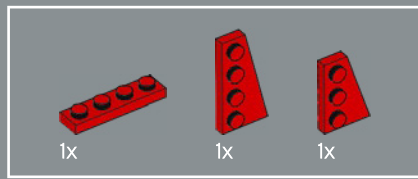

25

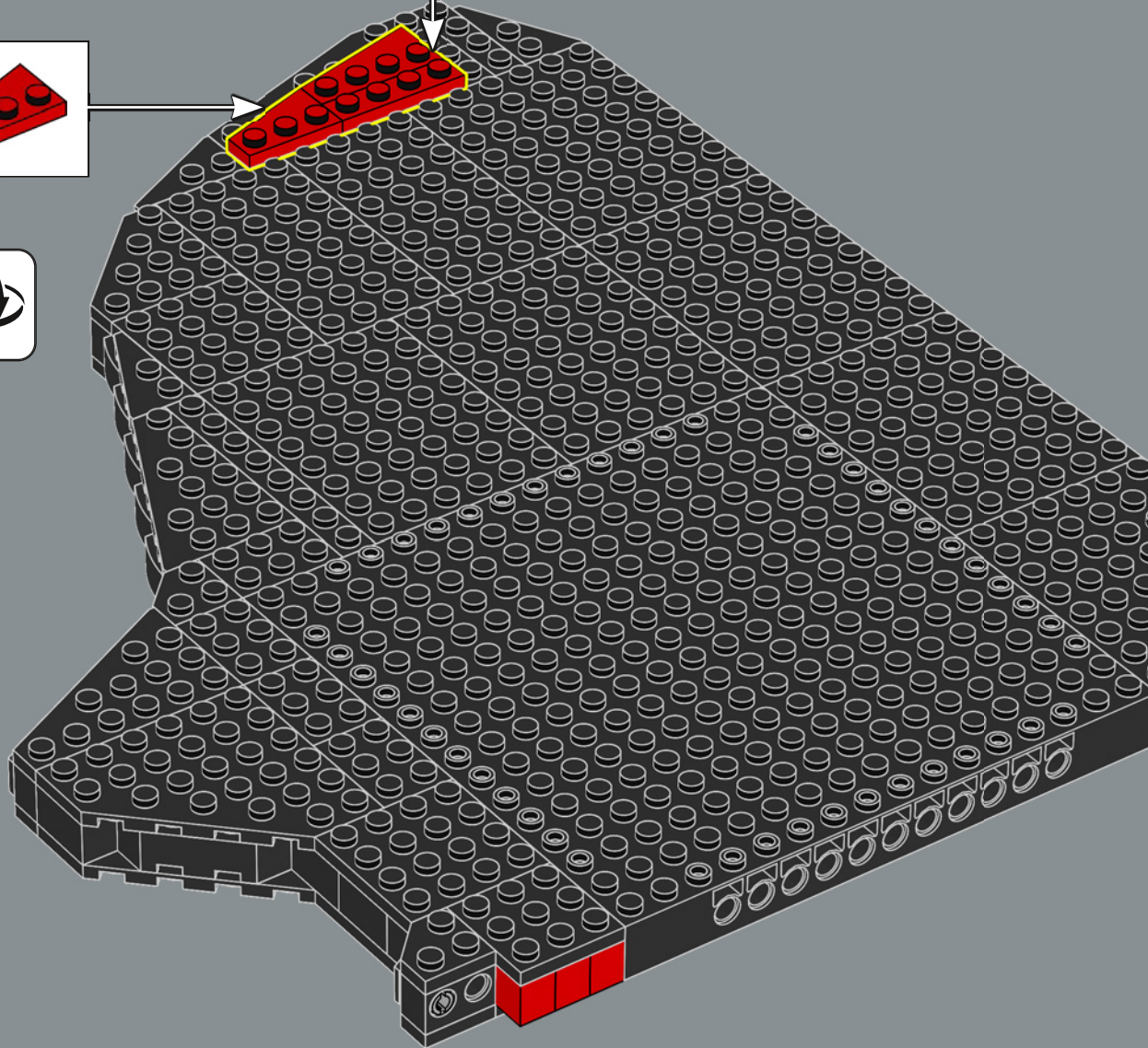
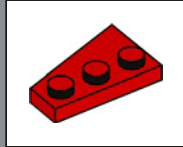



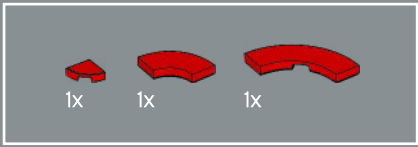

26

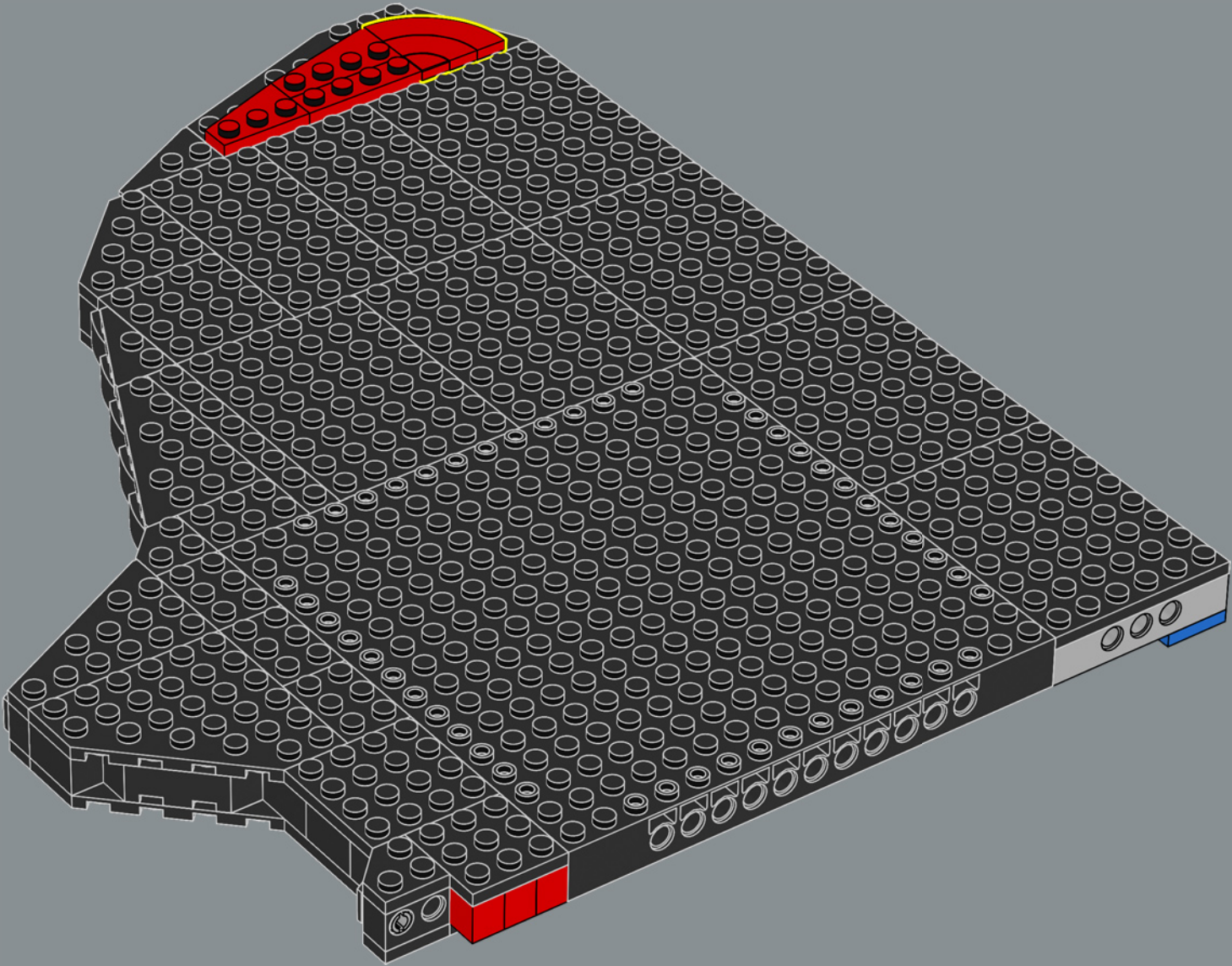

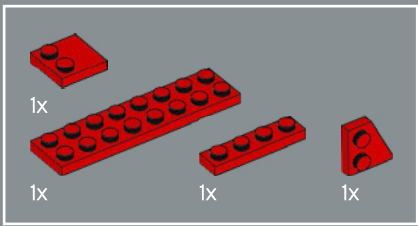

27

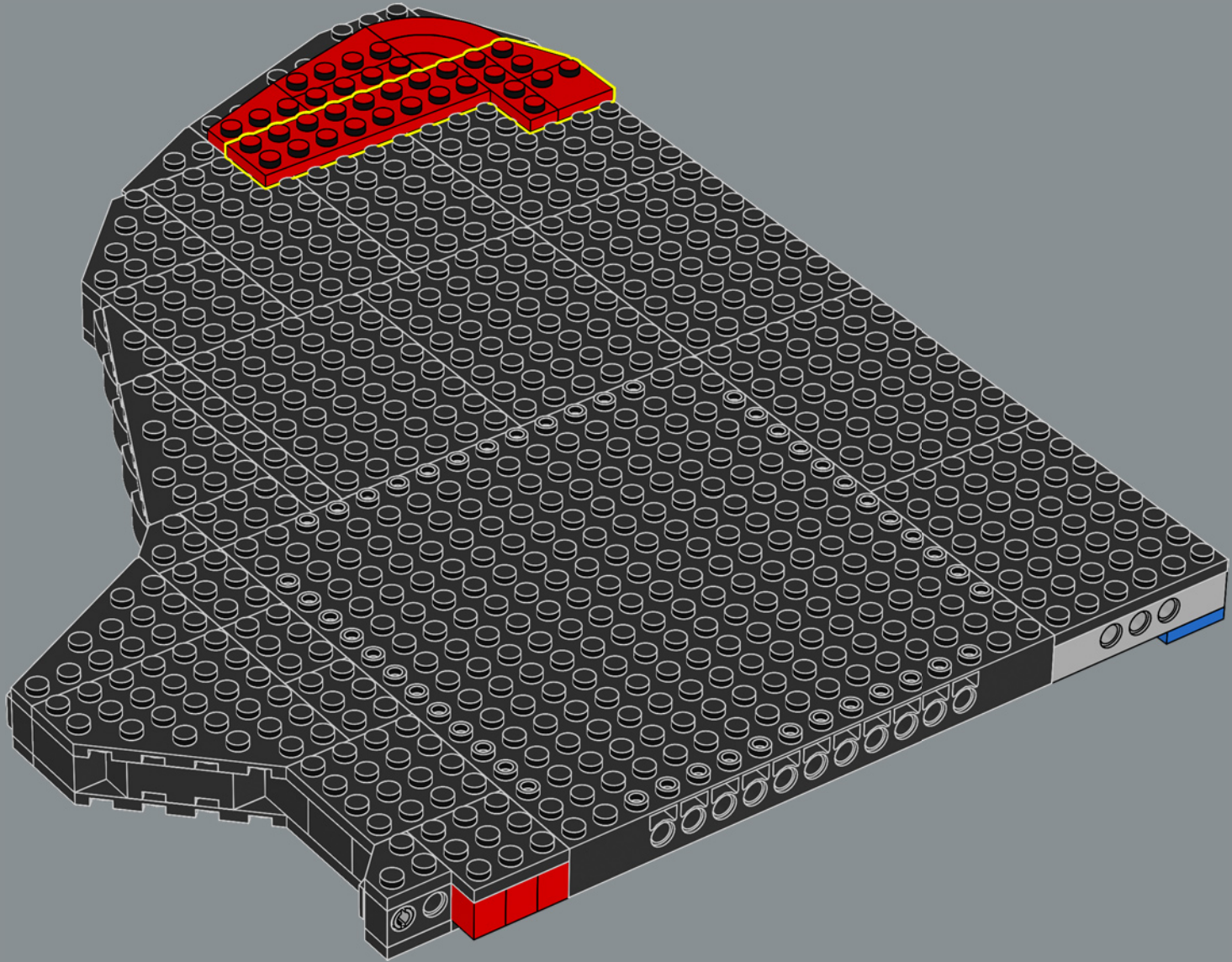

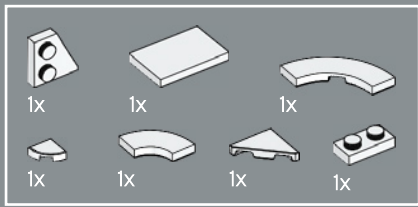

28

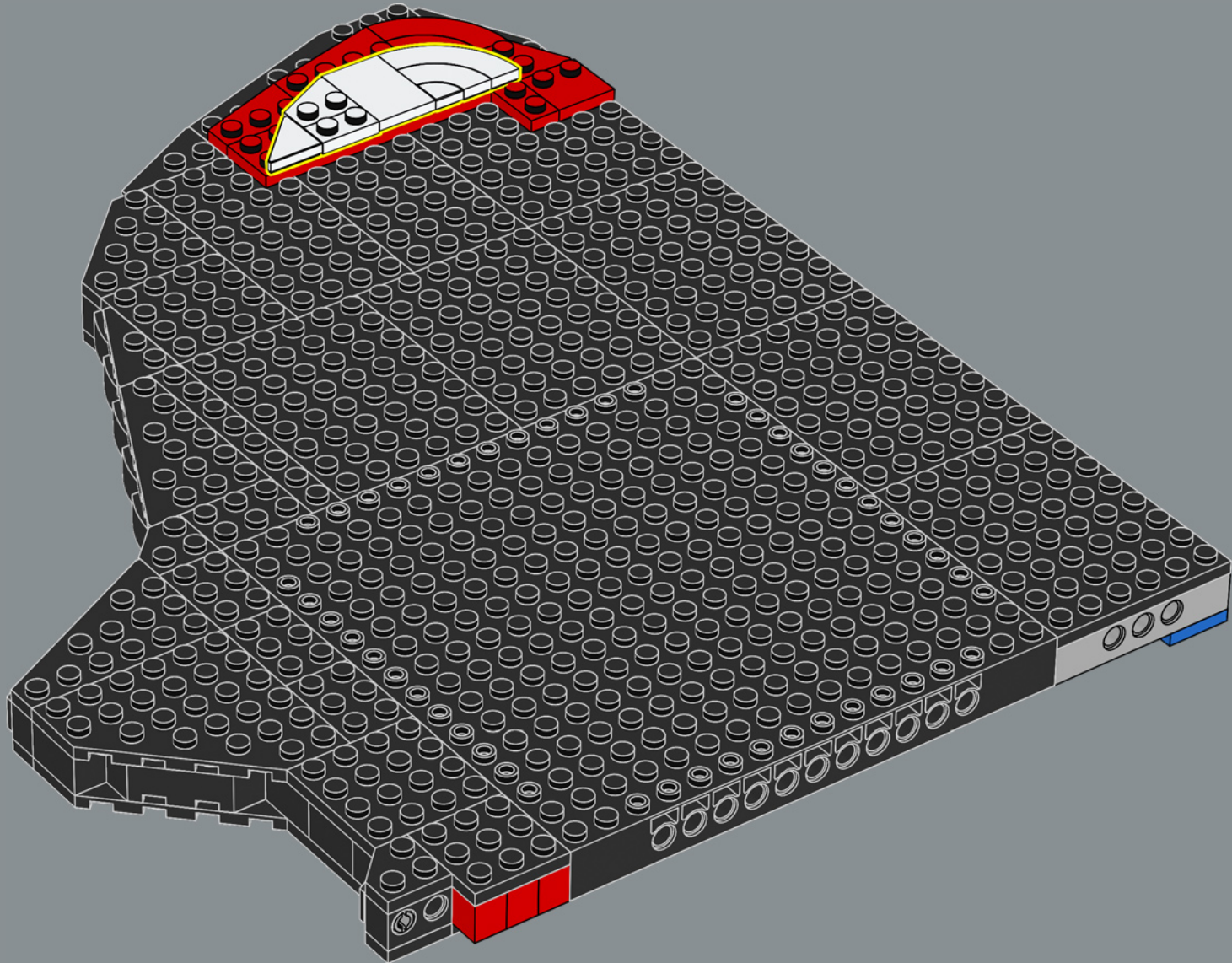

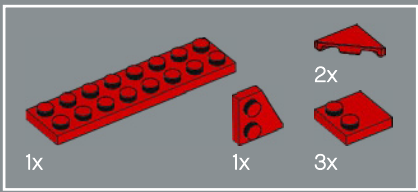

29

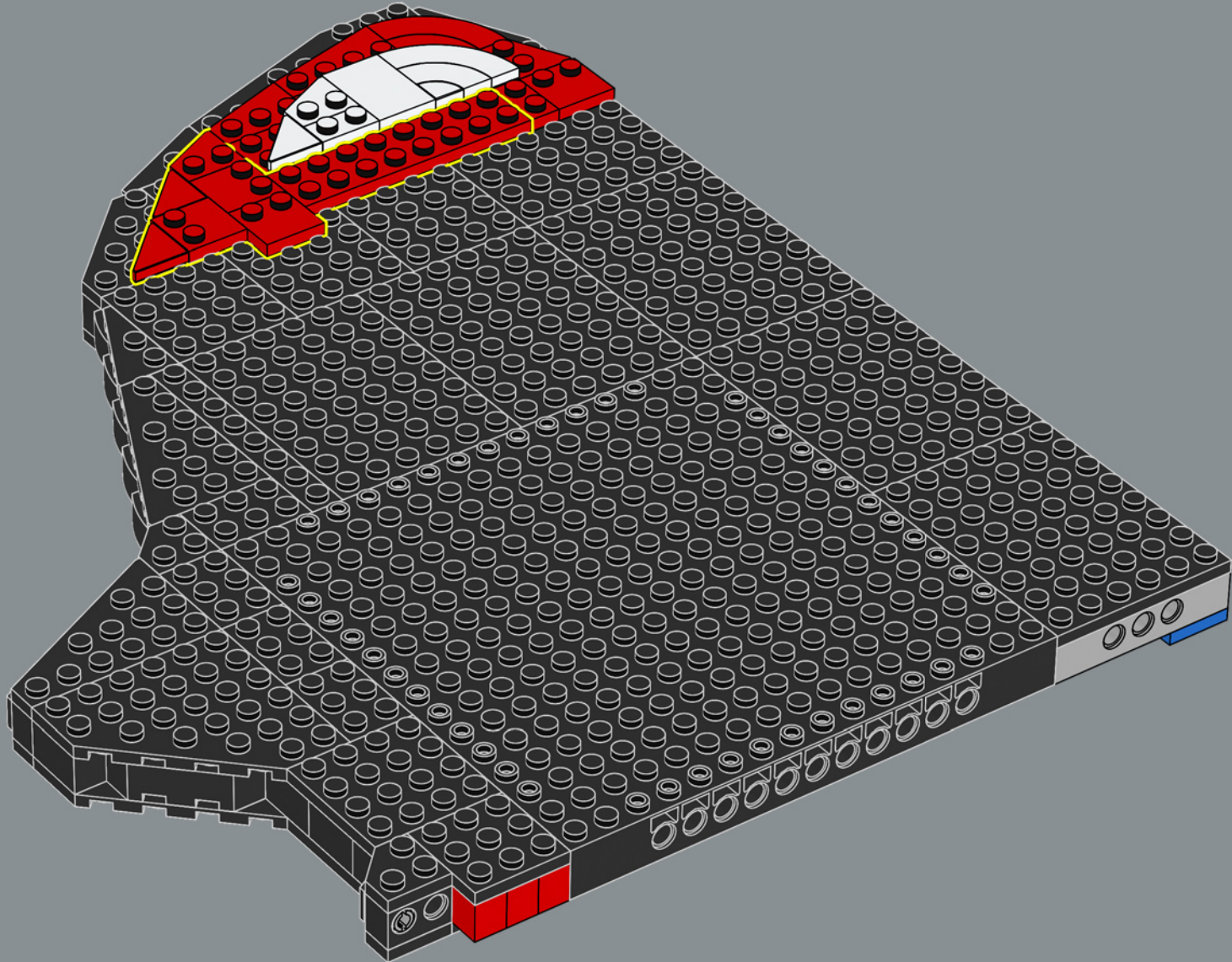

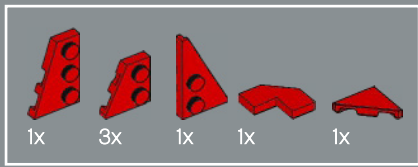

30

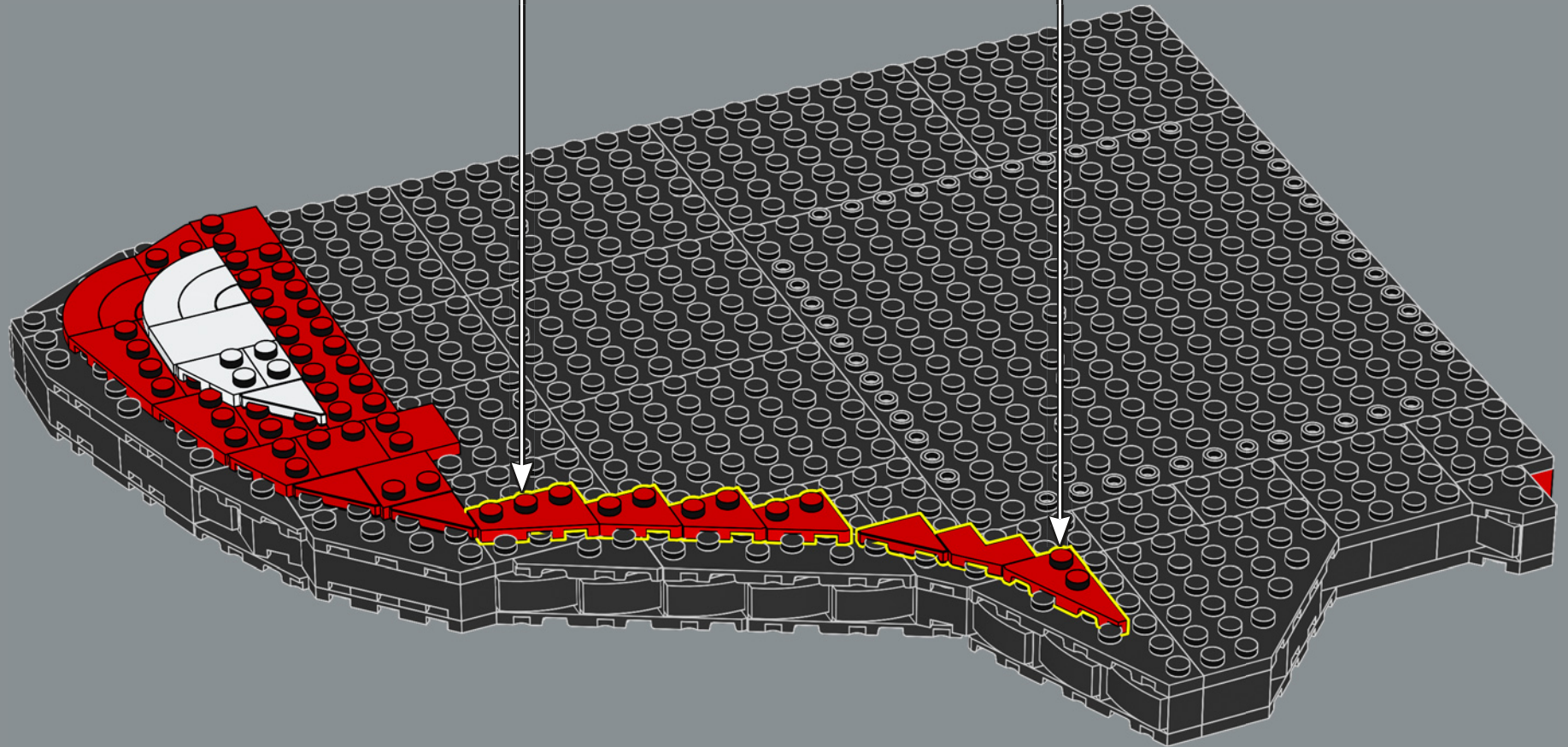
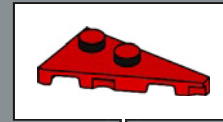
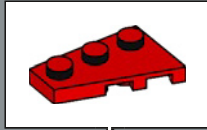

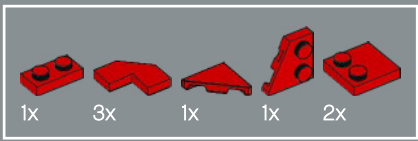

31

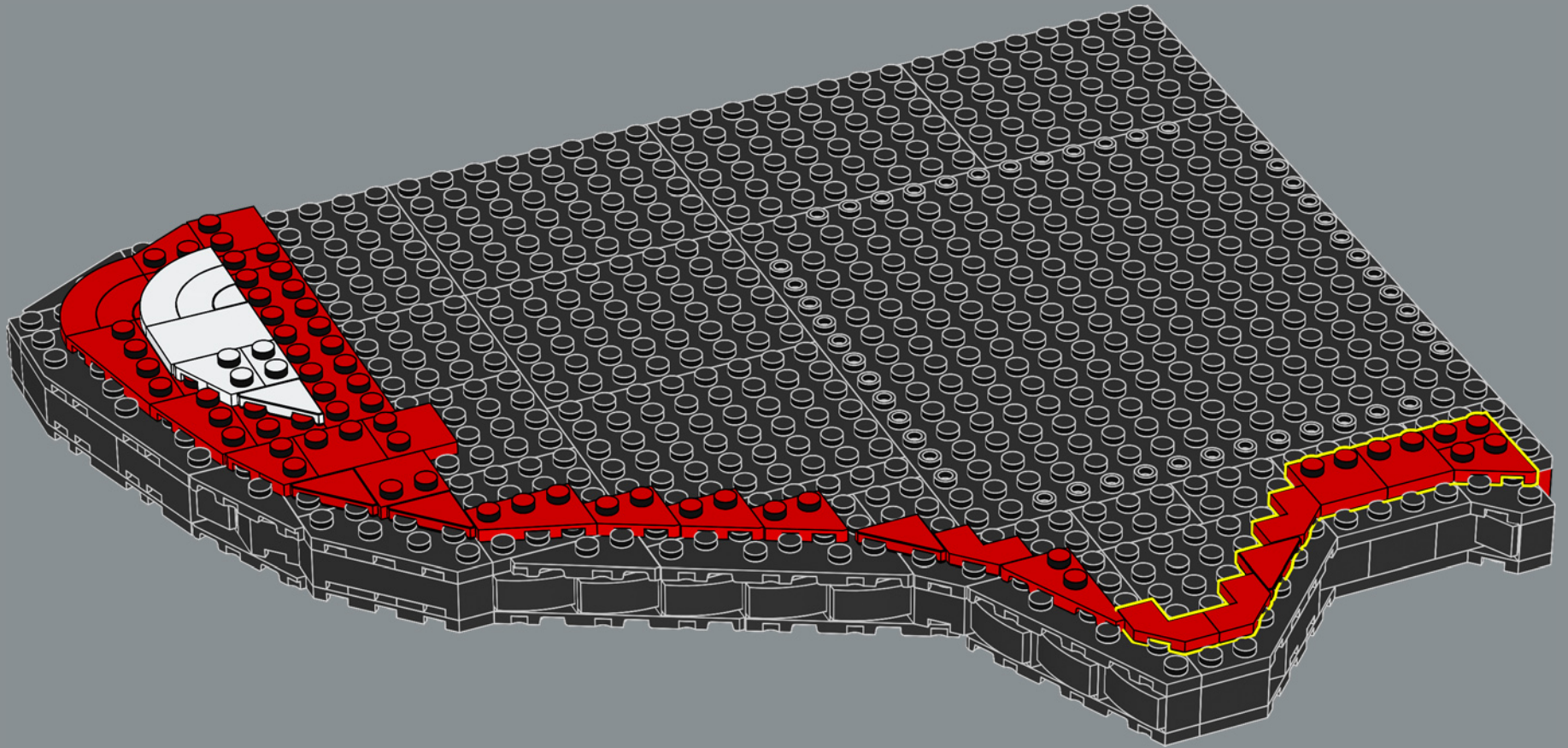

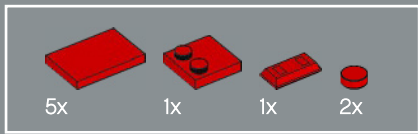

32

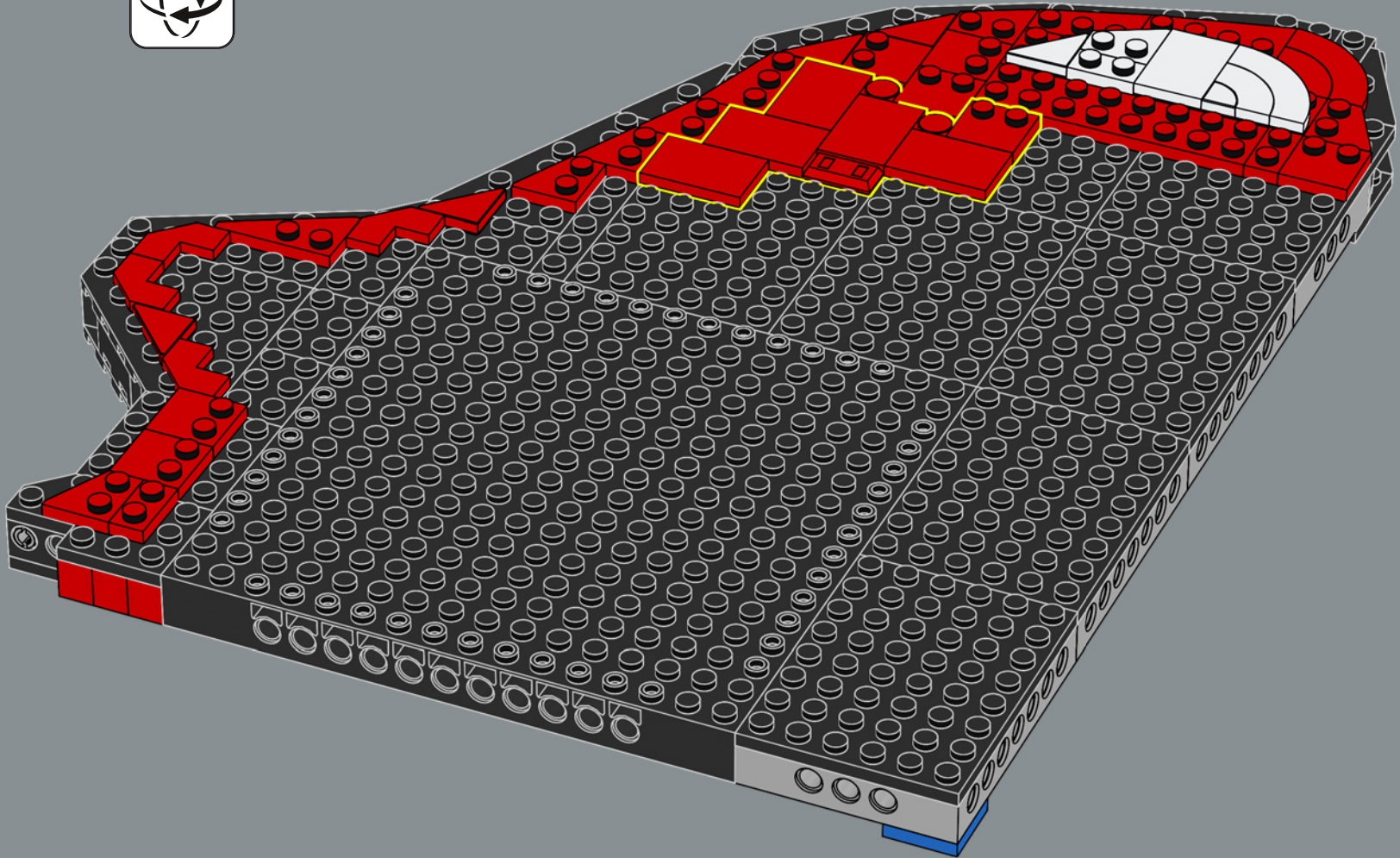

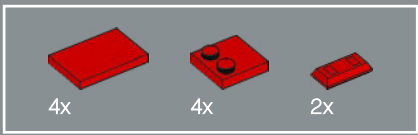

33

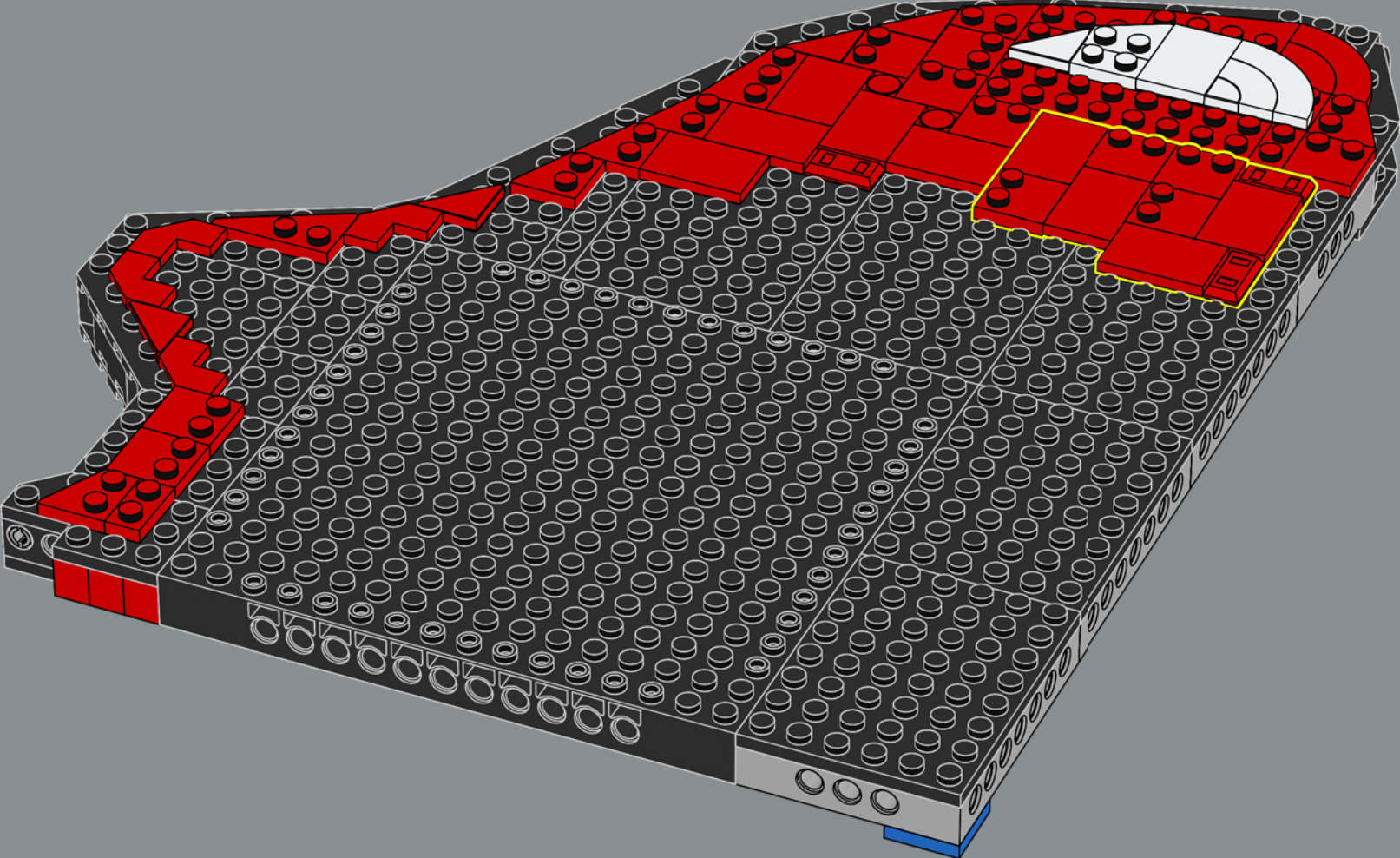



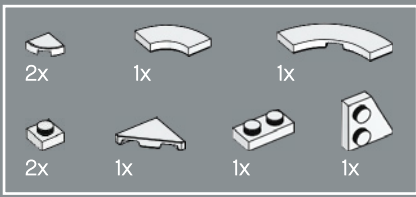

34

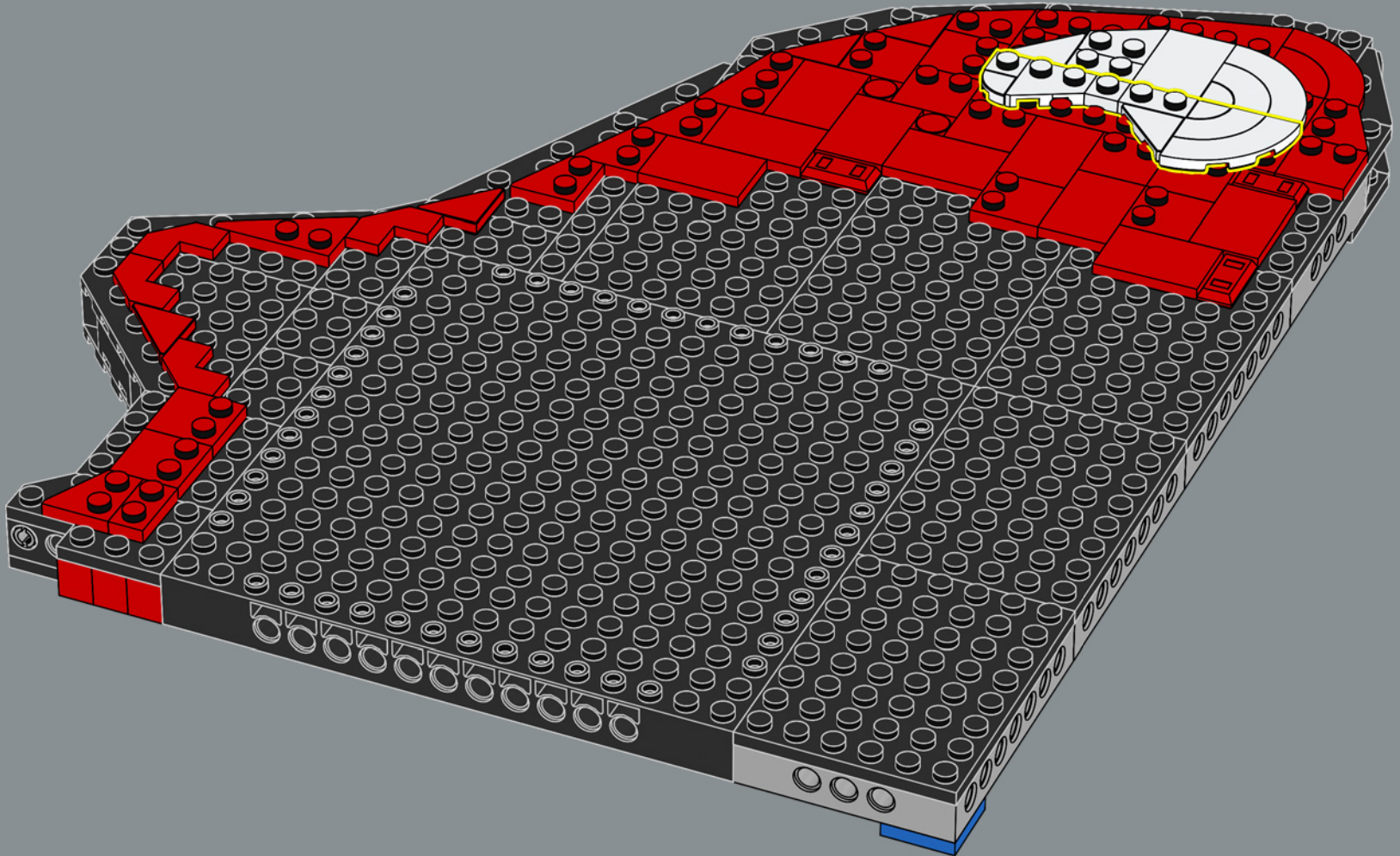

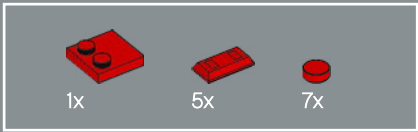

35

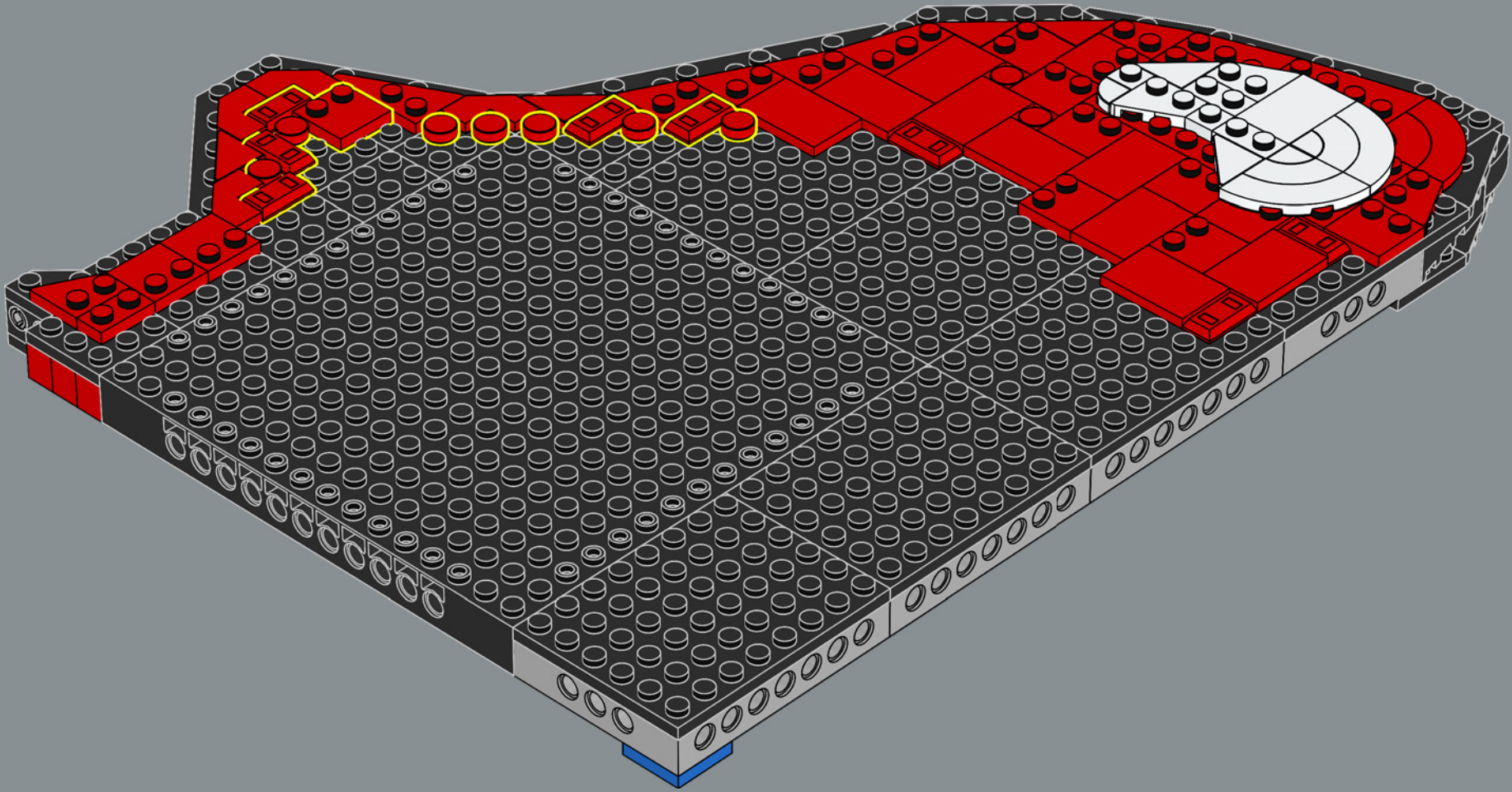

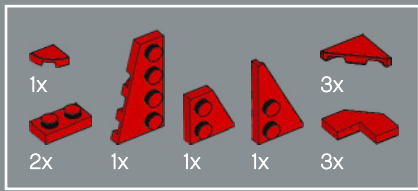

36

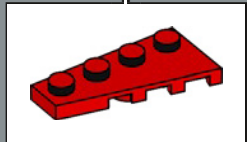
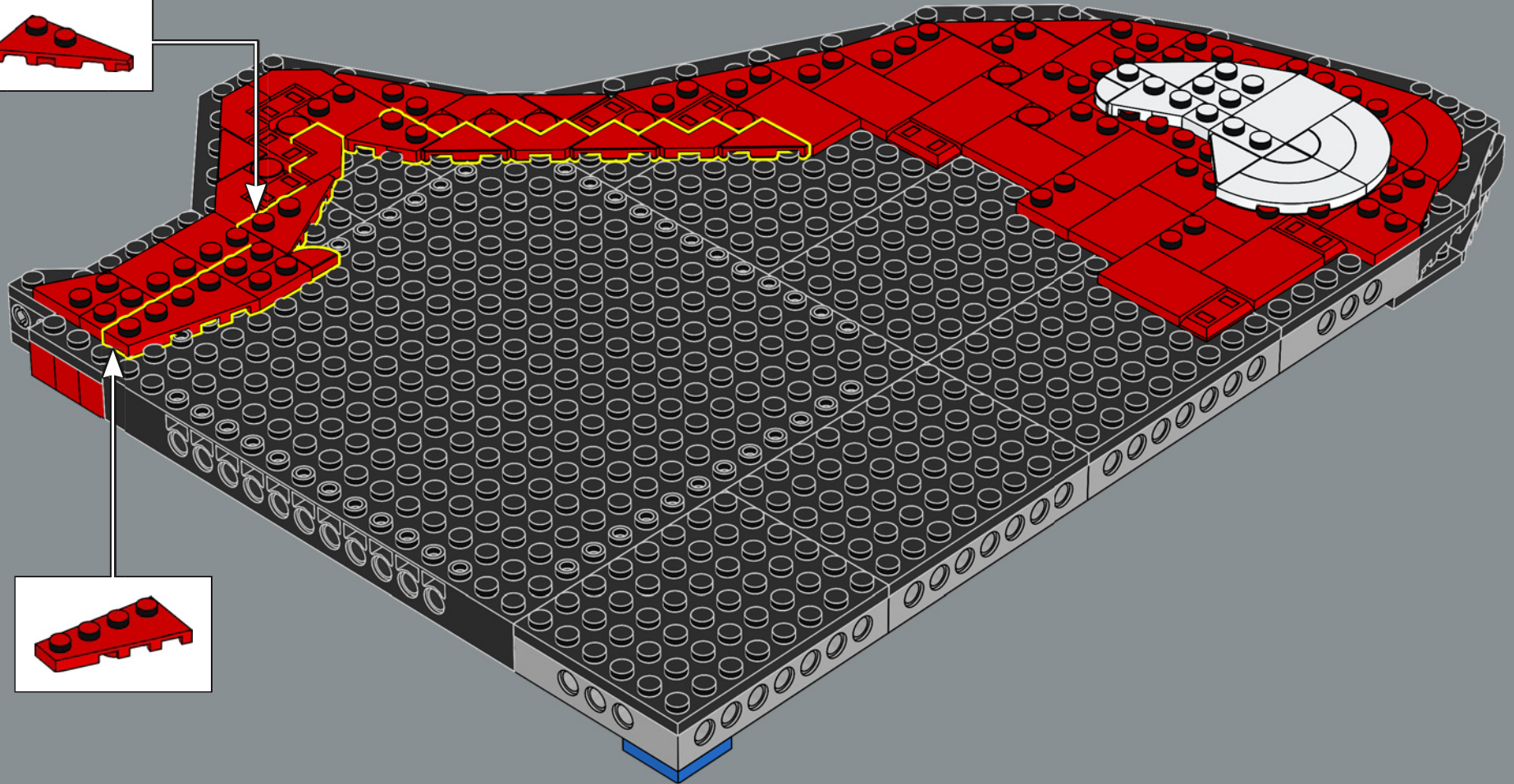
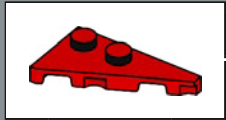

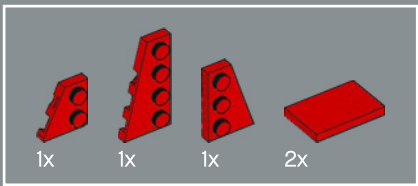

37

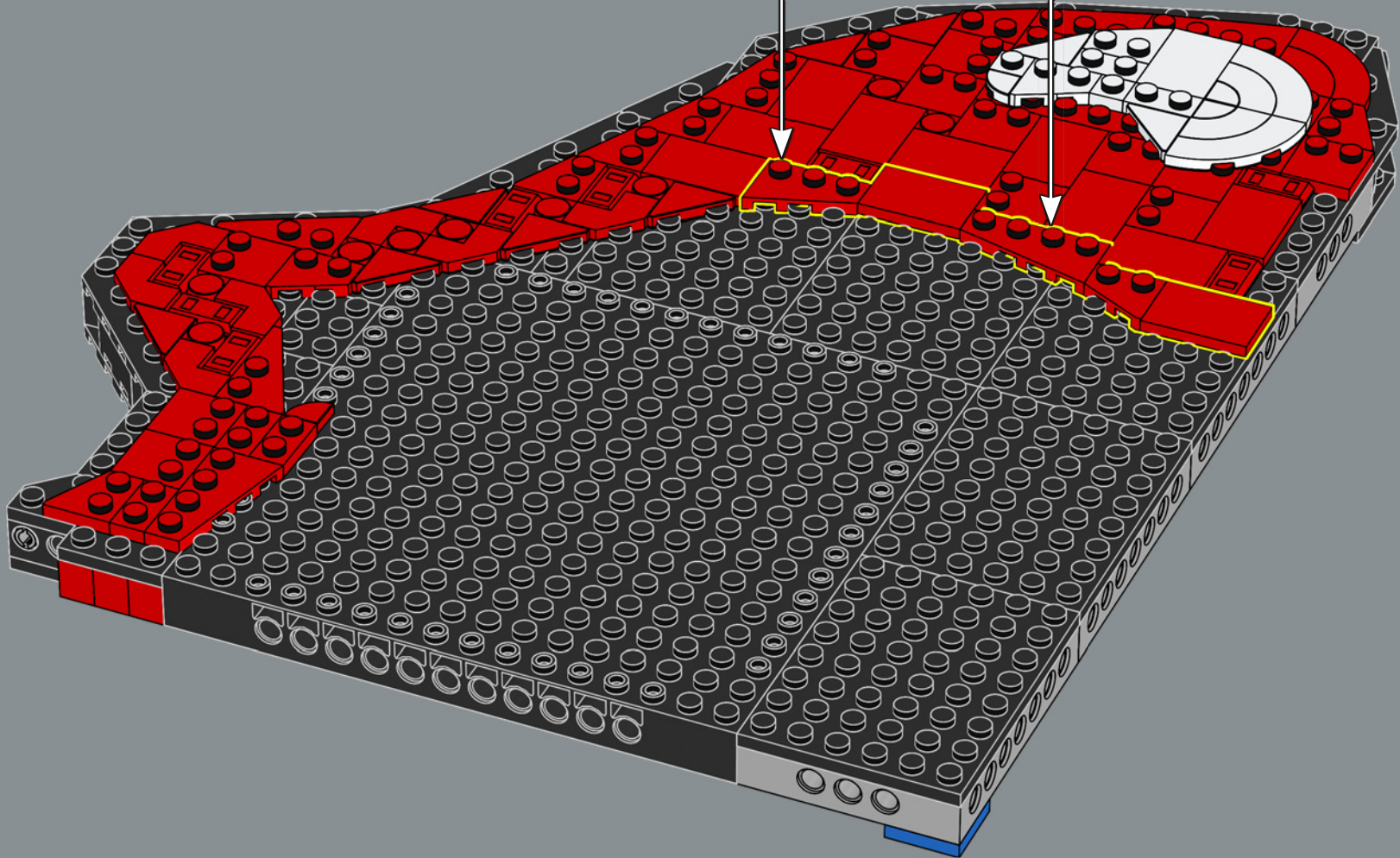
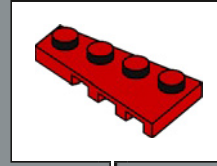

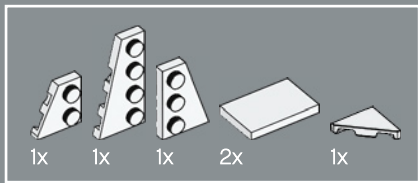

38

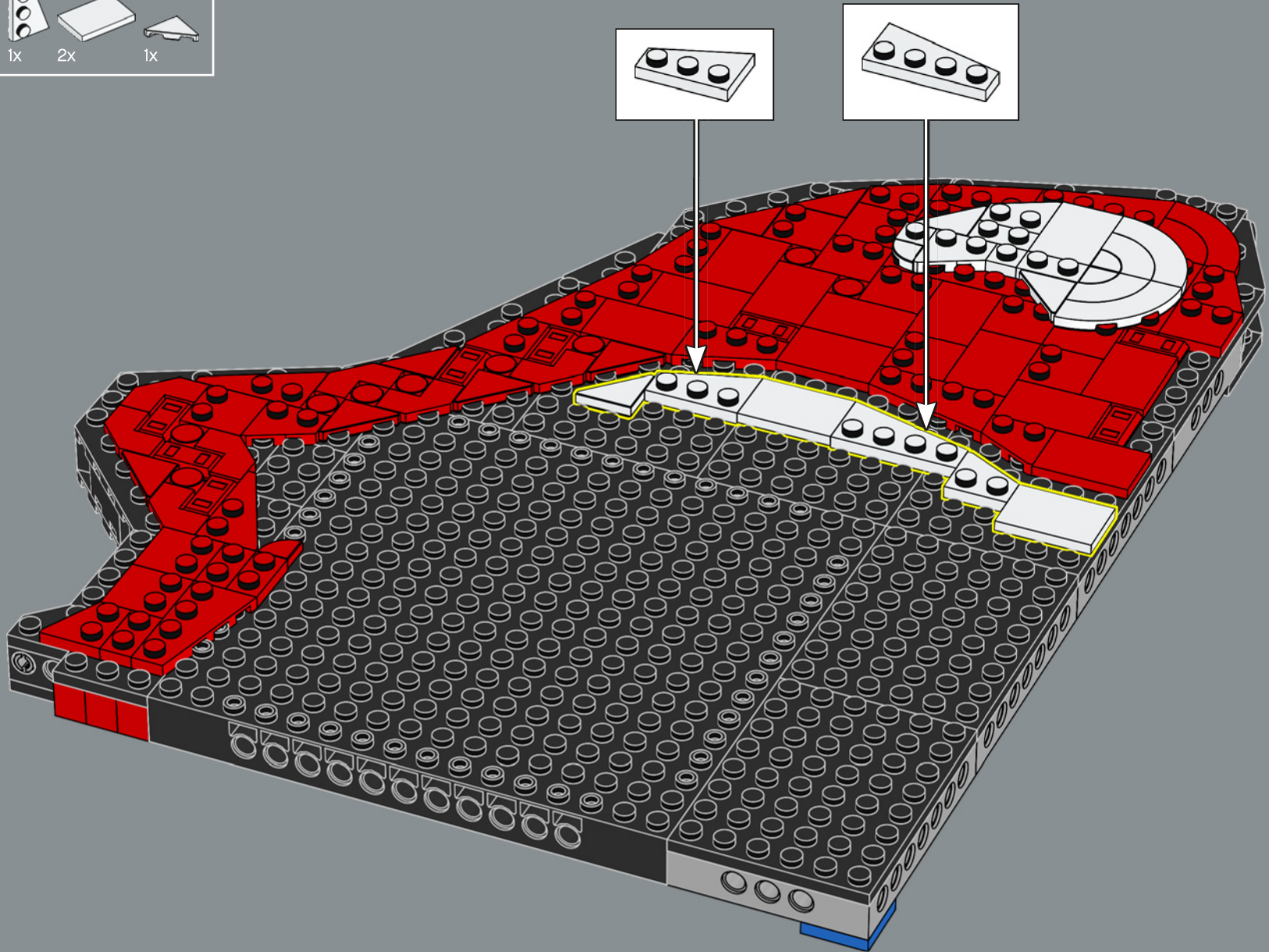

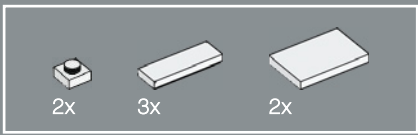

39

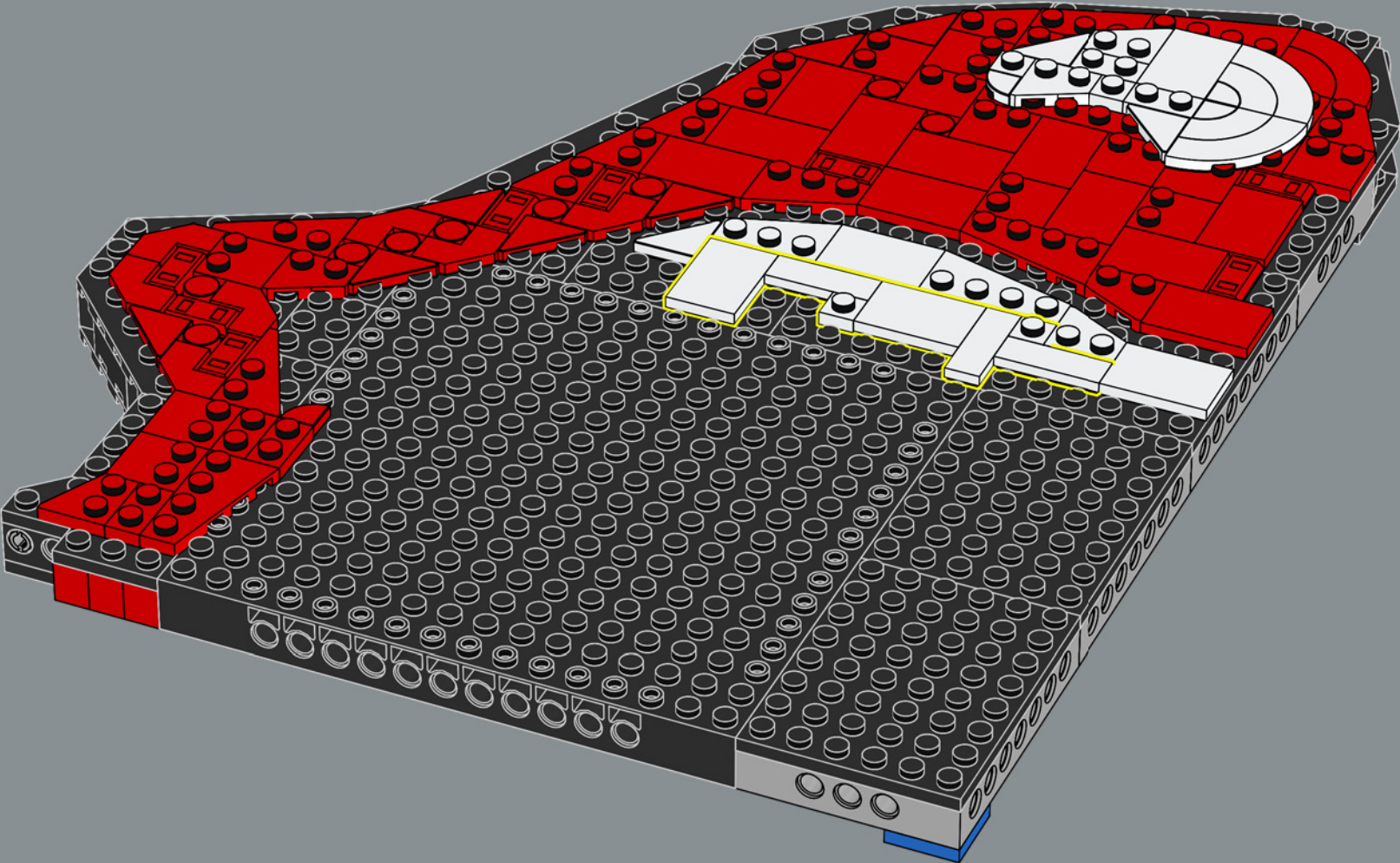

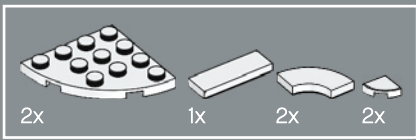

40

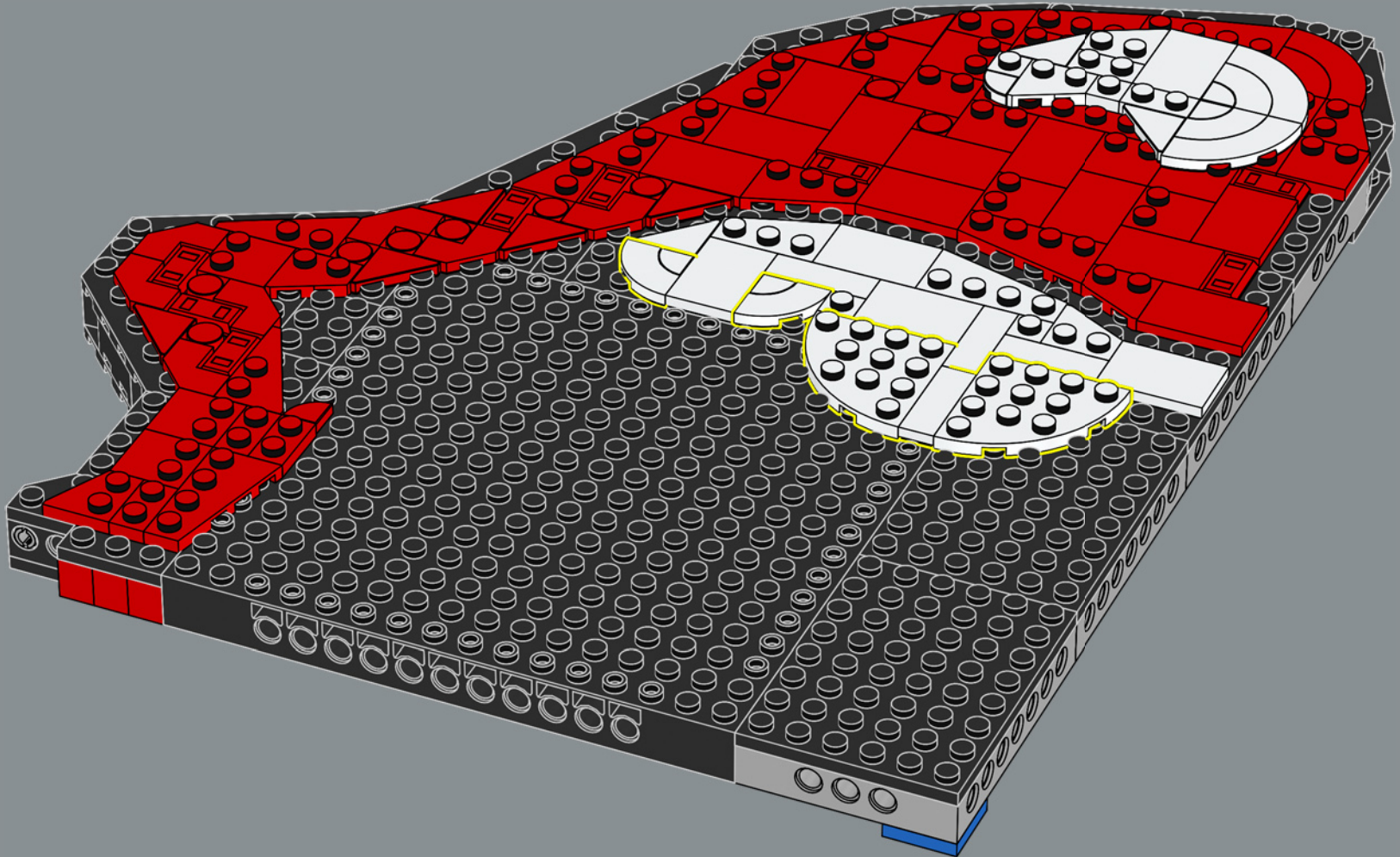

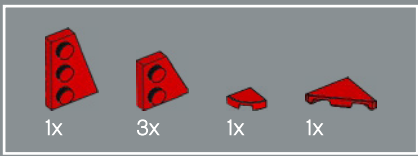

41

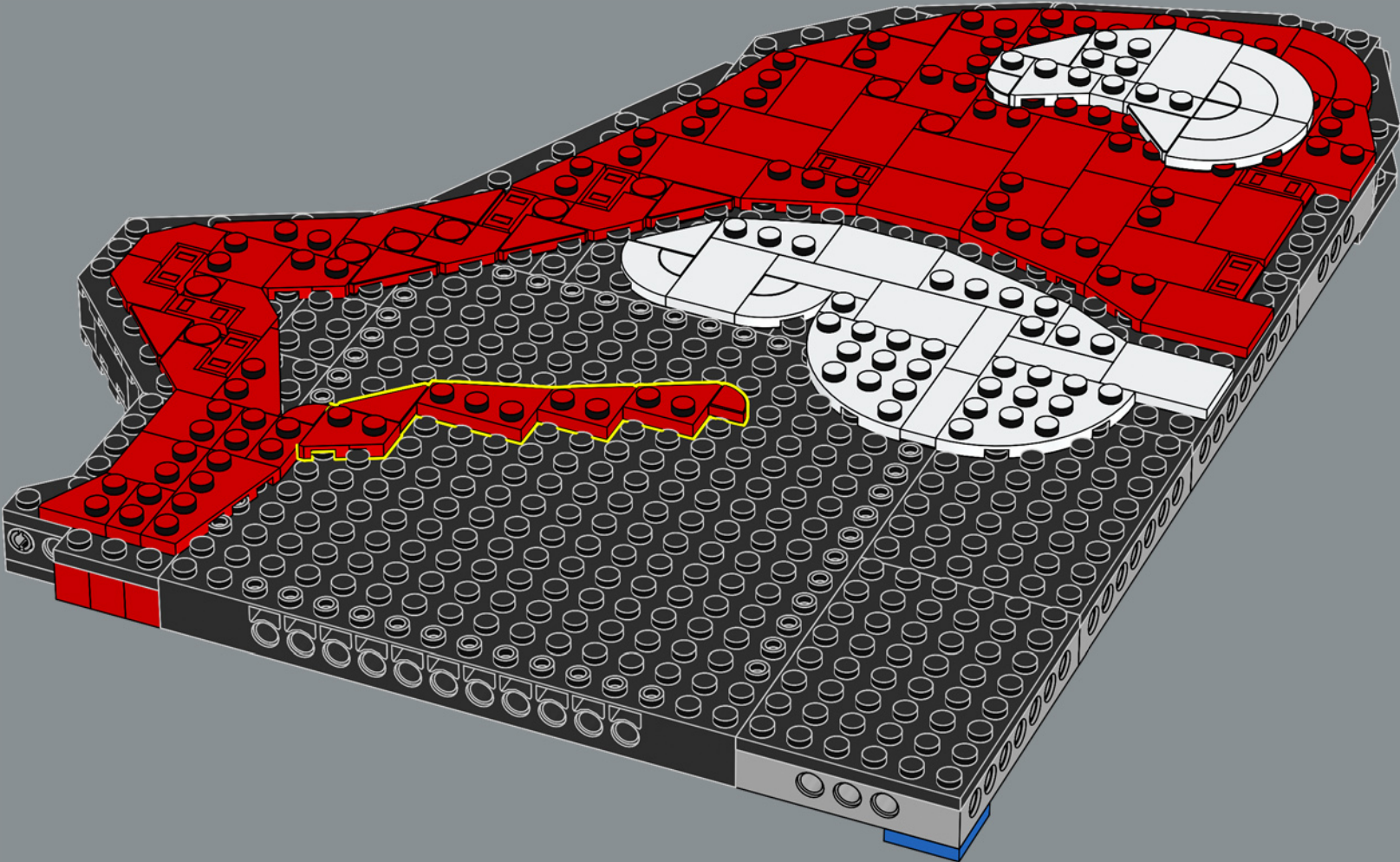



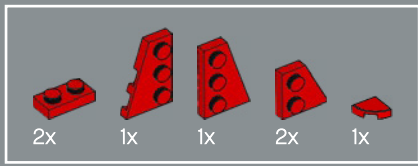

42

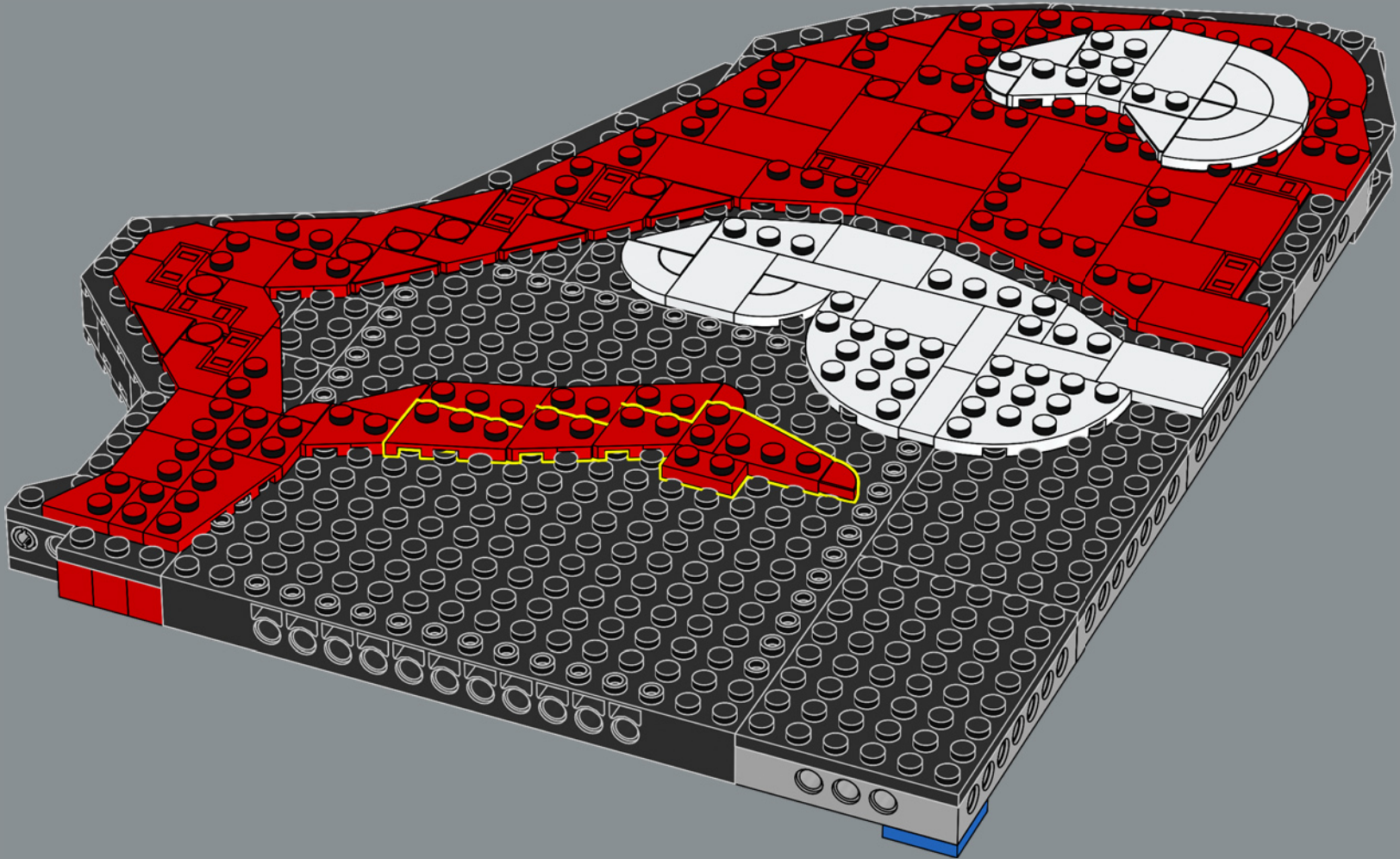



4x

43

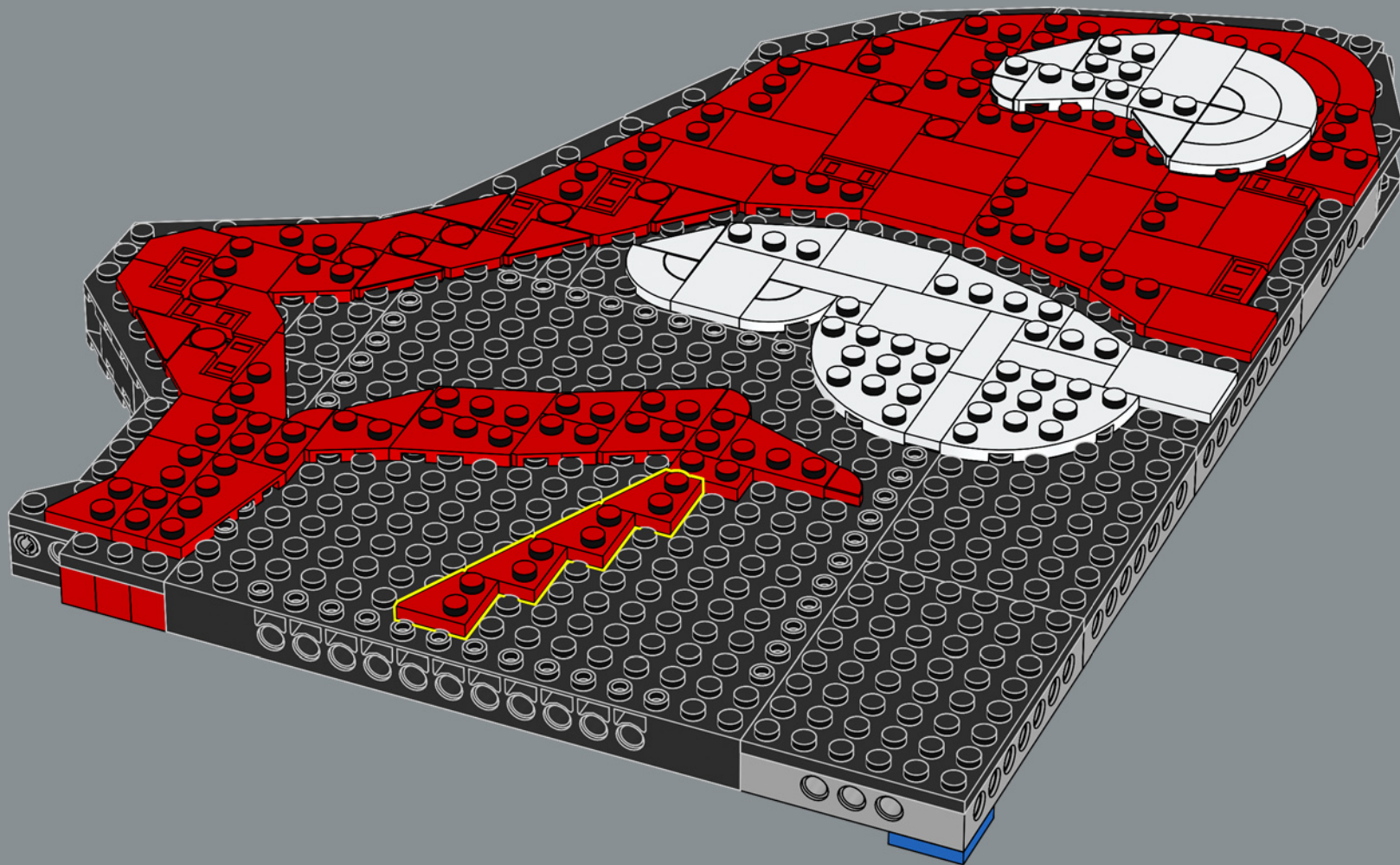

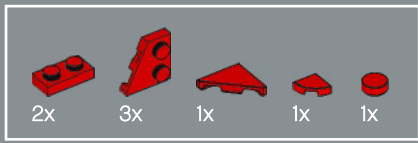

44

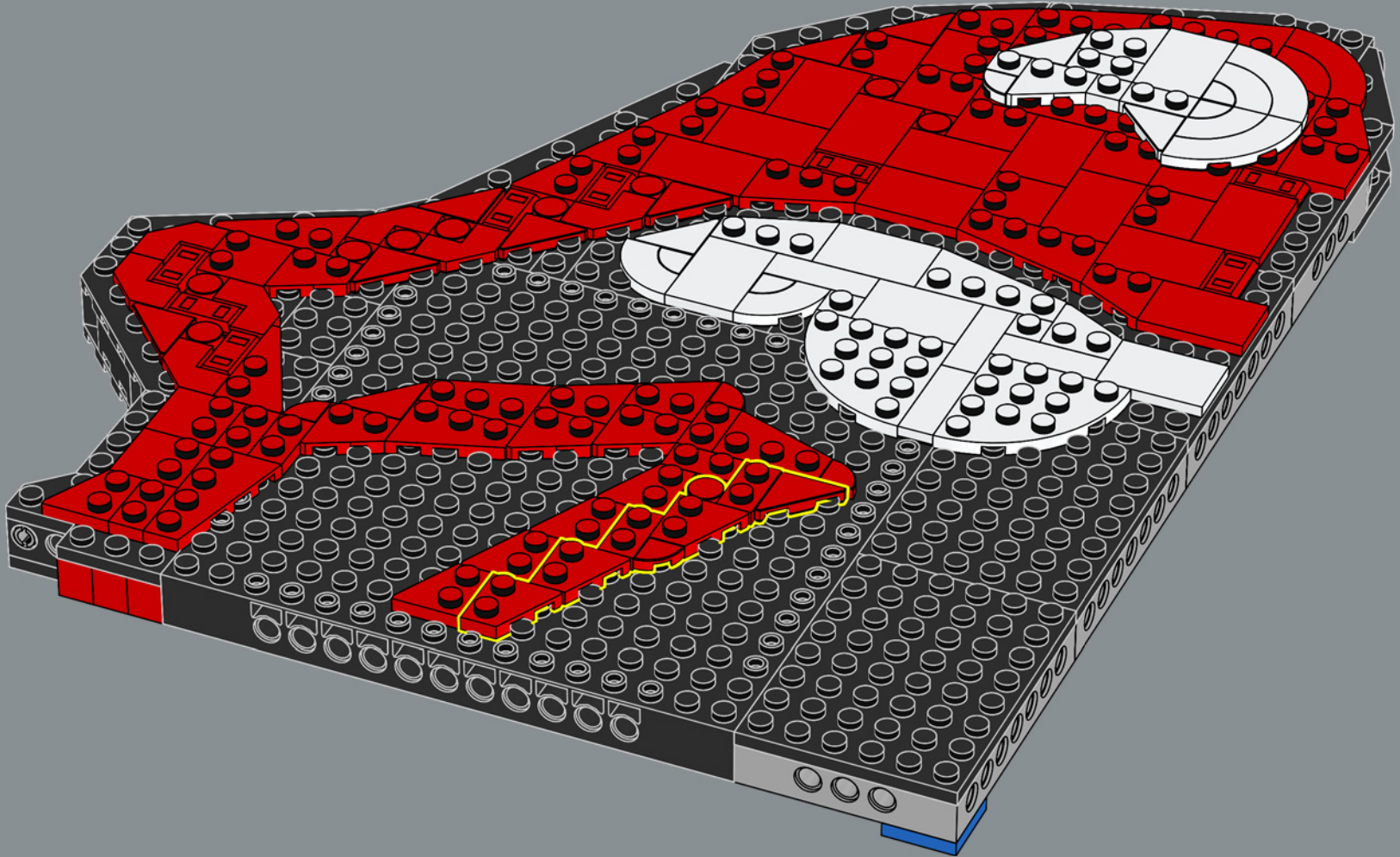

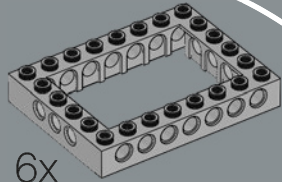
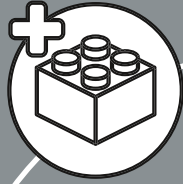

6x

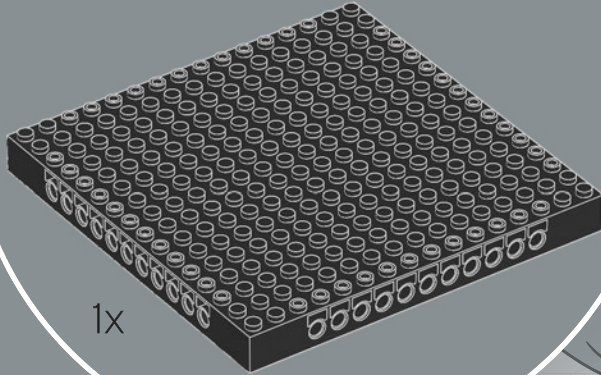

1x



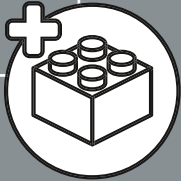
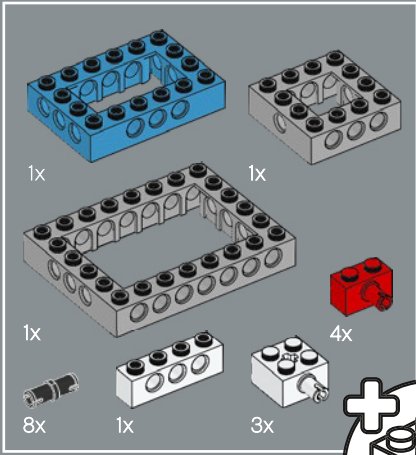
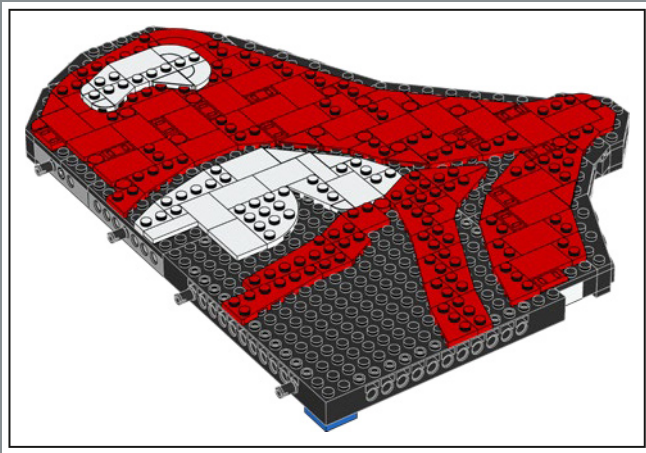

45

1

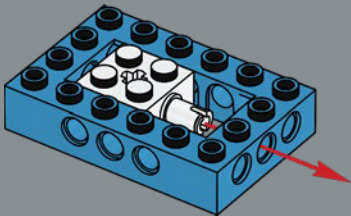

2

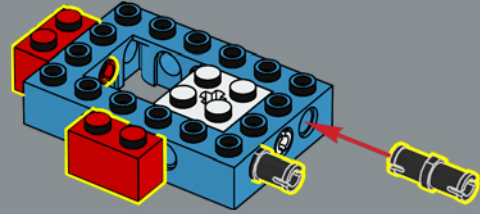

3

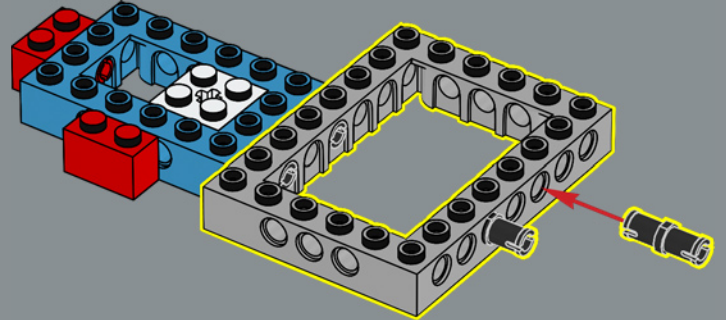

4

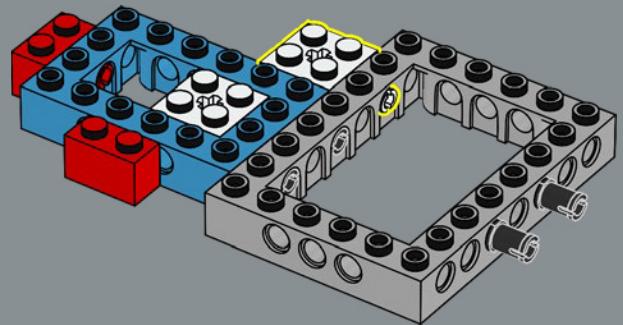

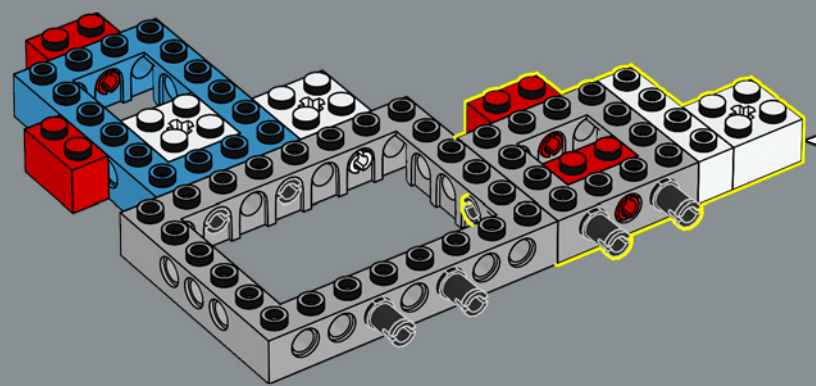
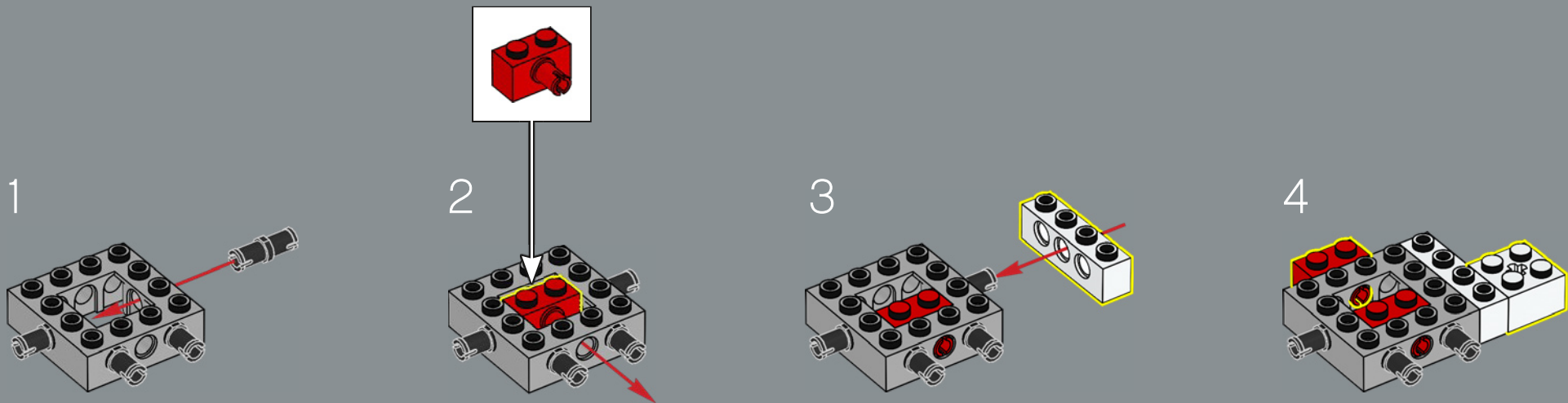

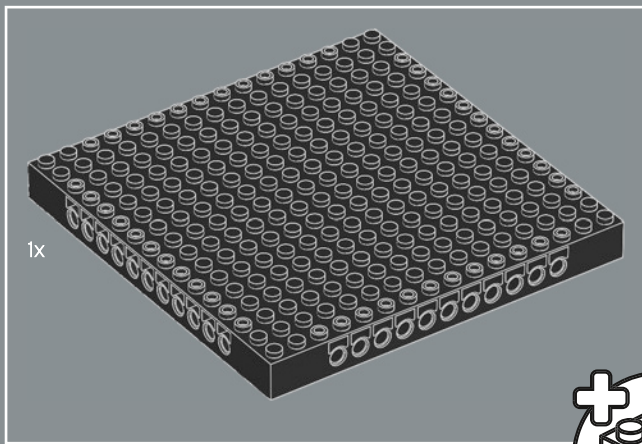

1x

46

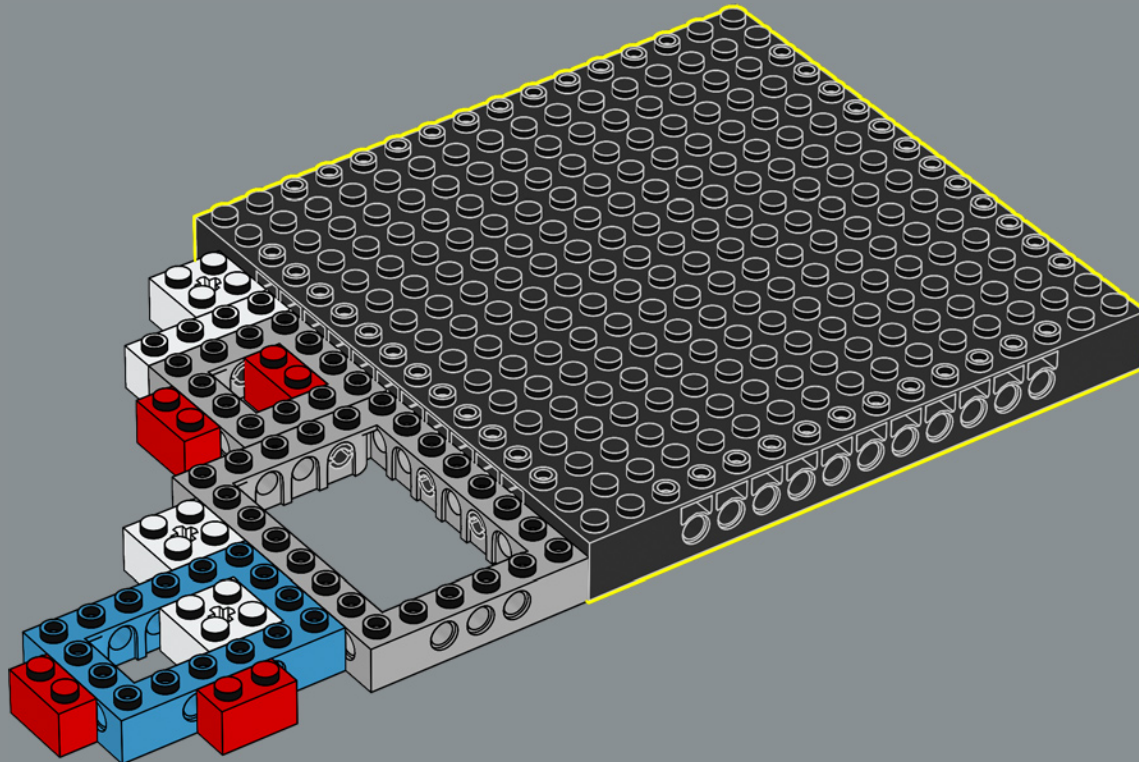
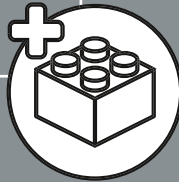

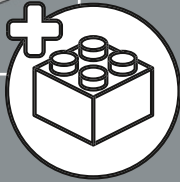
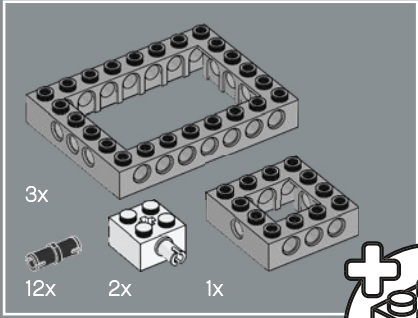
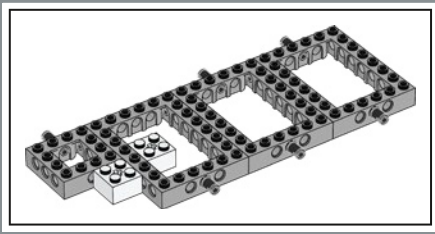

47

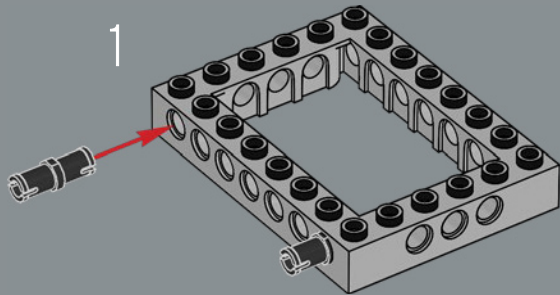

2

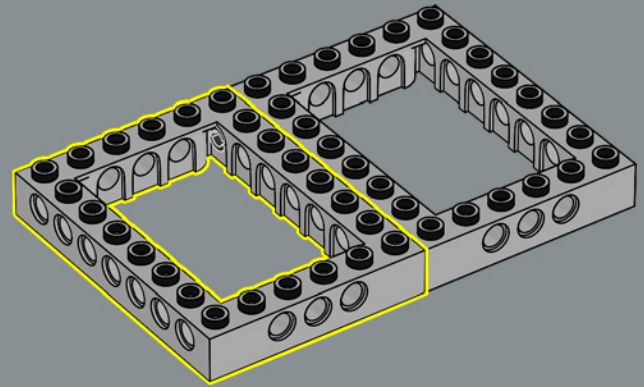

3

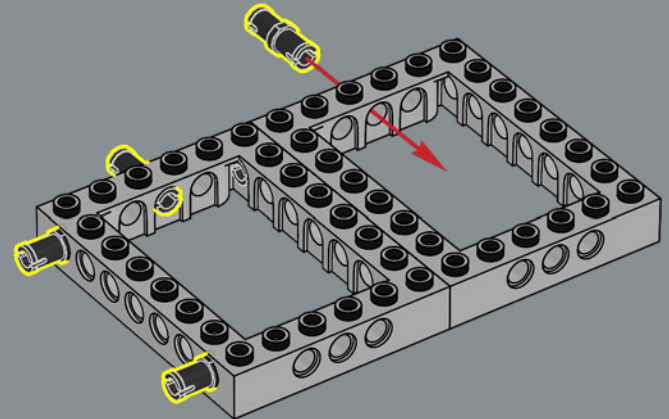



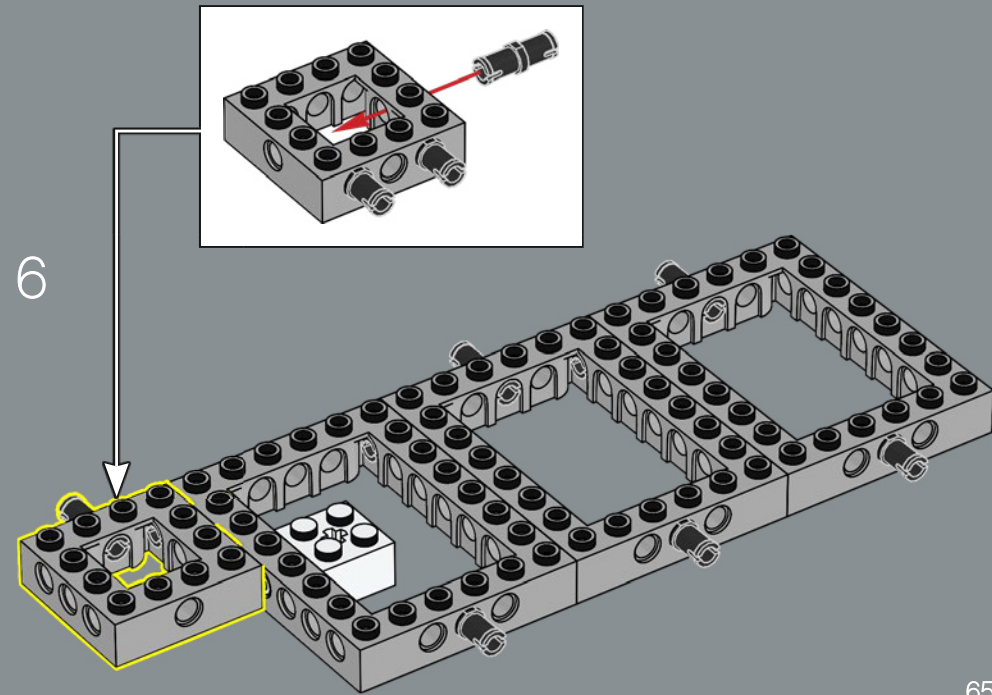
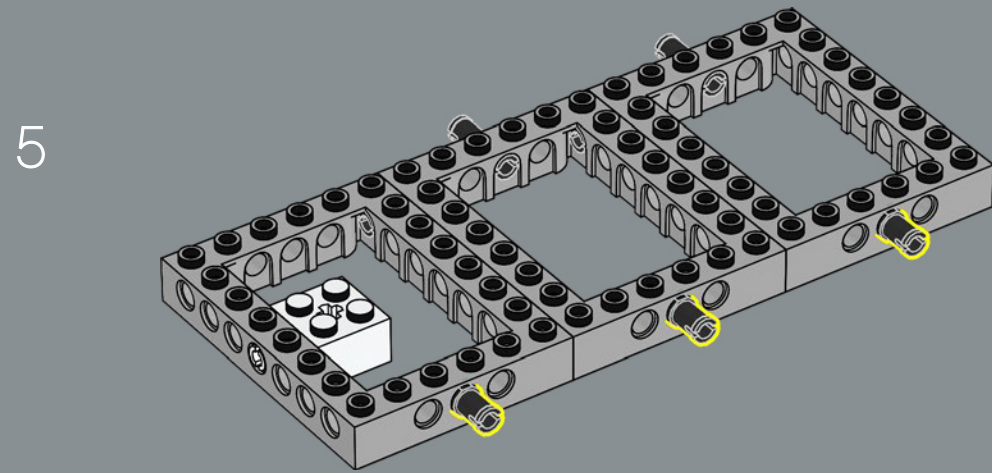
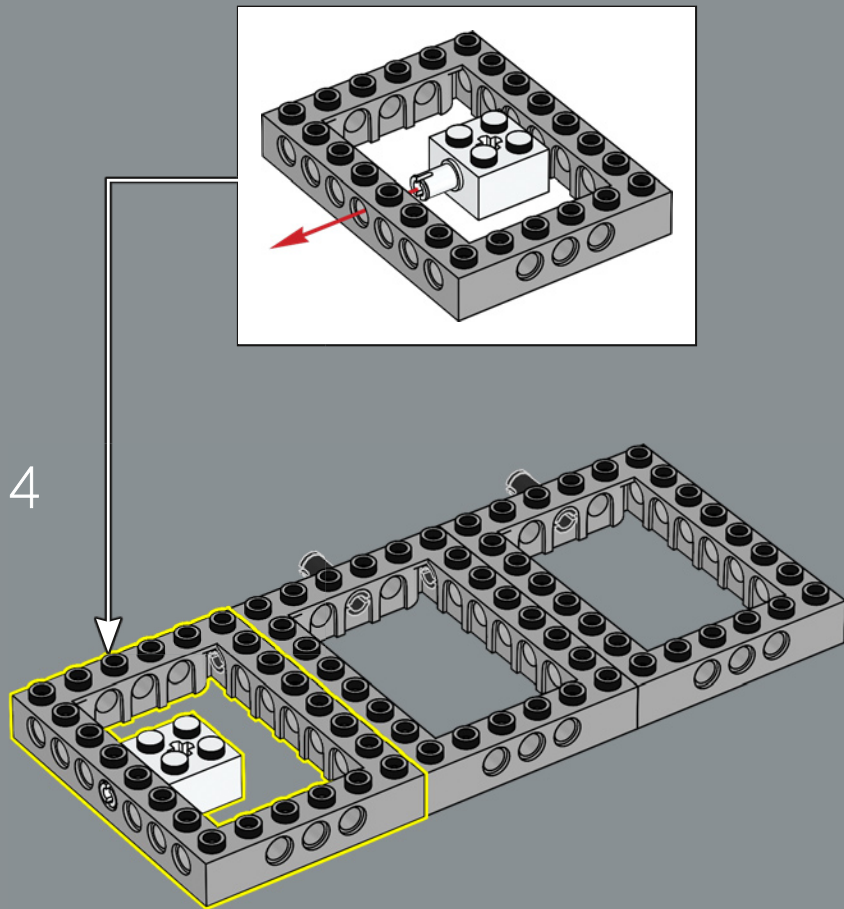

7

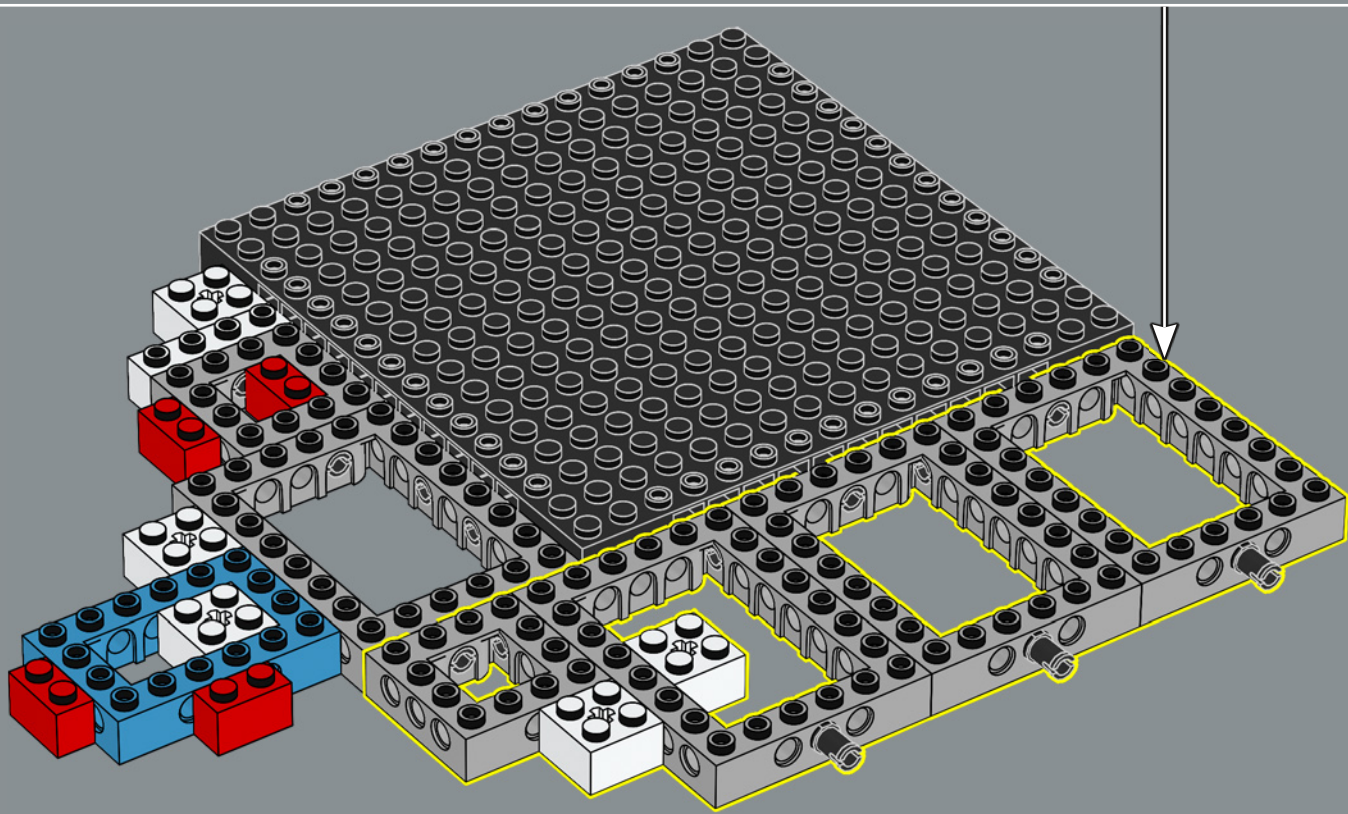
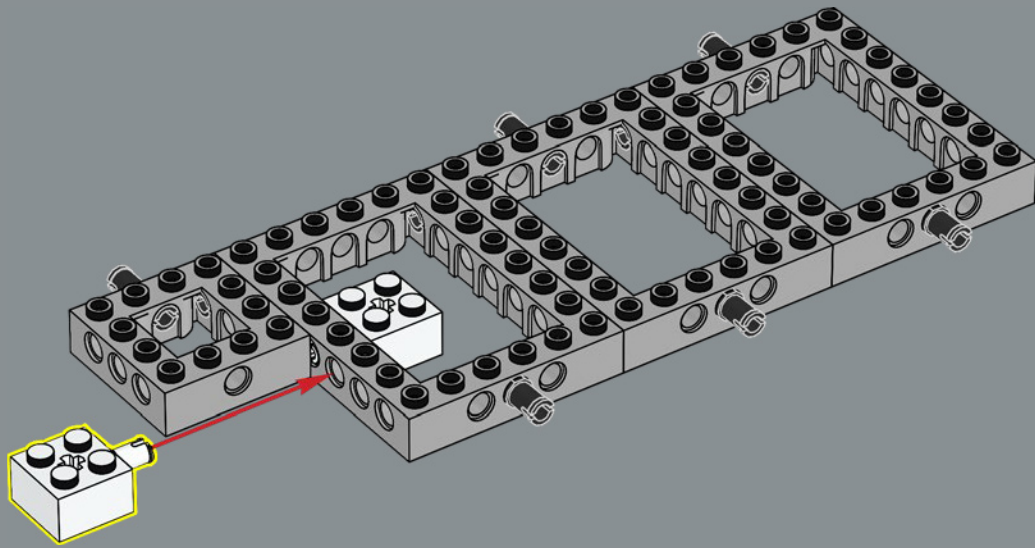

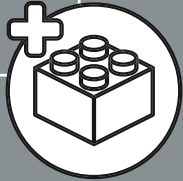
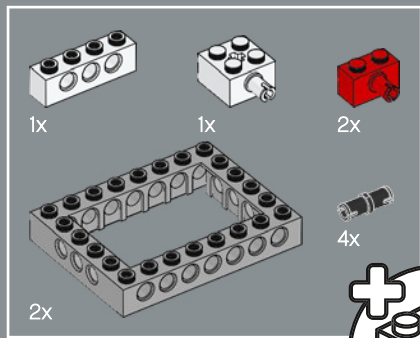

48

1

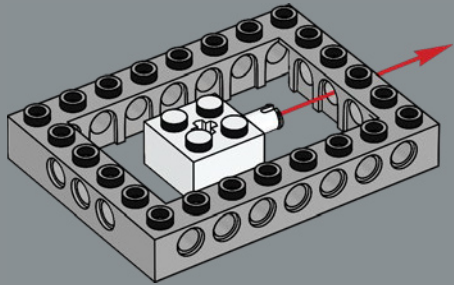

2

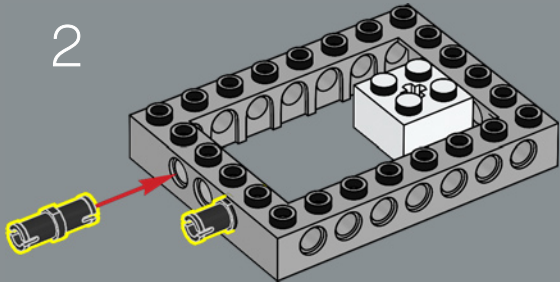

3

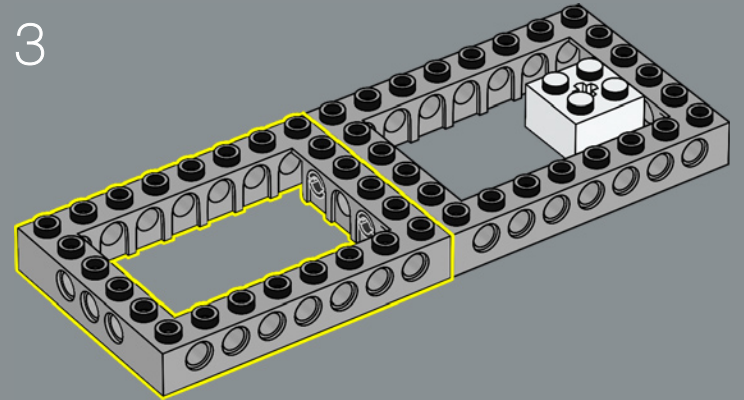

4

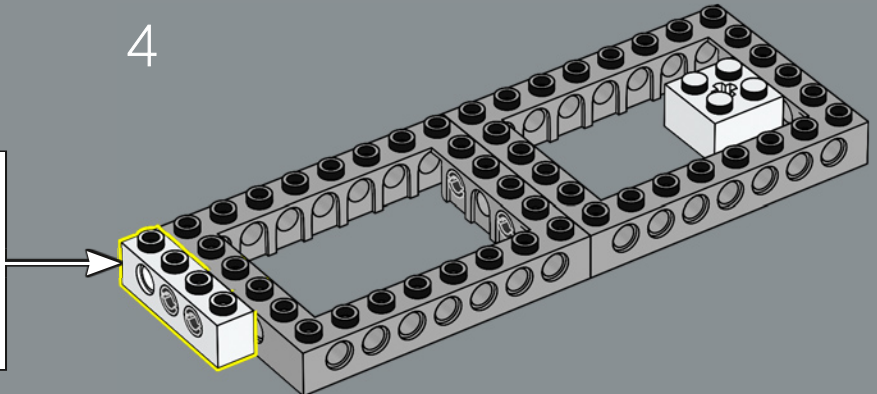
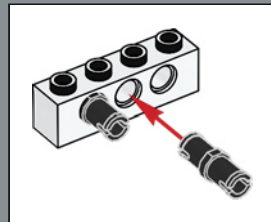

5

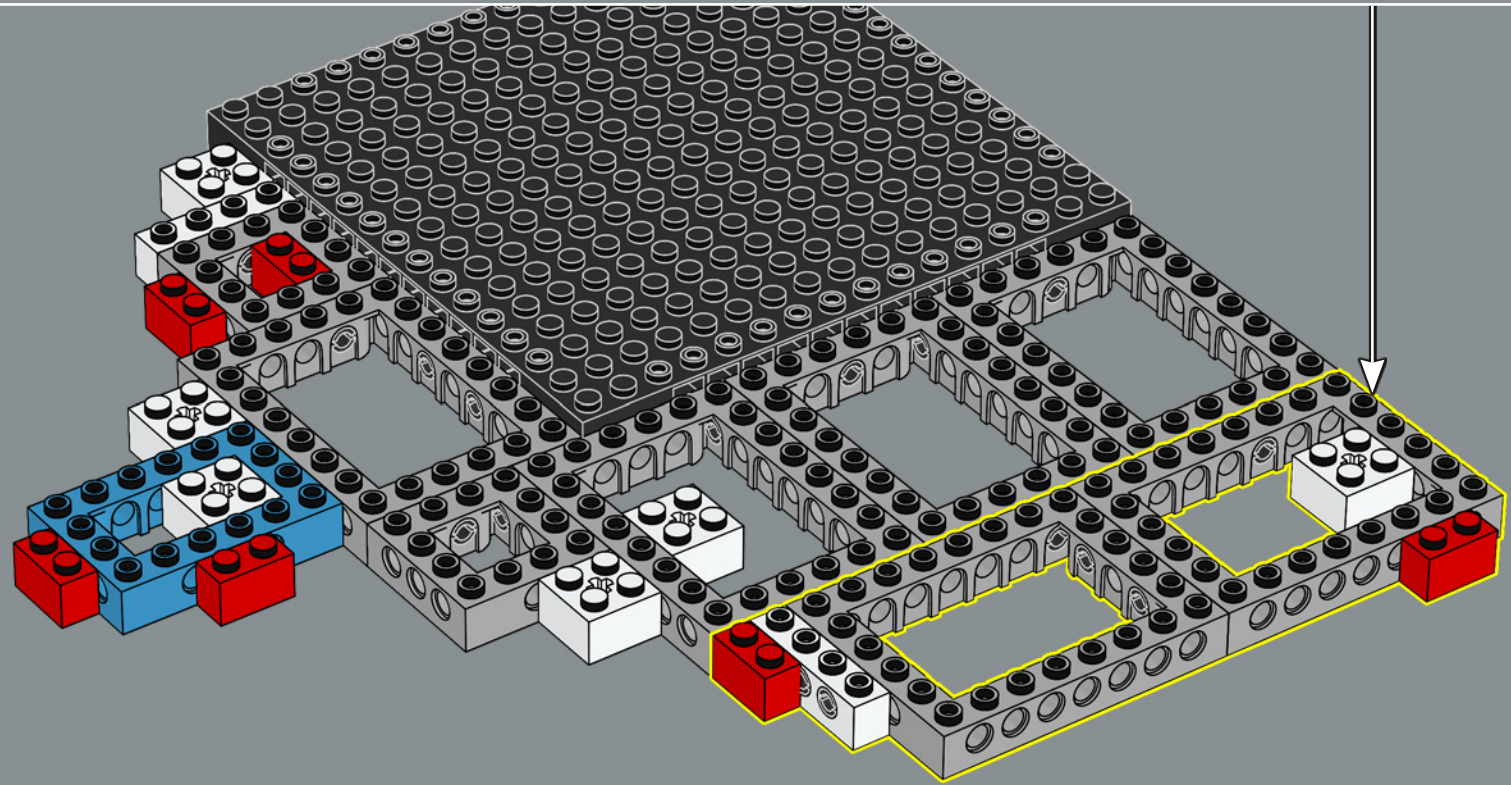
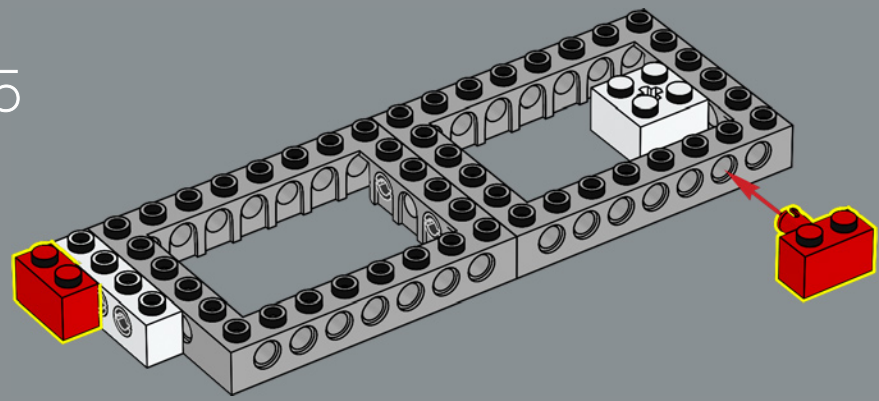

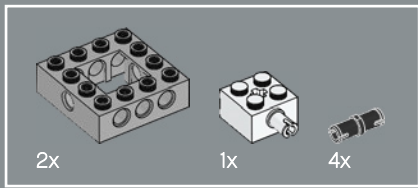

49 1

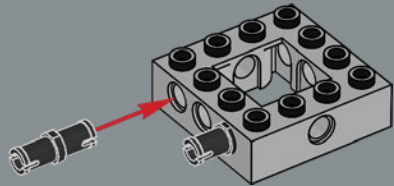

2

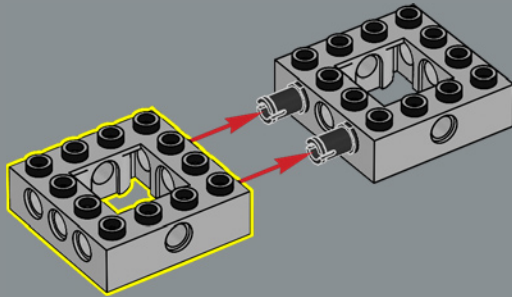

3

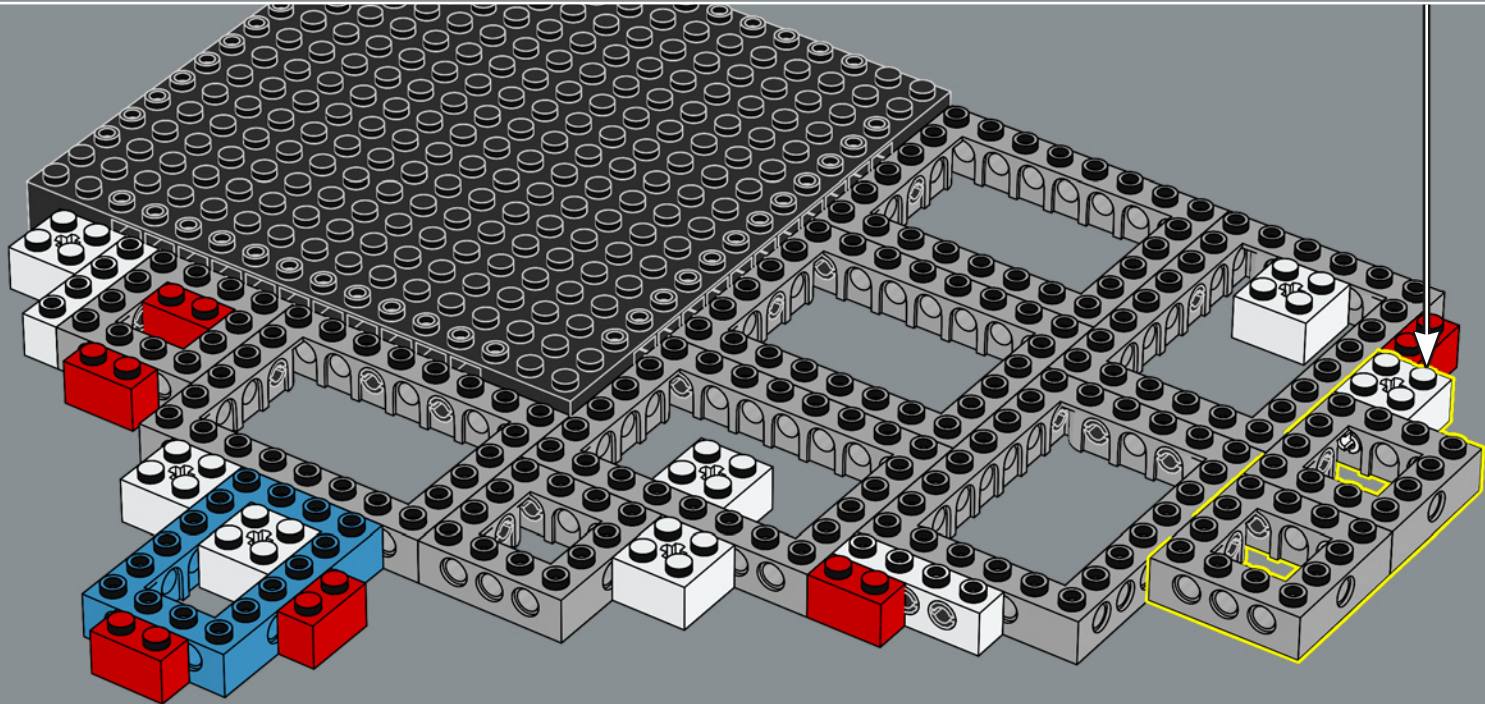
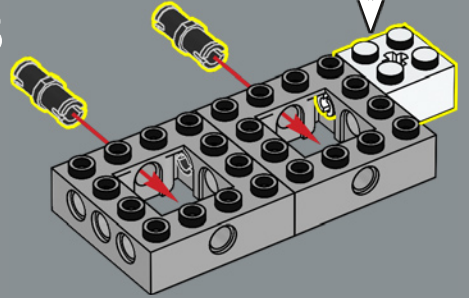

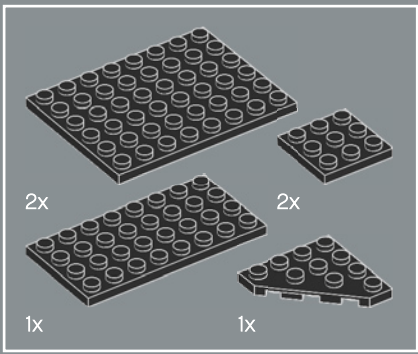

50

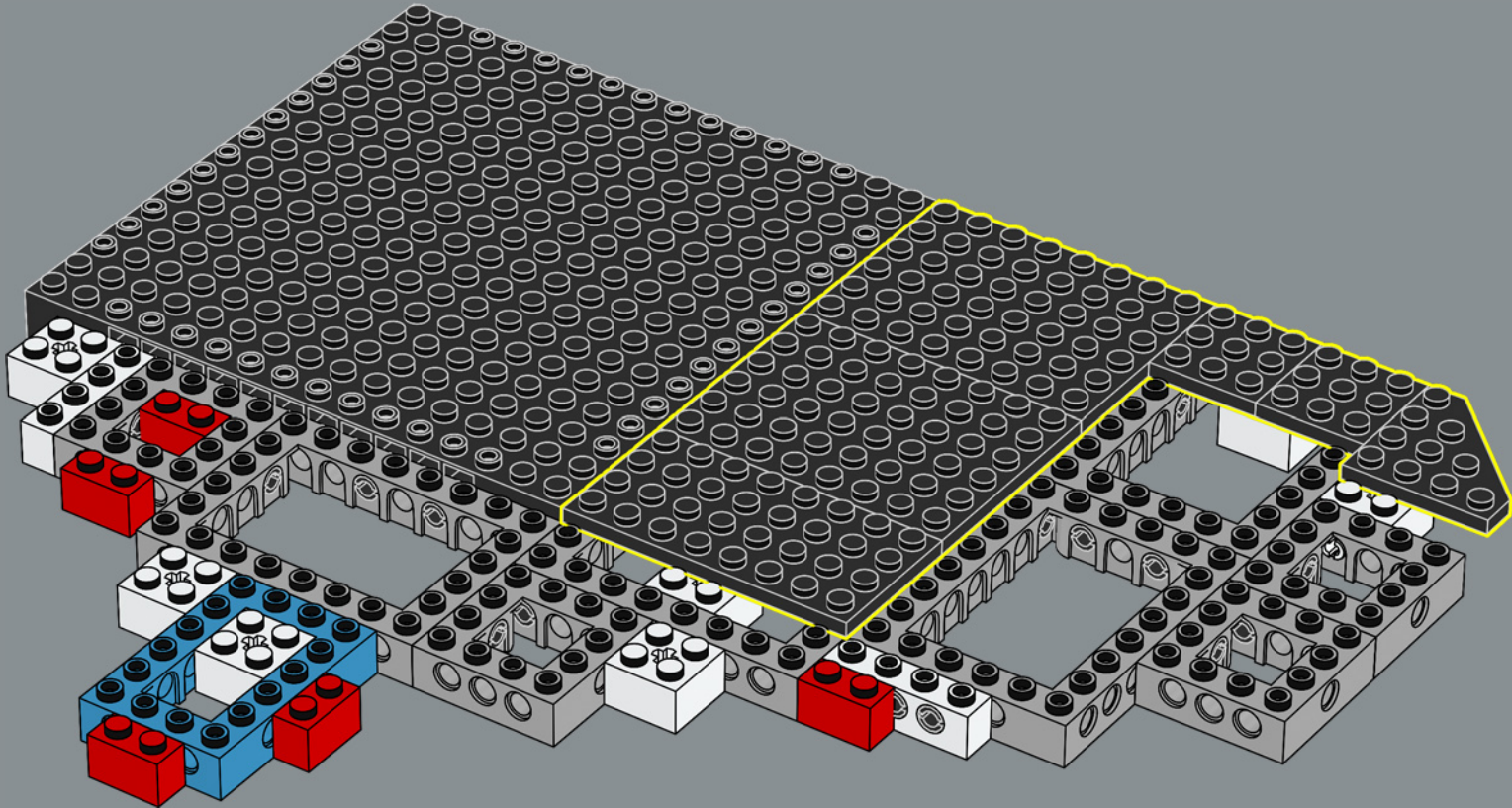

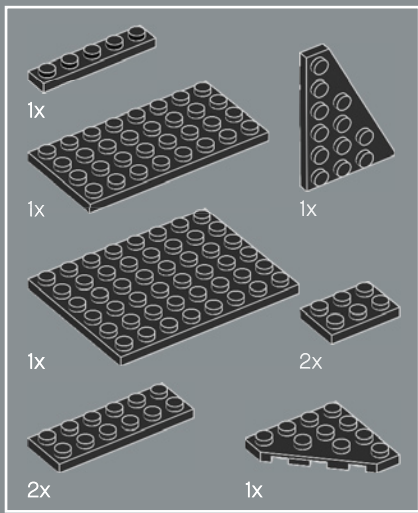

51

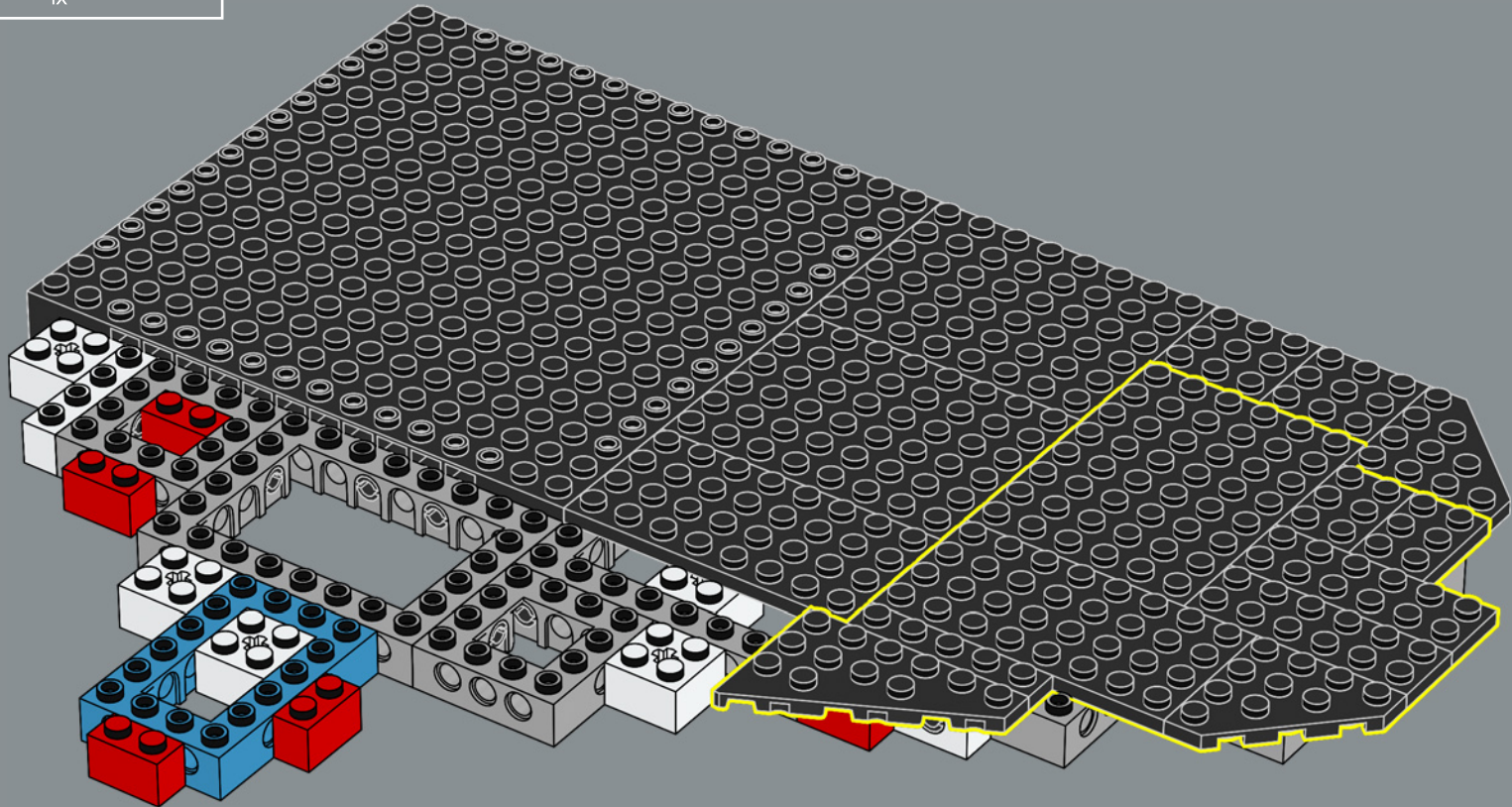

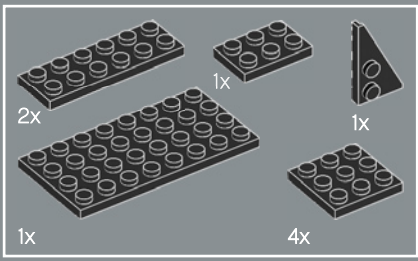

52

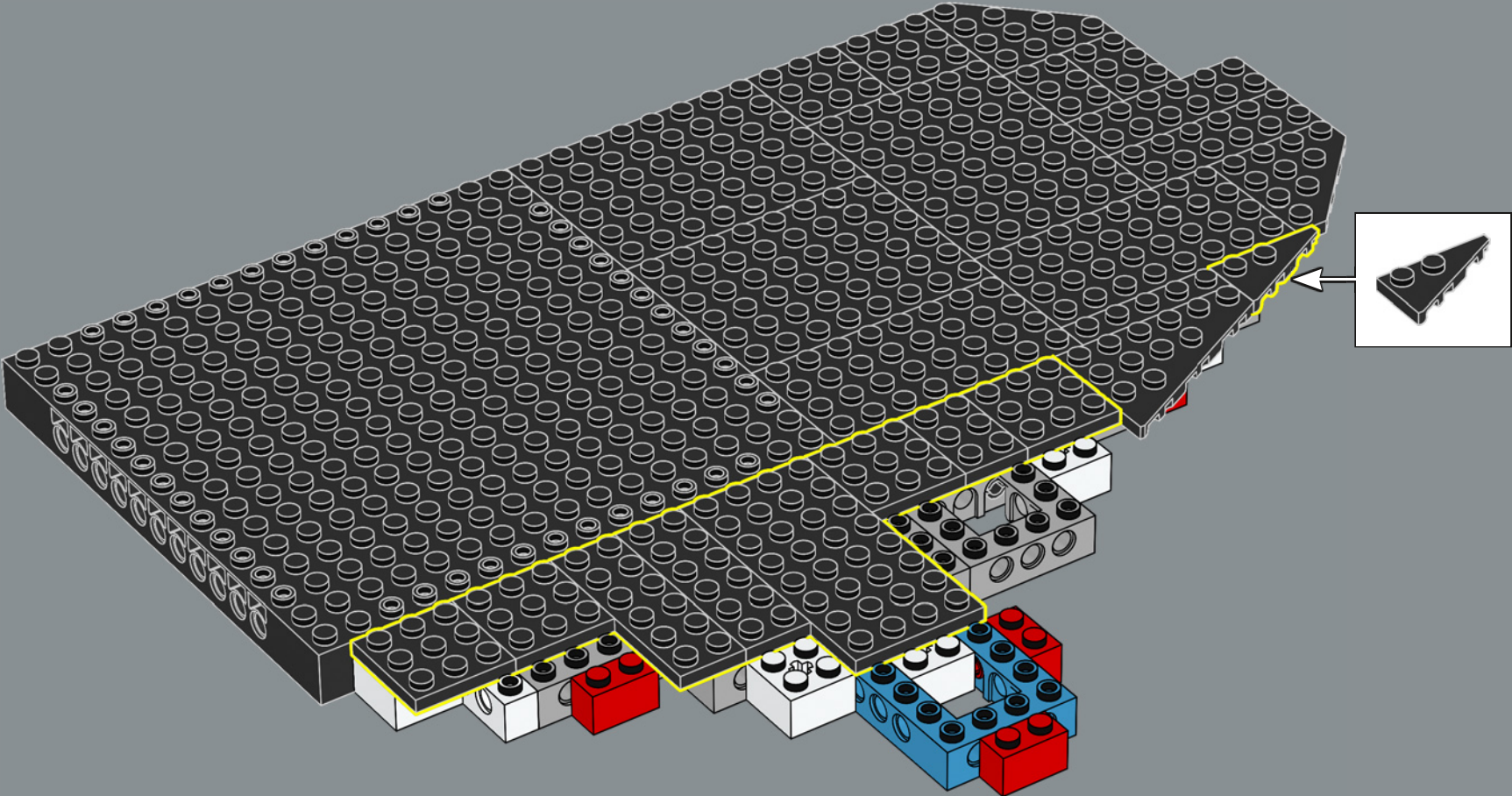



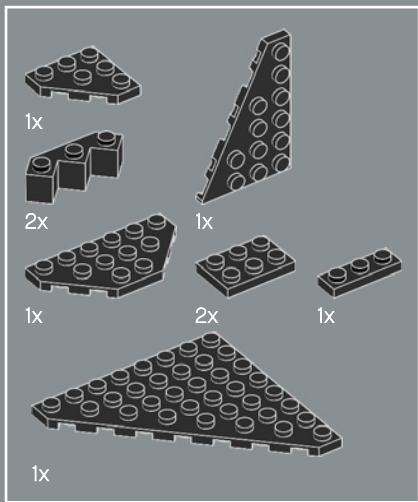

53

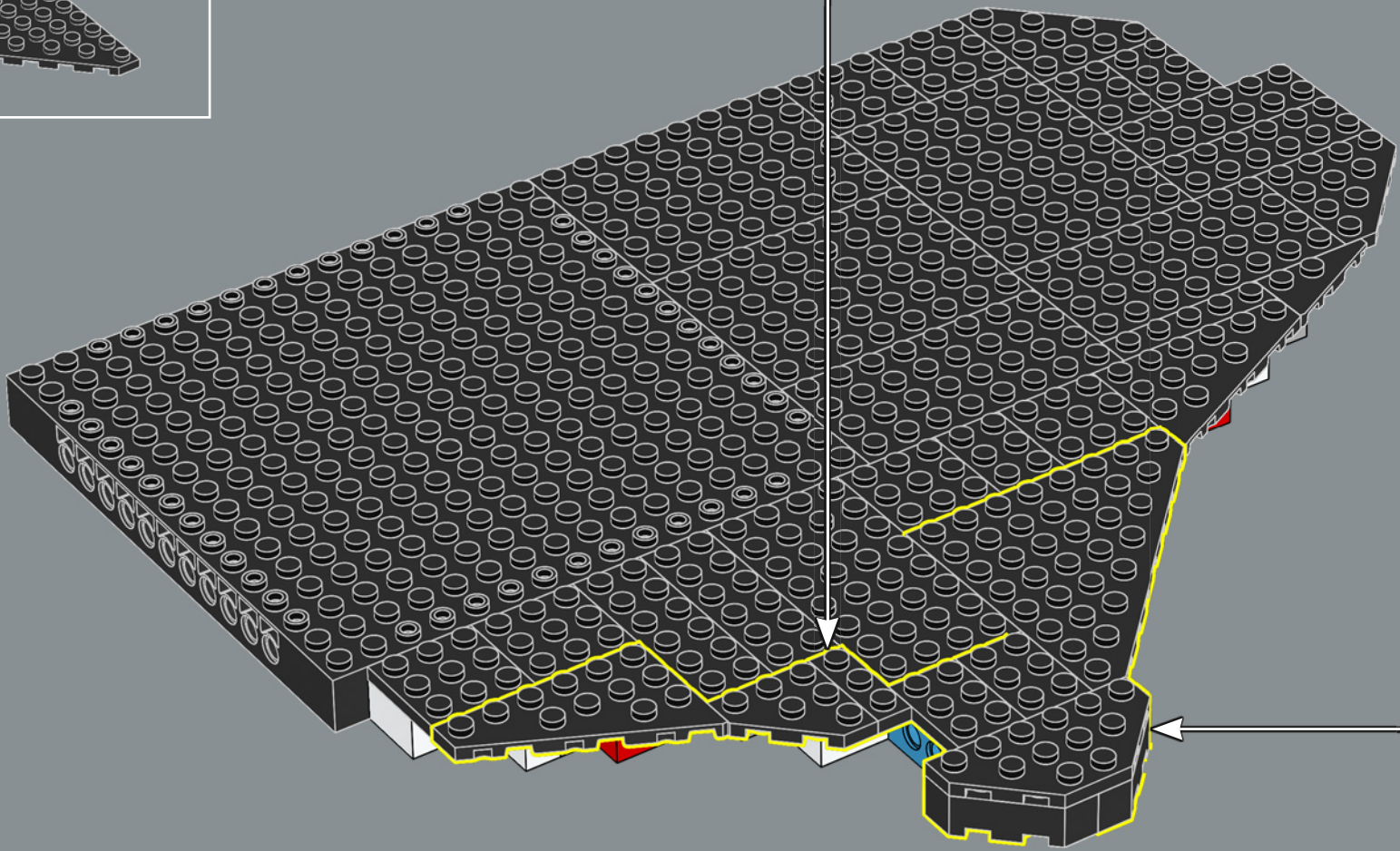
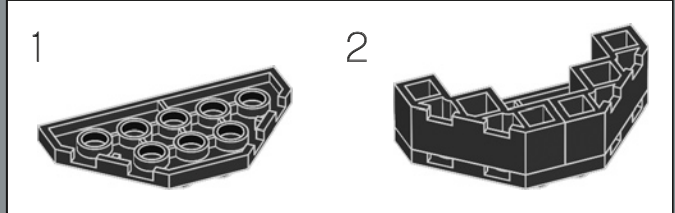
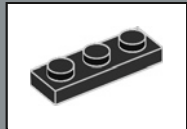

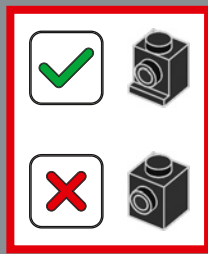
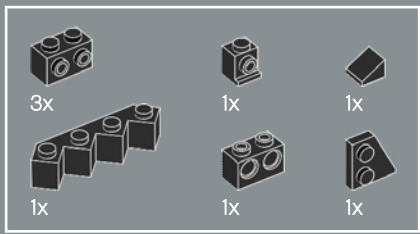

54

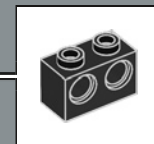
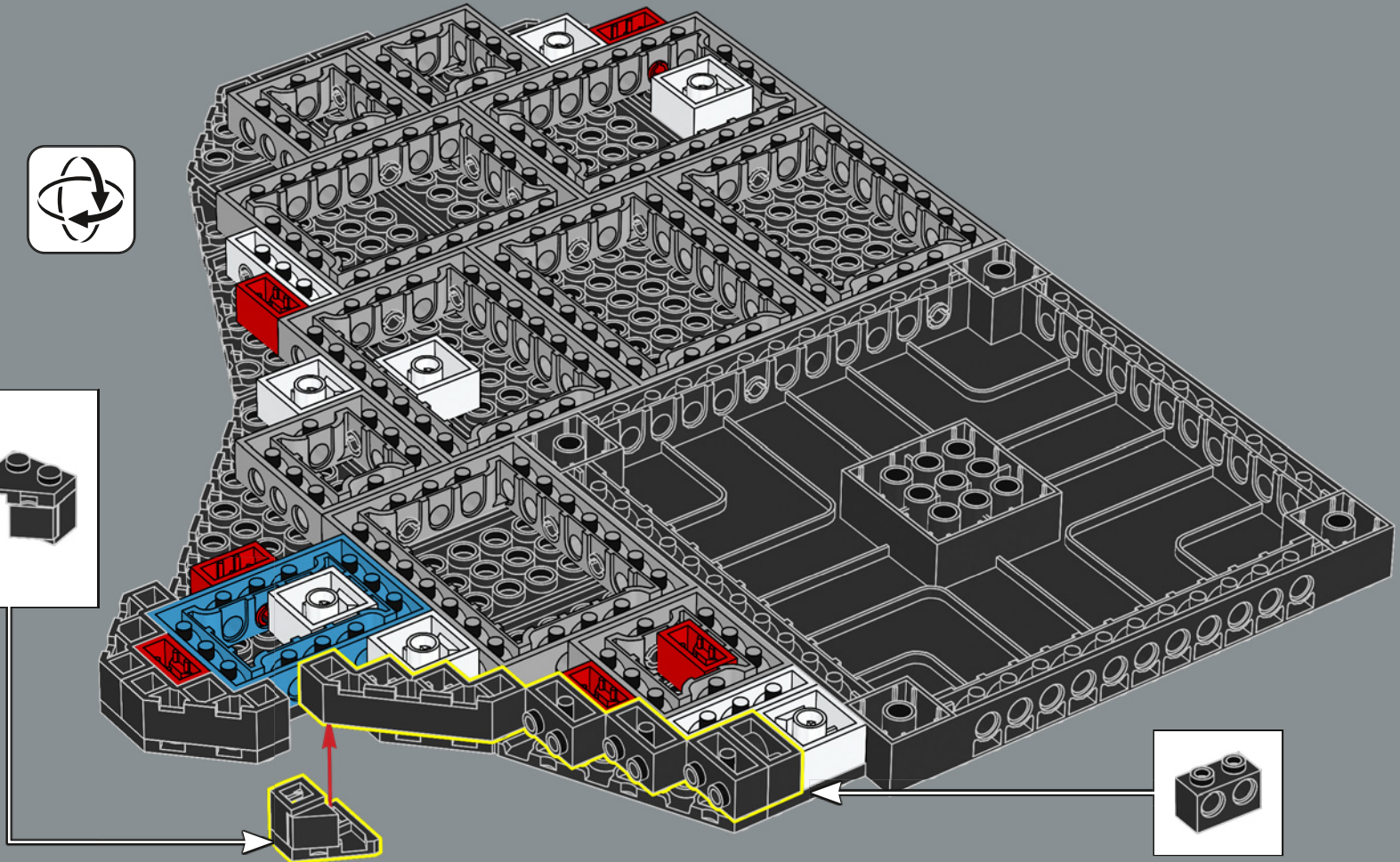
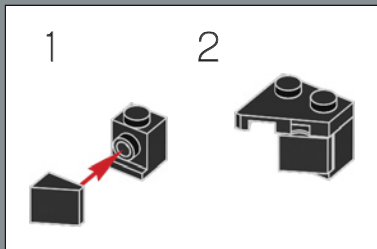

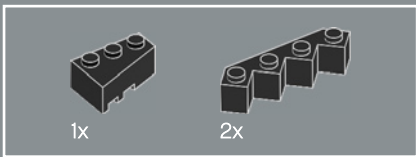

55

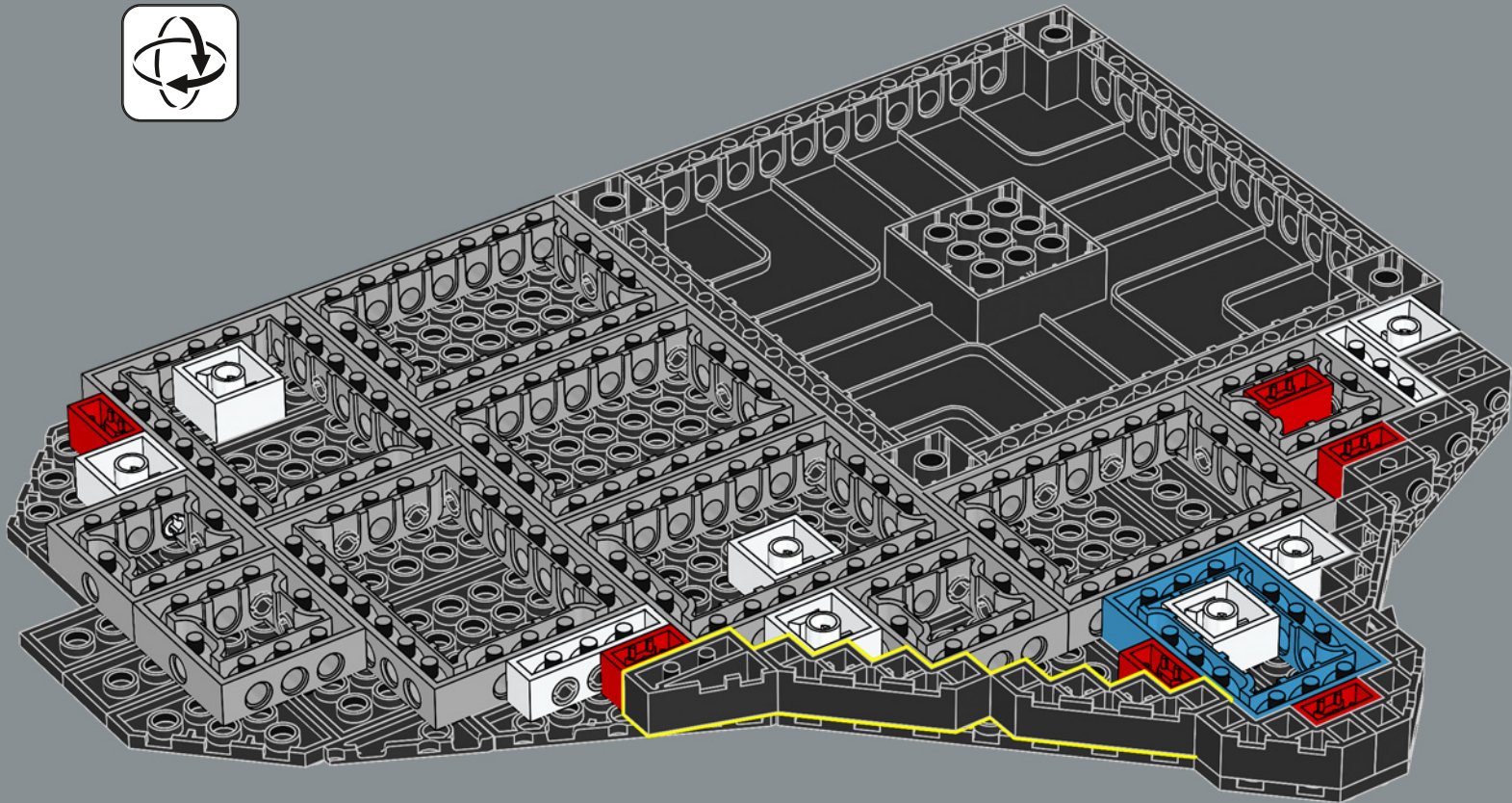

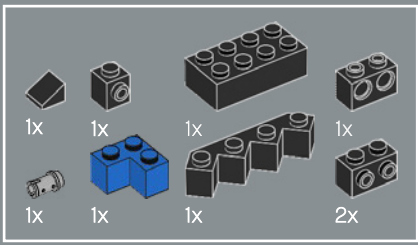

56

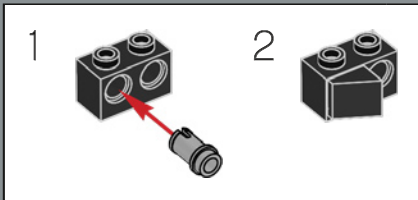
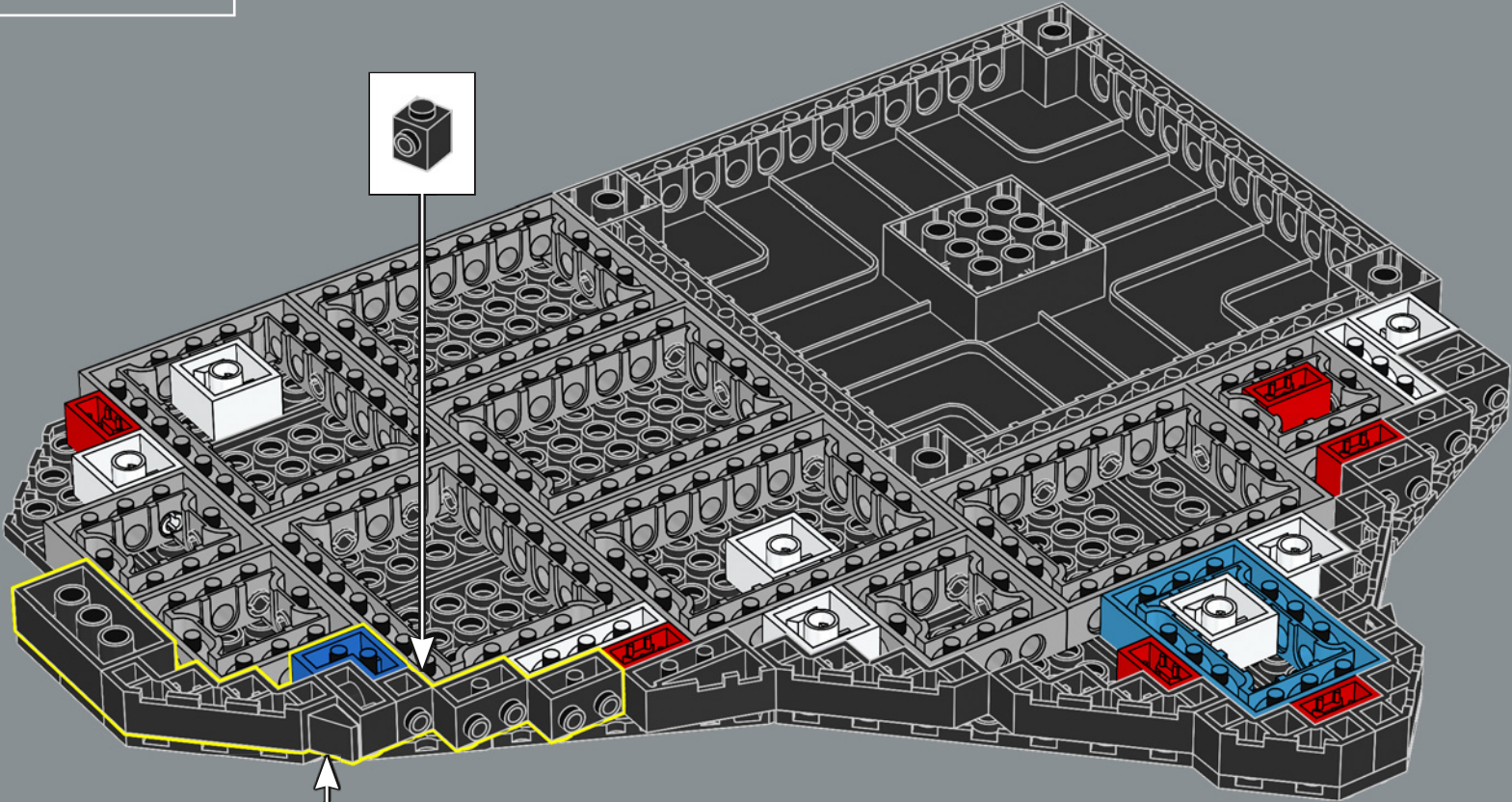



57

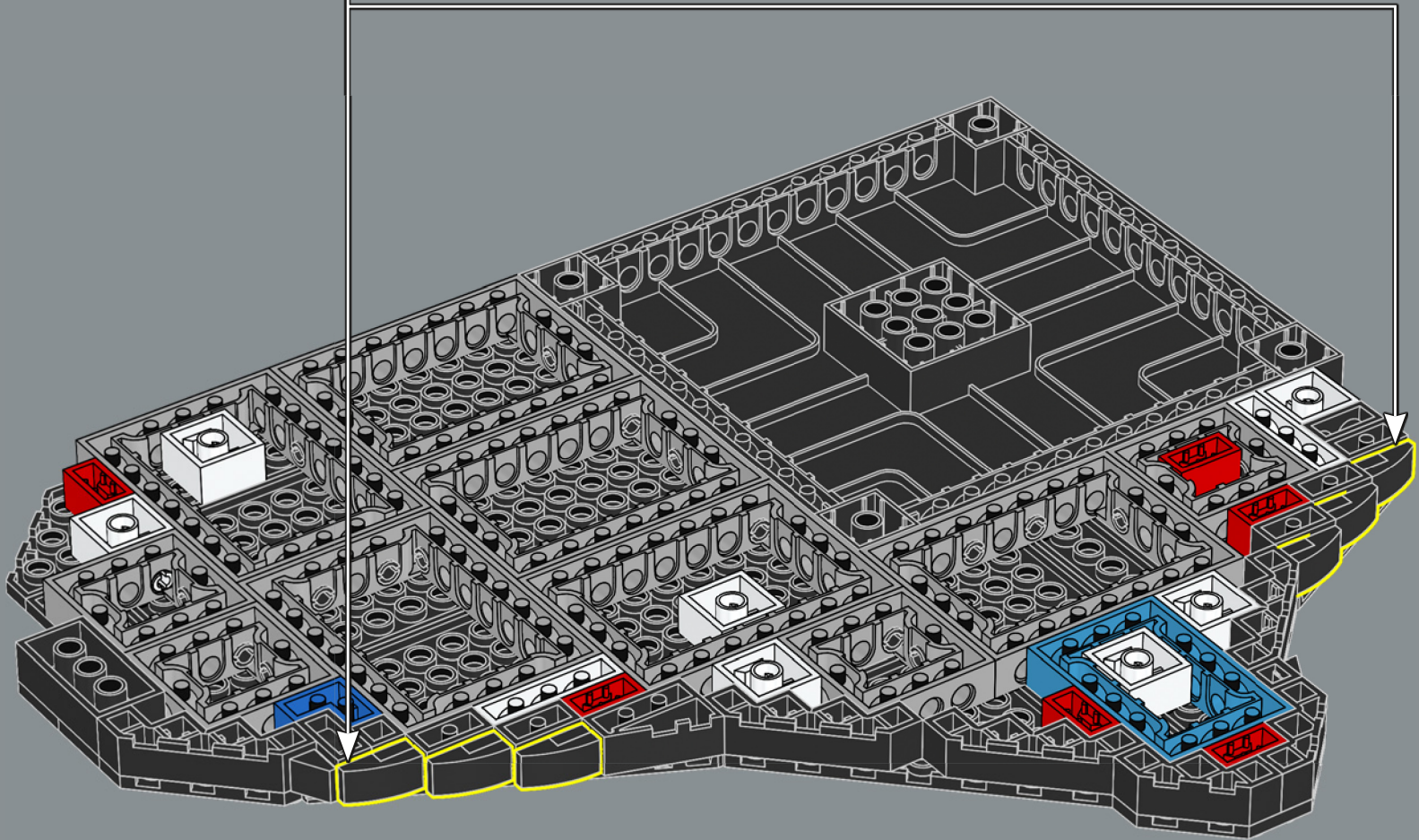
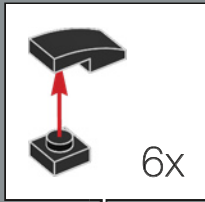

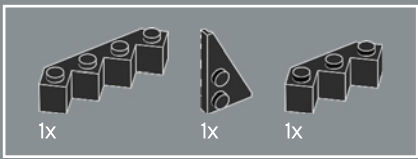

58

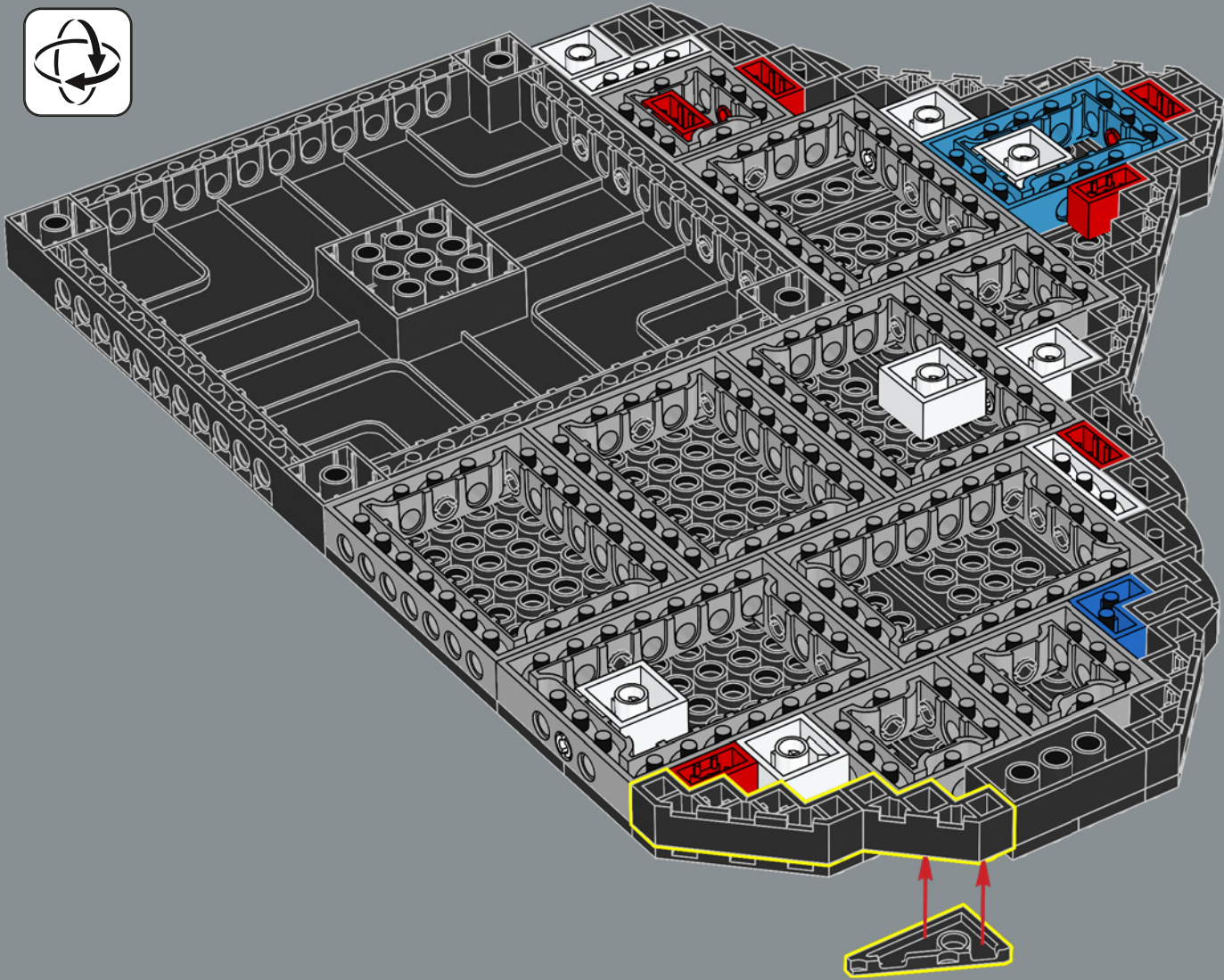

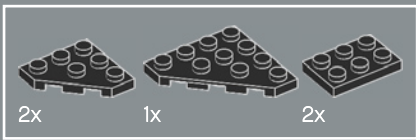

59

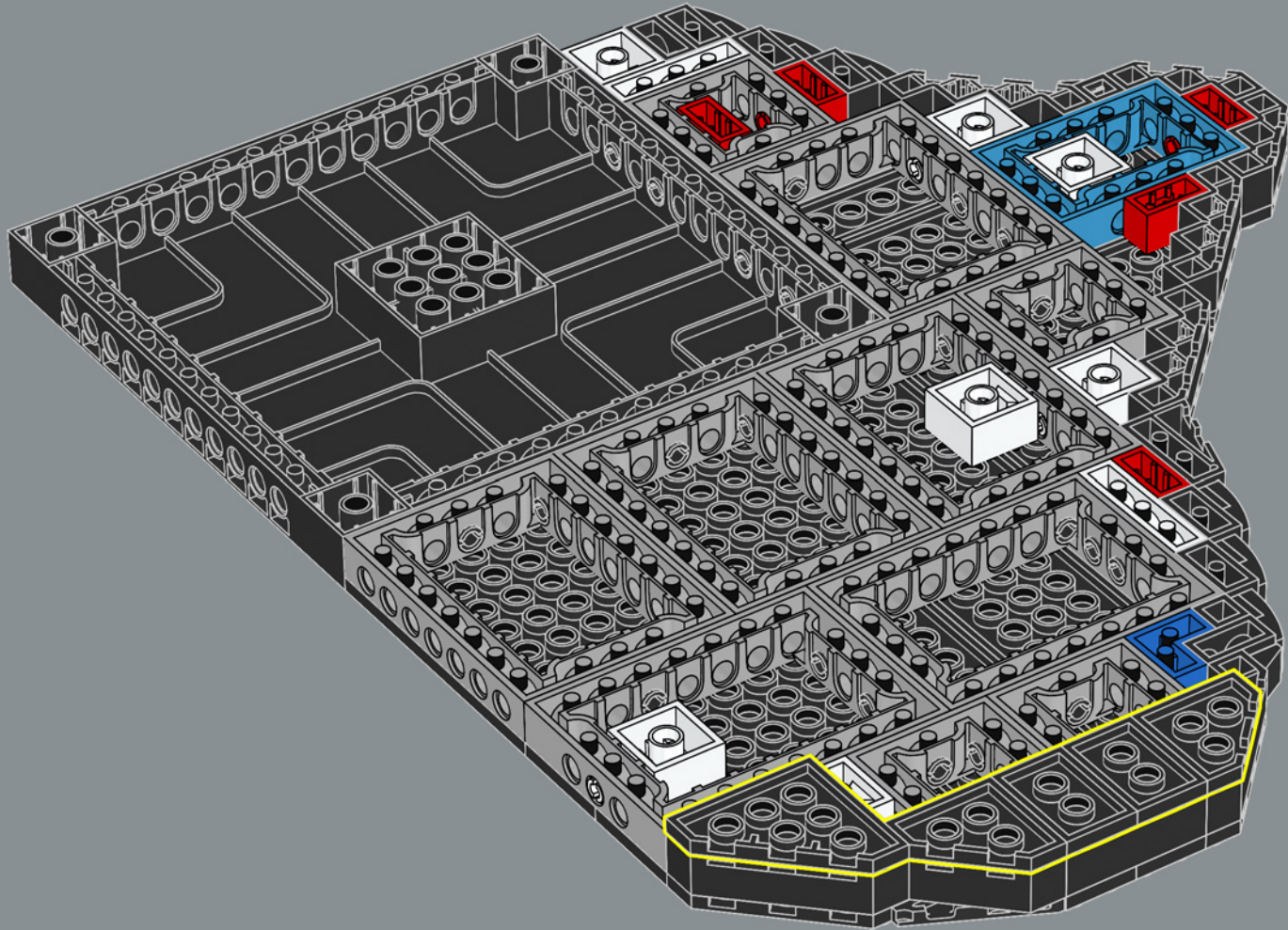

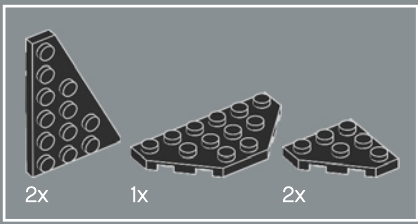

60

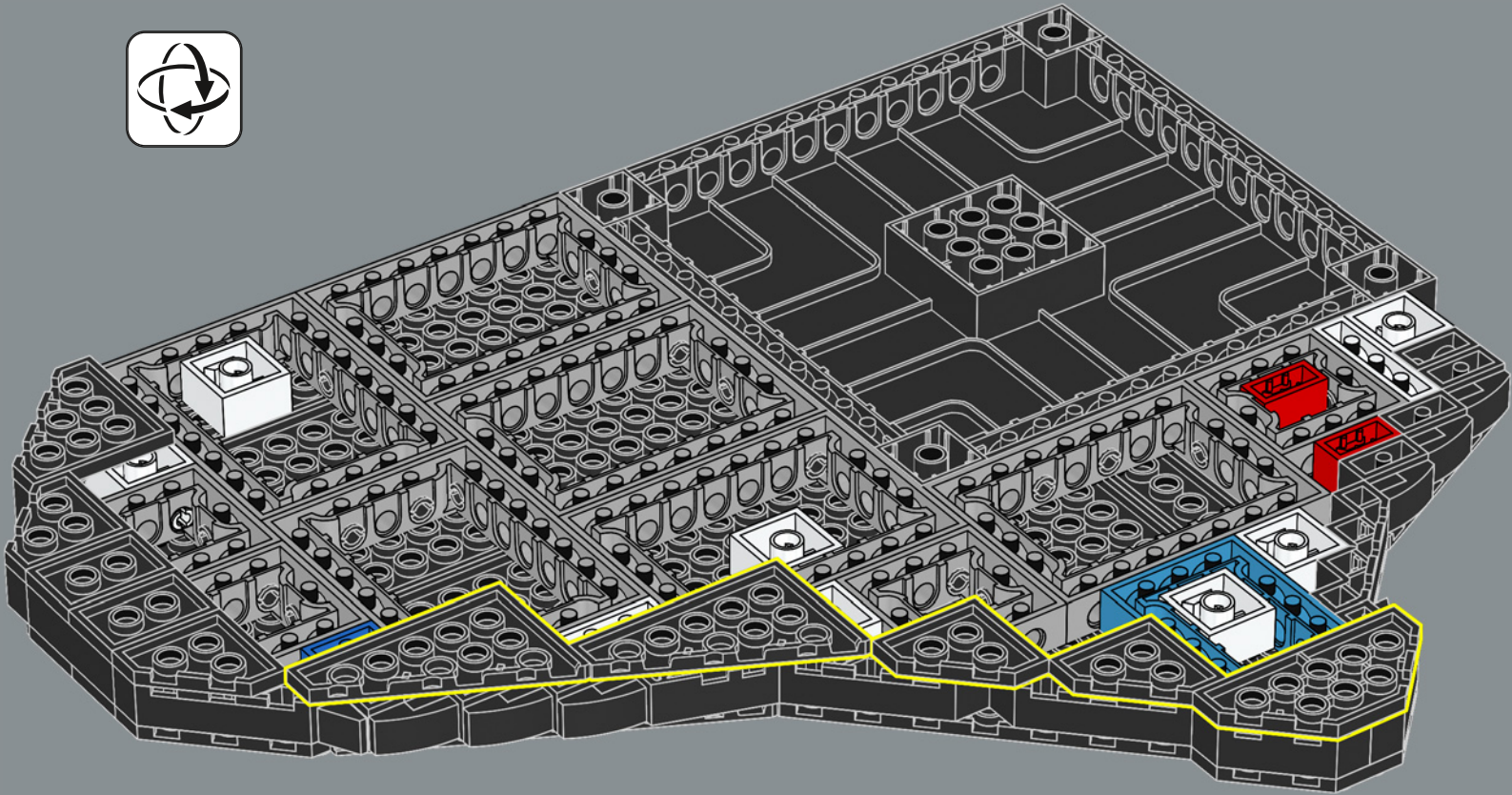



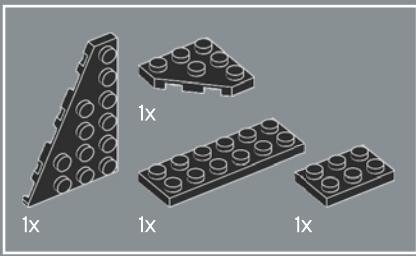

61

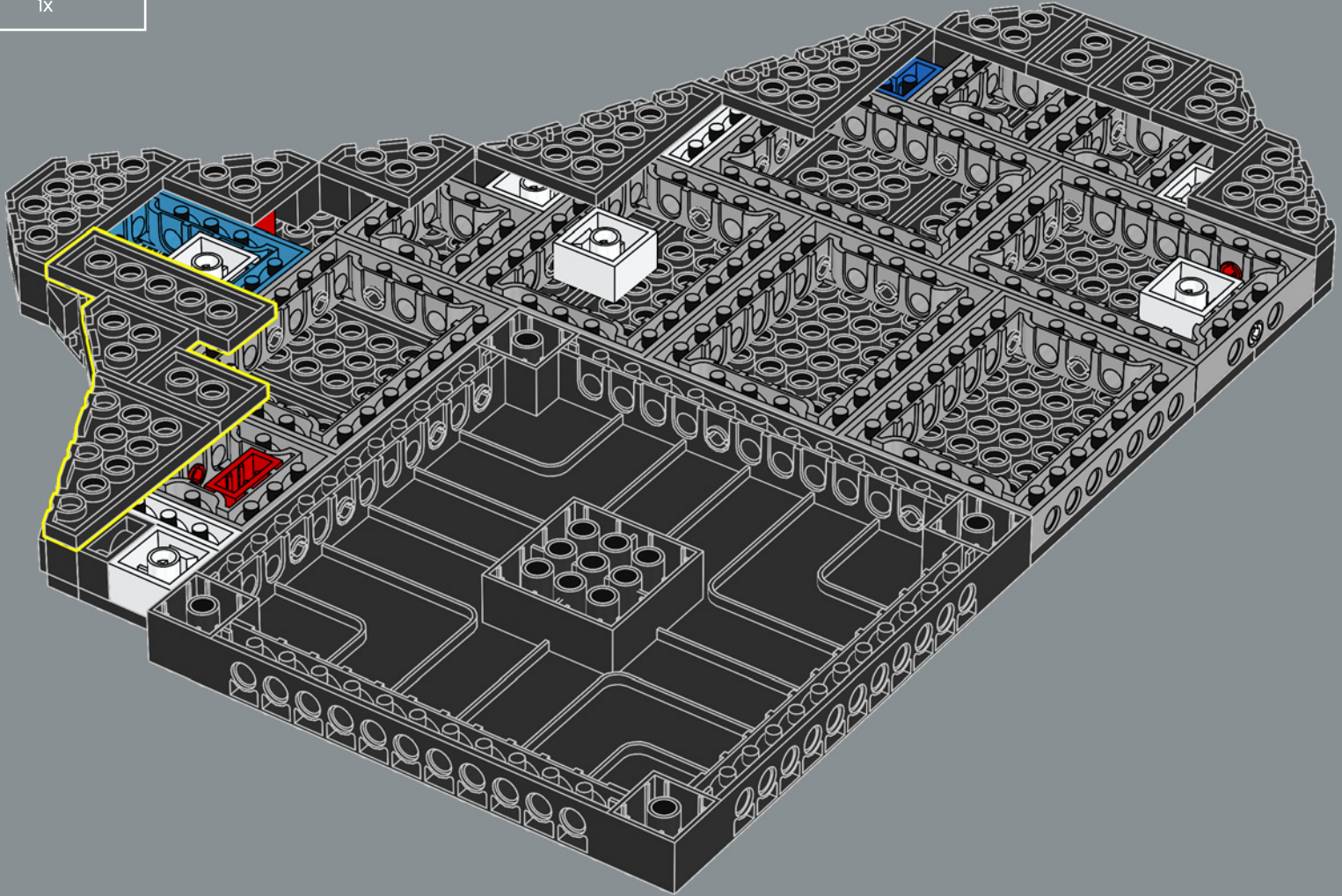

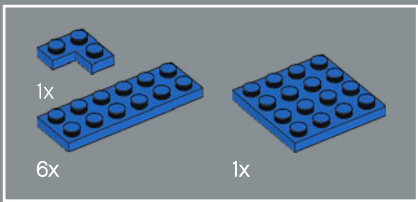

62

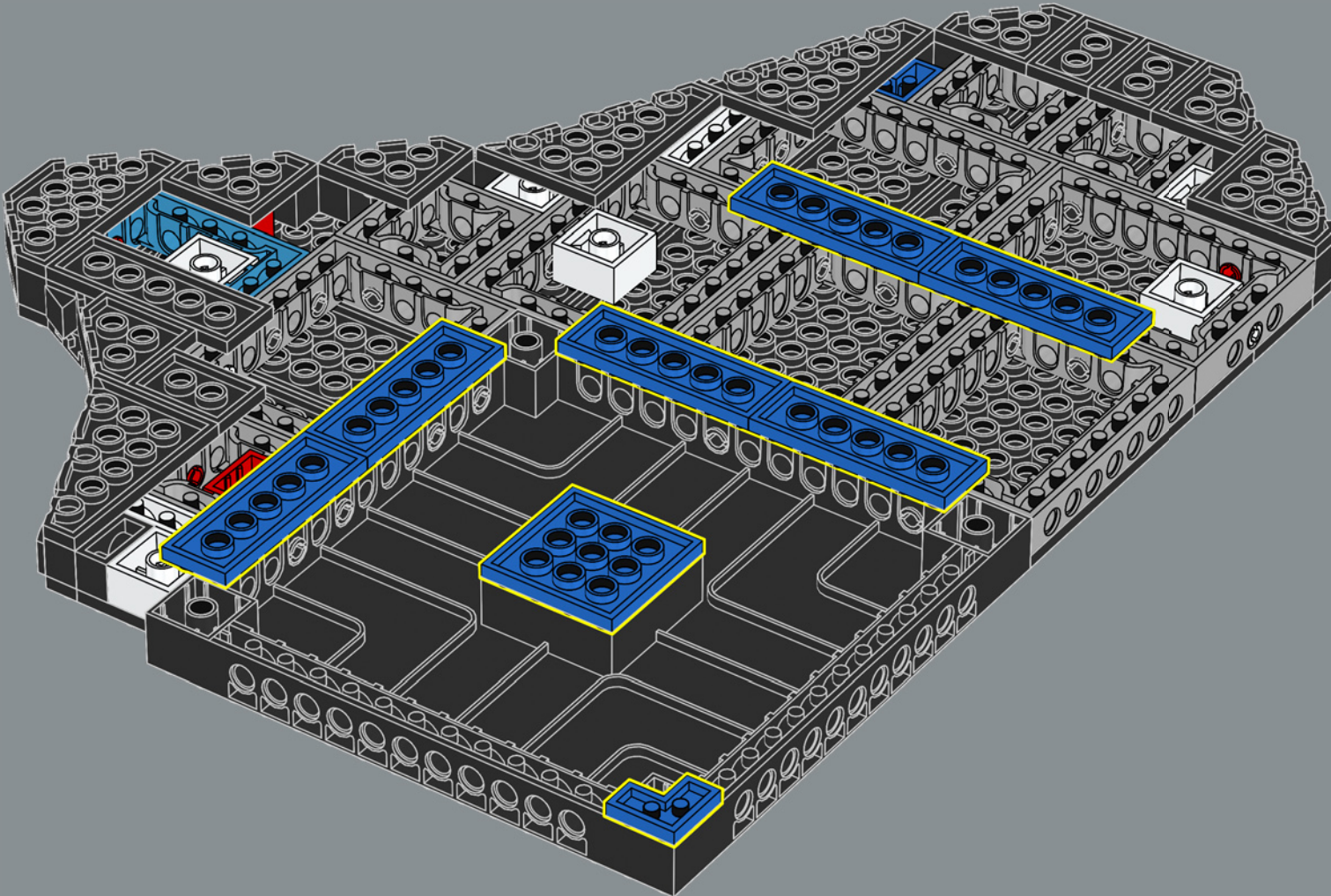





4x

63

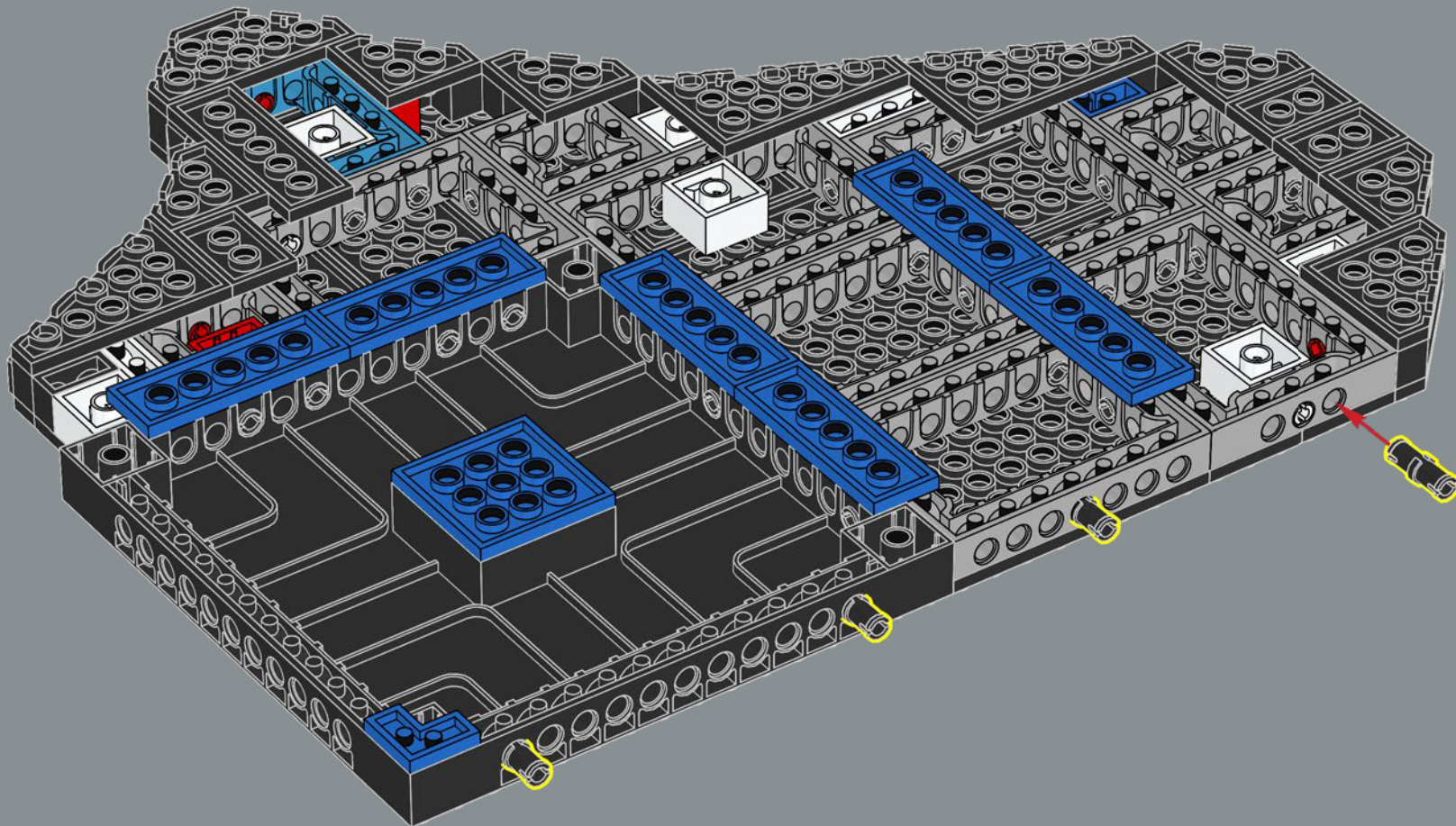

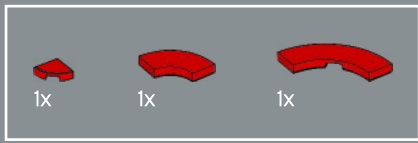

64

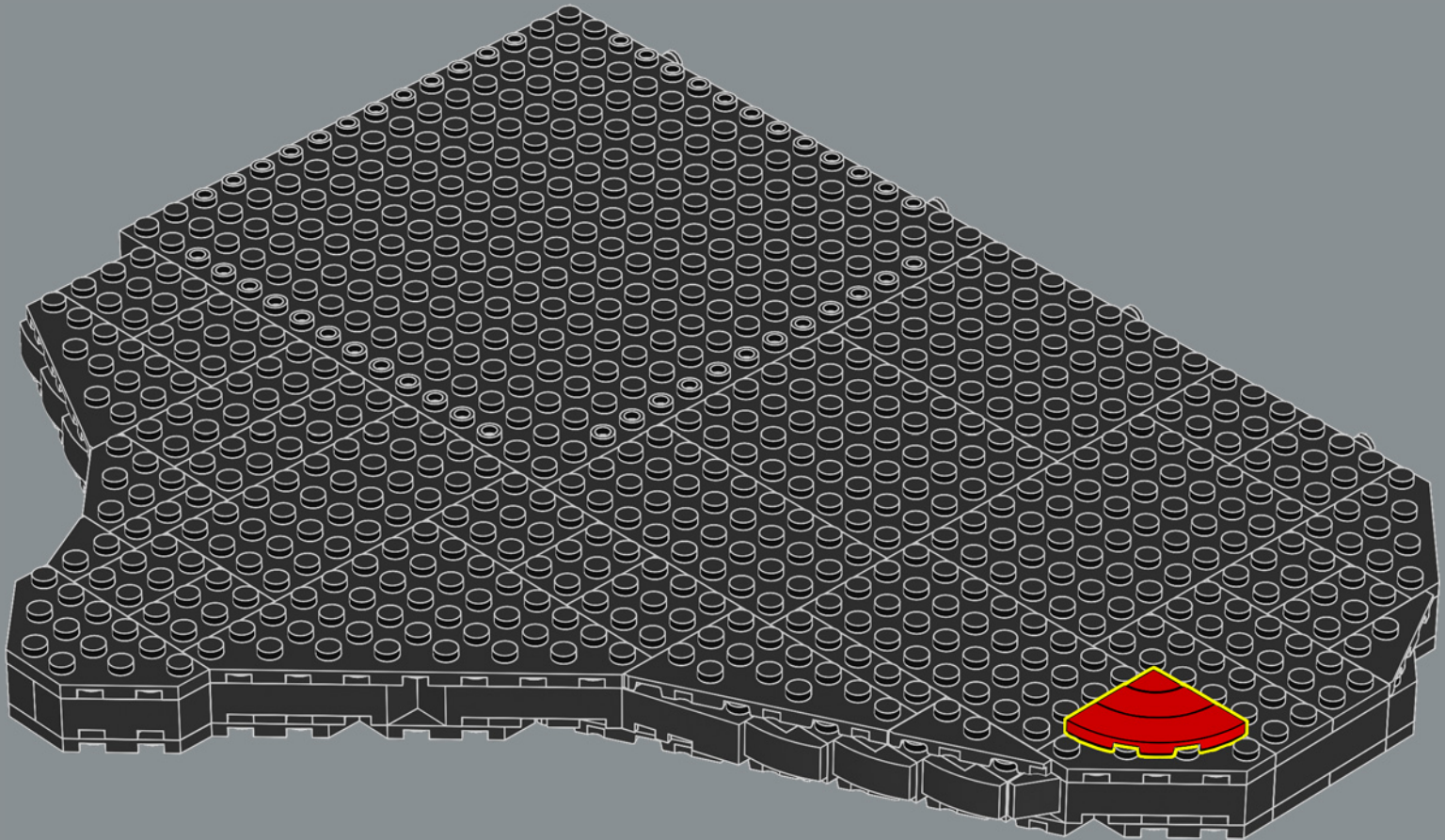



5x

65

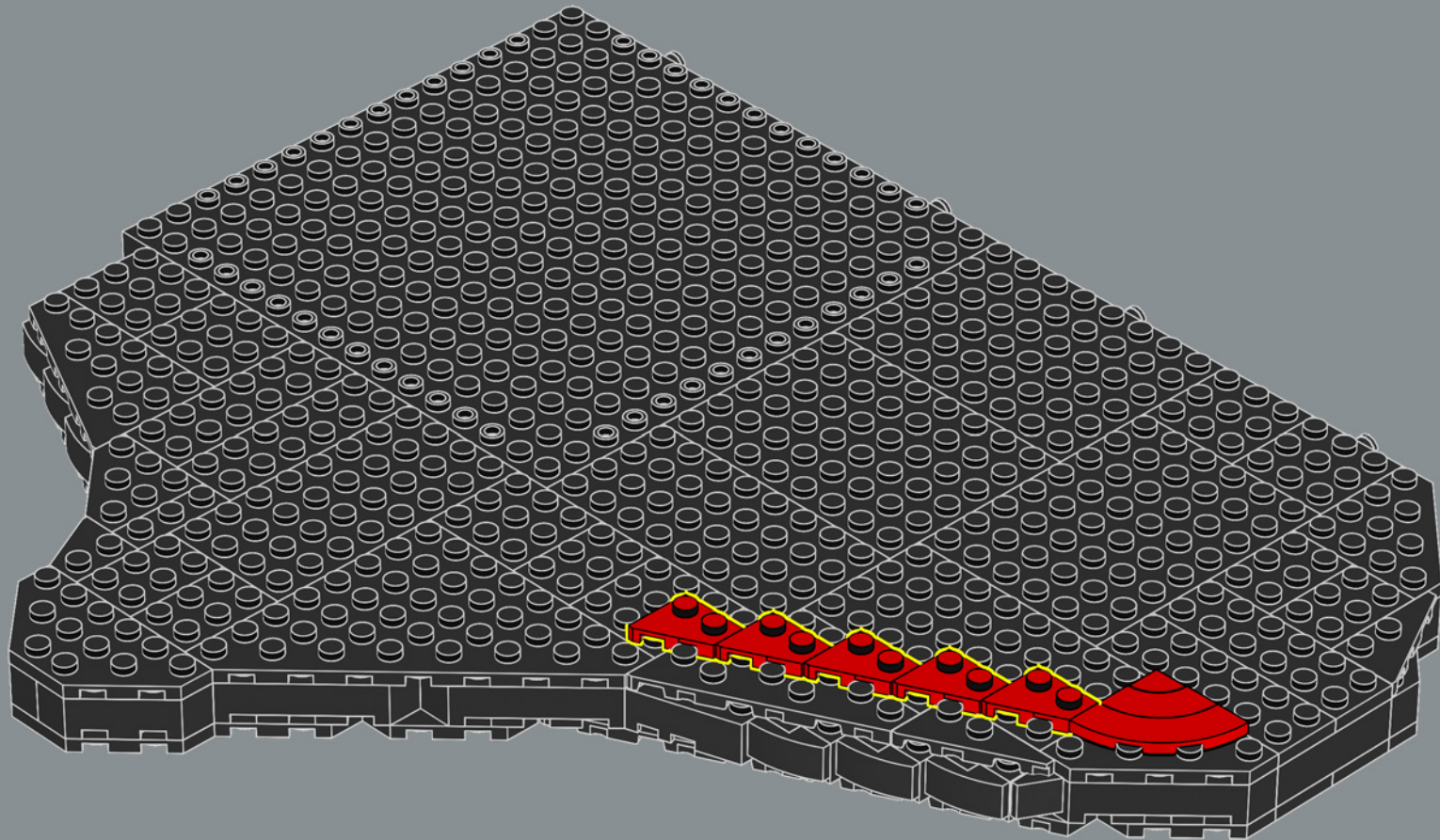

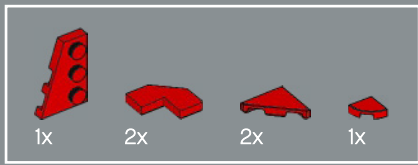

66

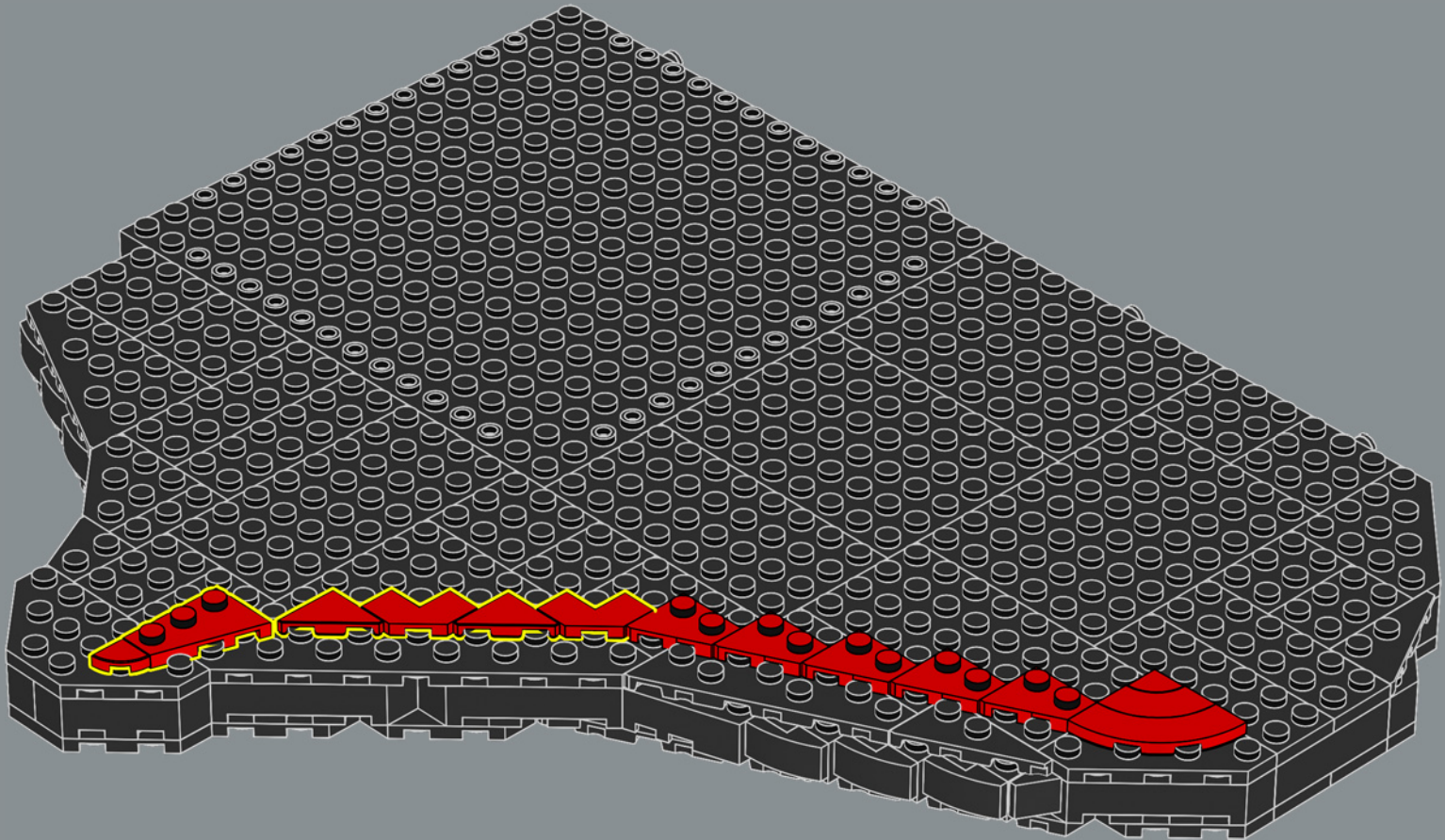

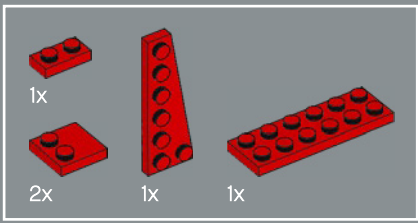

67

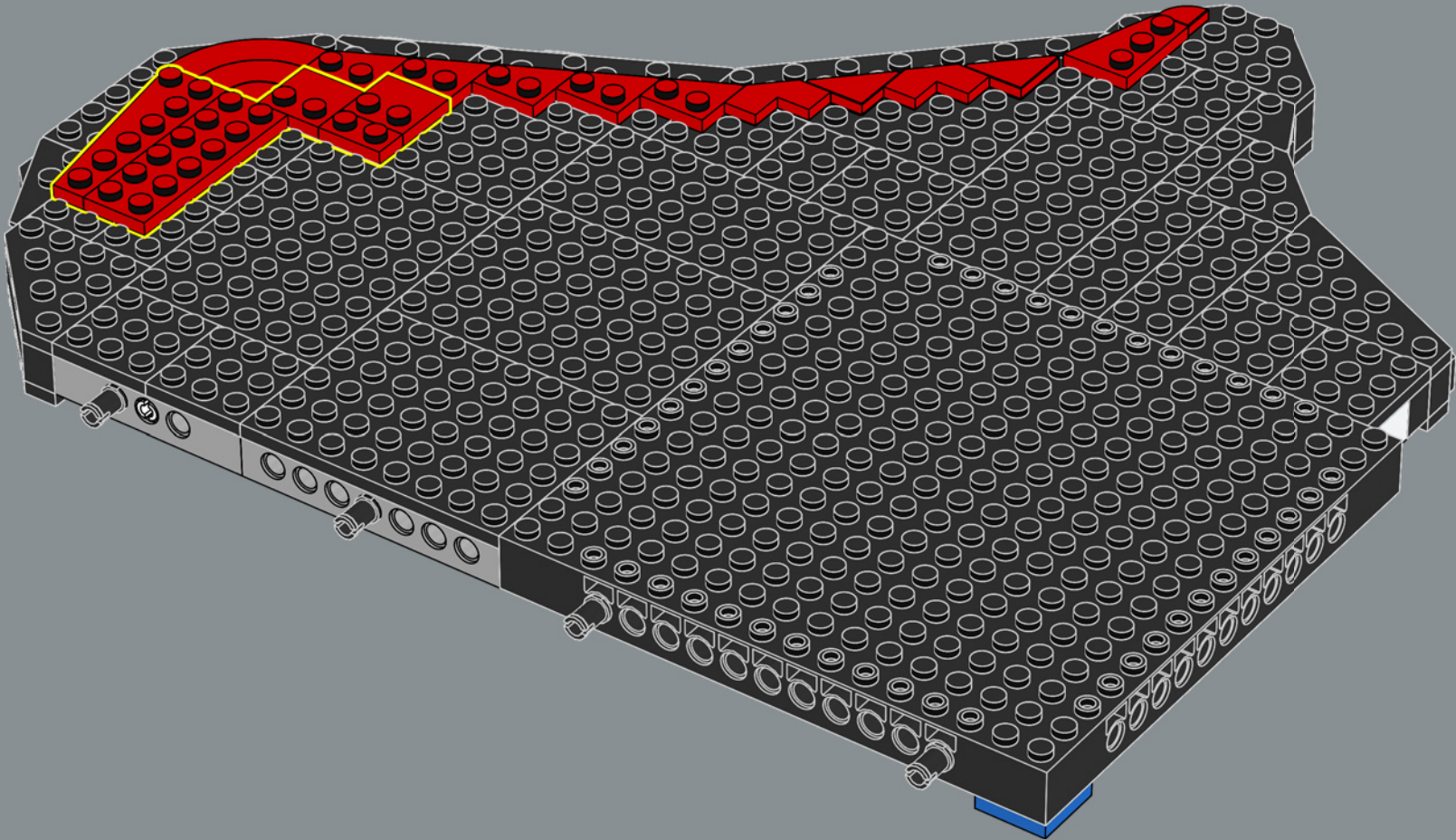



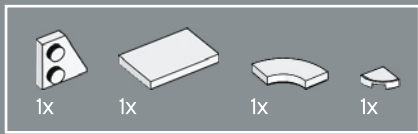

68

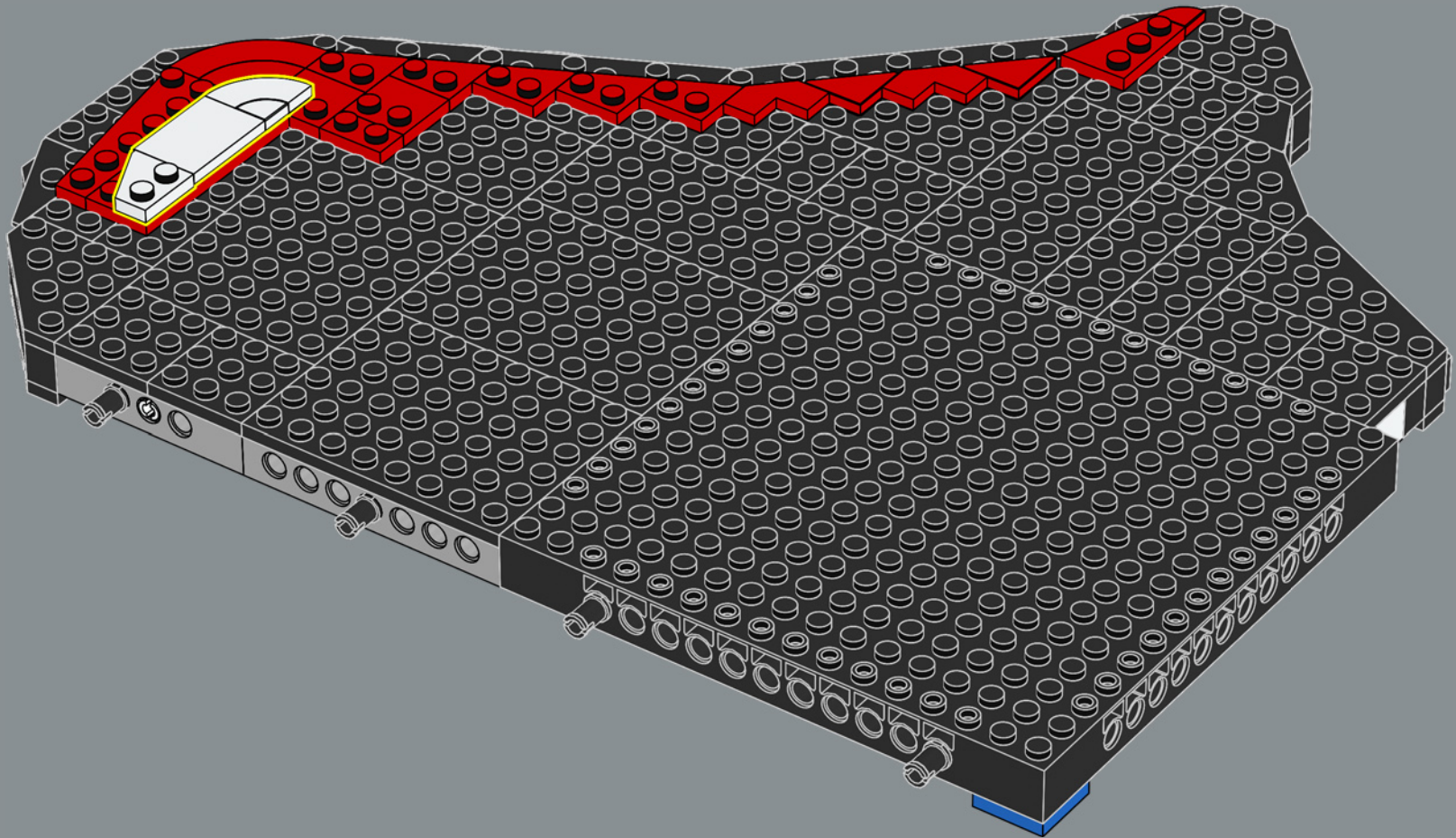

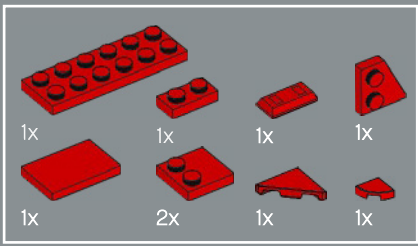

69

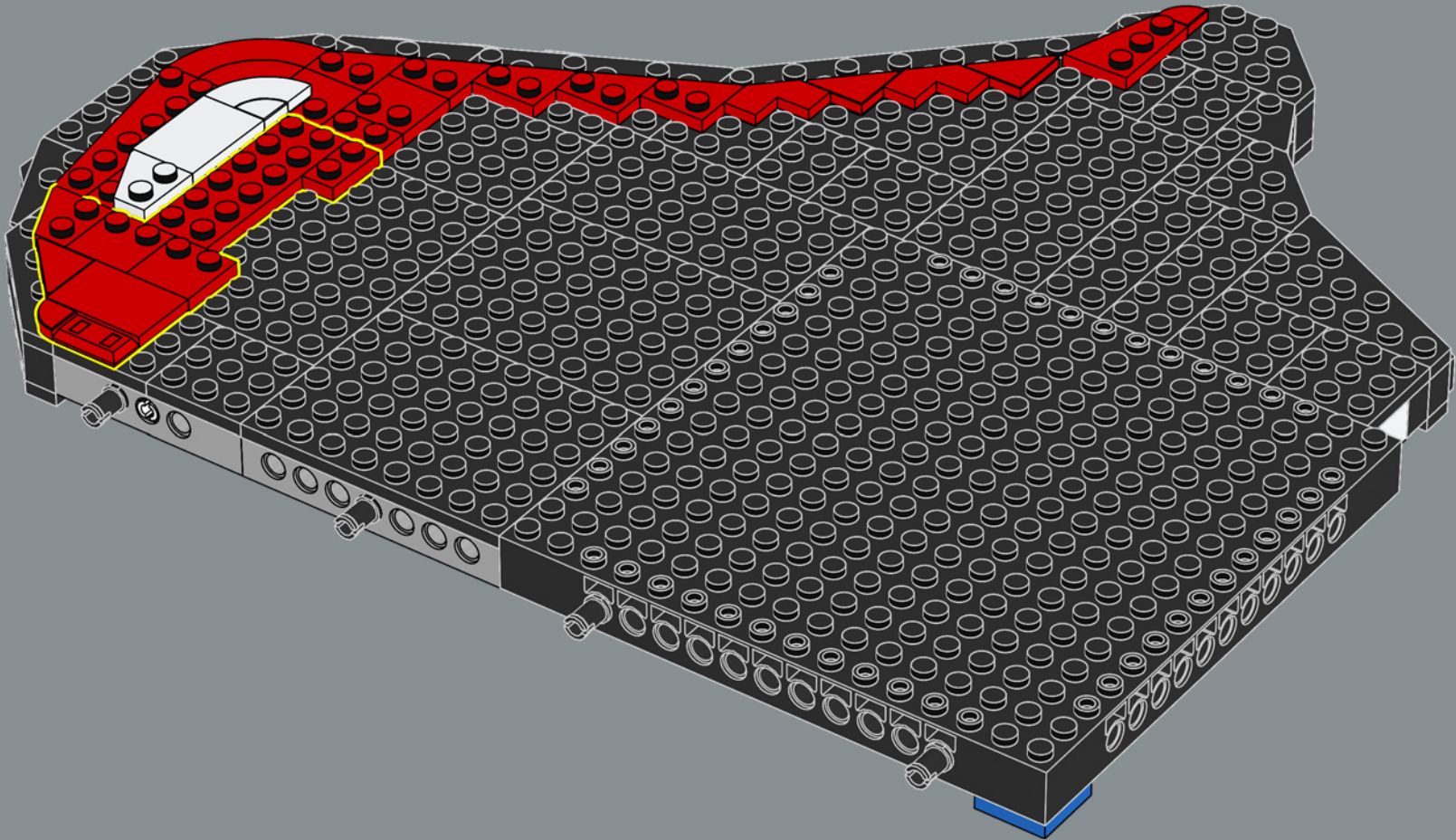

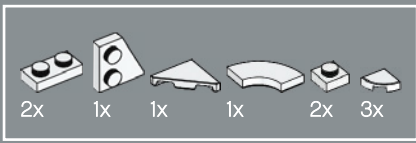

70

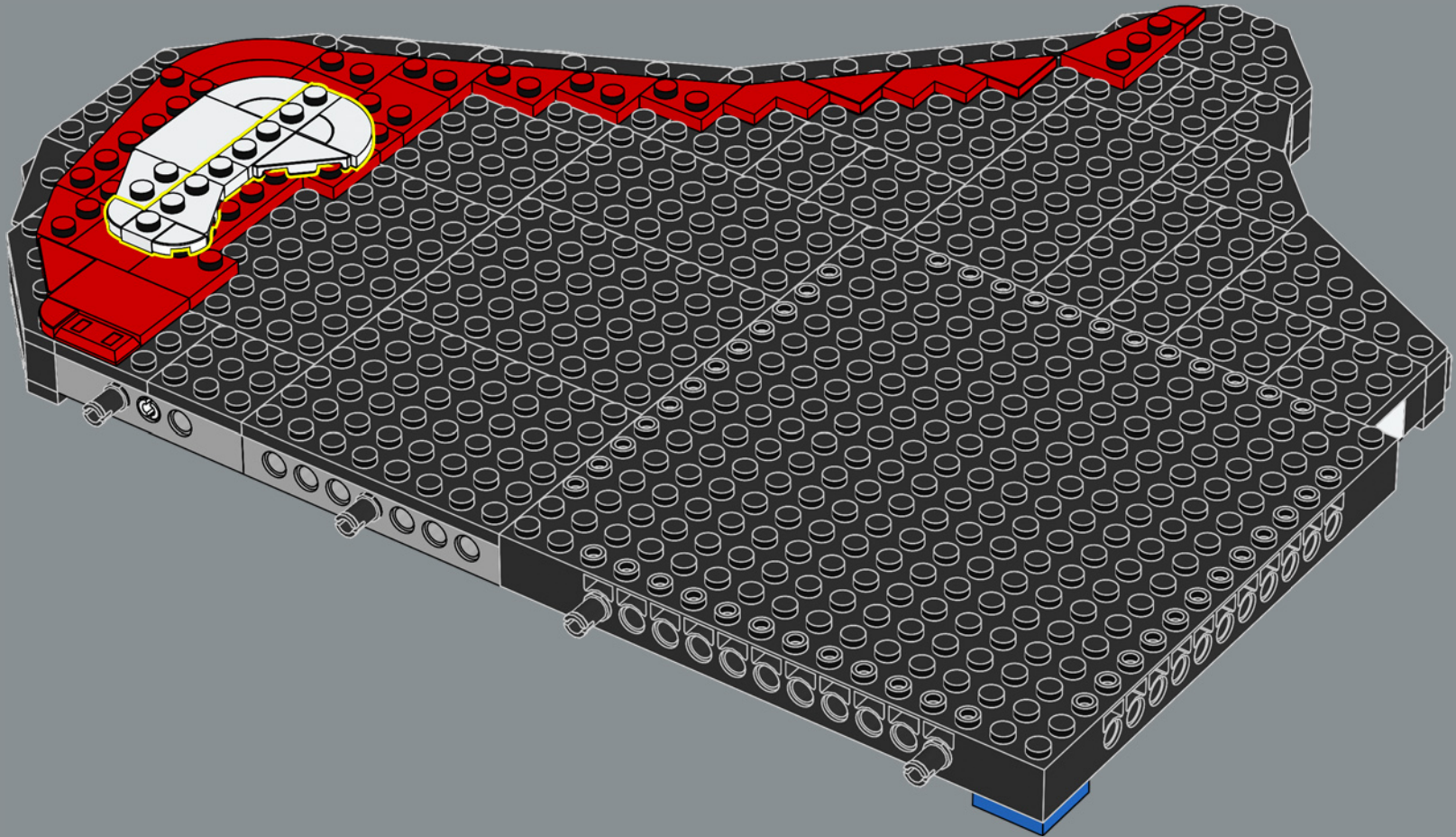

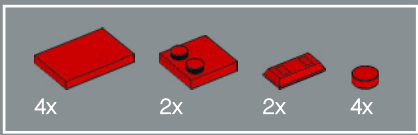

71

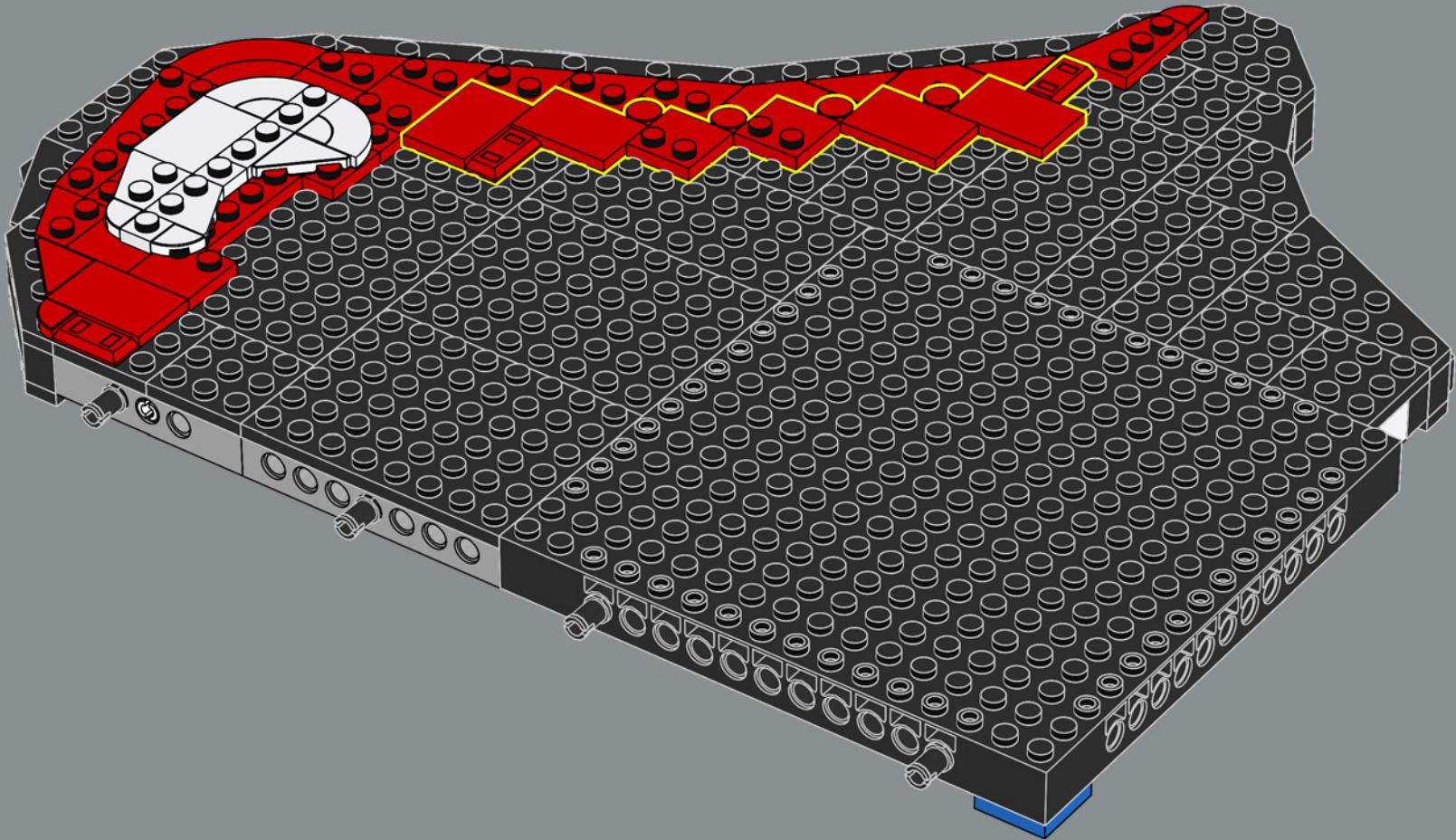

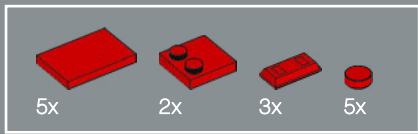

72

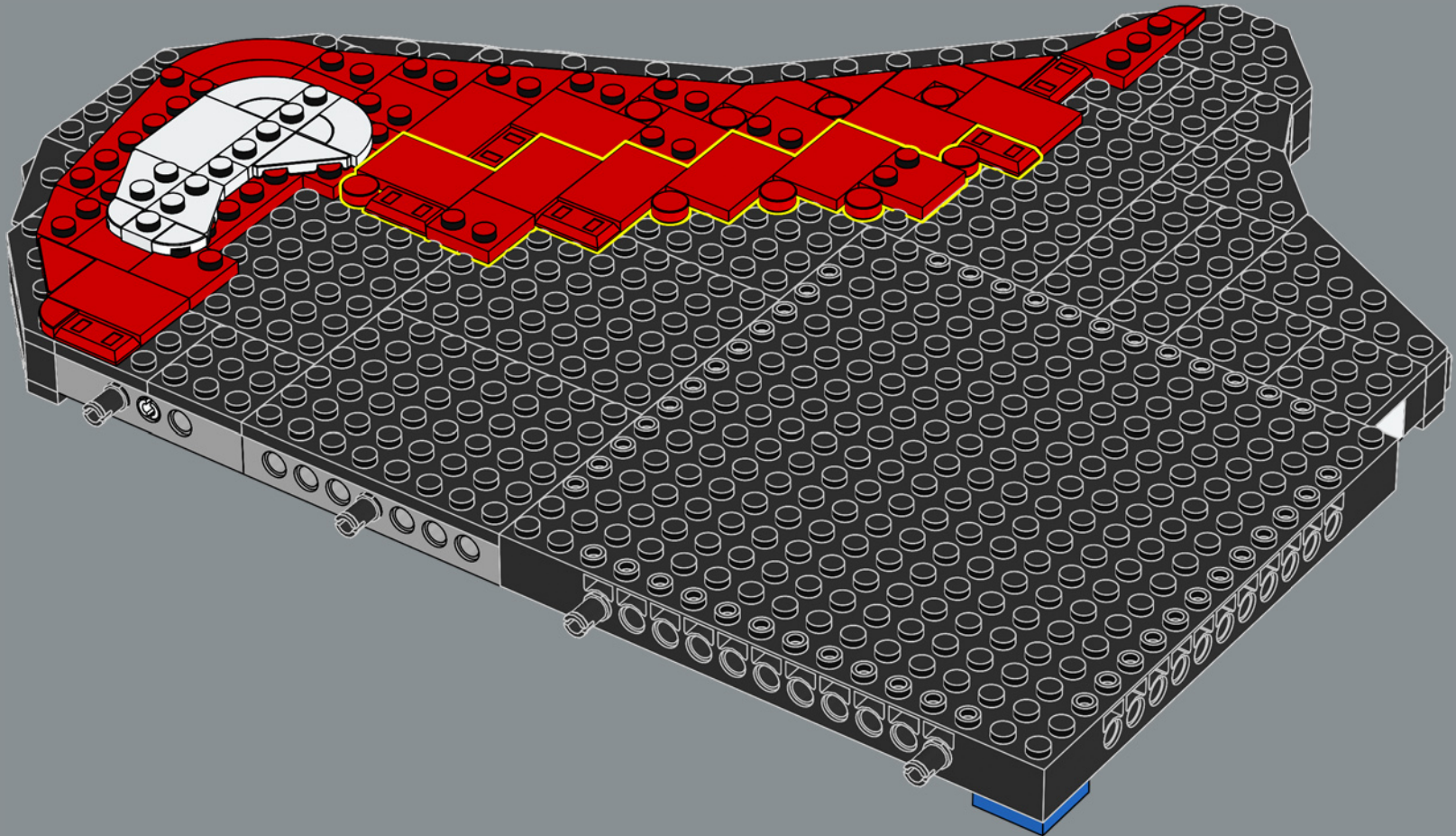

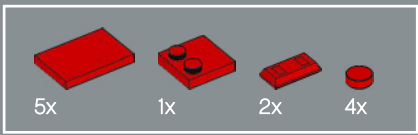

73

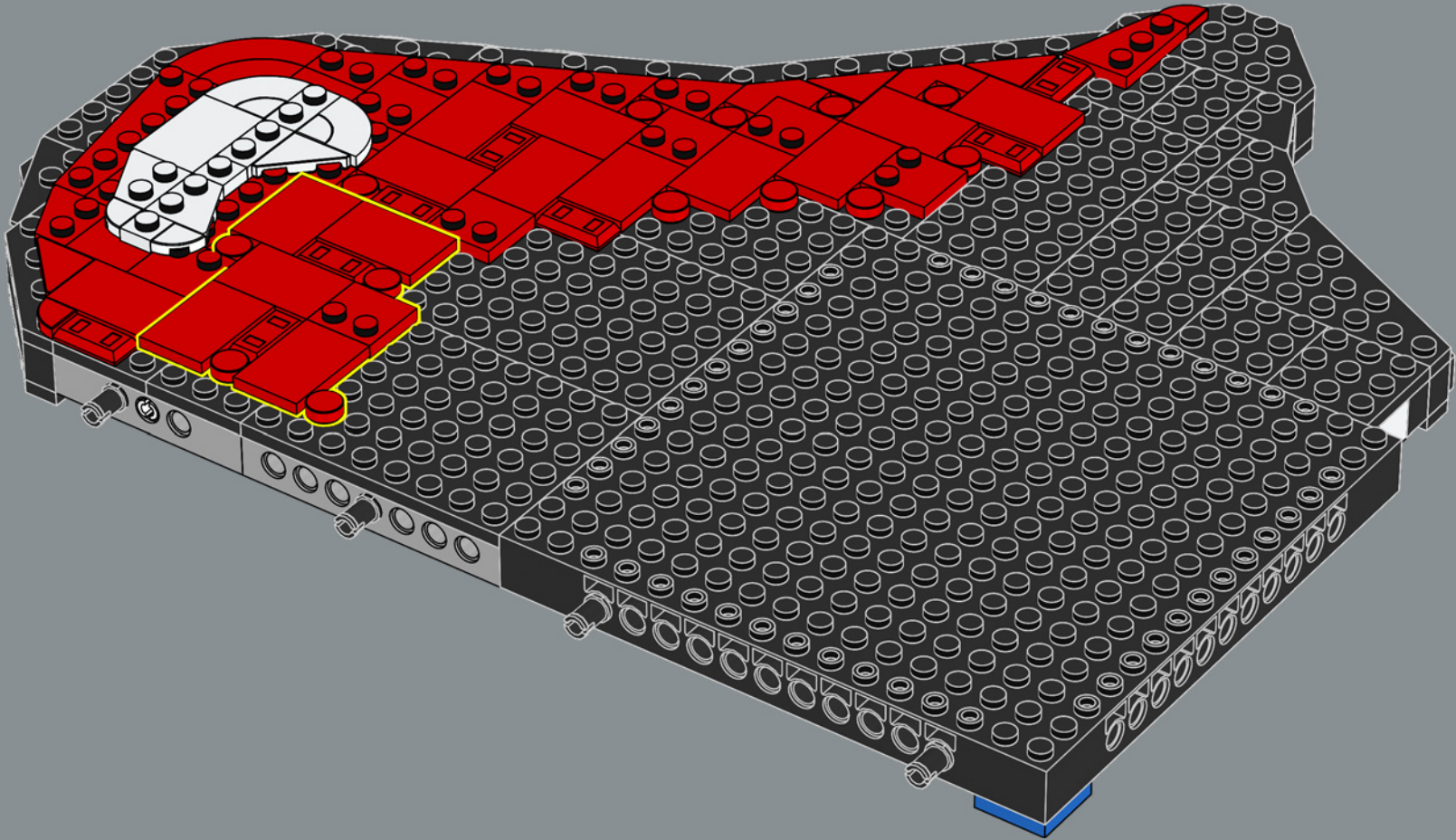

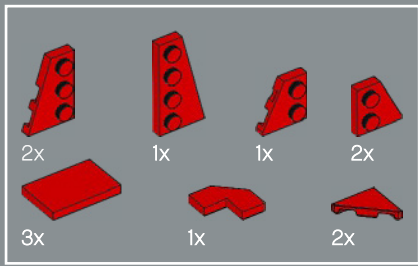

74

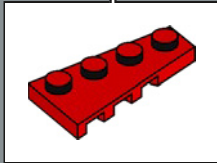
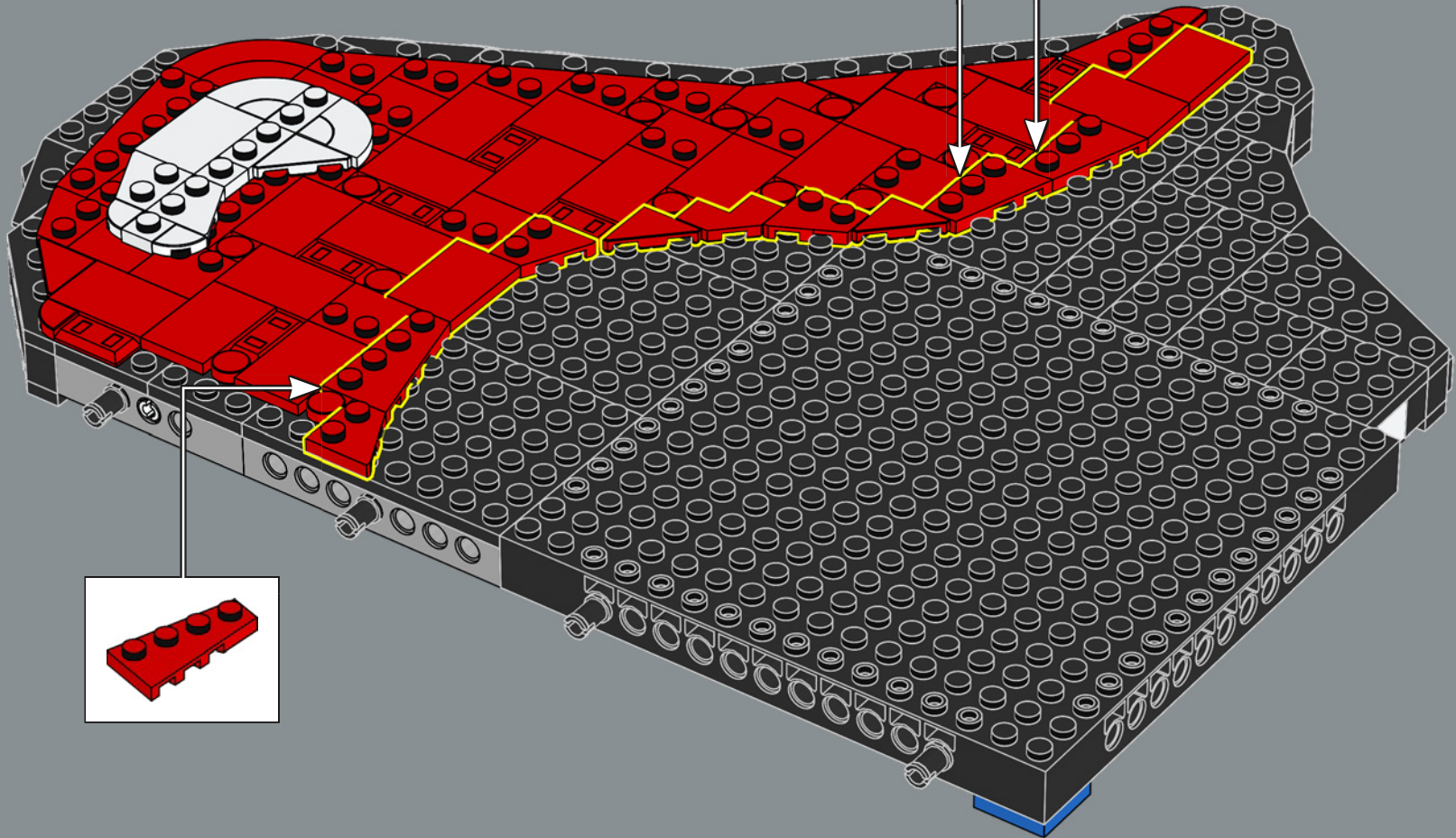
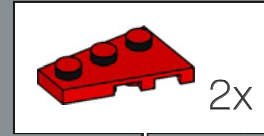

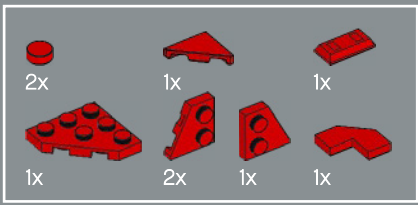

75

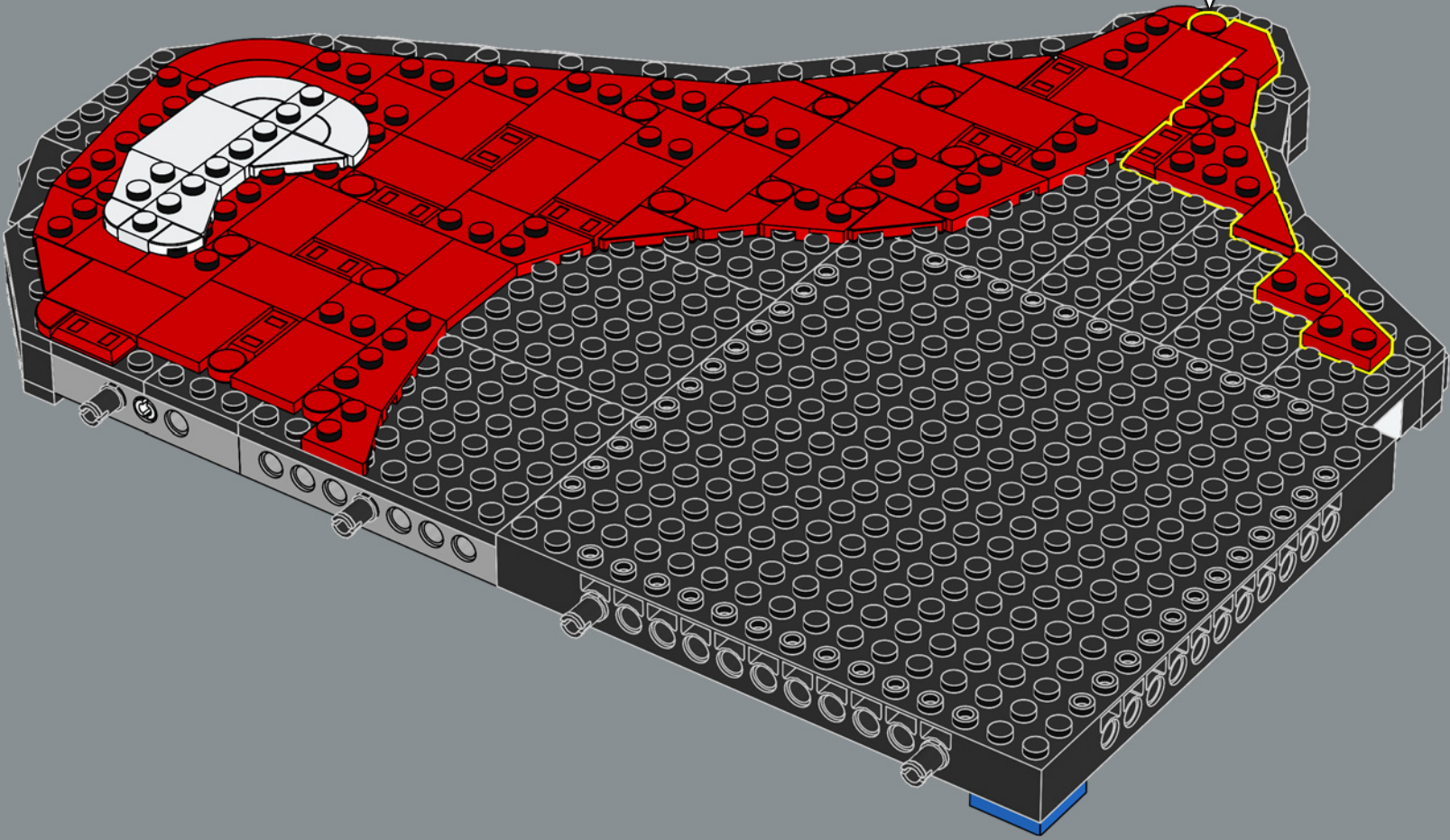



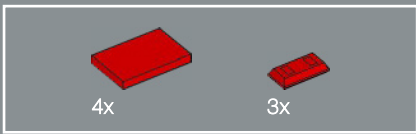

76

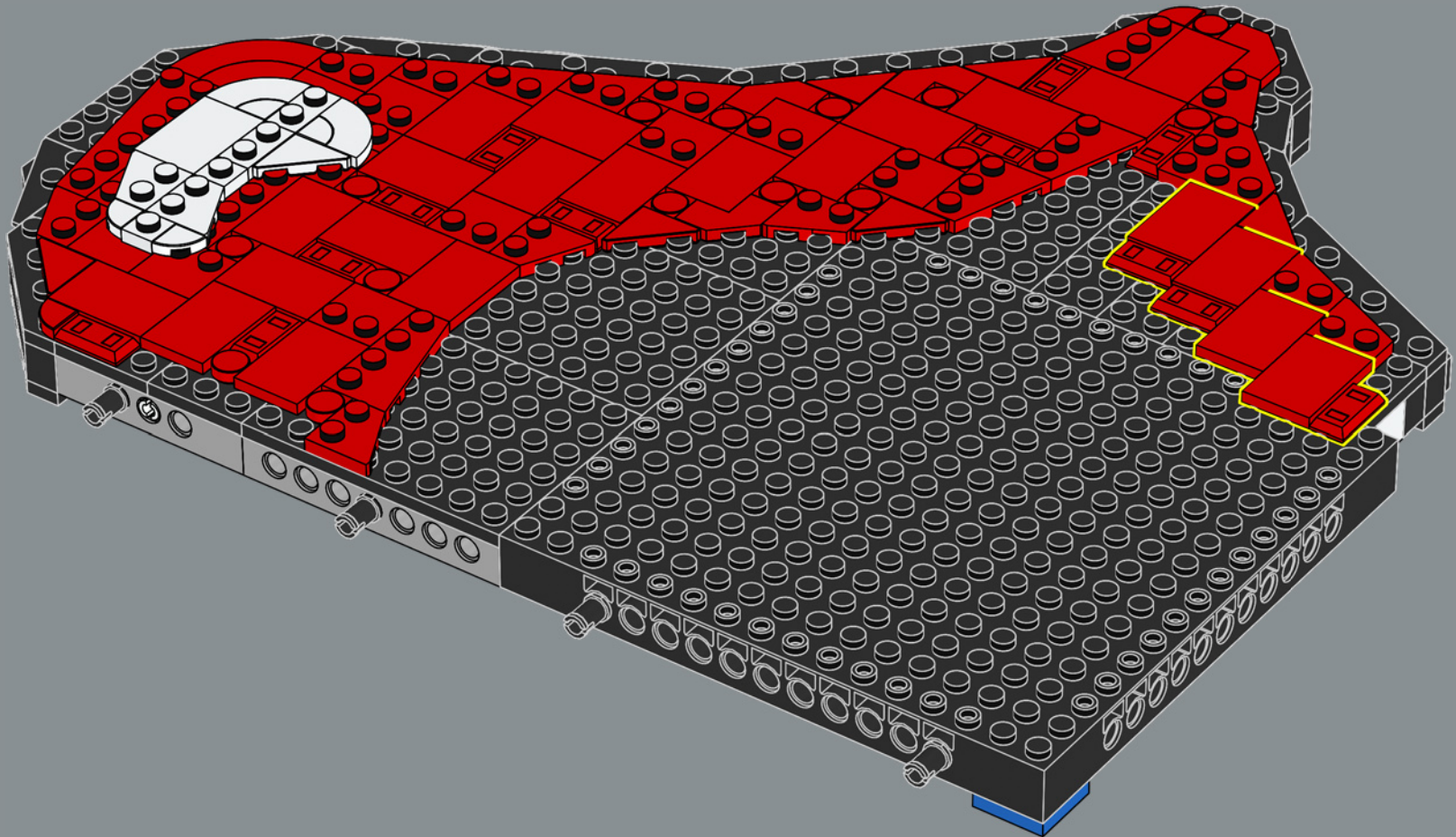

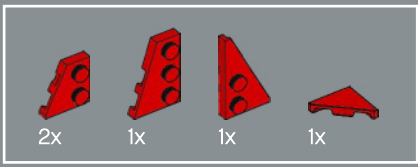

77

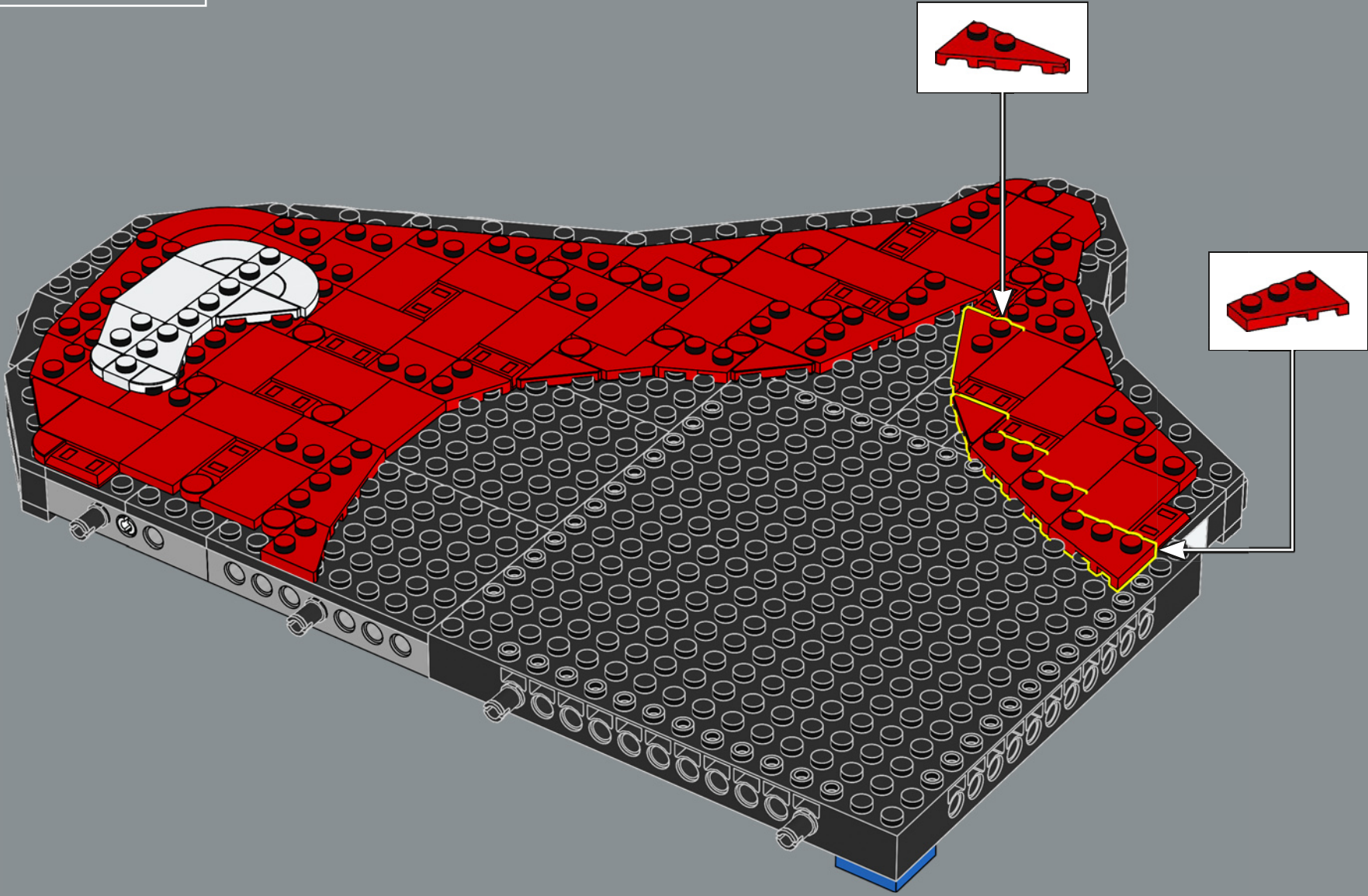

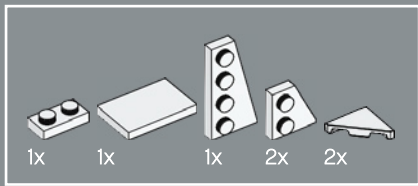

78

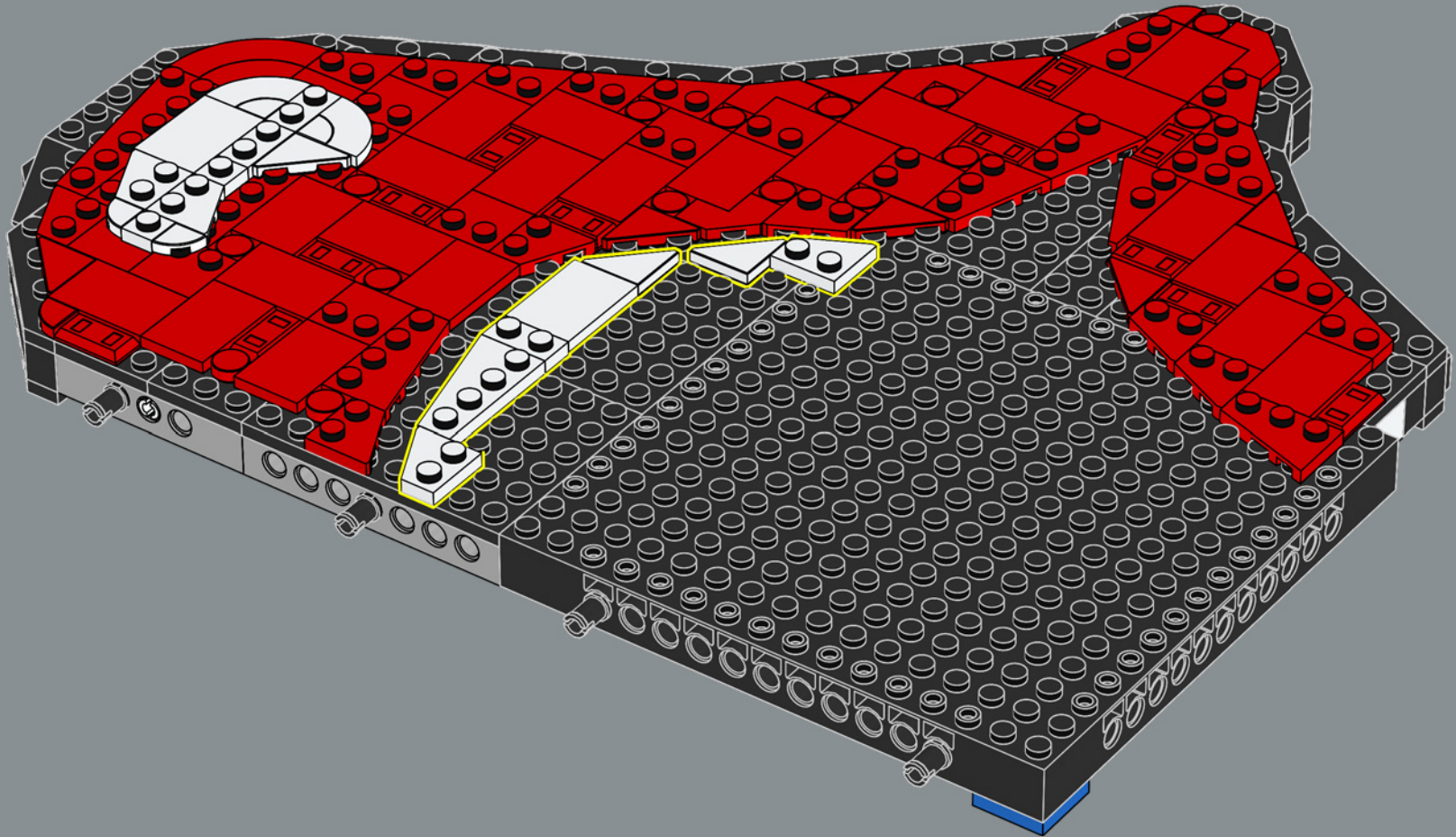

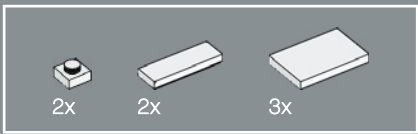

79

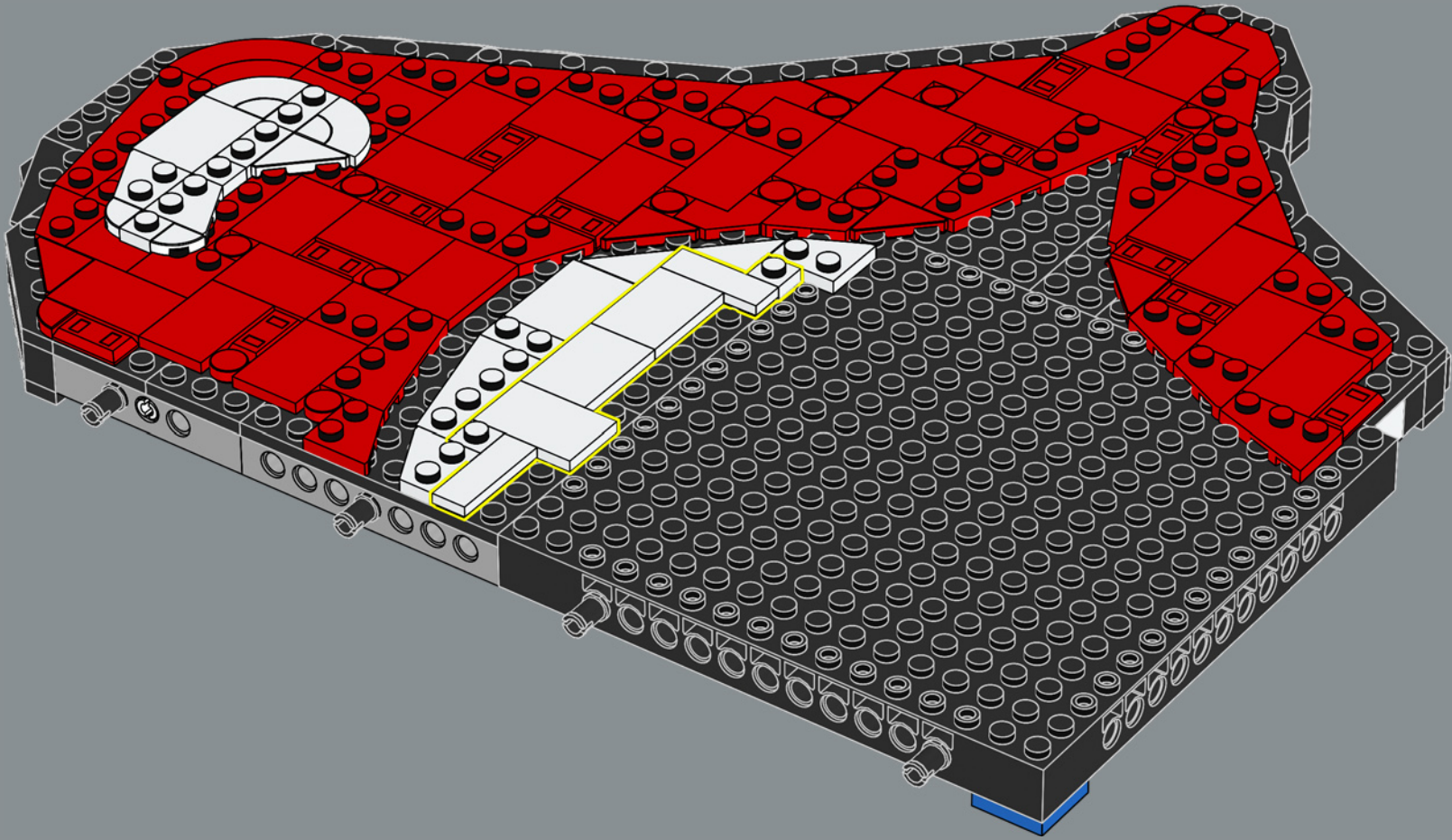

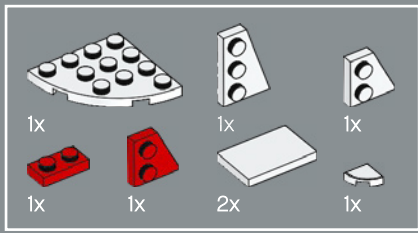

80

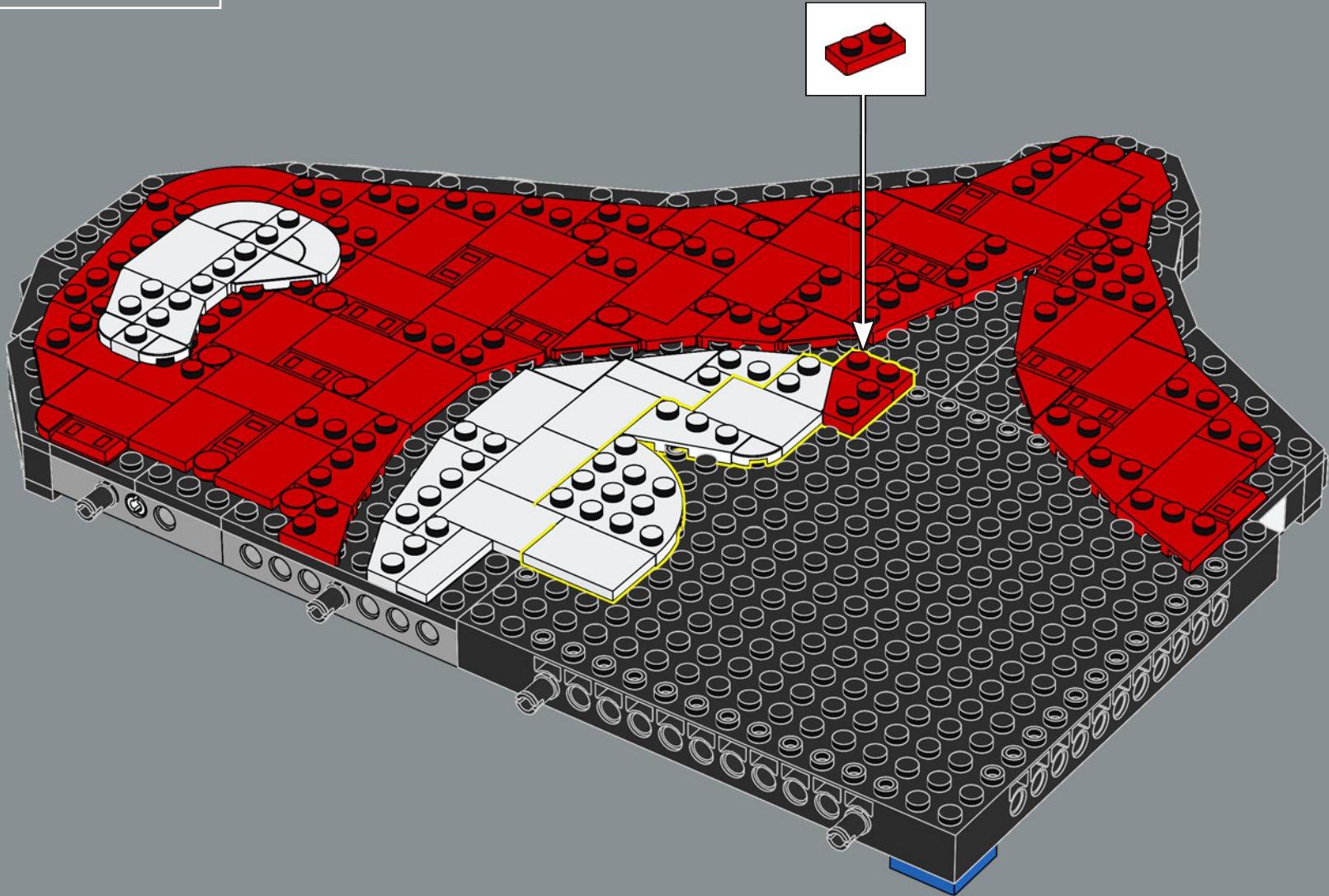

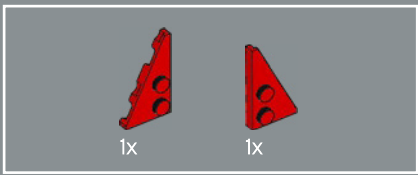

81

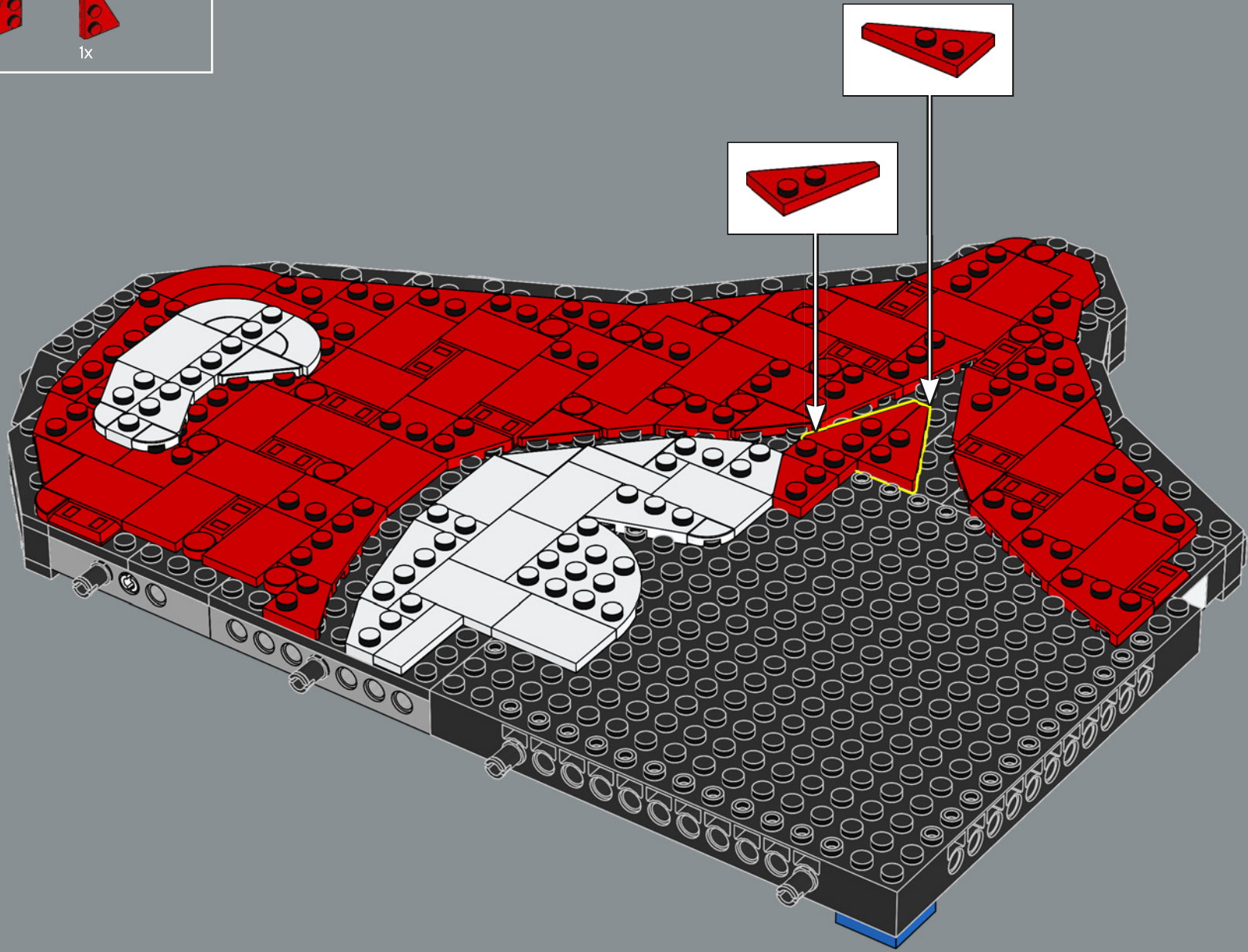

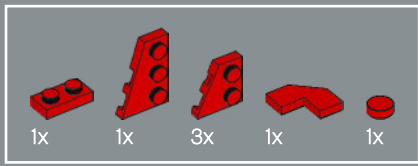

82

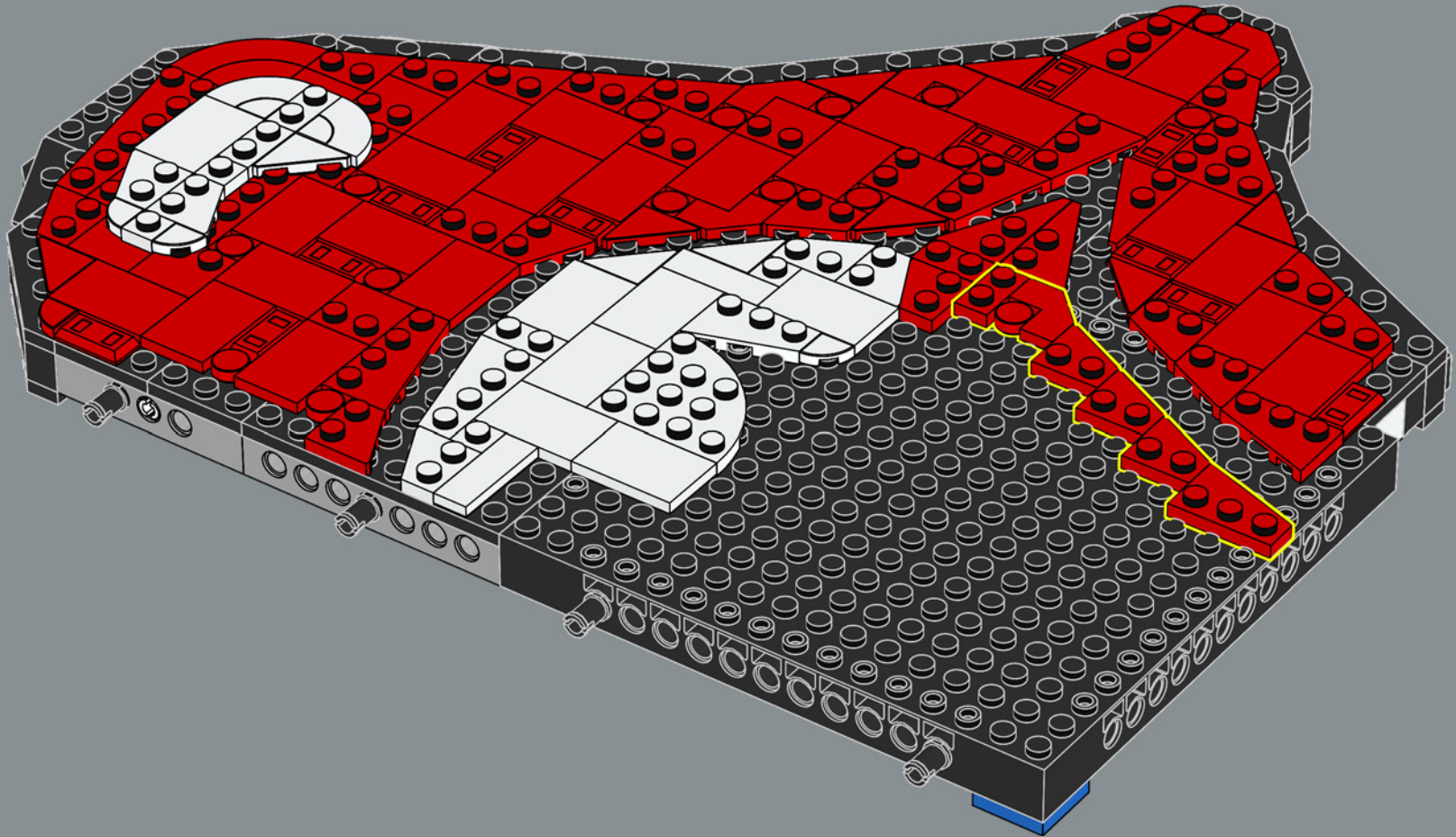

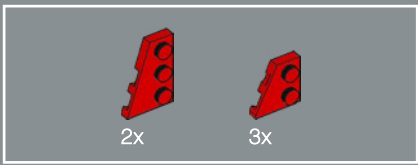

83

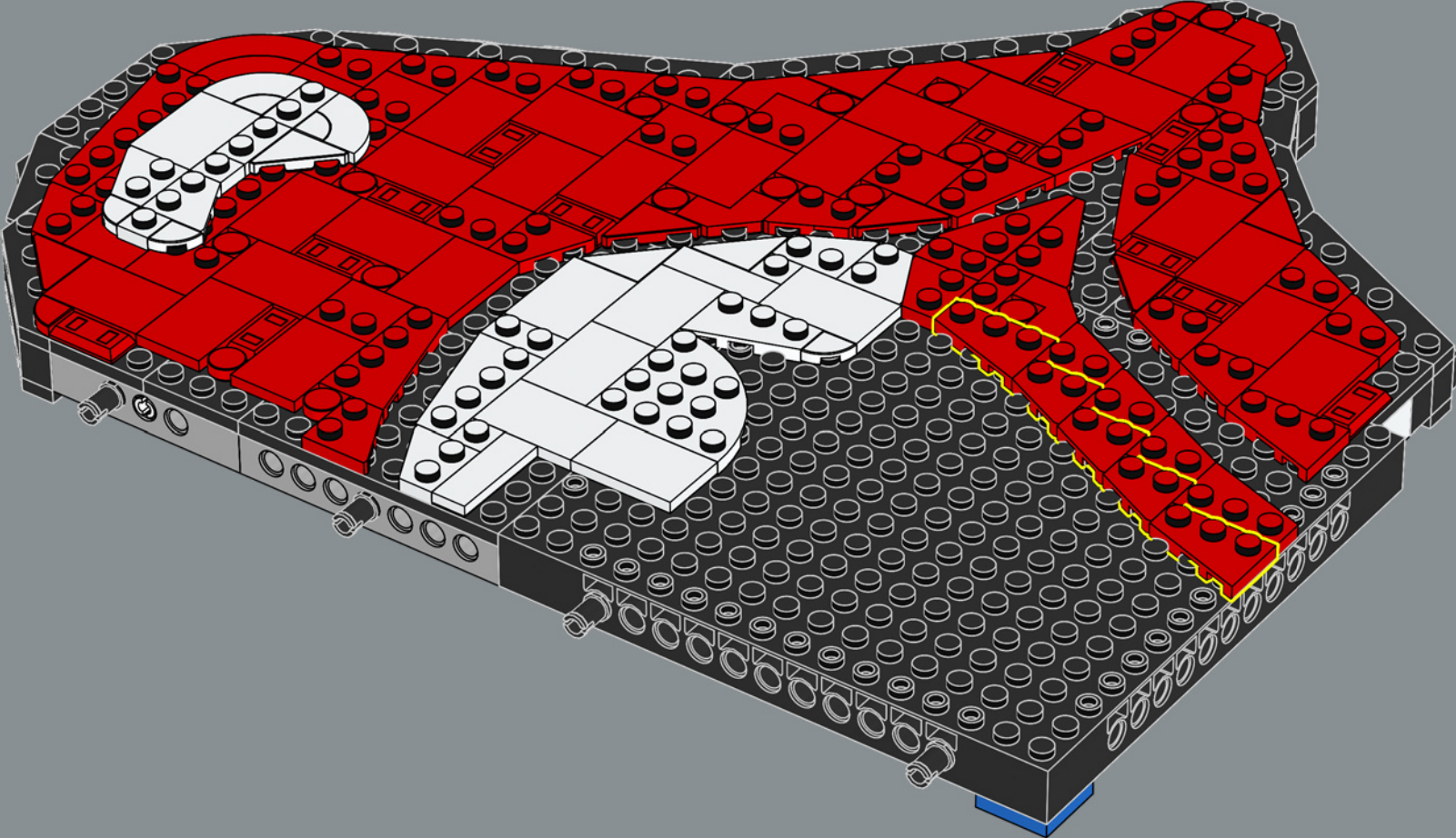



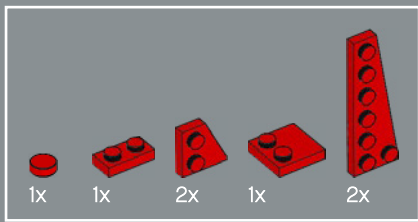

84

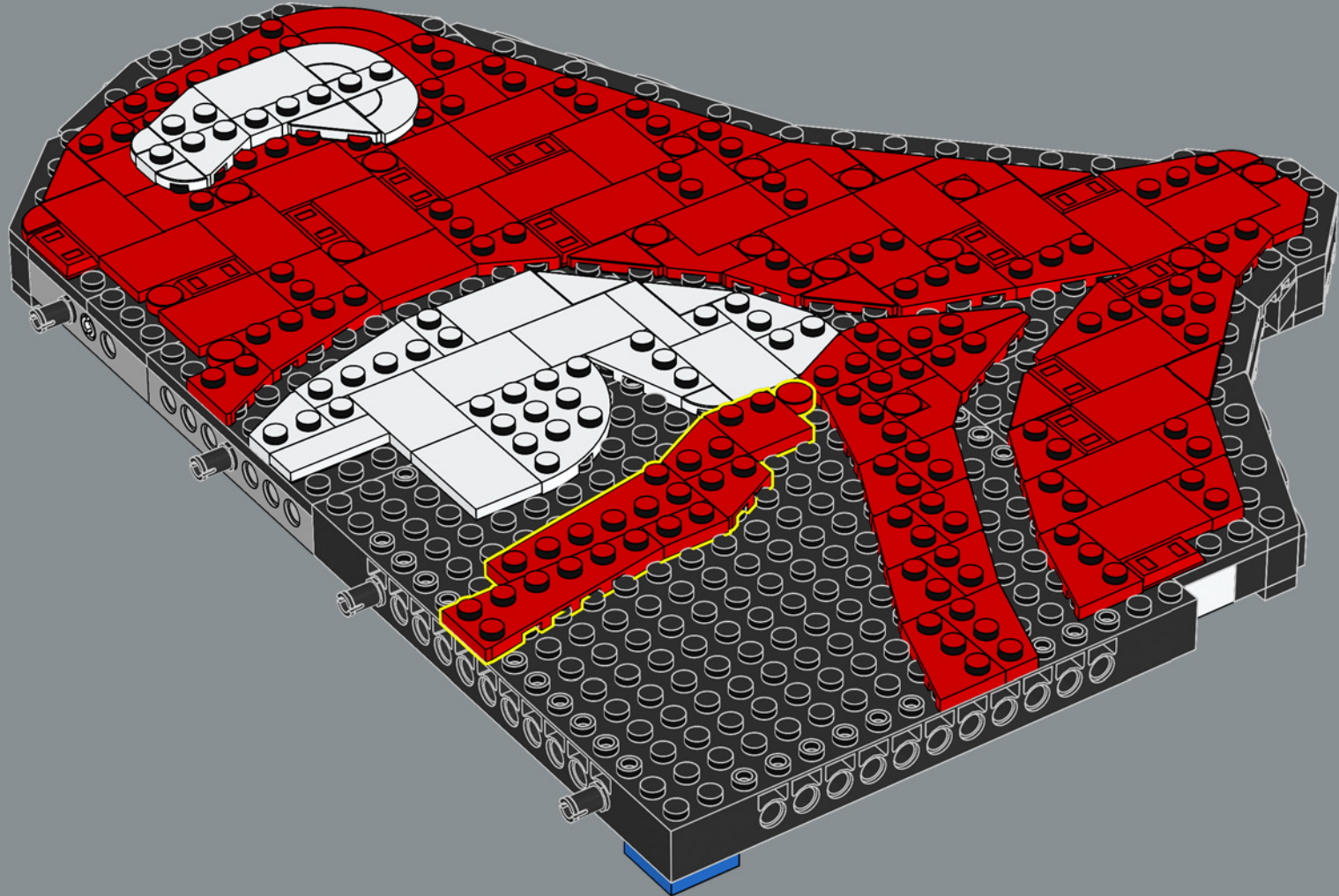

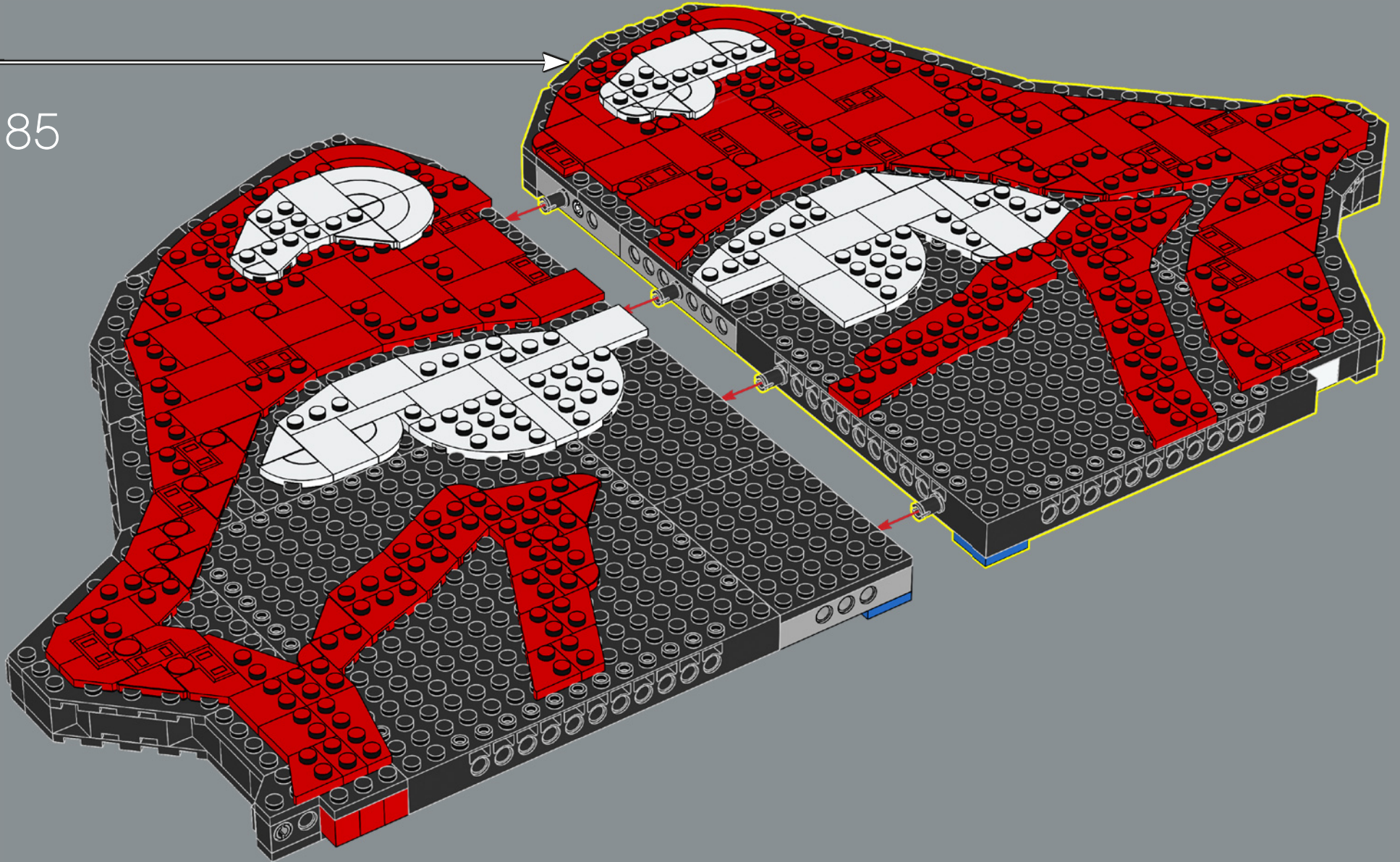

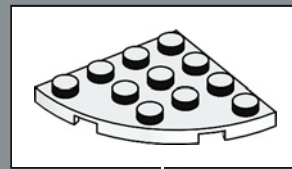
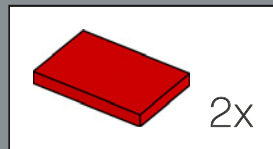
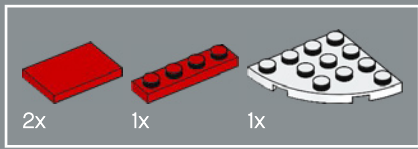

86

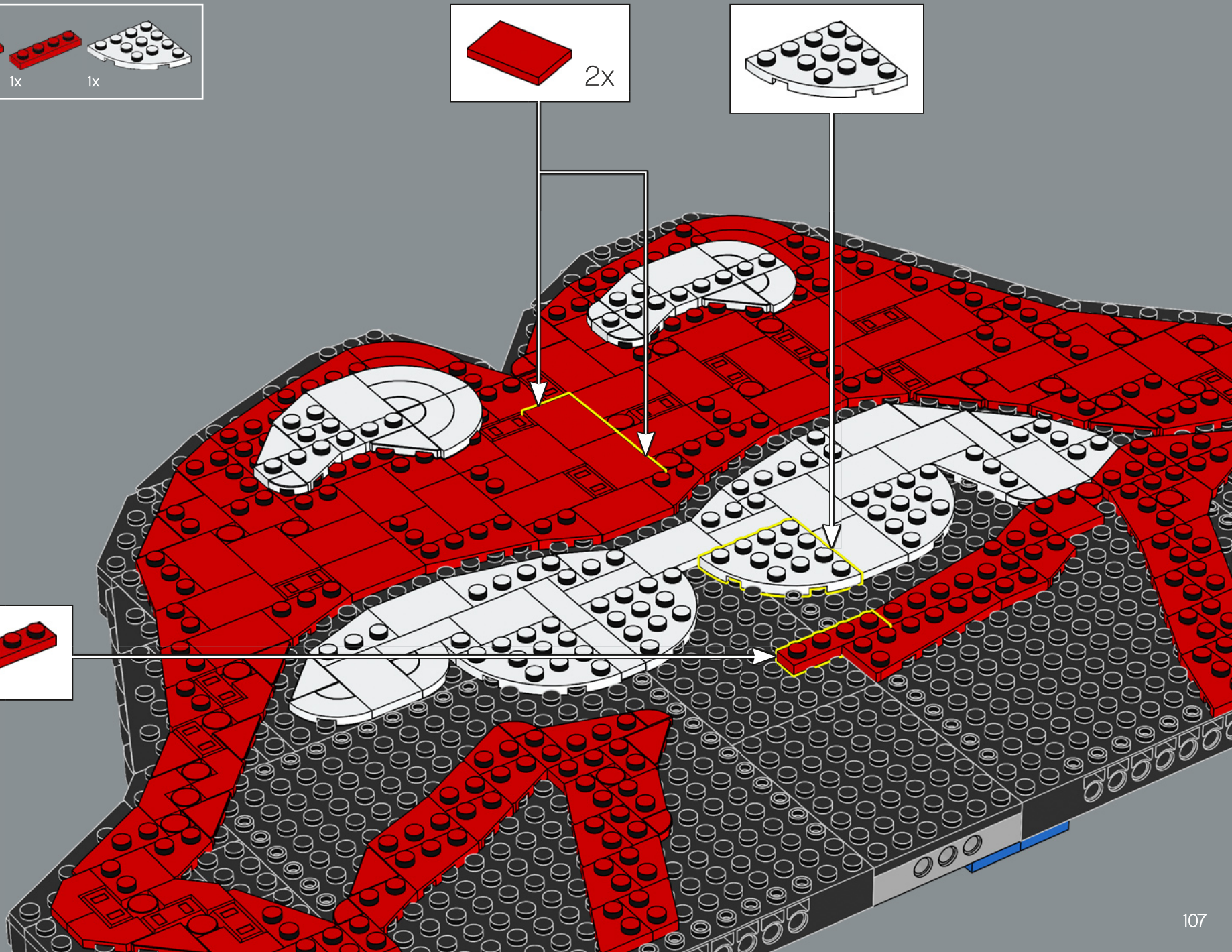
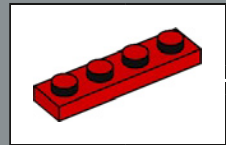

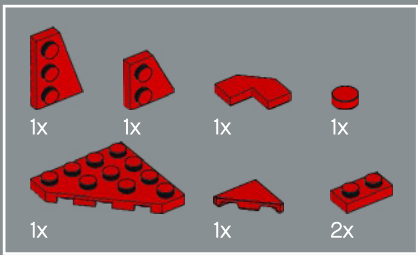

87

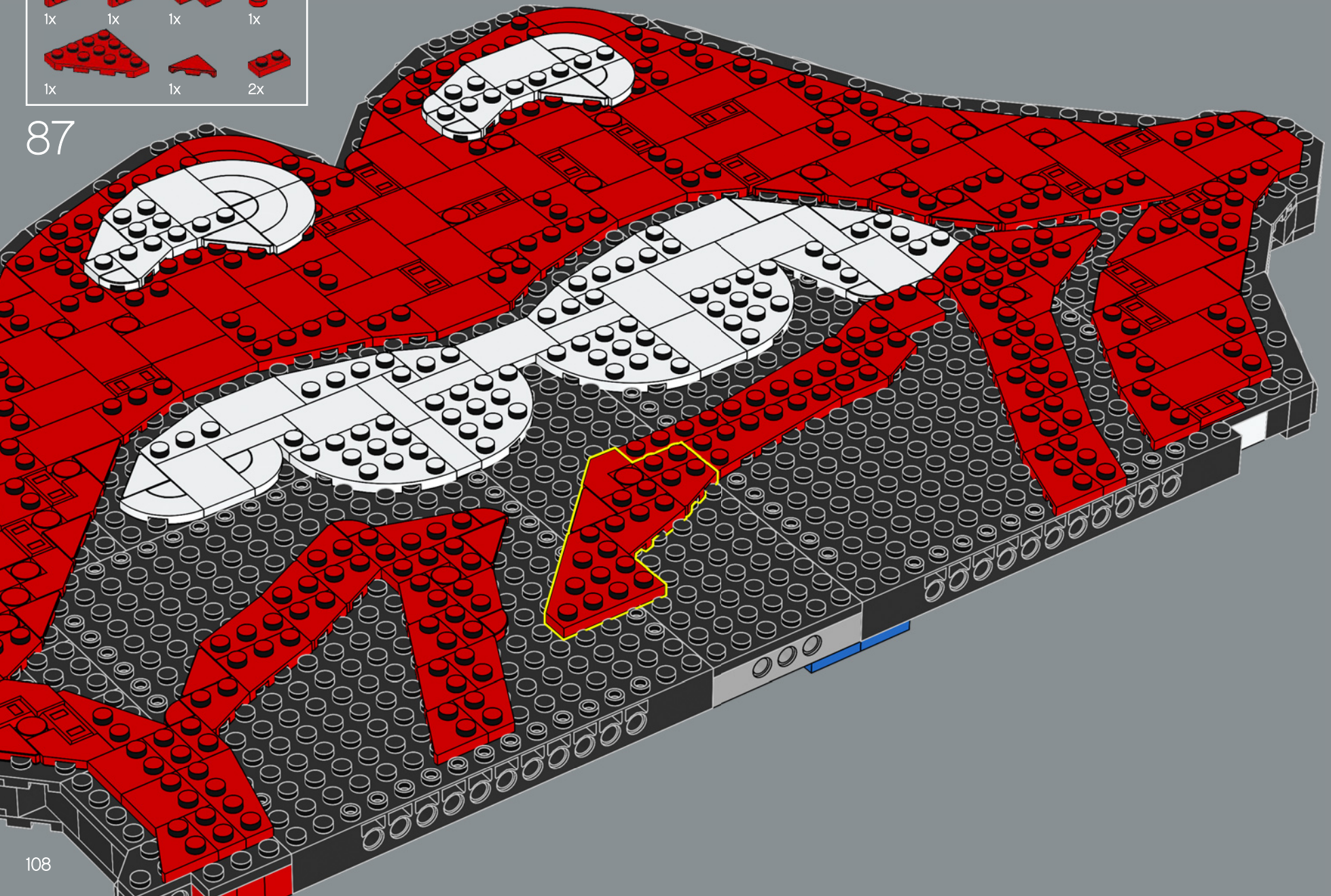

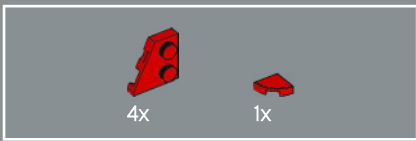

88

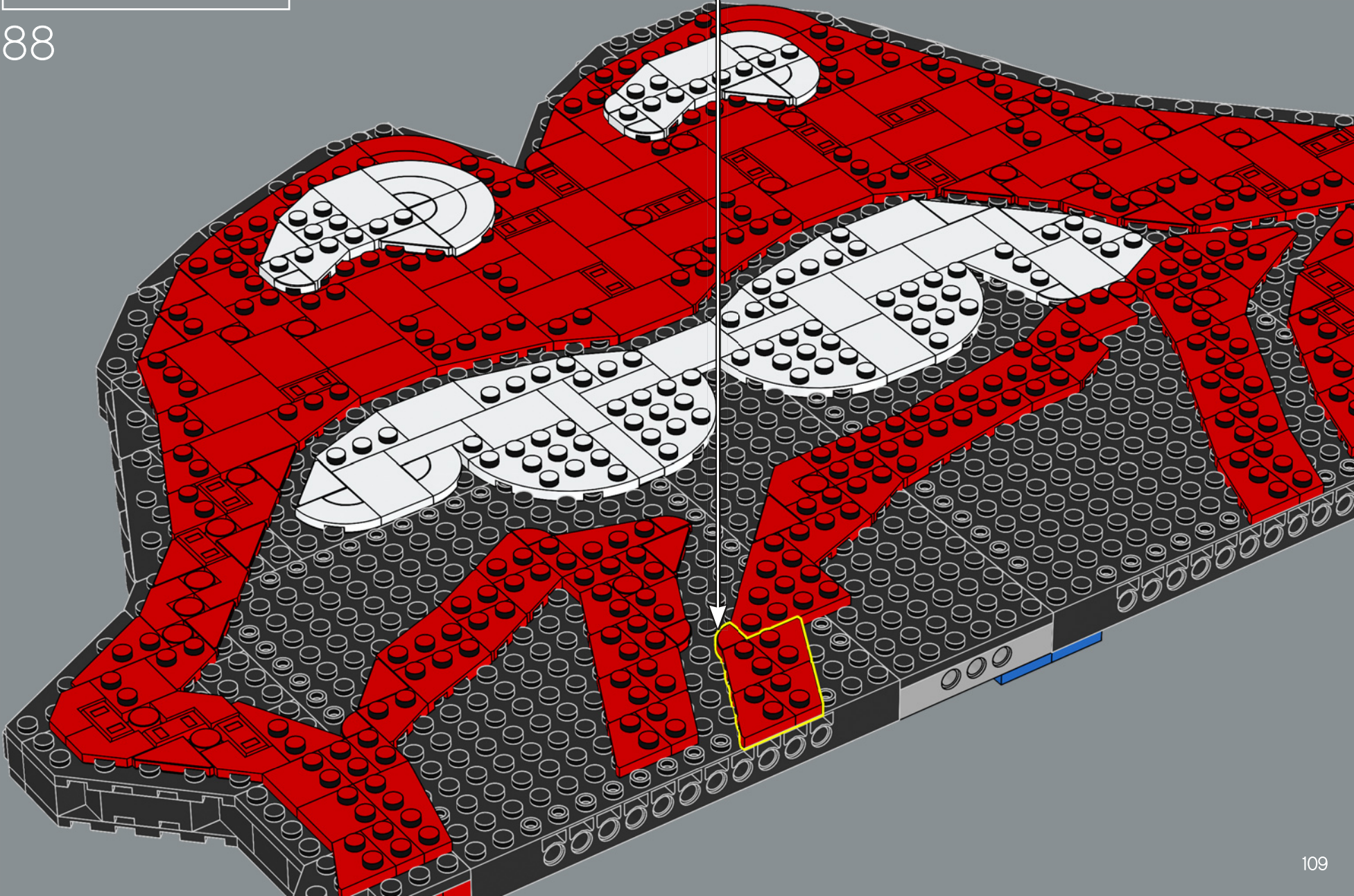

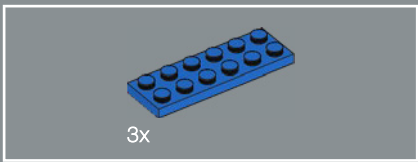

89

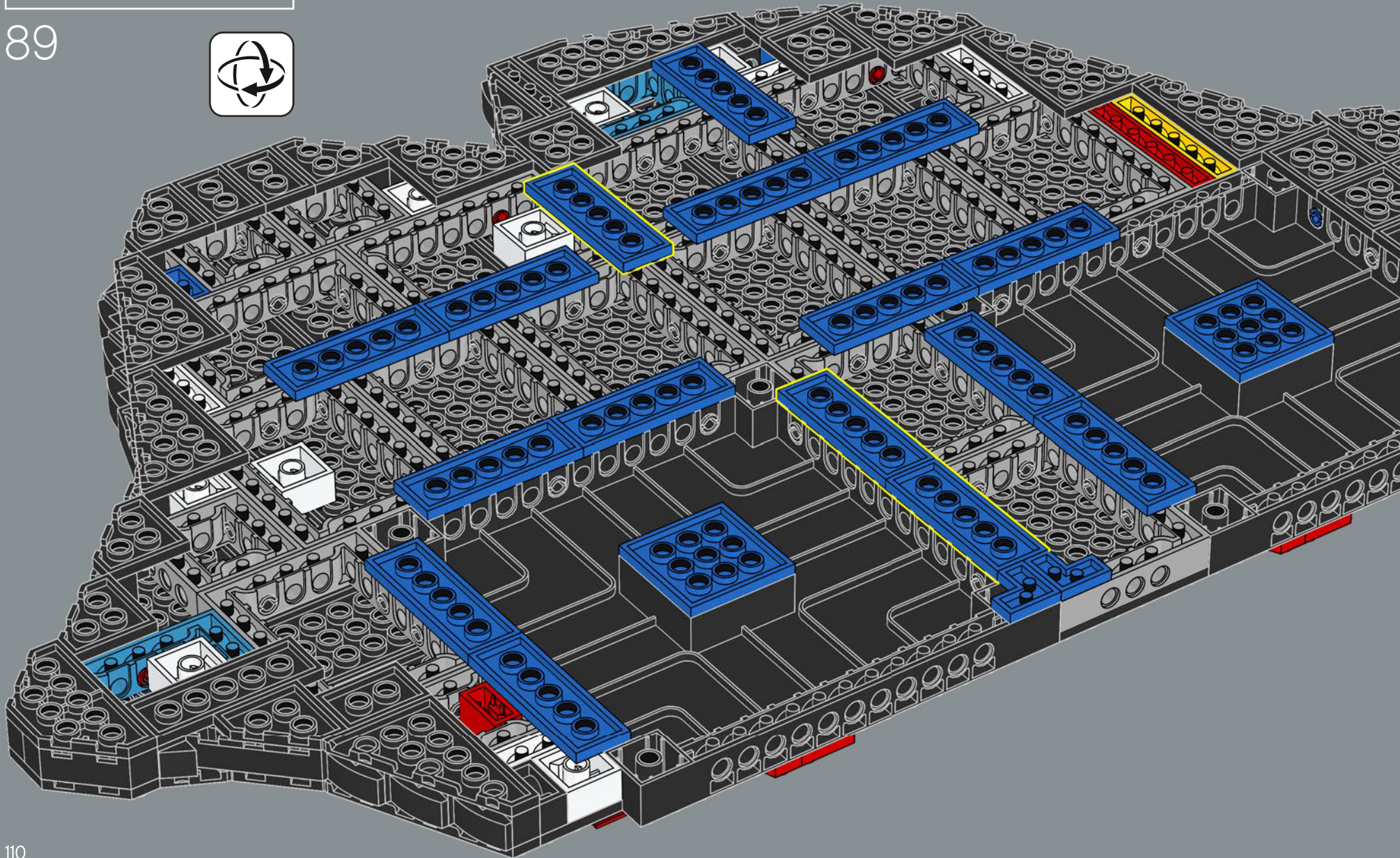

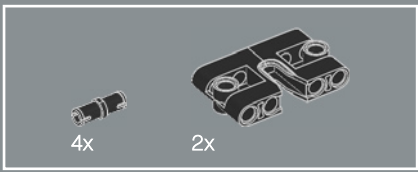

90

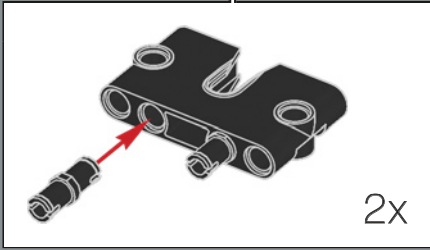
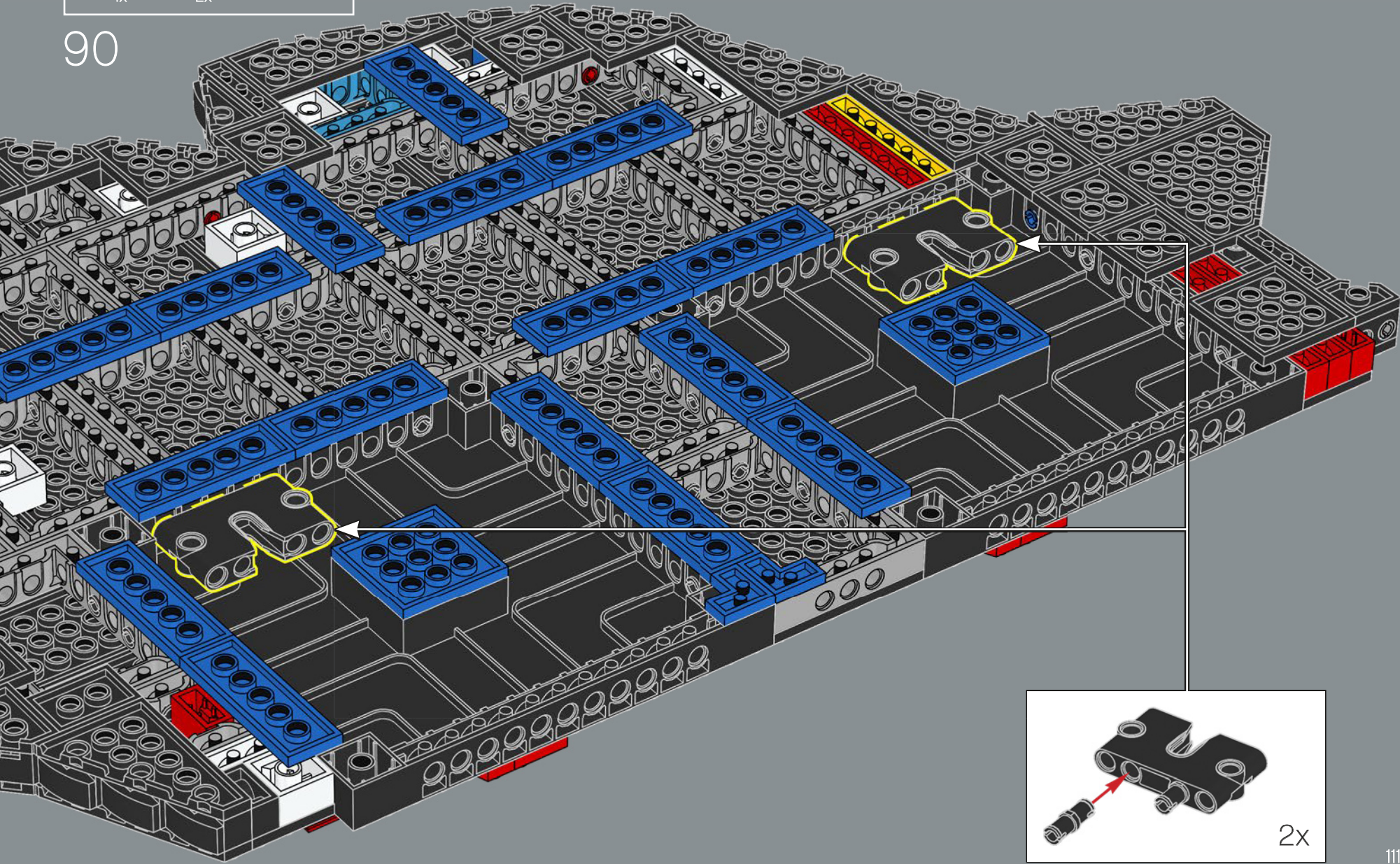

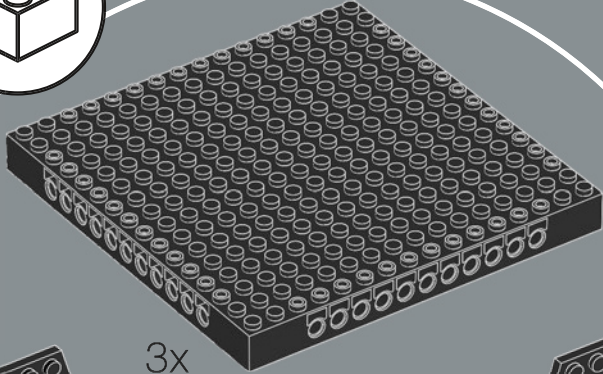
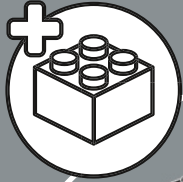

3x

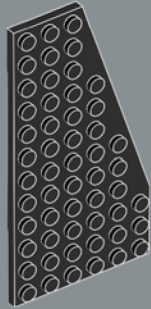

1x

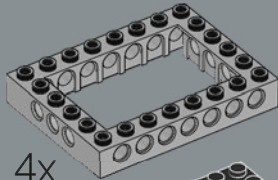

4x

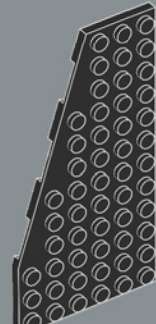

1x

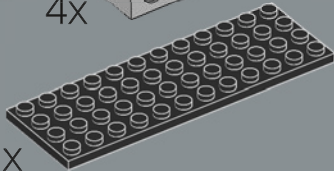

1x





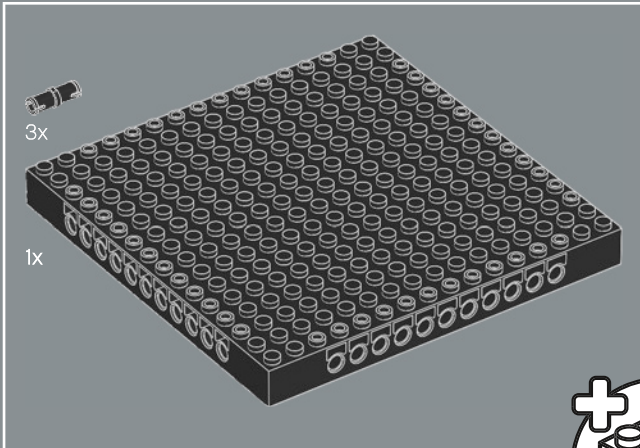
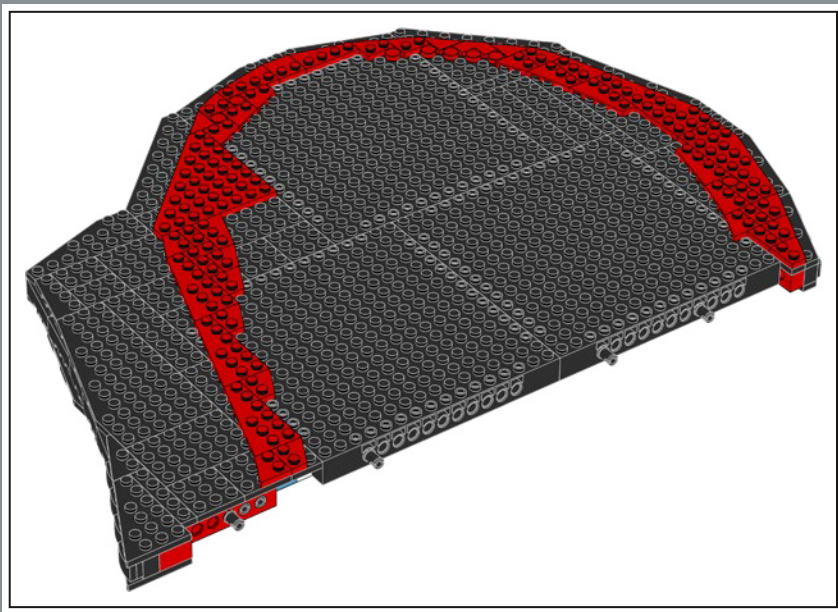

3x

1x

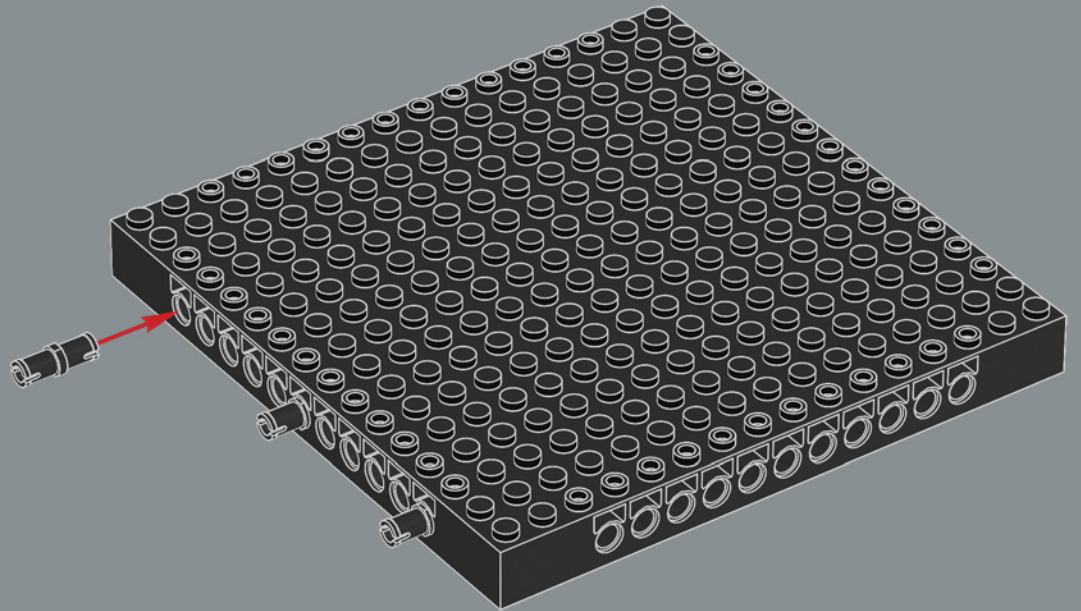
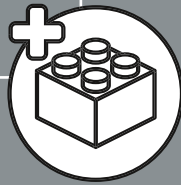

91

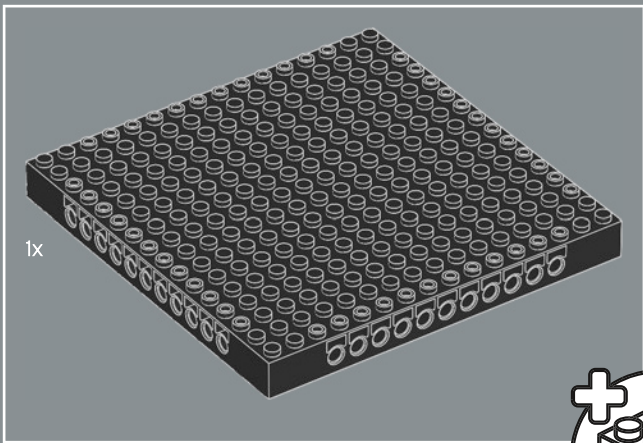

92

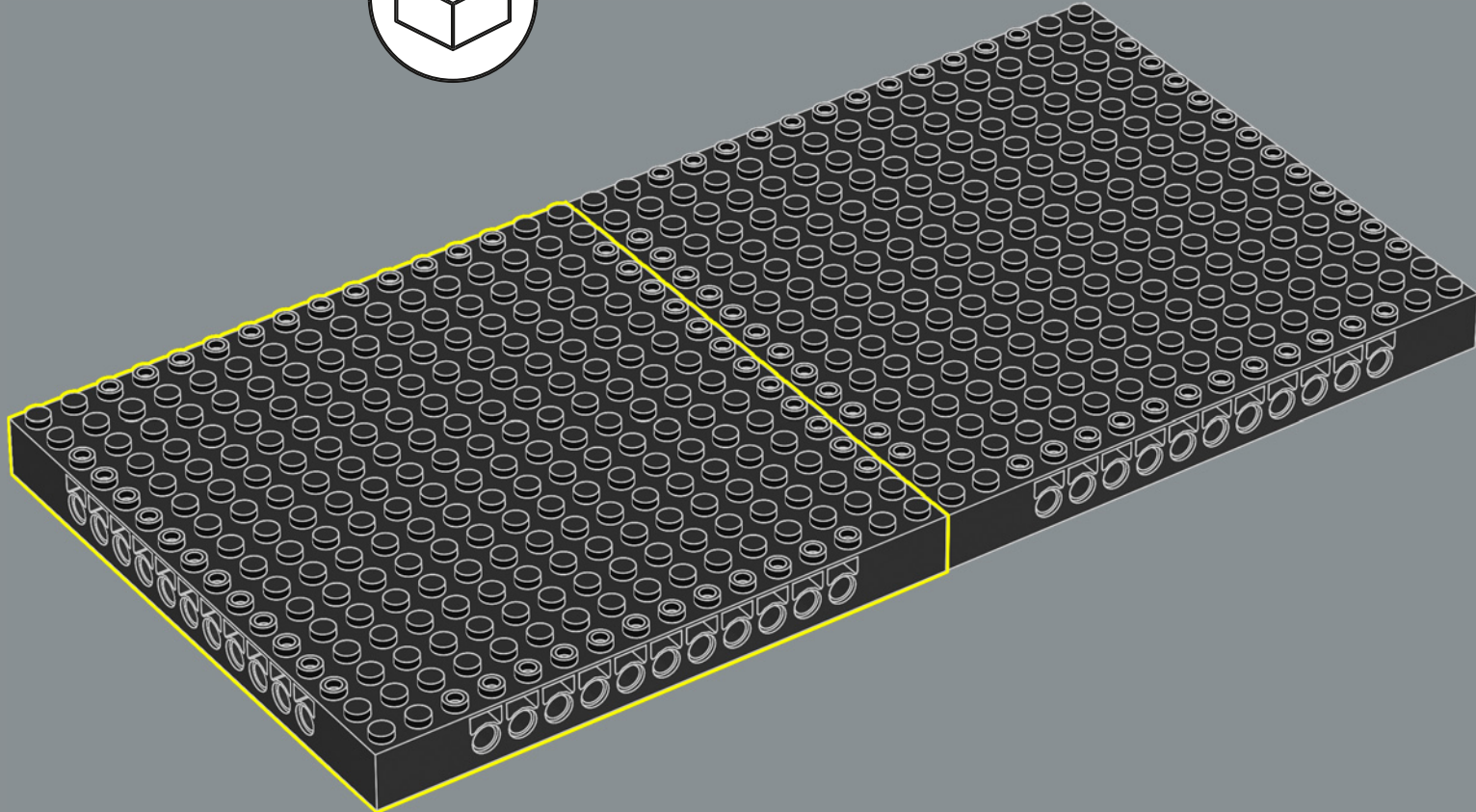
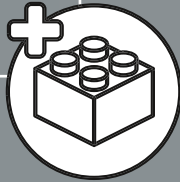

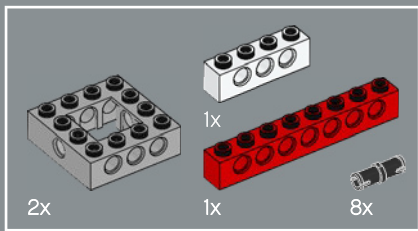

93

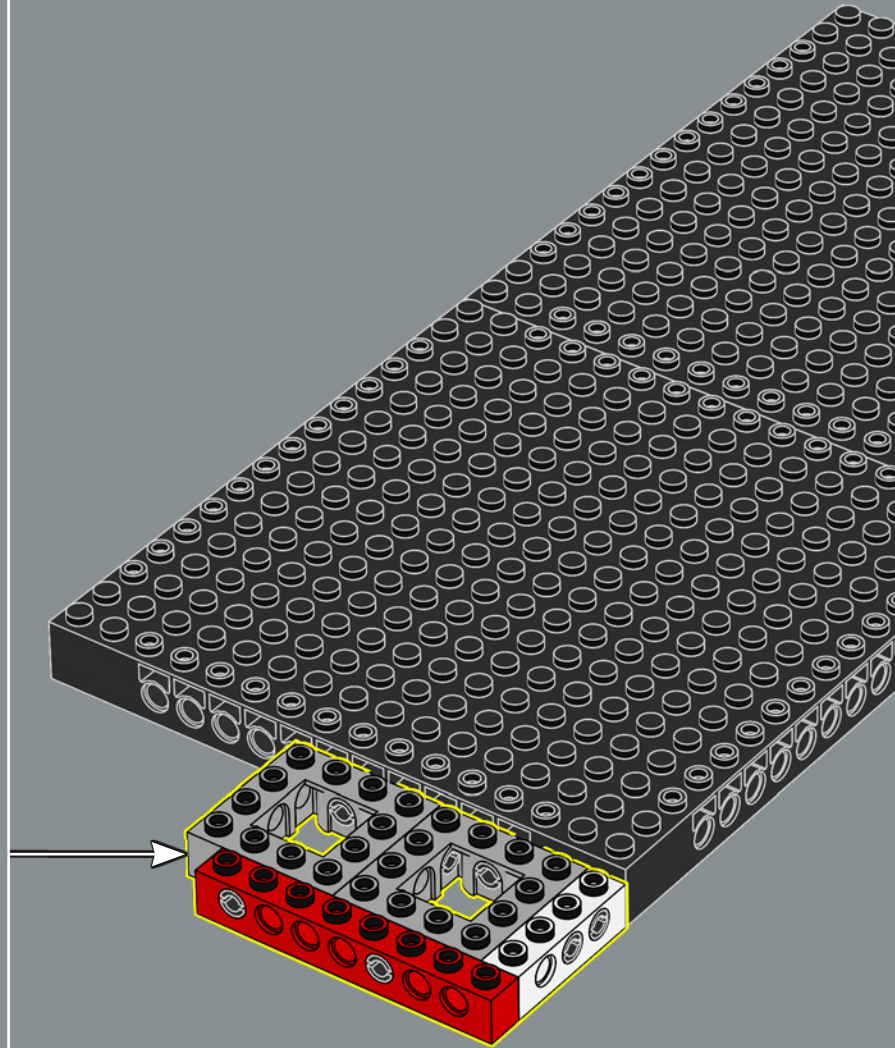
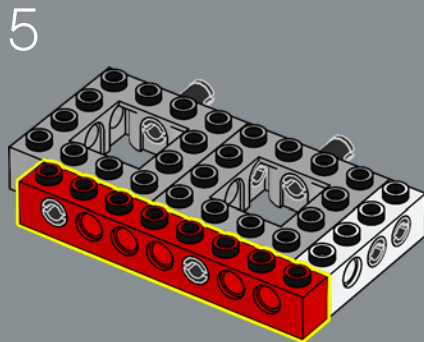
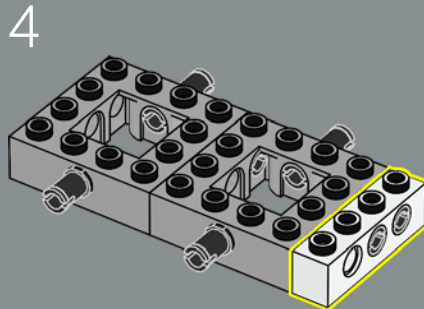
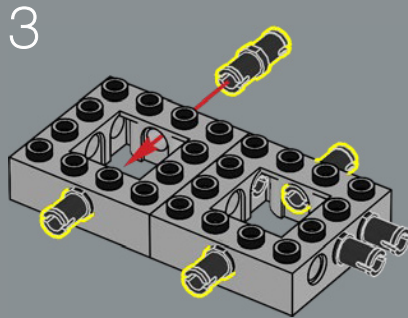
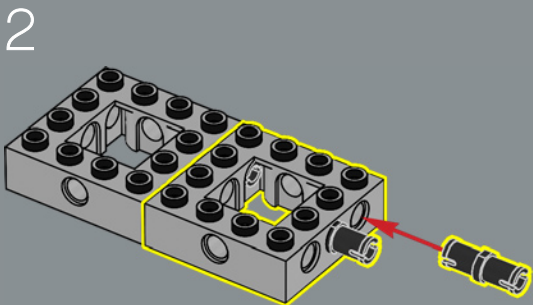
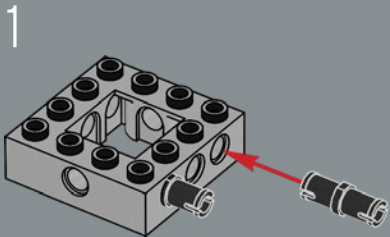

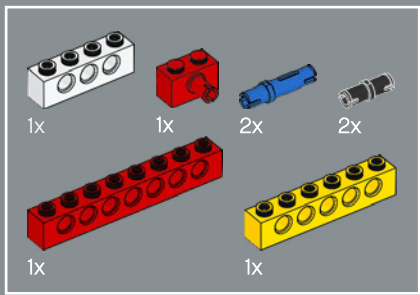

94

1

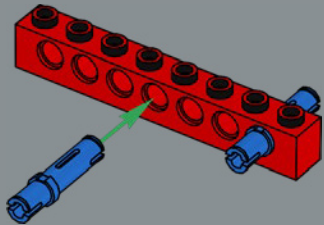

2

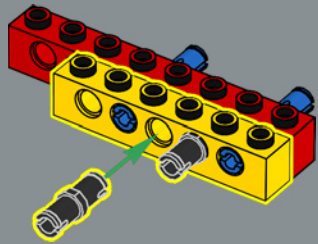

3

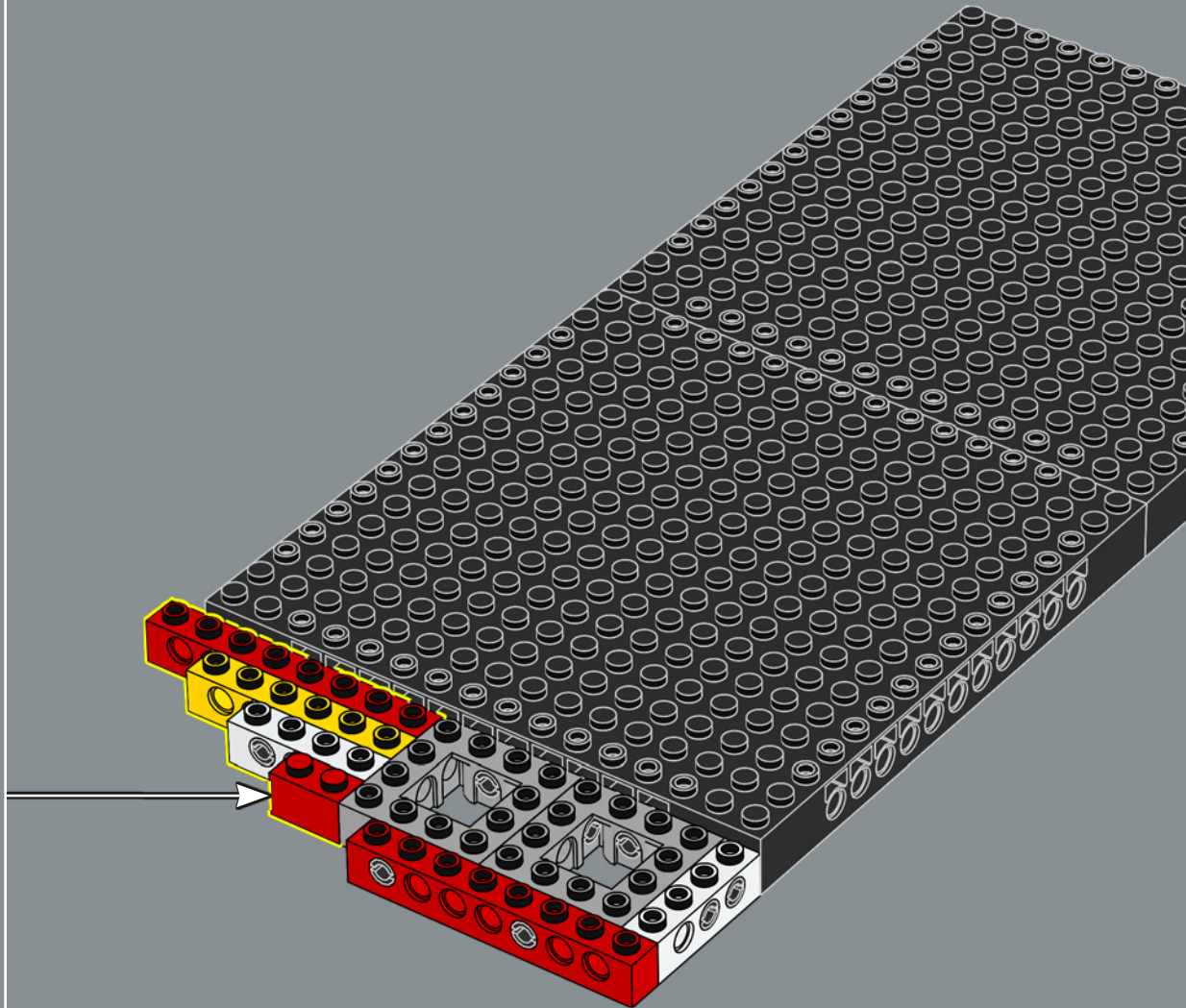
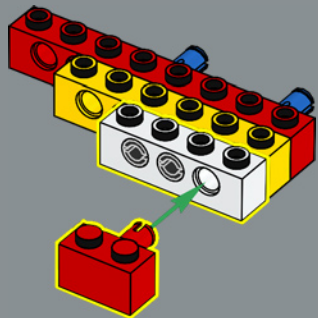

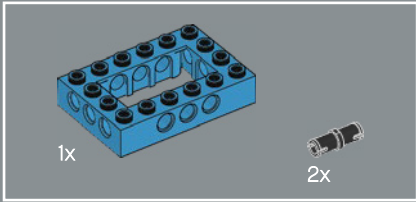
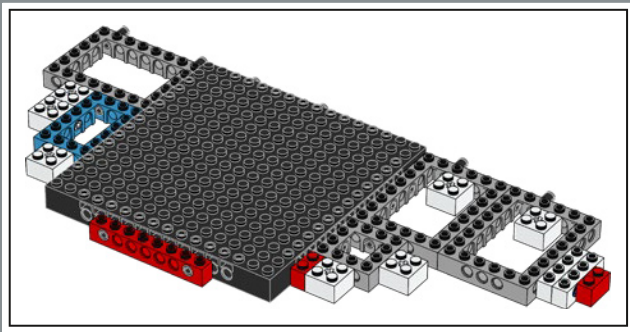

95

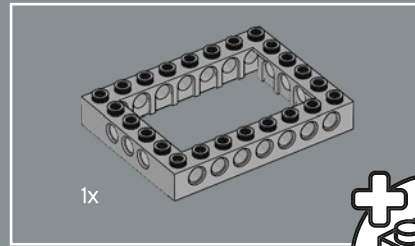
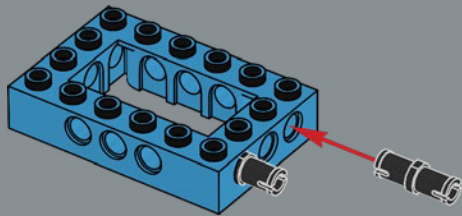

96

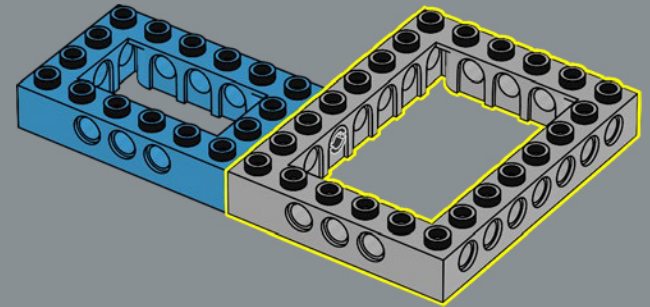
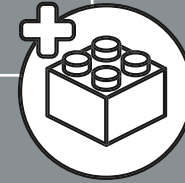

97

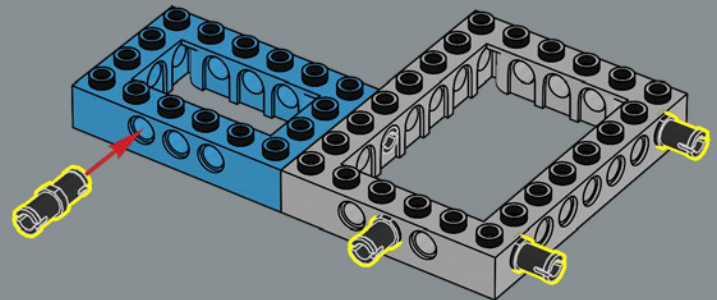

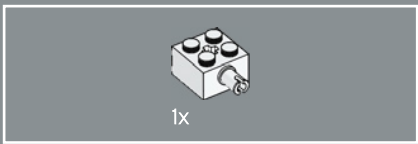

98

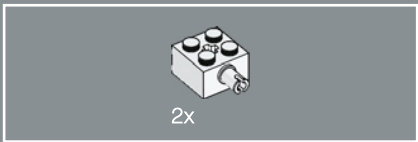
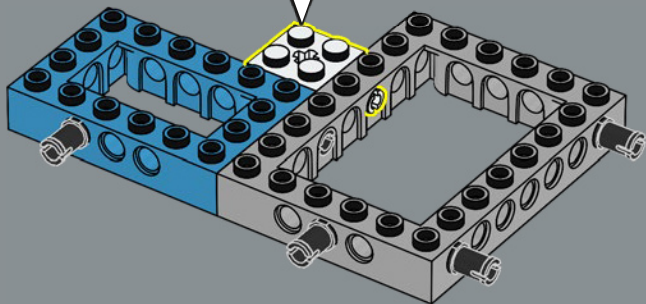
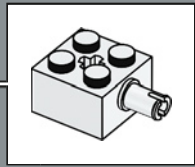

99

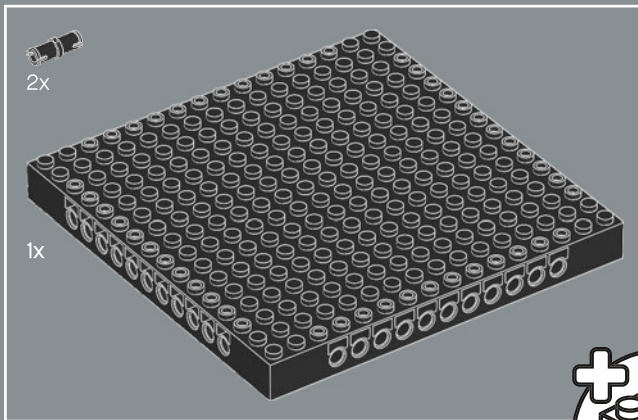
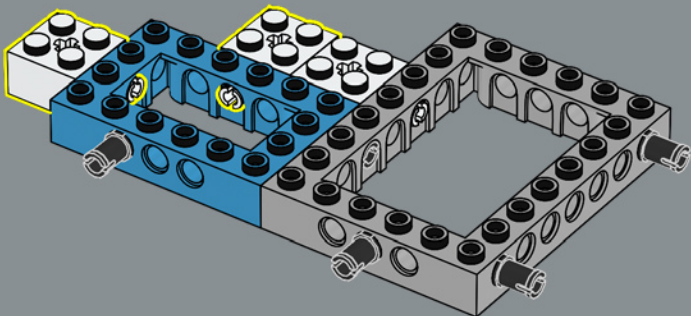

100

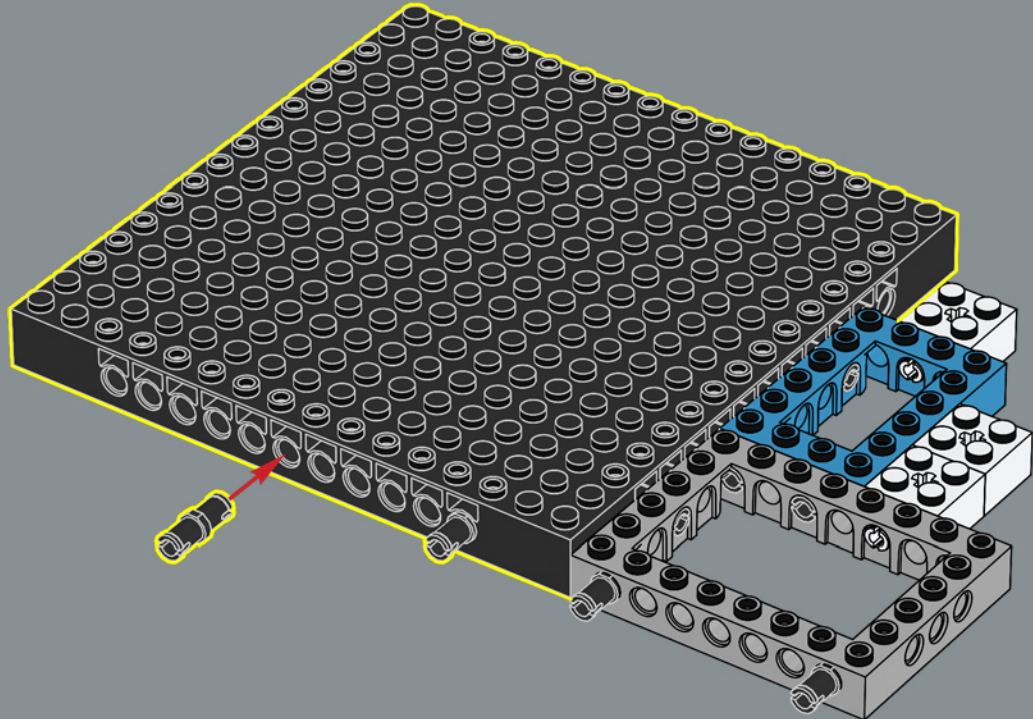
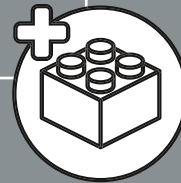

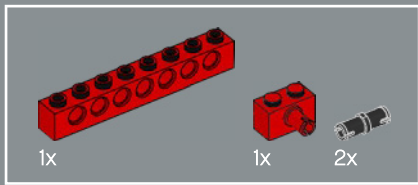

101

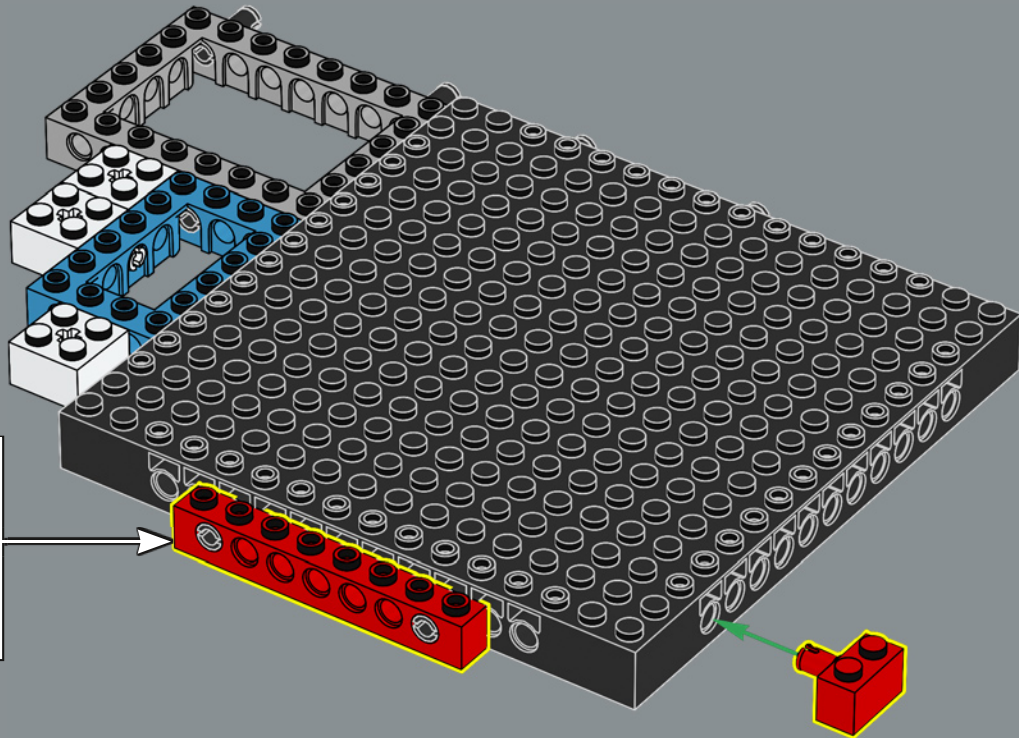
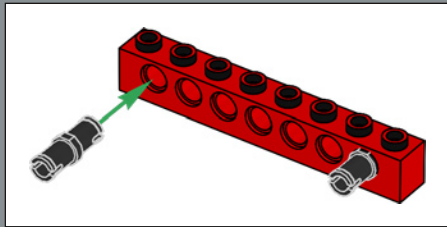

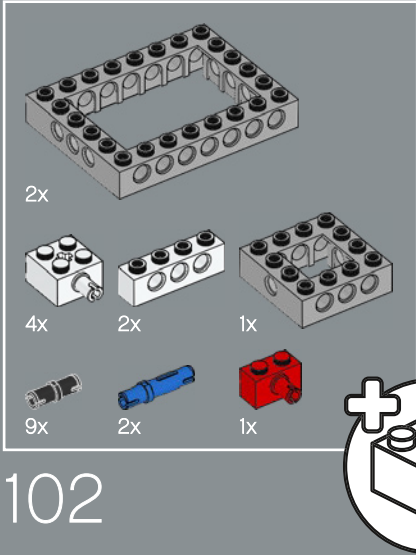
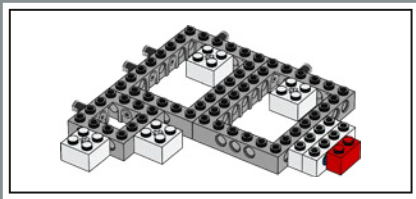

102

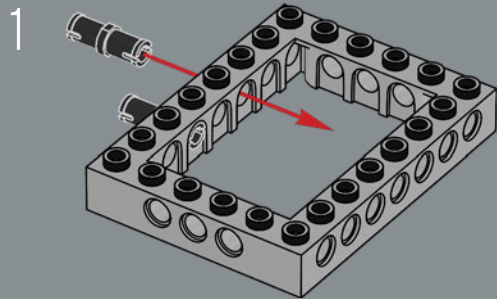

2

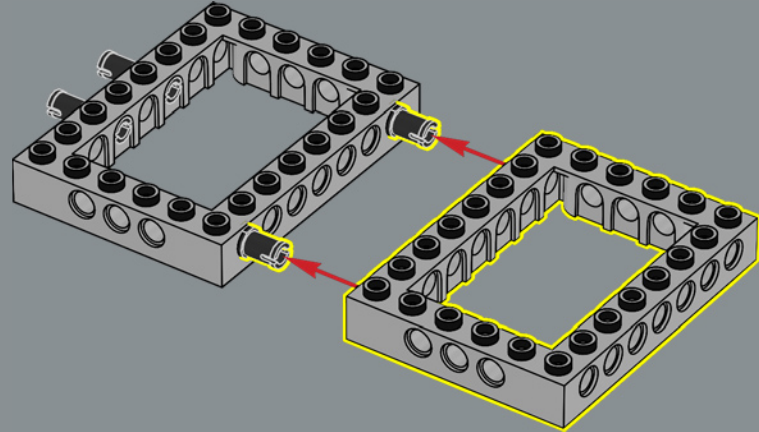

3

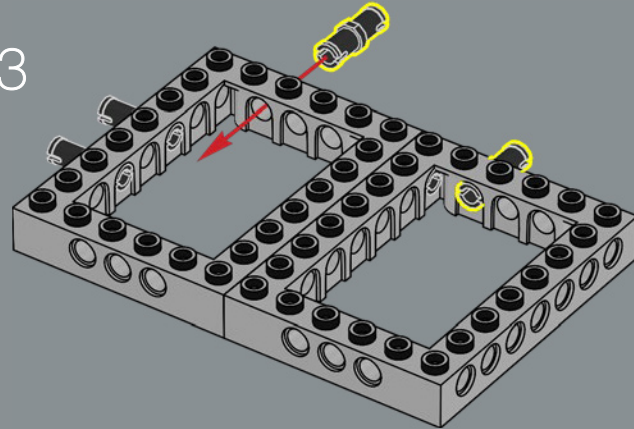



4

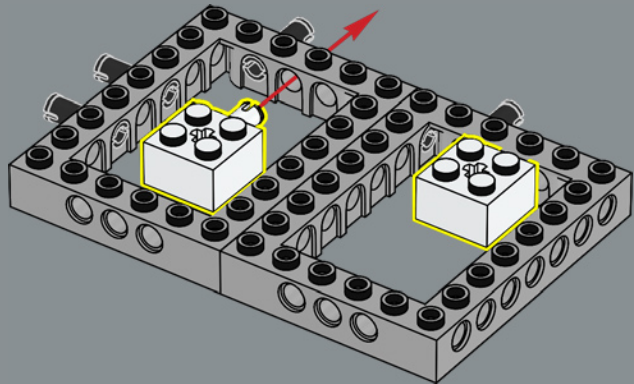

6

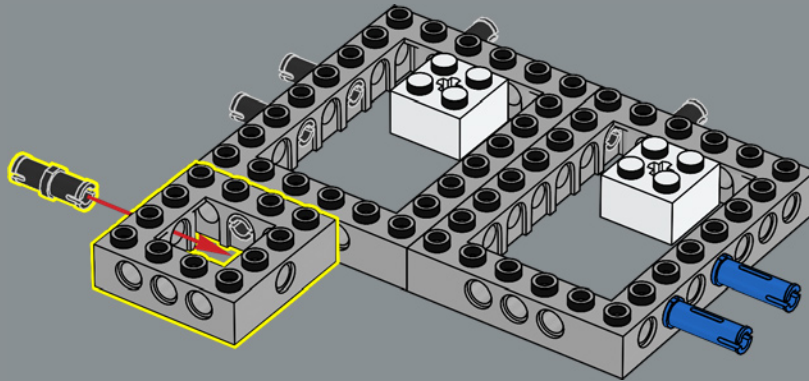

5

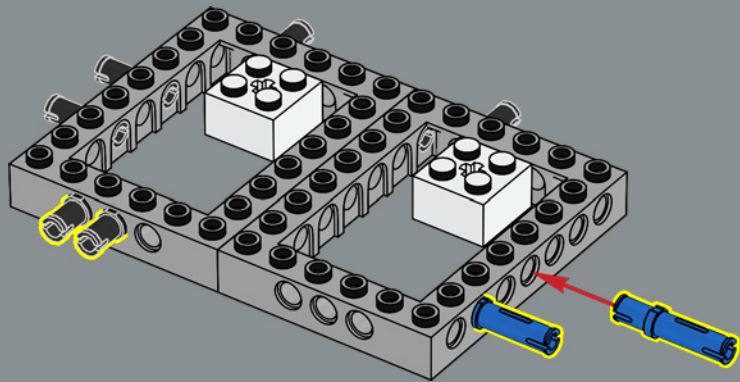

7

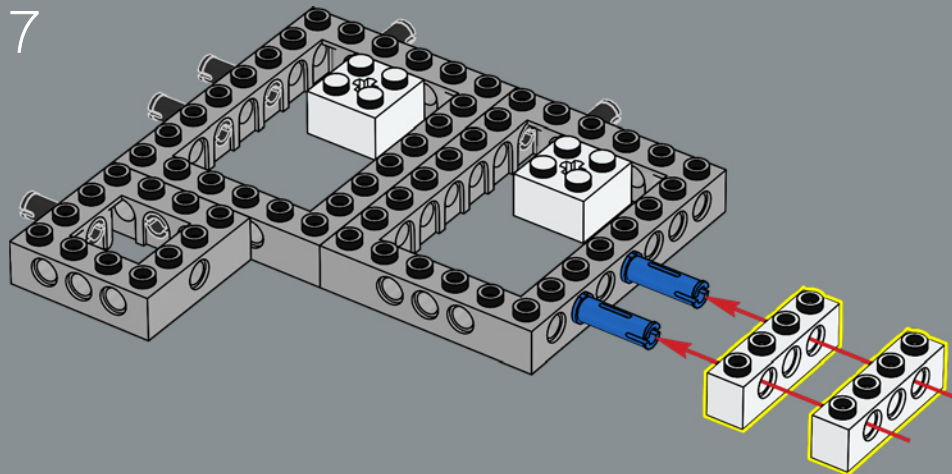

8

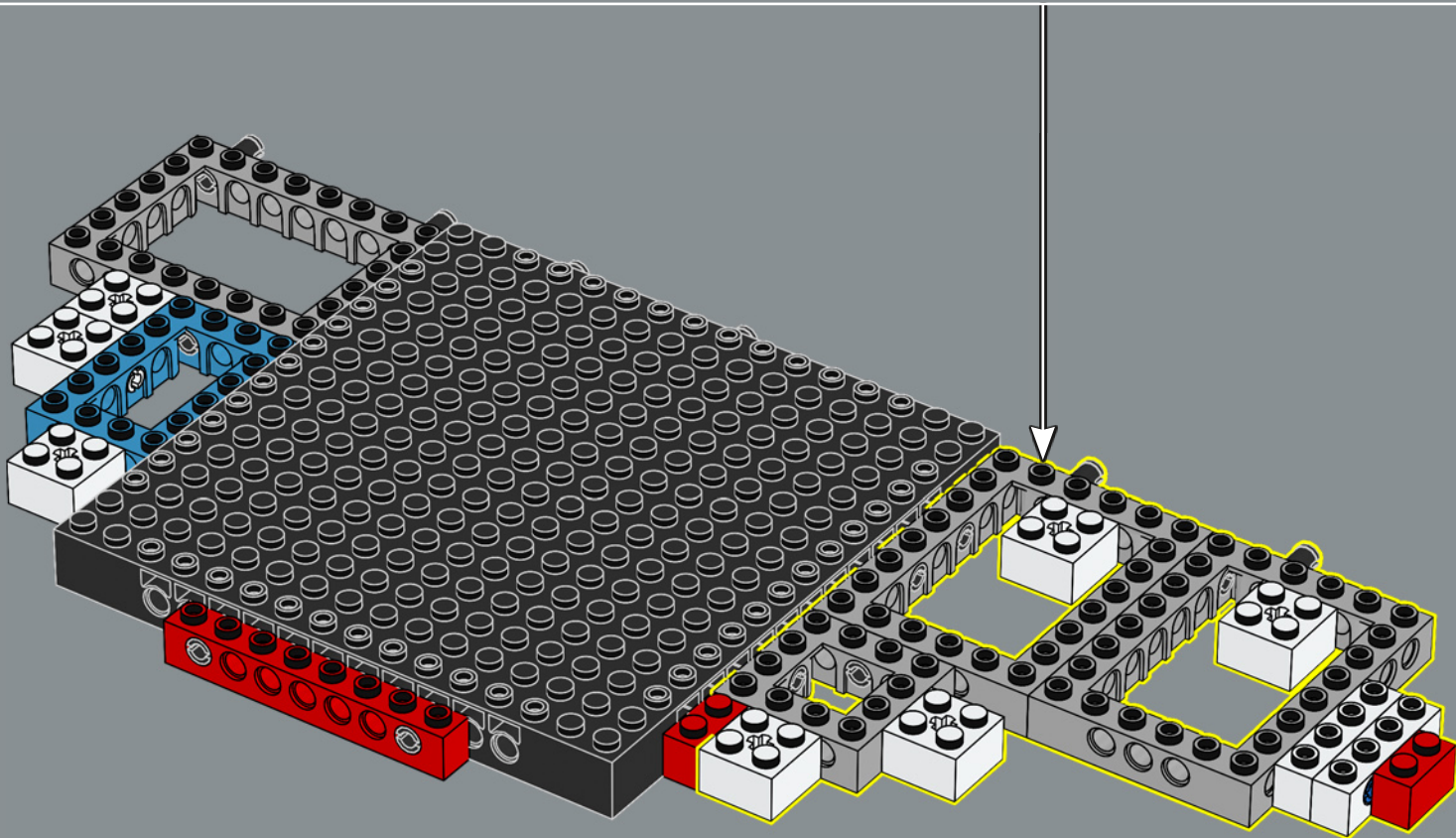
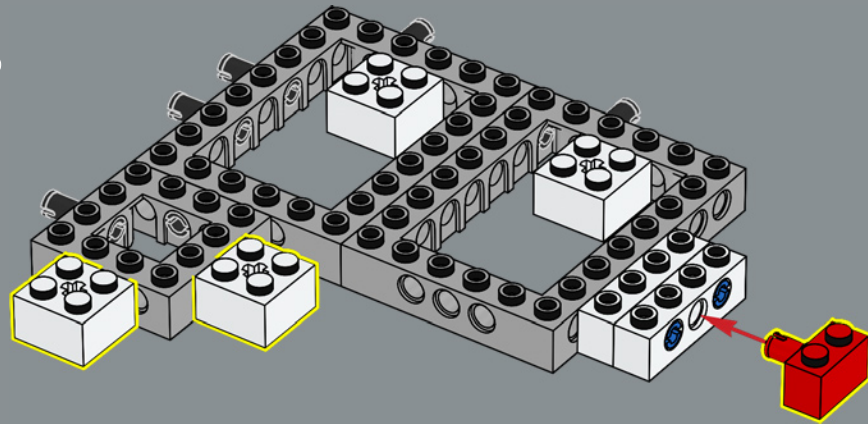

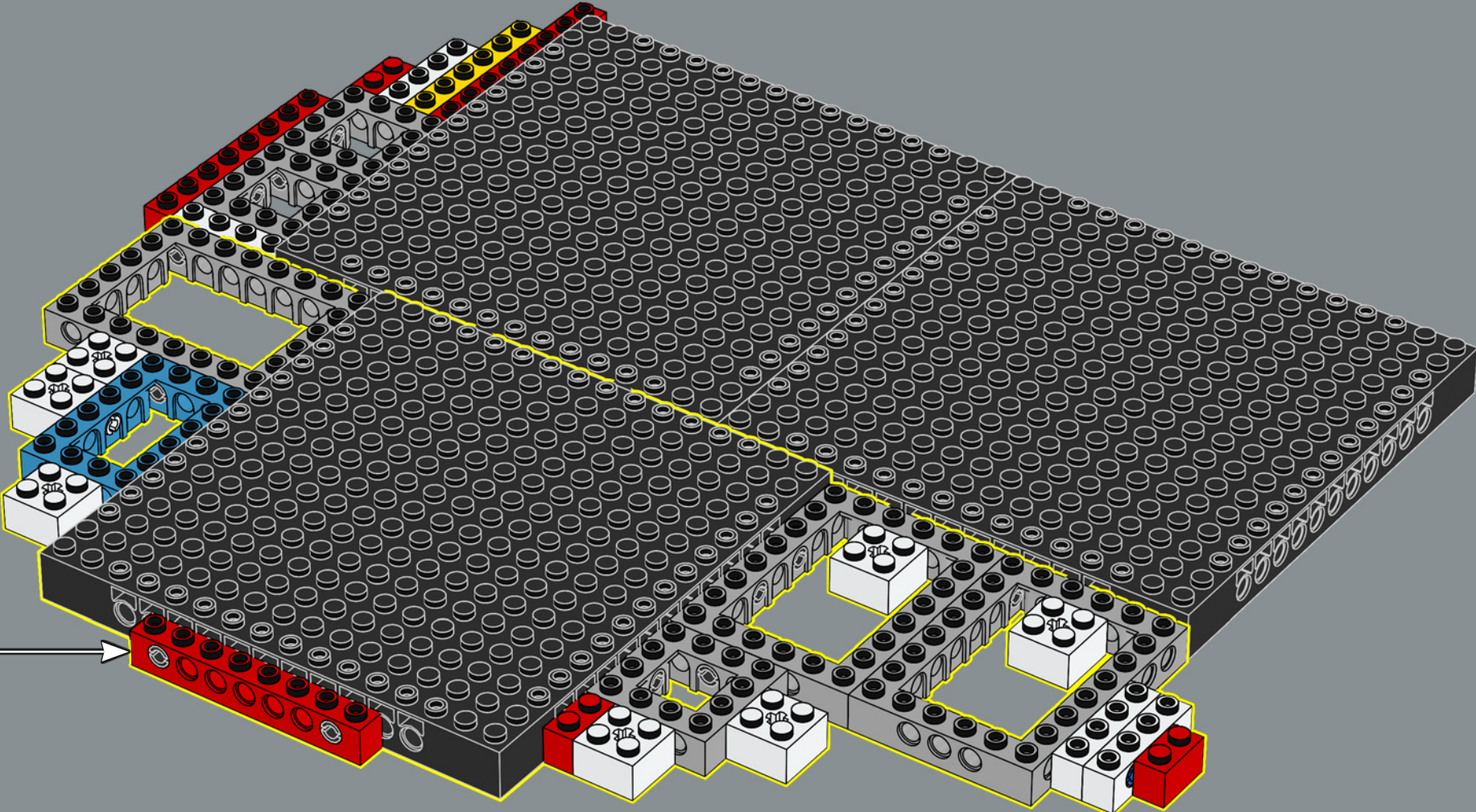

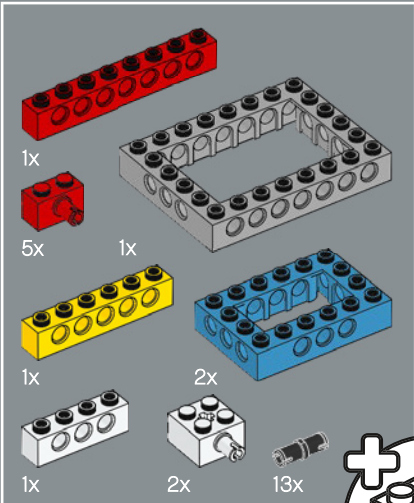
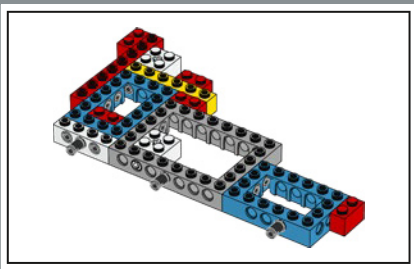

104

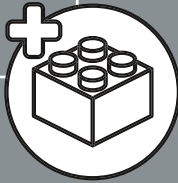

1

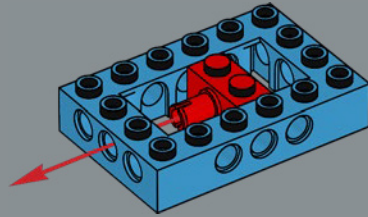

2

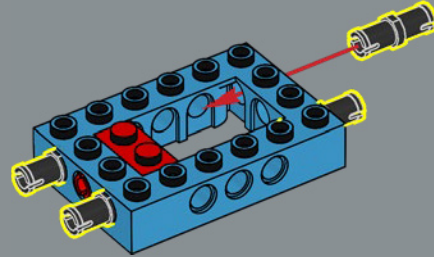

3

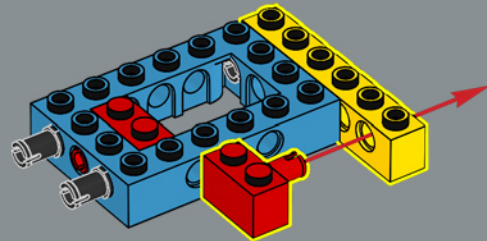

1

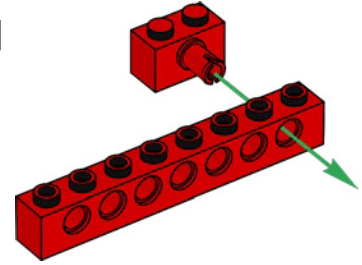

2

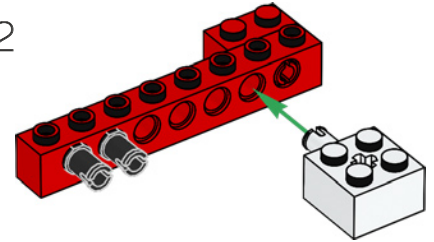

4

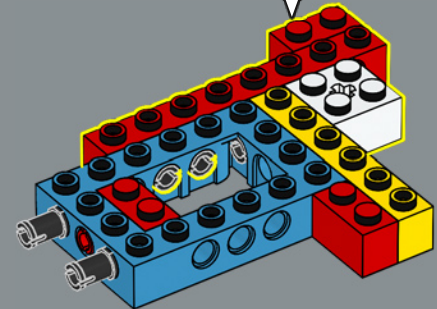

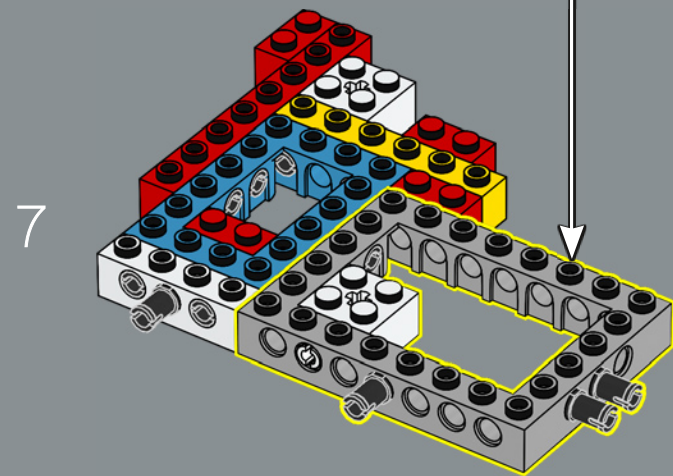
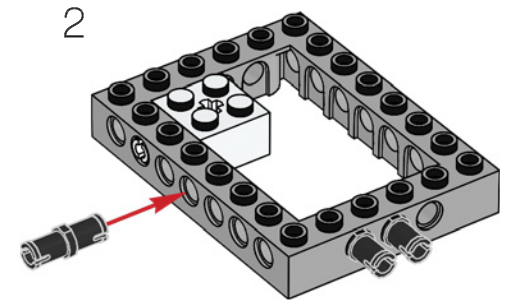
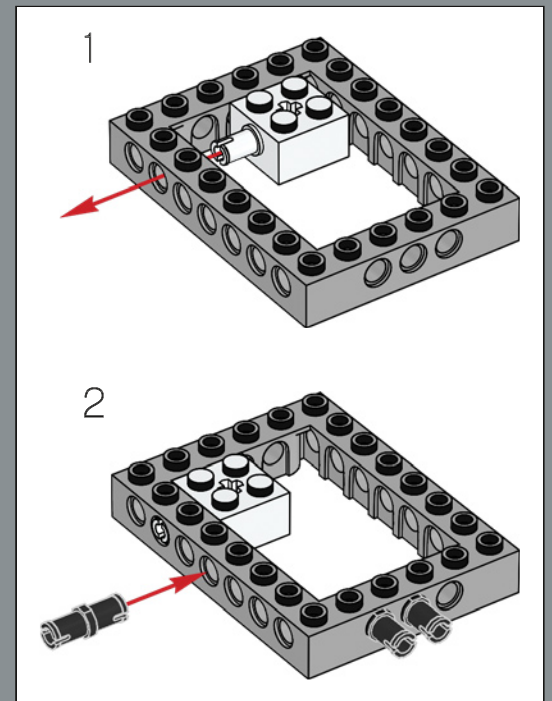
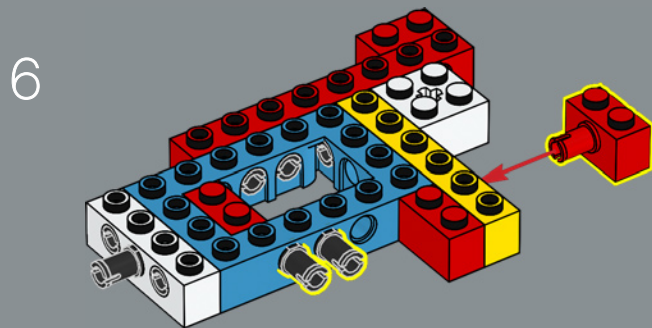
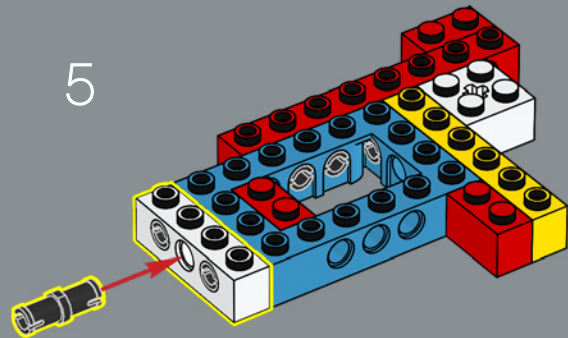

8

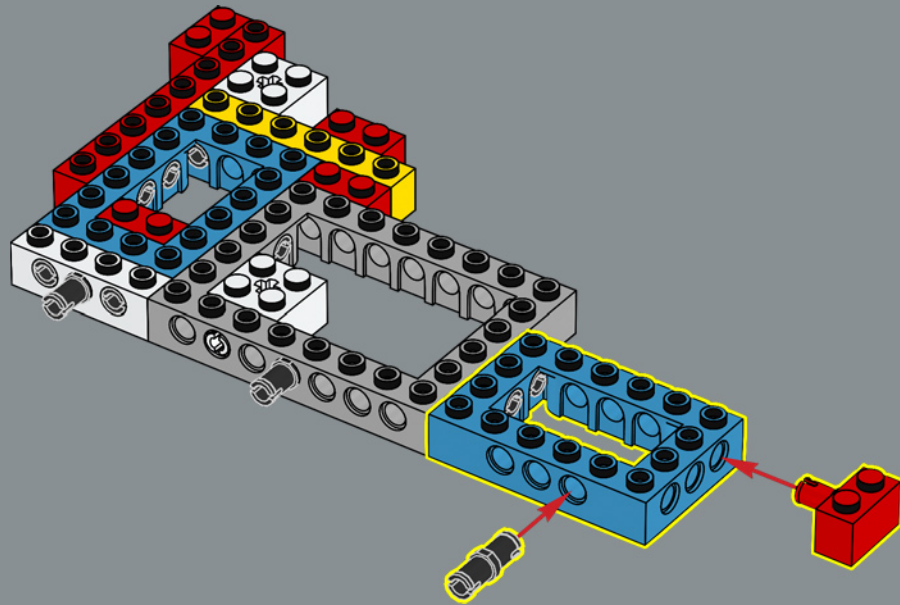

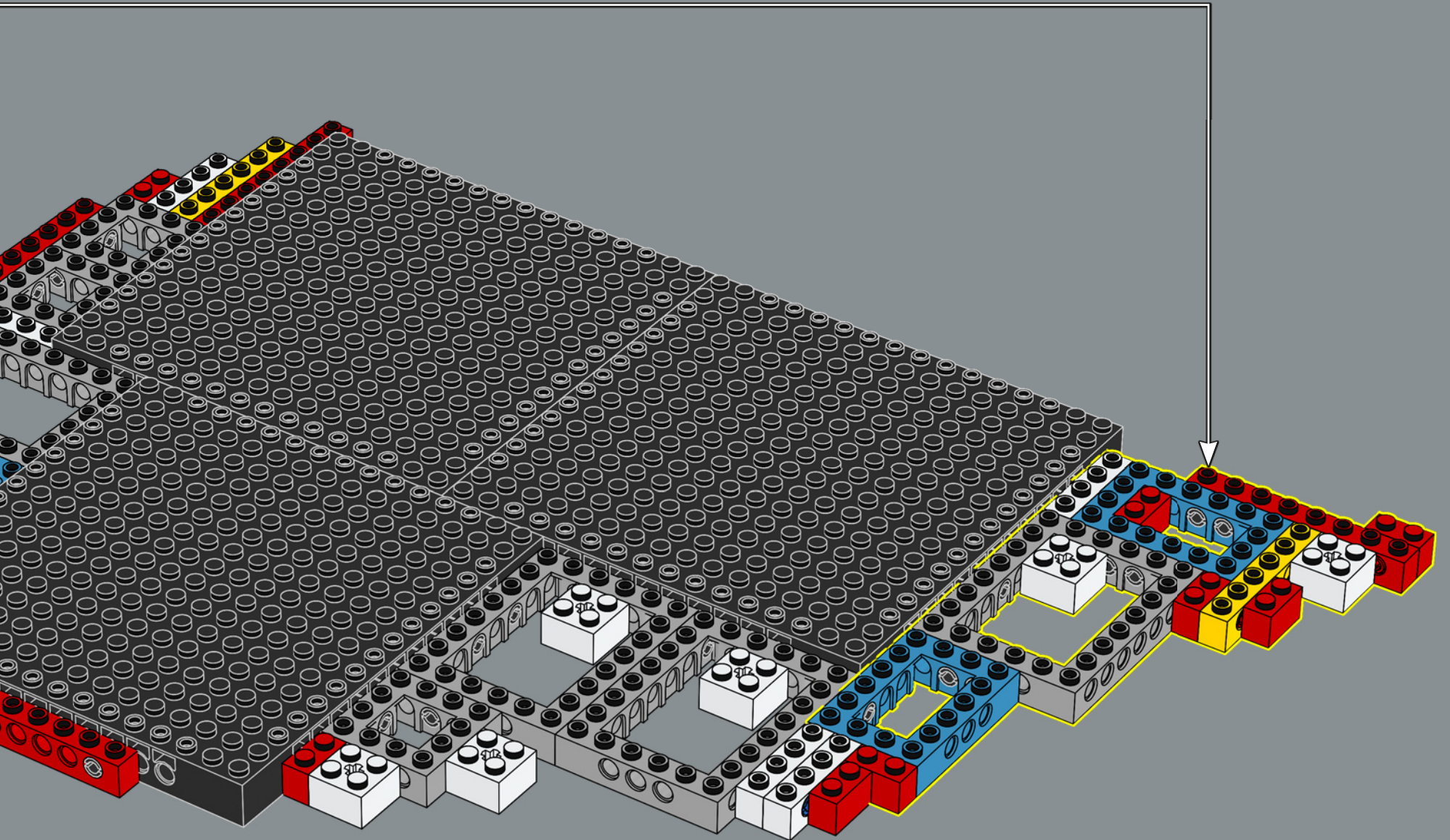

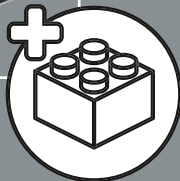
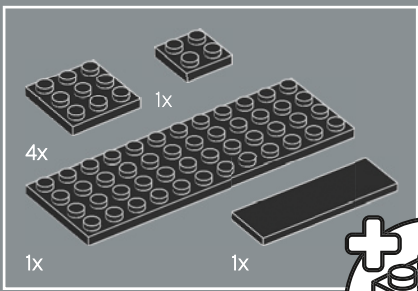

105

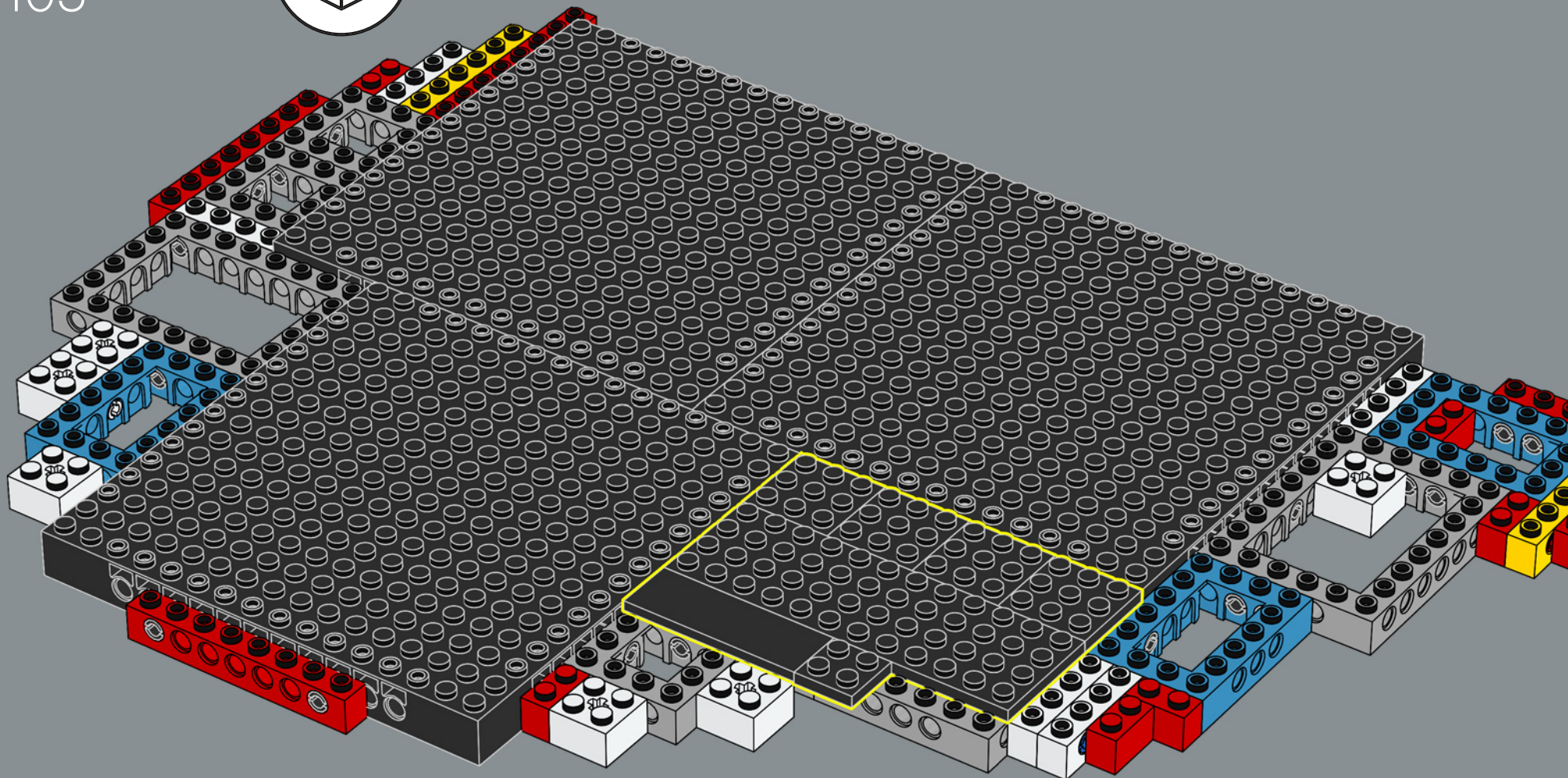



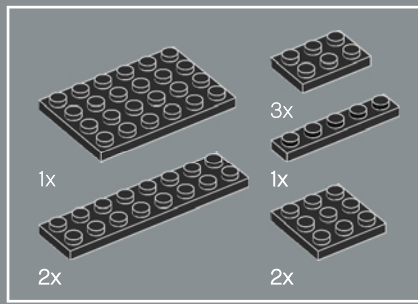

106

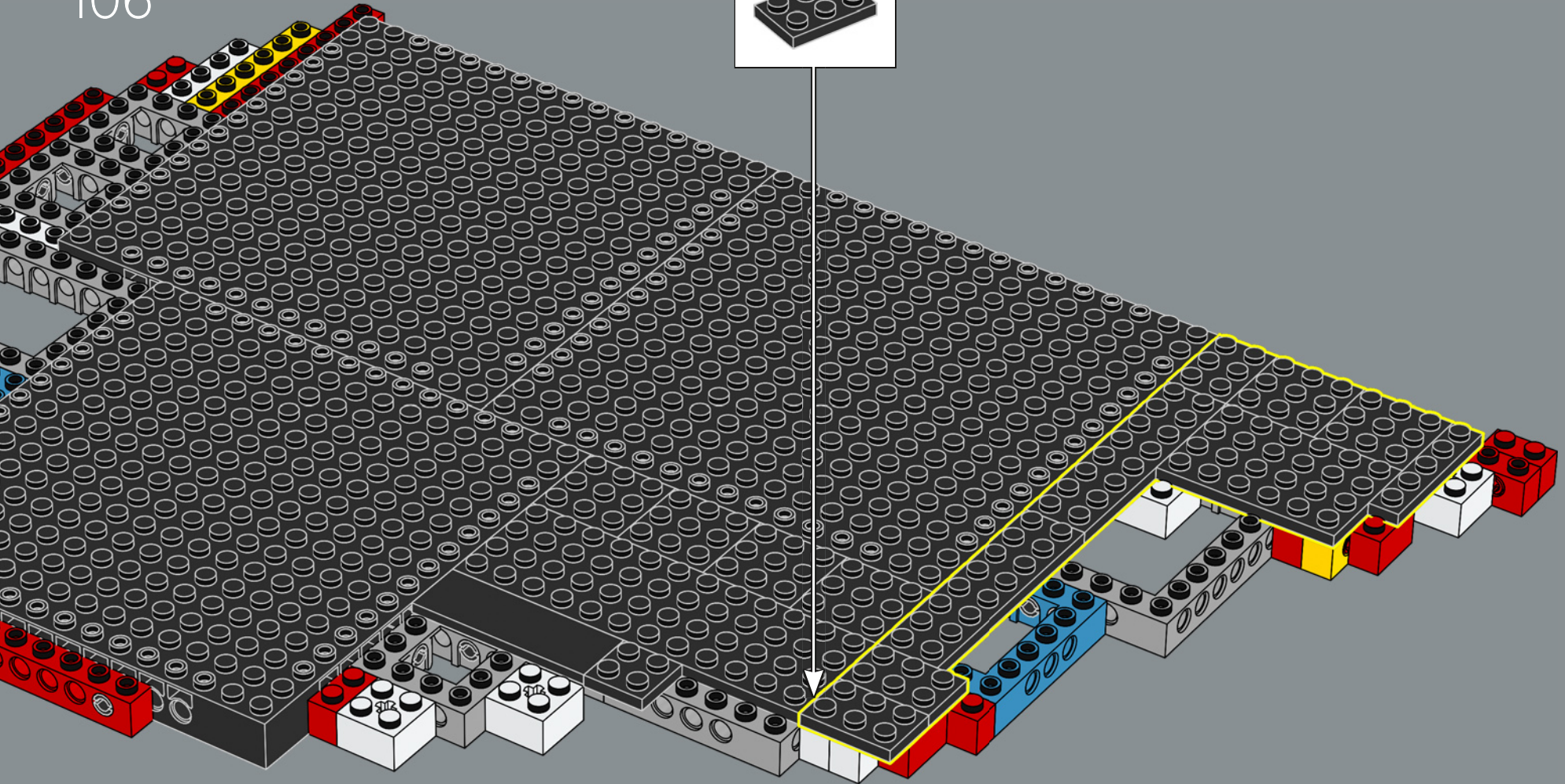
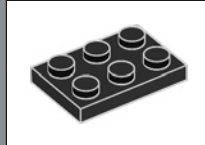

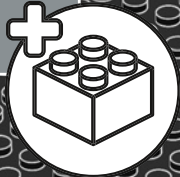
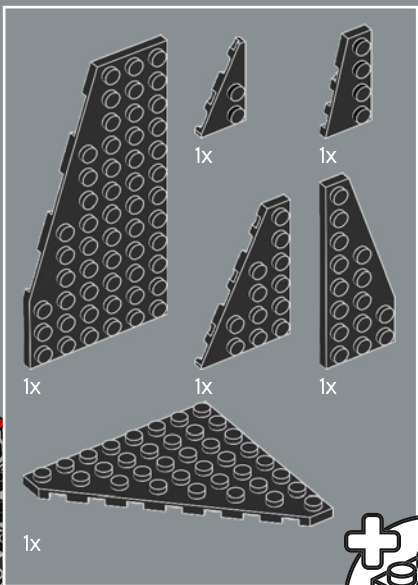

107

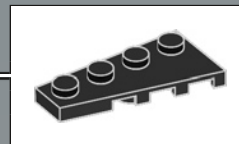
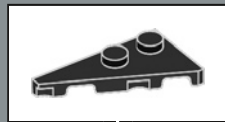

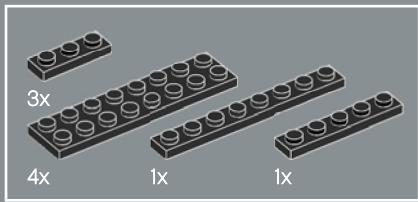

108

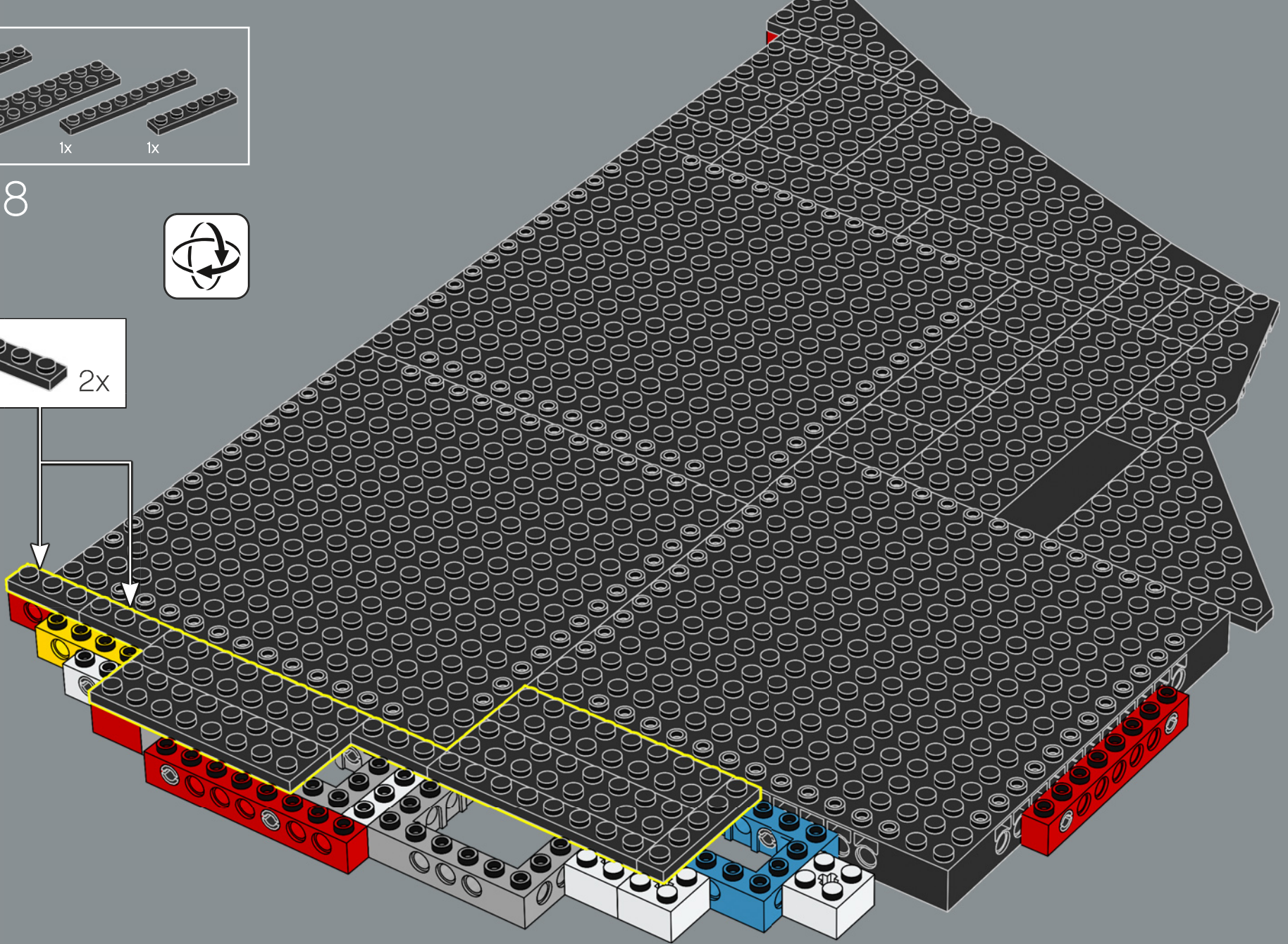
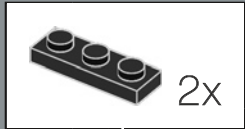

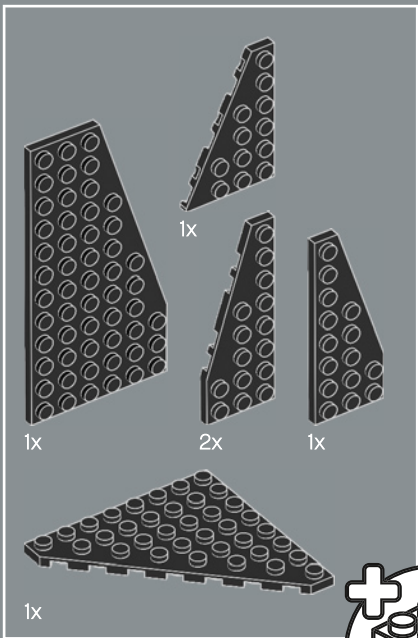

109

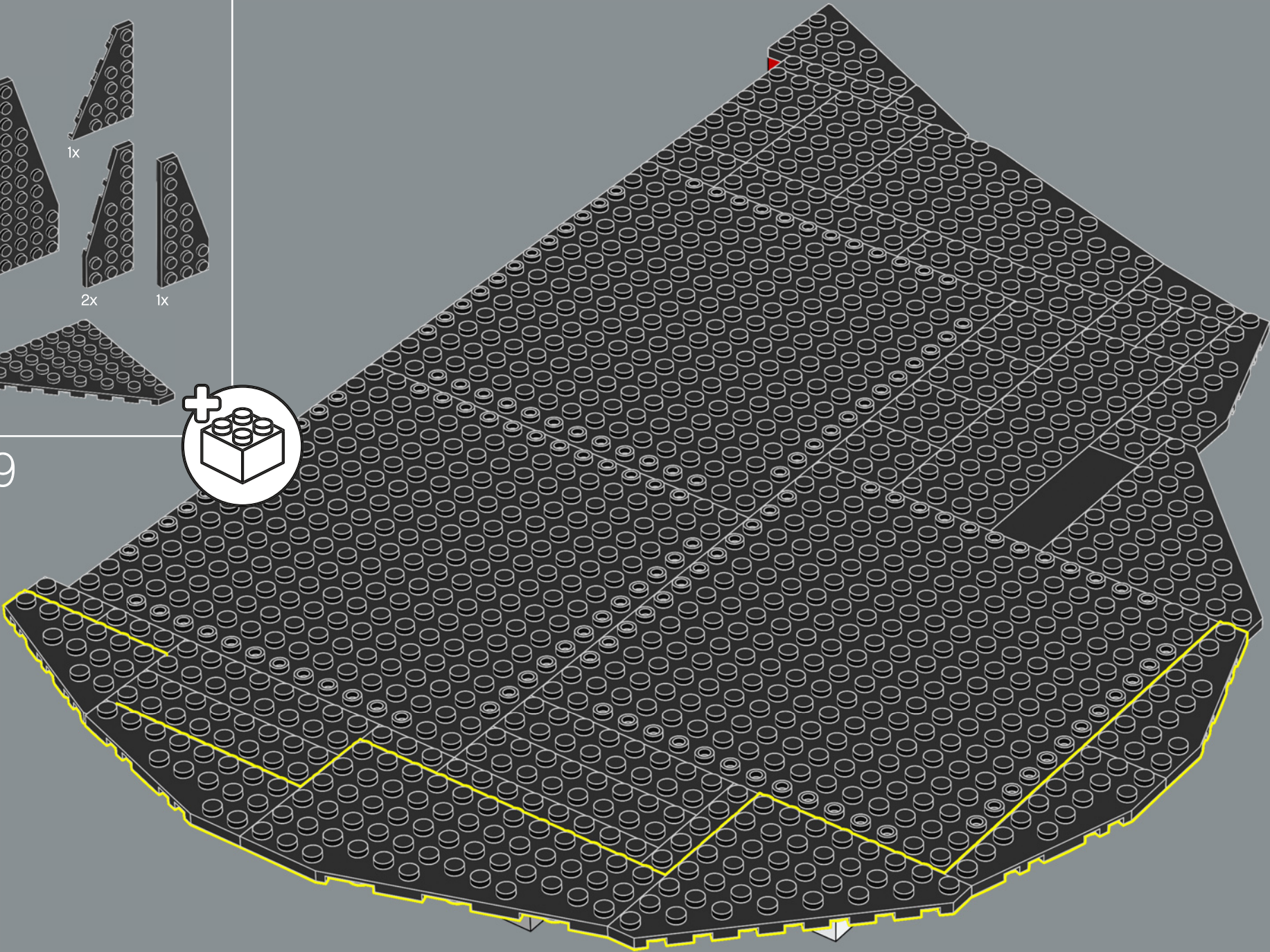

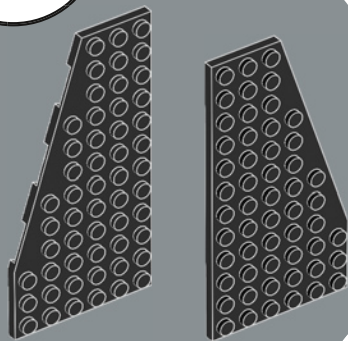
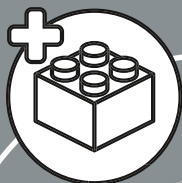

1x

1x



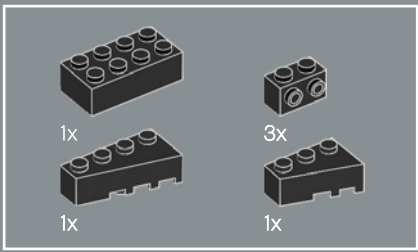

110

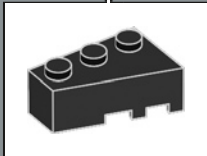
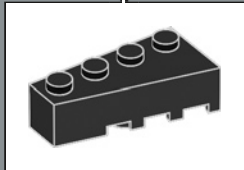
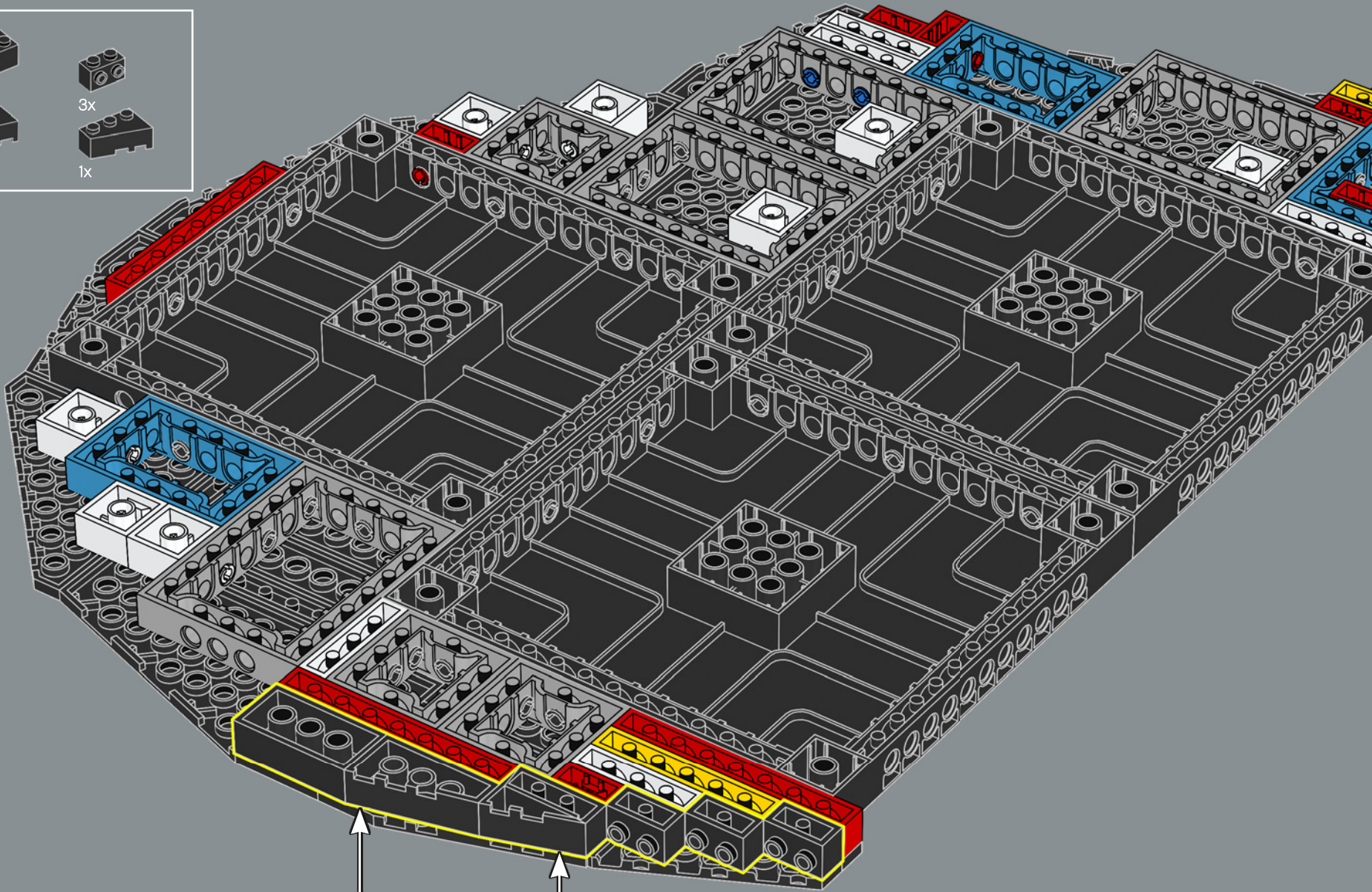

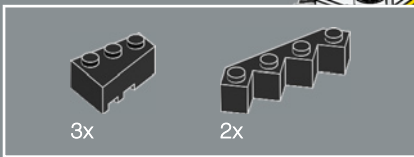

111

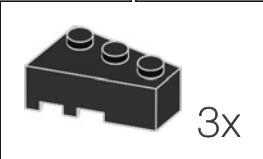
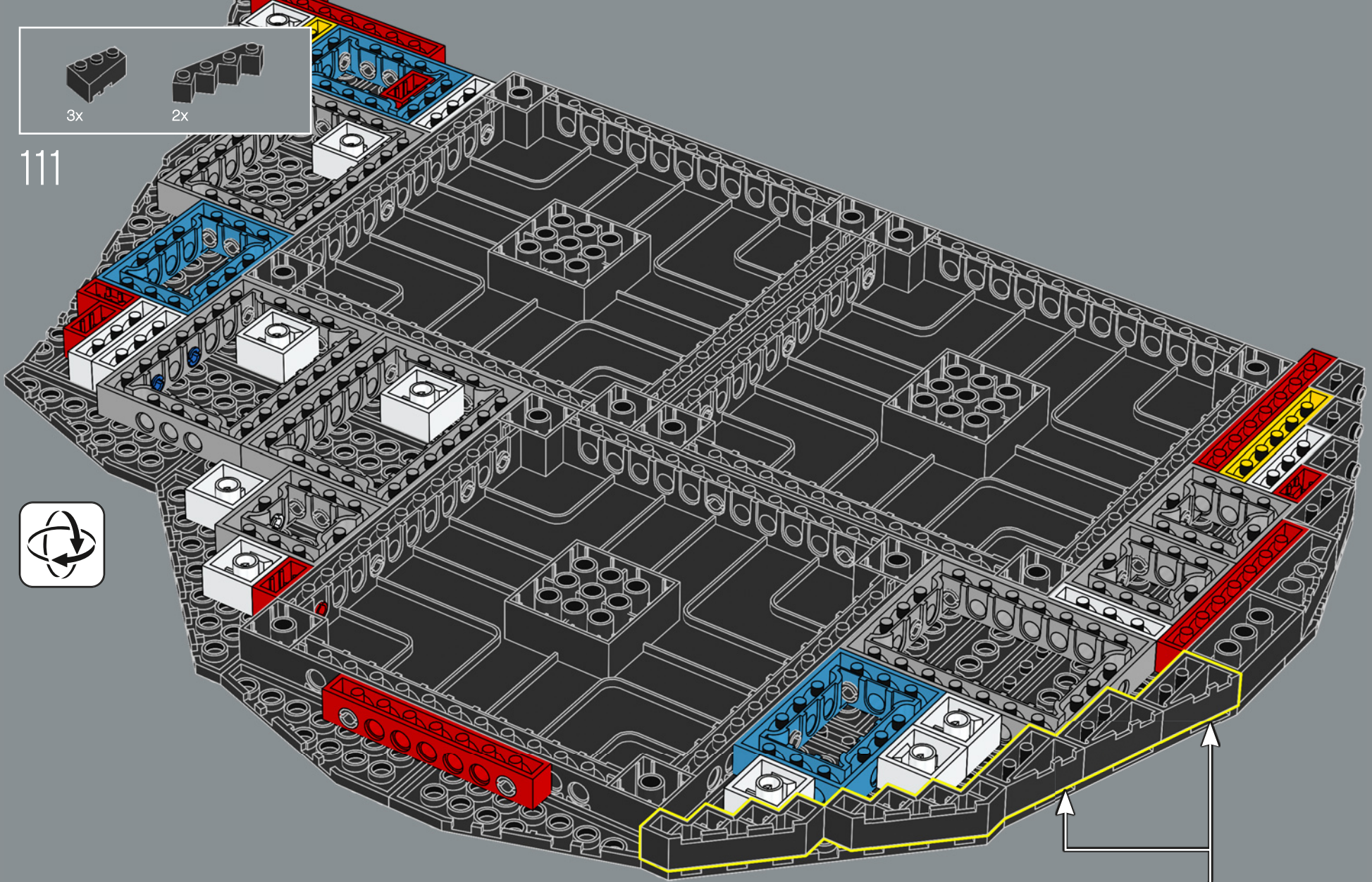

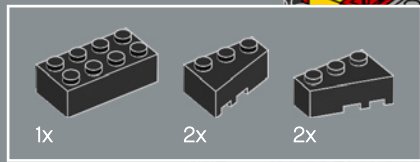

112

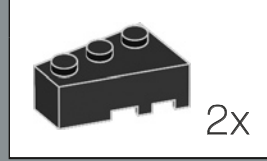
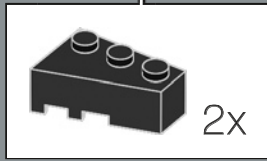
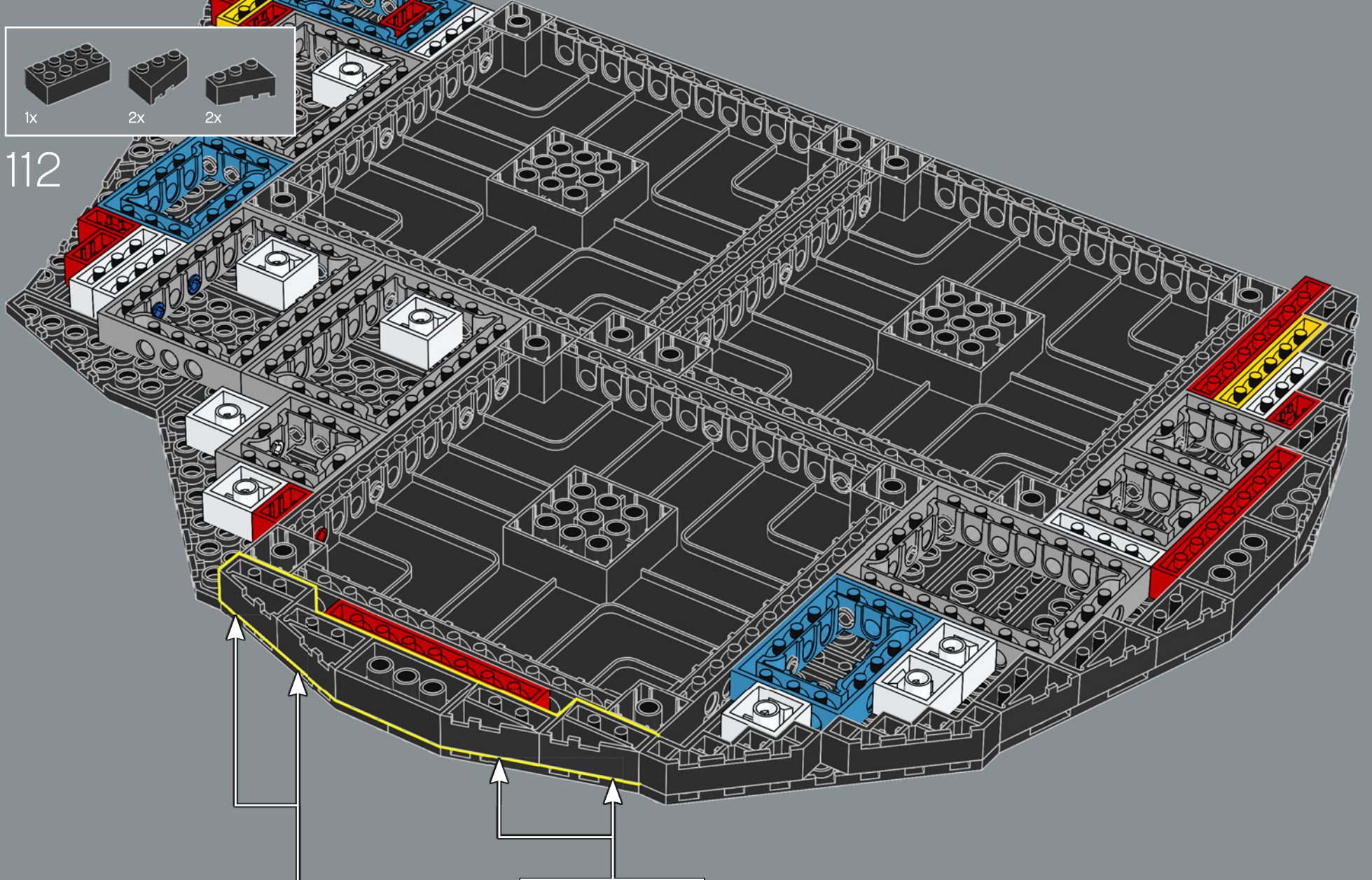



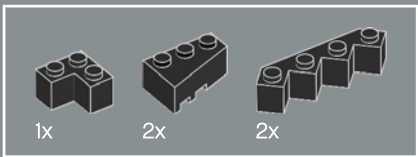

113

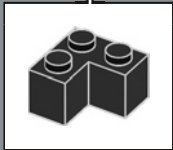
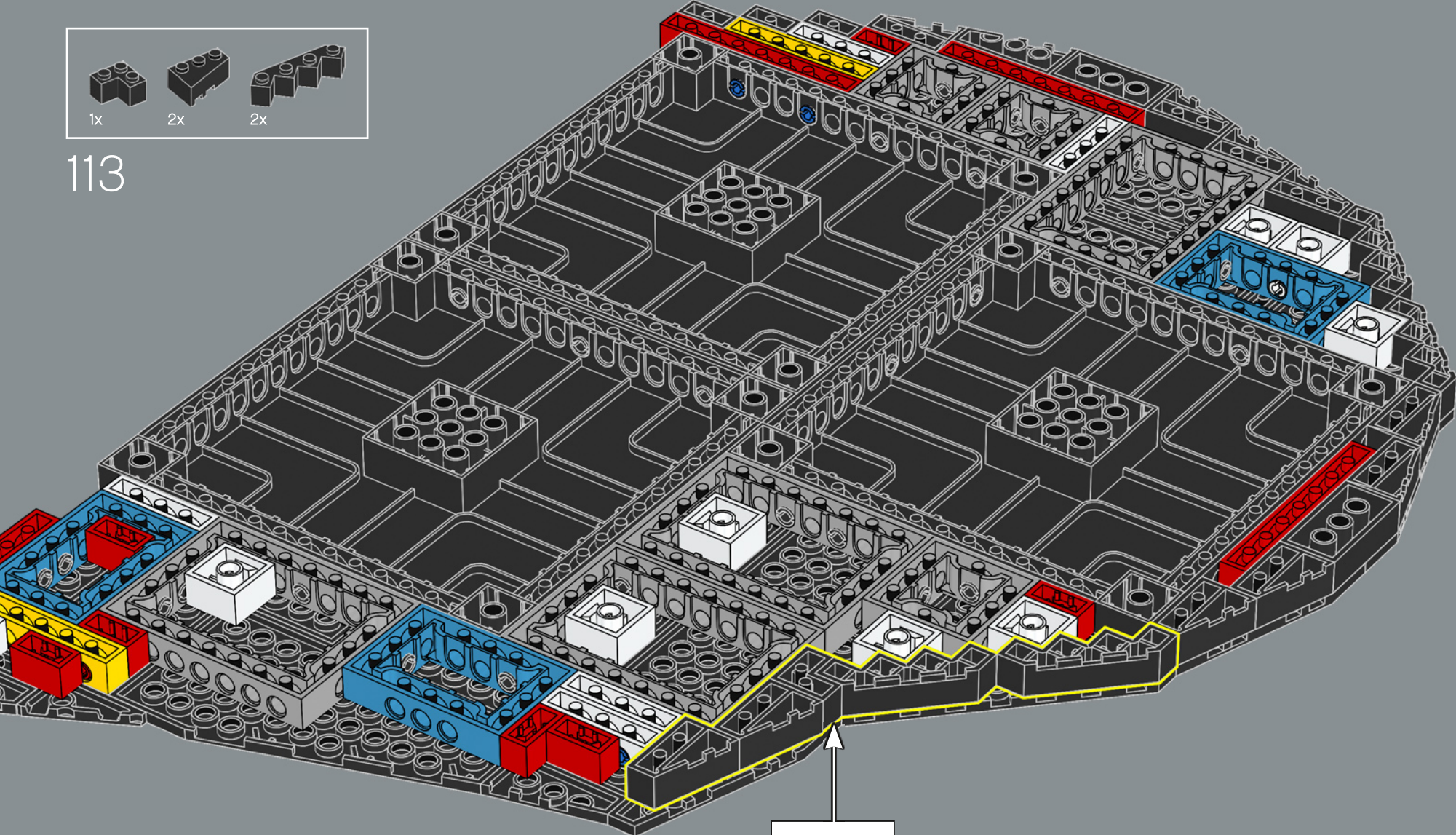

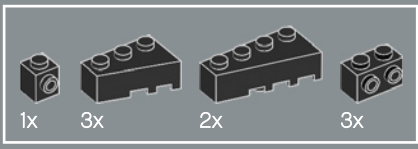

114

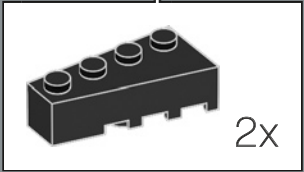
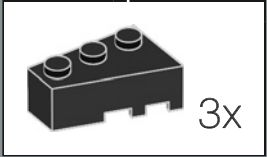
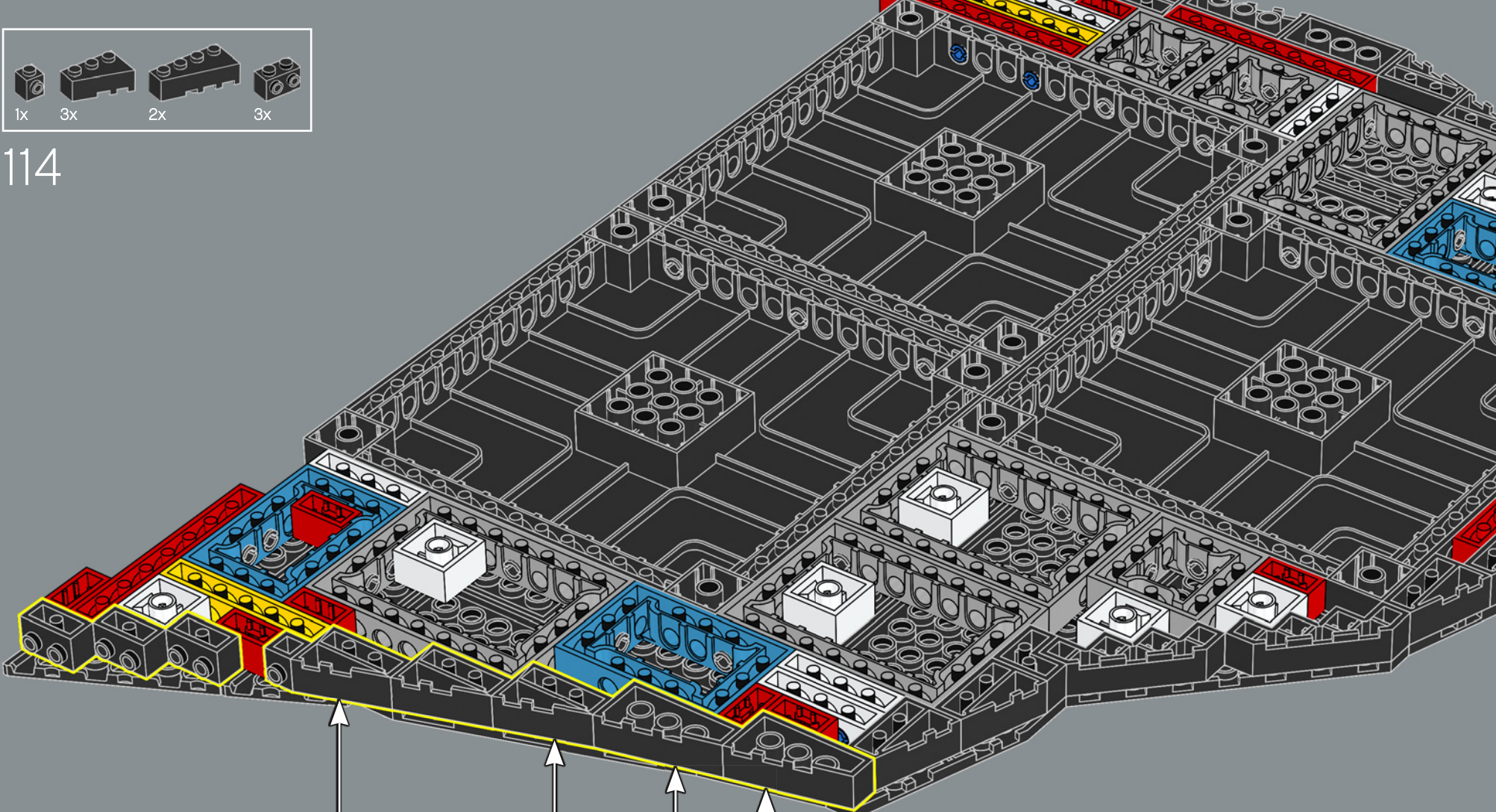



115

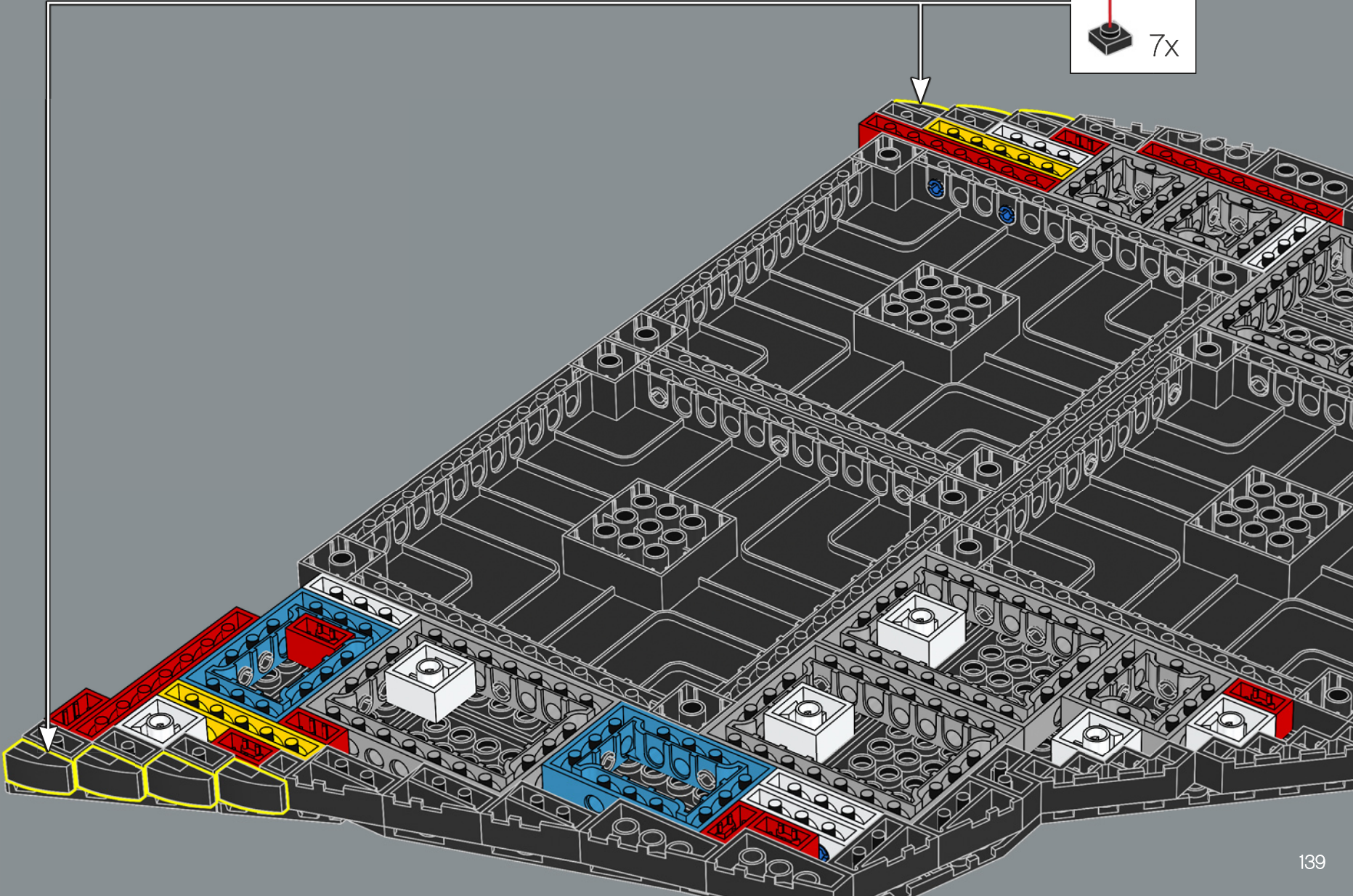
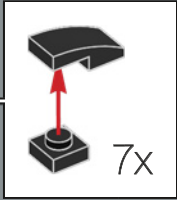

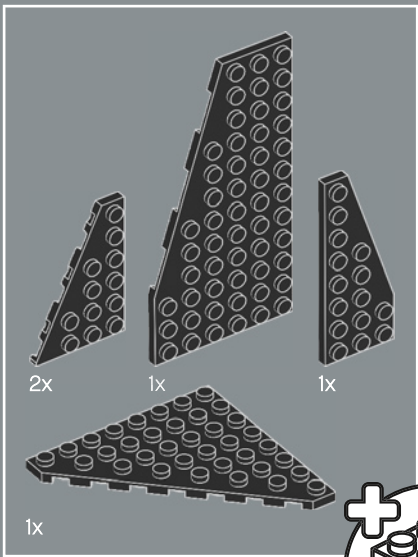

116

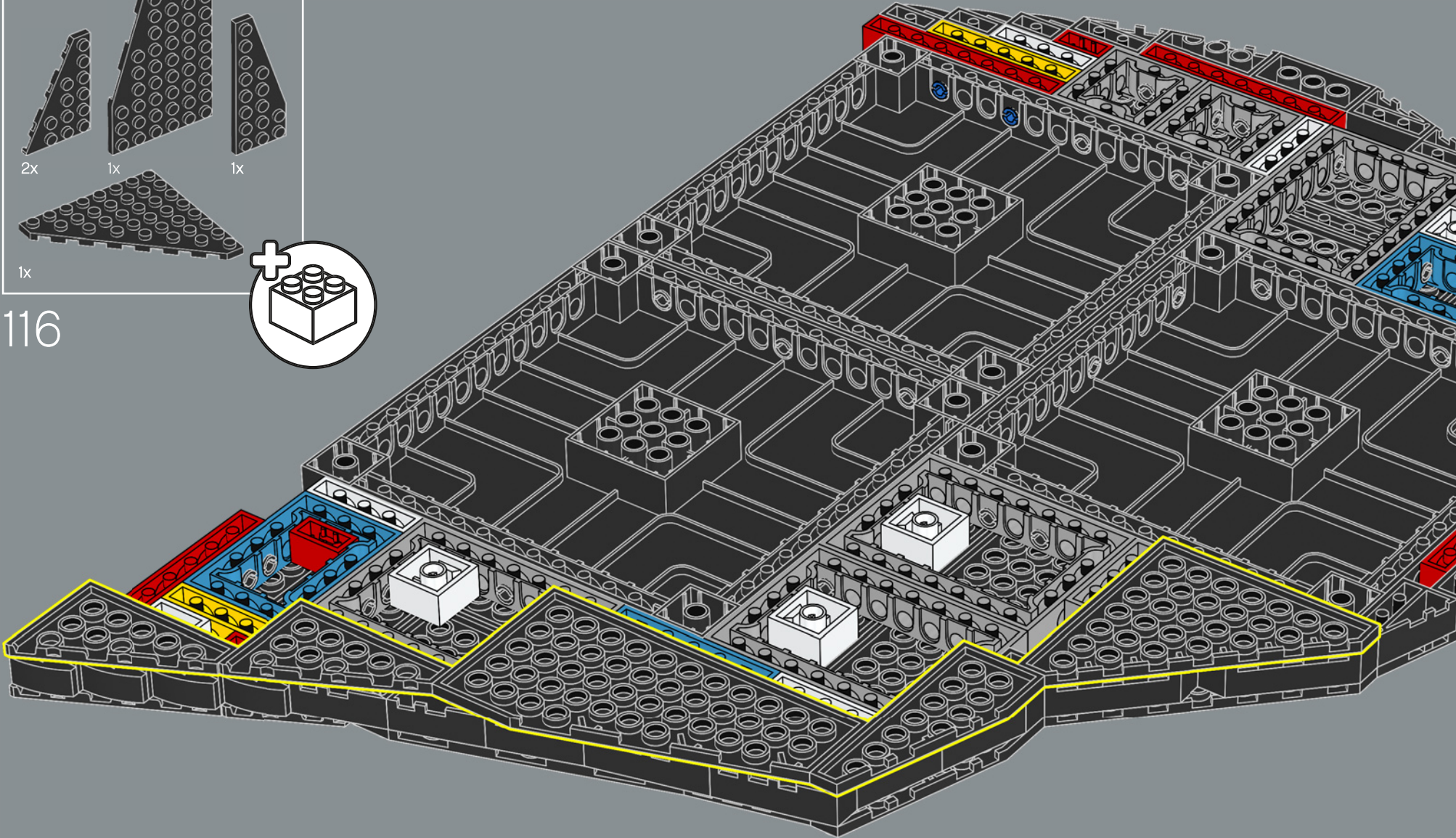
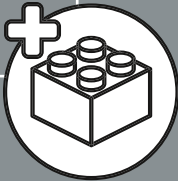

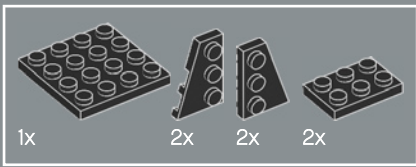

117

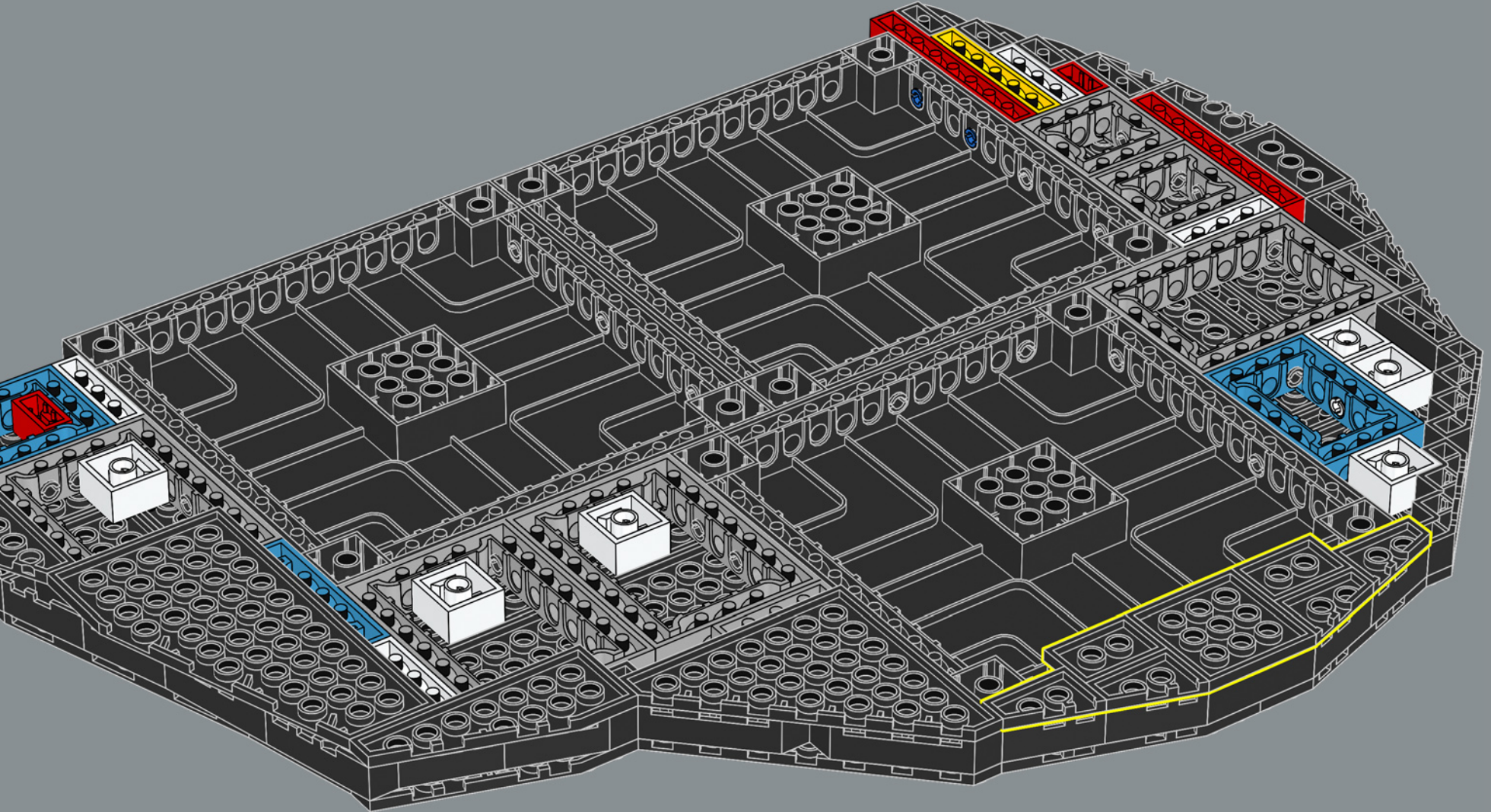

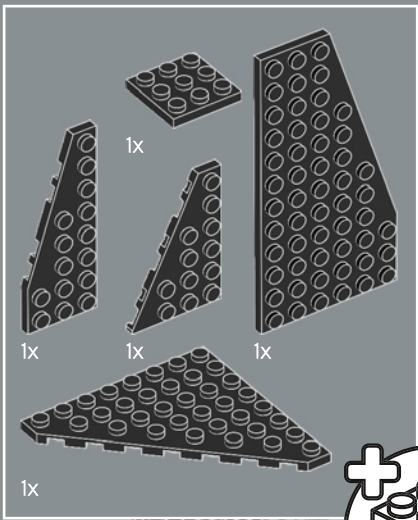

118

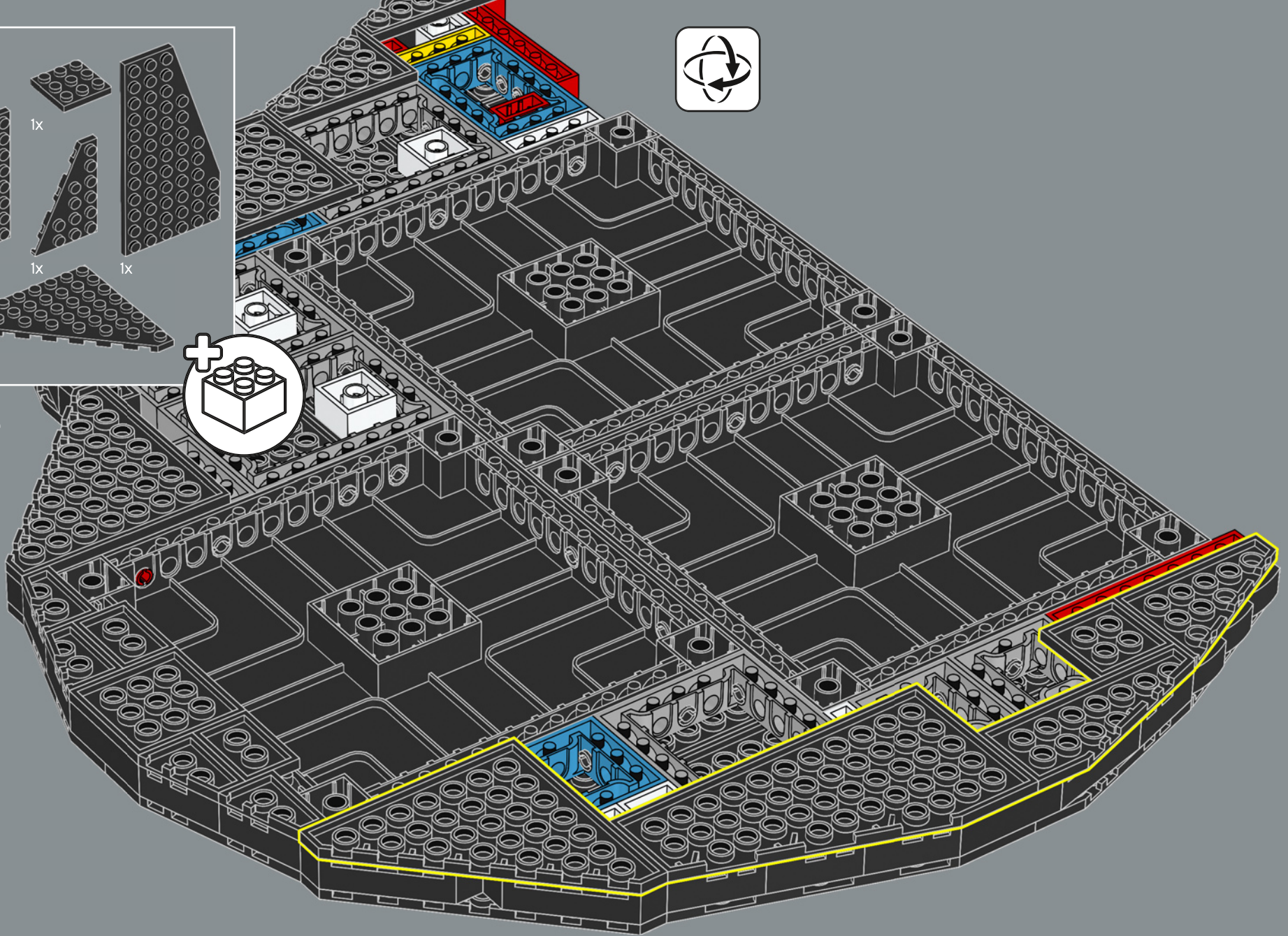
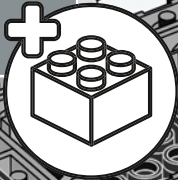

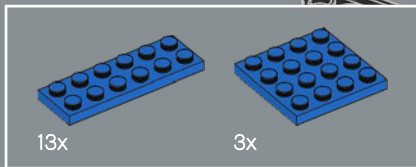

119

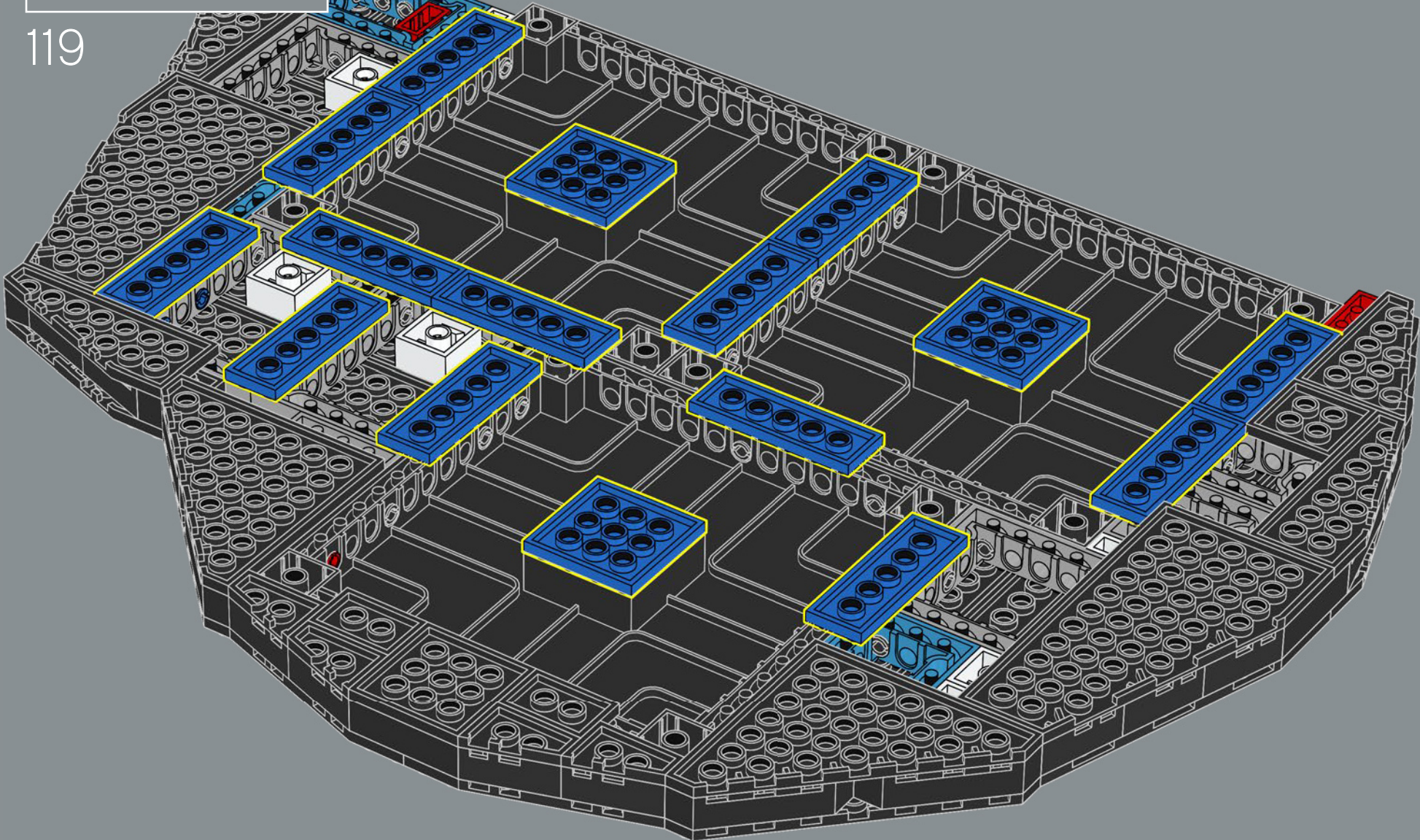





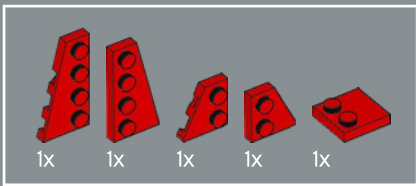

120

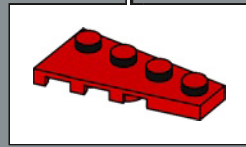
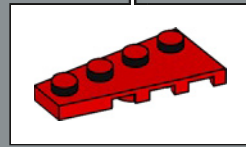
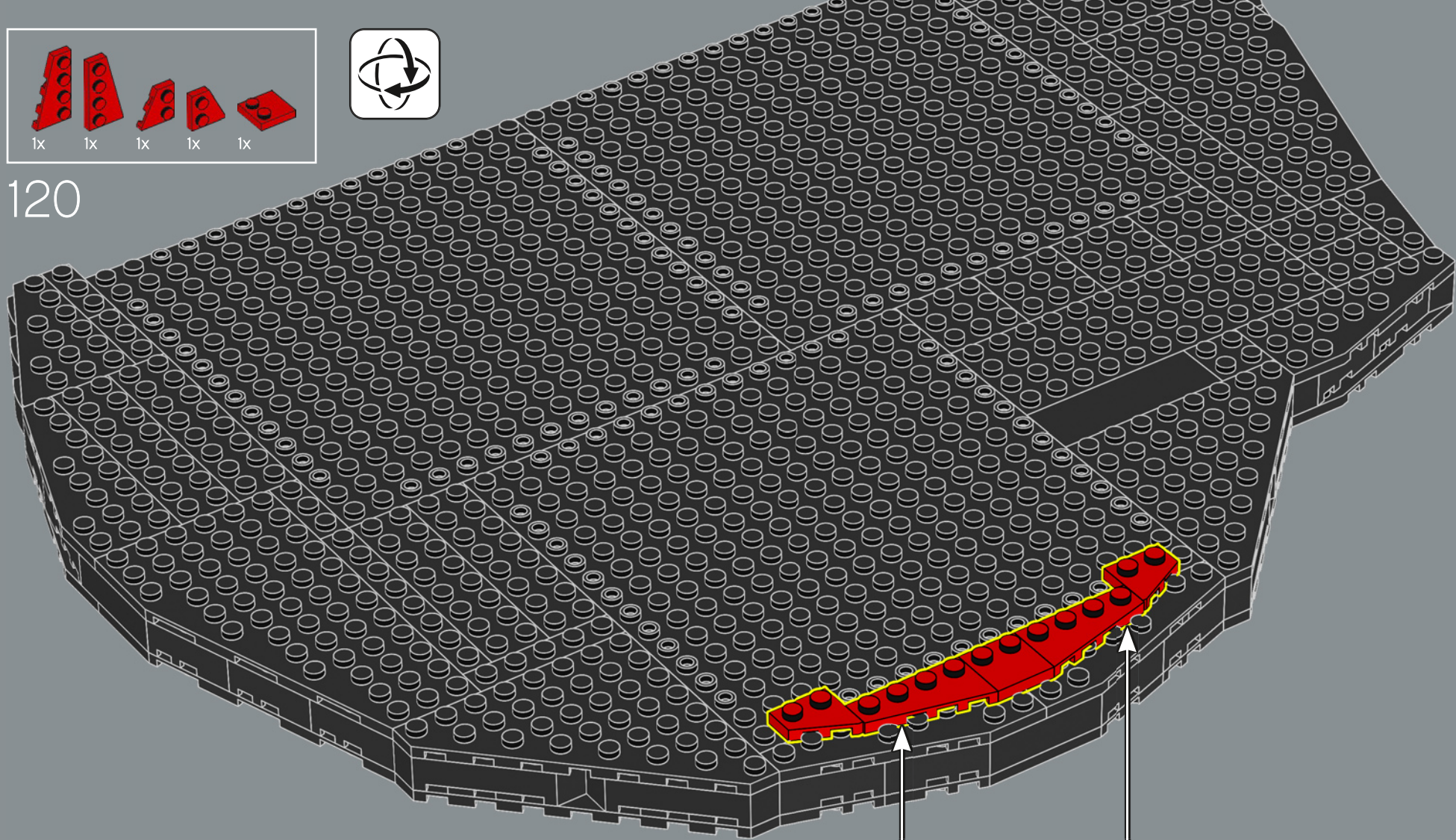

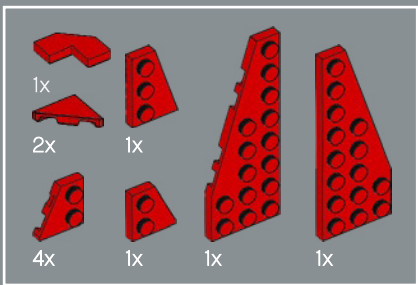

121

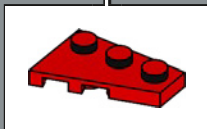
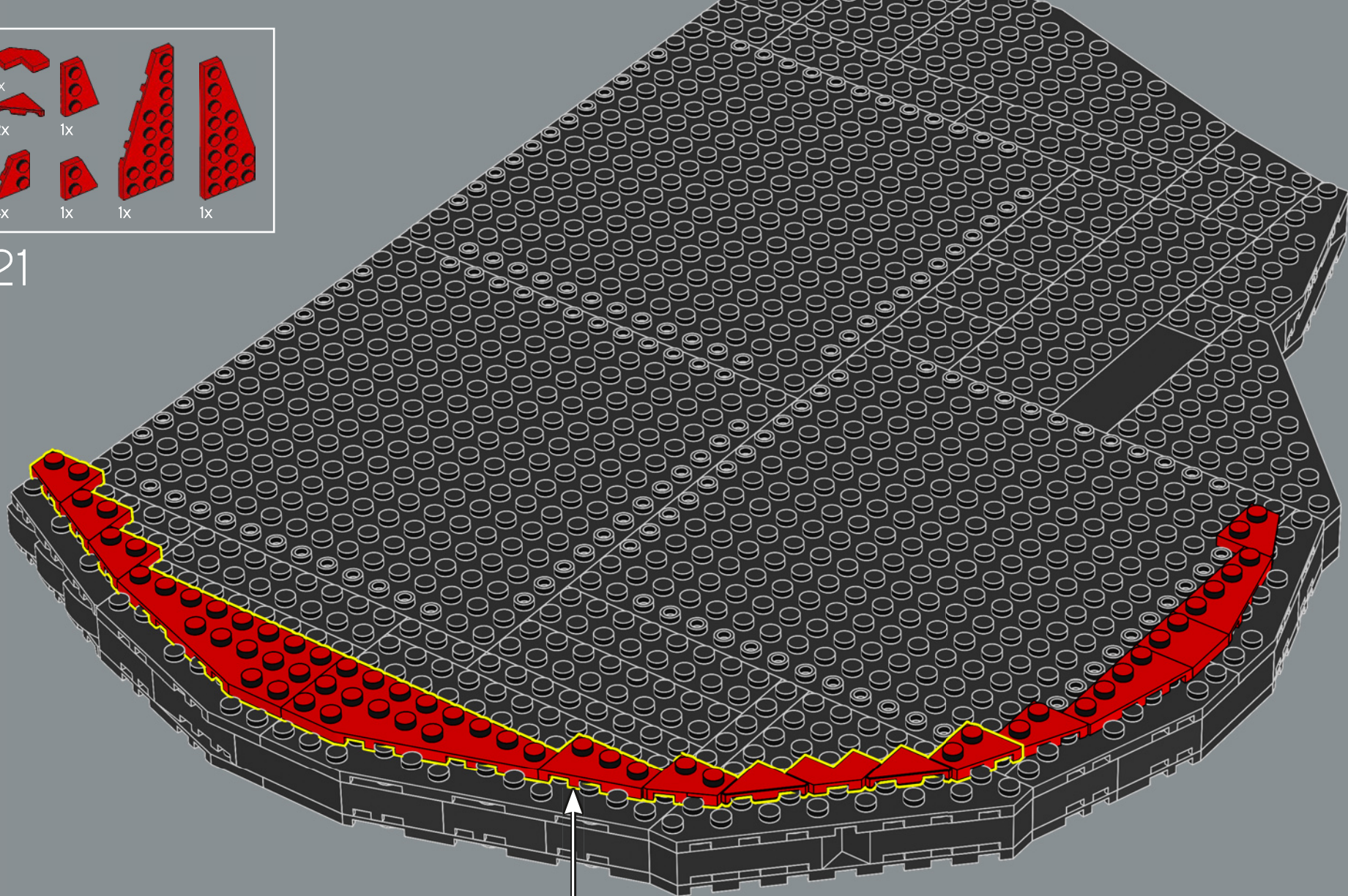

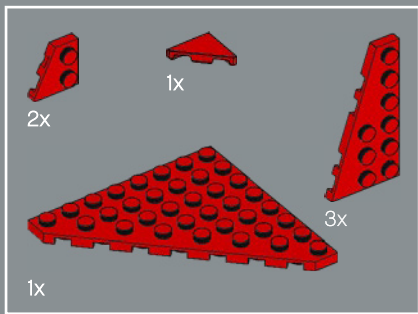

122

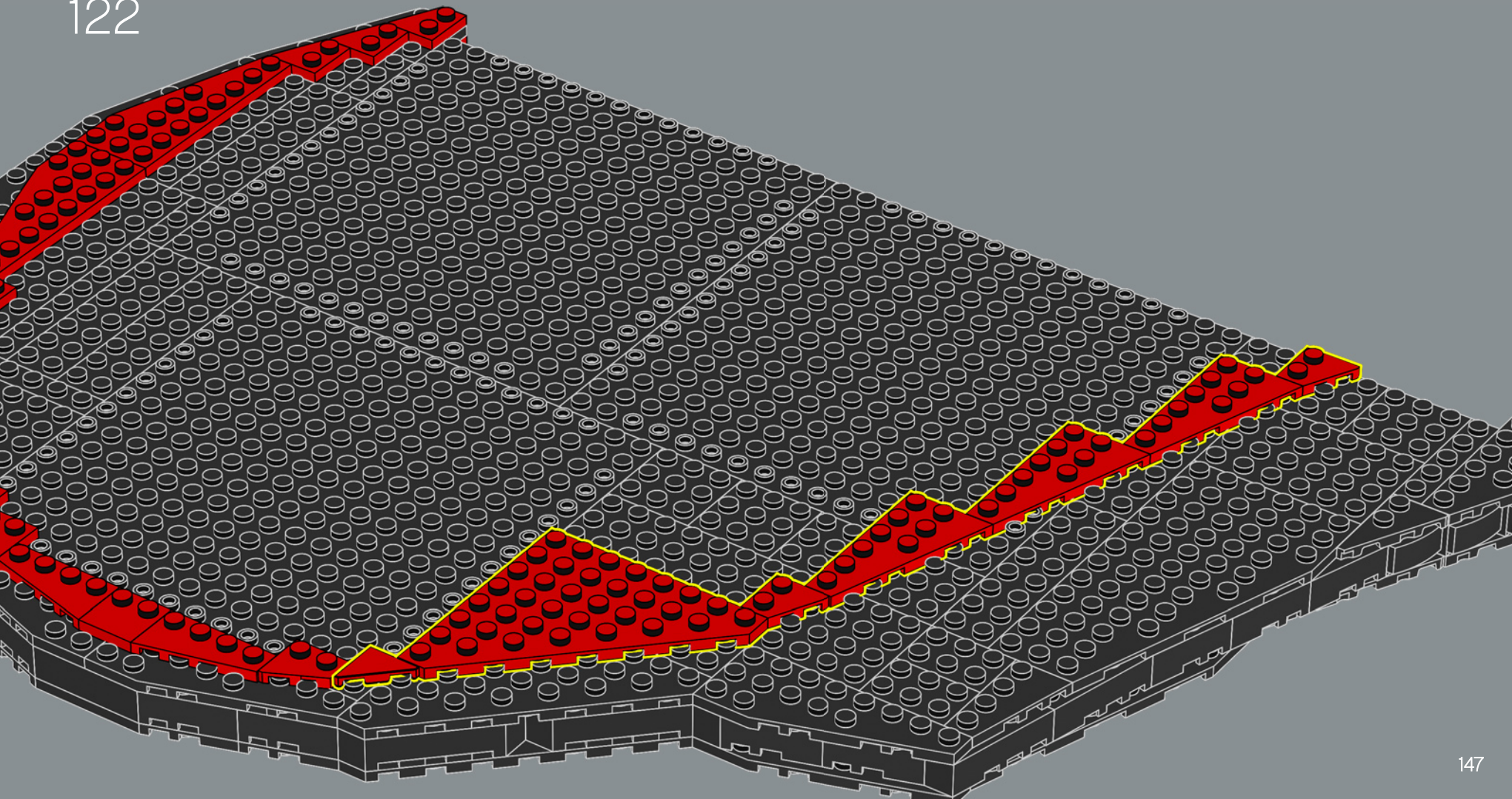

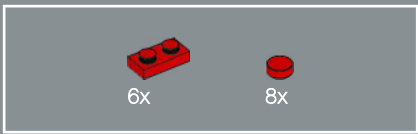

123

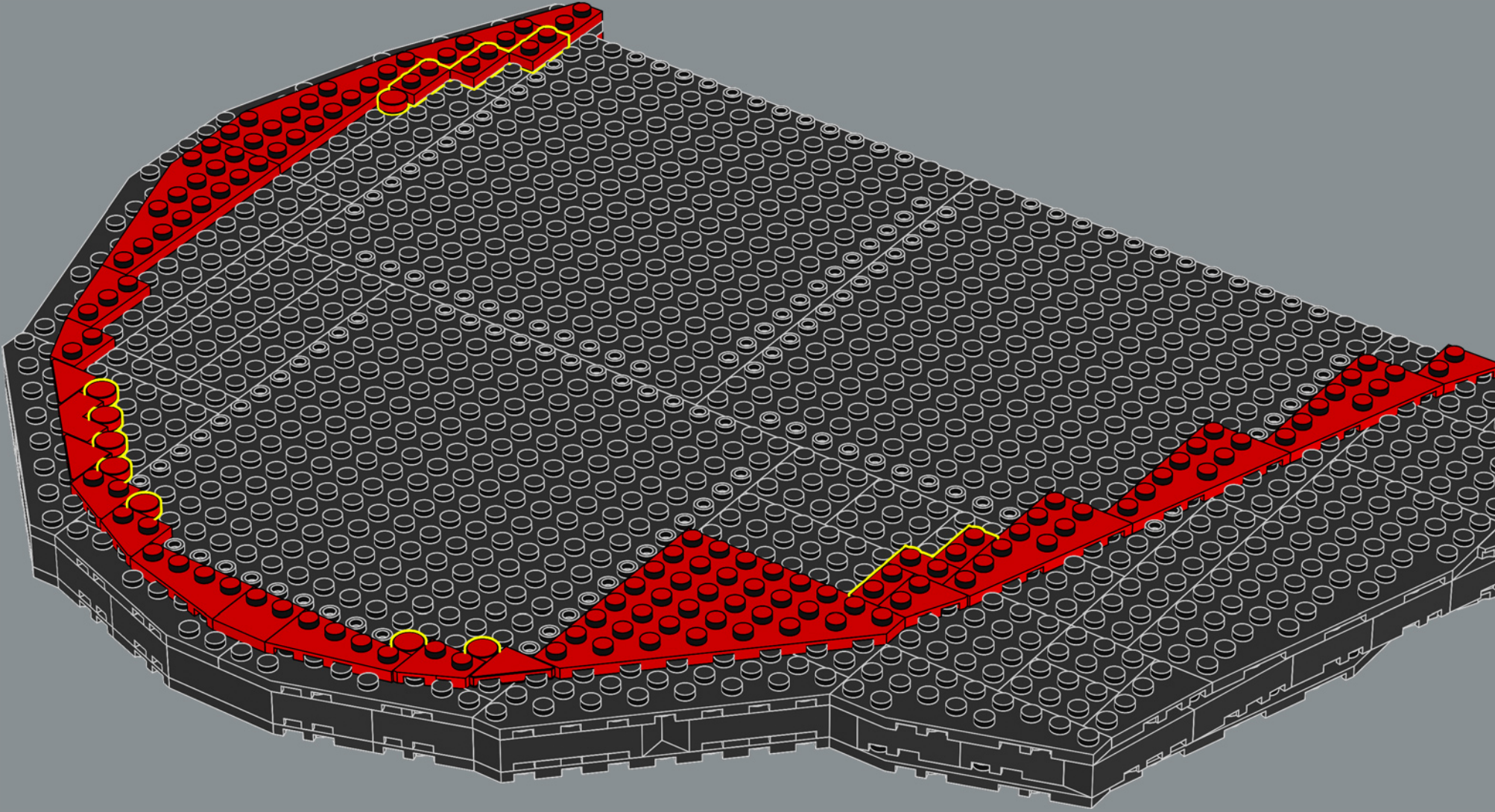

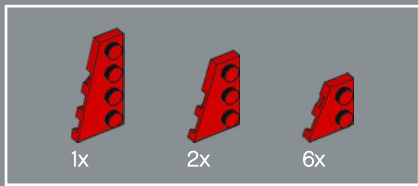

124

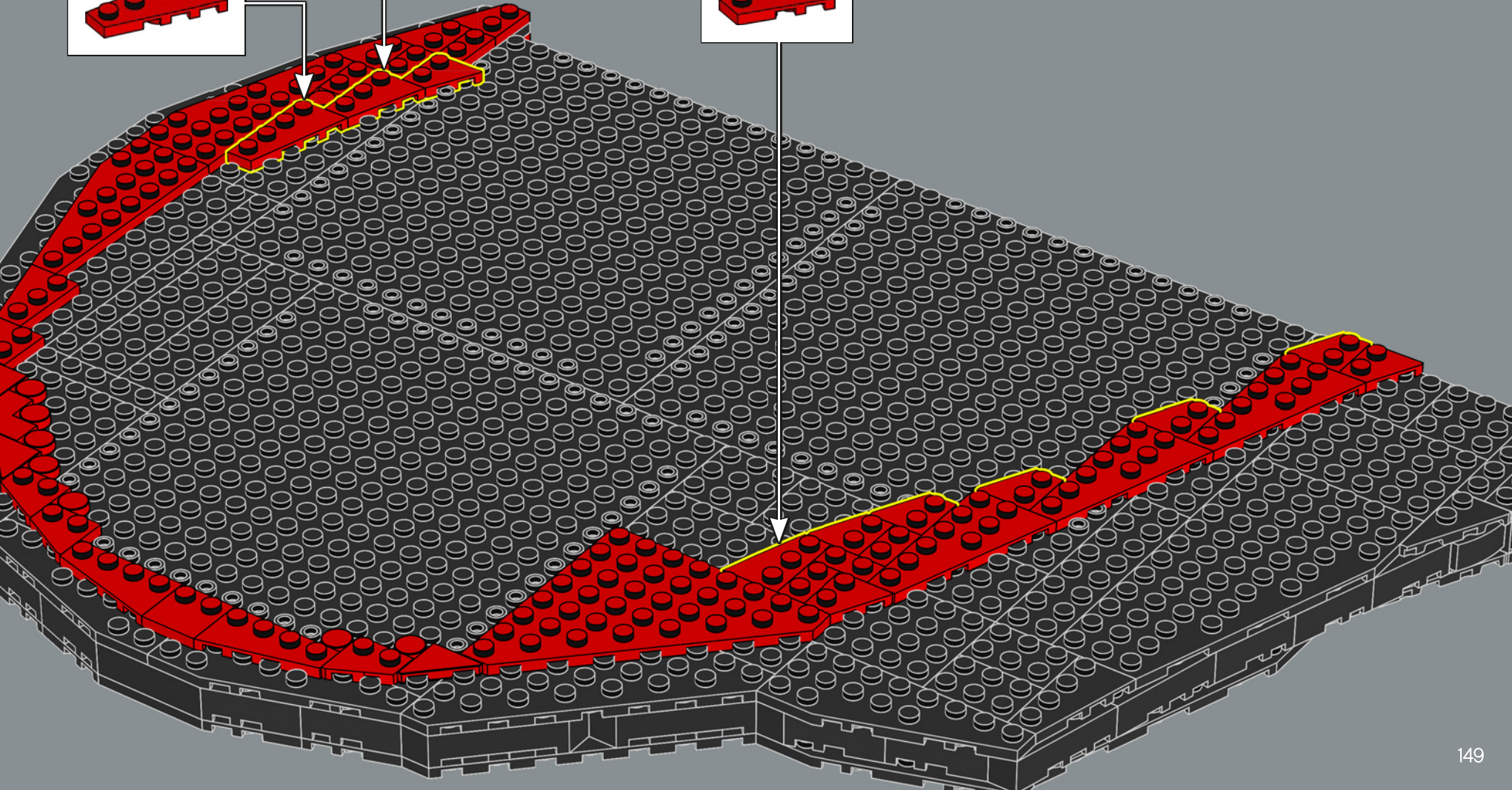
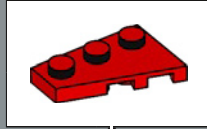
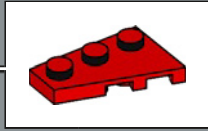
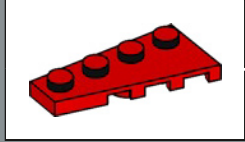

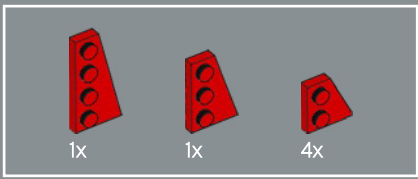

125

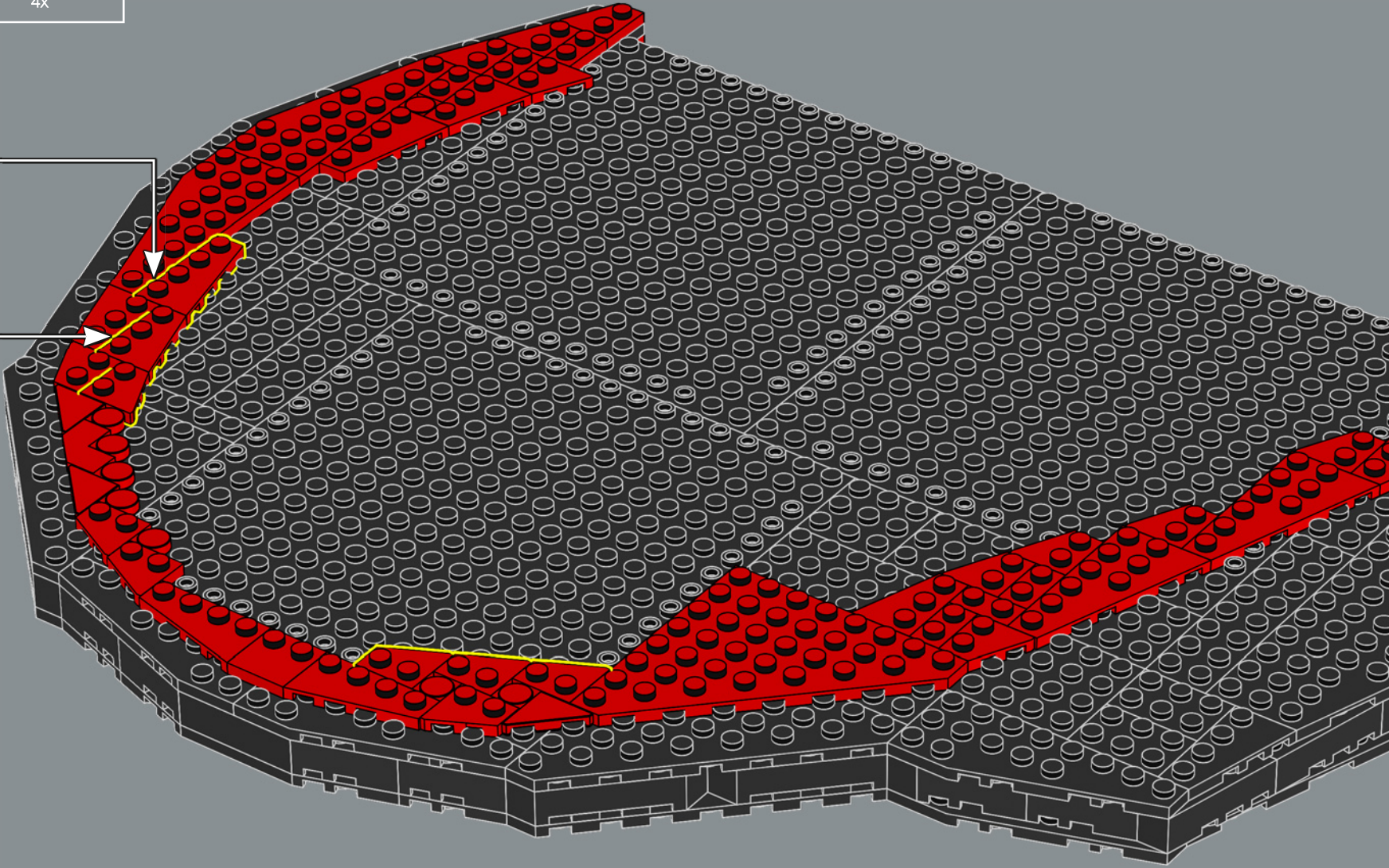
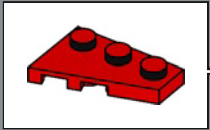
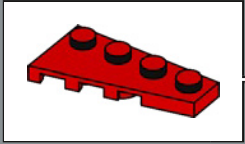



126

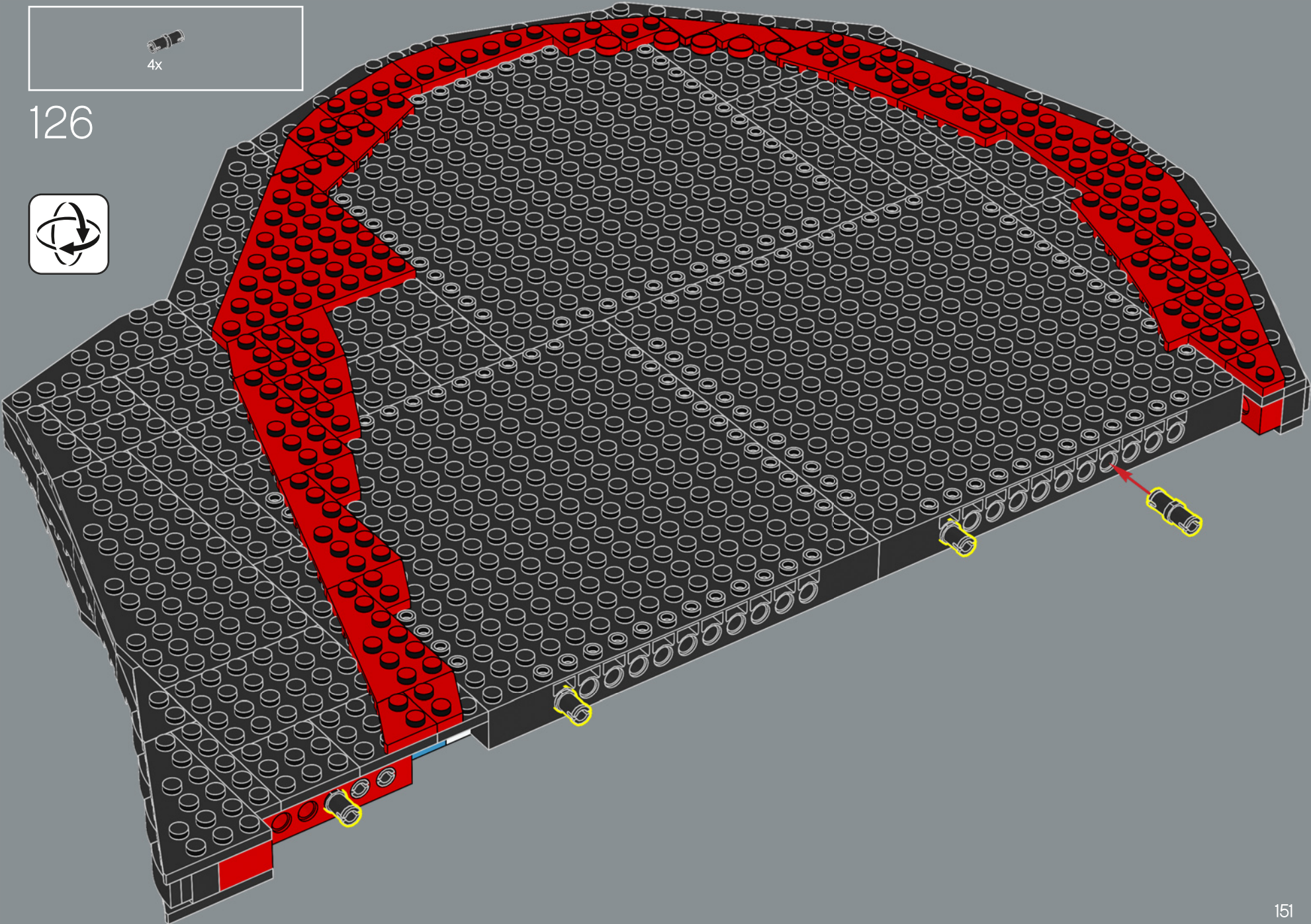

127

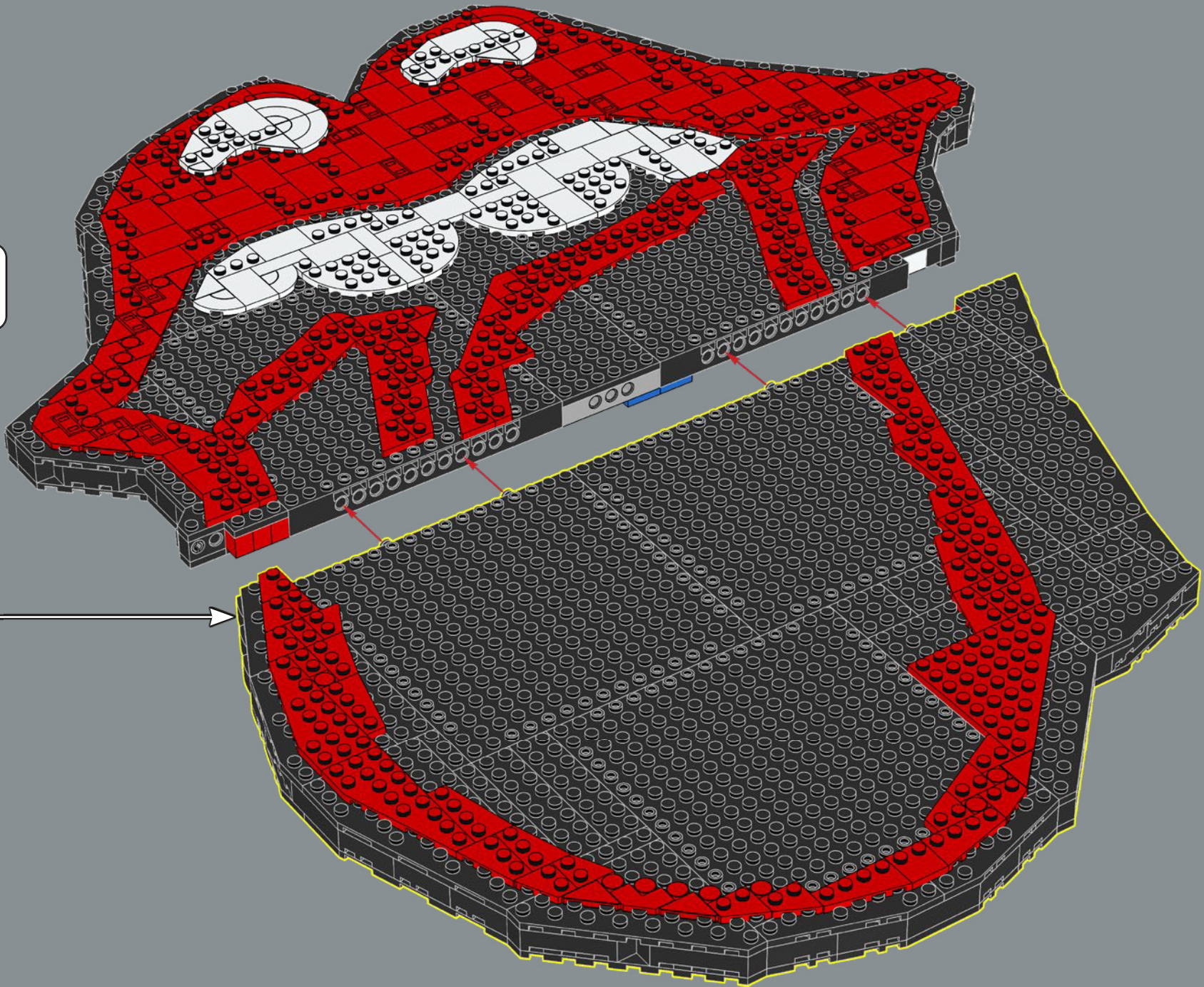

152



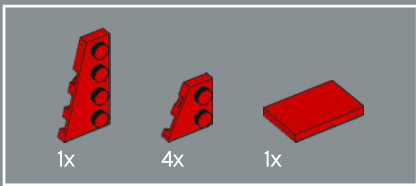

128

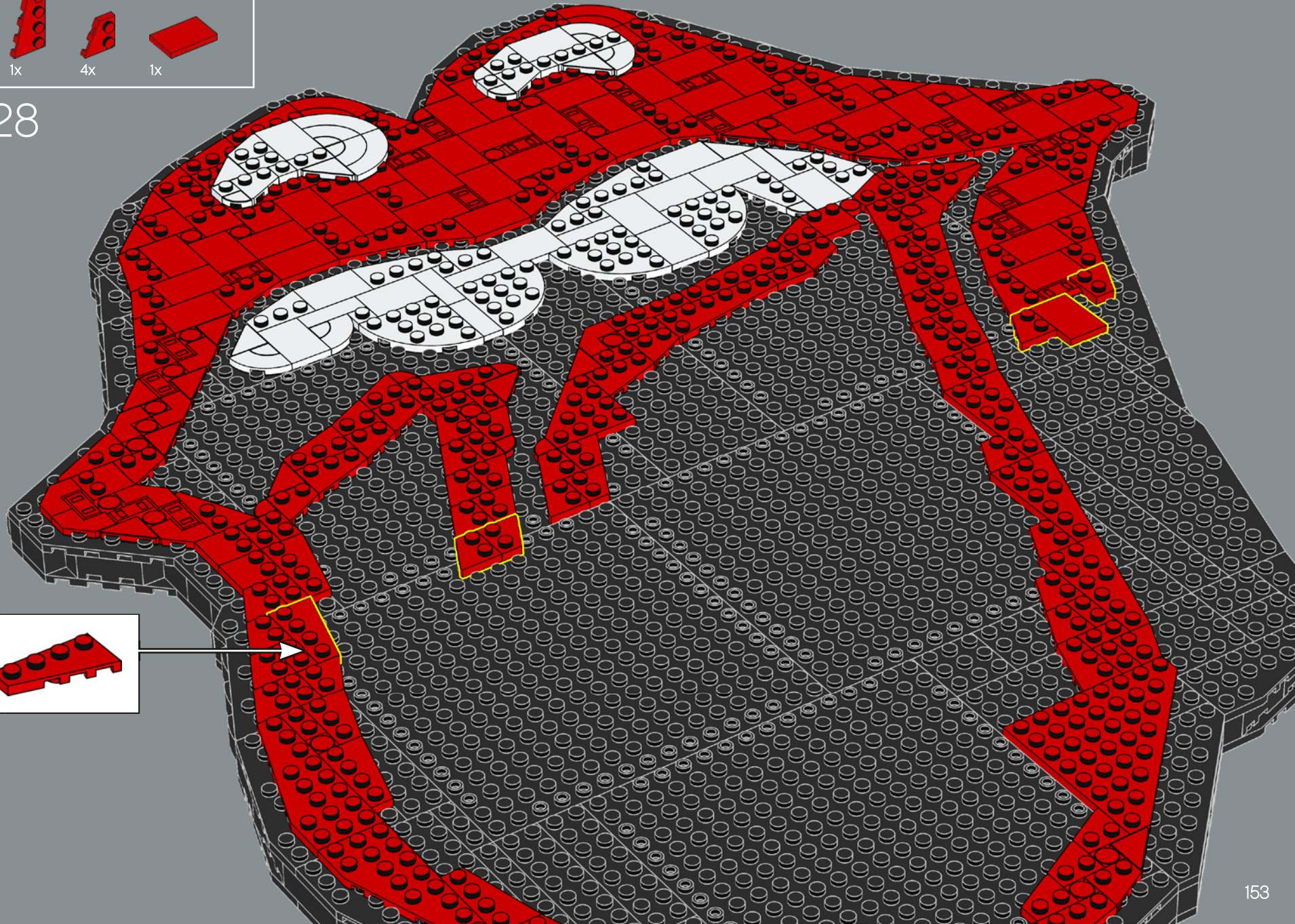
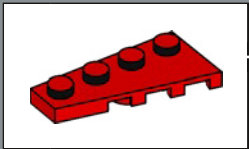

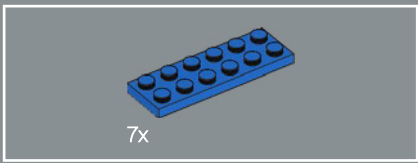

129

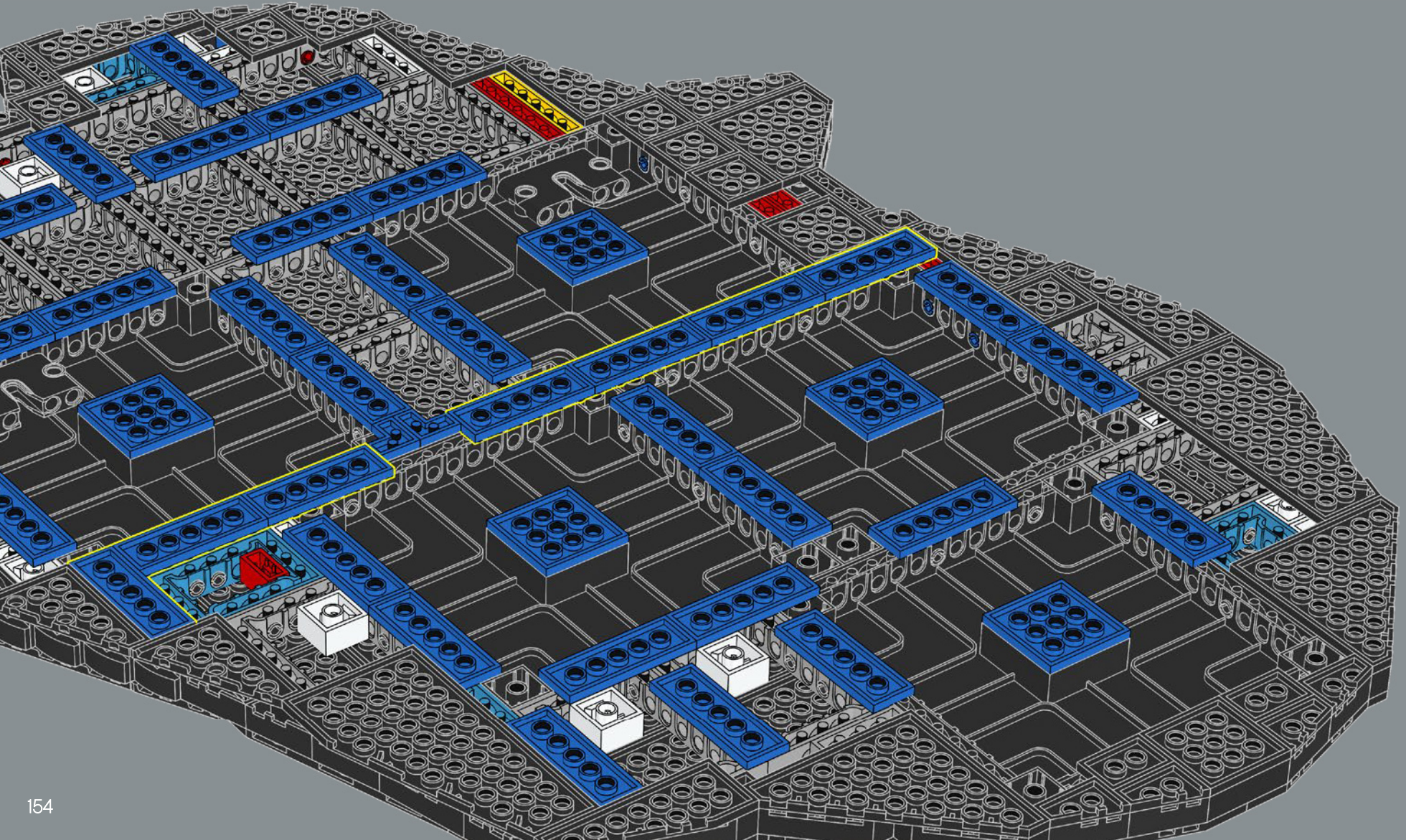

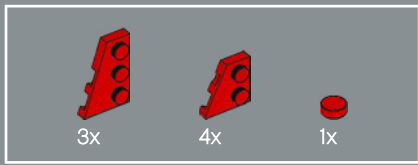

130

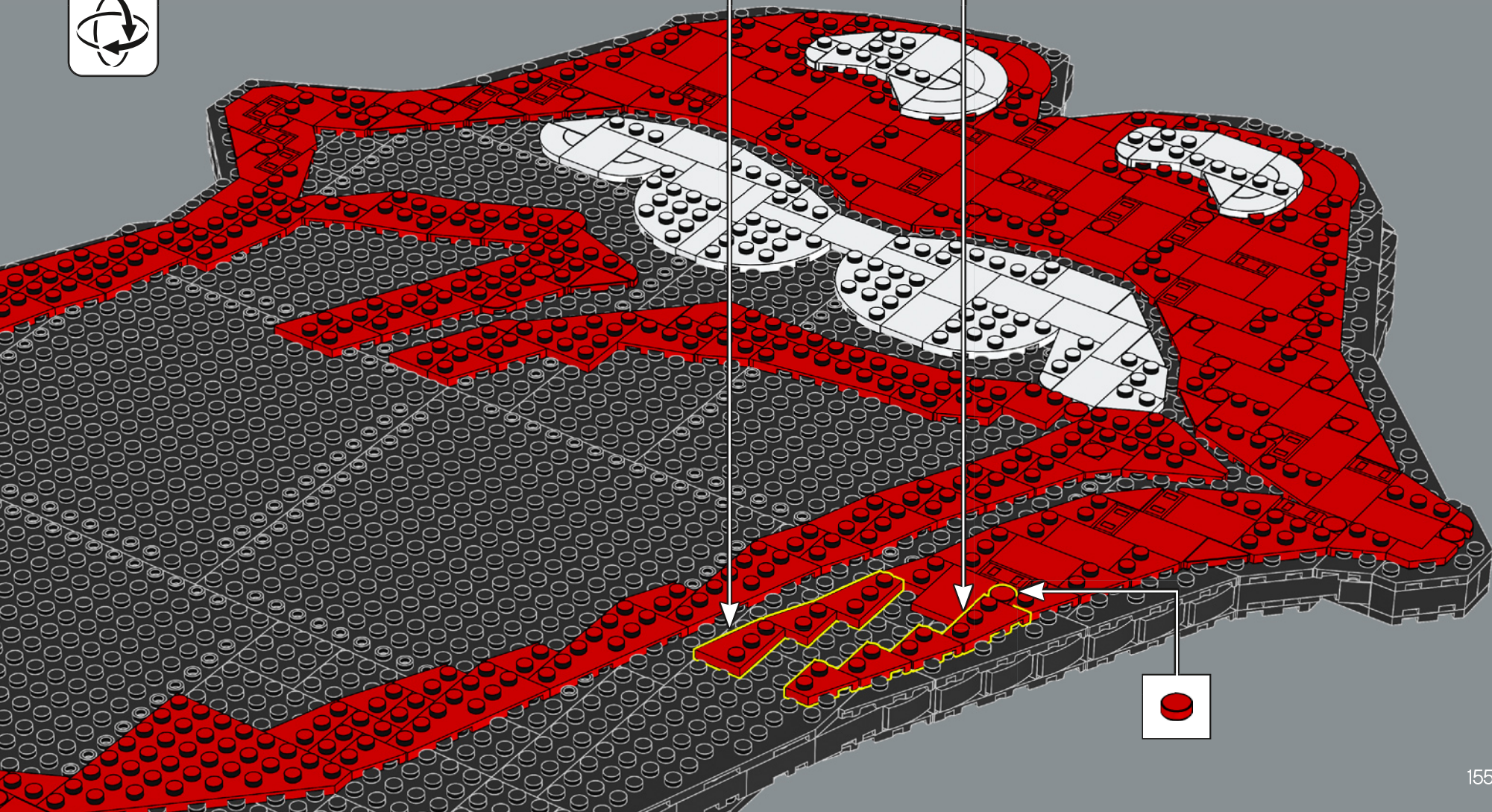
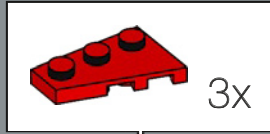

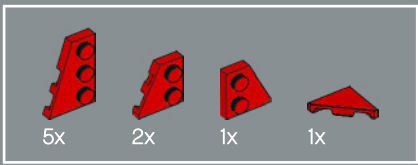

131

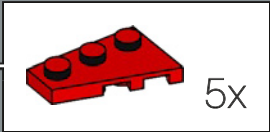
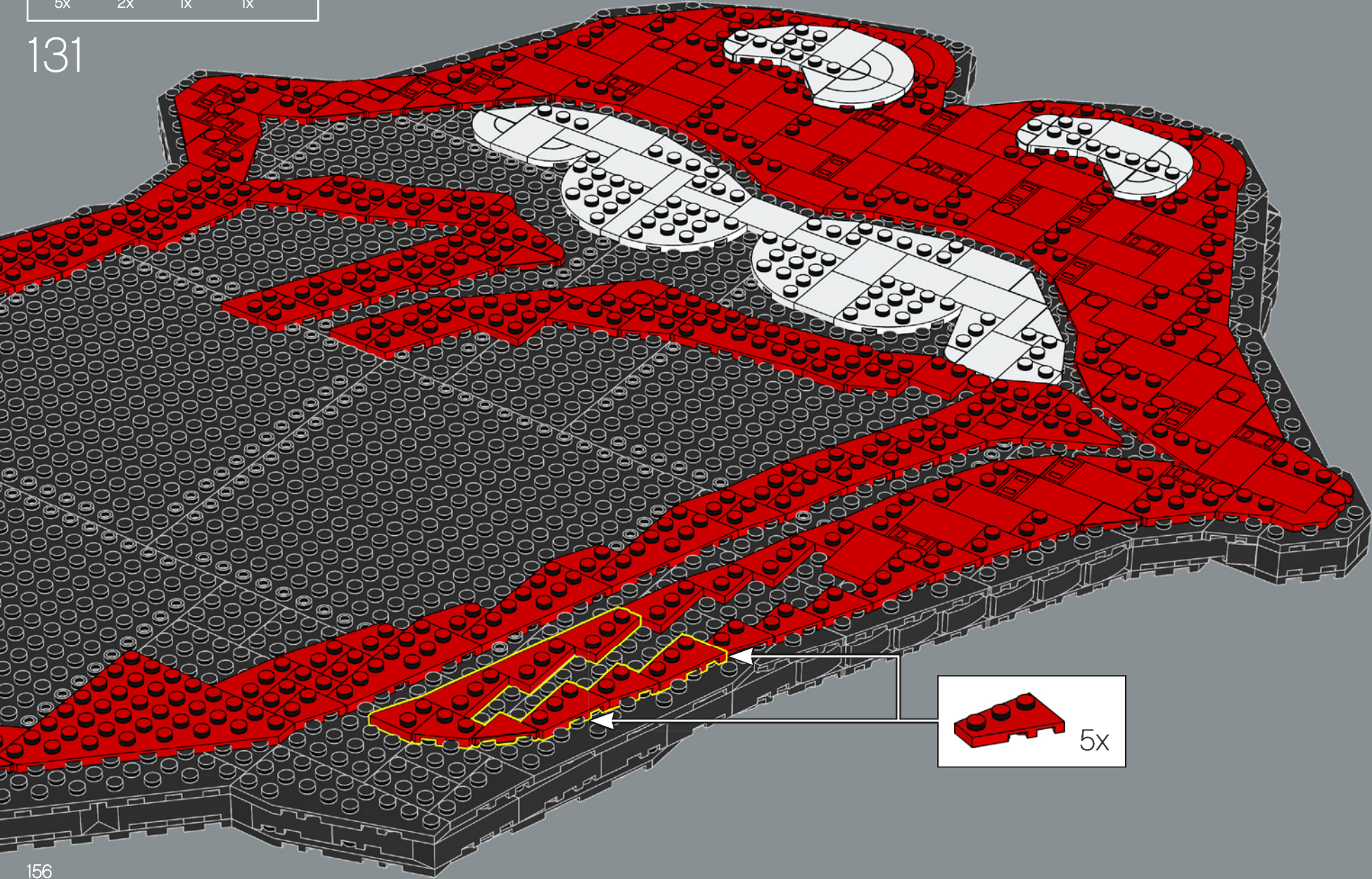

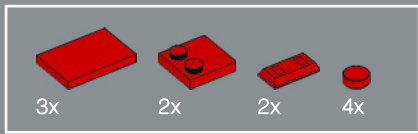

132

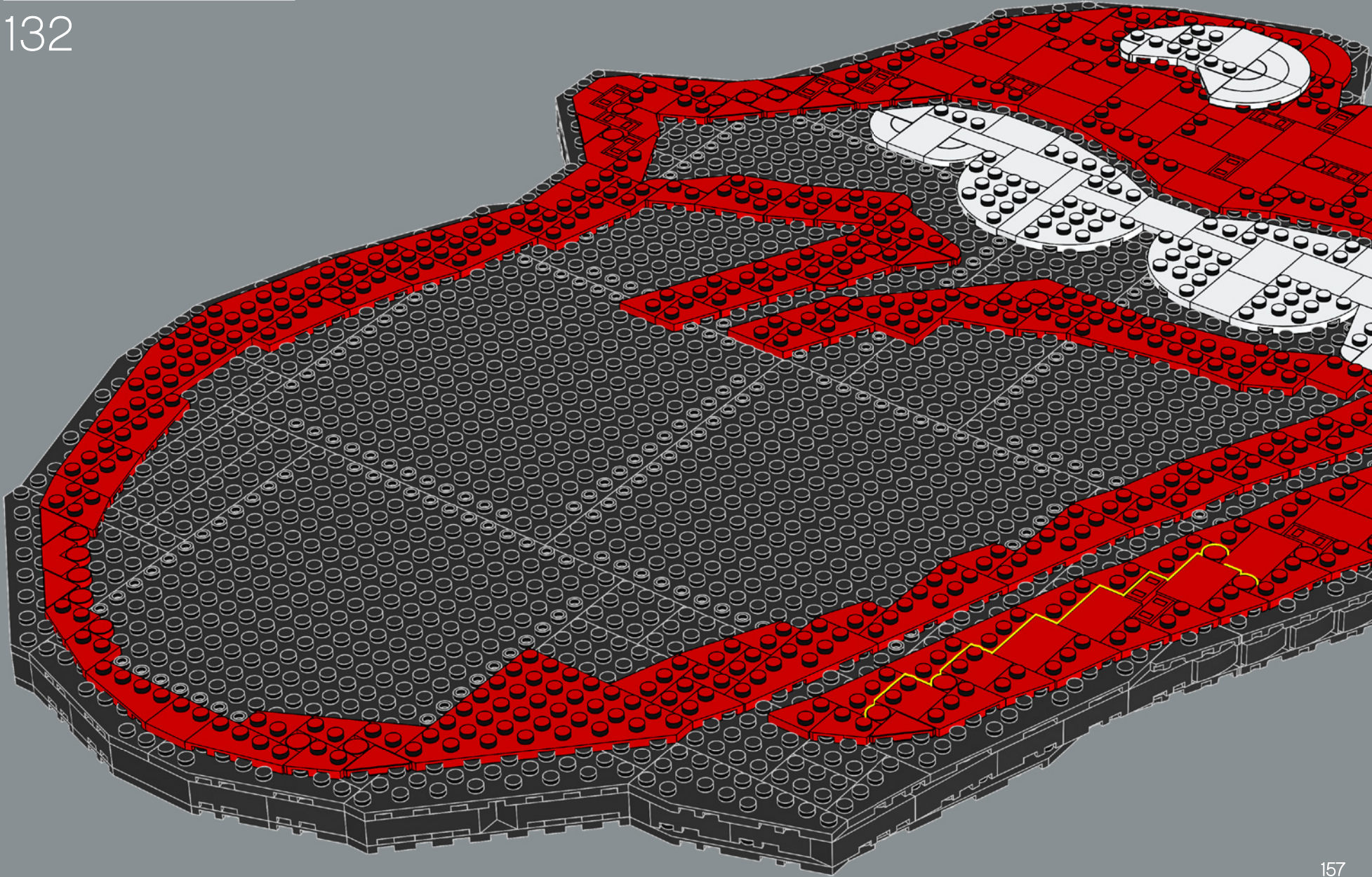

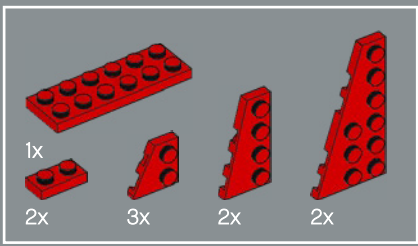

133

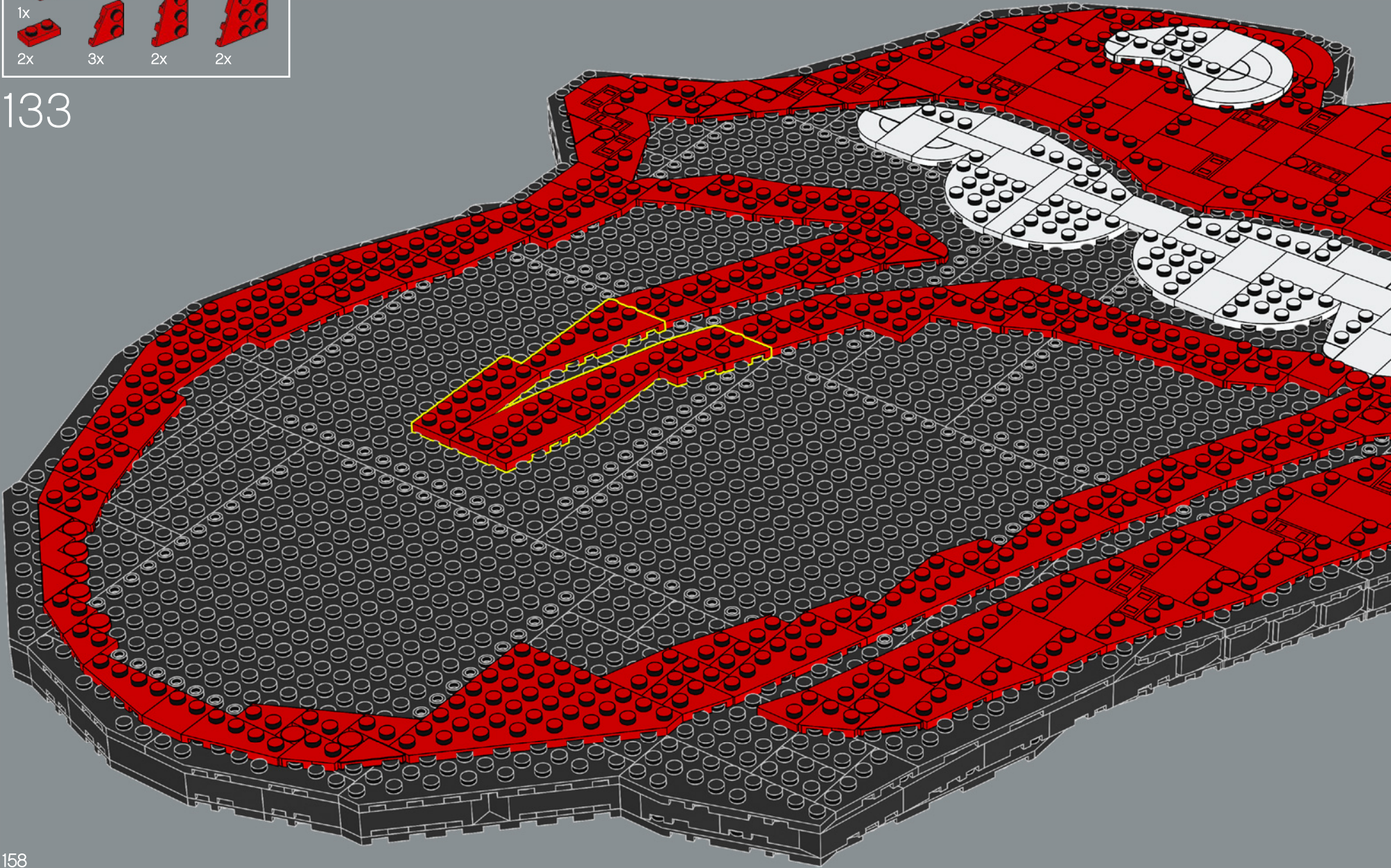



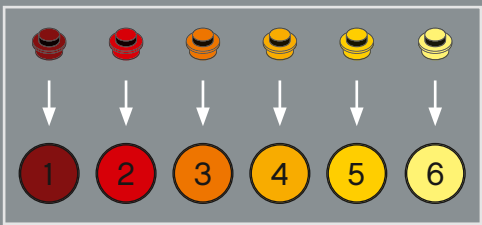

134

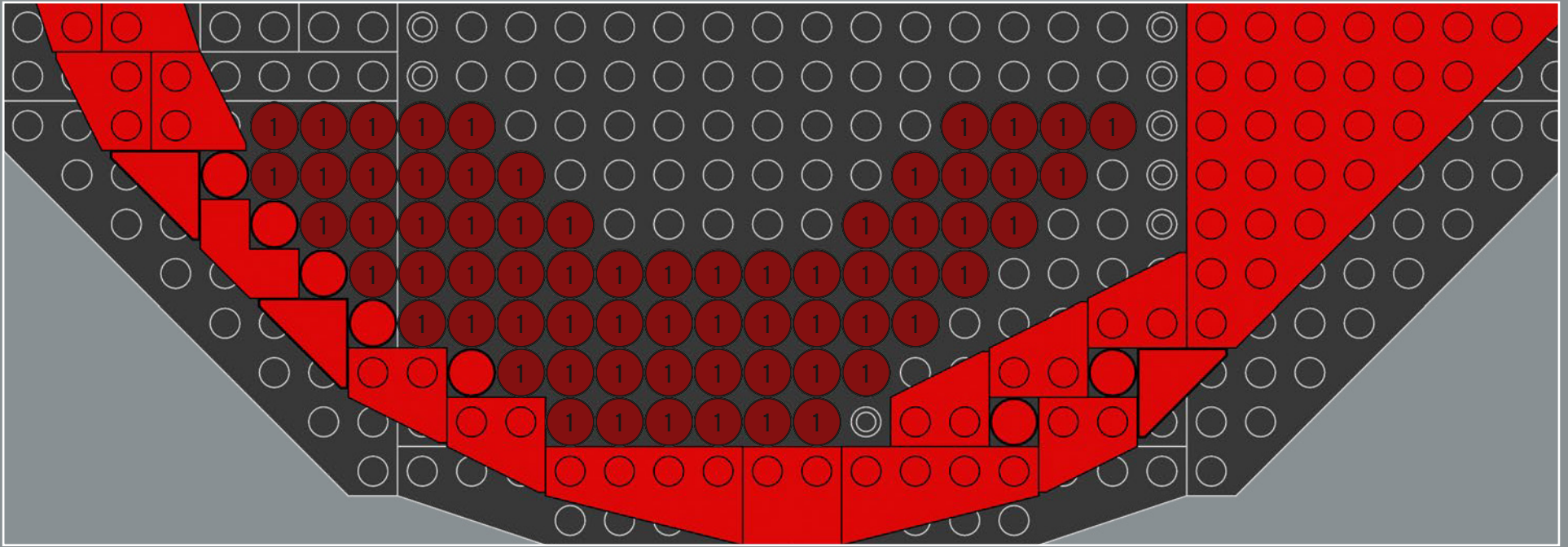
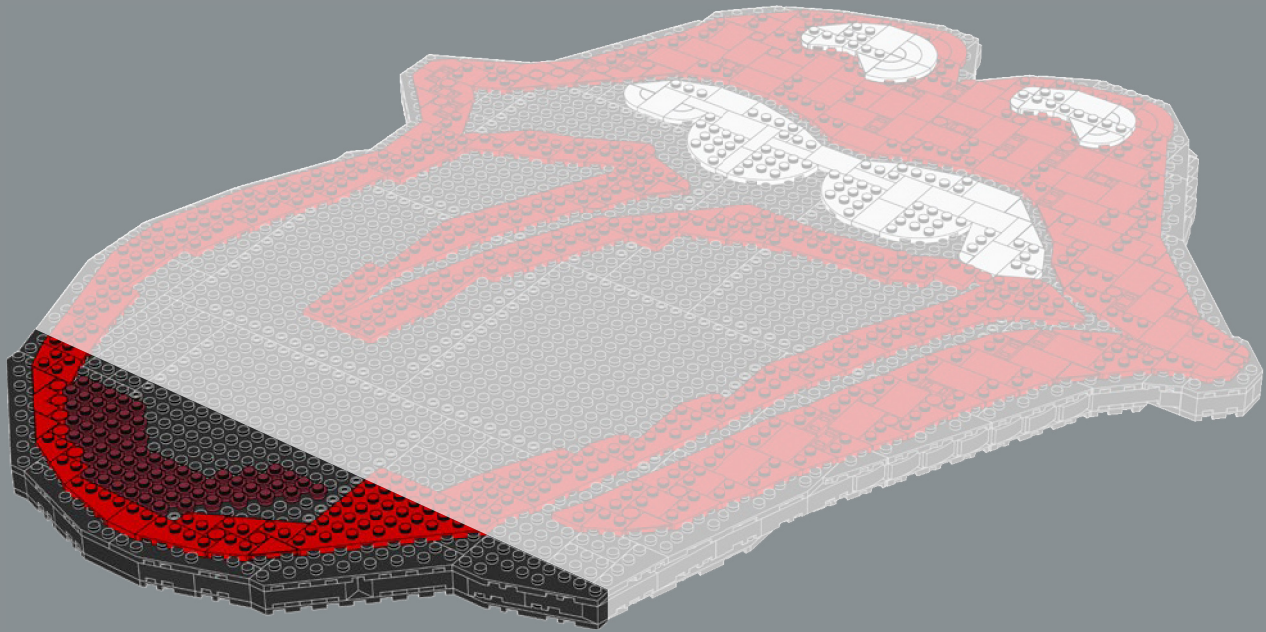





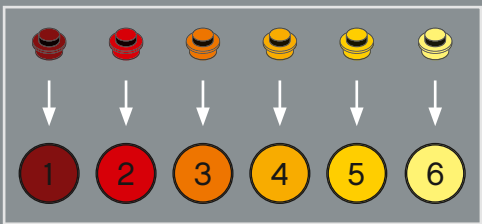

136

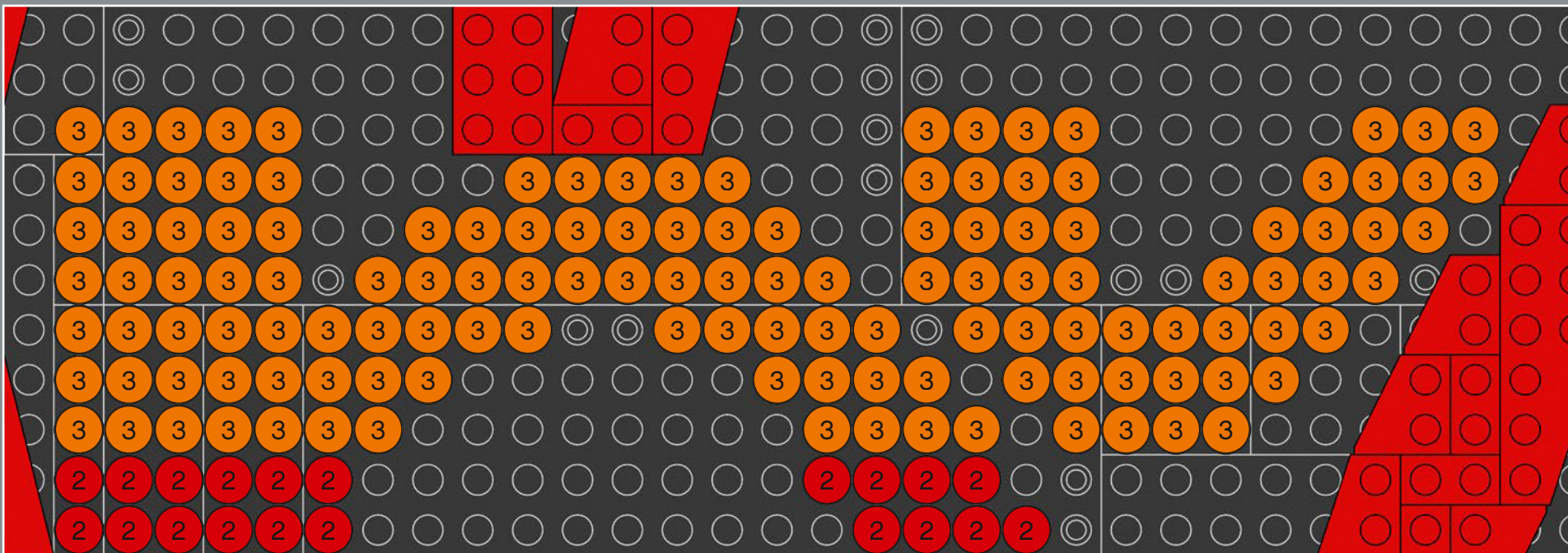
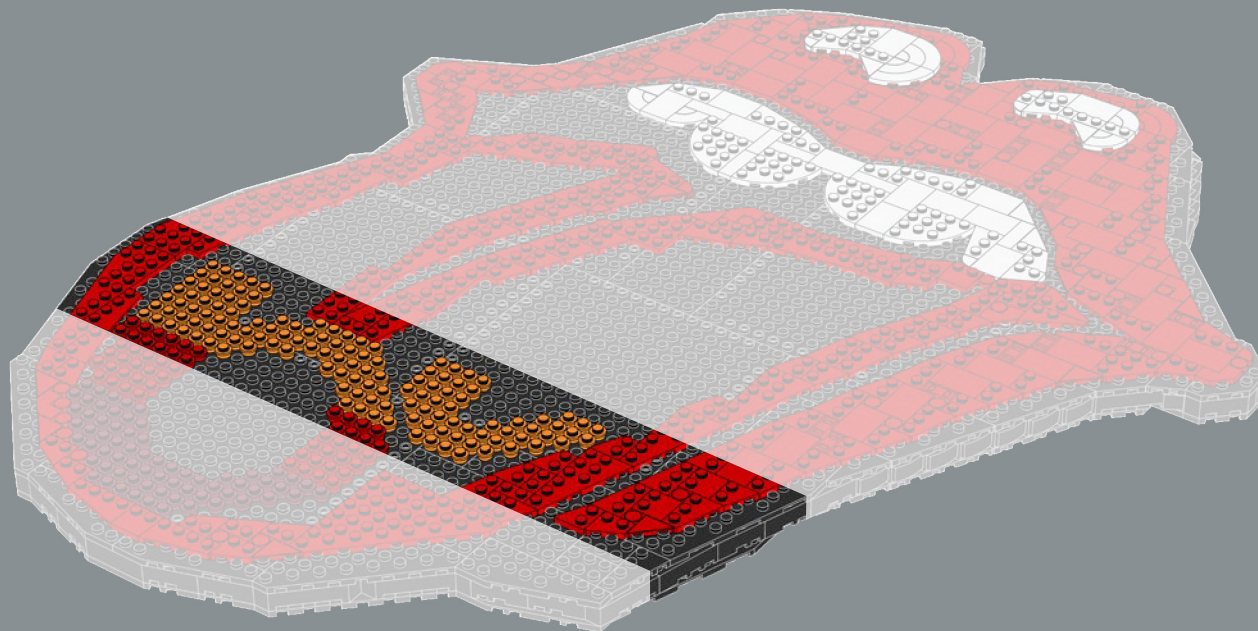

162

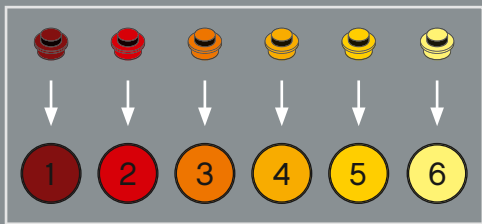

137

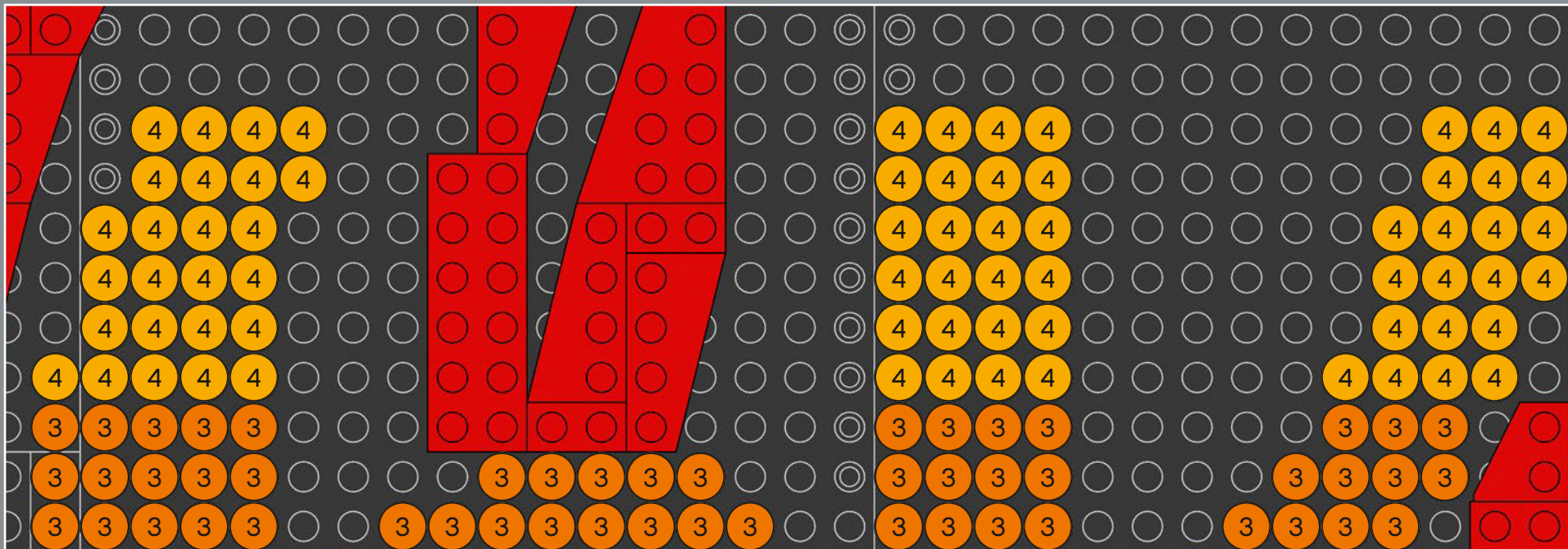
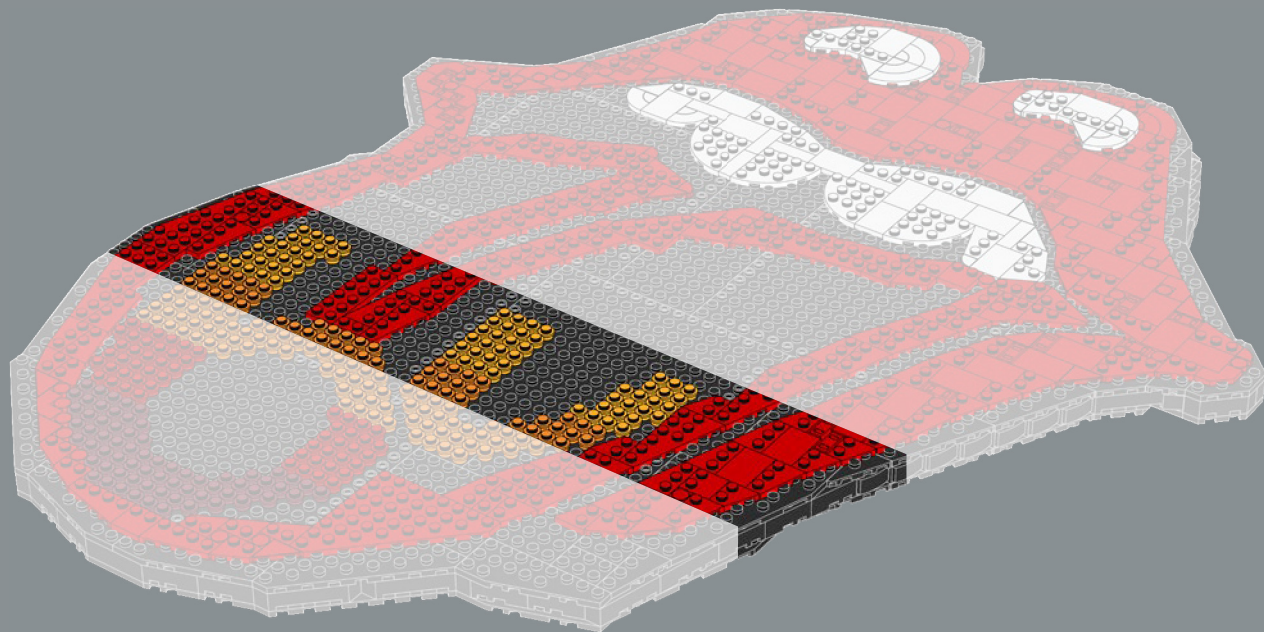

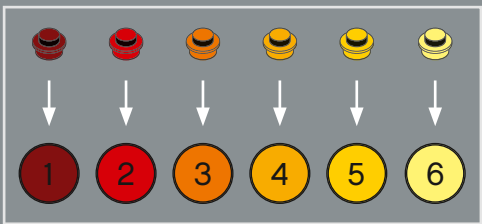

138

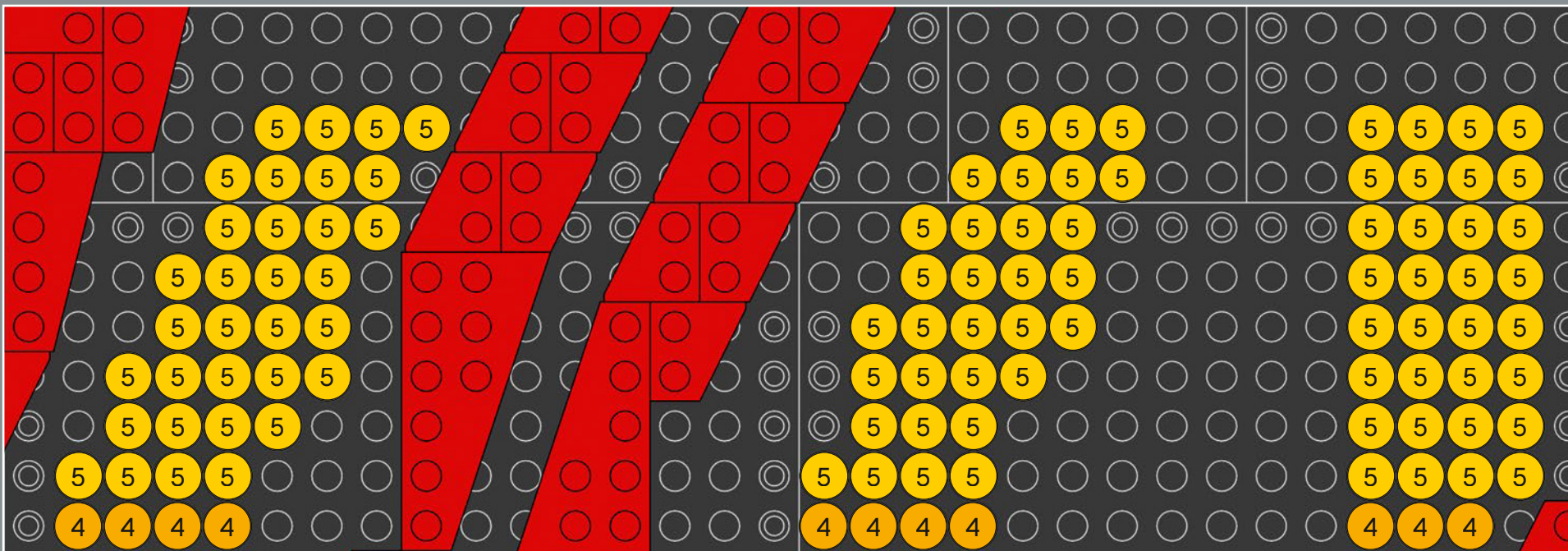
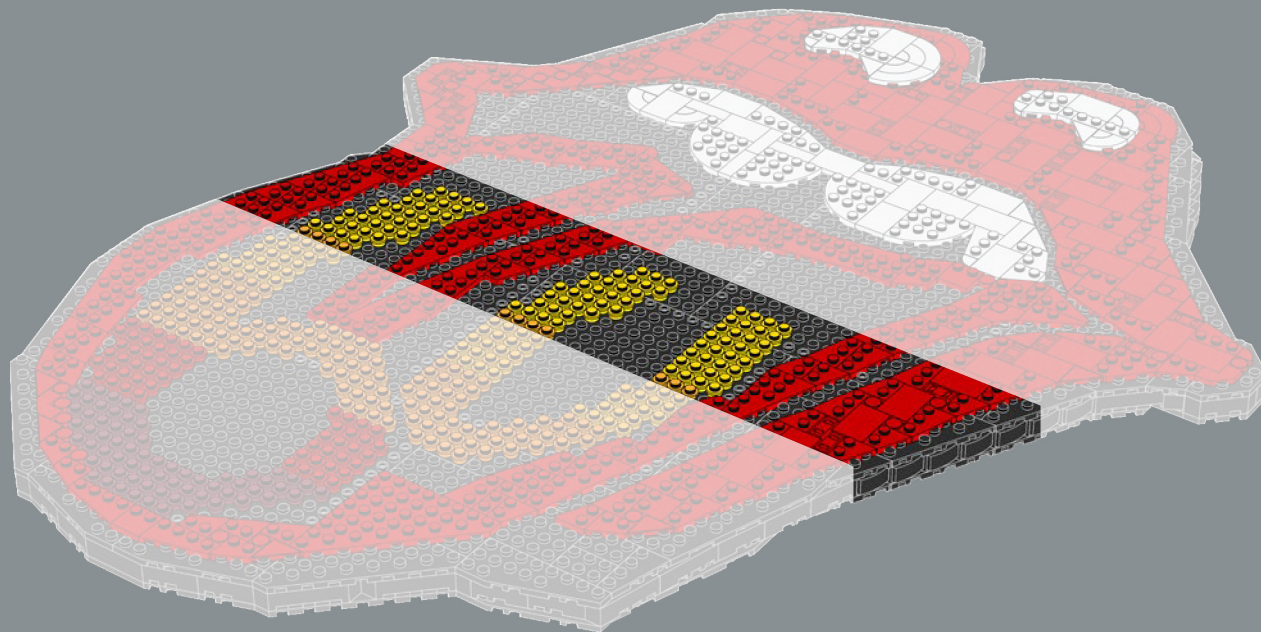

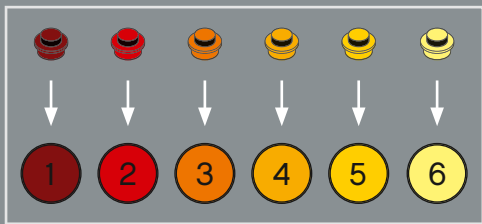

139

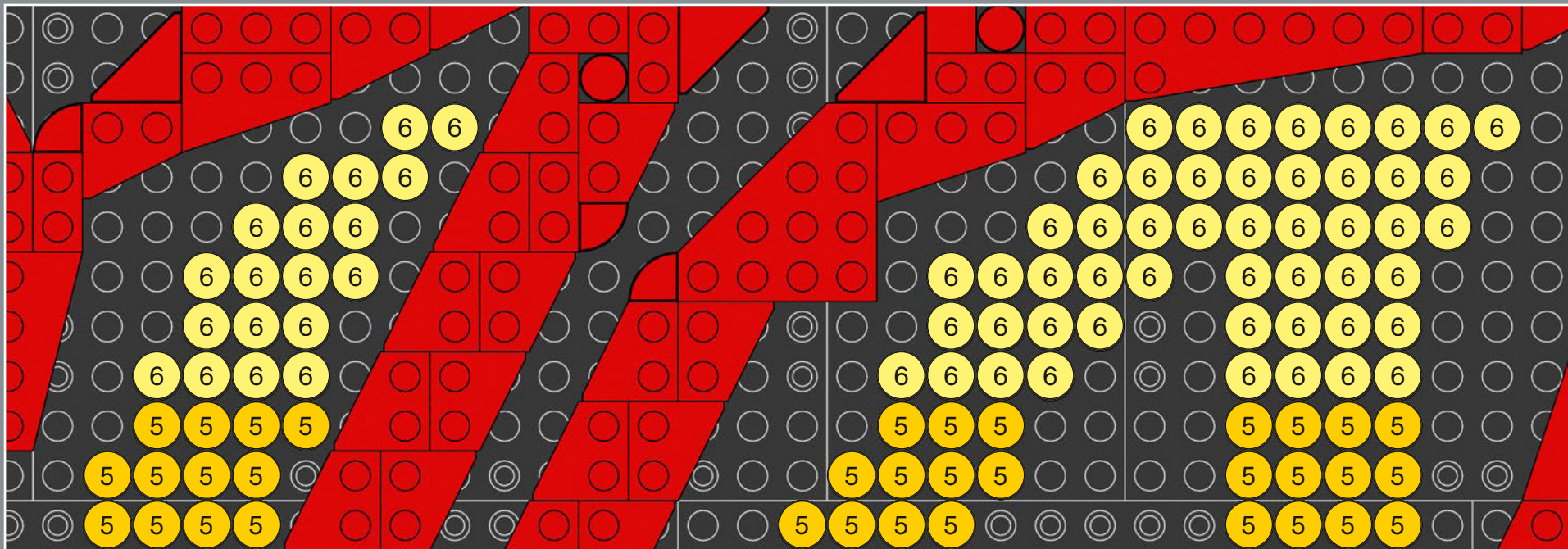
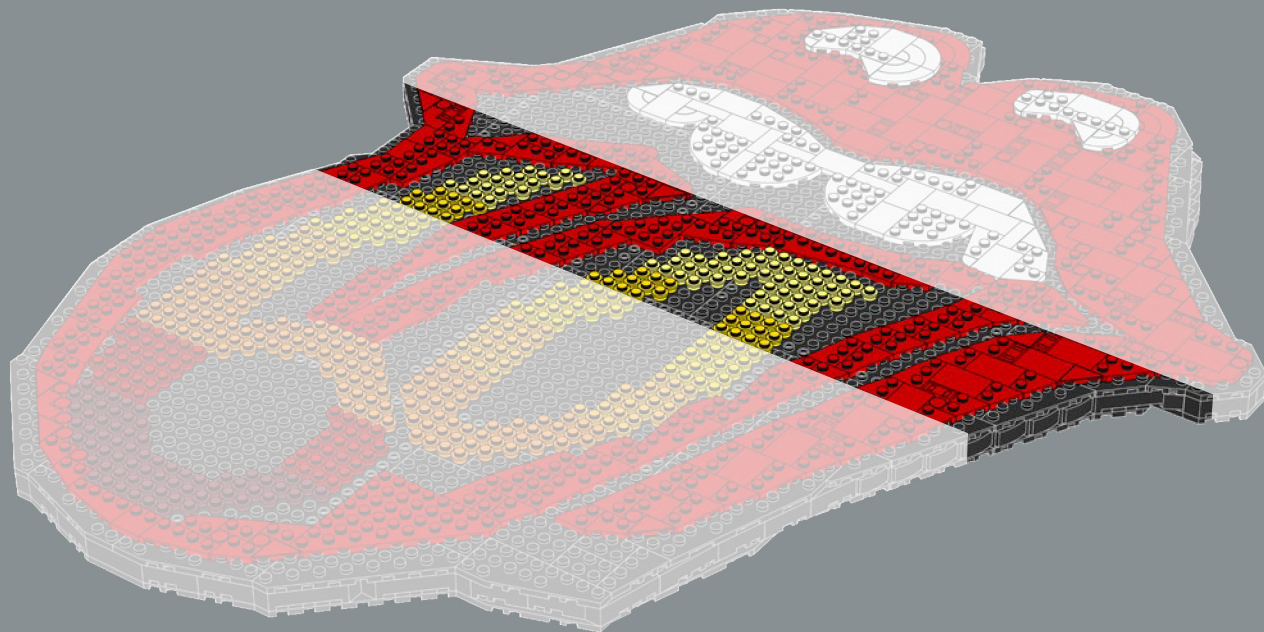

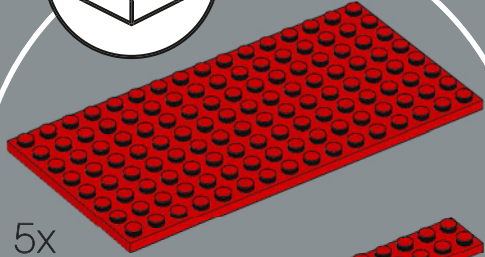
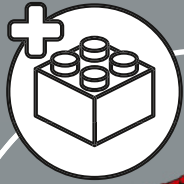

5x

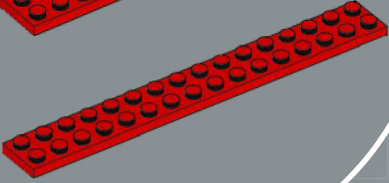

1x



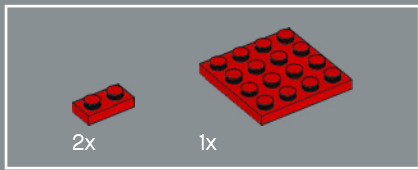

140

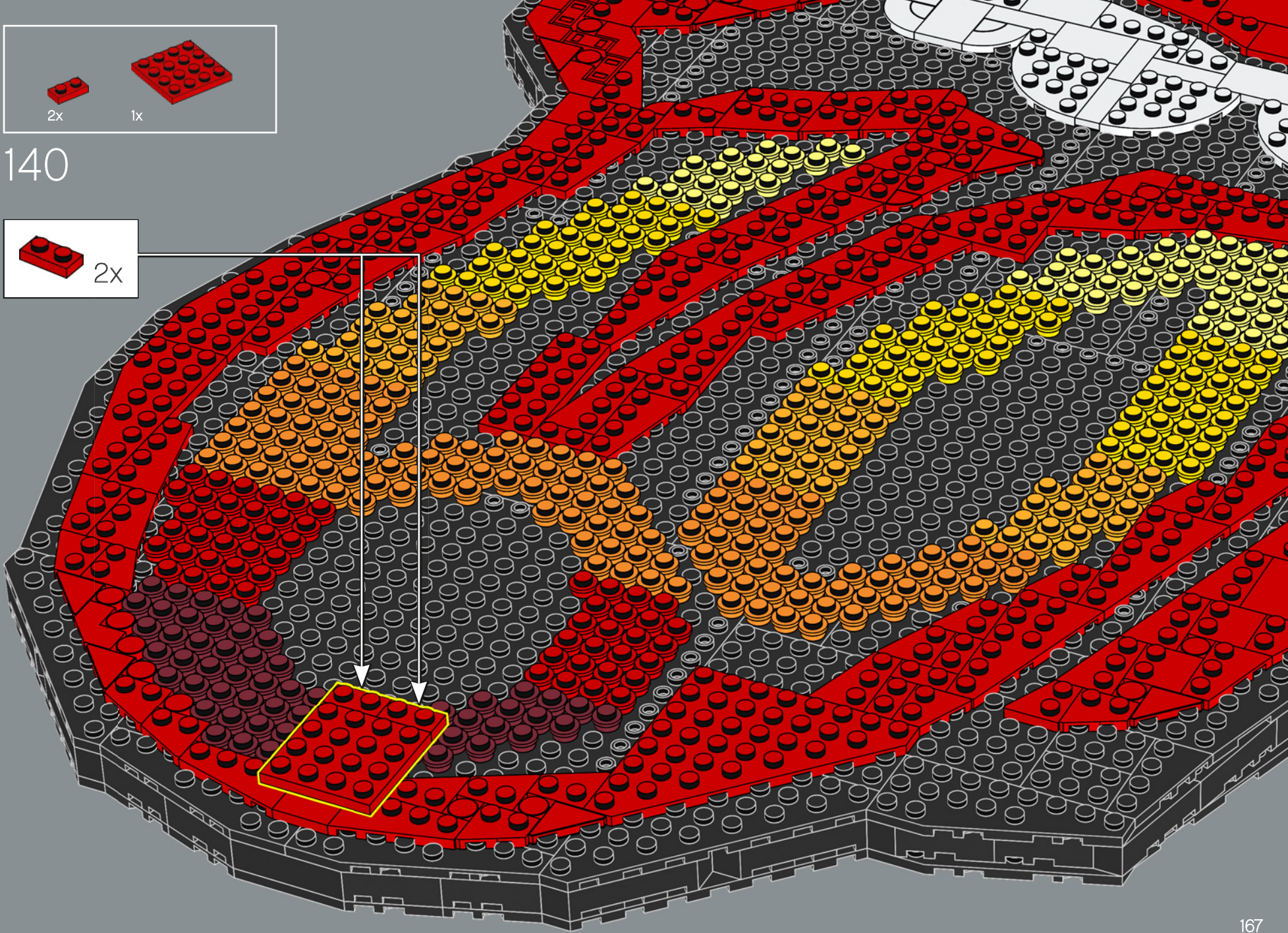
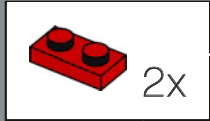

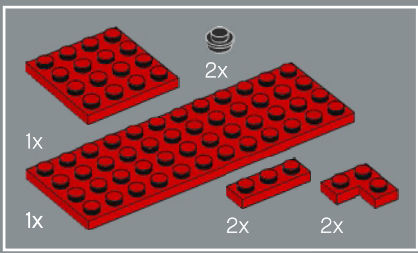

141

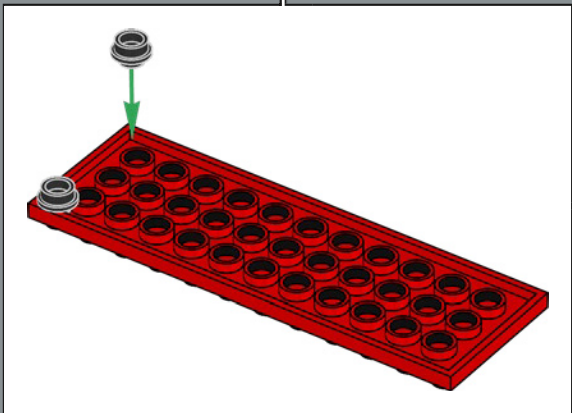
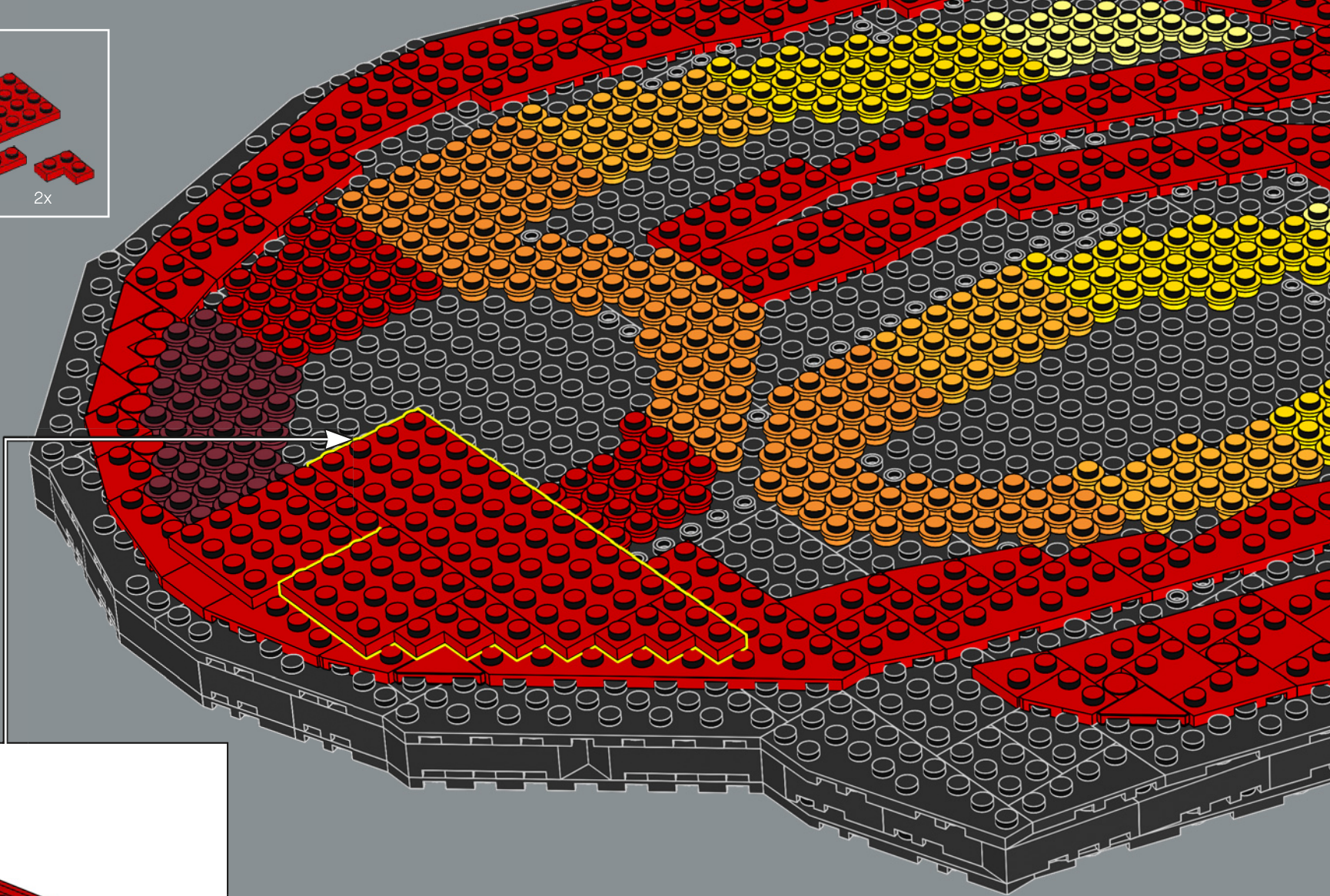



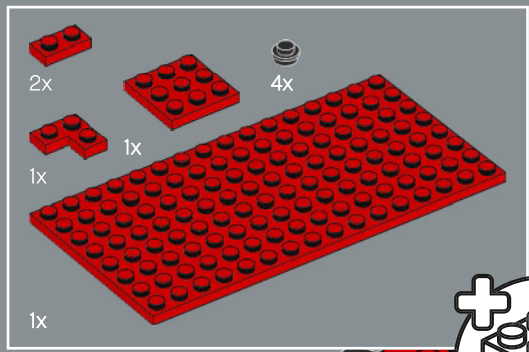

142

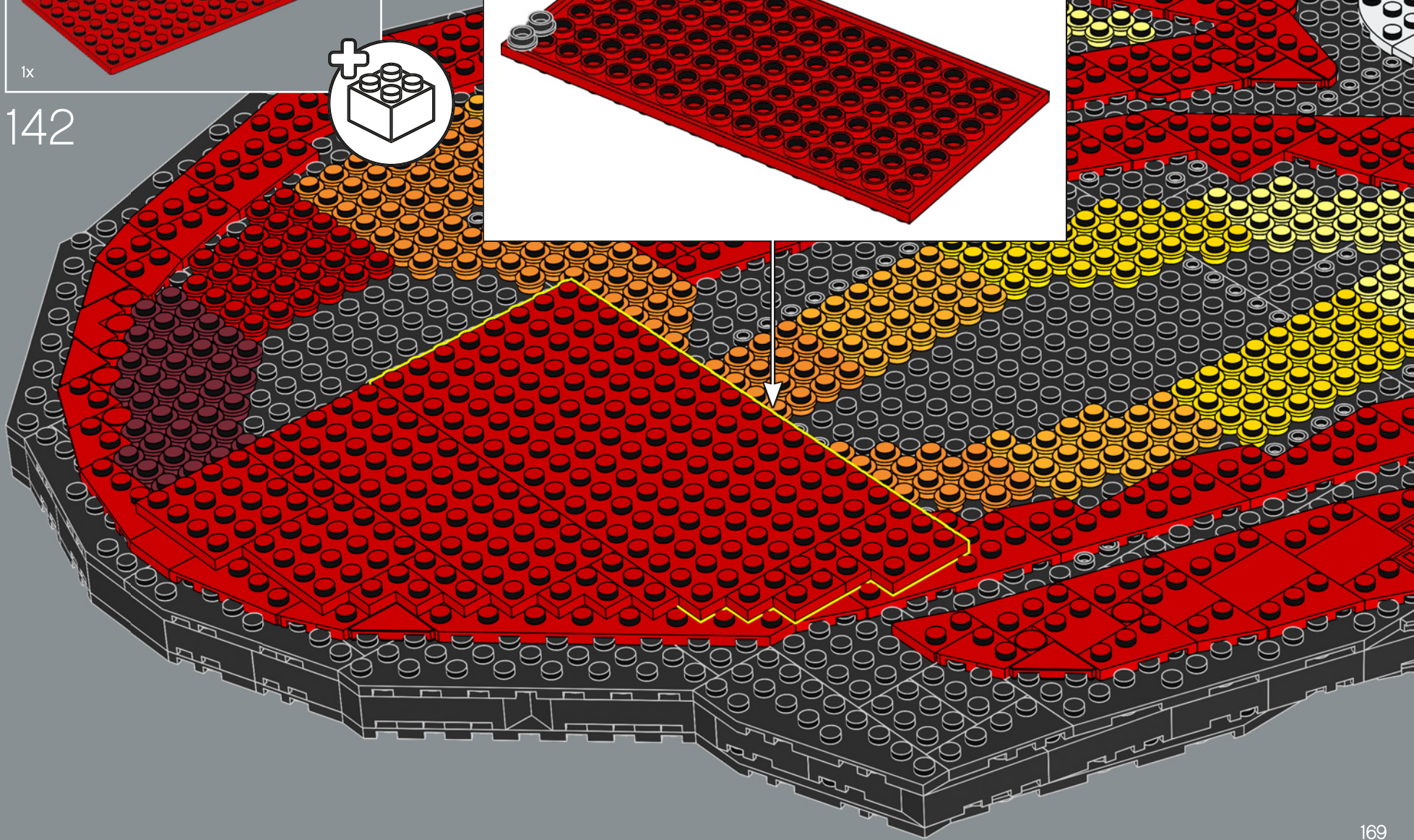
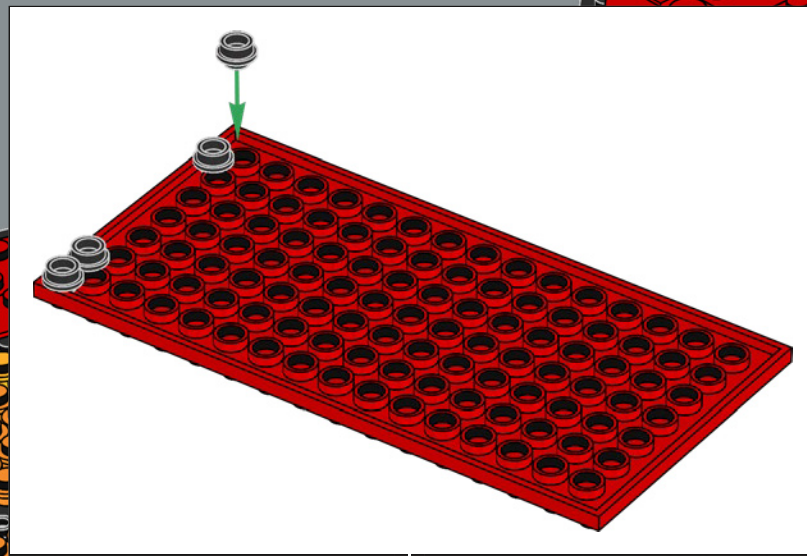

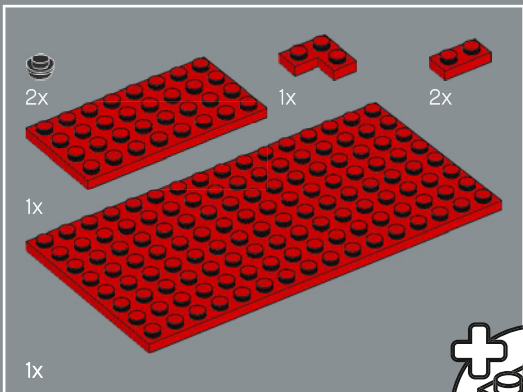

143

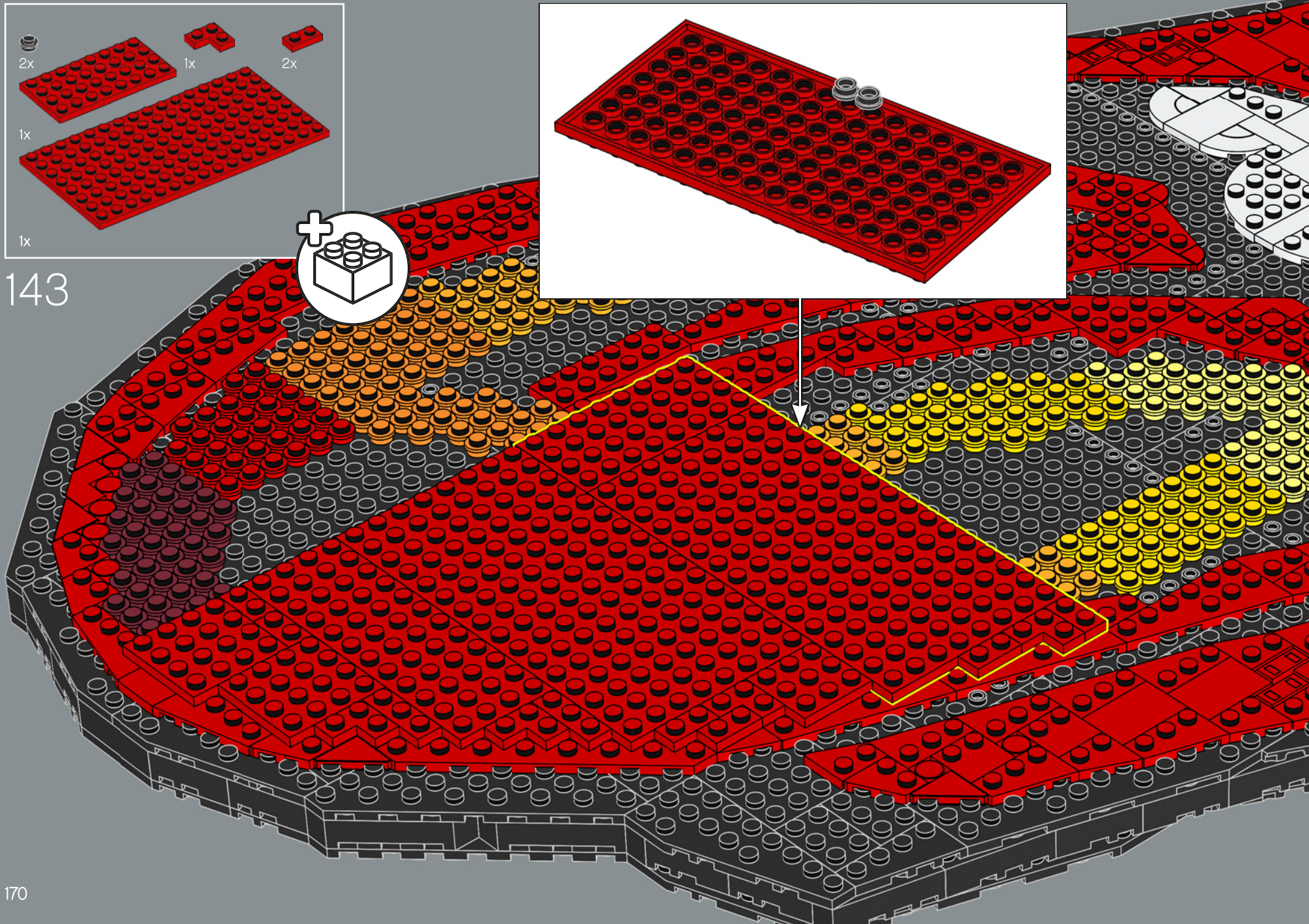
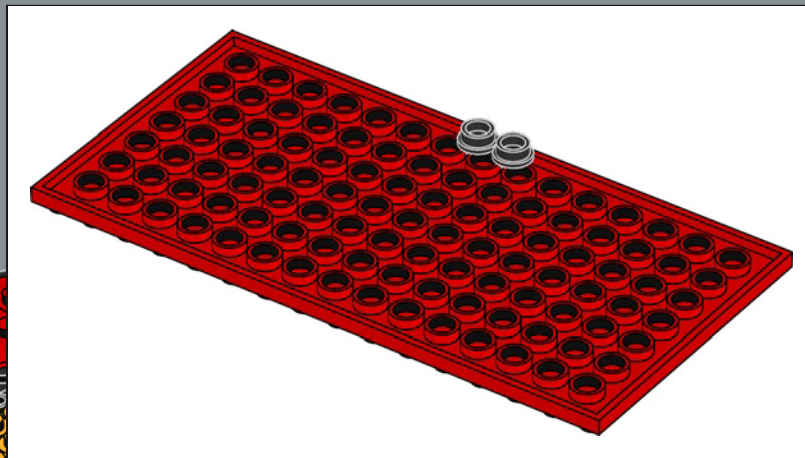

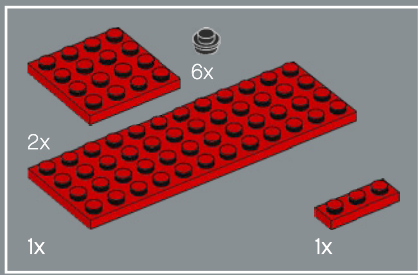

144

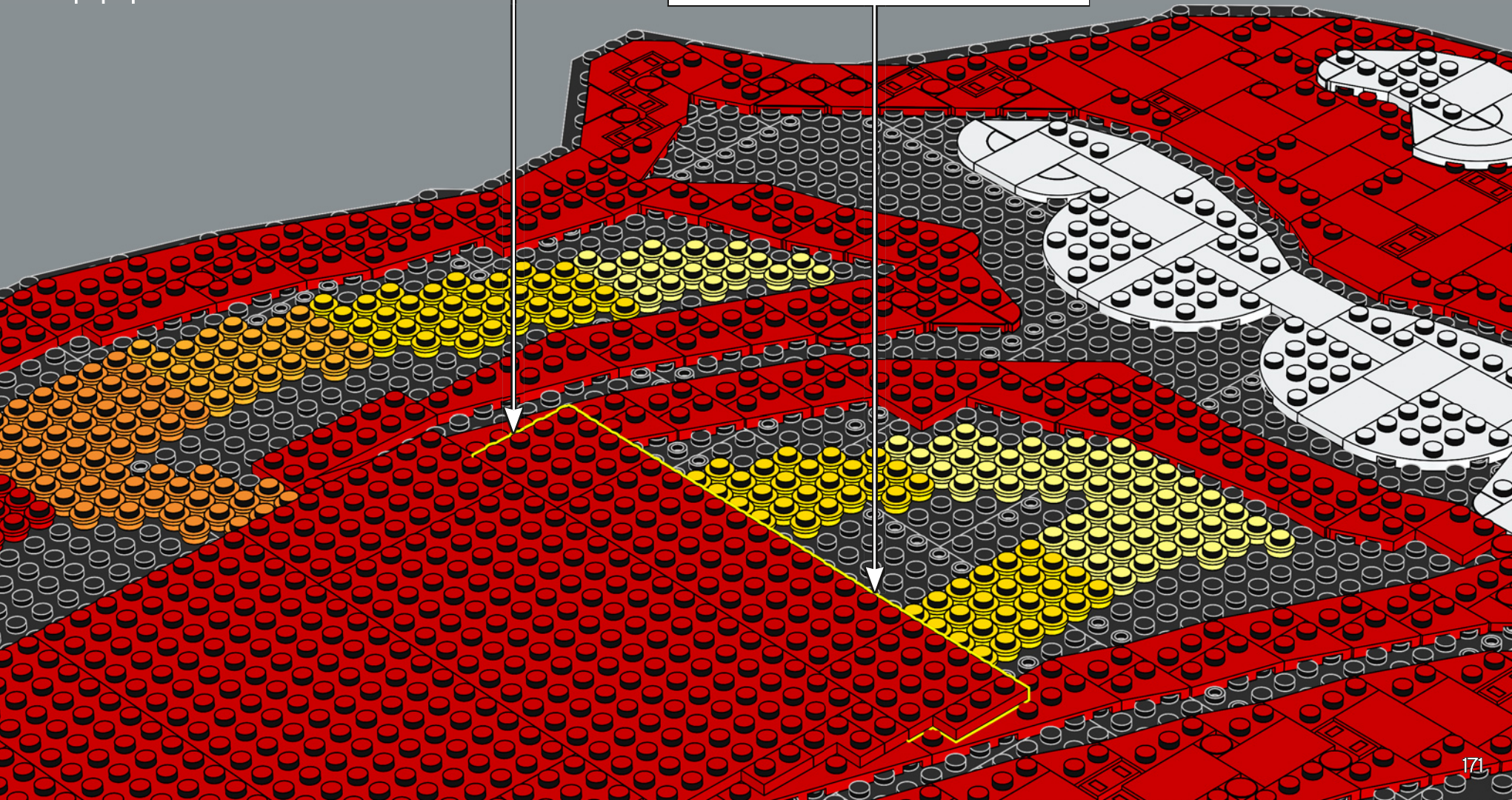
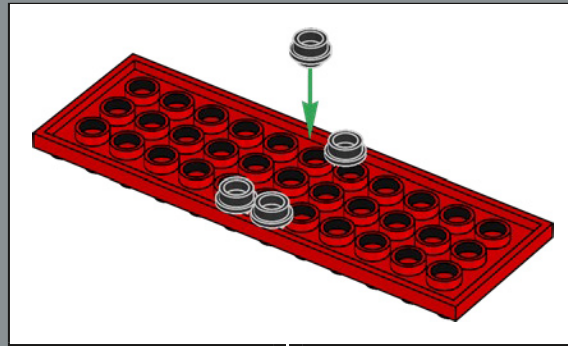
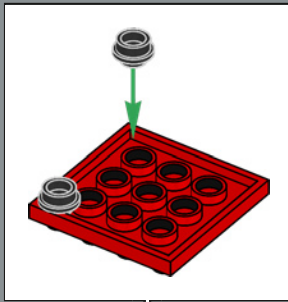

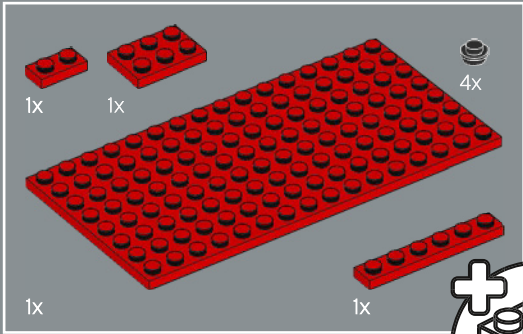

145

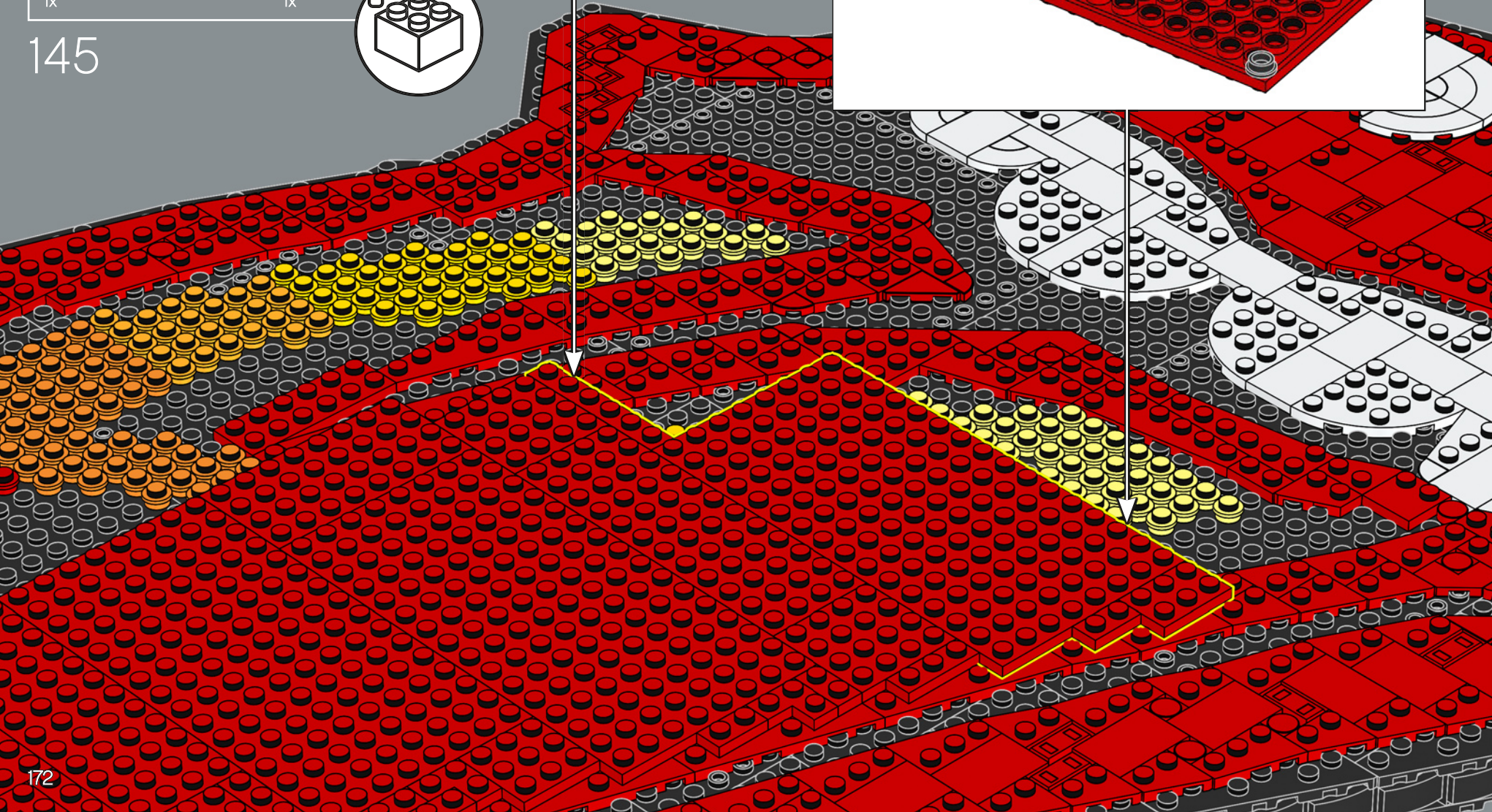
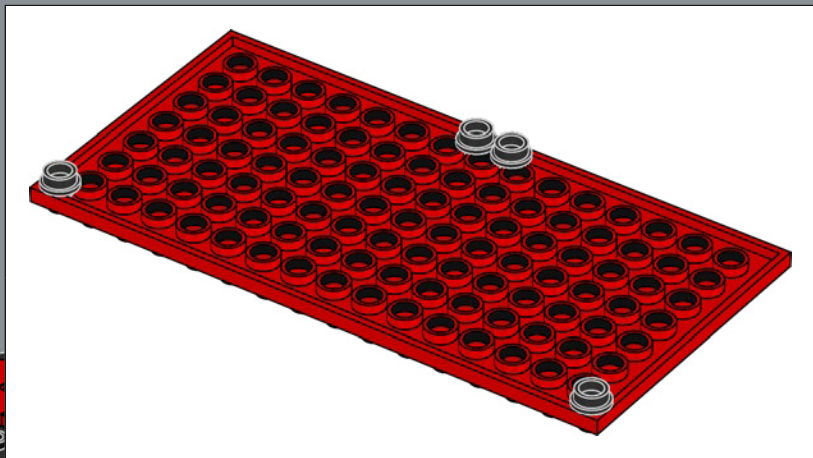
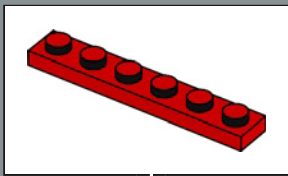

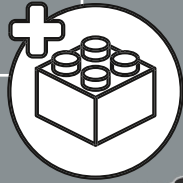
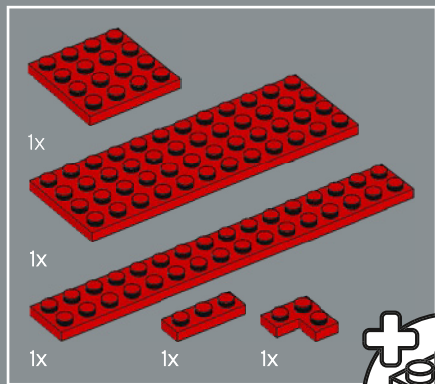

146

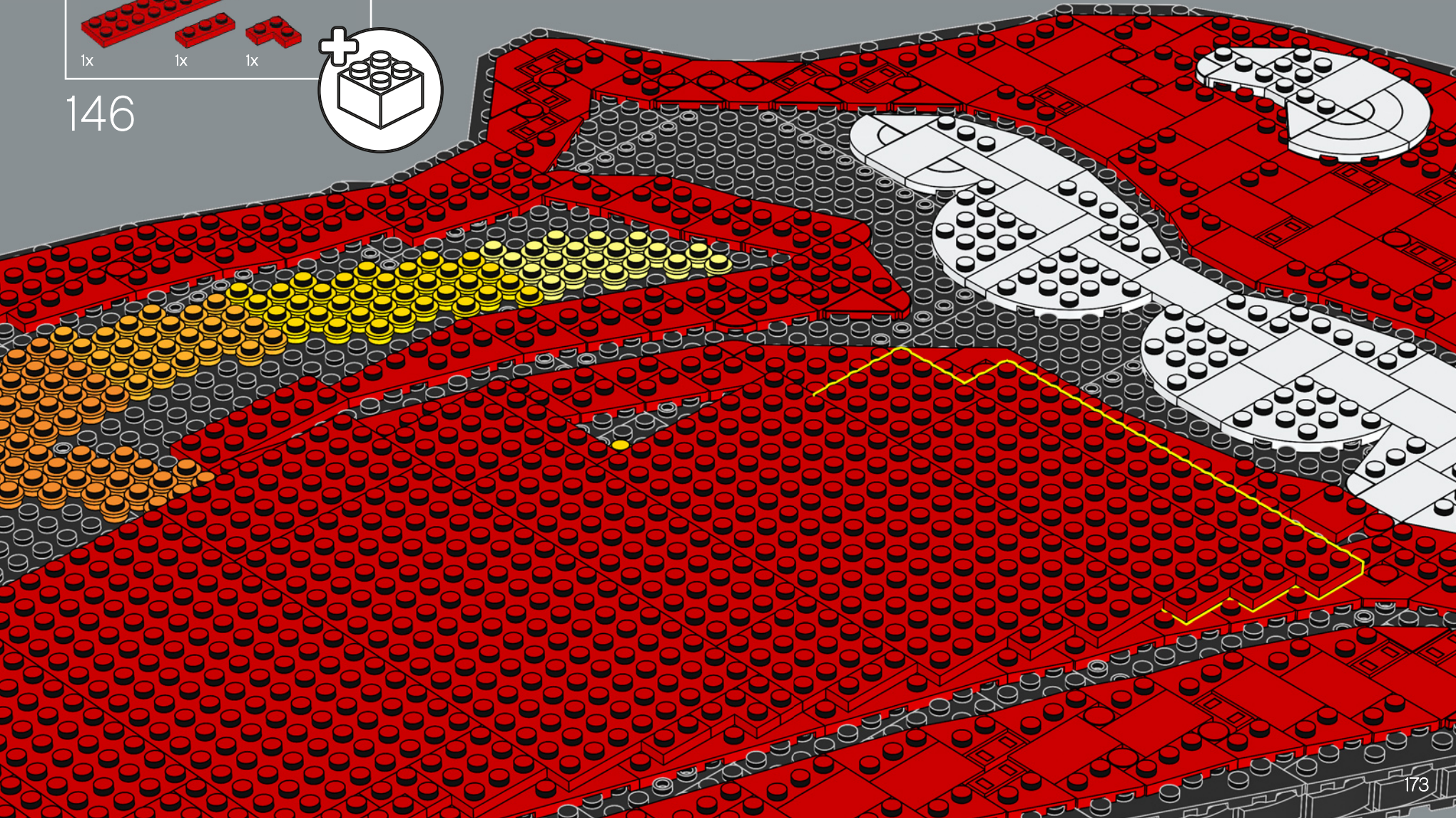

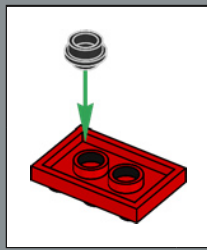
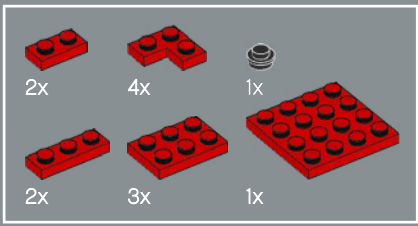

147

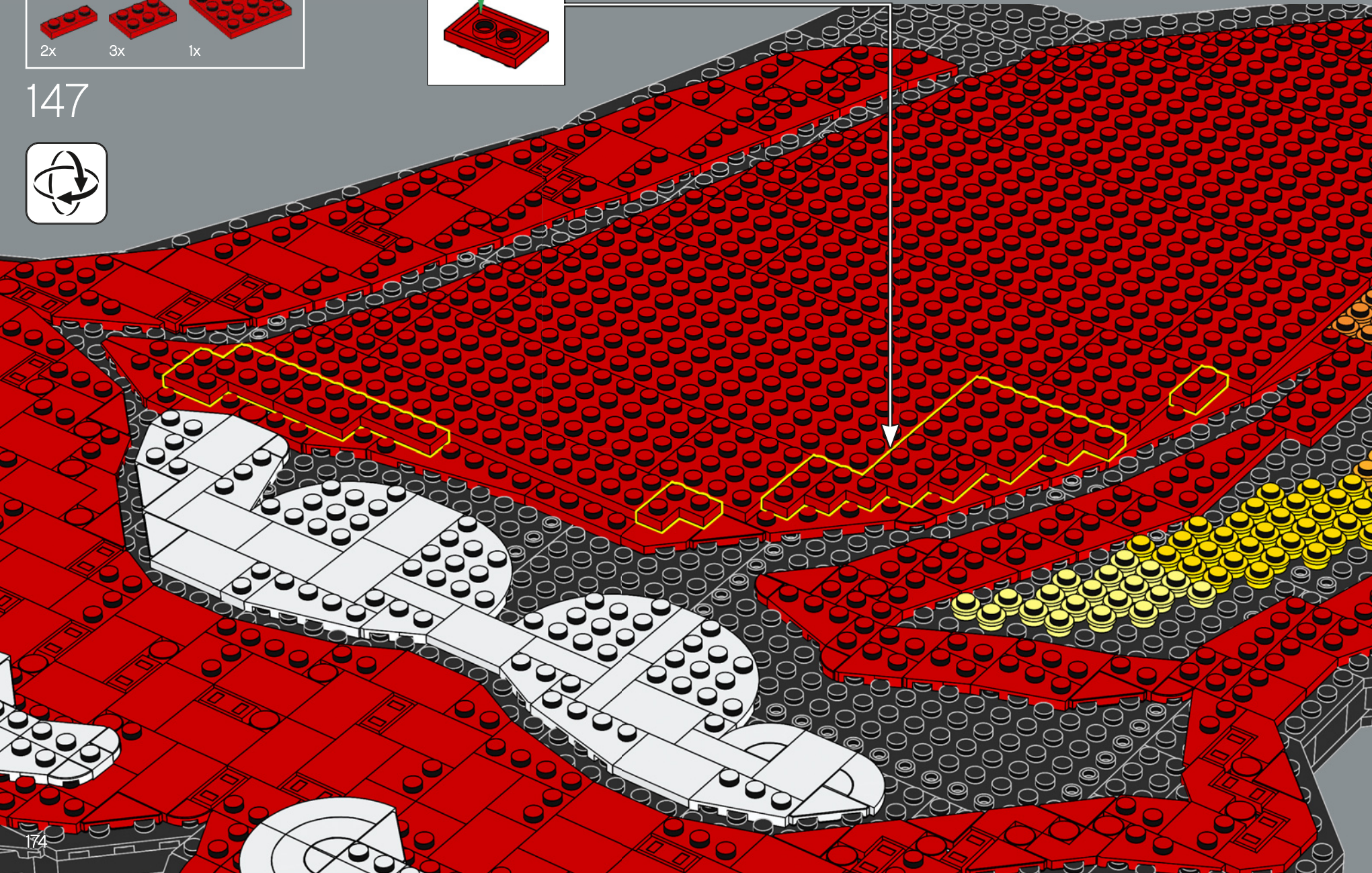

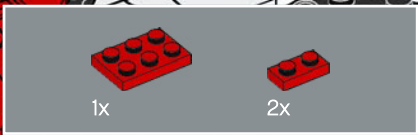

148

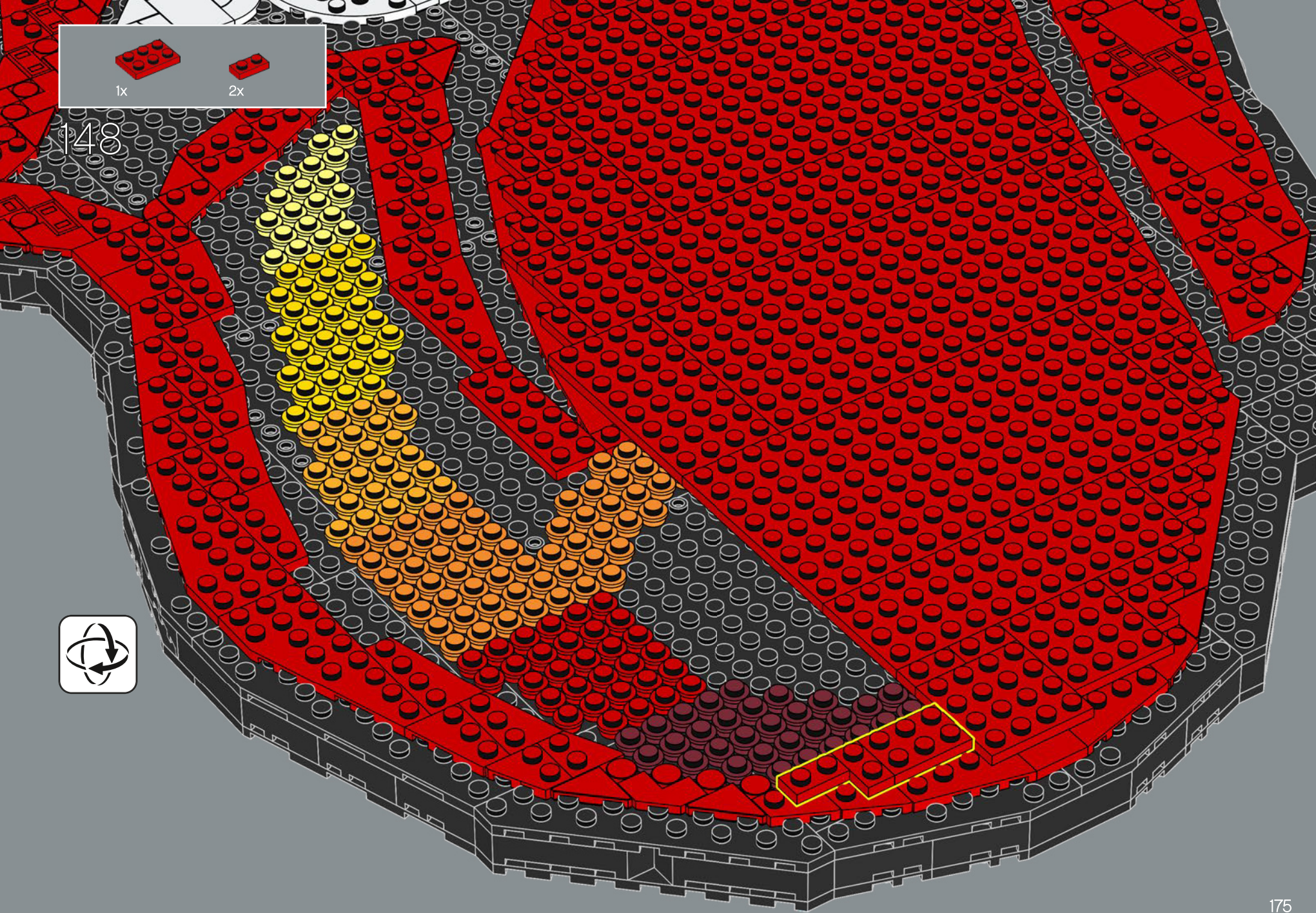

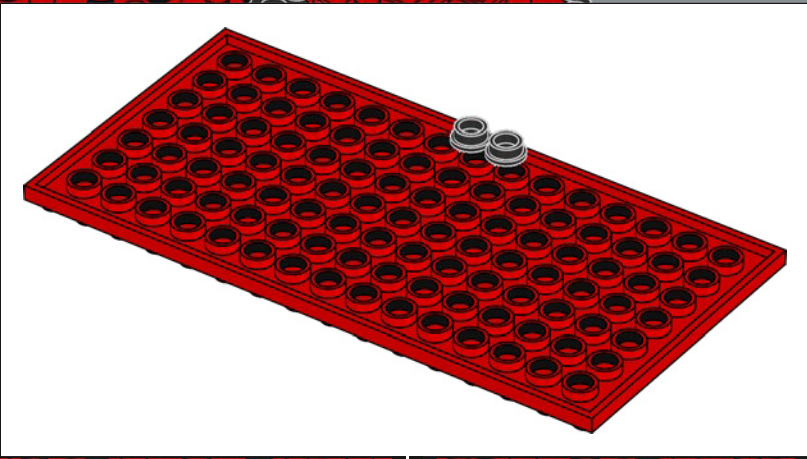
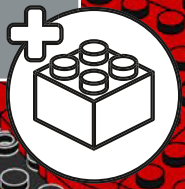
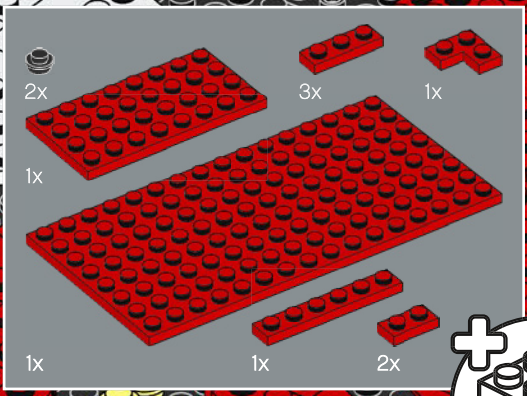

149

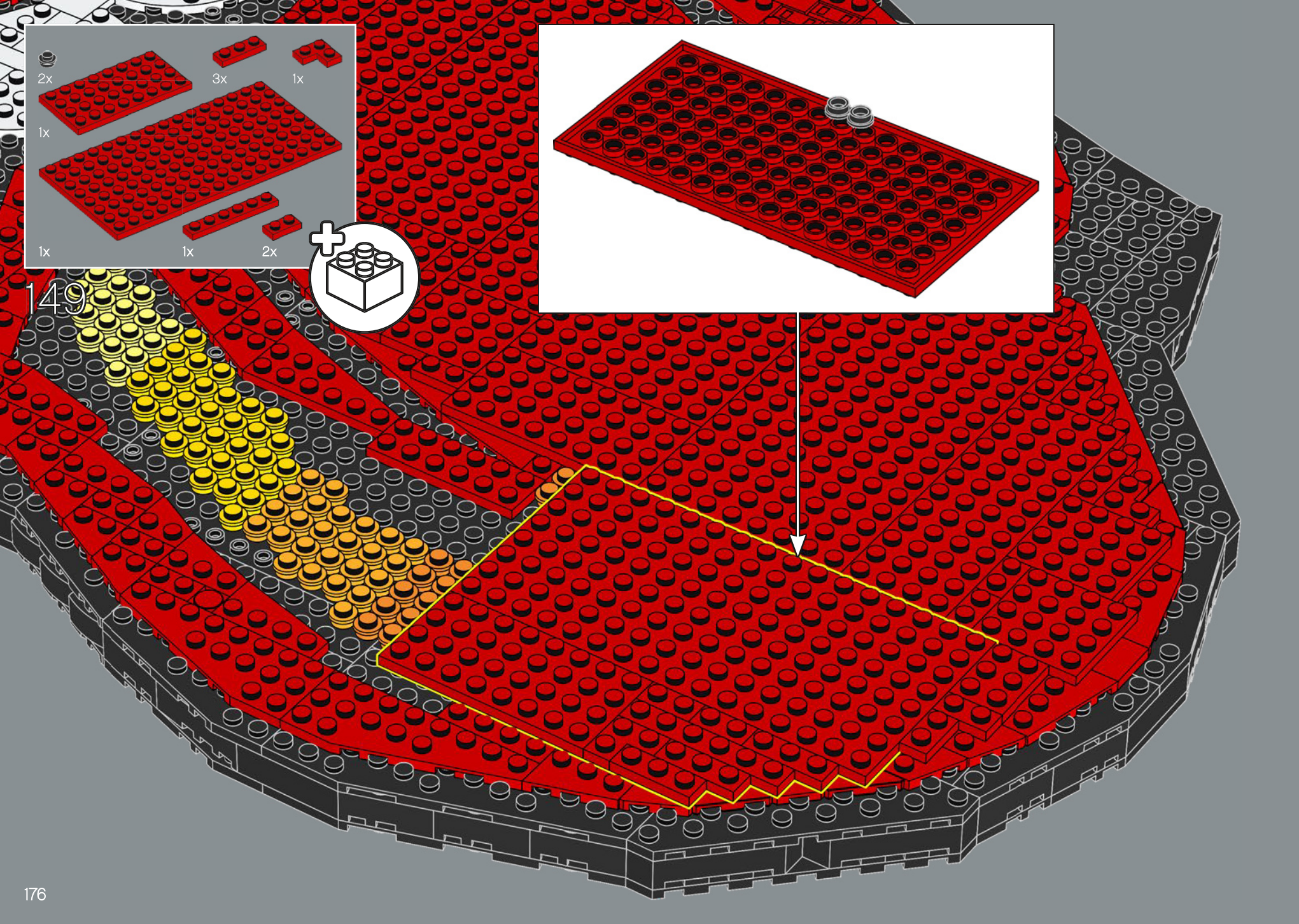



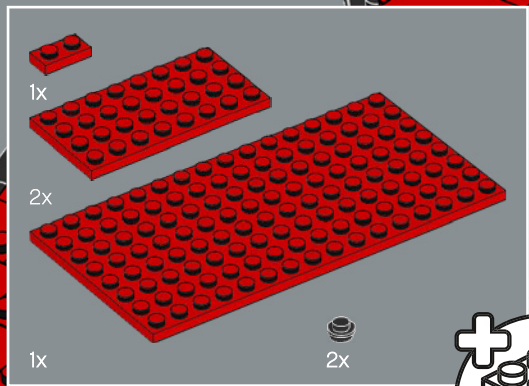

150

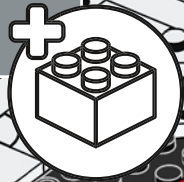

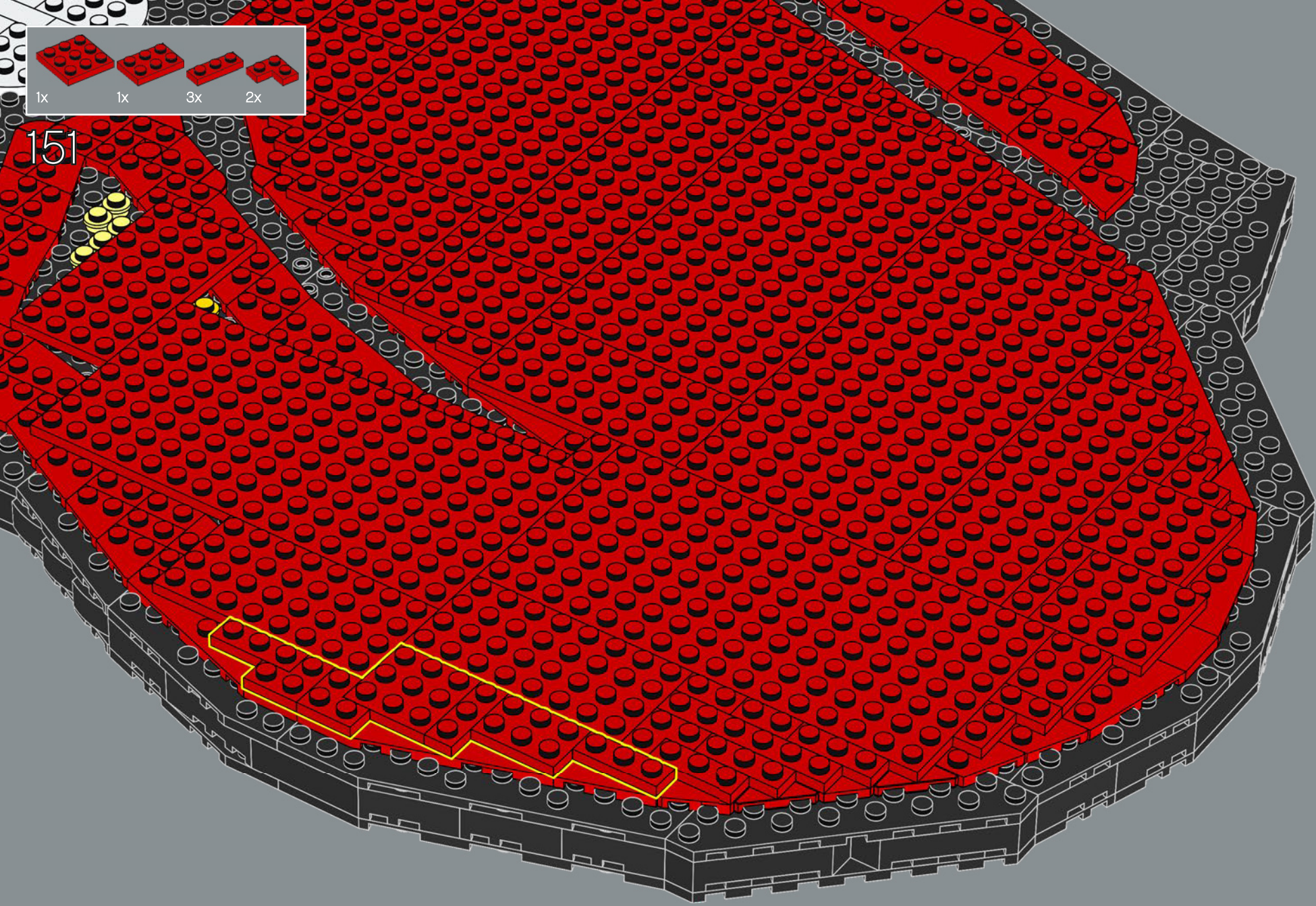

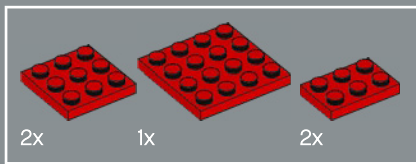

152

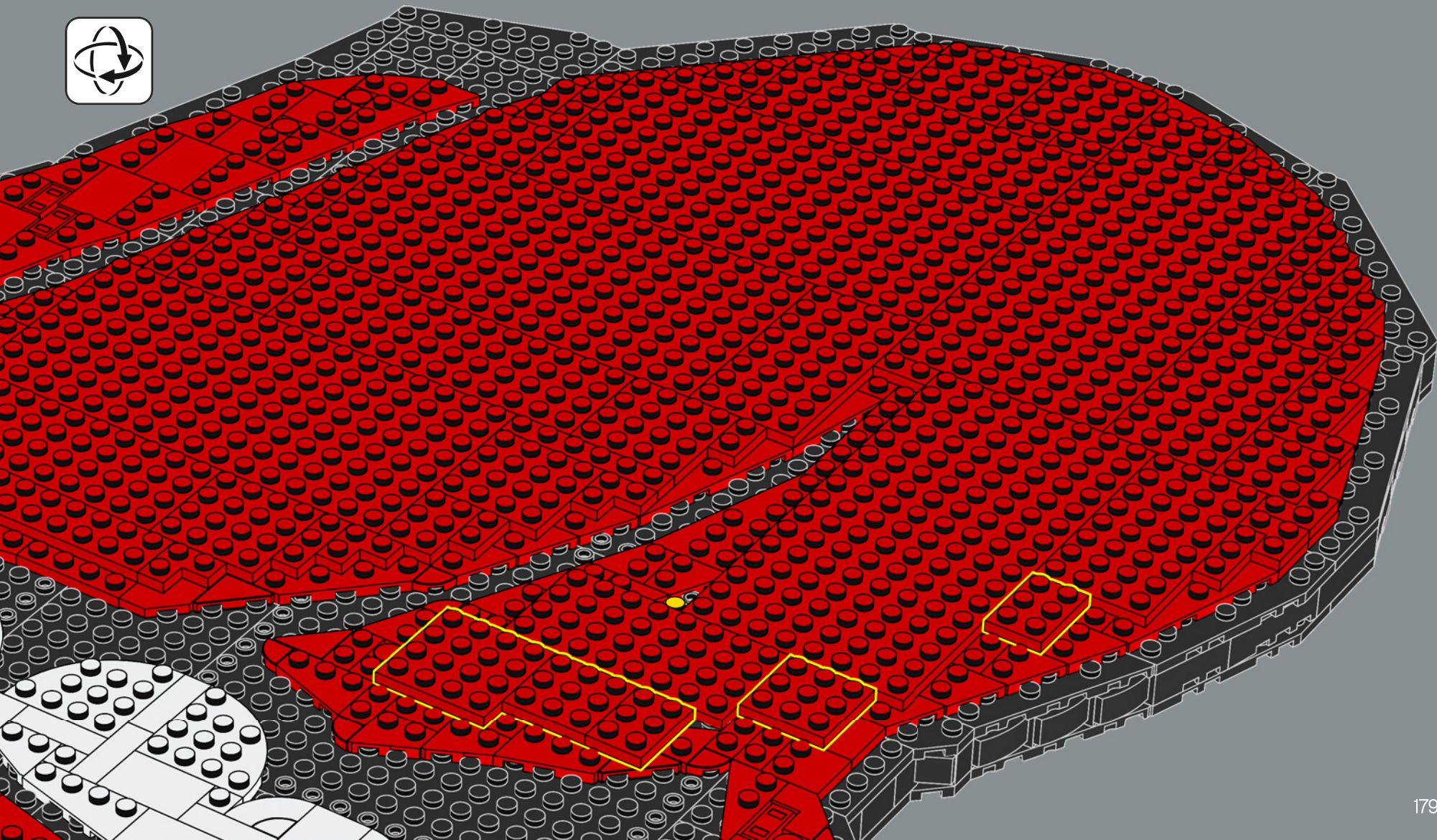



153

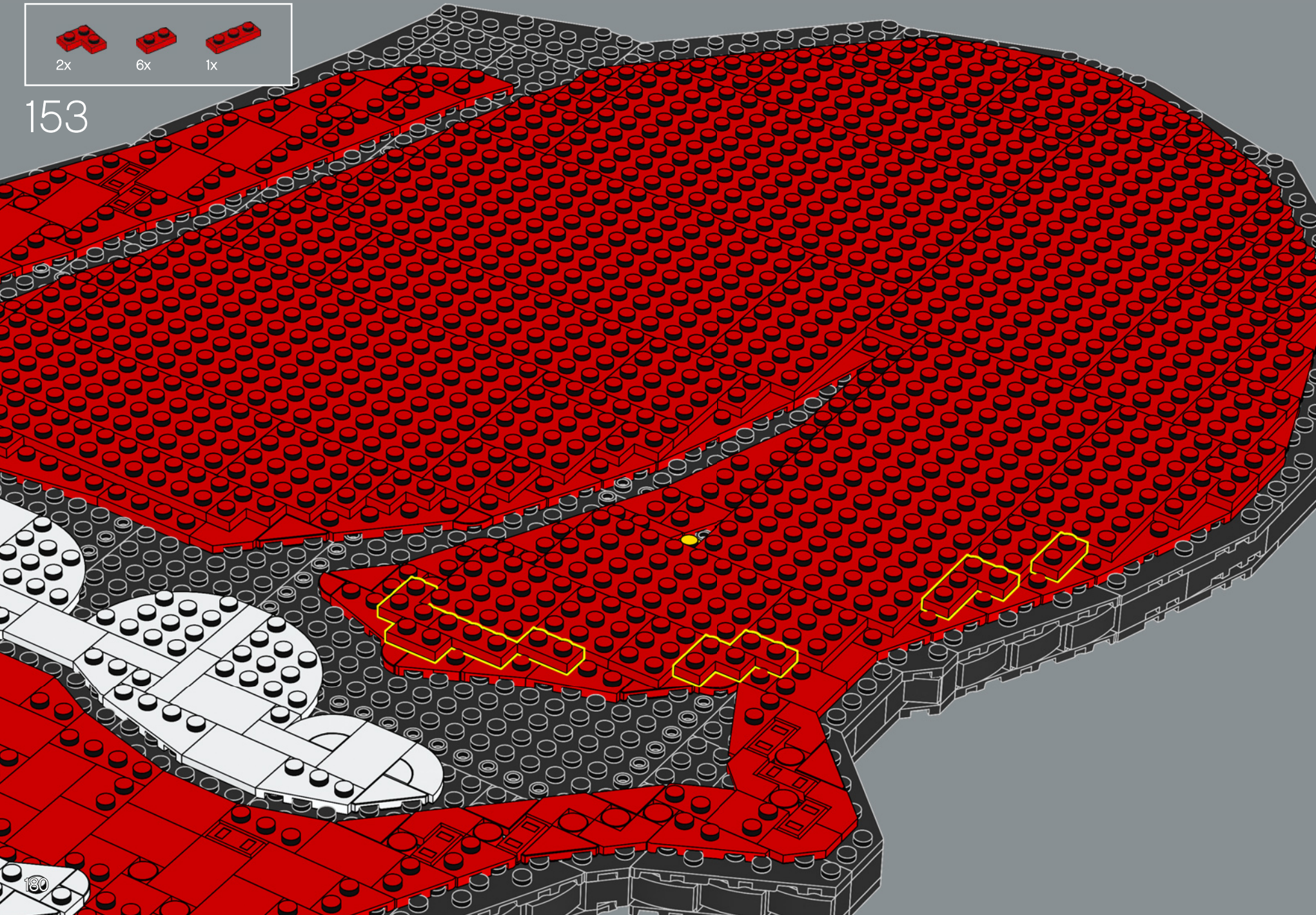

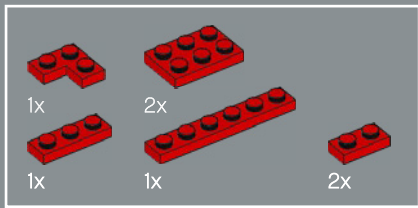

154

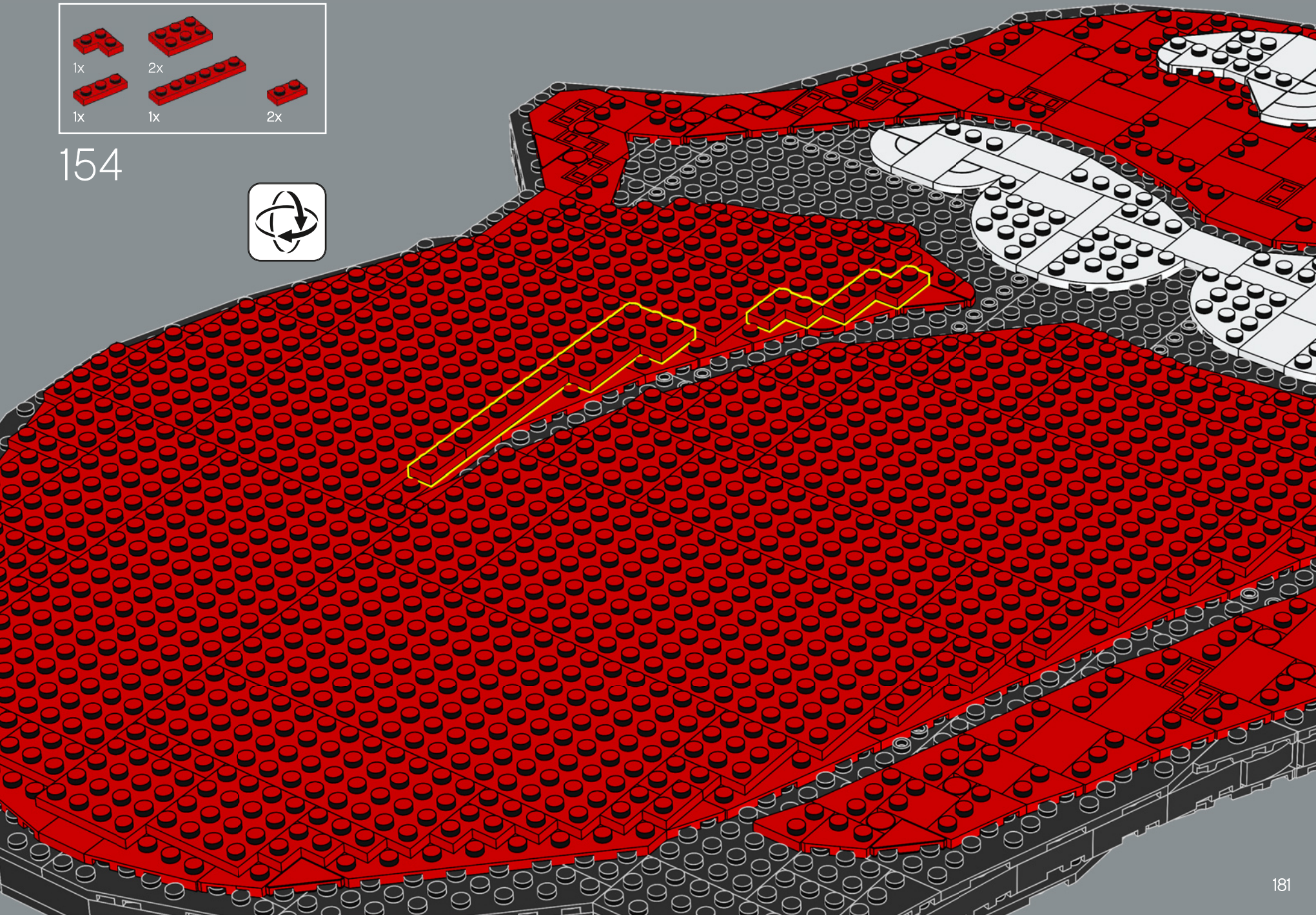



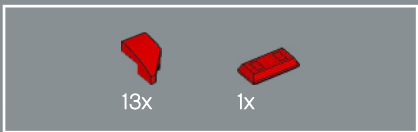

155

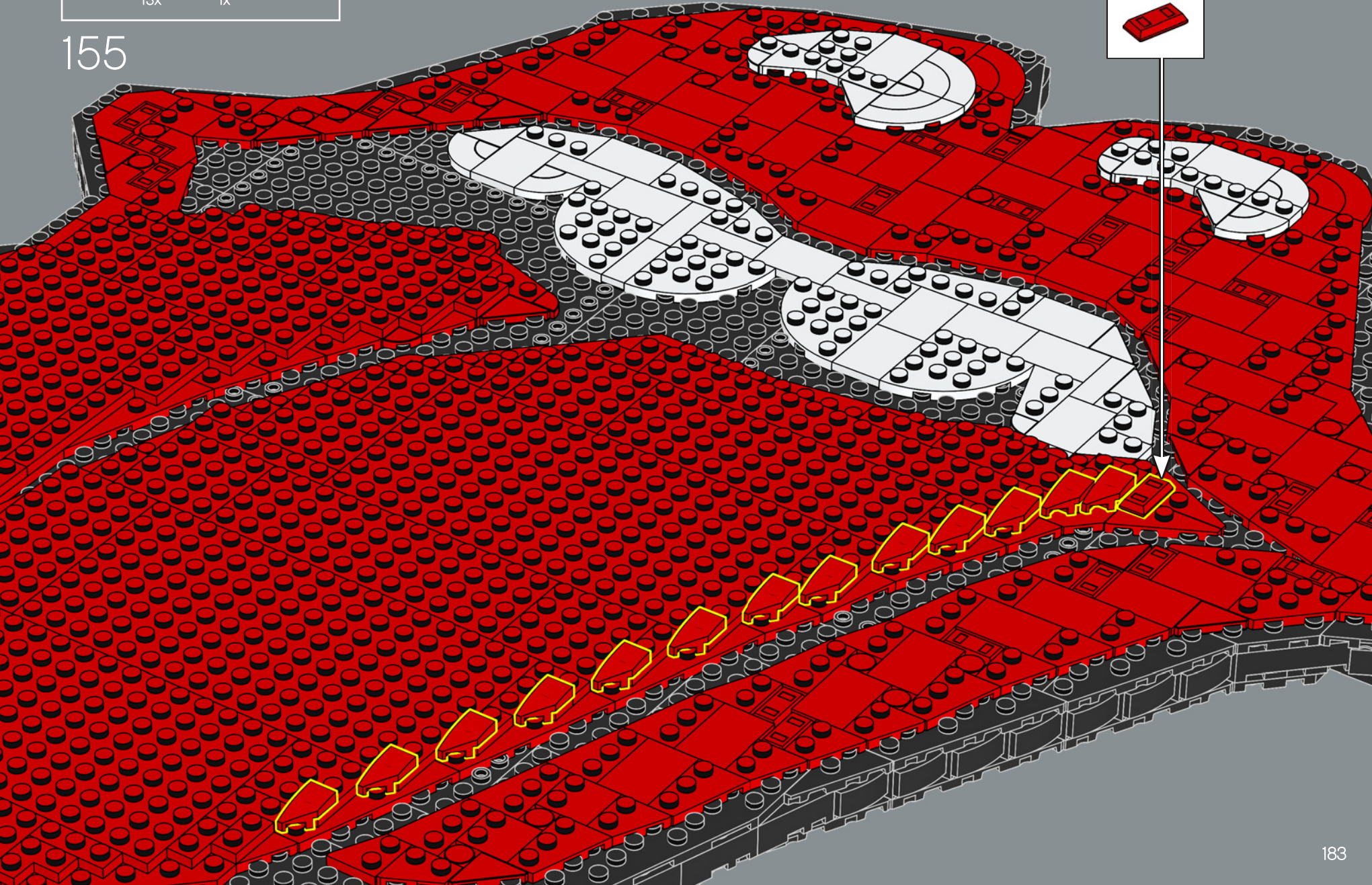

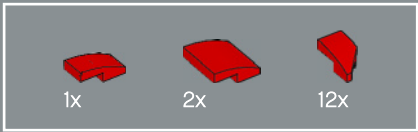

156

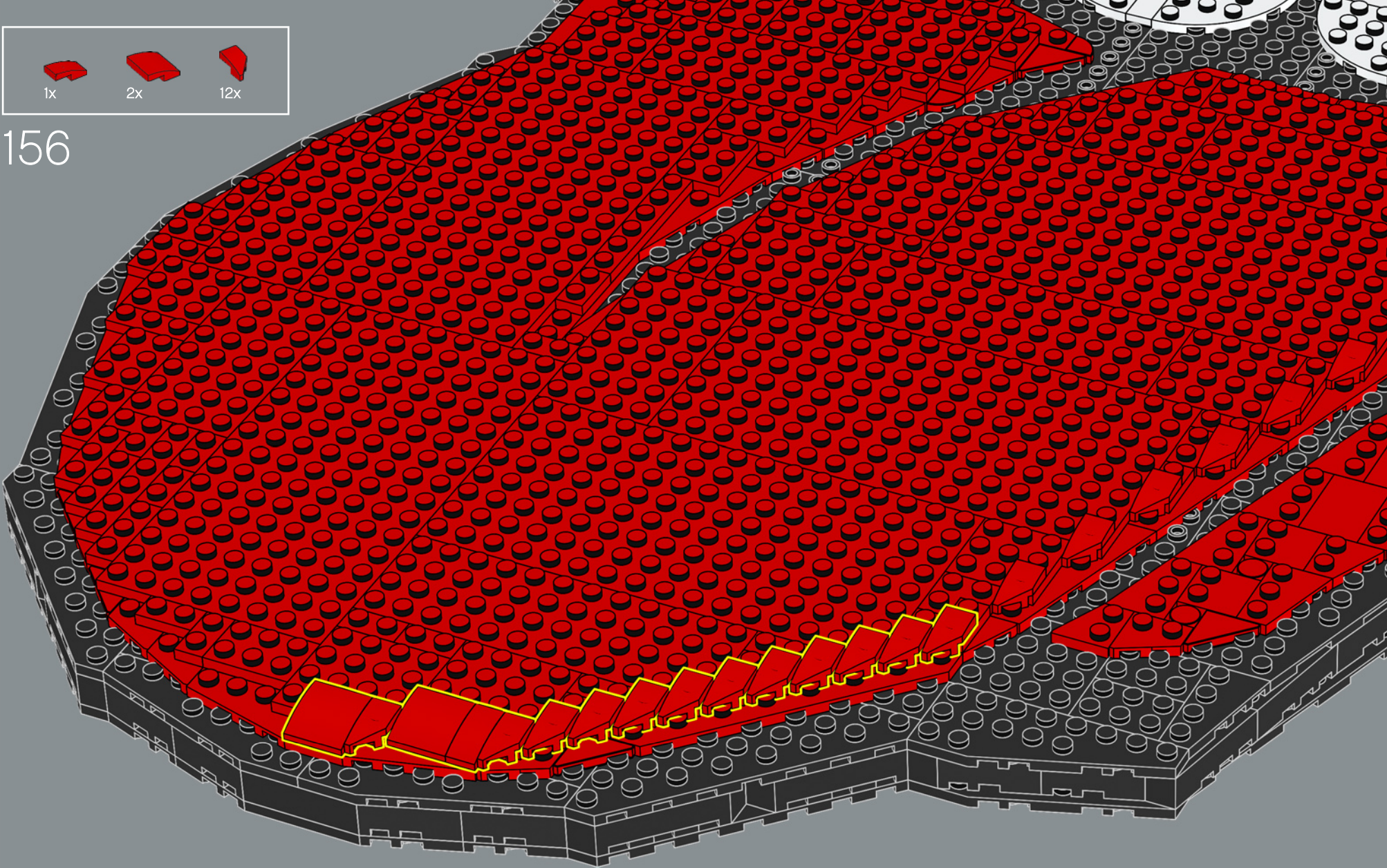



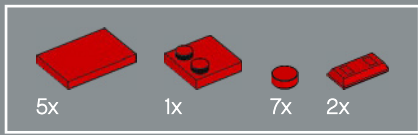

157

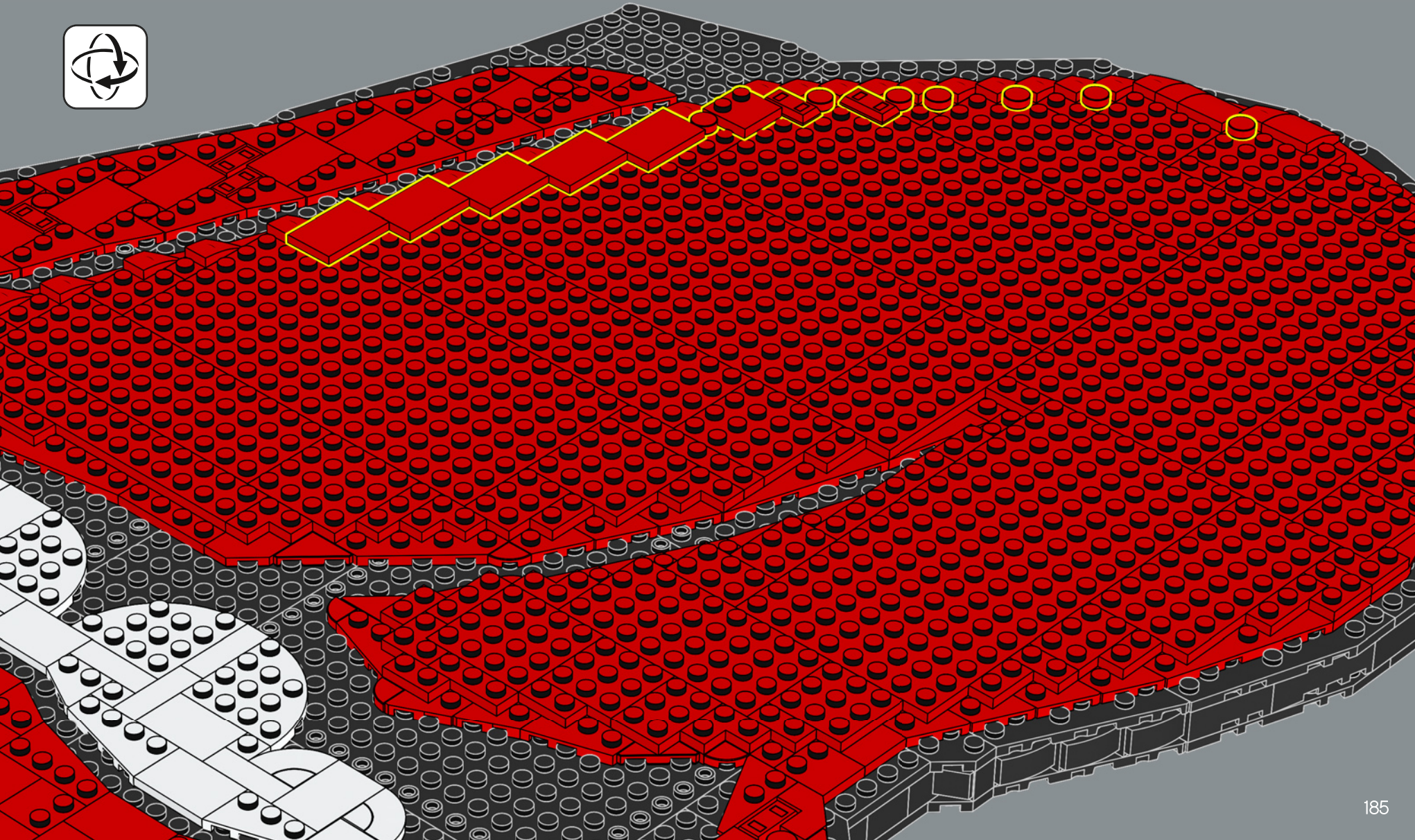

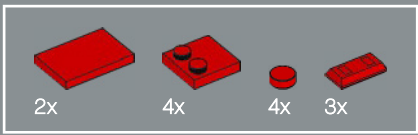

158

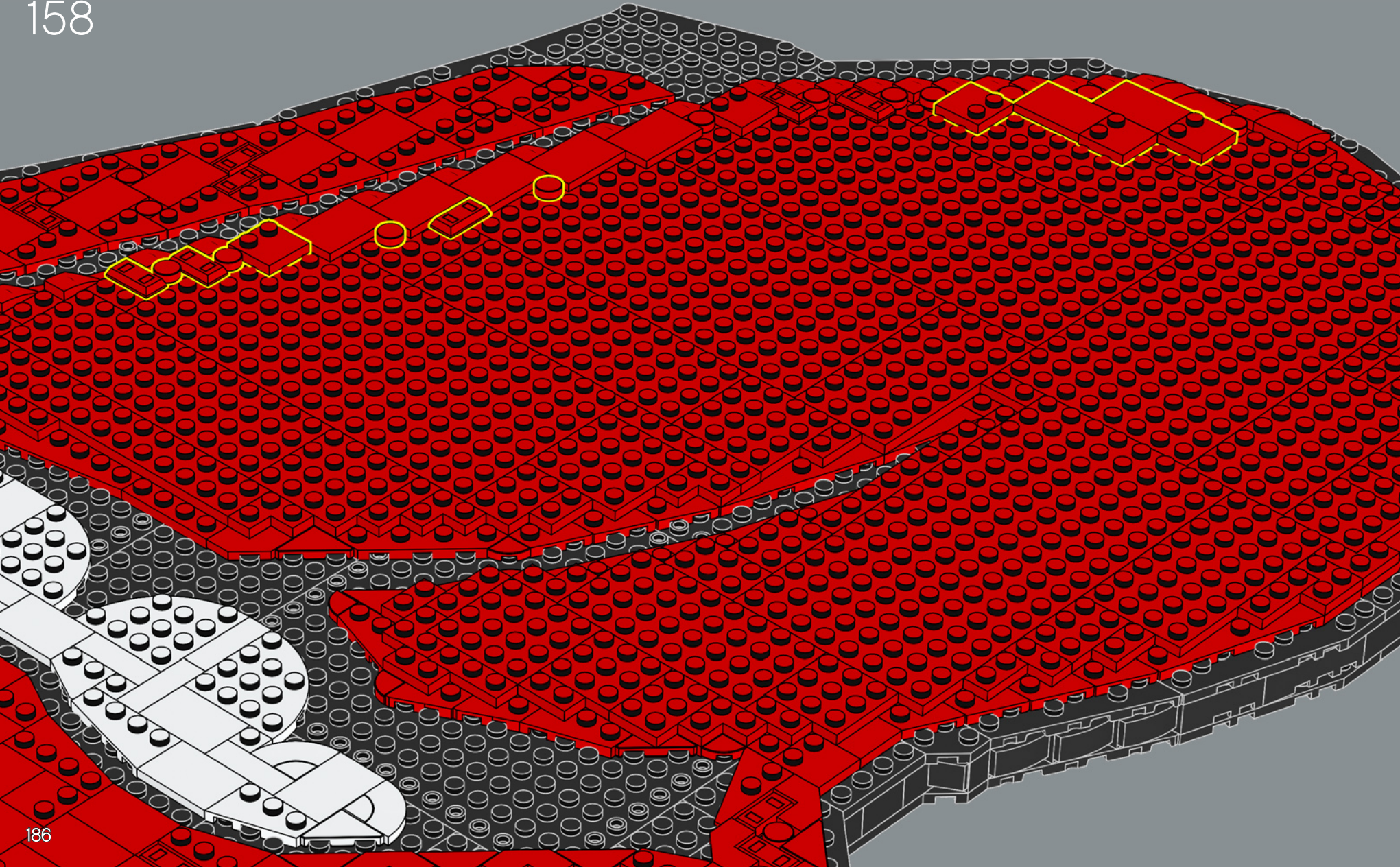

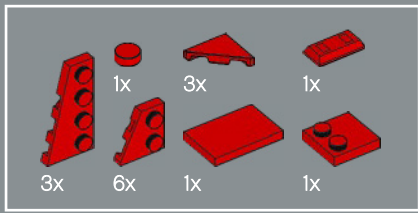

159

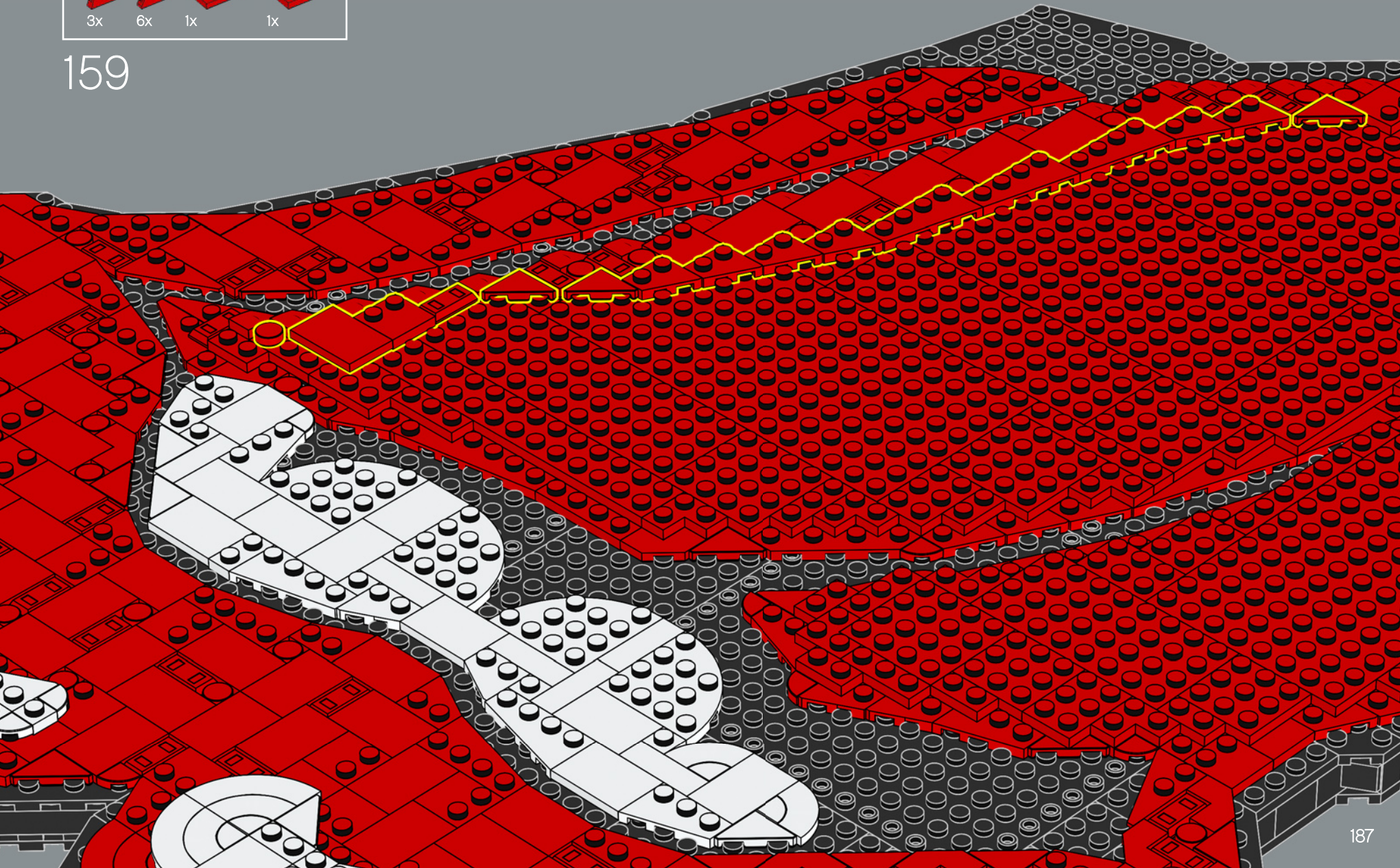

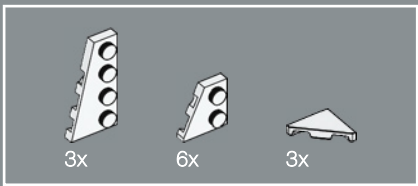

160

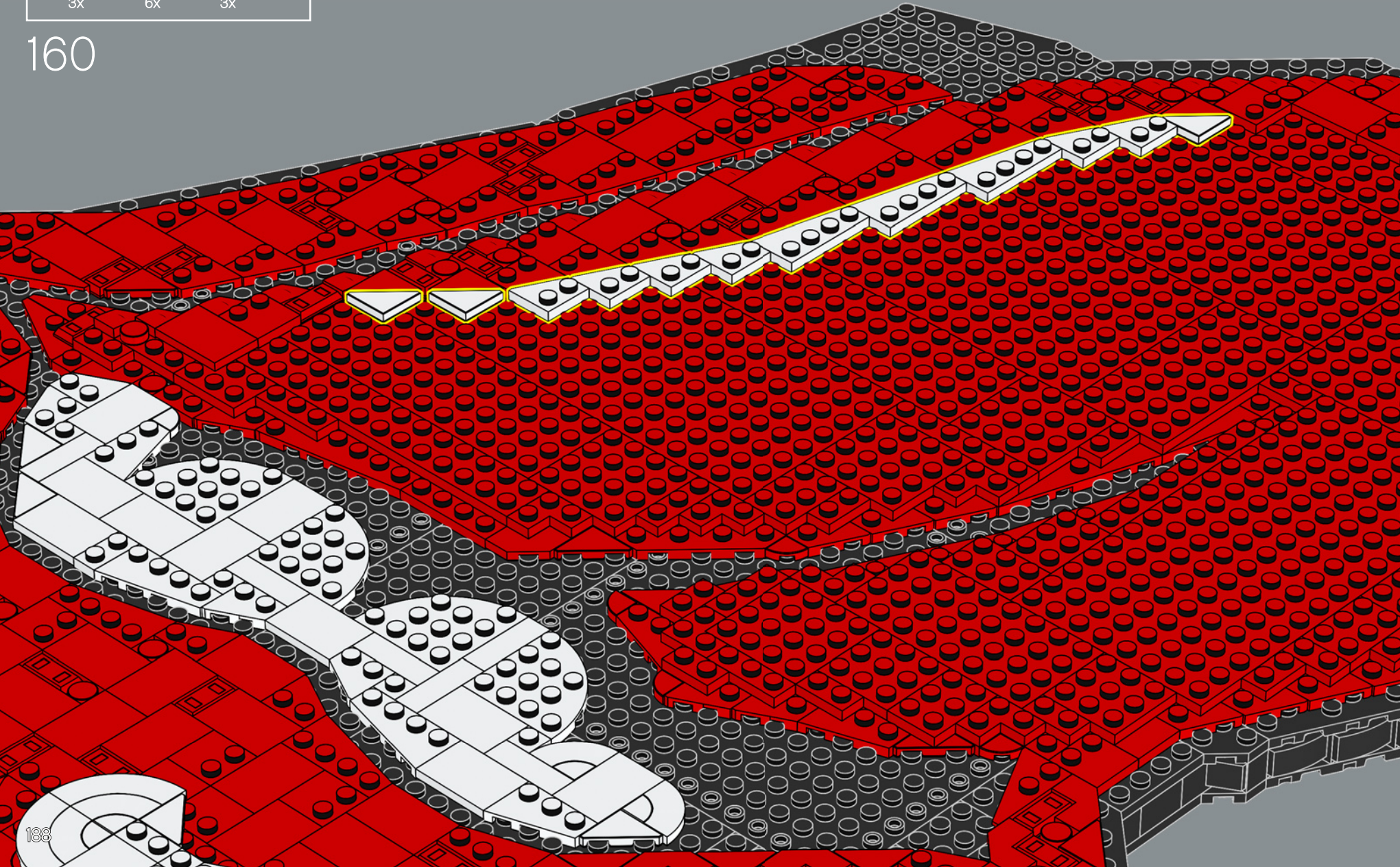

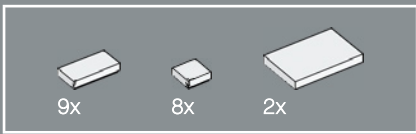

161

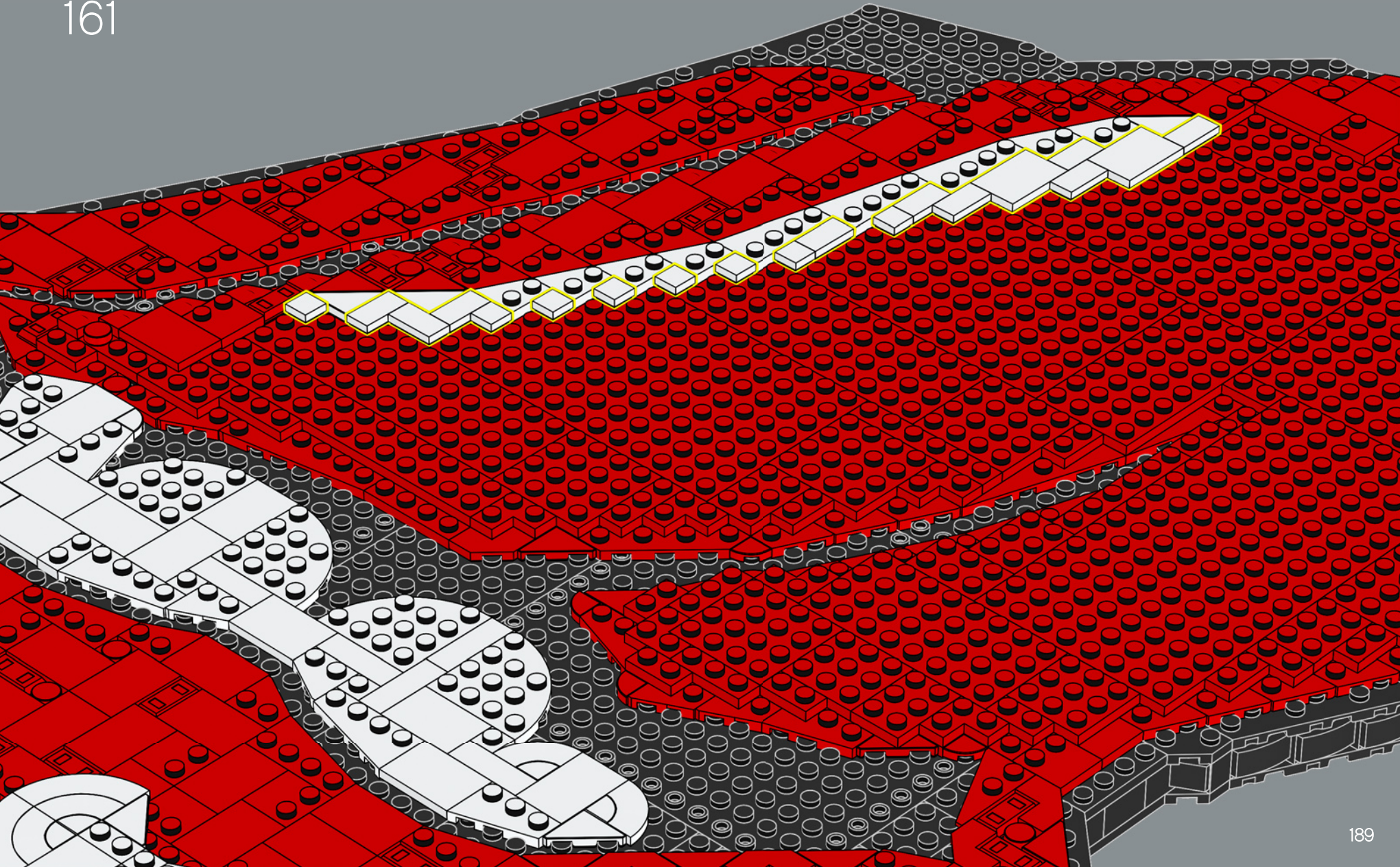

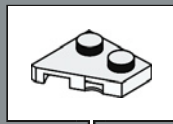
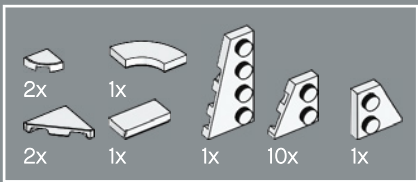

162

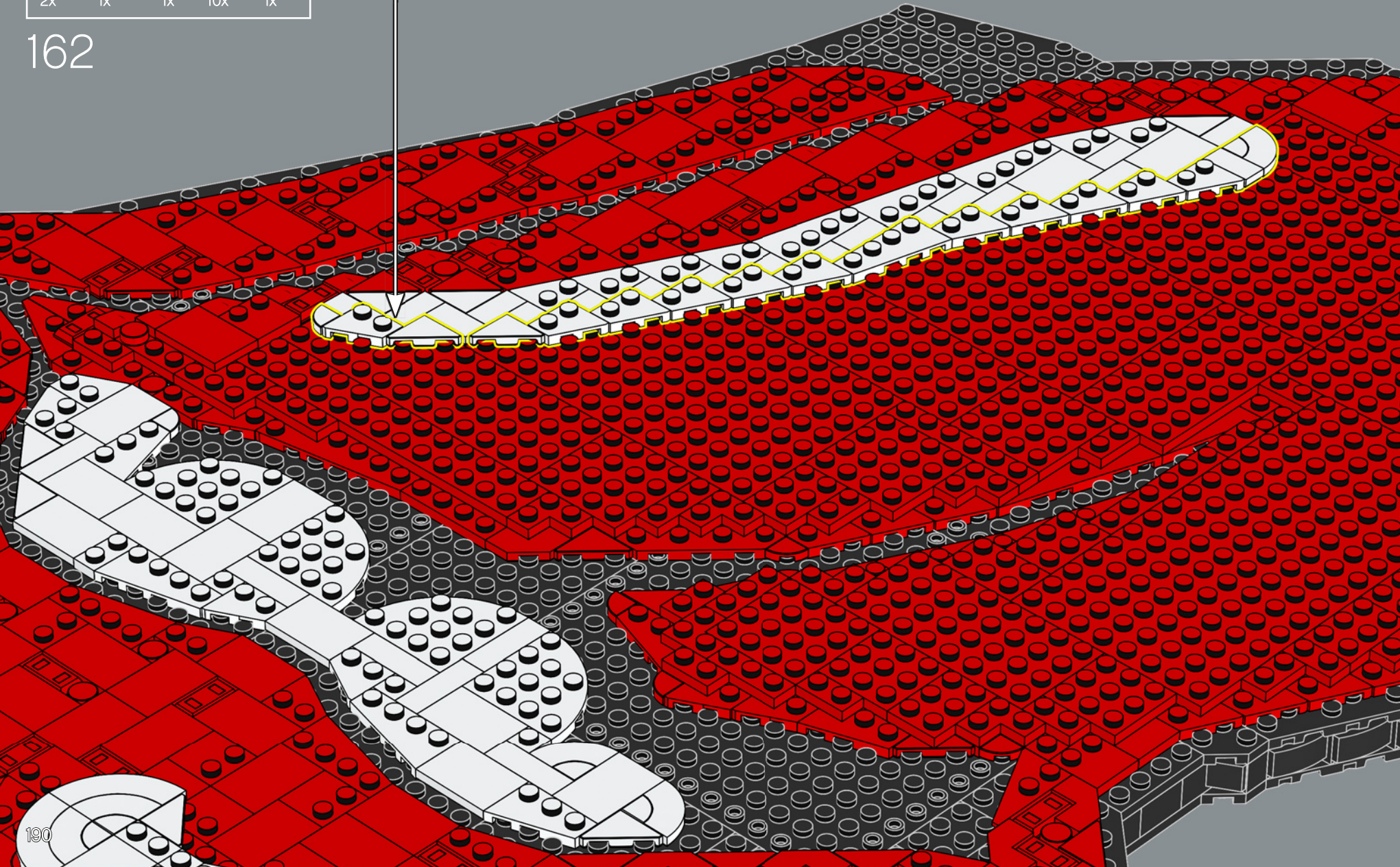

190

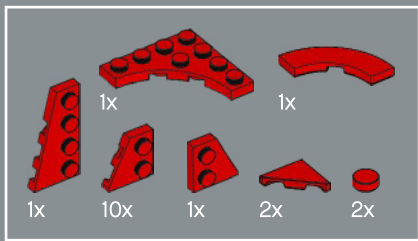

163

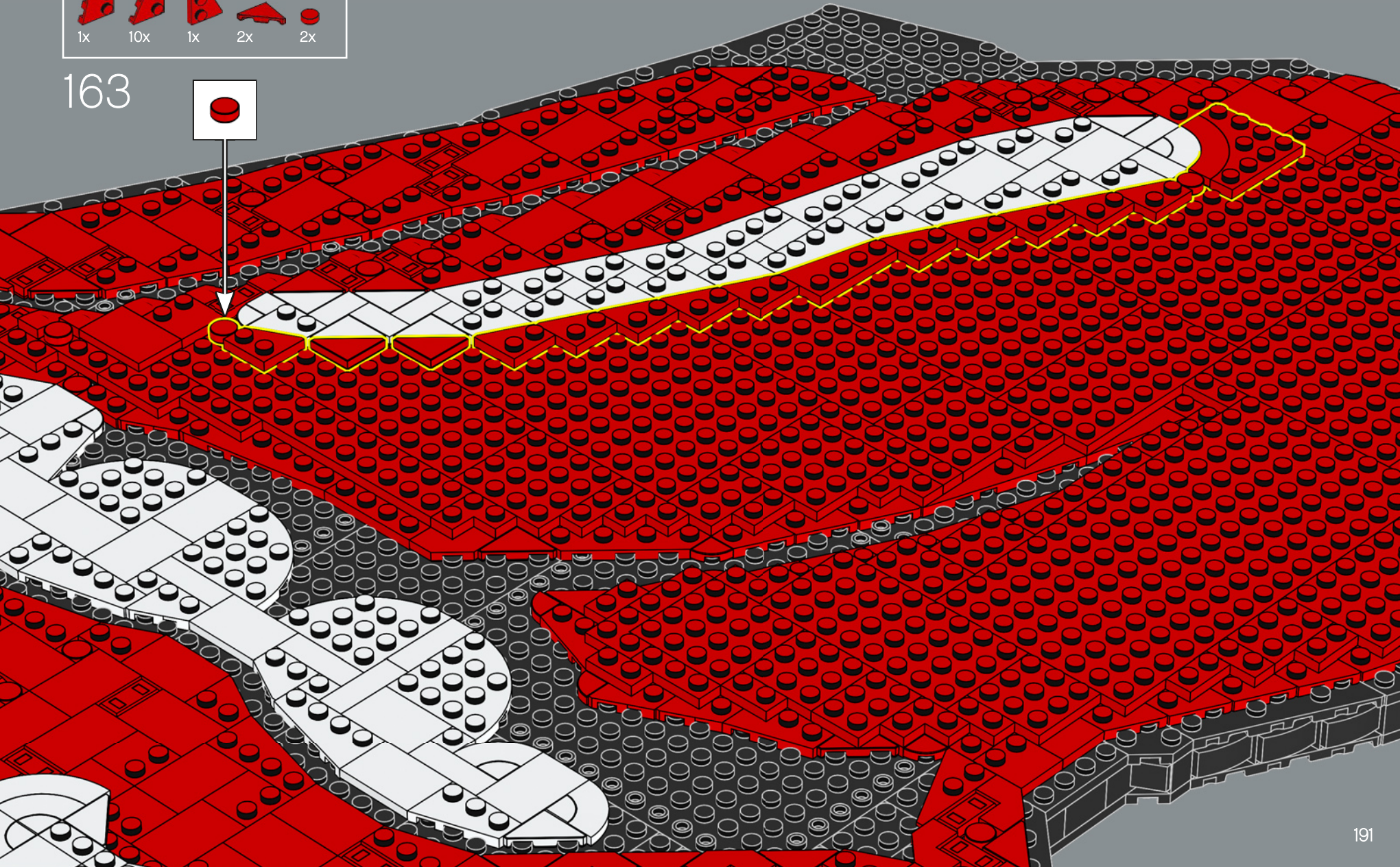

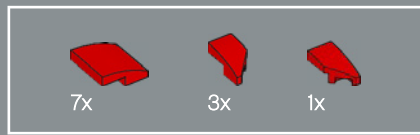

164

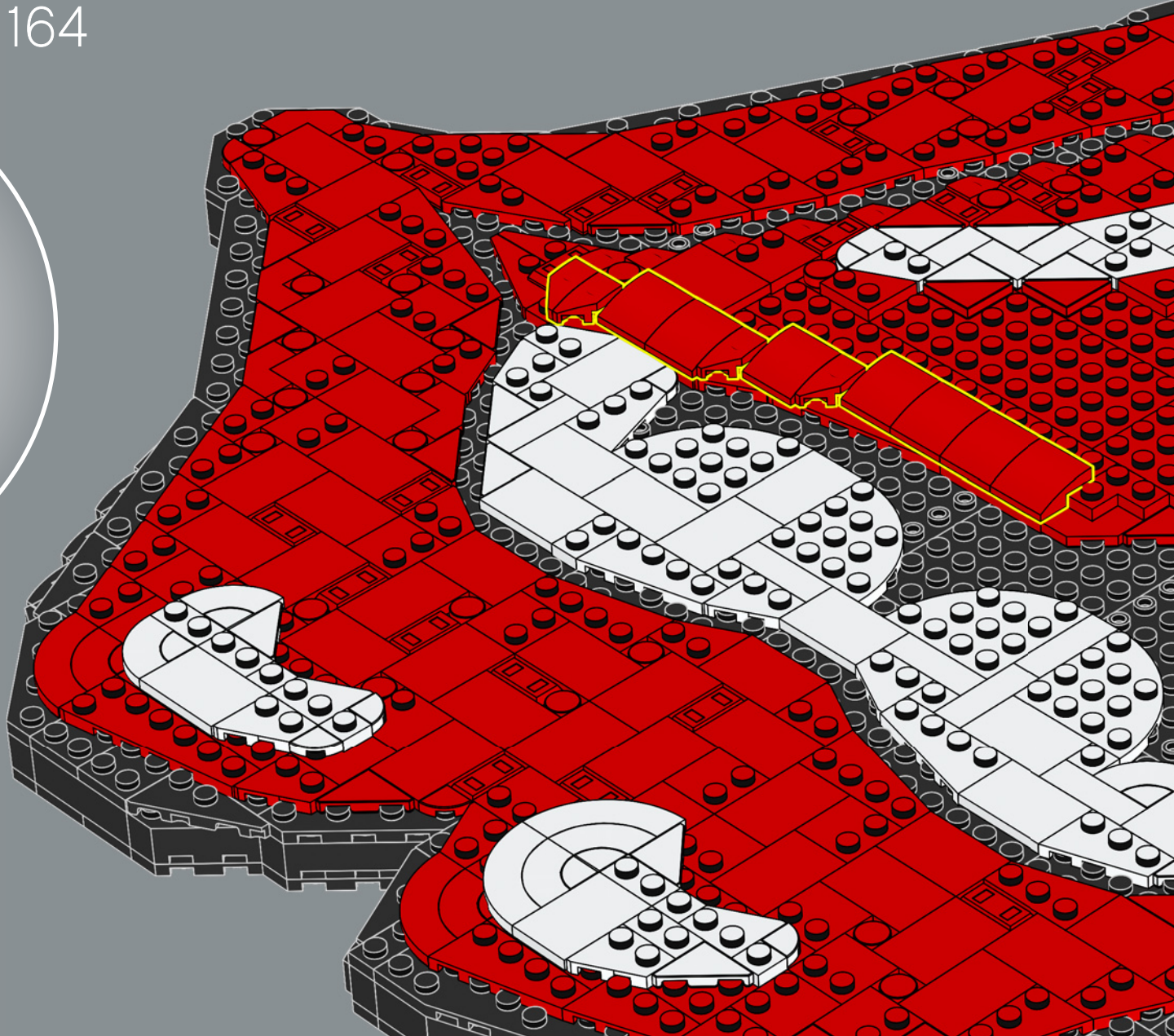





165

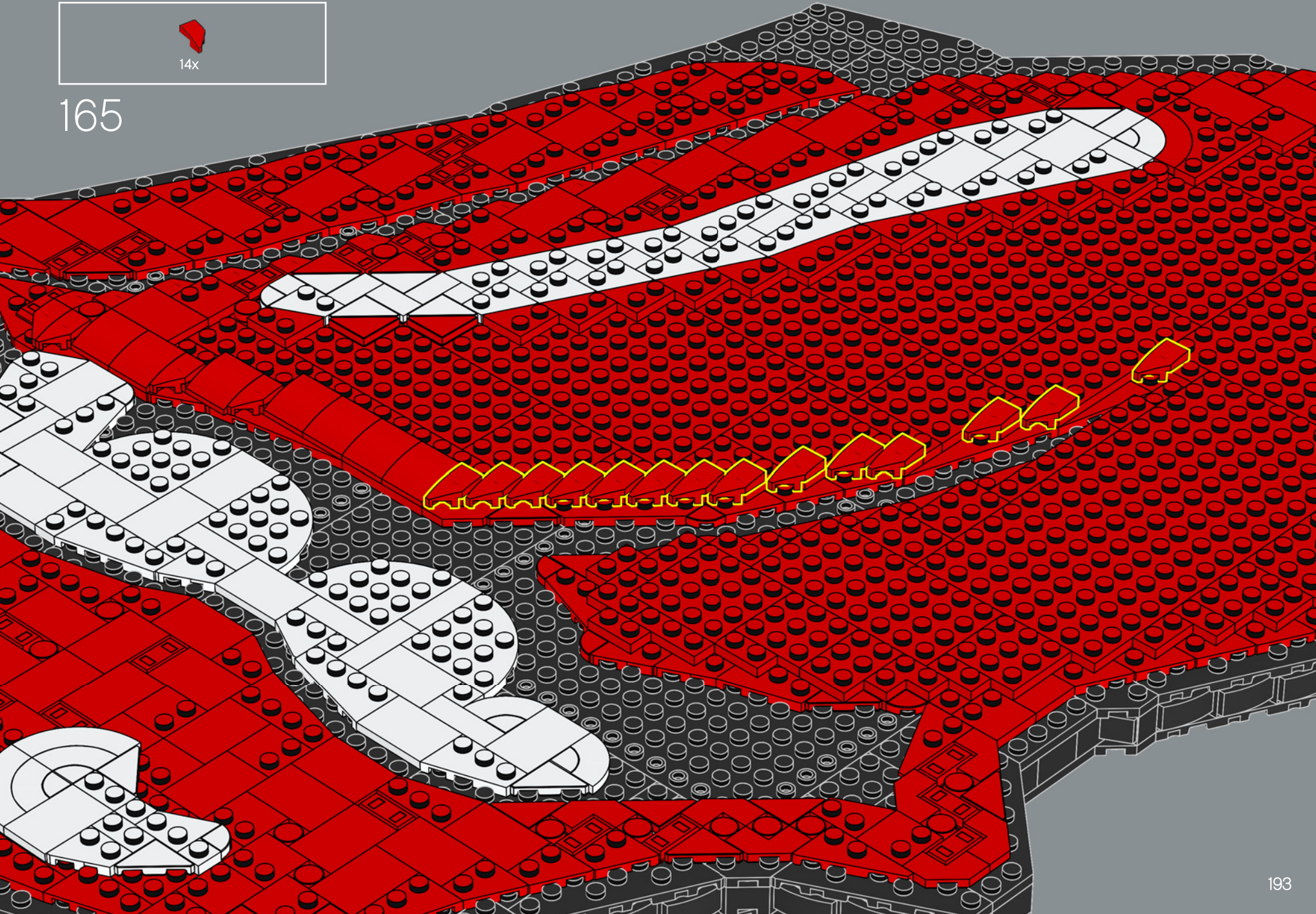

3x 1x 12x



166

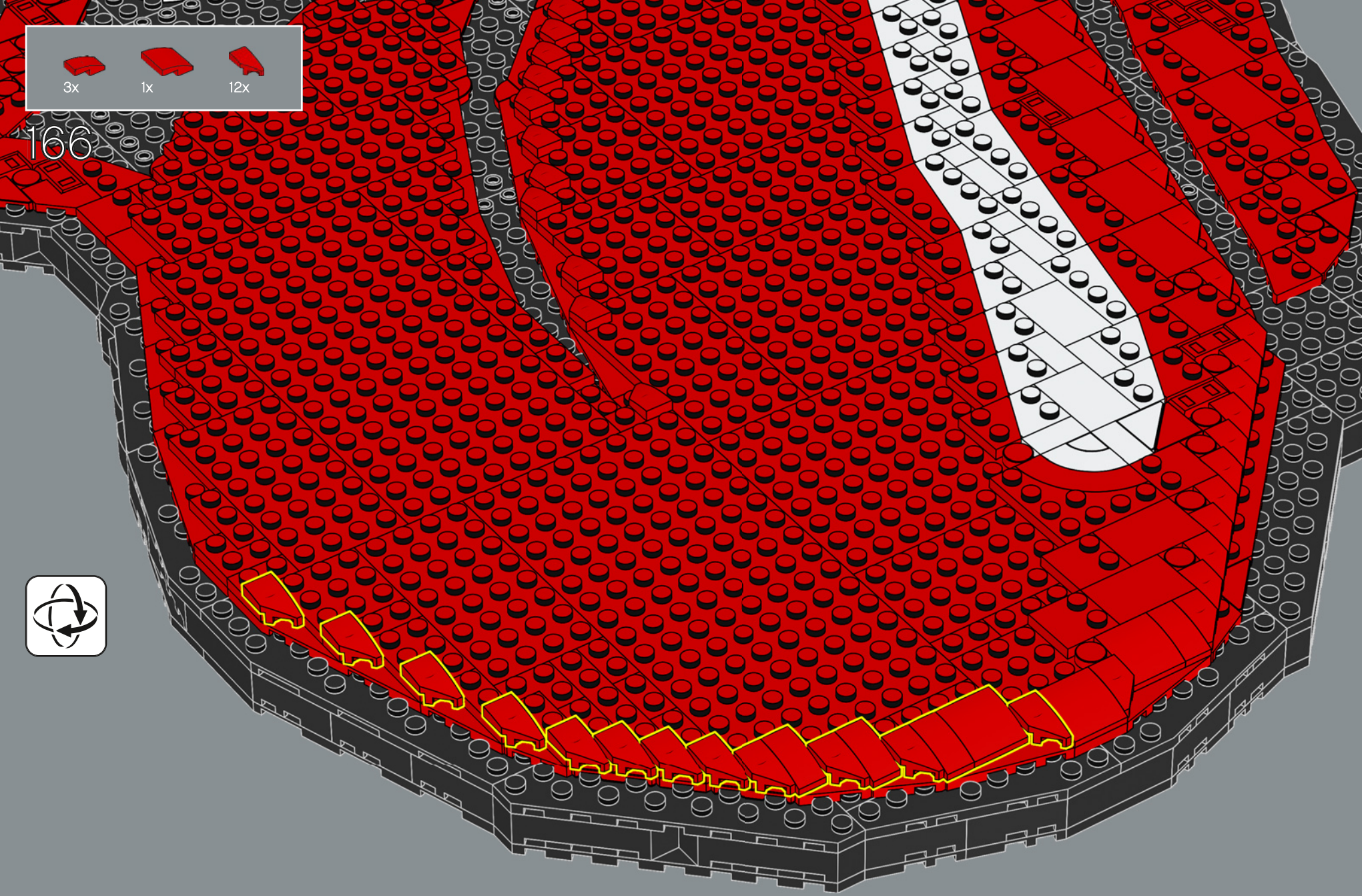

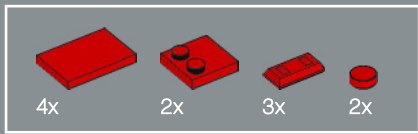

167

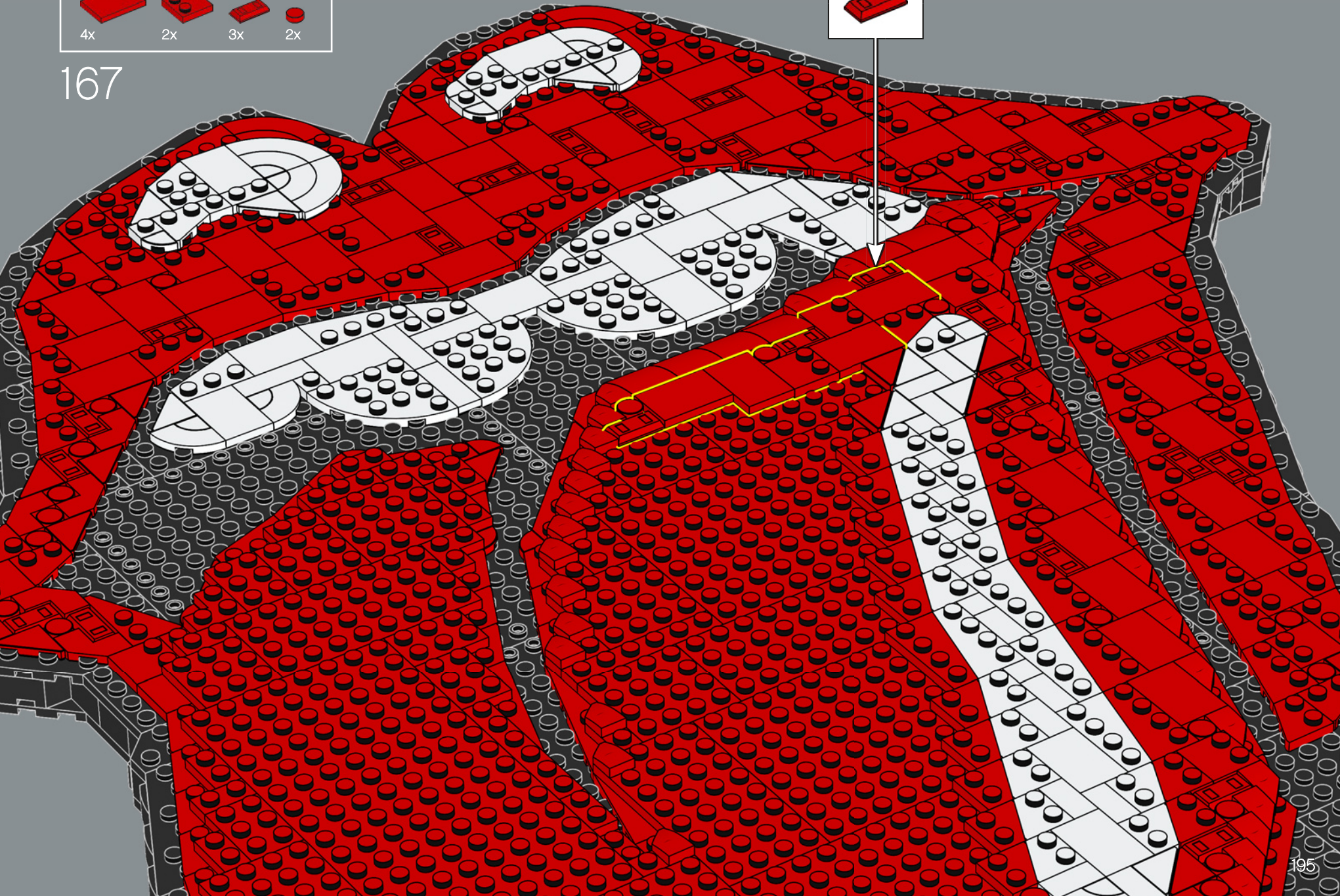

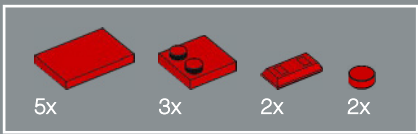

168

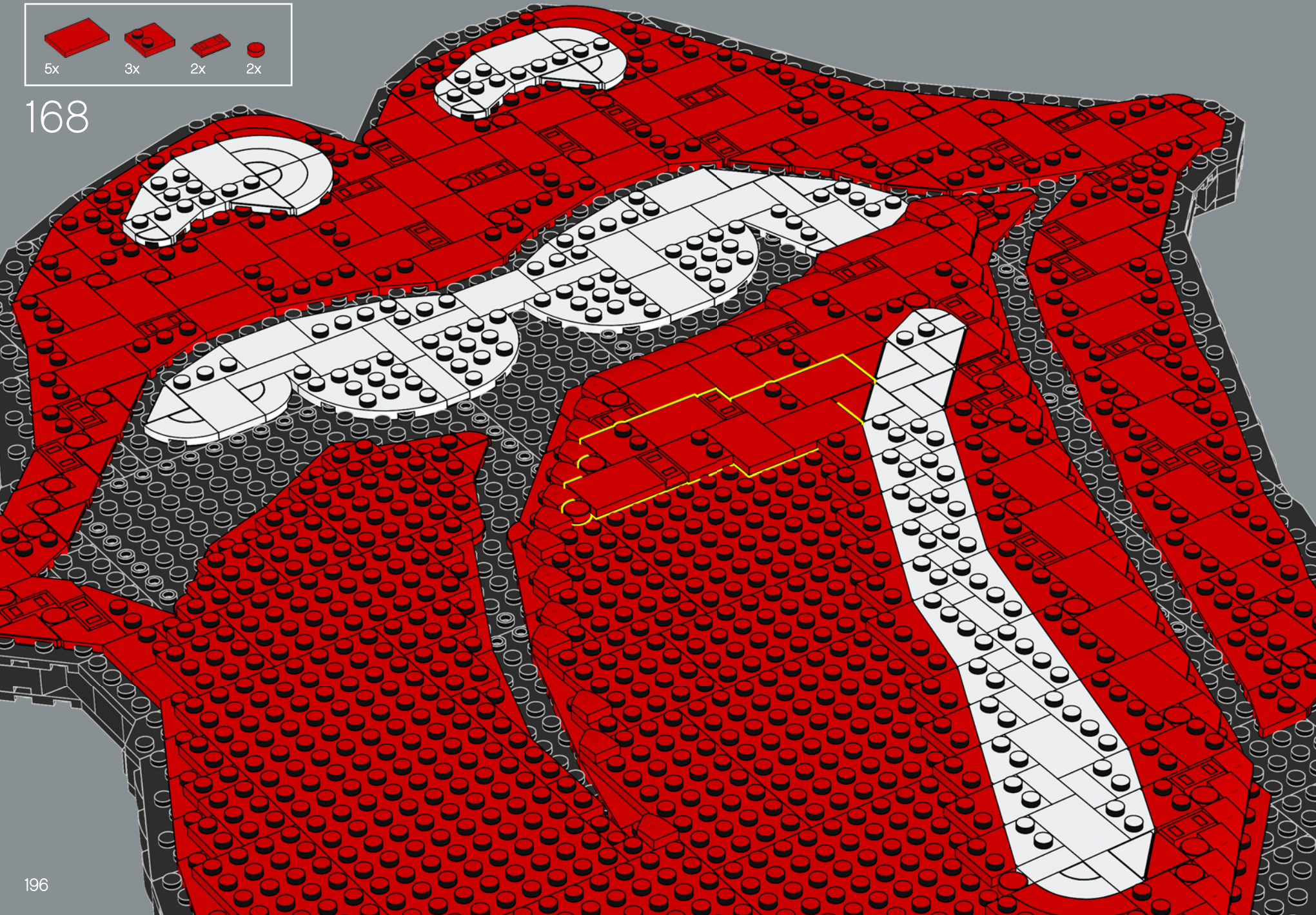

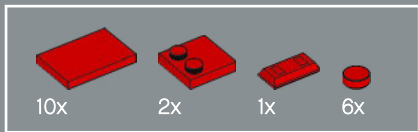

169

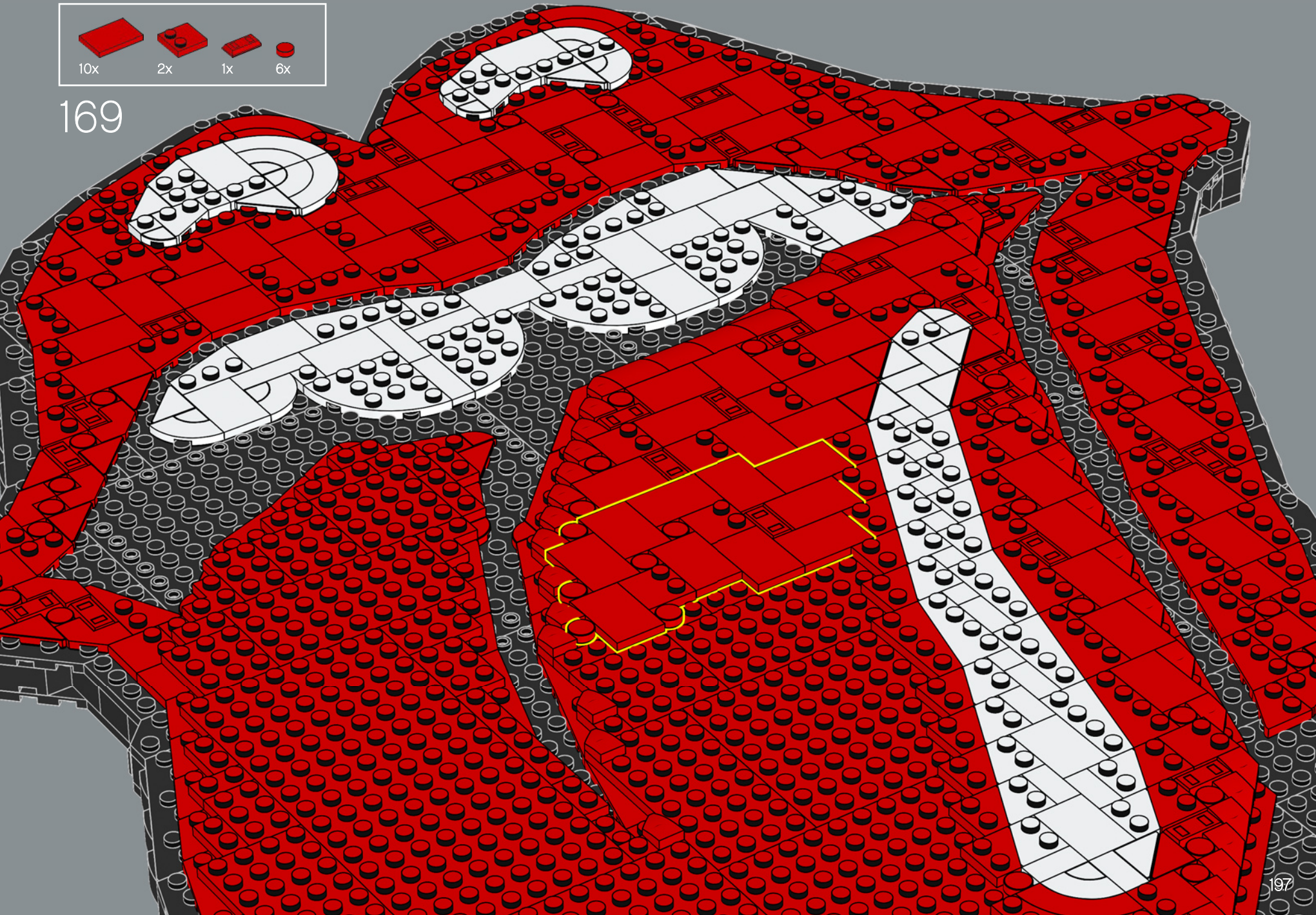

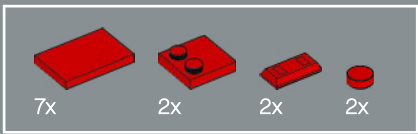

170

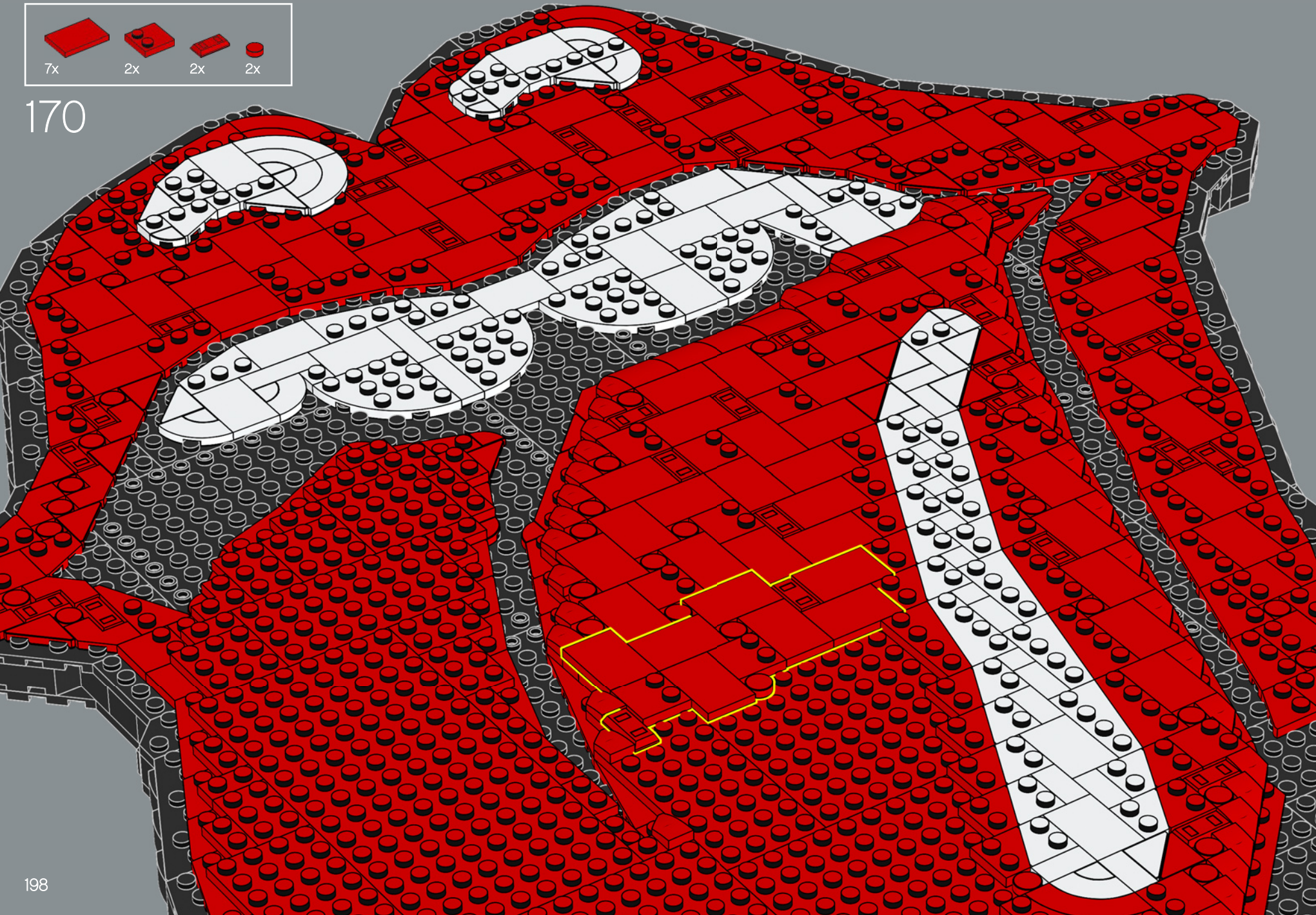

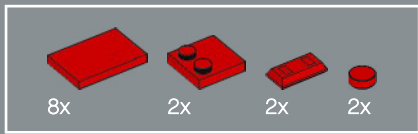

171

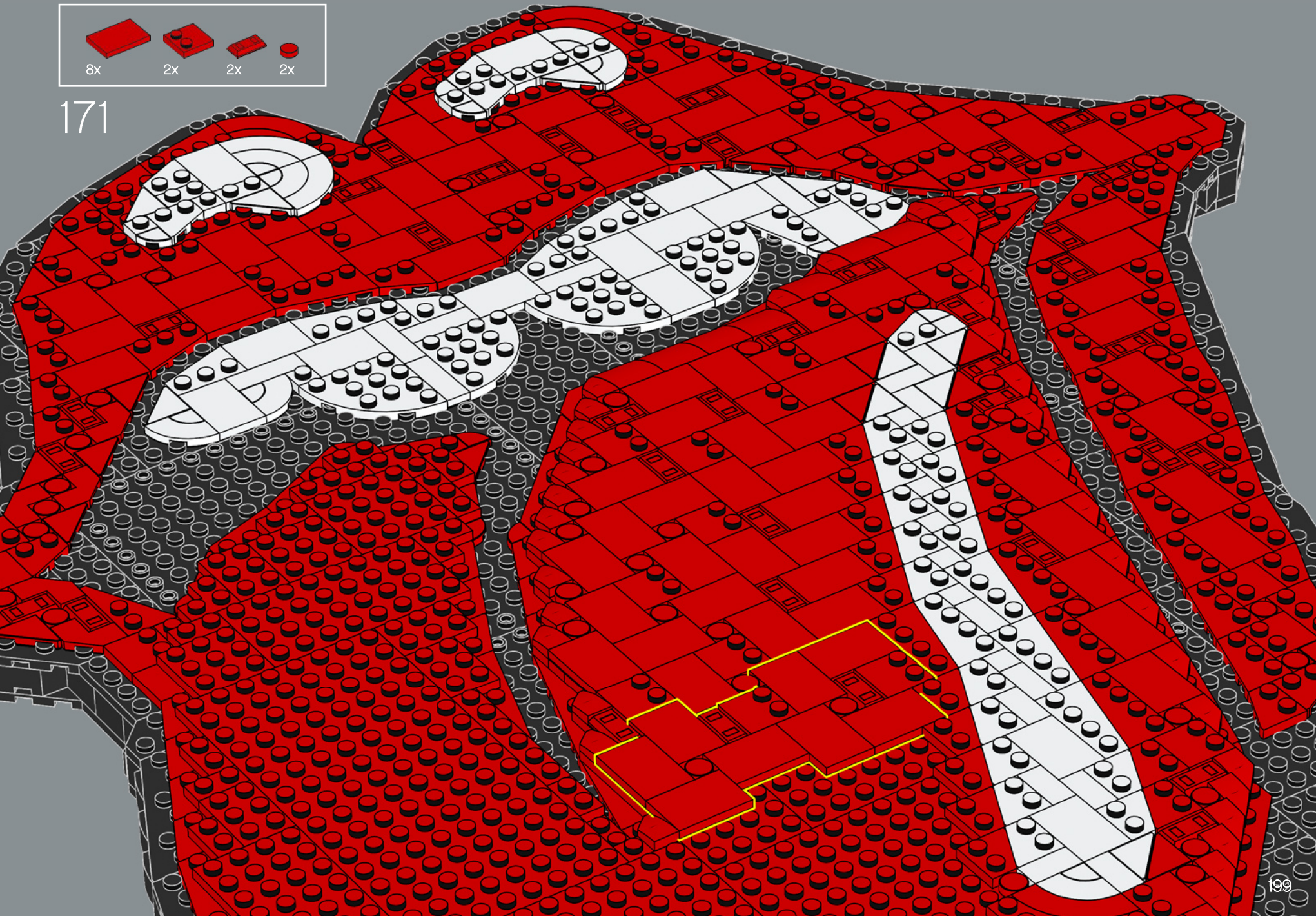

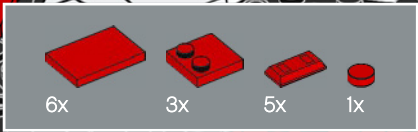

172

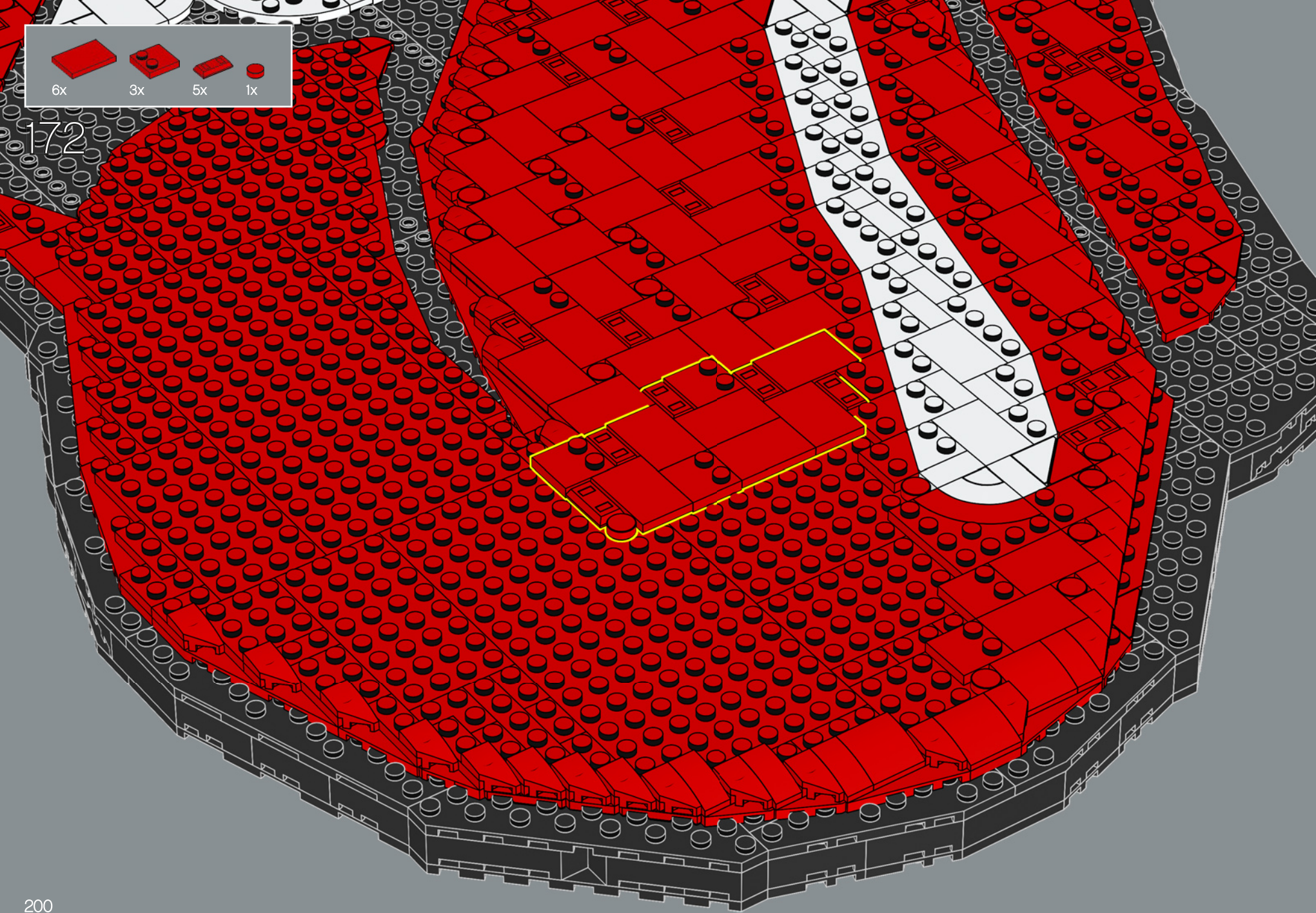



5x 6x 2x 1x

173

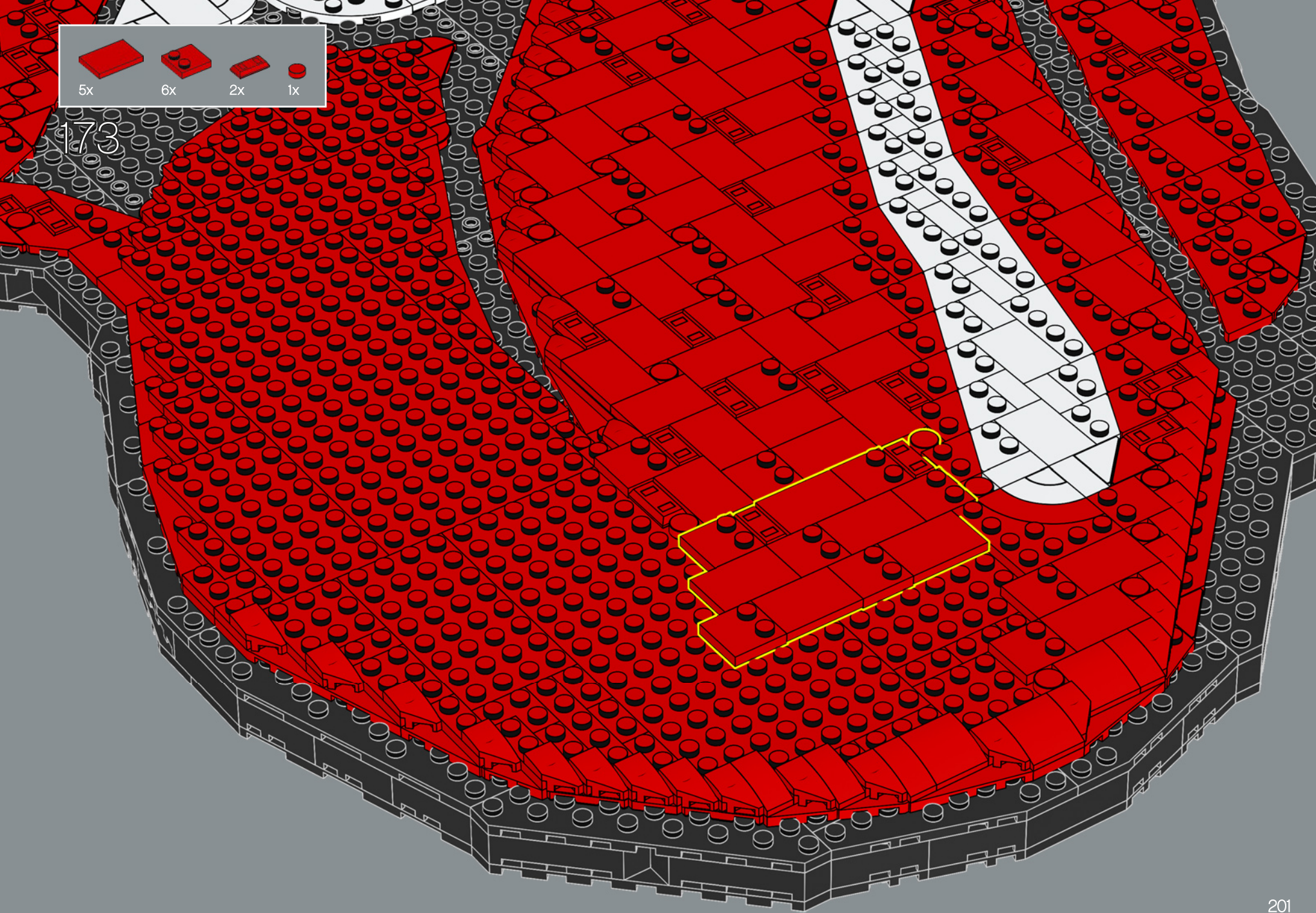

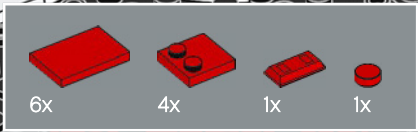

174

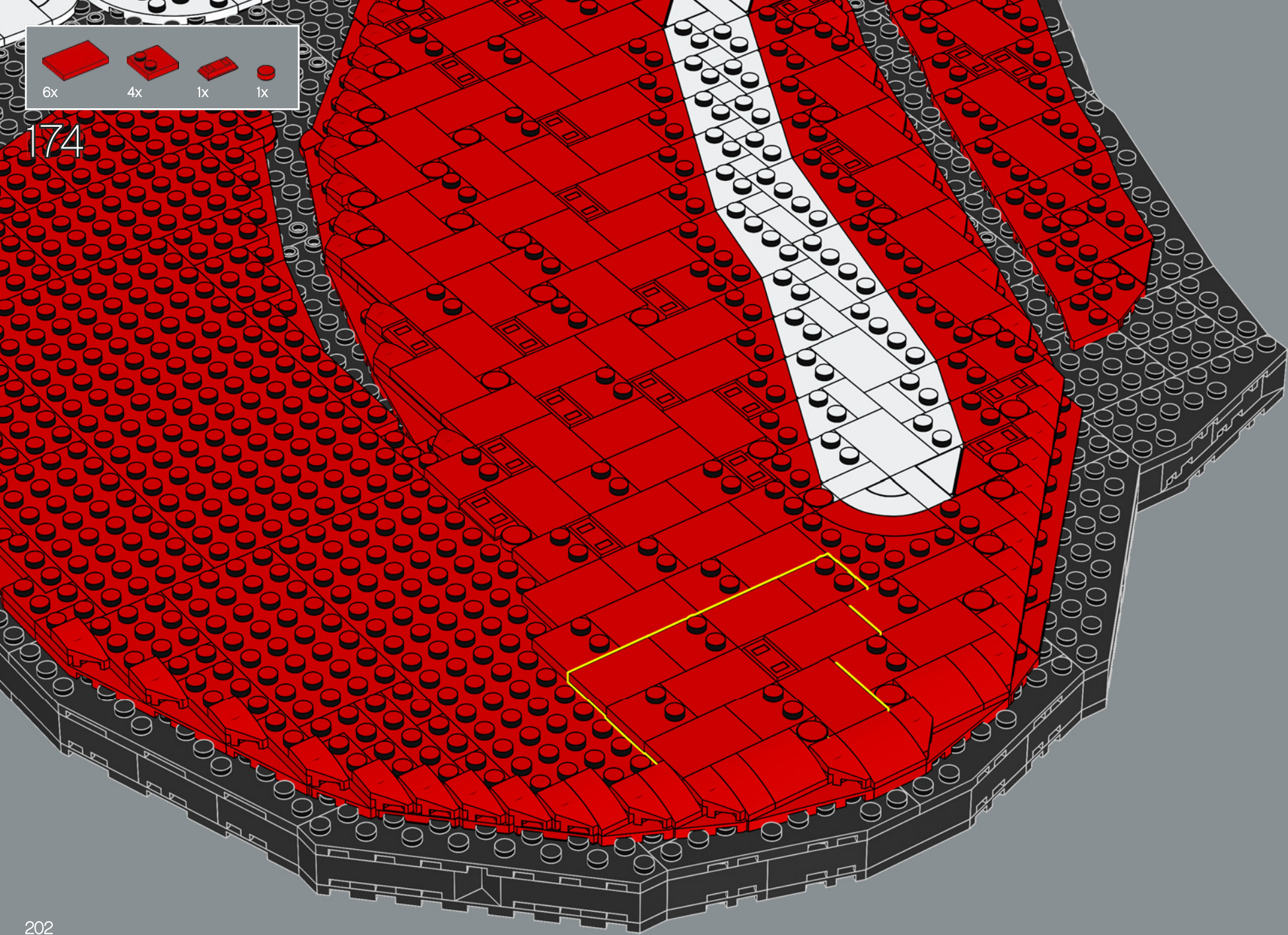

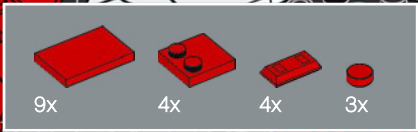

175

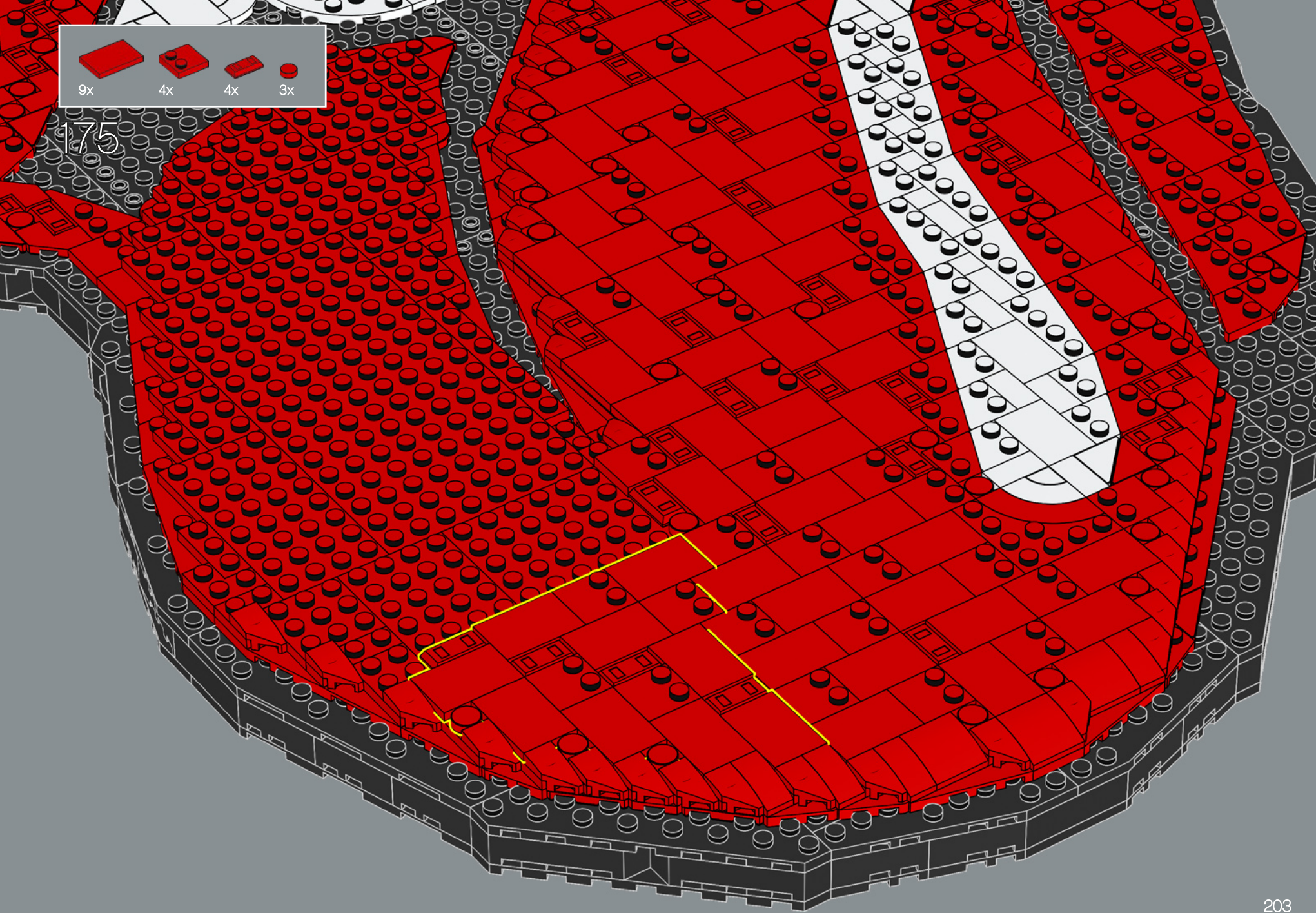

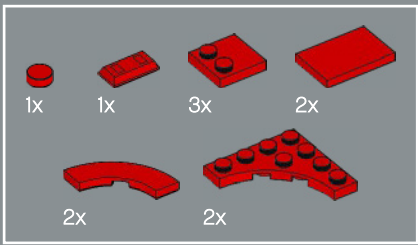

176

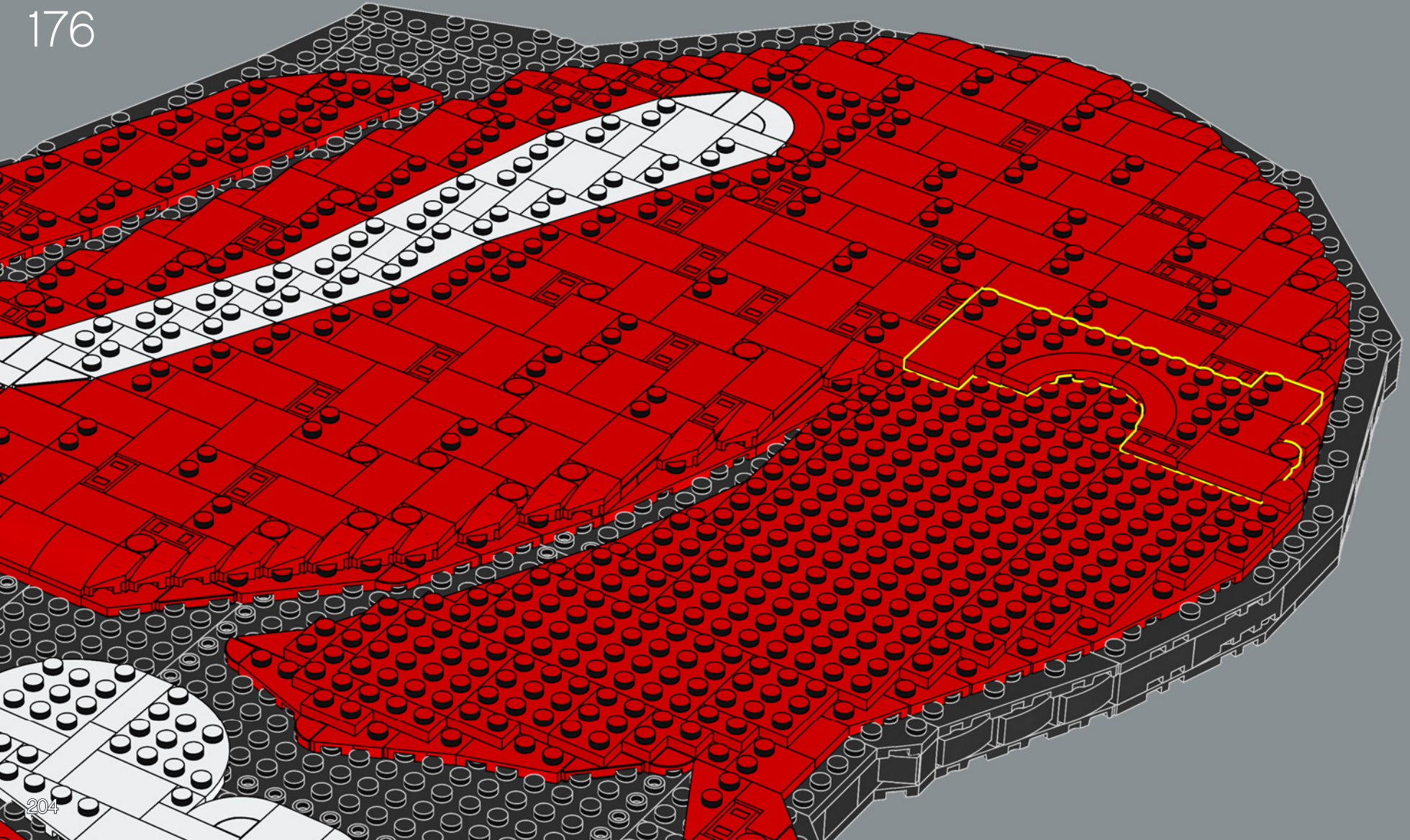



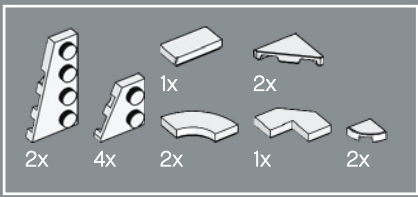

177

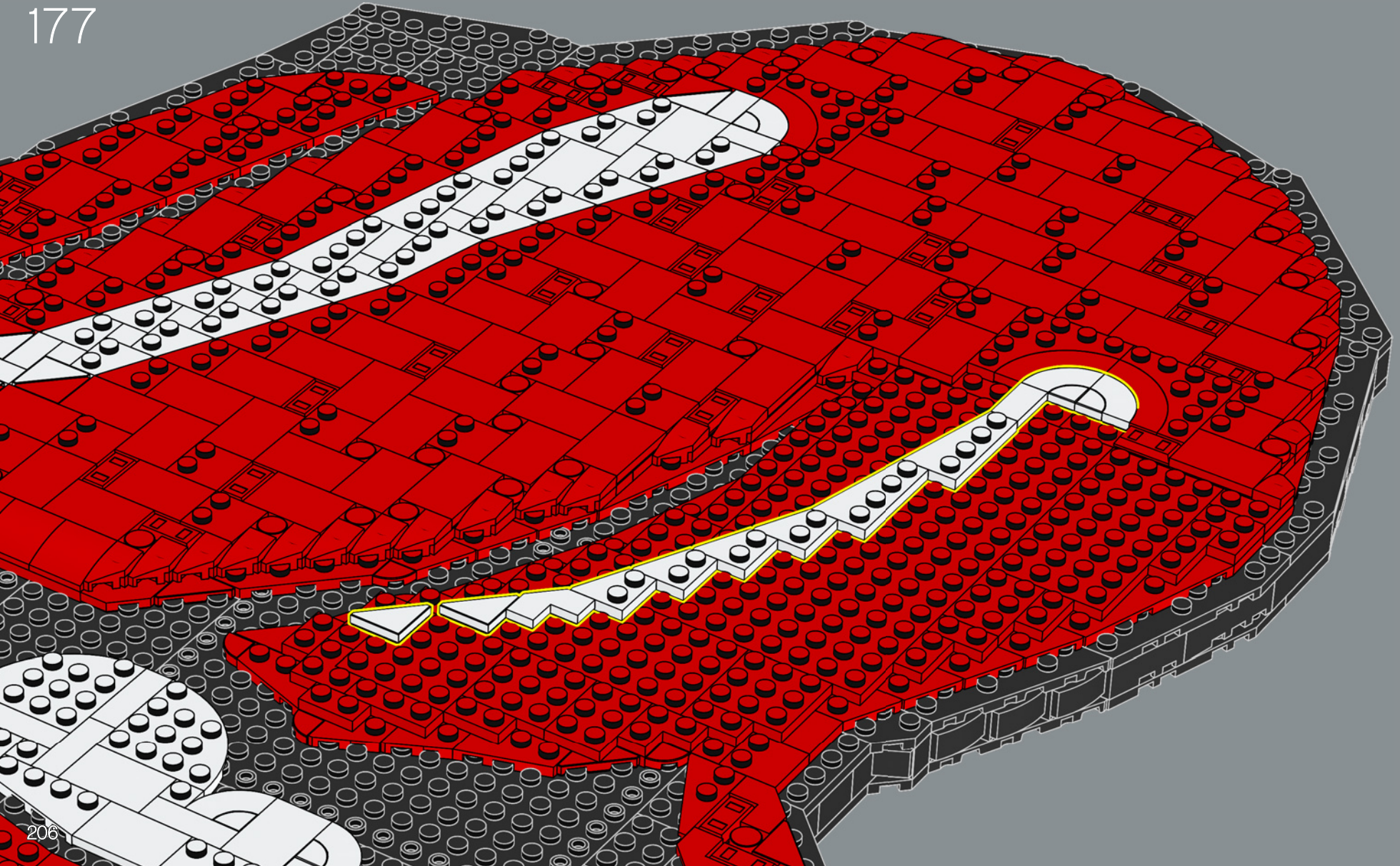

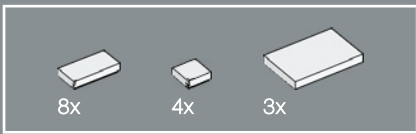

178

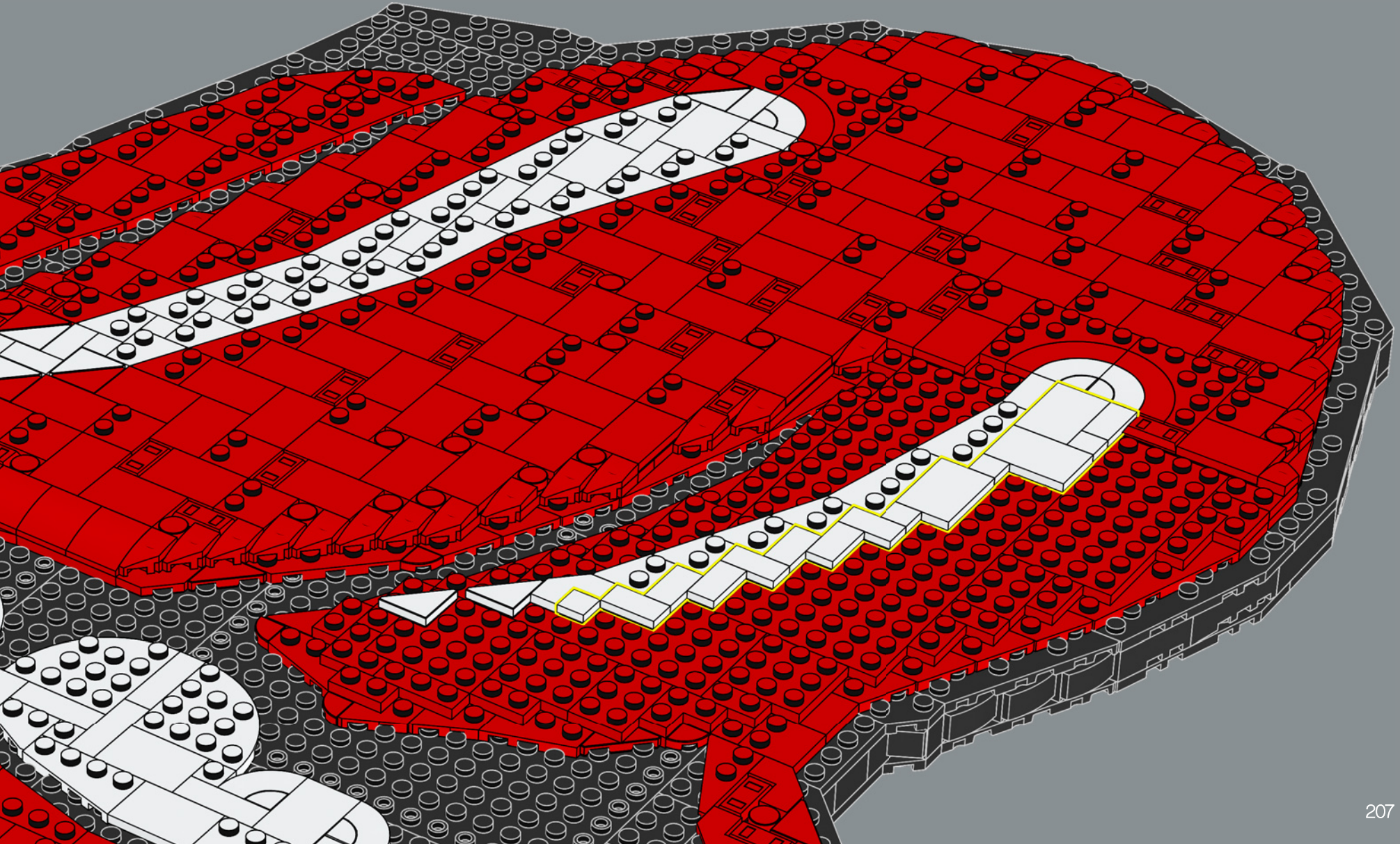

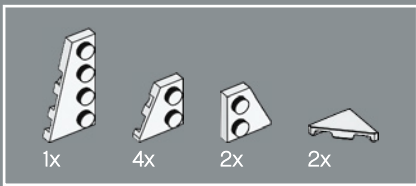

179

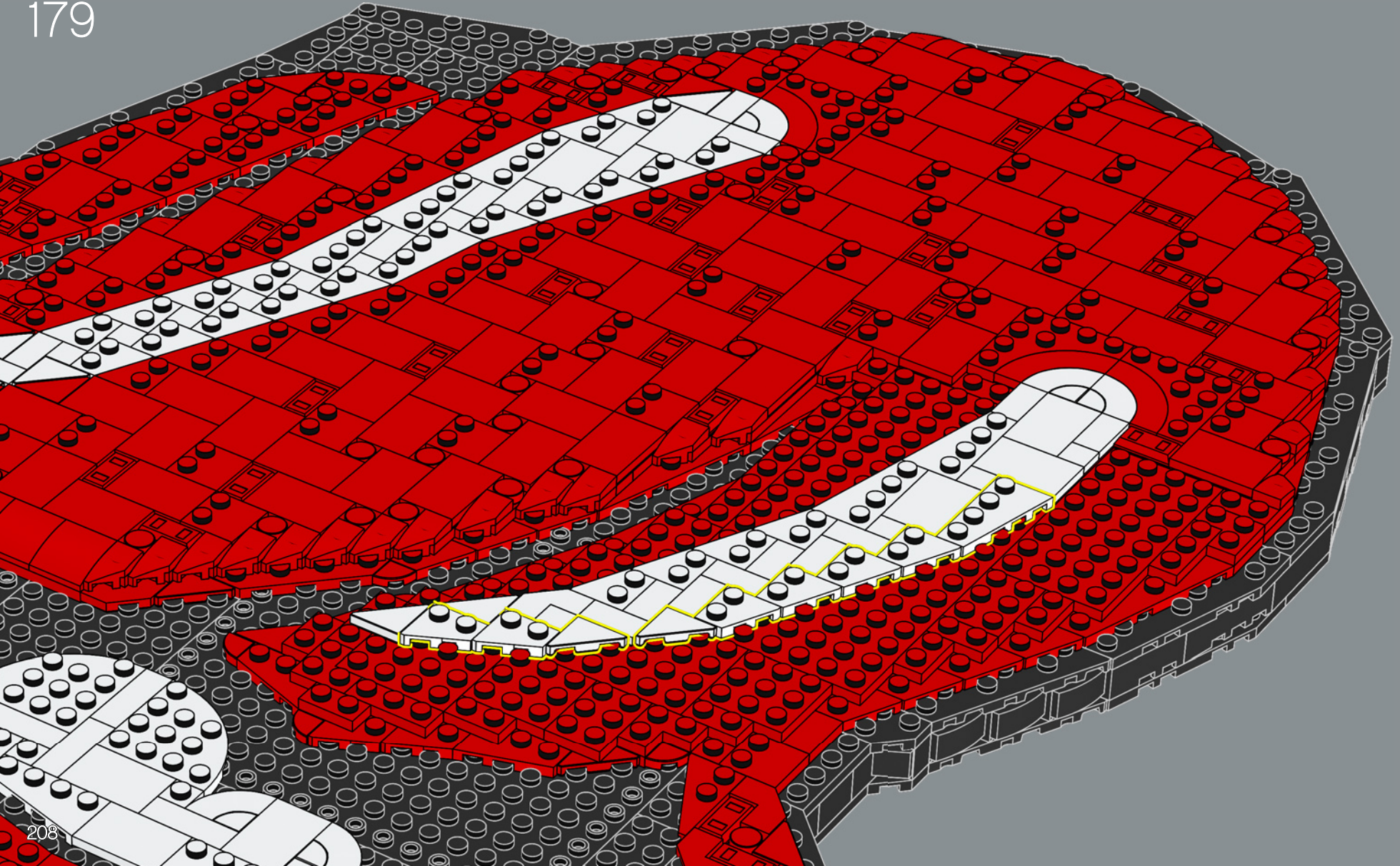

208





180

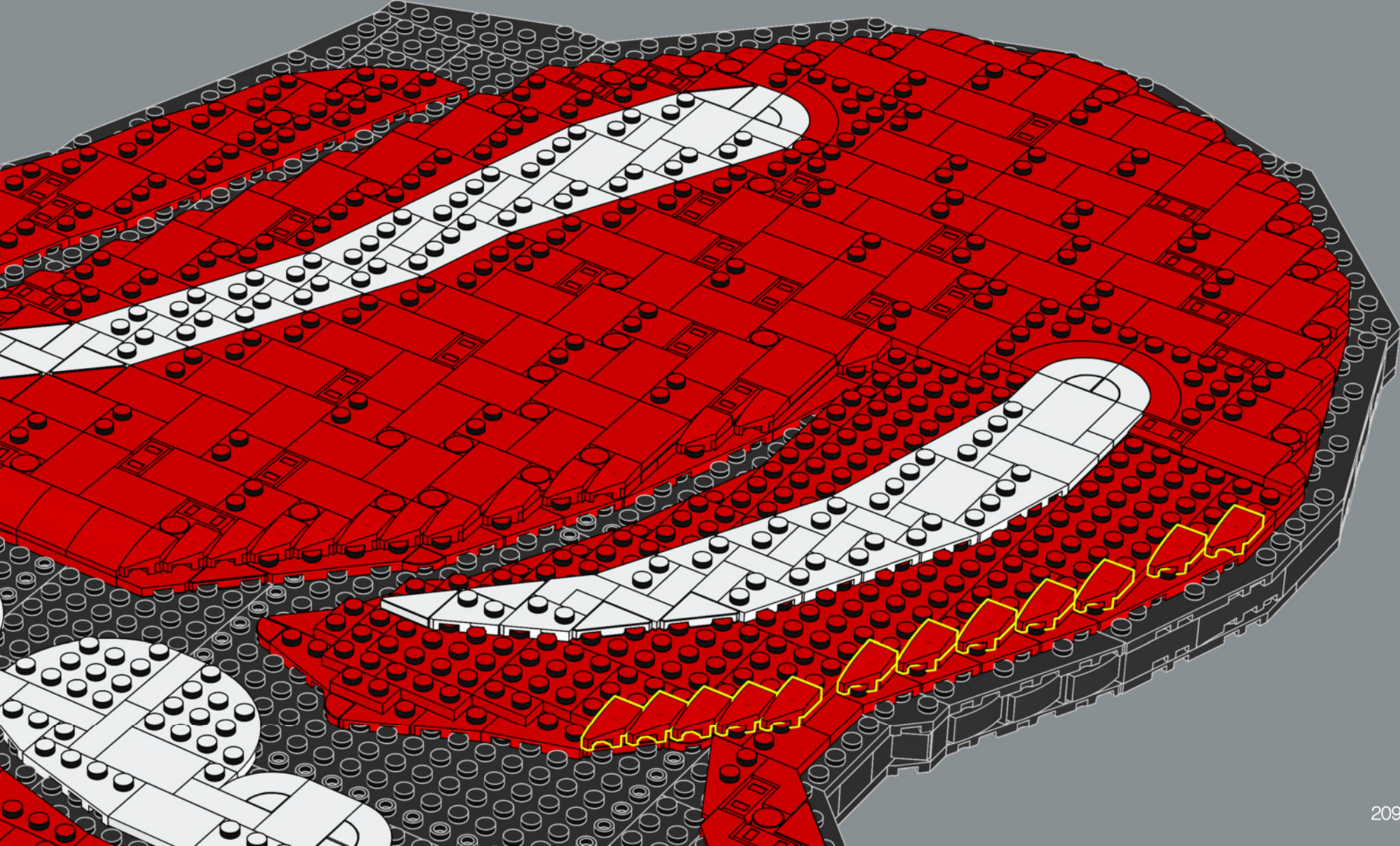



181

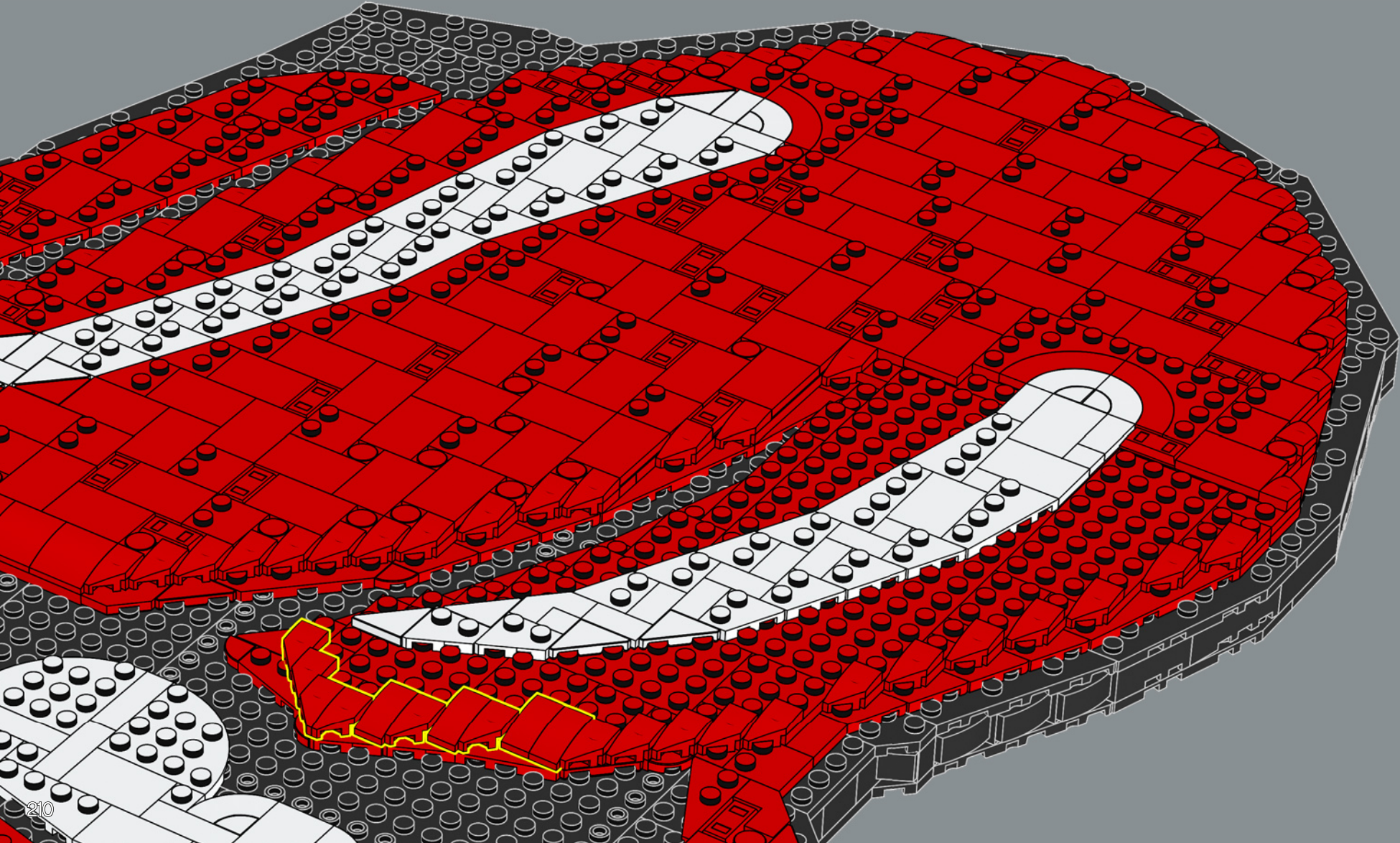

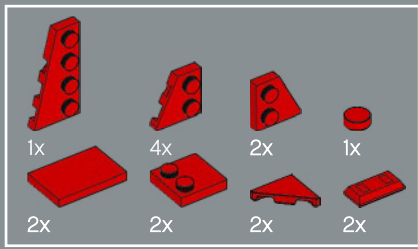

182

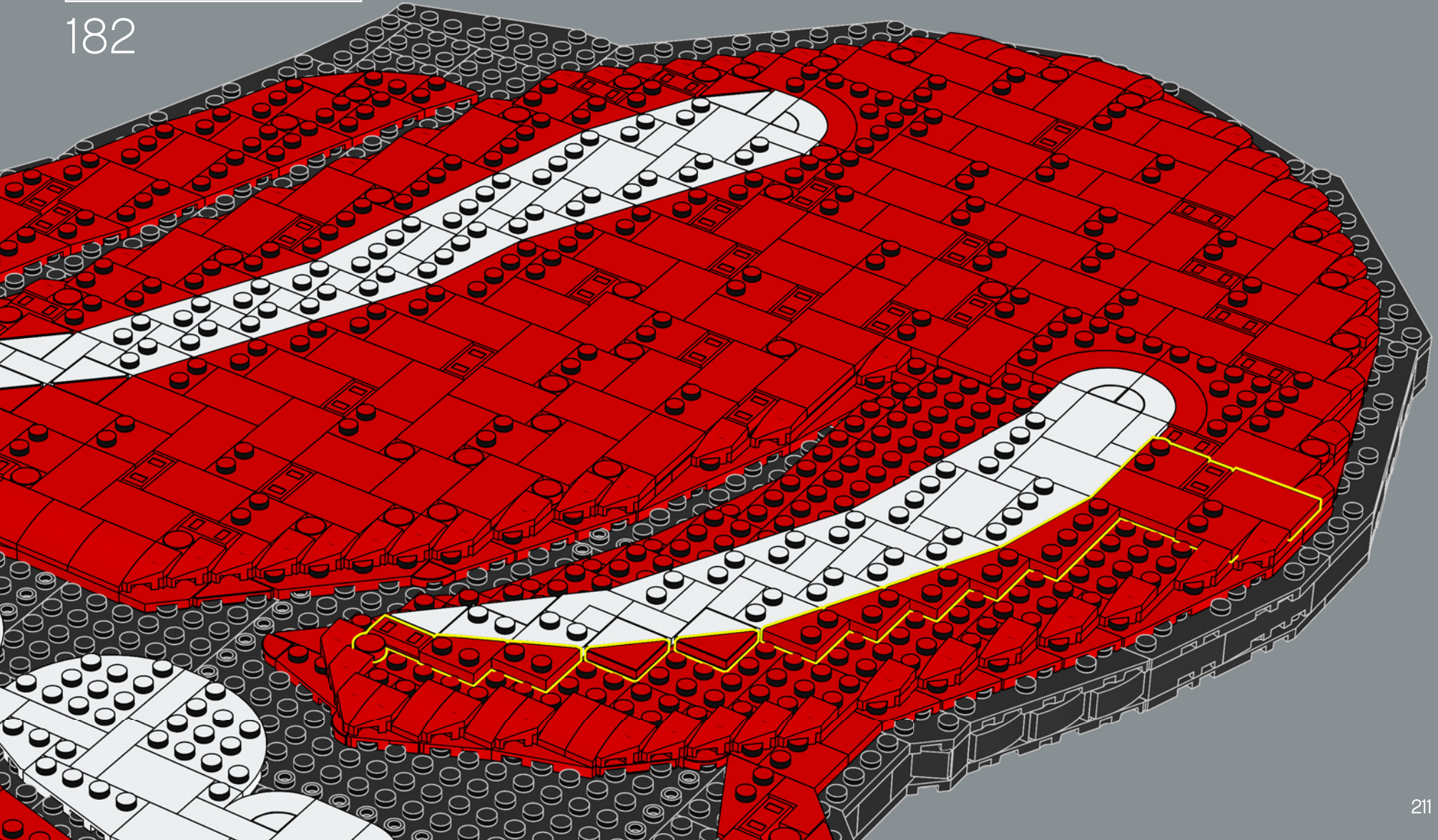

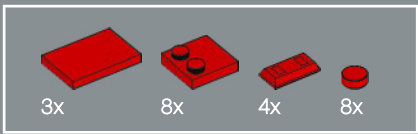

183

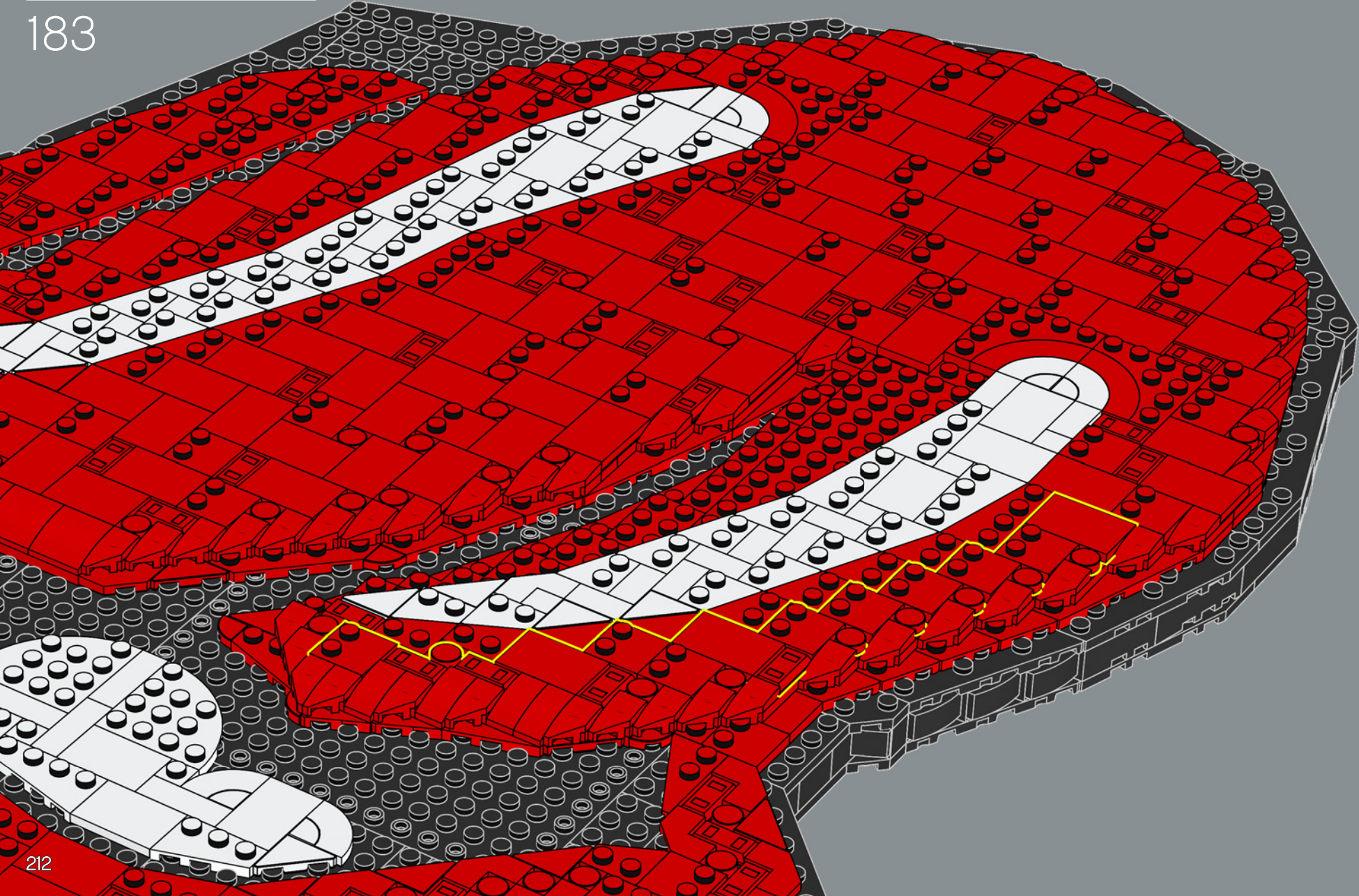

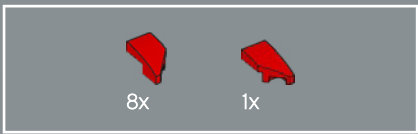

184

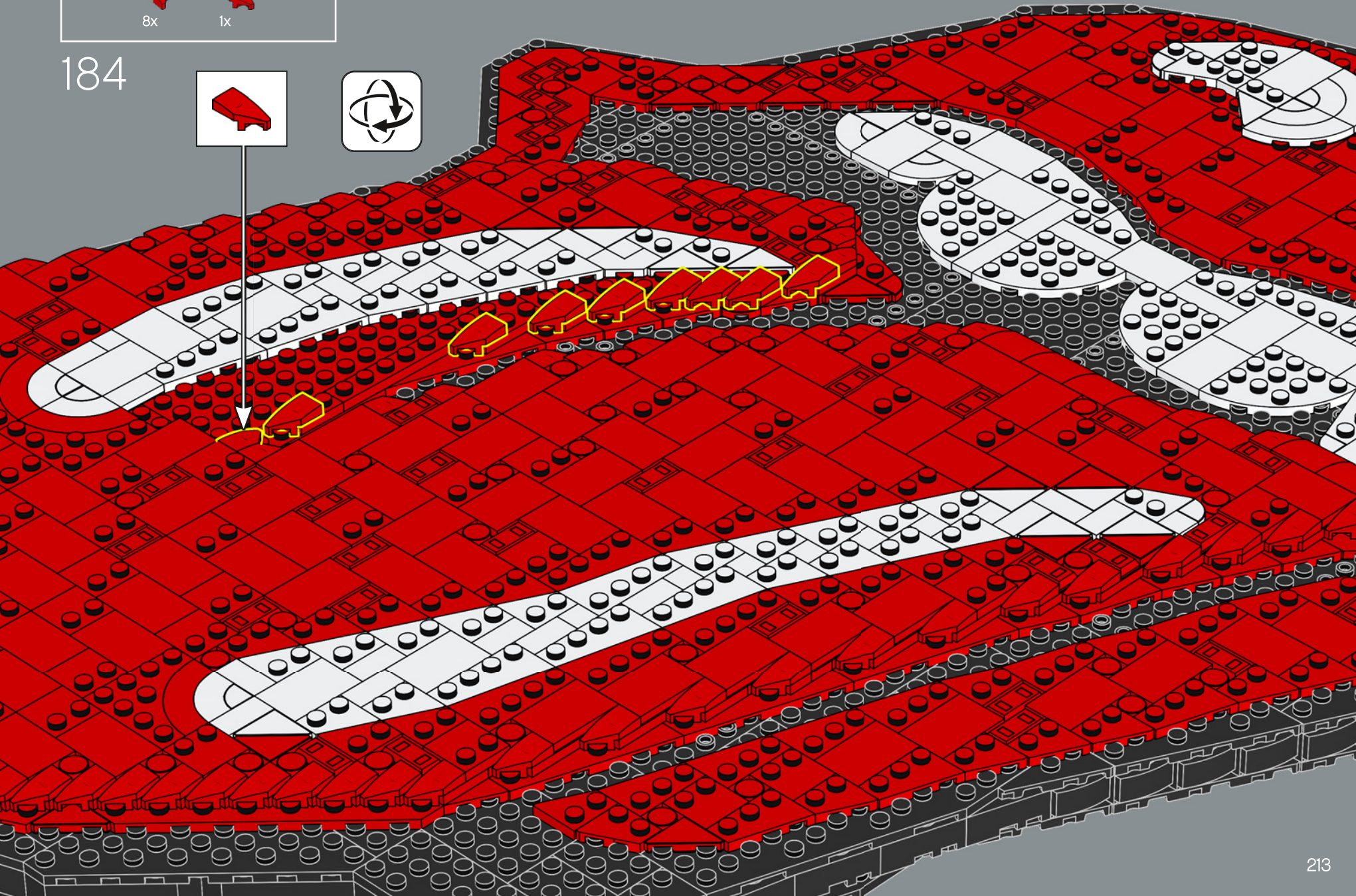

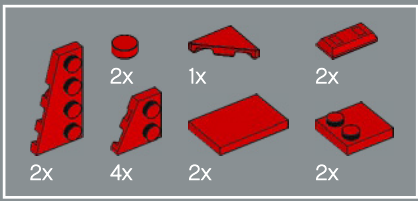

185

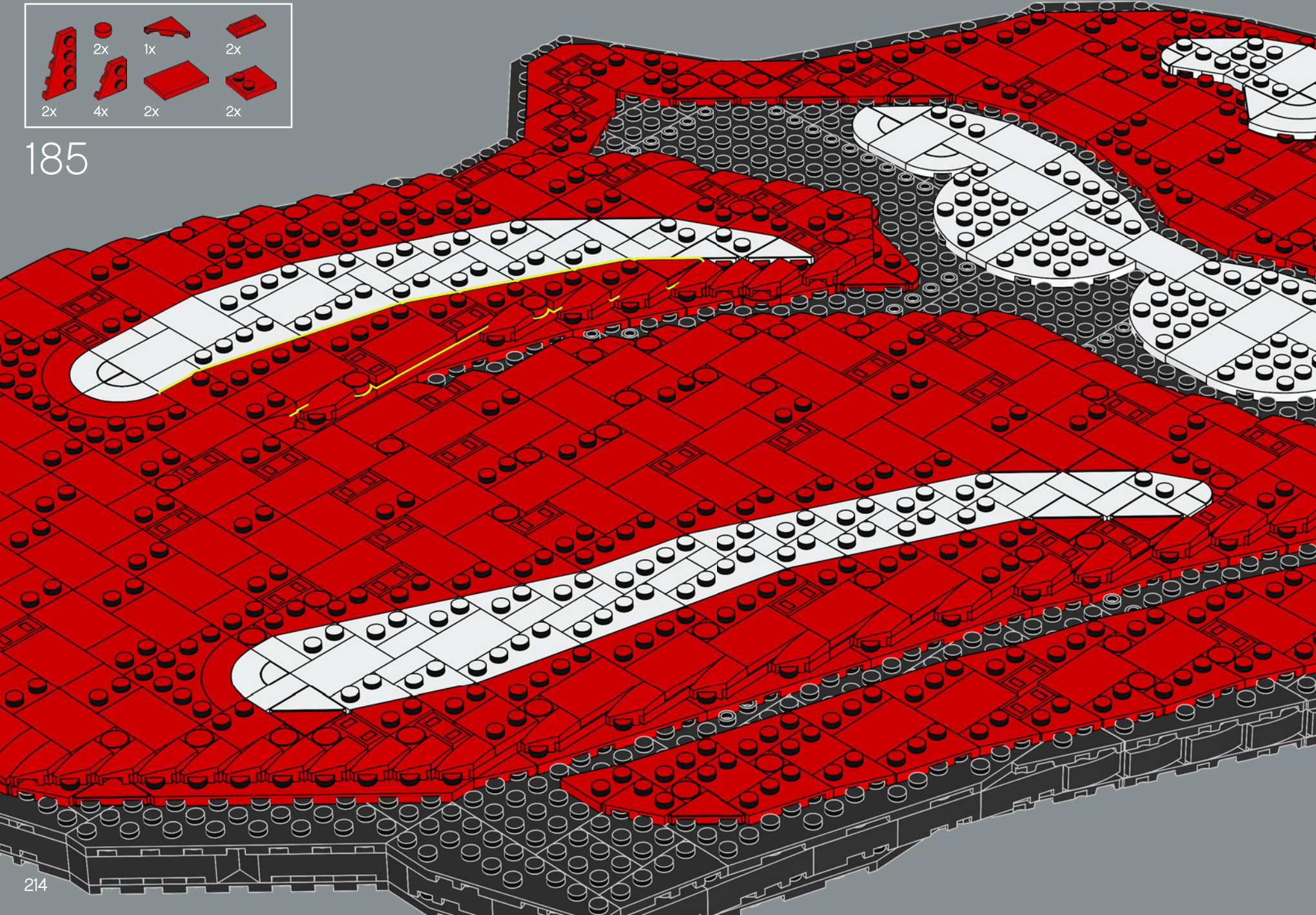



186

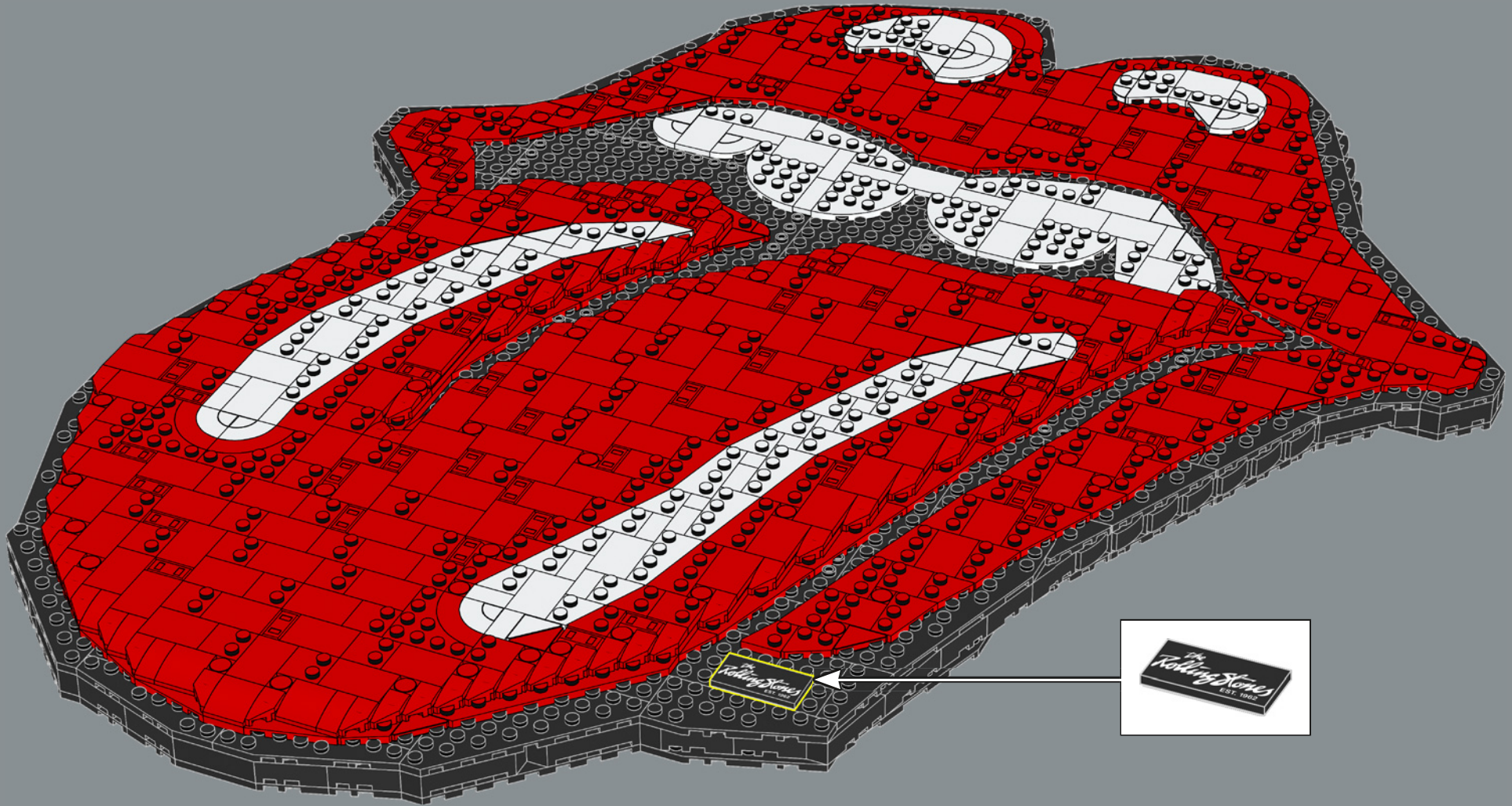







# FEEDBACK AND WIN



## FEEDBACK AND WIN

Your feedback will help shape the future development of this product series.

Please visit:

## FEEDBACK UND GEWINNEN

Dein Feedback trägt zur Weiterentwicklung dieser Produktreihe bei.

Geh auf:

## COMMENTEZ ET GAGNEZ

Vos commentaires nous aideront à concevoir les futurs produits de cette gamme.

Rendez-vous sur :

## COMENTA Y GANA

Tu opinión nos ayudará a dar forma al desarrollo de esta serie de productos en el futuro.

Visita:

## 反馈有奖

您的反馈将有助于我们在今后改进本系列产品。

请访问：

[LEGO.com/productfeedback](https://www.lego.com/productfeedback)

By completing, you will automatically enter a drawing to win a LEGO® set.

Terms & Conditions apply.

Durch Ausfüllen nimmst du automatisch an der Verlosung eines LEGO® Preises teil.

Es gelten die Teilnahmebedingungen.

En envoyant vos commentaires, vous serez automatiquement inscrit(e) à un tirage au sort qui vous permettra de remporter un prix LEGO®.

Offre soumise à conditions.

Al contestar, participarás automáticamente en el sorteo y podrás ganar un set LEGO®.

Sujeto a Términos y Condiciones.

完成我们的反馈调查，即可自动进入抽奖环节，赢取乐高®套装。

适用《条款和条件》。

8x  
302401  
12x  
307001  
14x  
6172366  
25x  
6132203  
10x  
6132204  
2x  
4179874  
2x  
6373439  
8x  
4161326  
1x  
4160857  
5x  
302301  
19x  
306901  
15x  
6217875  
18x  
6403936  
1x  
6168612  
9x  
6172674

6x  
4558168  
17x  
6156667  
13x  
370101  
4x  
4178429  
87x  
6284574  
55x  
614121  
65x  
6177505  
9x  
6170390  
31x  
6141553  
77x  
6141552  
4x  
6286513  
1x  
6286516  
3x  
6371578  
19x  
4180533

17x  
6177507  
5x  
6375825  
7x  
4180504  
14x  
4161329  
4x  
4160866  
60x  
6394880  
8x  
6029946  
18x  
6393320  
44x  
302321  
29x  
6351892  
1x  
6059013  
5x  
6170834

1x  
6059021  
74x  
6219819  
10x  
6105976  
2x  
6310198  
15x  
242021  
14x  
6217194  
14x  
362321  
10x  
302121  
116x  
6189130  
3x  
371021  
4x  
6217123  
1x  
245021  
3x  
366621  
7x  
4243814

3x  
6394888  
1x  
6278445  
3x  
379521  
8x  
370221  
2x  
303421  
4x  
303521  
1x  
6394884  
3x  
4514717  
1x  
428221  
5x  
6019675

23x  
614126  
22x  
302426  
1x  
6141556  
2x  
6295295  
6x  
6295293  
2x  
4180536  
2x  
4180508  
1x  
4161332  
122x  
6279875  
4x  
3200026  
22x  
6047276  
19x  
6138173  
3x  
6174243  
2x  
4584274



5x  
4251393



3x  
4251394



1x  
302226



5x  
6365577



1x  
235726



10x  
4526931



4x  
362326



5x  
6258209



10x  
6258214



4x  
6394879



4x  
4504382



3x  
4558954



1x  
407026



6x  
4527766



17x  
302126



3x  
371026



1x  
6078886



19x  
6174917



6x  
4227684



1x  
6323891



3x  
6078889



3x  
300126



10x  
6039347



3x  
6350415



2x  
6394881

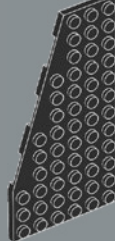

2x  
4143180



2x  
241926

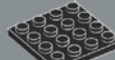

4x  
4243819



5x  
4160025

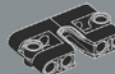

2x  
6302094

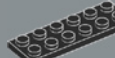

5x  
379526



1x  
6318582



3x  
346026

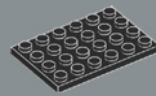

1x  
303226

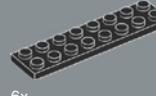

6x  
303426



2x  
4106977

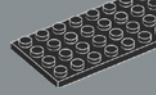

5x  
303526

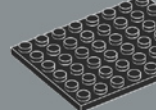

9x  
303626

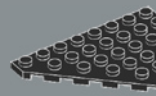

5x  
4205347

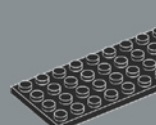

1x  
302926

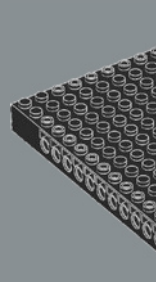

5x  
6302092



130x  
4157103



67x  
6314247



70x  
6331261



3x  
4211483



8x  
4211640



17x  
4211848



69x  
6319958



5x  
6185546



5x  
6185546



69x  
6319958



5x  
6185546



5x  
6185546



5x  
6185546



5x  
6185546



5x  
6185546



5x  
6185546



5x  
6185546



7x  
6299413



2x  
242023



3x  
4558606



5x  
4243815



36x  
379523



96x  
614124



3x  
389424



3x  
389424



3x  
389424



3x  
389424



3x  
389424



3x  
389424



3x  
389424



3x  
389424



3x  
389424



3x  
389424



3x  
389424

Customer Service  
Kundenservice  
Service Client  
Assistenza clienti  
Atención al cliente  
Serviço de Apoio ao Consumidor  
Ügyfélszolgálat  
Klientu apkalpošanas dienests  
Serviciul pentru clienți  
客户服务  
コンシューマーサービス  
고객 서비스  
**LEGO.com/service**

*the*  
*Rolling Stones*  
EST. 1962