



# CREATOR™

# 3 IN 1

31145



Q LEGO® Builder



### **Get excited about our new packaging!**

We're switching from plastic to paper-based packaging. That's why you might find a mix of paper and plastic in our boxes!

### **Nos nouveaux emballages vous emballeront !**

Nous passons des emballages en plastique aux emballages à base de papier. C'est pourquoi vous pourriez trouver un mélange de papier et de plastique dans nos boîtes !

### **¡Te presentamos nuestros nuevos empaques!**

Estamos sustituyendo las bolsas de plástico por bolsas con base de papel. ¡Por eso, puedes encontrar una mezcla de papel y de plástico en nuestras cajas!

**[LEGO.com/sustainable-packaging](https://www.lego.com/sustainable-packaging)**



# BUILDER



Apple and the Apple logo are trademarks of Apple Inc., registered in the U.S. and other countries and regions. App Store is a service mark of Apple Inc. Google Play and the Google Play logo are trademarks of Google LLC. Tencent and the Tencent logo are trademarks of Tencent Inc.



**EN** Ask parents' permission before going online | **DE** Eltern um Erlaubnis bitten, bevor du online gehst | **FR** Demande l'autorisation d'un parent avant d'aller en ligne | **IT** Chiedi il permesso ai tuoi genitori prima di andare online | **ES** Pídeles permiso a tus papás antes de conectarte a Internet | **PT** Pede autorização aos pais antes de acederes online | **ZH** 上网前应先征得父母的同意 | **PL** Poproś rodziców o zgodę, zanim wejdiesz do Internetu | **CS** Než půjdeš na internet, požádej rodiče o svolení | **SK** Skôr než pôjdeš na internet, vypýtaj si povolenie od rodičov | **HU** Kérj szülői engedélyt, mielőtt online csatlakoznál! | **RO** Cere permisiunea părinților înainte de a te conecta online | **BG** Поискайте разрешение от родител, преди да влезете онлайн | **LV** Pirms došanās tiešsaistē palūdz atļauju vecākiem | **ET** Enne Interneti kasutamist küsi vanematelt luba | **LT** Prieš prisijungdami prie interneto, atsiklauskite tėvų





1x

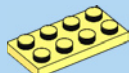

1x

1

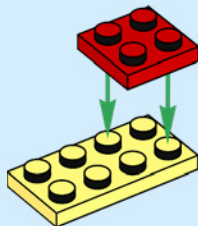



1x



1x

2

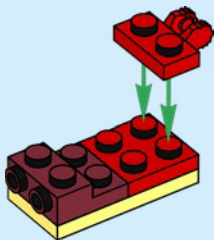

2x

3

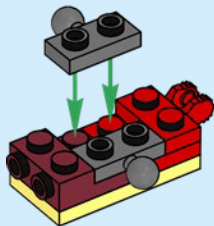



2x

4

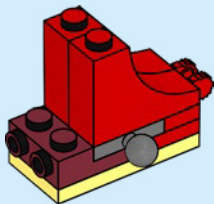

2x

5

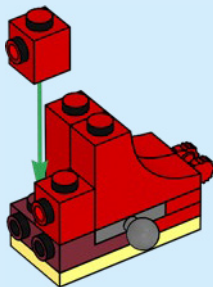



1x

6

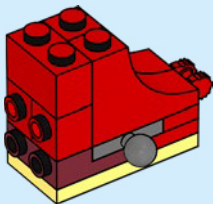

1x

7

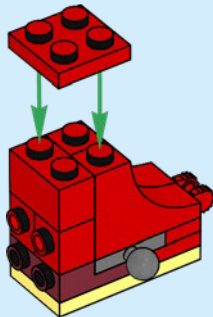



1x

8

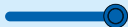
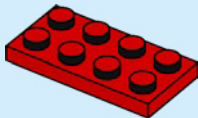





1x

9

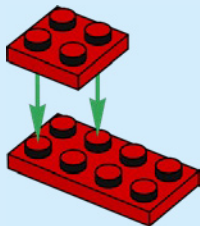

2x

10

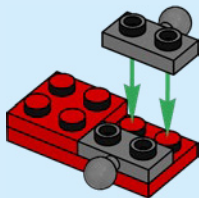



1x

11

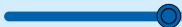
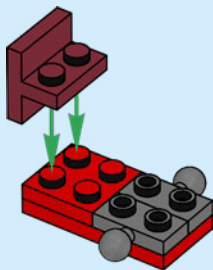



1x



1x

# 12

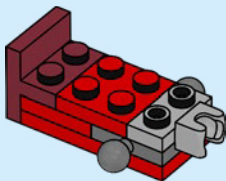

2x



1x

# 13

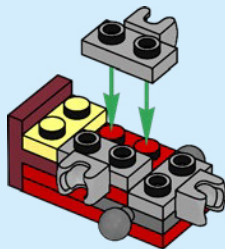



2x

14

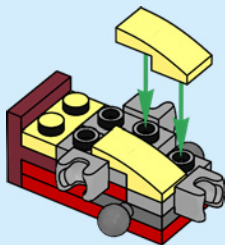



1x

15

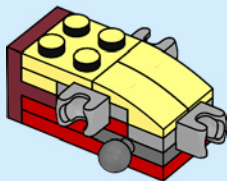

16

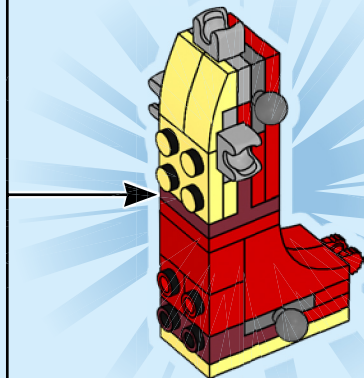



1x



2x

# 17

1

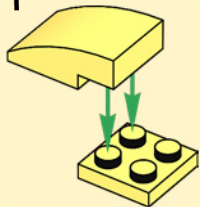

2

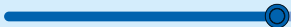
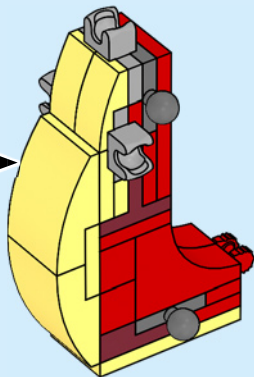
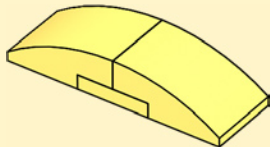

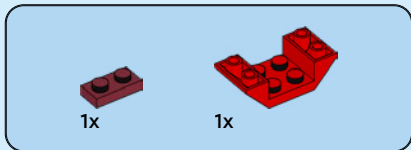
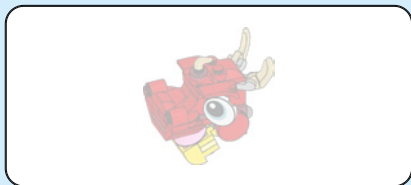

18

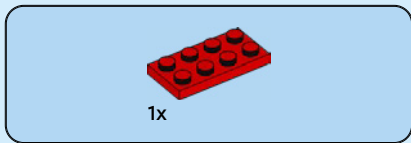
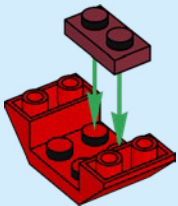

19

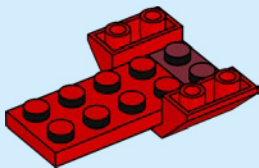



1x



1x

# 20

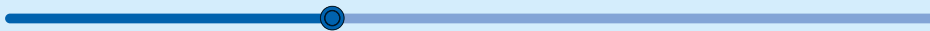
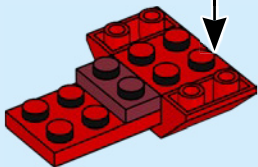
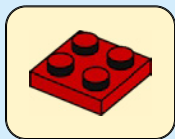





2x

21

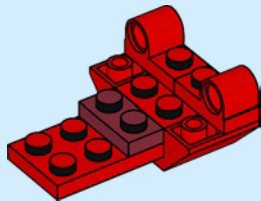

2x

22



2x

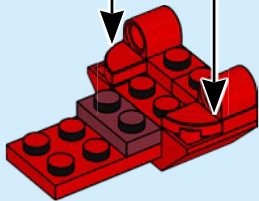



2x

# 23

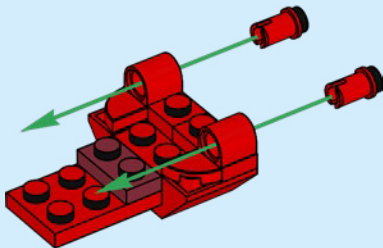



2x

24

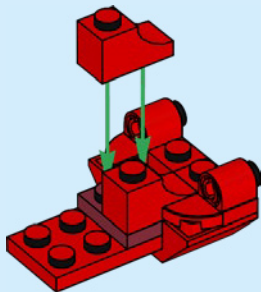

1x

25

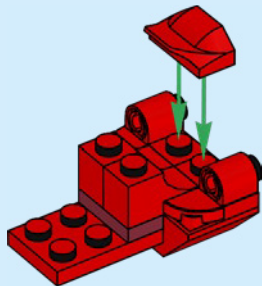



1x



2x



1x

# 26

1



2



3



4

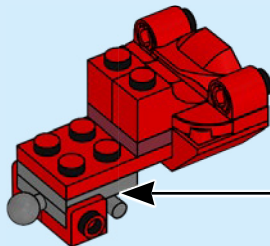
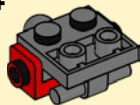



2x

27

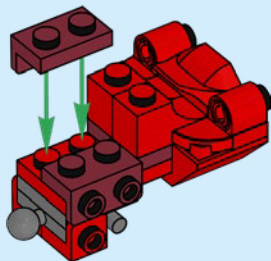

2x

28

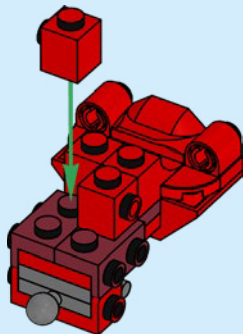



1x

29

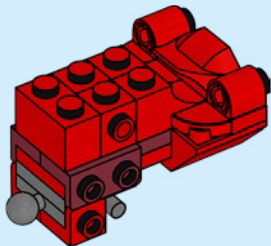

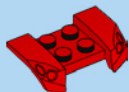

1x



2x

30

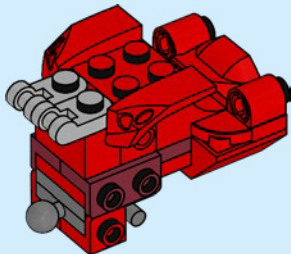

1x



1x

31

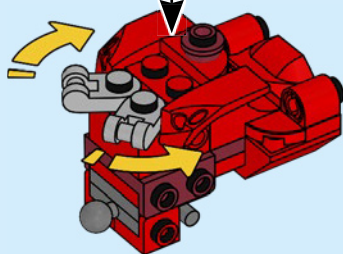
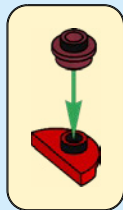



1x

32

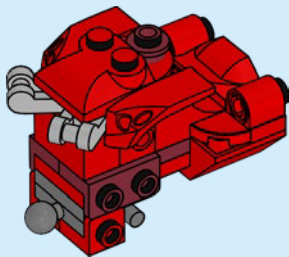





1x

# 33

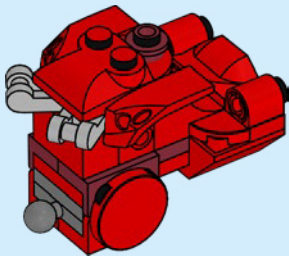

1x



1x

# 34

1



2

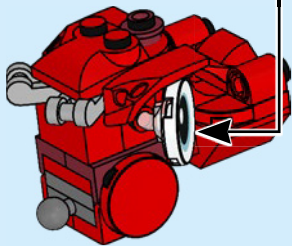



1x

35

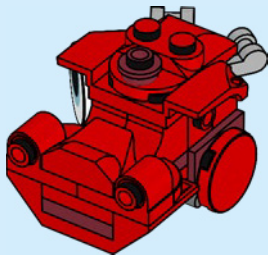

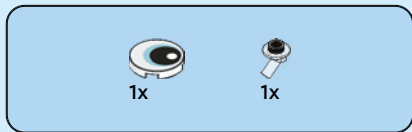

36

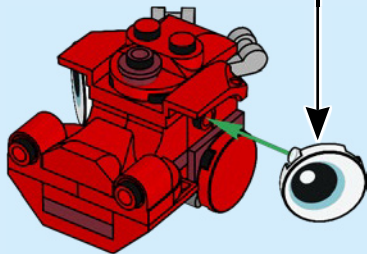



1x



1x



2x



1x

# 37

1

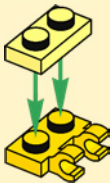

2

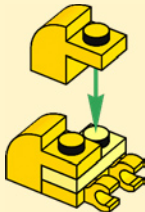

3

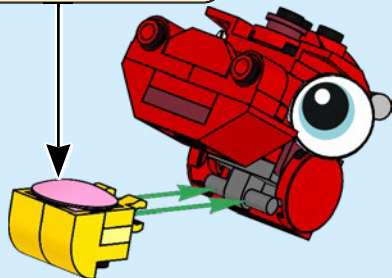
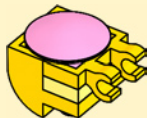

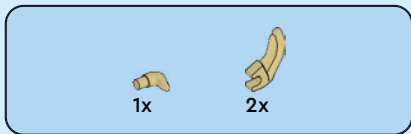

38

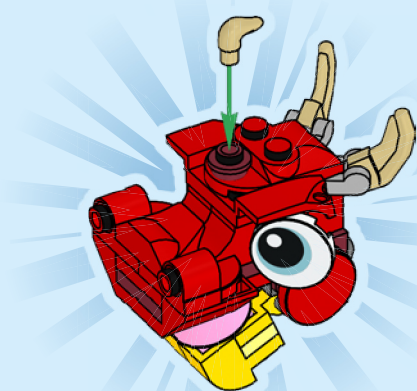

39

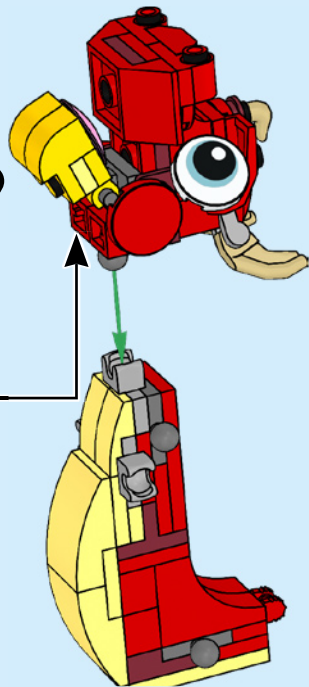



1x

40

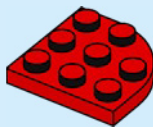



1x

41

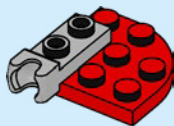

1x

42

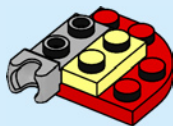



1x



1x

# 43

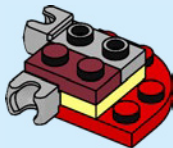





1x

44



1x

45

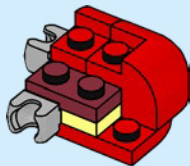



1x

46

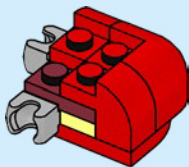



1x

47

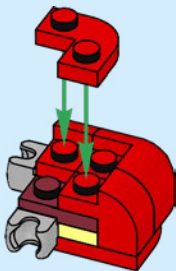

48

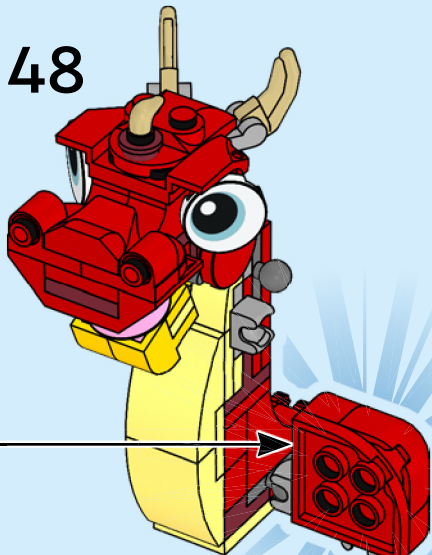



1x

49

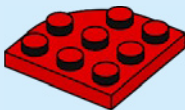



1x

50



1x

51





1x



1x

# 52

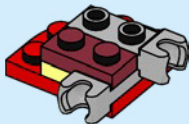



1x

53

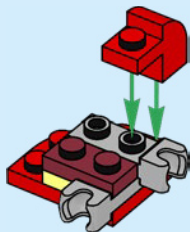

1x



1x

54

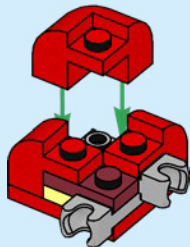



1x

55

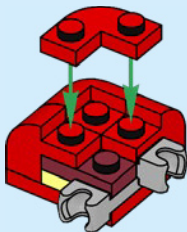



56

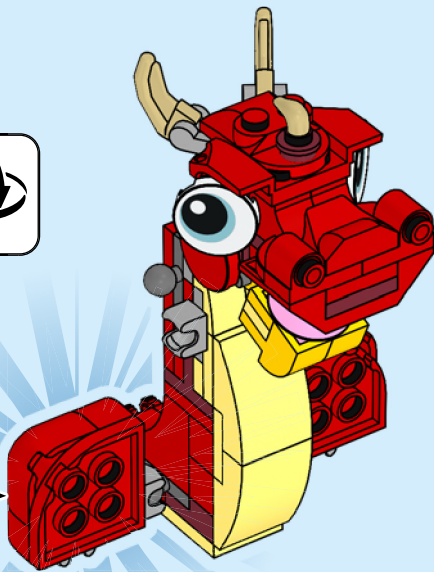
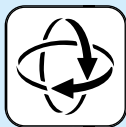



2x



2x



2x



2x



2x



2x



2x

57

1



2

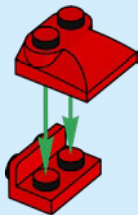

3



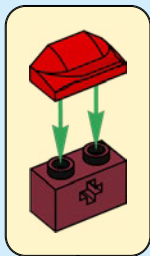

4

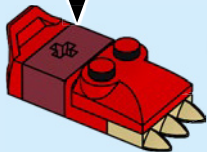

5

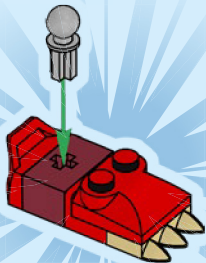

2x

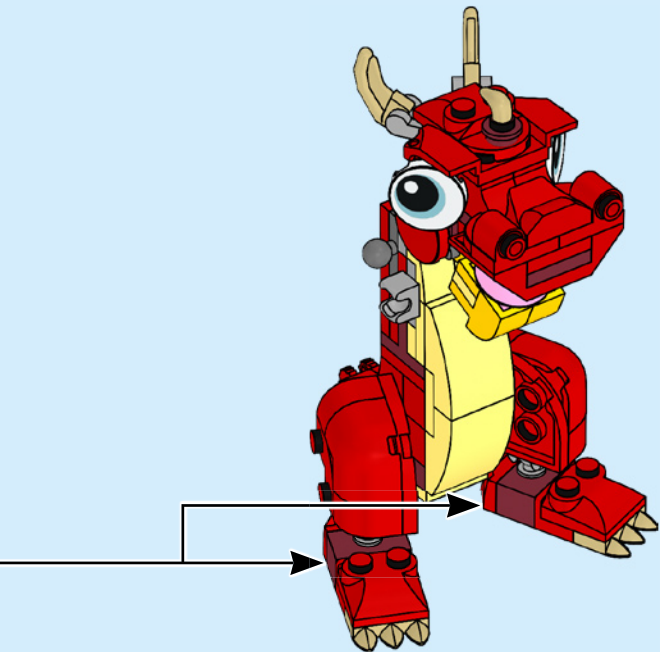

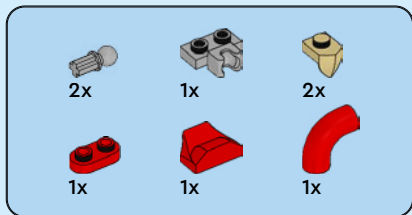

58

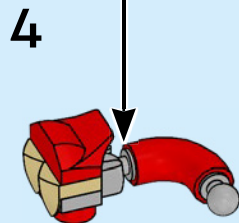
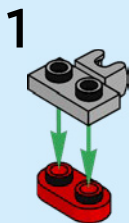
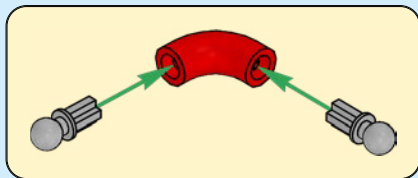

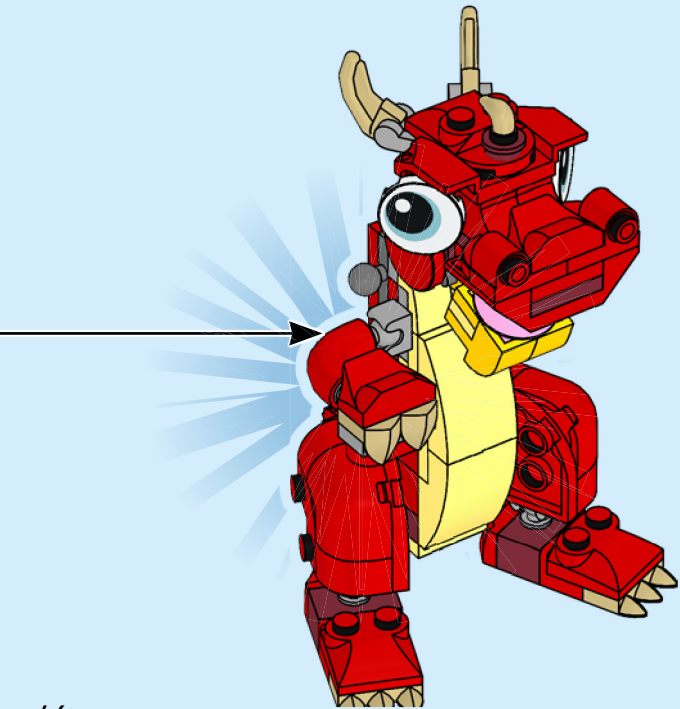



1x



1x

59

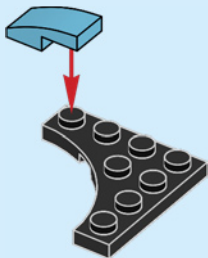

1x



1x

60

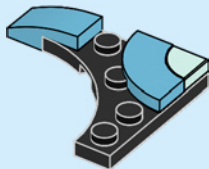



3x

61

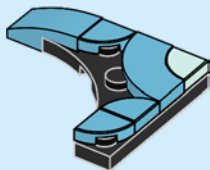





1x

62

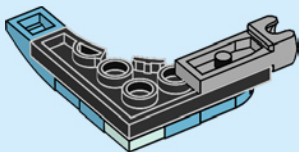
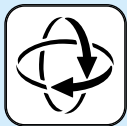

1x

63

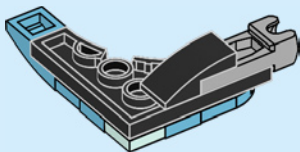

64

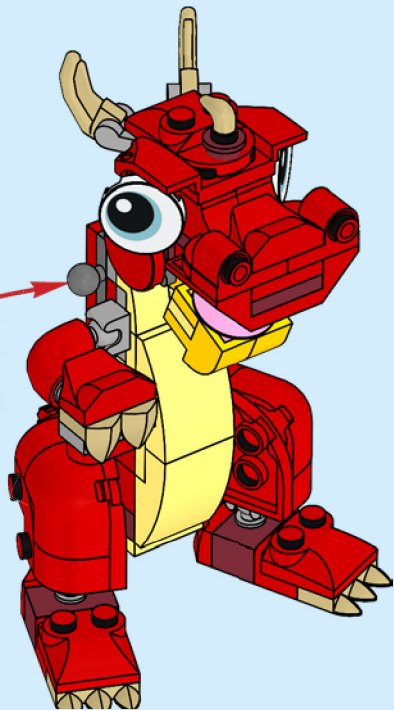
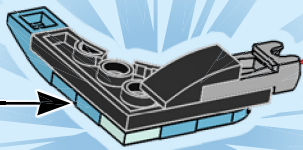

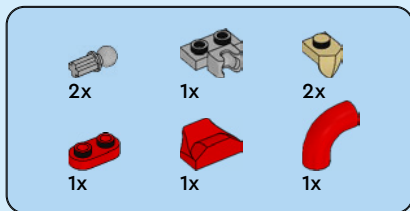

65

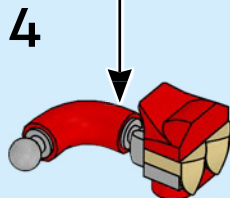
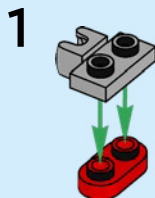
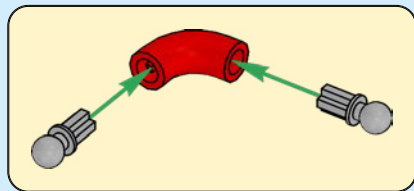

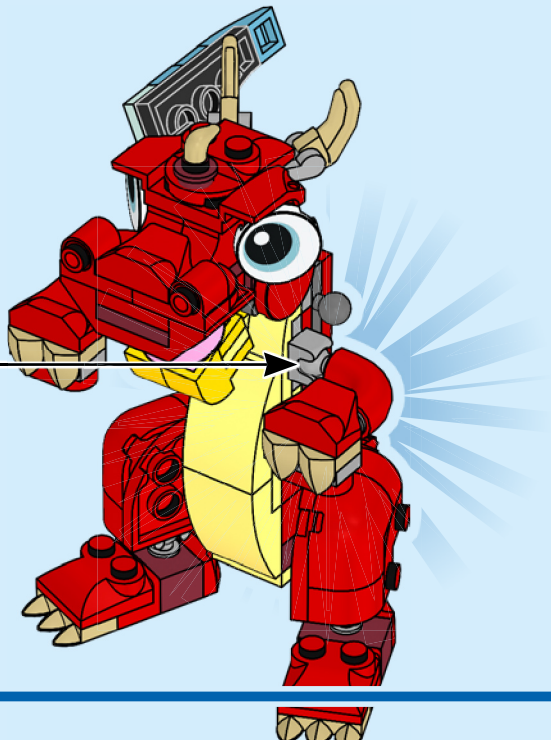

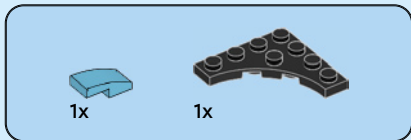
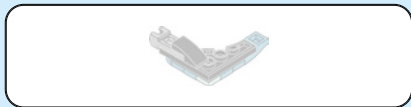

66

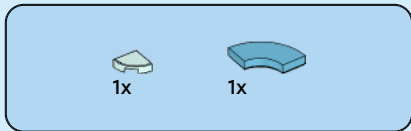
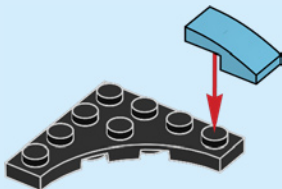

67

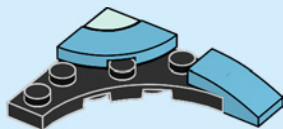



3x

68

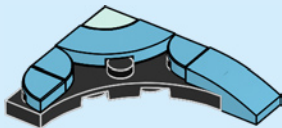



1x

69

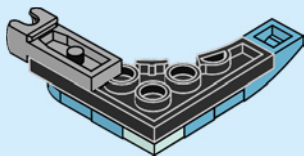



1x

70

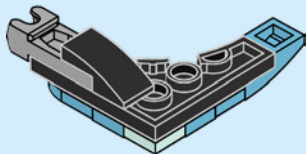



71

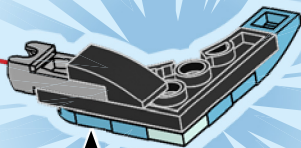
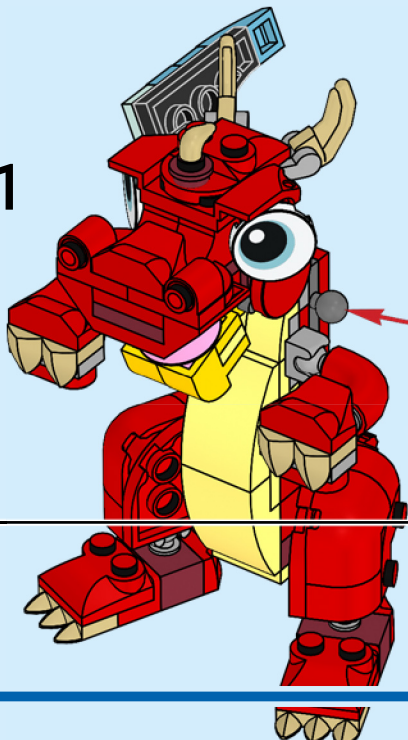

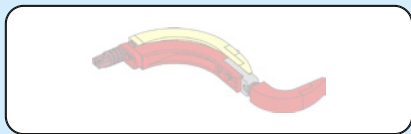

72

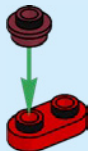

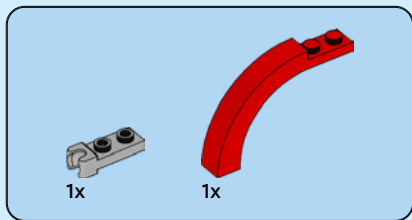

73

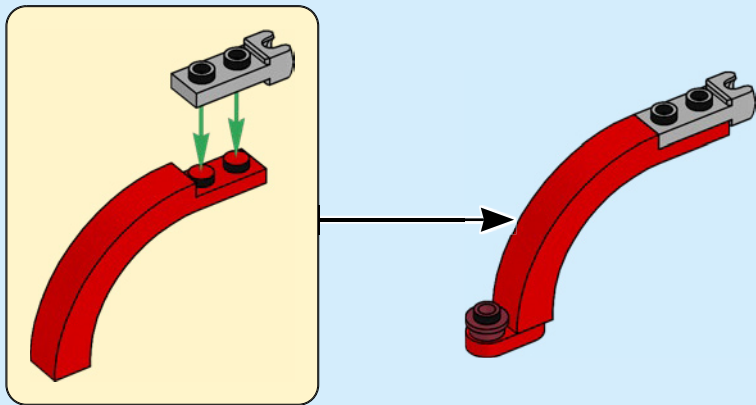

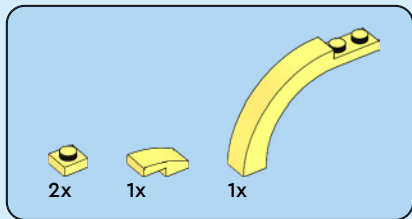

74

1

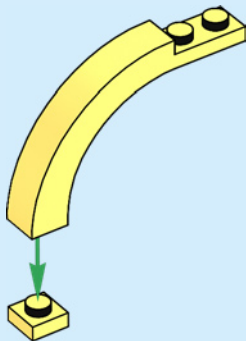

2

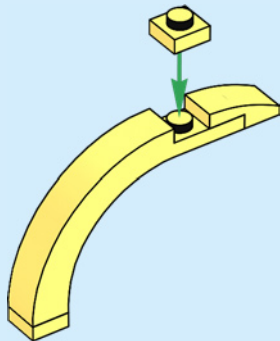

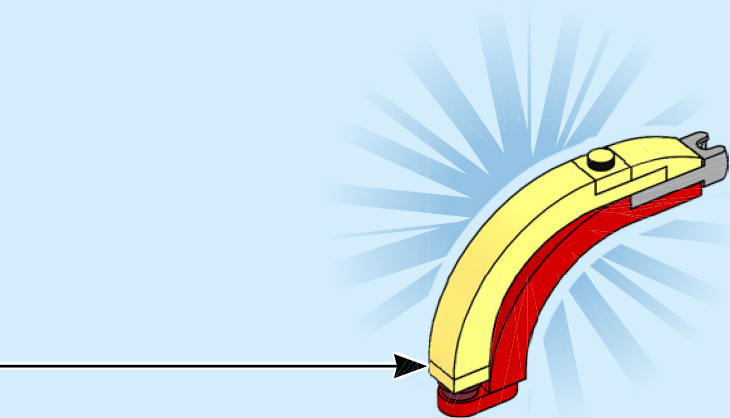



75

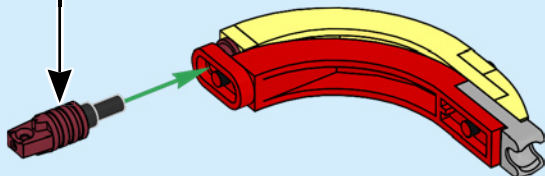
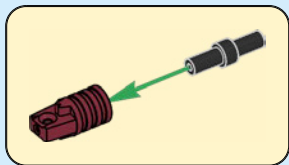

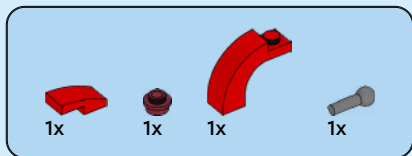

# 76

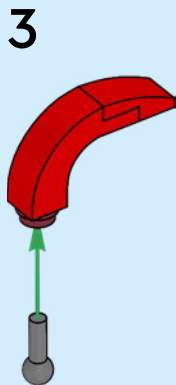
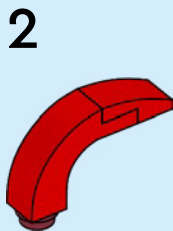
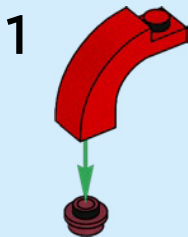

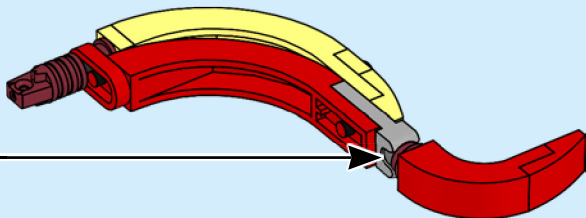



77







# CREATOR™

# 3 IN 1

31152



31150



31146



31149

31147



31145



31148



# SHARE YOUR FEEDBACK



Scan this QR code or go to  
**LEGO.COM/PRODUCTFEEDBACK** and give us  
your short feedback about this LEGO® set.

Terms and Conditions apply\*

**EN: SHARE YOUR FEEDBACK.** Terms and Conditions apply\* **DE: Teile dein FEEDBACK.** Es gelten die Teilnahmebedingungen\* **FR: Partagez vos COMMENTAIRES.** Des conditions s'appliquent\* **IT: Condividi il tuo FEEDBACK.** Termini e condizioni sono applicabili\* **ES: Comparte tu OPINIÓN.** Aplican términos y condiciones\* **PT: Partilha o teu FEEDBACK.** Aplicam-se termos e condições\* **ZH: 请分享您的反馈. 条款和条件适用\*** **PL: Podziel się swoją OPINIĄ.** Obowiązują warunki korzystania\* **CS: Podělte se o ZPĚTNOU VAZBU.** Platí všeobecné smluvní podmínky\* **SK: Podel' sa o svoj NÁZOR.** Platia všeobecné zmluvné podmienky\* **HU: Oszd meg a VÉLEMÉNYED.** Felhasználási feltételek érvényesek\* **RO: Trimite FEEDBACK.** Se aplică termeni și condiții\* **BG: Споделете вашите ОТЗИВИ.** Има определени правила и условия\* **LV: Sniedziet ATSAUKSMES.** Ir spēkā noteikumi un nosacījumi.\* **ET: Jaga oma TAGASISIDET.** Kehtivad tingimused\* **LT: Palikite ATSILIEPIMĄ.** Taikomos sąlygos\*

\*[LEGO.com/productfeedback-terms](https://www.lego.com/productfeedback-terms)

LEGO and the LEGO logo are trademarks of the/son des marques de commerce du/  
son marcas registradas de LEGO Group. ©2024 The LEGO Group.

6494915