

LEGO

NINJAGO

Masters of Spinjitzu



2521



1

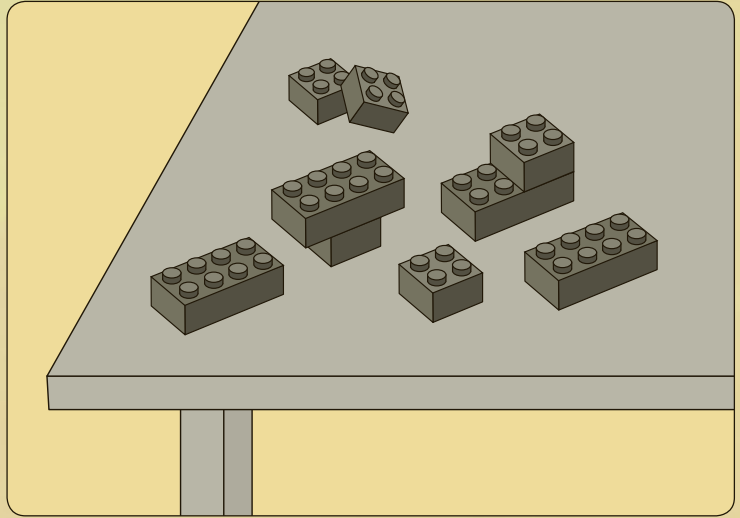
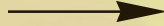
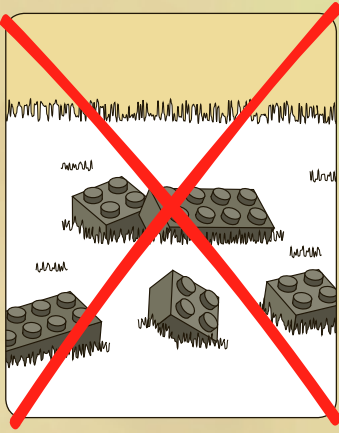

2



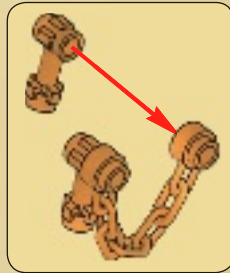
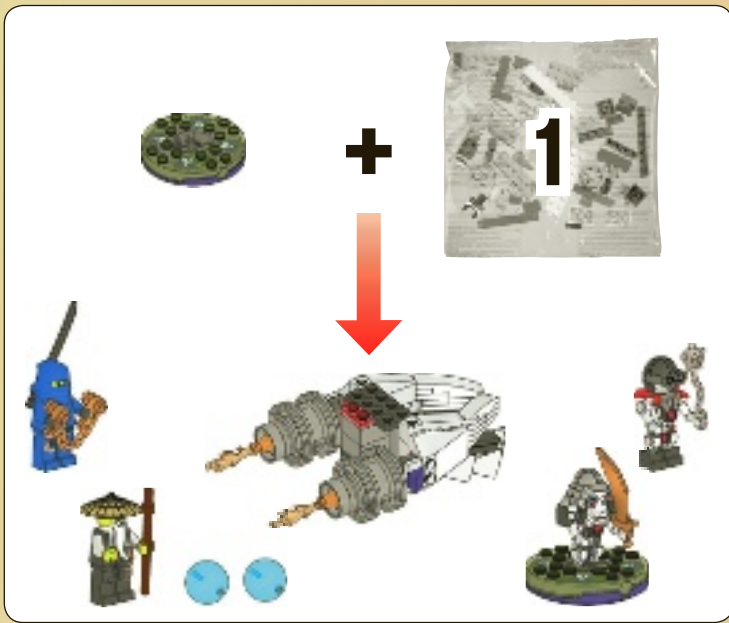

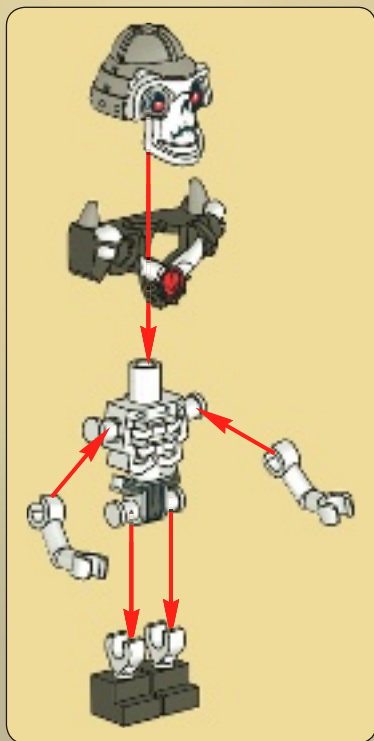

1



2



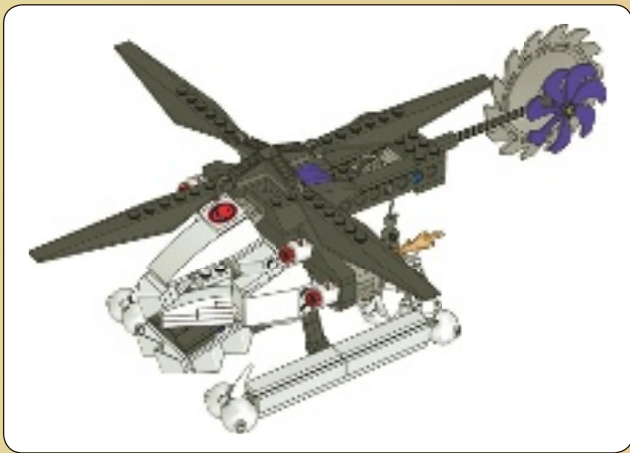

1

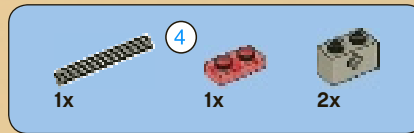

2

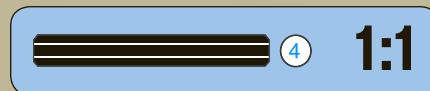
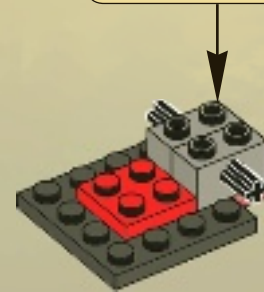
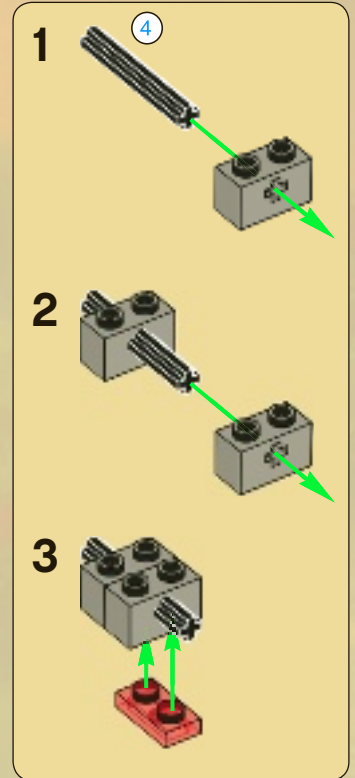



3

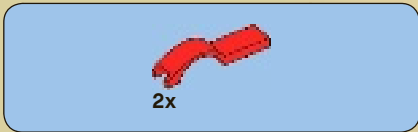

4

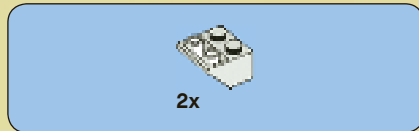
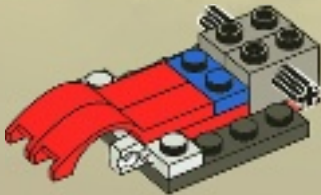

5

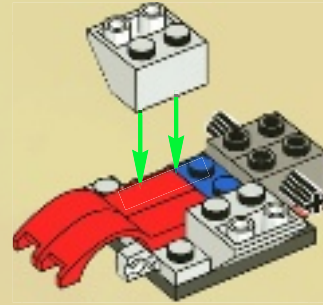

6





7

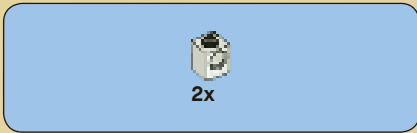

8



9

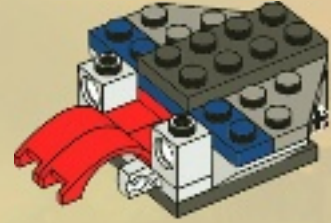

10

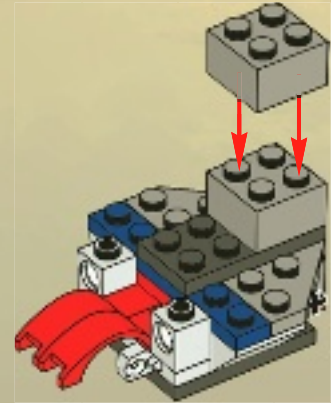



1

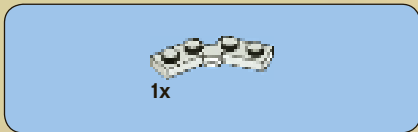

2



3



4

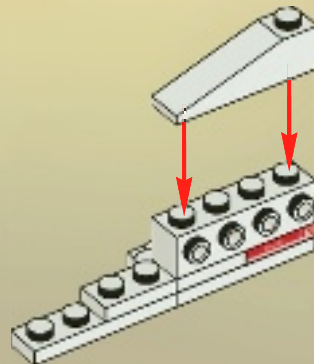

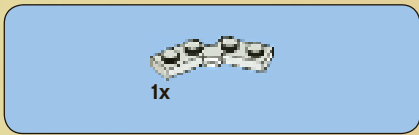

5

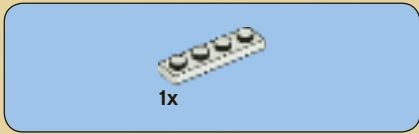
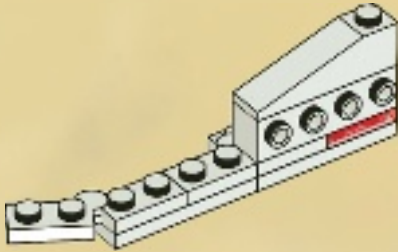

6

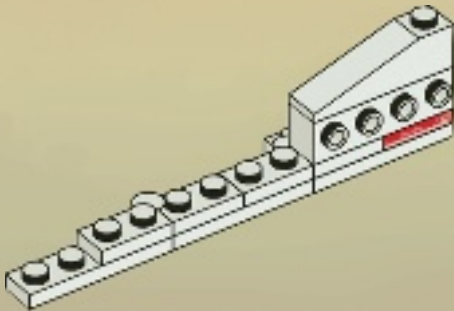

7

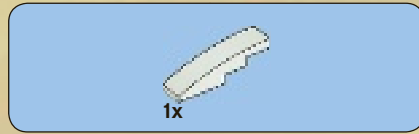
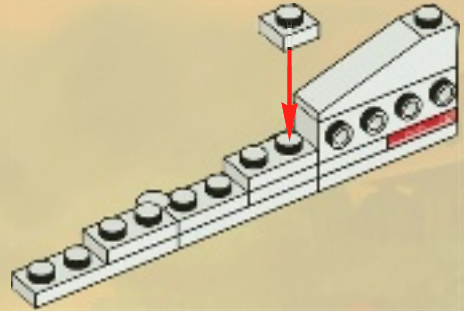

8

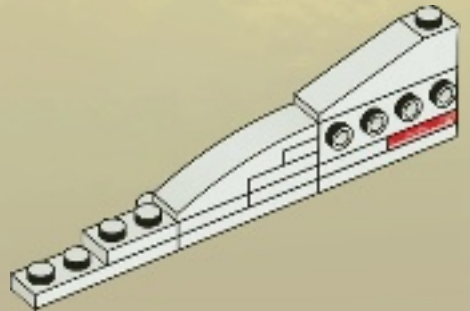



1x

9

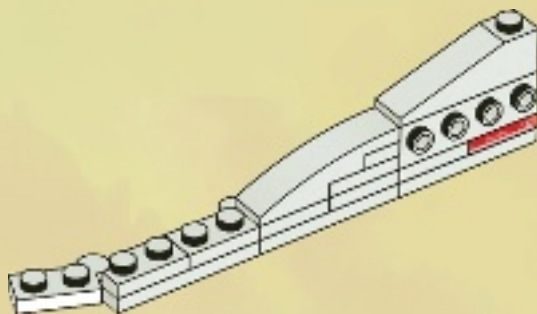

1x

10

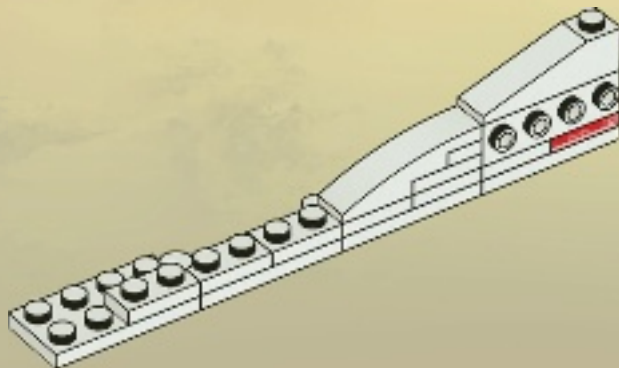

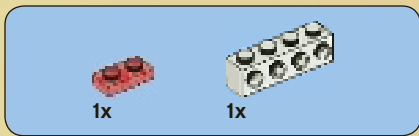

11

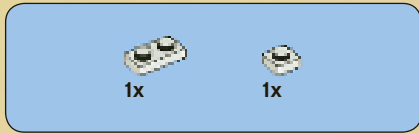
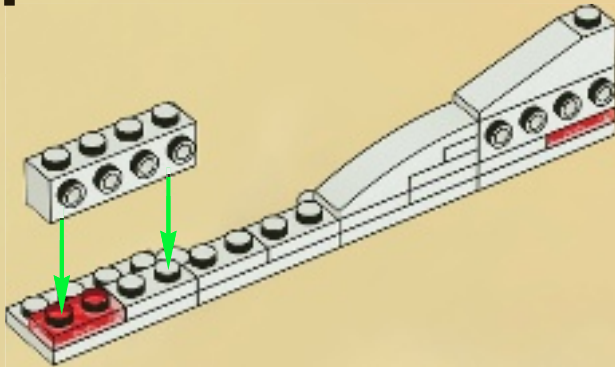

12

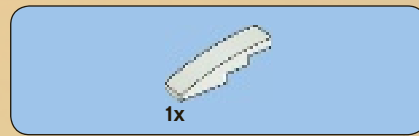
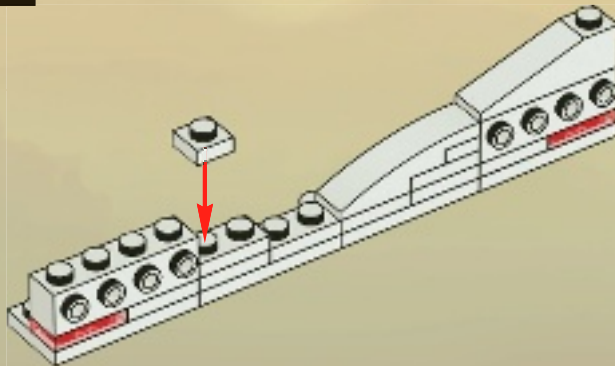

13

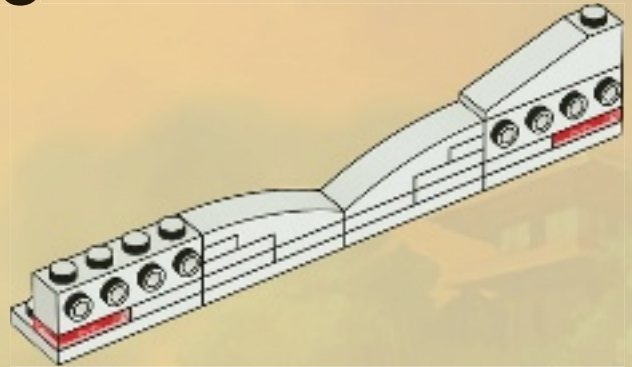

14

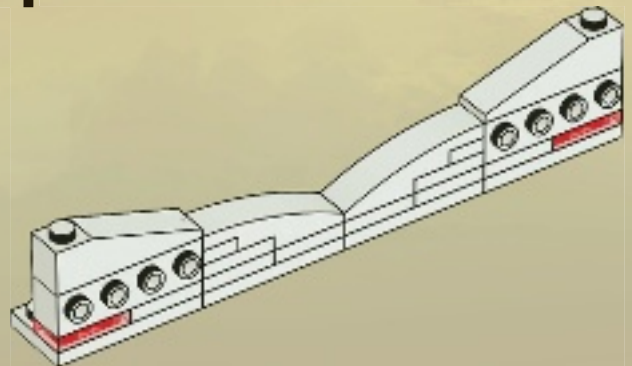

15

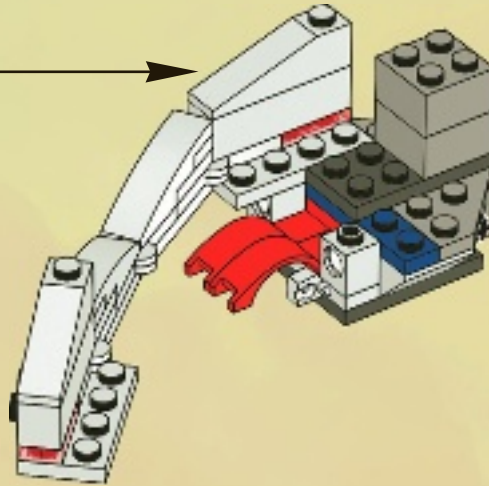

1x

16

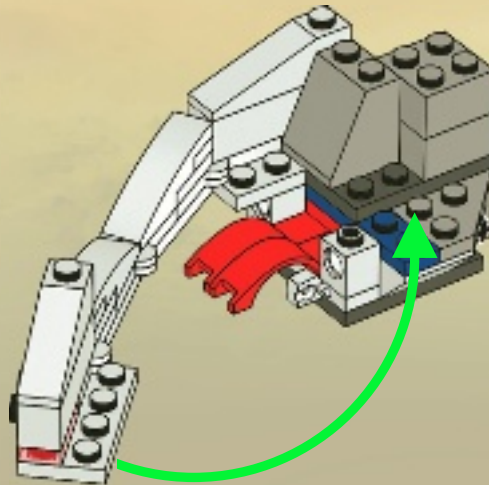



1x

17

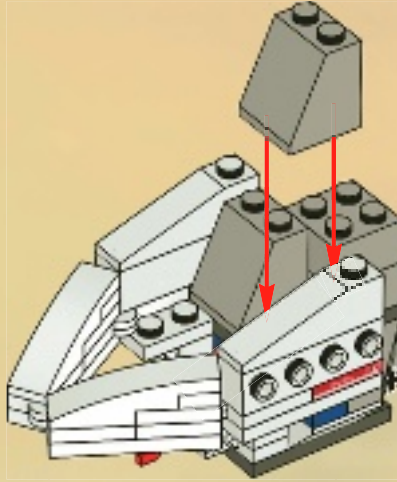

1x



1x

18

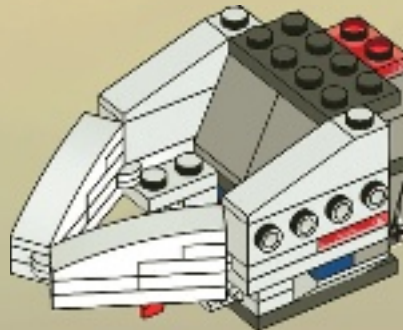



1x

1



1x

2



3x

3

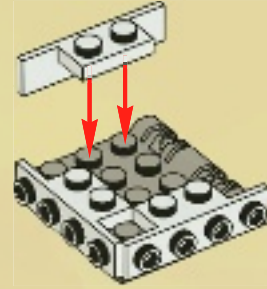

2x



2x

4



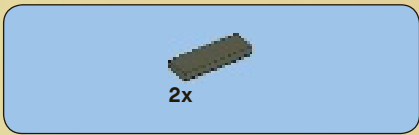

5

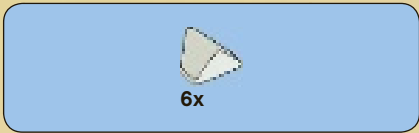

6

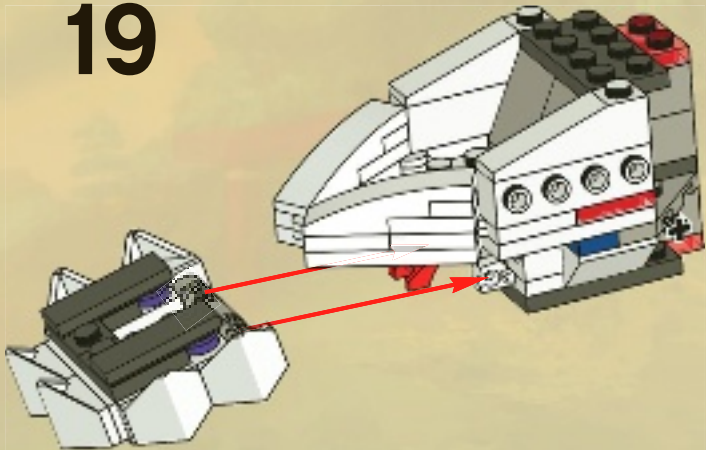
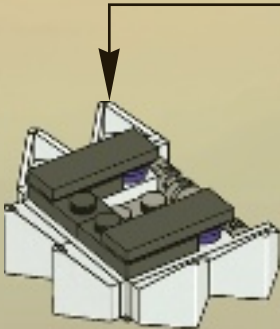

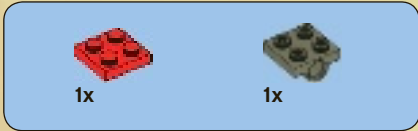

1



2

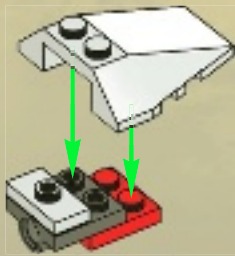

3

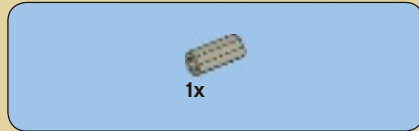
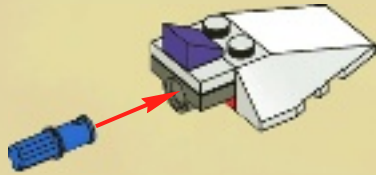

4

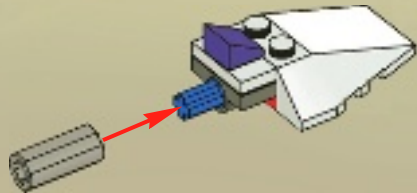

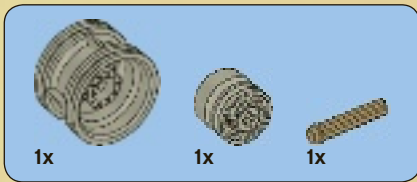

5

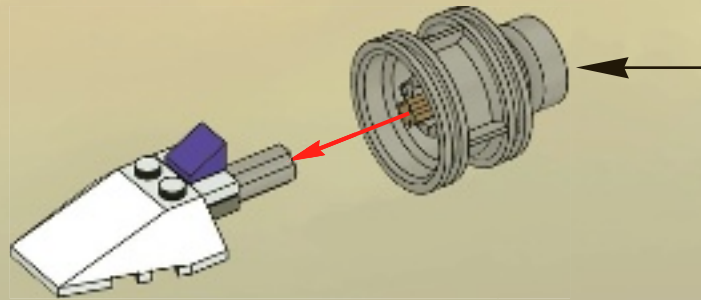
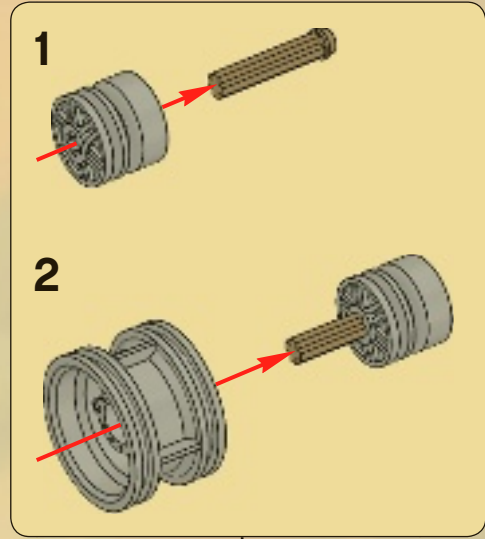



1x

6

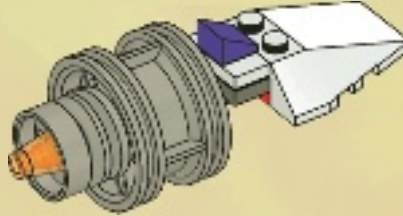

1x

7

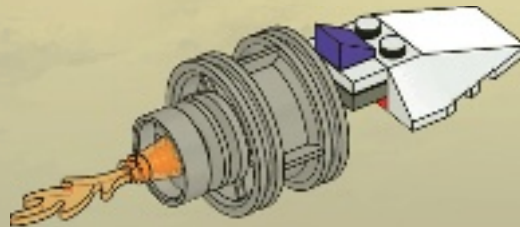

2x

20

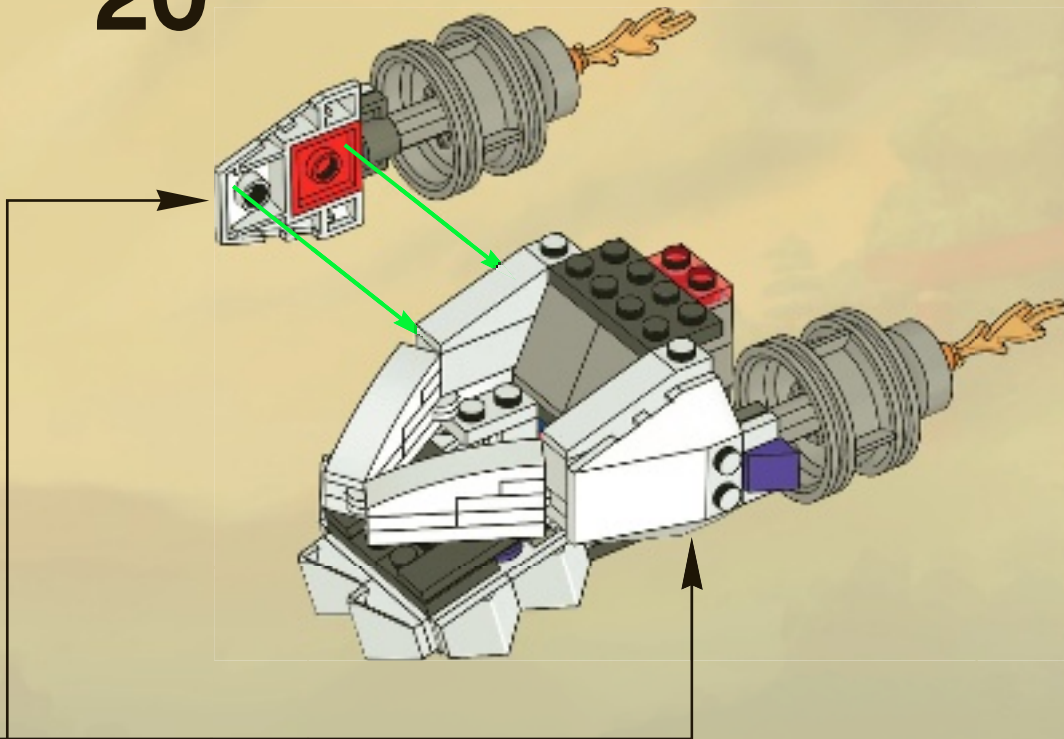

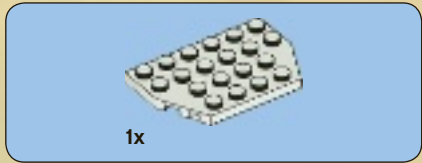
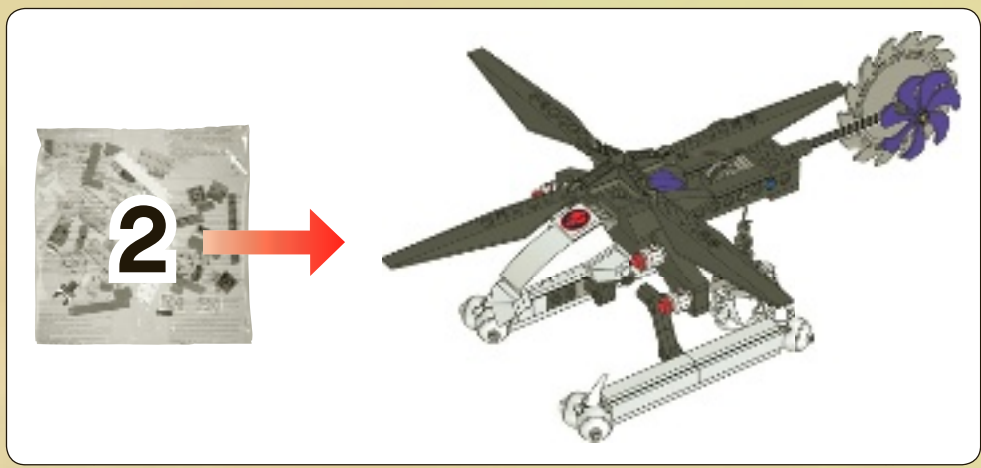

21

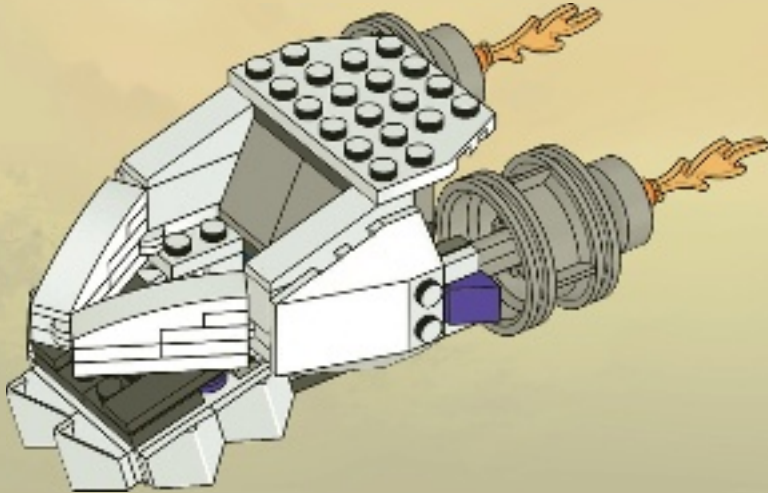

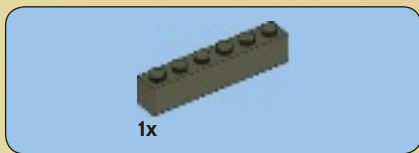

22

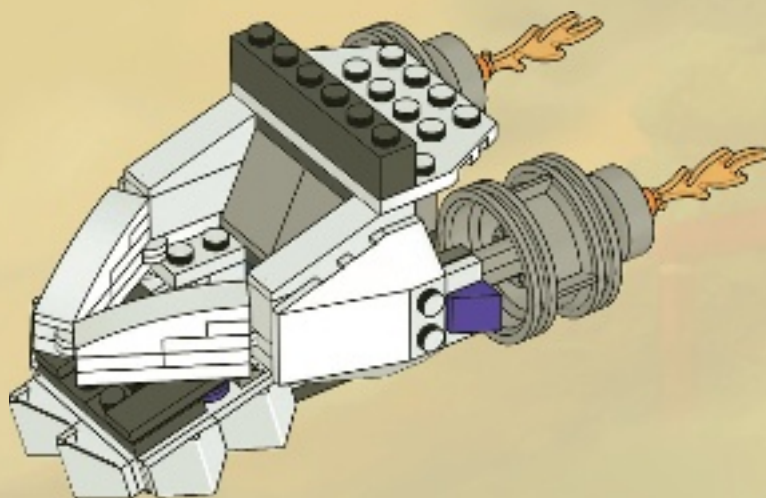

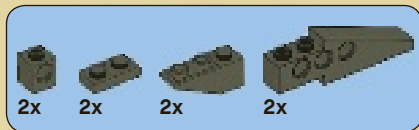

23

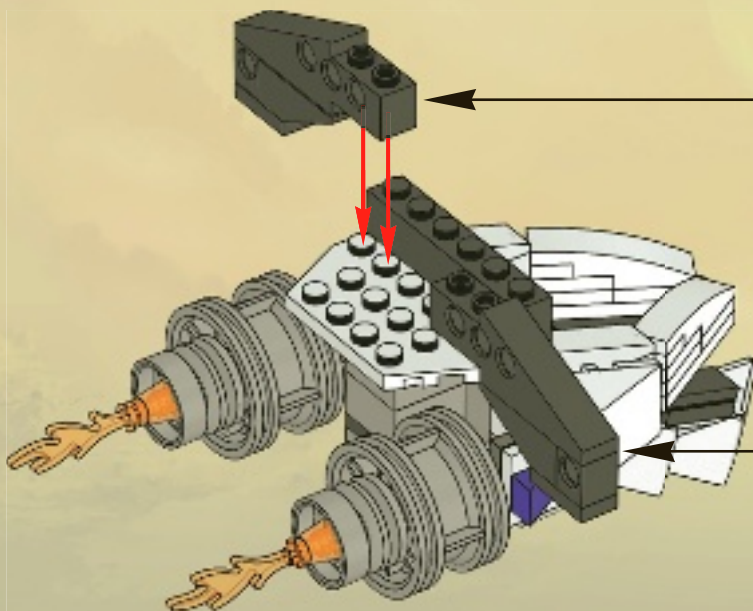
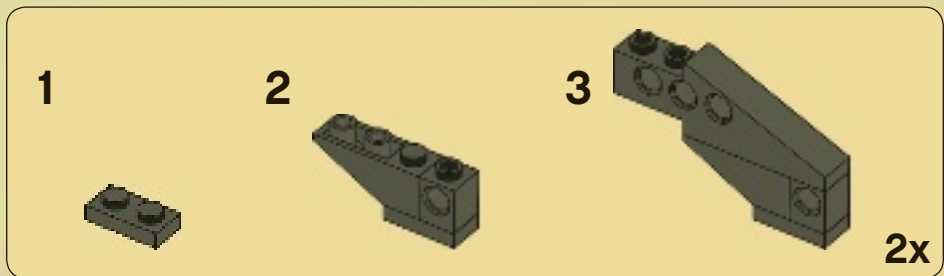

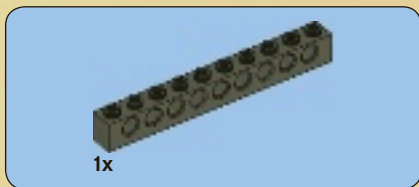

24

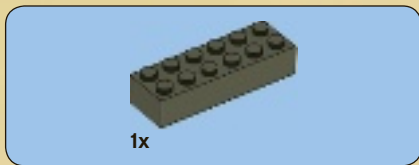
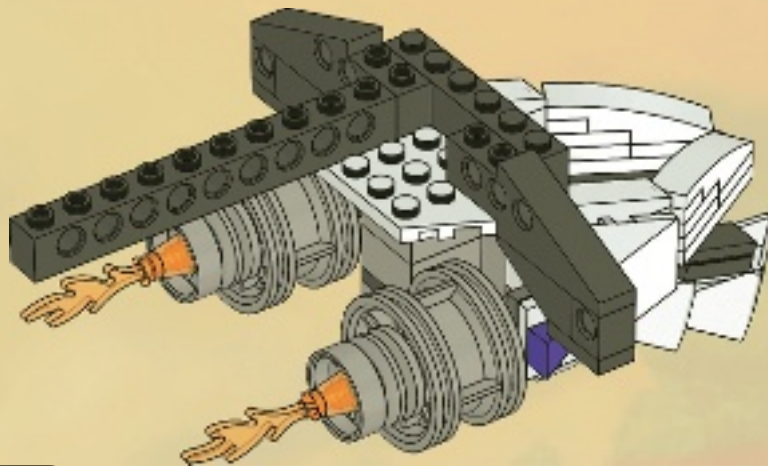

25

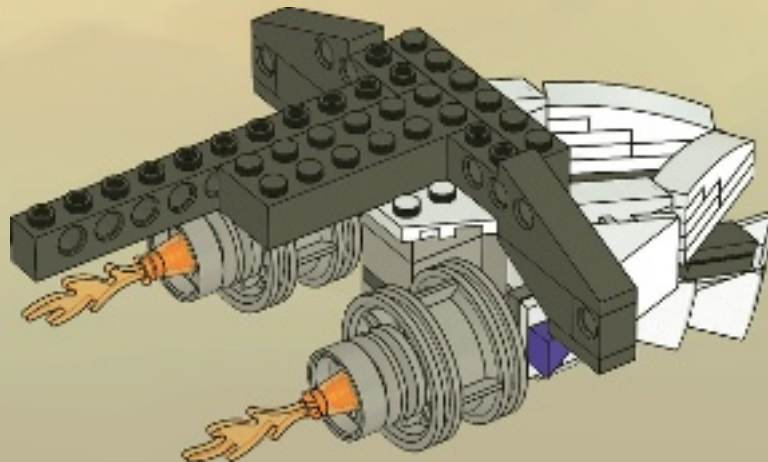



26

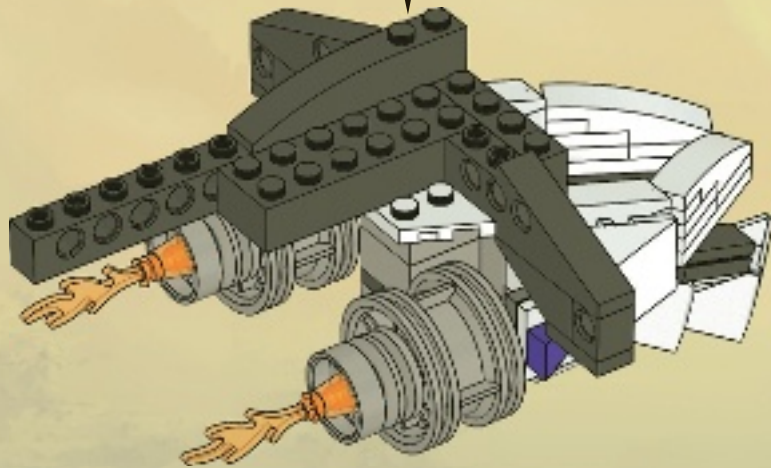
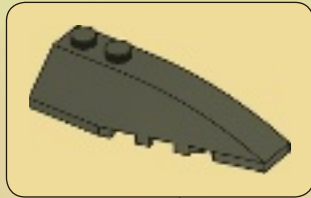



1x



2x

27

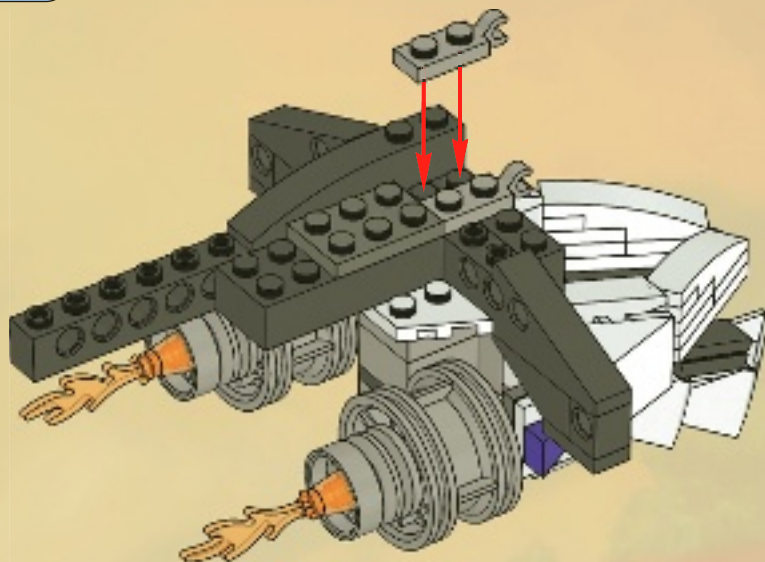

1x

28

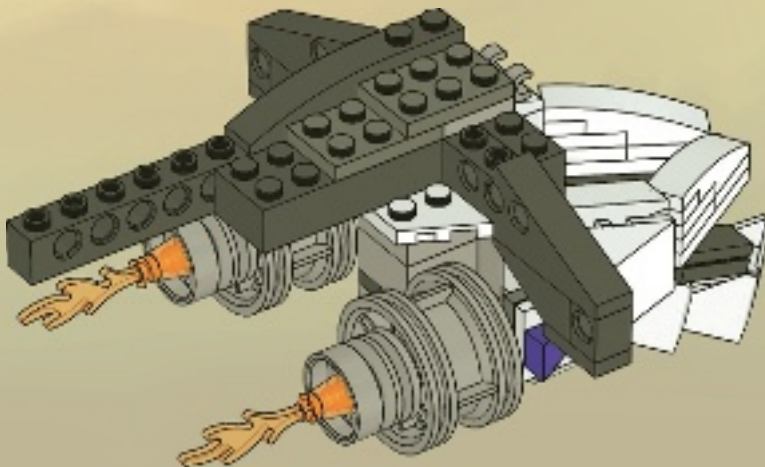



1x



2x

29

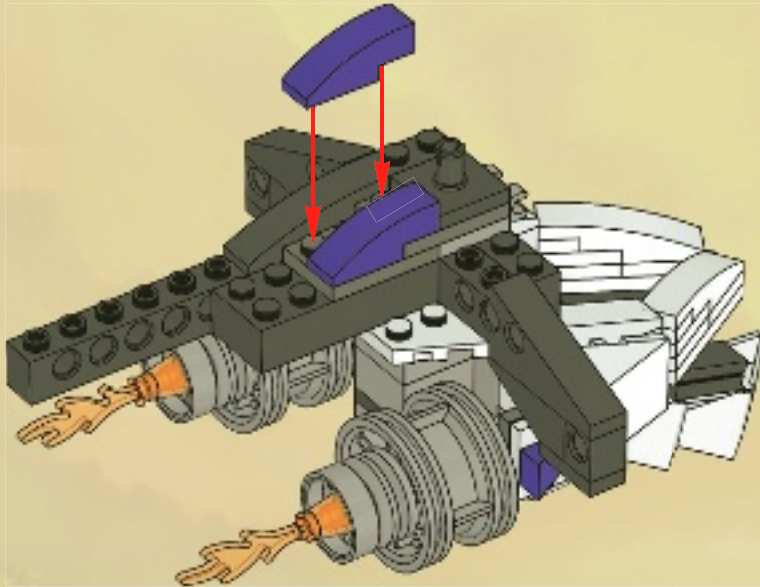



1x



1x

30

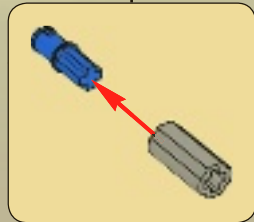
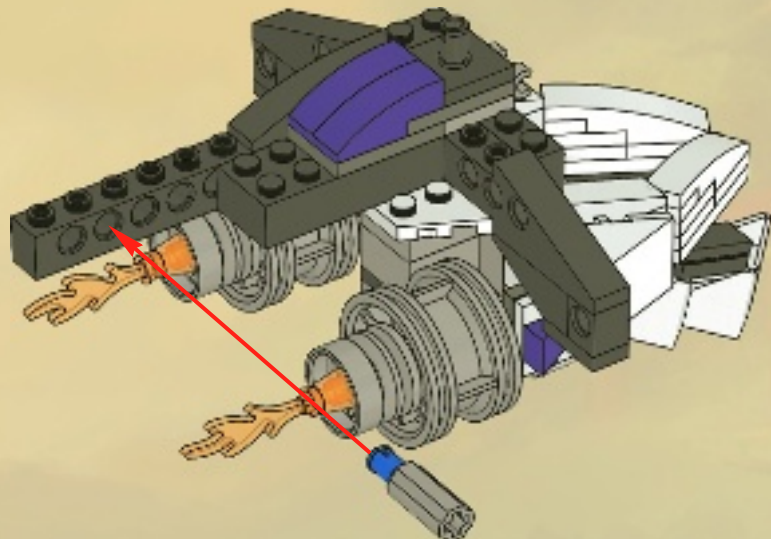

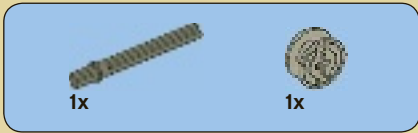

1



2



3



4



1x

5

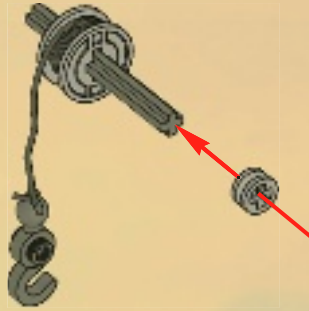

31

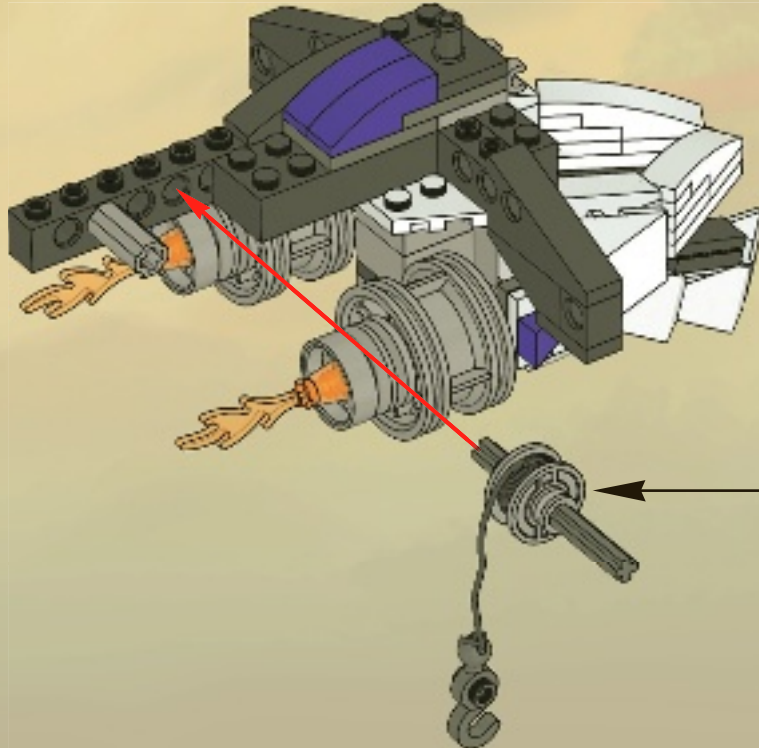

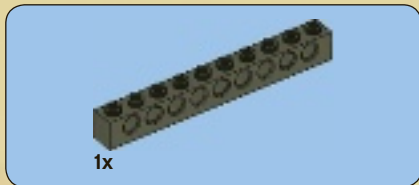

32

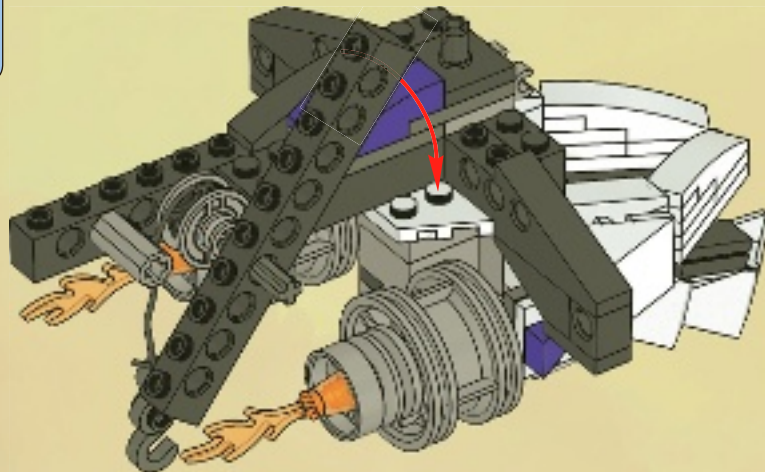

33

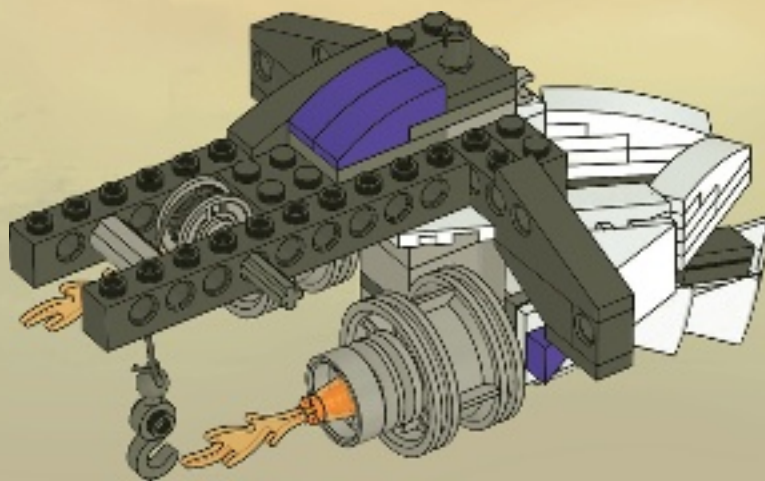



34

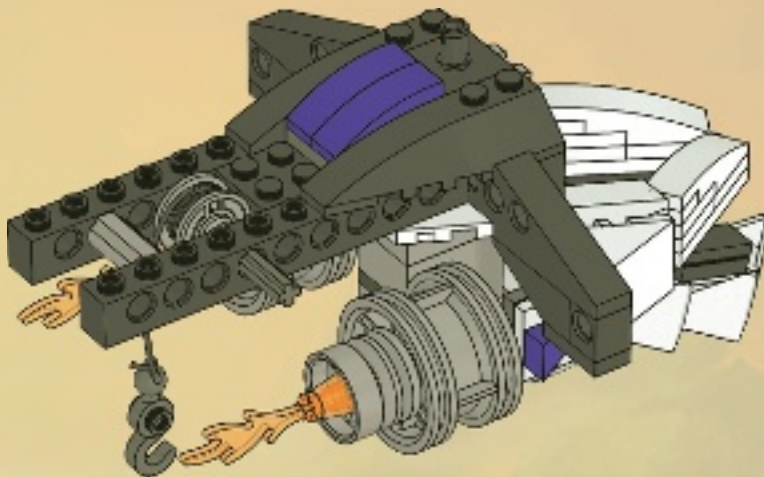

35

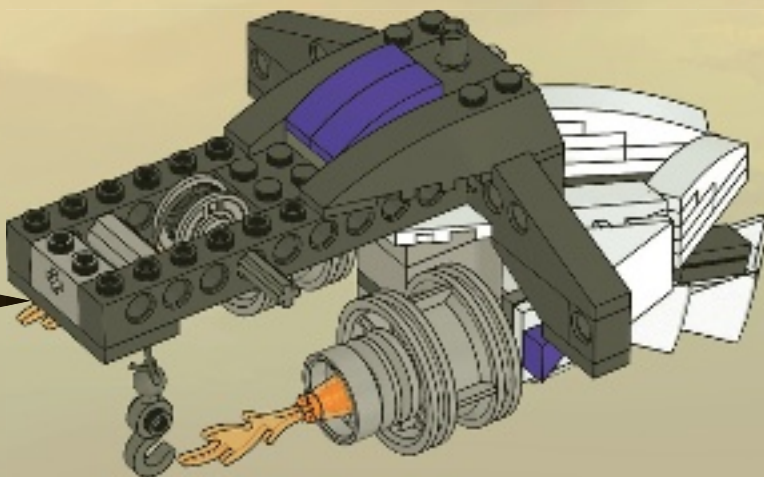
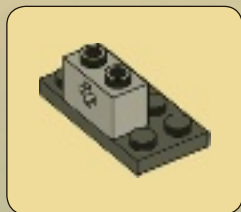



36

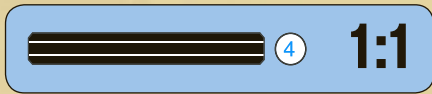
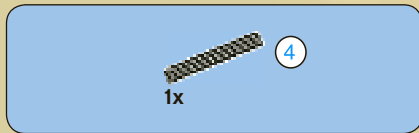
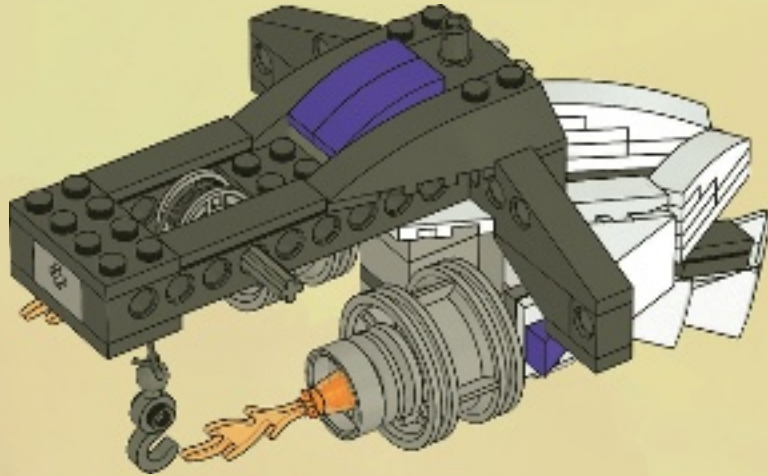

37

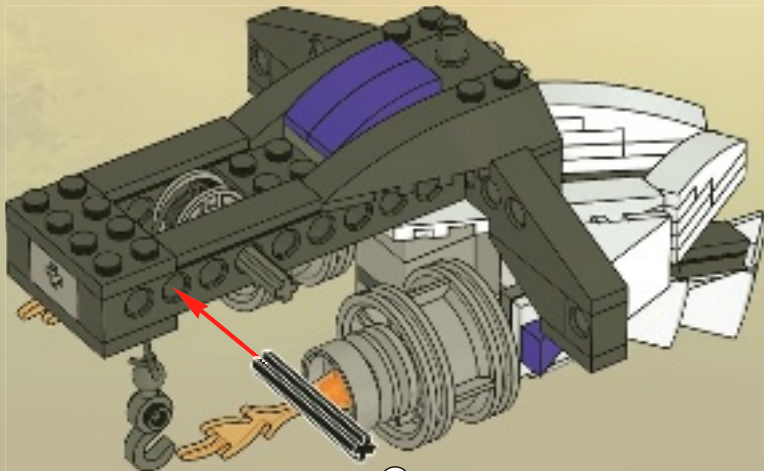

4



1x



1x

38

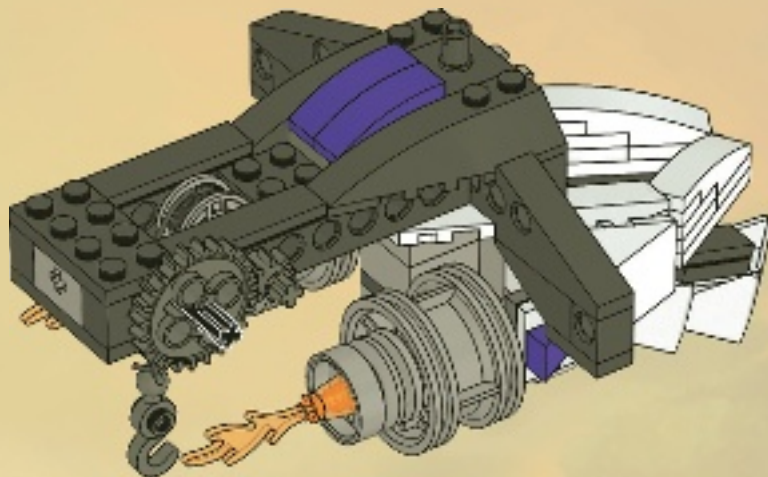

1x

39

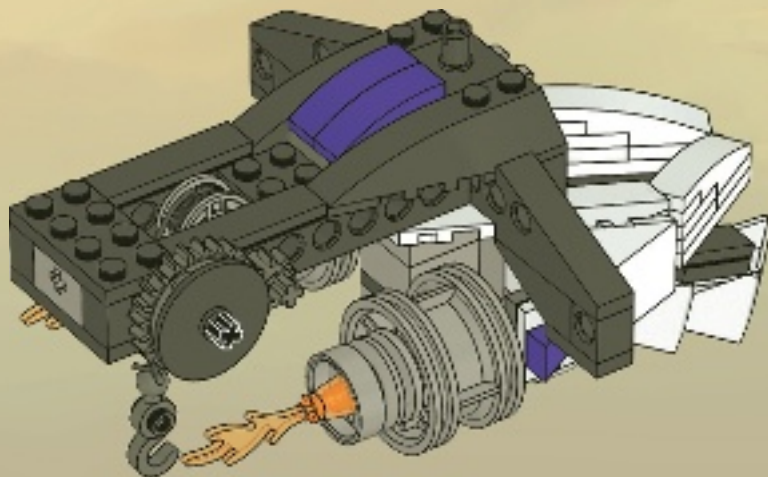

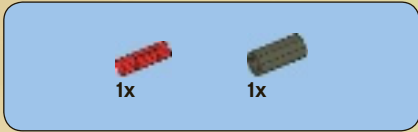

1

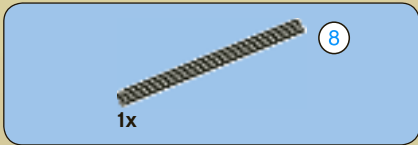
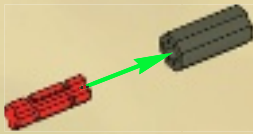

2



3

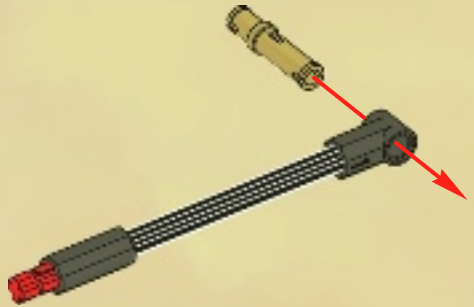

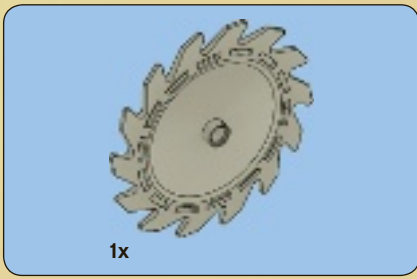

4

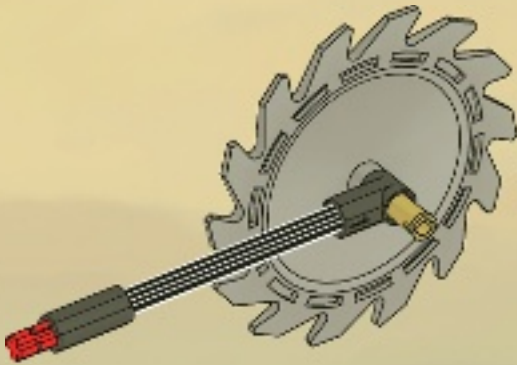

5

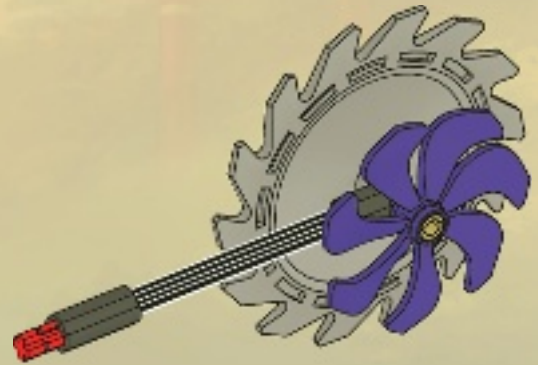

40

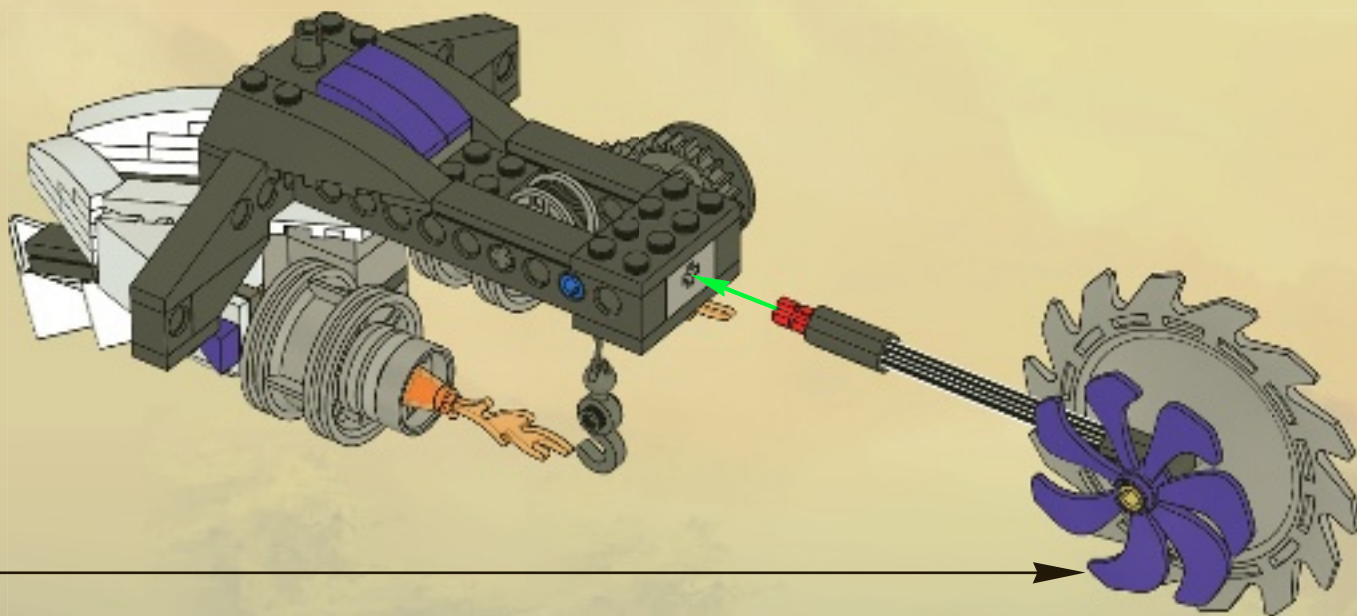
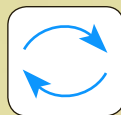



1



2



3

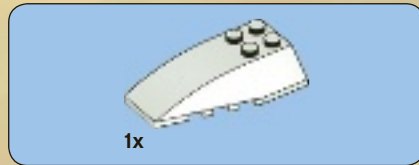
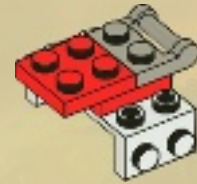

4

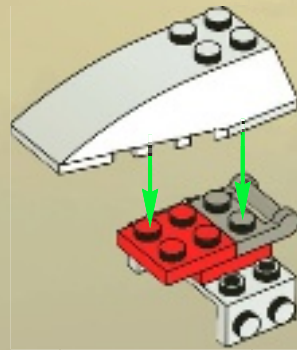



1x

5



1x

6

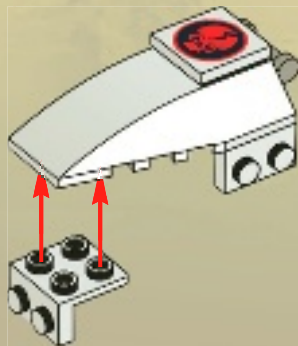

1x

7

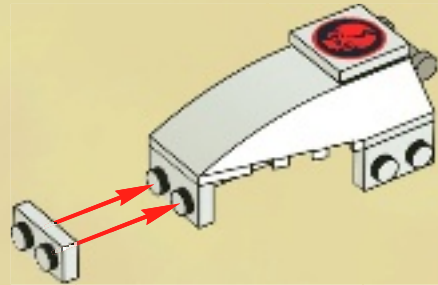

1x



2x

8

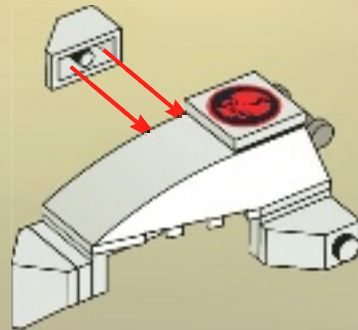

41

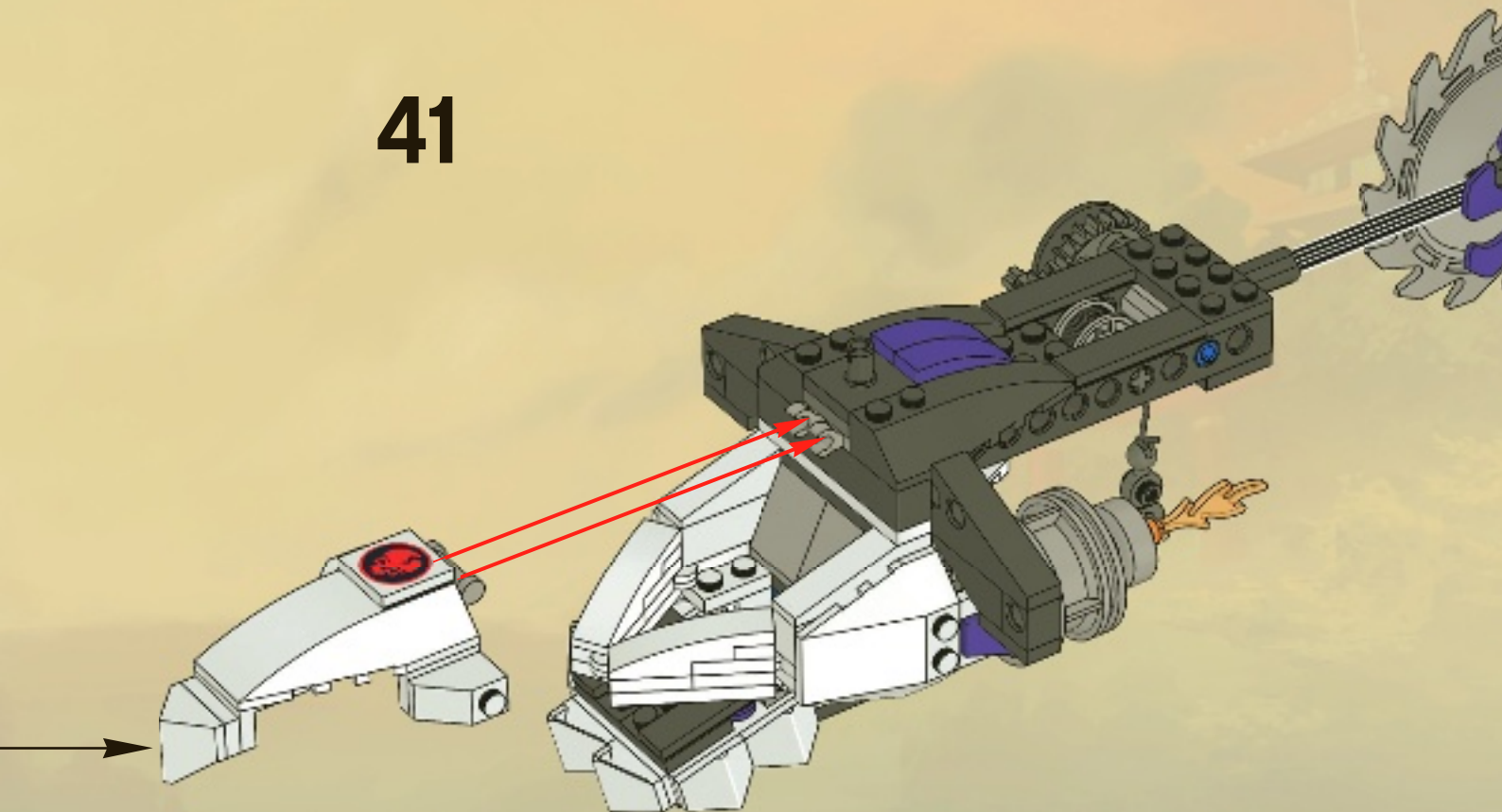

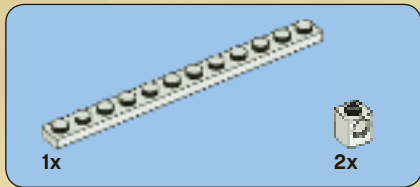
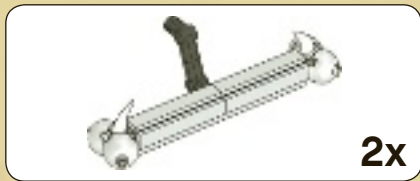

1

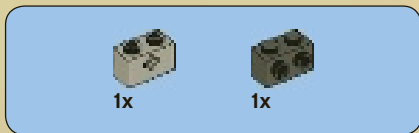
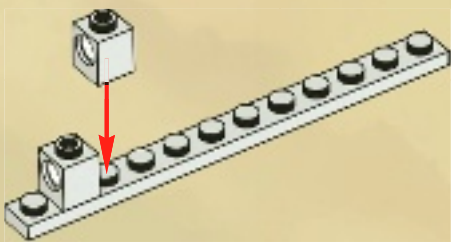

2

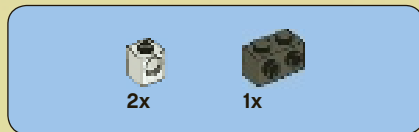
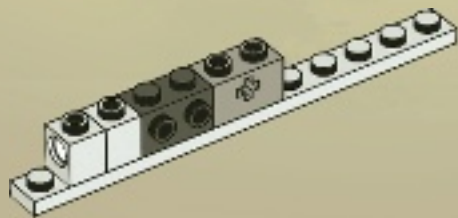

3

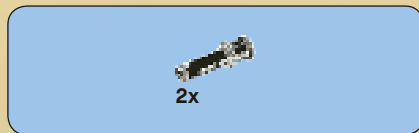
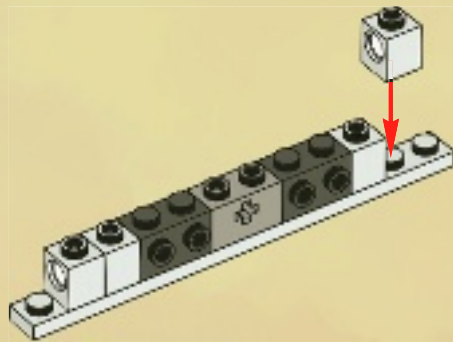

4

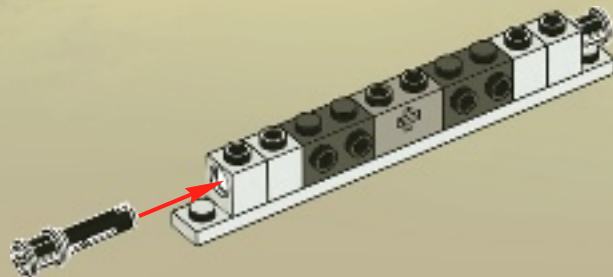

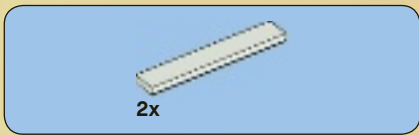

5

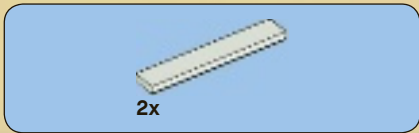
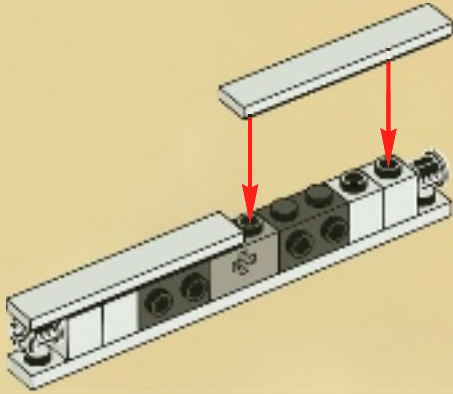

6

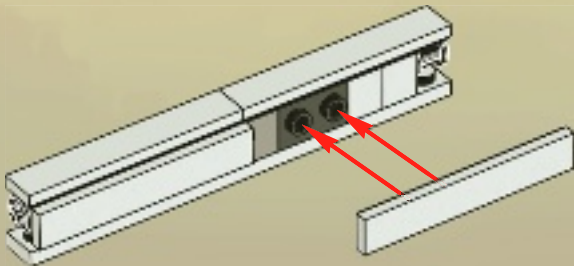

7

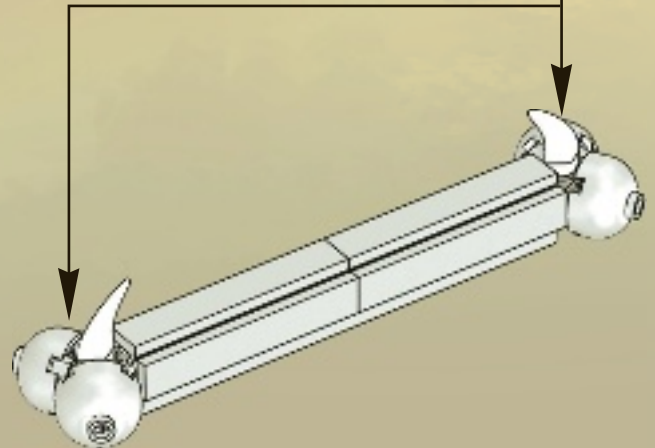
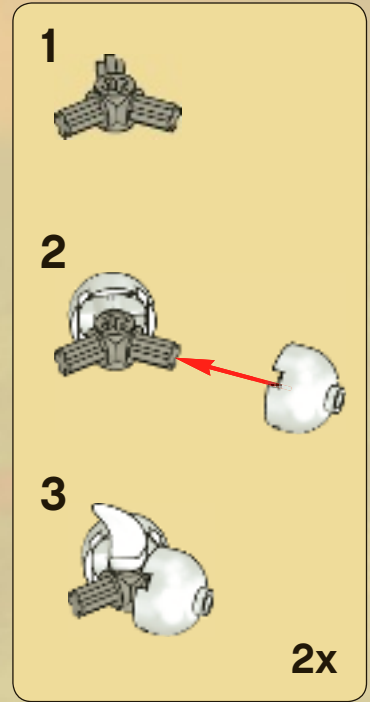



8

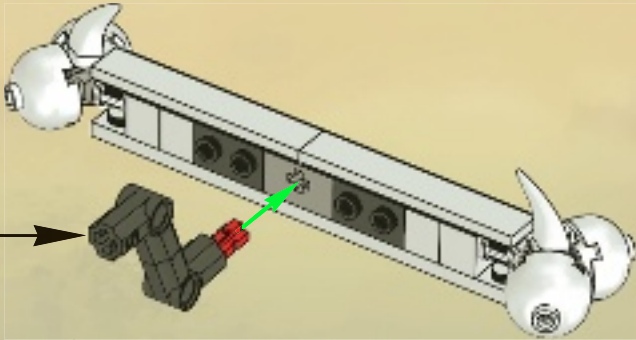
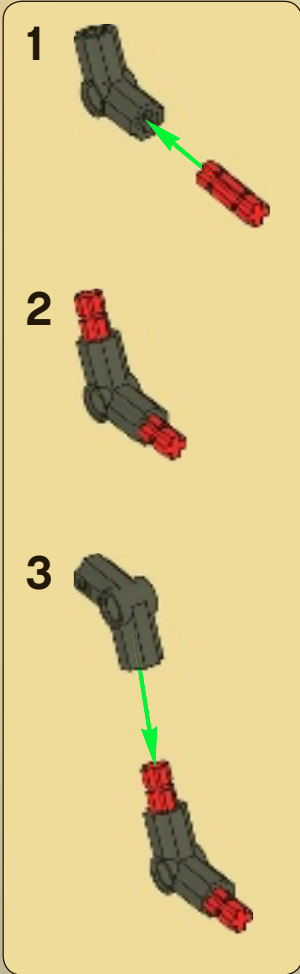

2x

42

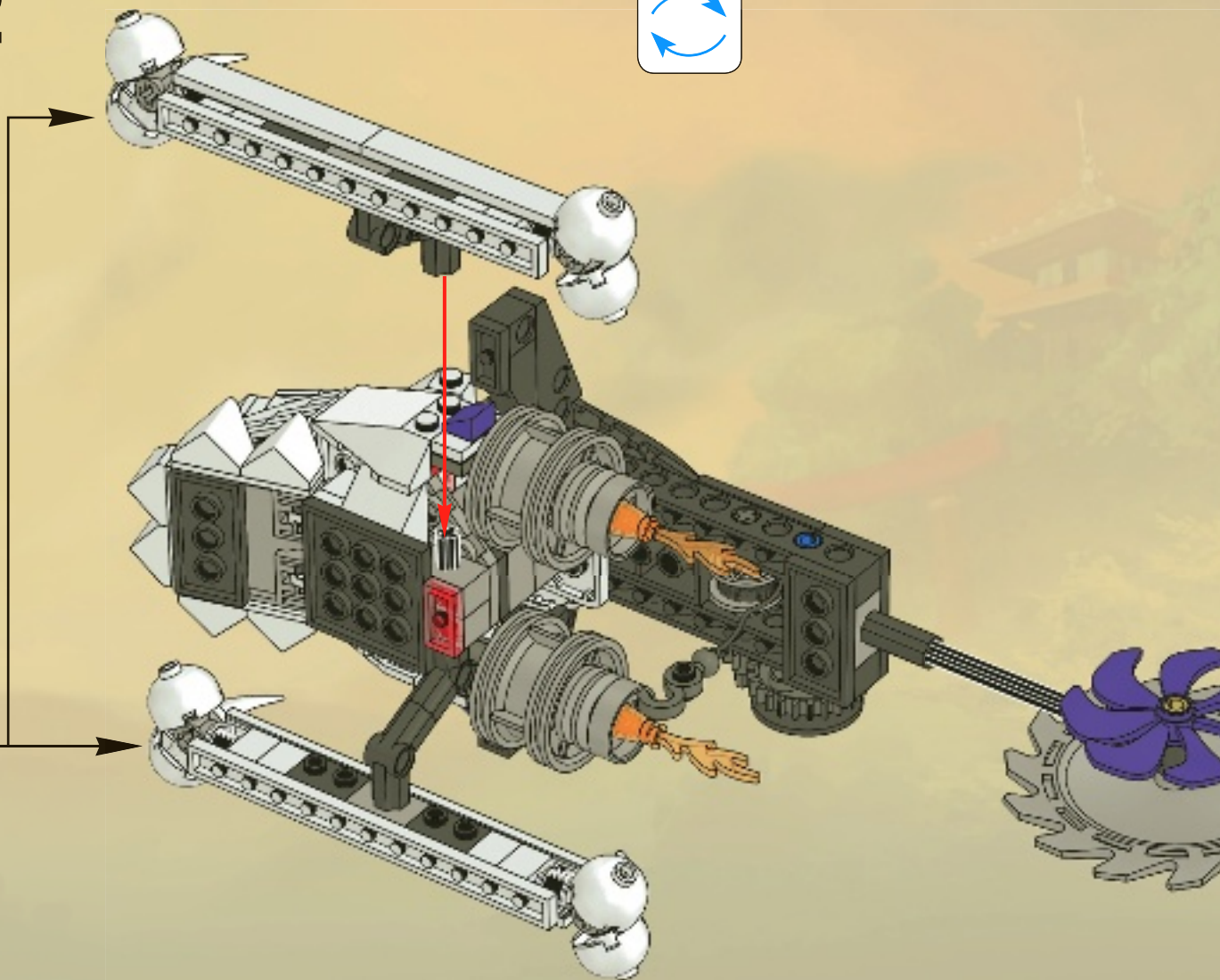
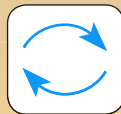



1

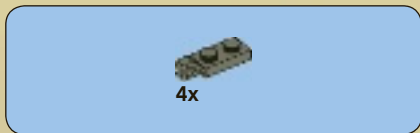

2

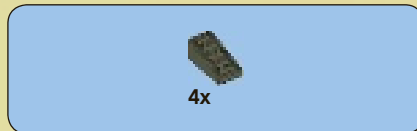
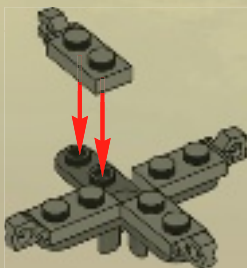

3

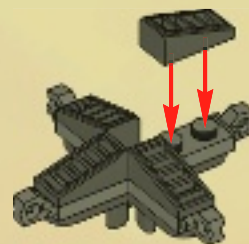

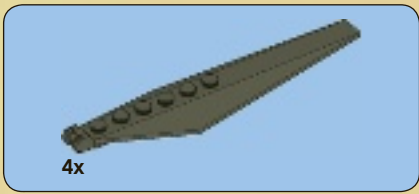

4

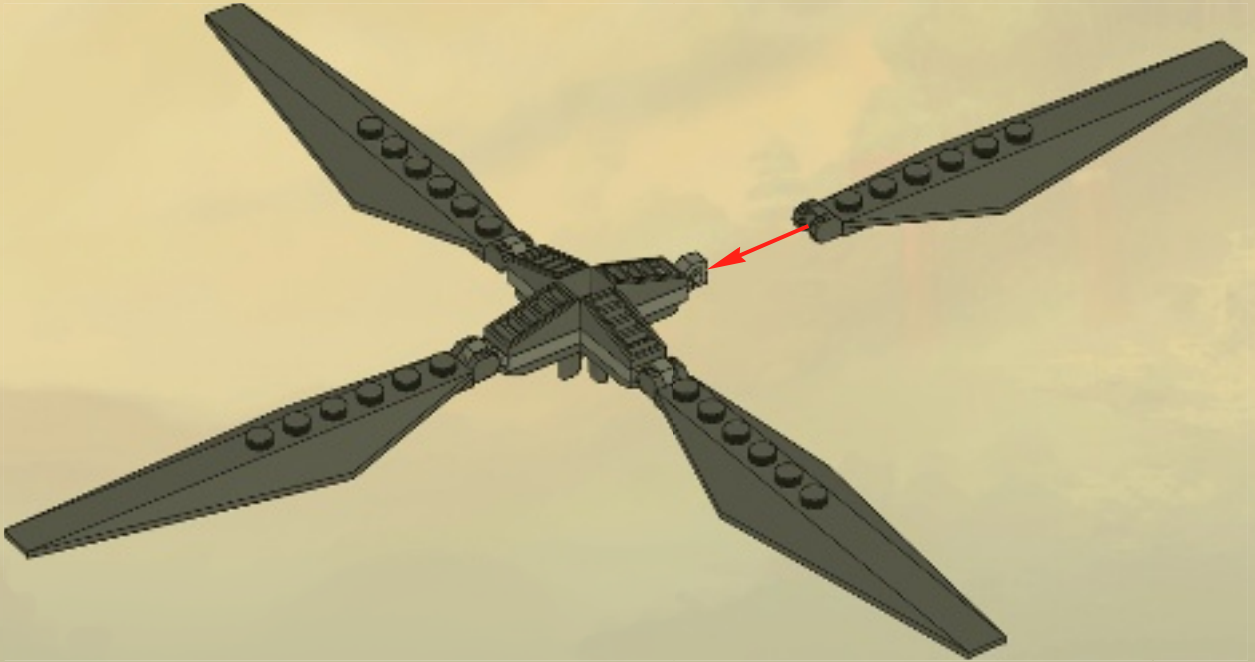

43

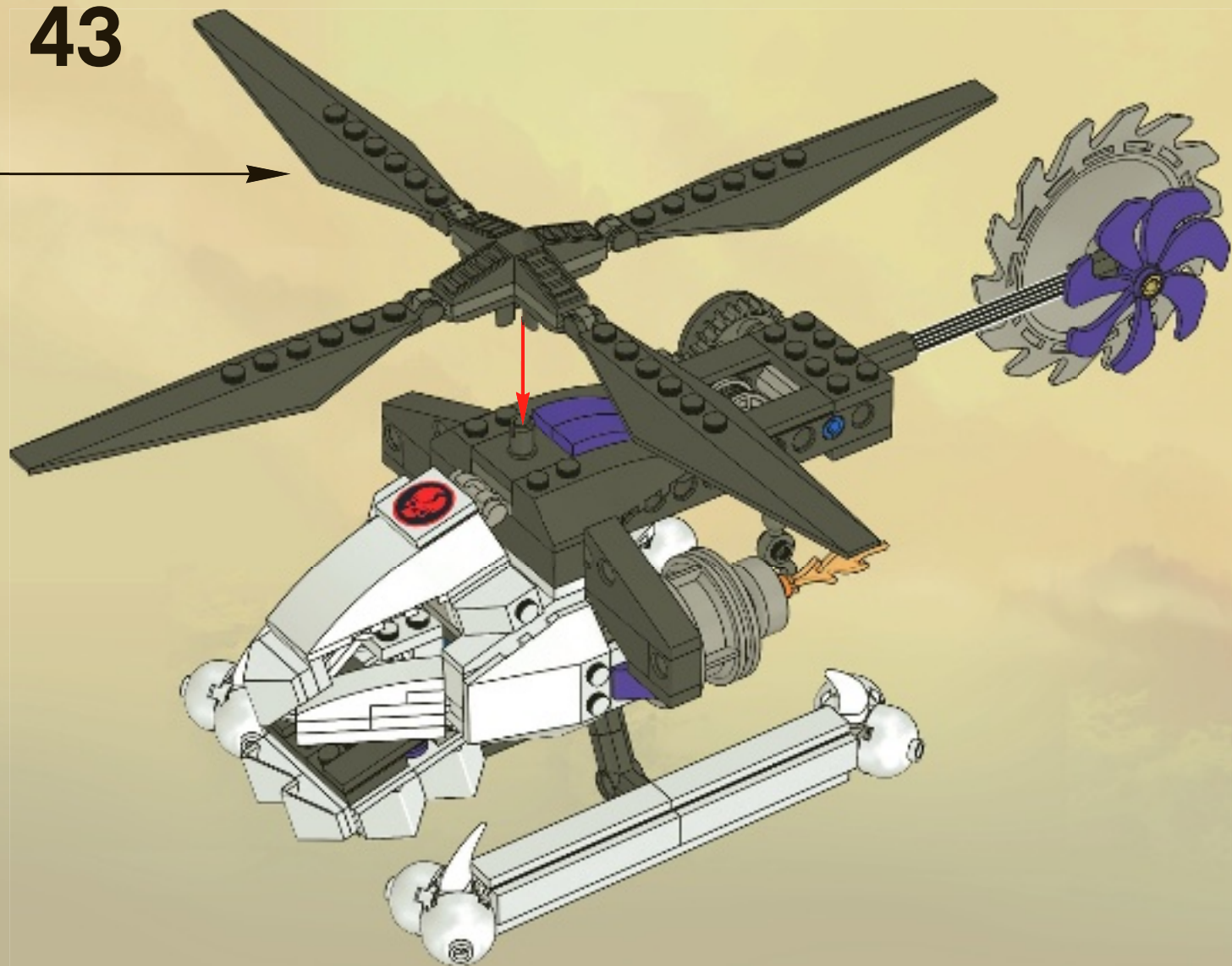



1

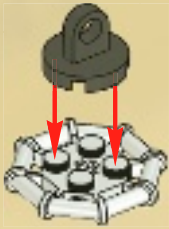

2

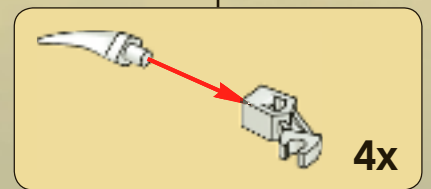
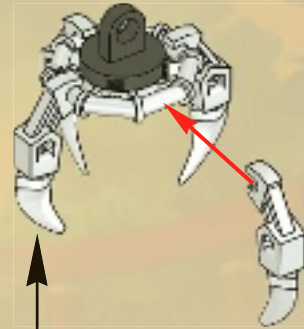

44

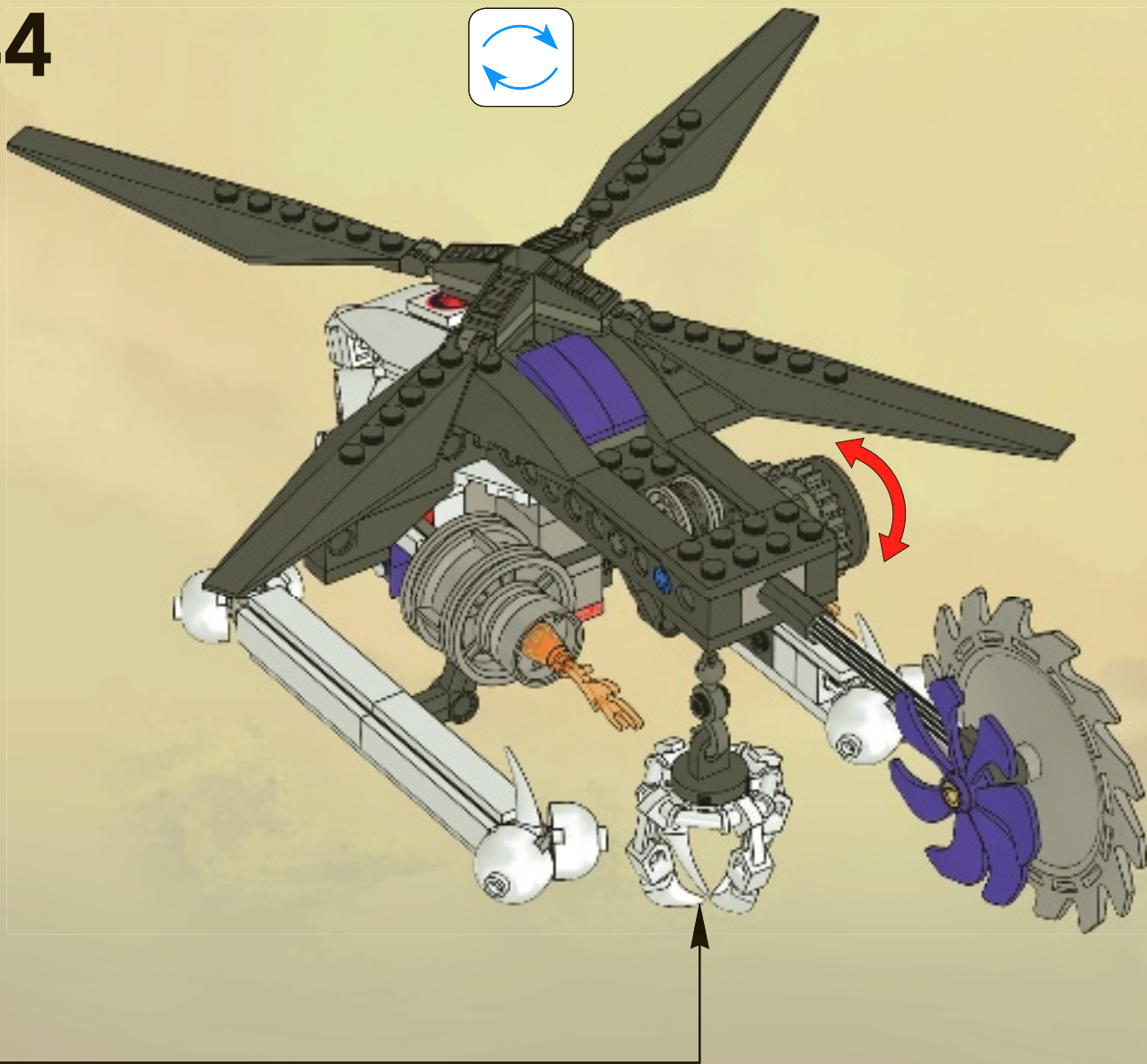
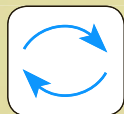

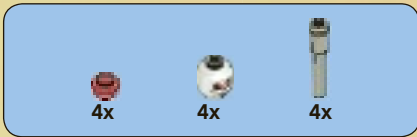

45

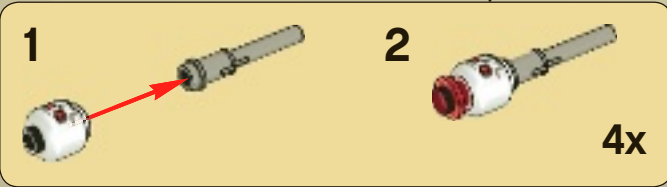
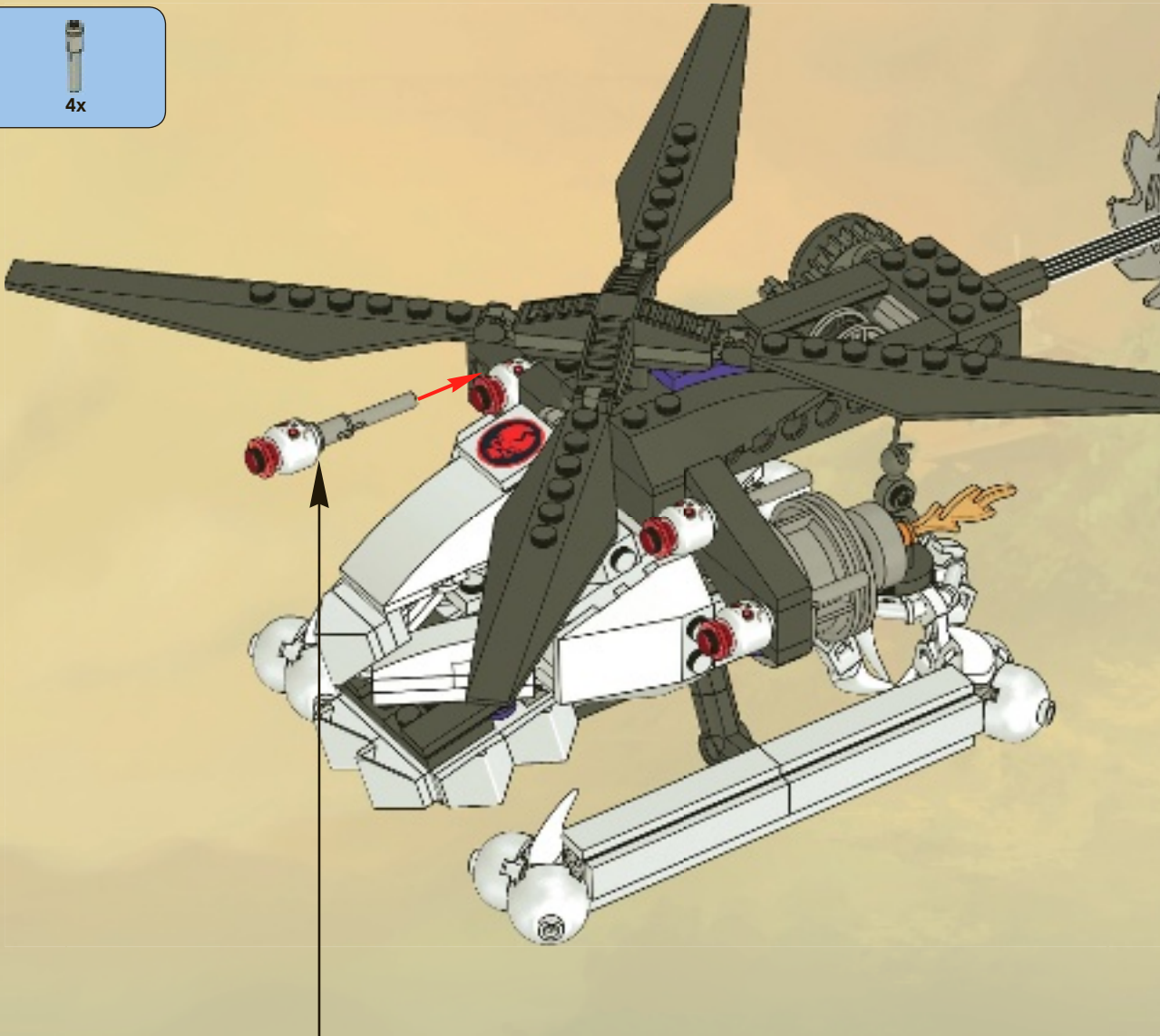





NINJAGO

Masters of Spinjitzu



JAY
2257 - 2506



KAI DX
2507 - 2508 - 2254



ZANE
2506 - 2507



COLE DX
2170 - 2509



NYA
2172 - 2507



SENSEI WU
2255 - 2507



GARMADON
2256 - 2506 - 2507



SAMUKAI
2507



NUCKAL
2173



FRAKJAW
2257



KRUNCHA
2174 - 2507



WYPLASH
2175 - 2506 - 2509





WIN!

Go to www.LEGOsurvey.com/product to fill out a survey for a chance to win a cool LEGO® Product. No purchase necessary. Open to all residents where not prohibited.

 www.LEGO.com



www.LEGOsurvey.com/product

GEWINNE! WIN!

Nimm an der Umfrage auf www.LEGOsurvey.com/product teil und hab die Chance ein cooles LEGO® Produkt zu gewinnen!
Die Teilnahme am Gewinnspiel führt zu keinerlei Kaufverpflichtungen. Teilnahme in allen nicht ausgeschlossenen Ländern möglich.

Ga naar www.LEGOsurvey.com/product, vul een enquêteformulier in en maak kans op een cool LEGO® product.
Geen aankoopverplichting. Iedereen mag deelnemen, uitgezonderd ingezetenden van landen waar een enquêteverbod geldt.

GAGNE! 当てよう!

Visite www.LEGOsurvey.com/product pour répondre à un questionnaire et avoir une chance de gagner un produit LEGO® très cool!
Aucune obligation d'achat. Ouvert à tous les résidents des pays autorisés.

www.LEGOsurvey.com/product にアクセスして、アンケートにご記入ください。当選者にはレゴ®製品を差し上げます。
お買い上げの必要はありません。
禁止されていない限り、すべての管轄にご利用いただけます。